

Thermal Conductivity of 1,2-ethanediol and 1,2-propanediol Binary Aqueous Solutions at Temperature from (253 to 373) K

Changyu Deng, Ke Zhang*, Tao Yang

(Key Laboratory of Thermo-Fluid Science and Engineering, Ministry of Education,
Xi'an Jiaotong University, Xi'an 710049, P. R. China)

*Corresponding author; Email: k.zhang@mail.xjtu.edu.cn; Tel.: (+86) 029-82663708

Abstract

Thermal conductivity of binary aqueous solutions of 1,2-ethanediol and 1,2-propanediol was measured using the transient hot wire method at temperature from 253.15 K to 373.15 K at atmospheric. Measurements were made for six compositions over the entire concentration range from 0 to 1 mole fraction of glycol, namely, 0.0, 0.2, 0.4, 0.6, 0.8, and 1.0 mole fraction of glycol. The uncertainty of the thermal conductivity, temperature, and concentration measurements are estimated to be better than $\pm 2\%$, 0.01K, 0.1%, respectively. The second-order Scheffé polynomial is used to correlate the temperature and composition dependence of the experimental thermal conductivity, which is found to be in good agreement with the experiment data from the present work and other reports.

1 Introduction

1,2-Ethanediol and 1,2-propanediol are important chemicals in industries and scientific researches. 1,2-Ethanediol, also known as ethylene glycol, is a commercially important raw material for the manufacture of polyester fibers, chiefly polyethylene terephthalate, and can also be used as a humectant, plasticizer, softener, etc. 1,2-Ethanediol lowers the freezing point of water, therefore aqueous solutions of it are commercially applied as antifreezes. They are widely employed, for example, in motor vehicles, solar energy units, heat pumps, water heating systems, and industrial cooling systems.[2] 1,2-Propanediol, also called propylene glycol, is widely used in the manufacture of unsaturated polyester resins. It is a precursor of many polyether polyols used in the urethane foam, elastomer, elastomer, adhesives, and sealants industry, adhesives, and sealants industry polyester resins. Its aqueous solutions are utilized in aircraft de-icing and anti-icing fluids because of its proven performance, low toxicity, ready biodegradability, and environmental acceptance.[3] Its solutions play an important role as heat transfer fluids and coolant agents owing to their ability to efficiently lower the freezing point of water and their low volatility. Although ethylene glycol solutions have better thermophysical properties than propylene glycol solutions, especially at lower temperature, the less toxic propylene glycol is preferred for applications involving possible human contact or where mandated by regulations.[4]

The physical properties have to be known in process engineering and in heat exchanger

design. For instance, Najjar et al. demonstrated the influence of improved physical property data on calculated heat transfer rates and showed that e.g. the resulting error in heat transfer coefficients will be about 110% if each of the estimated physical properties is 50% high. [5, 6] Among those thermal properties, thermal conductivity is essential to designing heat transfer and thermal energy storage systems, yet the thermophysical properties of these aqueous solutions are still scarce, especially at low temperature.[4] With regard to thermal conductivity at atmosphere, researchers were prone to investigate them together, probably due to their similar properties and applications. Literature on thermal conductivity of aqueous solutions of 1,2-ethanediol and 1,2-propanediol are summarized in Table 1.

Table 1 Summary of literature on thermal conductivity of aqueous solutions of 1,2-ethanediol and 1,2-propanediol at atmospheric^a

First author	Year	Temperature/K	Mass fraction/%
Bates, O. K.	1945[8]	293-383	10, 20, 30, 40, 50, 60, 70, 80, 90
Riedel, L.	1951[9]	233-373	Same as above
Rastorguev, Yu. L.	1966[10] ^b	313	20, 40, 60, 80
Rastorguev, Yu. L.	1967[11]	313	78
Vanderkool, W. N.	1967[12]	273-381 ^b 273, 323, 373 ^c	20, 40, 60, 80
Ganiev, Yu. A.	1968[13] ^b	313	81
Usmanov, I. U.	1977[14] ^b	313	20, 40, 60, 80
Bogacheva, I. S.	1980[15] ^b	298-363	25, 50, 75
Bohne, D.	1984[6] ^b	280-470	25, 55, 75
Grigrev, A.	1985[16] ^b	302-454	14, 24, 62, 78
Assael, M. J.	1989[17]	296-355	25, 50, 75
Sun, T.	2003[18] ^b , 2004[19] ^c	299-442	25, 50, 75

a) Authors measured both glycols unless otherwise stated

b) 1,2-Ethanediol only

c) 1,2-Propanediol only

In this paper, thermal conductivity of binary aqueous solutions of 1,2-ethanediol and 1,2-propanediol was measured using the transient hot wire method at temperature from 253.15 K to 373.15 K covering the whole composition range at atmospheric. The second-order Scheffé polynomial was used to correlate the temperature and composition dependence of the experimental thermal conductivity.

2 Experimental

2.1 Chemicals

The chemical samples of 1,2-ethanediol and 1,2-propanediol used in this work were analytical grade. Both of them have mass fraction purity of 99.0 % and were provided by Sinopharm Chemical Reagent CO, Ltd., China. Complete specification of chemical samples is listed in Table 2. Deionized and redistilled water was used throughout all of the experiments. All sample materials were used without further purification. In the experiments, the aqueous solutions were prepared by weighing, and then injected into

the pressure vessel. An analytical balance (Mettler Toledo XS205) with an accuracy of ± 0.1 mg was used to weigh the samples.

Table 2 Specification of chemical samples

Chemical	CAS number	Source	Initial mass fraction purity	Purification method
1,2-ethanediol	107-21-1	Sinopharm Chemical Reagent CO, Ltd	99.0	none
1,2-propanediol	57-55-6	Sinopharm Chemical Reagent CO, Ltd	99.0	none

2.2 Apparatus

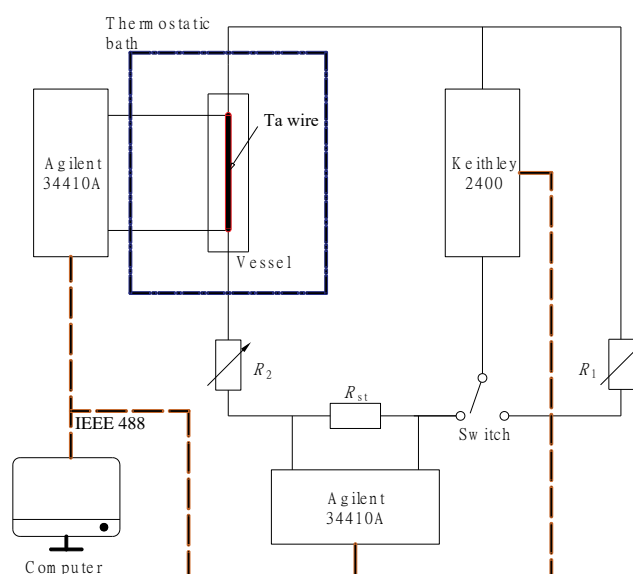

Figure 1 Schematic diagram of transient hot-wire apparatus

The measurements of thermal conductivity were conducted by the transient hot-wire apparatus. The physical basis details of the transient hot-wire technique has been described elsewhere. The main structure of the apparatus, procedure of measurements, calibration procedure, and uncertainty assessment have been given in our earlier publication.[20] For experiments in present work, only the size of the pressure vessel and the multimeters of the data acquisition system were modified. Thus, a simple description is presented here.

The hot wire was a single tantalum wire with a diameter of 25 μm and a length of about 30 mm. The tantalum wire was anodized to form a layer of insulating tantalum pentoxide on their surface. The tantalum wire was enclosed by a stainless-steel vessel with a volume of about 20mL. A schematic diagram of the transient hot-wire apparatus is presented in Figure 1. The power of the circuit was supplied by a Keithley 2400 sourcemeter. The resistance of the tantalum wire was obtained by measuring the current and voltage using two Agilent 34410 digital multimeters. All the data acquisition and instrument control were performed by a computer via the IEEE-488 interfaces.

The transient hot-wire apparatus was completely immersed in a thermostatic bath (Fluke, model 7037). The temperature was measured with a platinum resistance thermometer. The total uncertainty of the temperature for the thermal conductivity

measurements was less than 10mK.

The performance of the apparatus was tested by measuring the thermal conductivity of saturated liquid toluene (mass fraction purity better than 99.5 %) from 273K to 373 K. Agreement with recommended values calculated by REFPROP software was within a maximum deviation of 1.20 % and an average absolute deviation of 0.61 %. This comparison indicated that the uncertainty in the measurement of the thermal conductivity should be better than ± 2.0 %.

Considering the uncertainties of temperature, pressure, and concentration measurements, the total experimental combined expanded uncertainty of the thermal conductivity measurements at the 95 % confidence level is estimated to be 2 % with a coverage factor of $k=2$.

3 Results and Discussions

3.1 Pure liquids

Thermal conductivity of pure liquid 1,2-ethanediol and 1,2-propanediol is presented in Table 3.

Table 3 Thermal conductivity of 1,2-ethanediol and 1,2-propanediol

1,2-Ethanediol		1,2-Propanediol	
T (K)	λ (W/m·K)	T (K)	λ (W/m·K)
263.23	0.2485	253.31	0.1979
273.20	0.2495	263.27	0.1974
283.09	0.2503	273.26	0.1969
293.06	0.2513	282.93	0.1964
312.91	0.2535	293.20	0.1962
332.63	0.2549	313.35	0.1955
352.54	0.2562	333.46	0.1951
363.09	0.2565	353.51	0.1945
372.48	0.2568	363.59	0.1943
		373.59	0.1938

For engineering application and further research, a continuous function of thermal conductivity is required.

Thermal conductivity of pure liquids was correlated as a function of temperature:[21]

$$\lambda_i = a_i \cdot T^2 + b_i \cdot T + c_i \quad (1)$$

where T denotes the absolute temperature of solutions in K, a_i , b_i and c_i are coefficients.

Data are fitted via the least-square method and correlation coefficients are obtained, shown in Table 4.

As error of correlation shown in Figure 4 and Figure 5, the average absolute deviations and the maximum absolute deviations of the calculated thermal conductivity of

mixtures from experimental data are respectively 0.87 %,2.52 % for 1,2-ethanediol, and 0.53 %, 1.53 % for 1,2-propanediol. The calculated values are in satisfying agreement with the experiment data.

Table 4 Fitting coefficients for pure glycols

Liquid	a_i	b_i	c_i	MAD	AAD
1,2-Ethanediol	-3.7625×10^{-7}	3.1811×10^{-4}	1.9064×10^{-1}	0.09%	0.06%
1,2-Propanediol	9.6913×10^{-8}	-9.2337×10^{-5}	2.1496×10^{-1}	0.10%	0.05%

Values of thermal conductivity of 1,2-ethanediol measured in this work are compared with reported by other researchers in Figure 2, and 1,2-propanediol in Figure 3. It can be easily seen that most data are within $\pm 2\%$ of calculated lines. The maximum absolute deviations of 1,2-ethanediol and 1,2-propanediol from calculated values are 3.24% and 2.55% respectively.

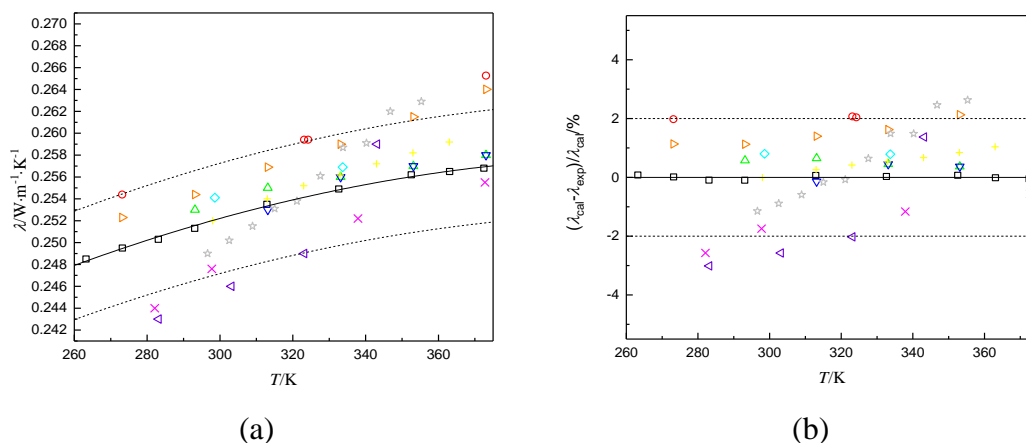

Figure 2 Comparison of thermal conductivity of 1,2-ethanediol. \circ , Ref. [12]. \triangle , Ref. [22]. ∇ , Ref. [23]. \diamond , Ref. [24]. \blacktriangleleft , Ref. [25]. \blacktriangleright , Ref. [9]. $+$, Ref. [15] \times , Ref. [6]. \star , Ref. [17]. \square , present work. Solid line, calculated from correlation. Dash line, $\pm 2\%$.

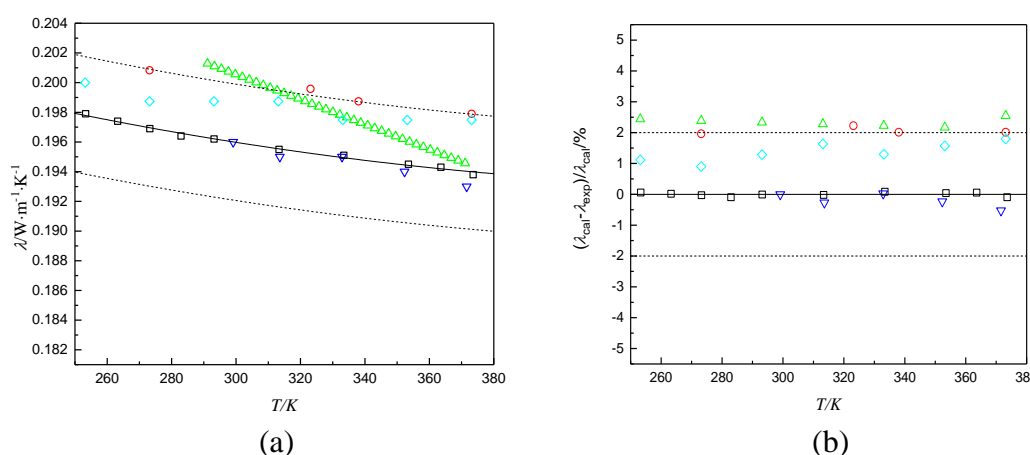

Figure 3 Comparison of thermal conductivity of 1,2-propanediol. \circ , Ref. [12]. \triangle , Ref. [26]. ∇ , Ref. [19]. \diamond , Ref. [9]. \square , present work. Solid line, calculated from correlation. Dash line, $\pm 2\%$.

3.2 Mixtures

Experiment results of thermal conductivity with different temperature and fractions are

Table 5 Thermal conductivity of 1,2-ethanediol binary solutions

T (K)	λ (W/m·K)	T (K)	λ (W/m·K)
$x_1=0.2008, w_1=0.4641$		$x_1=0.5980, w_1=0.8368$	
253.27	0.3727	253.34	0.2802
263.09	0.3802	263.2	0.2820
272.91	0.3877	273.19	0.2848
282.70	0.3953	283.04	0.2874
292.68	0.4040	292.89	0.2897
312.40	0.4182	312.73	0.2951
332.22	0.4305	332.48	0.2993
352.05	0.4387	352.36	0.3028
362.06	0.4422	362.28	0.3040
372.03	0.4448	372.24	0.3048
$x_1=0.4014, w_1=0.6980$		$x_1=0.7992, w_1=0.9321$	
253.63	0.3140	253.57	0.2542
263.33	0.3169	263.46	0.2553
273.19	0.3210	273.41	0.2564
283.12	0.3259	283.18	0.2572
292.94	0.3299	293.05	0.2585
312.75	0.3387	312.89	0.2612
332.49	0.3457	332.61	0.2633
352.41	0.3512	352.93	0.2654
362.35	0.3534	362.98	0.2660
372.39	0.3551	372.98	0.2664

x_1 : mole fraction of 1,2-ethanediol; w_1 : mass fraction of 1,2-ethanediol

presented in Table 5 (1,2-ethanediol) and Table 6 (1,2-propanediol).

Owing to the lack of fully developed thermal conductivity predictive models for liquid mixtures, empirical and semi-empirical correlation equations are considered in the literature. The second-order Scheffé polynomial was applied in this paper. With its simple forms, the polynomial is able to correlate binary data satisfactorily.[27]

$$\lambda_m = \lambda_1 w_1^2 + \lambda_2 w_2^2 + 2\beta_{12} w_1 w_2 \quad (2)$$

with λ_1 and λ_2 thermal conductivity of pure liquids predicted by Eq.(1), and β_{12} expressed by

$$\beta_{12} = A_{12} + B_{12}T \quad (3)$$

Combining Eq.(1)(2)(3), the thermal conductivity of binary solutions can be calculated by fractions of components and temperature. Thermal conductivity of pure water is obtained by IAPWS formulation.[28] The coefficients in these equations are presented in Table 7.

As error of correlation shown in Figure 4 and Figure 5, the average absolute deviations

Table 6 Thermal conductivity of 1,2-propanediol binary solutions

T (K)	λ (W/m·K)	T (K)	λ (W/m·K)
$x_1=0.2004, w_1=0.5143$		$x_1=0.6001, w_1=0.8638$	
254.17	0.3358	253.30	0.2287
264.00	0.3403	263.16	0.2289
273.50	0.3466	273.09	0.2292
283.35	0.3529	283.02	0.2298
293.25	0.3588	292.99	0.2305
313.08	0.3691	312.64	0.2324
332.89	0.3792	332.78	0.2347
352.41	0.3849	352.58	0.2359
362.73	0.3878	362.73	0.2362
372.72	0.3890	372.56	0.2361
$x_1=0.4031, w_1=0.7405$		$x_1=0.8013, w_1=0.9446$	
253.12	0.2643	253.01	0.2098
263.10	0.2652	263.23	0.2098
273.19	0.2670	274.26	0.2098
283.11	0.2687	284.30	0.2098
293.32	0.2720	294.28	0.2100
313.38	0.2773	313.85	0.2102
333.07	0.2817	333.77	0.2105
353.14	0.2849	353.26	0.2110
363.25	0.2866	363.14	0.2110
373.45	0.2869	373.20	0.2108

x_1 : mole fraction of 1,2-propanediol; w_1 : mass fraction of 1,2-propanediol

and the maximum absolute deviations of the calculated thermal conductivity of mixtures from experimental data are respectively 0.87 %, 2.52 % for 1,2-ethanediol, and 0.53 %, 1.53 % for 1,2-propanediol. The calculated values are in satisfying agreement with the experiment data.

Table 7 Fitting parameters for aqueous solutions

Parameter	1,2-Ethanediol	1,2-Propanediol
a_1	-5.9997×10^{-07}	1.6981×10^{-07}
b_1	4.5786×10^{-04}	-1.3731×10^{-04}
c_1	1.6558×10^{-01}	2.1992×10^{-01}
a_2	-9.2221×10^{-06}	-8.9967×10^{-06}
b_2	7.1540×10^{-03}	7.0008×10^{-03}
c_2	-7.0826×10^{-01}	-6.8217×10^{-01}
A_{12}	2.3589×10^{-01}	2.3526×10^{-01}
B_{12}	4.3606×10^{-04}	3.2318×10^{-04}
MAD	2.52%	1.53%
AAD	0.87%	0.53%
Bias	-0.32%	-0.21%

Note: subscript 1 denotes glycol, subscript 2 denotes water.

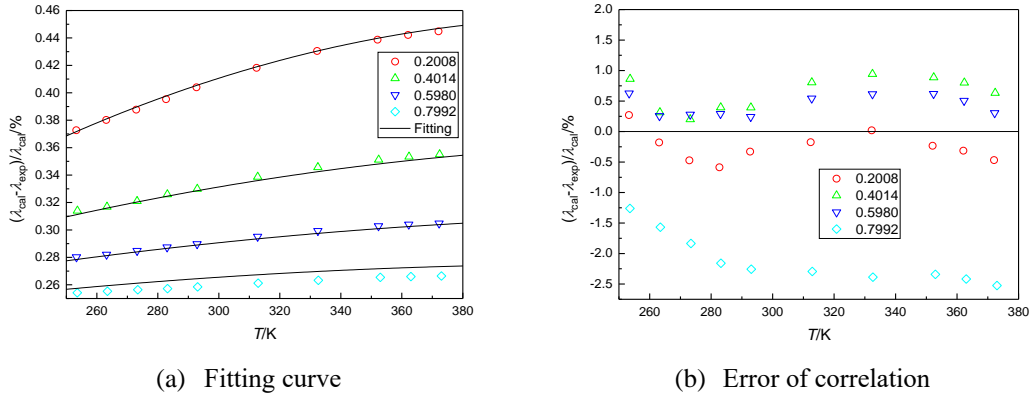

Figure 4 Fitting curves and errors of aqueous solutions of 1,2-ethanediol

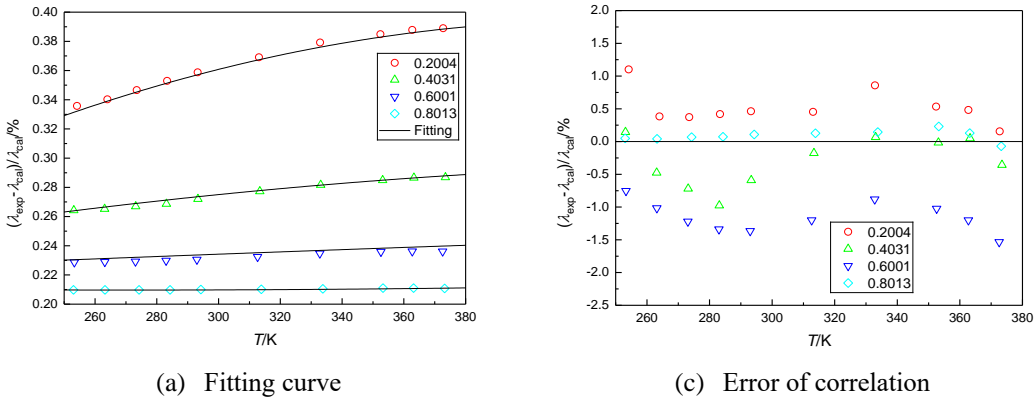

Figure 5 Fitting curves and errors of aqueous solutions of 1,2-propanediol

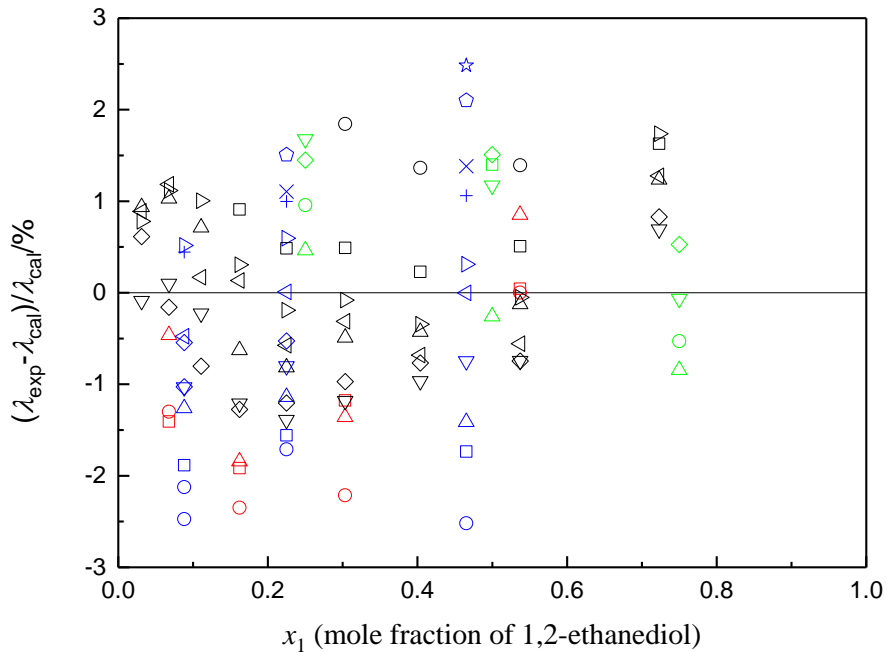

Figure 6 Deviations of the thermal conductivity fitting equation of 1,2-ethanediol from experiment values of other investigators. Measurements at similar temperature (within $\pm 2.5\text{K}$) are put in the same temperature groups. Ref. [12]: \circ 273K, \square 323K, \triangle 373K. Ref. [17]: \circ 297K, \square 302K, \triangle 308K, ∇ 314K, \diamond 319K, \triangleleft 325K, \triangleright 329K, $+$ 335K, \times 341K, \square 347K, \star 355K. Ref [18]: \circ 301K, \square 312K, \triangle 324K, ∇ 348K, \diamond 372K. Ref[9]: \circ 233K, \square 253K, \triangle 273K, ∇ 293K, \diamond 333K, \triangleleft 353K, \triangleright 373K.

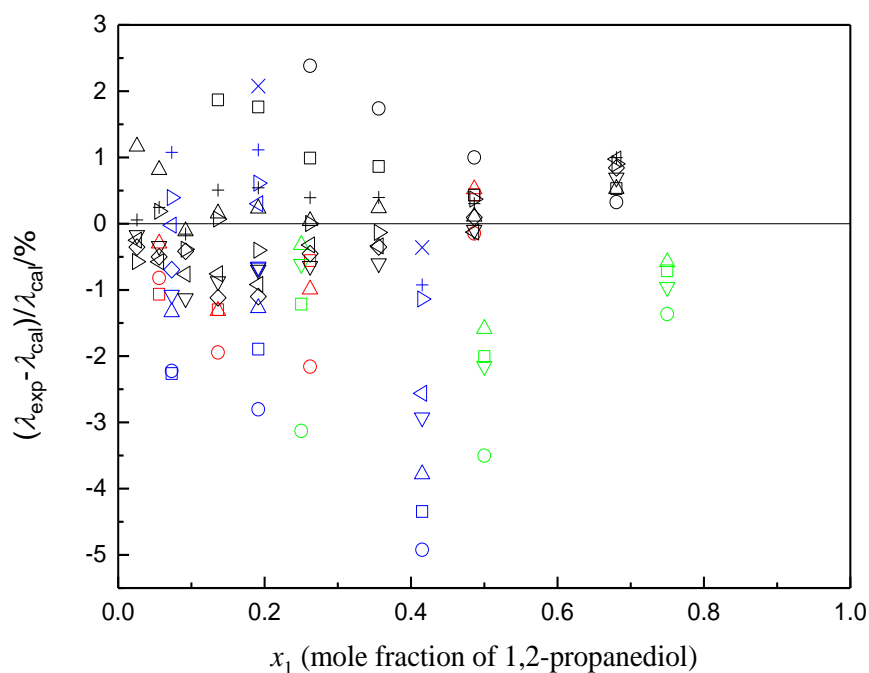

Figure 7 Deviations of the thermal conductivity fitting equation of 1,2-propanediol from experiment values of other investigators. Measurements at similar temperature (within ± 2.5 K) are put in the same temperature groups. Ref. [12]: \circ 273K, \square 323K, \triangle 373K. Ref.[17]: \circ 297K, \square 302K, \triangle 310K, ∇ 317K, \diamond 320K, \triangleleft 325K, \triangleright 331K, $+$ 338K, \times 345K. Ref[19]: \circ 299K, \square 323K, \triangle 348K, ∇ 372K, \diamond 398K, \triangleleft 420K, \triangleright 441K. Ref[9]: \circ 233K, \square 253K, \triangle 273K, ∇ 293K, \diamond 313K, \triangleleft 333K, \triangleright 353K, 373K.

The deviations of correlation from other authors' measurements are shown in Figure 6 and Figure 7. Most values are within $\pm 3\%$ of the fitting equations, indicating the good agreement between the measurements of present work and others. The largest deviation is 2.52% for 1,2-ethanediol, and 4.92% for 1,2-propanediol.

4 Conclusions

Thermal conductivity of binary aqueous solutions of 1,2-ethanediol and 1,2-propanediol was measured using the transient hot wire method at temperature from 253.15 K to 373.15 K at atmospheric, with mole fractions of glycol to be 0%, 20%, 40%, 60%, 80% and 100% for both solutions. The measurement uncertainty of thermal conductivity is estimated to be better than $\pm 2\%$ with a coverage factor of $k=2$. Thermal conductivity of pure liquids is correlated with temperature via second-order polynomial and is found to be in good agreement with other reports. The second-order Scheffé polynomial was used to correlate the temperature and composition dependence of the experimental thermal conductivity. The average absolute deviations and the maximum absolute deviations of those calculated values from the experimental data are 0.87 %, 2.52 %, and 0.53 %, 1.53 %, respectively. Experiment values from other authors are compared with correlation functions and they are in good agreement.

References

1. Shamsetdinov F, N., et al., *Experimental study of the thermal conductivity of ammonia + water refrigerant mixtures at temperatures from 278 K to 356 K and at pressures up to 20*

- MPa*. International journal of refrigeration, 2013. **36**(4): p. 1347-1368.
2. Rebsdatt, S. and D. Mayer, *Ethylene Glycol*, in *Ullmann's Encyclopedia of Industrial Chemistry*. 2000, Wiley-VCH Verlag GmbH & Co. KGaA.
 3. Sullivan, C.J., *Propanediols*, in *Ullmann's Encyclopedia of Industrial Chemistry*. 2000, Wiley-VCH Verlag GmbH & Co. KGaA.
 4. ASHRAE, *Physical properties of secondary coolants (brines)*, in *ASHRAE handbook—fundamentals*. 2005, ASHRAE: Atlanta.
 5. Najjar, M.S., K.J. Bell, and R.N. Maddox, *The Influence of Improved Physical Property Data on Calculated Heat Transfer Coefficients*. Heat Transfer Engineering, 1981. **2**(3-4): p. 27-39.
 6. Bohne, D., S. Fischer, and E. Obermeier, *Thermal, Conductivity, Density, Viscosity, and Prandtl-Numbers of Ethylene Glycol-Water Mixtures*. Berichte der Bunsengesellschaft für physikalische Chemie, 1984. **88**(8): p. 739-742.
 7. Kroenlein, K., et al. *ThermoLit: NIST Literature Report Builder for Thermalchemical Properties Measurements*. 2016 [cited 2017 2017/11/6]; Available from: <http://trc.nist.gov/thermolit/main/home.html#home>.
 8. Bates, O. and G. Hazzard, *Thermal Conductivity of Alcohols and Glycols*. Industrial & Engineering Chemistry, 1945. **37**(2): p. 193-195.
 9. Riedel, L., *Measurement of Thermal Conductivity of Mixtures of Several Organic Compounds with Water*. Chem.-Ing.-Tech., 1951. **23**: p. 465.
 10. Rastorguev, Y.L. and Y.A. Ganiev, *Thermal Conductivity of Aqueous Solutions of Organic Liquids*. Russ. J. Phys. Chem., 1966. **40**: p. 869-871.
 11. Rastorguev, Y.L. and Y.A. Ganiev, *Thermal conductivity of organic liquids*. Zh. Fiz. Khim., 1967. **41**: p. 1352.
 12. Vanderkooi, W.N., D.L. Hildenbrand, and D.R. Stull, *Liquid thermal conductivities. The apparatus, values for several glycols and their aqueous solutions, and five high molecular weight hydrocarbons*. Journal of Chemical & Engineering Data, 1967. **12**(3): p. 377-379.
 13. Ganiev, Y.A. and Y.L. Rastorguev, *Thermal Conductivity of Mixed Non-Electrolyte Solutions*. Russ. J. Phys. Chem., 1968. **42**: p. 68-71.
 14. Usmanov, I.U. and A.S. Salikhov, *The Concentration Variation of the Thermal Conductivities of Certain Aqueous Solutions of Organic Liquids*. Russ. J. Phys. Chem., 1977. **51**: p. 1488-1489.
 15. Bogacheva, I.S., et al., *Heat Conductivity of Mixtures of Organic Liquids*. Russ. J. Phys. Chem., 1980. **54**: p. 838-839.
 16. Grigrev, A., *Thermal Conductivity: Water and Water-Organic Systems*. Sov. Un. Gov. Bur. of Stand., Grozny Oil Inst., Infor. Seri, 1985.
 17. Assael, M.J., et al., *Absolute measurements of the thermal conductivity of mixtures of alkene-glycols with water*. International Journal of Thermophysics, 1989. **10**(6): p. 1127-1140.
 18. Sun, T. and A.S. Teja, *Density, Viscosity, and Thermal Conductivity of Aqueous Ethylene, Diethylene, and Triethylene Glycol Mixtures between 290 K and 450 K*. Journal of Chemical & Engineering Data, 2003. **48**(1): p. 198-202.
 19. Sun, T. and A.S. Teja, *Density, Viscosity and Thermal Conductivity of Aqueous Solutions of Propylene Glycol, Dipropylene Glycol, and Tripropylene Glycol between 290 K and 460 K*. Journal of Chemical & Engineering Data, 2004. **49**(5): p. 1311-1317.
 20. Wu, J., et al., *Thermal Conductivity of Liquid Dimethyl Ether from (233 to 373) K at Pressures*

- up to 30 MPa*. Journal of Chemical & Engineering Data, 2009. **54**(6): p. 1720-1723.
21. Focke, W.W., *Correlating Thermal-Conductivity Data for Ternary Liquid Mixtures*. International Journal of Thermophysics, 2008. **29**(4): p. 1342-1360.
 22. Ganiev, Y.A., *Thermal conductivity of glycols*. Zh. Fiz. Khim., 1969. **43**: p. 239-240.
 23. Rastorguev, Y.L. and M.A. Gazdiev, *Study of the thermal conductivity of manyatomic alcohols*. Inzh.-Fiz. Zh., 1969. **17**: p. 72-79.
 24. DiGuilio, R. and A.S. Teja, *Thermal Conductivity of Poly(ethylene glycoles) and Their Binary Mixtures*. J. Chem. Eng. Data, 1990. **35**: p. 117.
 25. Pastoriza-Gallego, M.J., L.C. Lugo, D., and J.L.P. Legido, M. M., *Thermophysical profile of ethylene glycol-based ZnO nanofluids*. J. Chem. Thermodyn, 2014. **73**: p. 23-30.
 26. Mallan, G.M., M.S. Michaelian, and F.J. Lockhart, *Liquid thermal conductivities of organic compounds and petroleum fractions*. J. Chem. Eng. Data, 1972. **17**: p. 412.
 27. Zhou, J.-C., et al., *Thermal Conductivity of DMSO + C₂H₅OH, DMSO + H₂O, and DMSO + C₂H₅OH + H₂O Mixtures at T = (278.15 to 338.15) K*. Journal of Chemical & Engineering Data, 2013. **58**(3): p. 663-670.
 28. Huber, M.L., et al., *New international formulation for the thermal conductivity of H₂O*. Journal of Physical and Chemical Reference Data, 2012. **41**(3): p. 033102.