

# A PID-Sliding Mode Control Design for a Coupled Tank

Ahmed RHIF, Zohra Kardous, Naceur BenHadj Braiek

Advanced System Laboratory, Polytechnic School of Tunisia (Laboratoire des Systèmes Avancés (L.S.A), Ecole Polytechnique de Tunisie)

Email: ahmed.rhif@issatso.rnu.tn, zohra.kardous@enit.rnu.tn, naceur.benhadj@ept.rnu.tn

**Abstract** — The sliding mode control (SMC) is strongly requested due to its robustness against the disturbances. The principle of the sliding mode control is to force the system to converge toward a selected surface and then to evolve there in spite of the uncertainties and the disturbances. The surface is defined by a set of relations between the state variables of the system. However, the chattering phenomenon remains the main disadvantage of this robust control. As solution to this problem, a PID sliding mode approach is exposed and tested in this paper.

**Keywords** — sliding mode control, discontinuous control, multimodel fusion, Lyapunov stability, stabilization.

## 1. INTRODUCTION

The sliding mode approach is classified in the monitoring with Variable System Structure (VSS) [1-3]. The sliding mode is strongly requested seen its facility of establishment, its robustness against the disturbances and models uncertainties. The principle of the sliding mode control is to force the system to converge towards a selected surface and then to evolve there in spite of uncertainties and the disturbances. The surface is defined by a set of relations between the state variables of the system. The sliding surface is defined according to the control objectives and to the wished performances in closed loop, the synthesis of the discontinuous control is carried out in order to force the trajectories of the system state to reach the sliding surface, and then, to evolve in spite of uncertainties, of parametric variations,... The sliding mode exists when commutations take place in a continuous way between two extreme values  $u_{\min}$  and  $u_{\max}$  [4, 5].

First of all, in this case, we will be interested in the problem of the stabilizing control existence. Then we will give an outline for the state space stabilizing partition construction. For the systems controlled with a sliding mode control (SMC), the Lyapunov function is often requested [6]. This method is based on the linearization around the balance points and on linear systems per pieces. To determine the fields of stability, many theories established the fact that the system which trajectory is attracted towards a balance point loses energy gradually in a monotonous way. Lyapunov generalizes the concept of energy by using a candidate function  $V(X)$  which depends on the state of the system [7].

This paper is organized in three parts: first we start by presenting the SMC theory and its stabilization conditions in general case. After that, we describe the hydraulic process: coupled tank. Finally, we expose the process model as well as the design of a PID-sliding mode control as a solution to the chattering phenomenon.

## 2. STUDIED PROCESS: DESCRIPTION AND MODELING

In hydraulic plants [8], we need often to control the level of the liquid in a tank. Usually, the classical regulator implemented by these controls is PID [9-11]. This controller is designed to obtain the best characteristics in terms of steady state error, response speed and stability. The hydraulic system is existing together with two extra-modules which allow the automatic control of the level and the flow with variable coefficients of the analogical PID controller. The circuits and techniques employed on this system present the same functionalities, aims and performances as that used in the professional field.

### *Specifications of the hydraulic process:*

The hydraulic system with coupled tank is composed of two transparent tanks made in Figure 1. In the horizontal one (Tank 2), an electrical water pump is used to transfer the liquid, water, from this tank to the vertical one (Tank 1). On the concerned process there are two transducers: flow and level.

The flow transducer is a “blade or turbine flow-meter” that provides the system output with a pulse voltage which frequency is proportional to the liquid flow.

The level transducer uses the pressure exerted by the water in the first tank (tank1) to generate an elementary deformation on the inbuilt Strain Gages. Then the liquid level can be deduced from a signal conditioner proportional to this pressure.

### *The process modelling:*

The system with coupled tank is considered as a benchmark for the study and the analysis of the hydraulic systems control problems. This designed device allows us to examine the control level of the liquid in a tank by varying the flow of the pump  $P$  using the valve  $V_1$  or by applying a disturbance using the valve  $V_2$  (Figure 1).

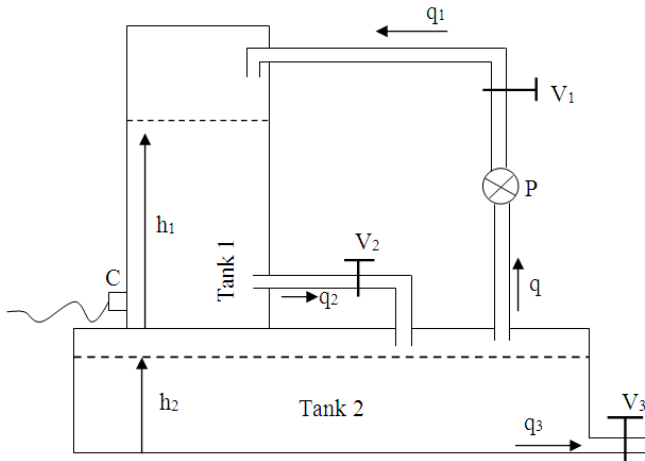

Figure 1. The hydraulic system conception

Table 1 presents the various parameters of this hydraulic system.

**Table.1 System parameters**

$A_1$	Section of tank 1	0.03 m <sup>2</sup>
$A_2$	Section of tank 2	0.08 m <sup>2</sup>
$s_1$	Variable section of valve 1	0.00008 m <sup>2</sup>
$s_2$	Variable section of valve 2	0.00008 m <sup>2</sup>
$s_3$	Variable section of valve 3	0.00008 m <sup>2</sup>
$a_1$	Discharge coefficient	1
$a_2$	Discharge coefficient	1
$a_3$	Discharge coefficient	1
$h_1$	Tank 1 level	0.6 m
$h_2$	Tank 2 level	0.2 m
$u$	Input Power	12 v
$k_p$	Pump Gain	7.5 m <sup>3</sup> /s.v
$k_s$	Transducer Gain	40 v/m
$g$	Gravity constante	9.8 m/sec <sup>2</sup>

Using table 1, the relation between the supply voltage  $u$  of the pump and the input flow  $q$  can be written as (1).

$$\begin{cases} q = k_p u \\ q_2 = s_2 a_2 \sqrt{2g(h_1 - h_2)} \\ q_3 = s_3 a_3 \sqrt{2gh_2} \end{cases} \quad (1)$$

The vertical tank (tank 1) can be filled from the horizontal tank (tank 2) via the variable channel 1 by opening the valve  $V_1$  placed after the pump which changes the incoming flow. A second valve  $V_2$  (channel 2) inserted below the vertical tank (tank 2) may change the output flow  $q_2$ . When we consider only the case of level control, we will have  $q_1 = q$ . By using the flow equilibrium equation we obtain:

$$\begin{cases} \dot{h}_1 = \frac{1}{A_1} (q_1 - q_2) \\ \dot{h}_2 = \frac{1}{A_2} (q_2 - q_3) \end{cases} \quad (2)$$

Finally, the hydraulic system is modelled by the following state representation (3).

$$\begin{cases} \dot{h}_1 = \frac{1}{A_1} (k_p u - s_2 a_2 \sqrt{2g(h_1 - h_2)}) \\ \dot{h}_2 = \frac{1}{A_2} (s_2 a_2 \sqrt{2g(h_1 - h_2)} - s_3 a_3 \sqrt{2gh_2}) \\ y = k_s h_1 \end{cases} \quad (3)$$

We consider  $x = \begin{pmatrix} x_1 \\ x_2 \end{pmatrix}$  with  $x_1 = h_1$  and  $x_2 = h_2$ , equation (3) gives (4).

$$\begin{cases} \dot{x}_1 = \frac{1}{A_1} (k_p u - s_2 a_2 \sqrt{2g(x_1 - x_2)}) \\ \dot{x}_2 = \frac{1}{A_2} (s_2 a_2 \sqrt{2g(x_1 - x_2)} - s_3 a_3 \sqrt{2gx_2}) \\ y = k_s x_1 \end{cases} \quad (4)$$

From equation (4), we can represent this nonlinear system by the following form (5).

$$\begin{cases} \dot{x}_1 = f_1(x) + Bu \\ \dot{x}_2 = f_2(x) \\ y = Cx_1 \end{cases} \quad (5)$$

with

$$f_1(x) = \frac{-s_2 a_2}{A_1} \sqrt{2g(x_1 - x_2)}, \quad C = k_s \quad \text{and} \quad B = \frac{k_p}{A_1}$$

$$f_2(x) = \frac{s_2 a_2}{A_2} \sqrt{2g(x_1 - x_2)} - \frac{s_3 a_3}{A_2} \sqrt{2gx_2}$$

## 2. REVIEW OF SLIDING MODE THEORY

### 2.1 The sliding mode control synthesis

We consider a general non linear system represented by (6) [12].

$$\dot{x} = f(x) + g(x)u + h(t, x) \quad (6)$$

where  $x$  represents the state variable,  $f(x)$  and  $g(x)$  two non linear state functions and  $h(t, x)$  a function representing the disturbances. This function is limited by a known scalar function  $\Pi$  (7).

$$\|h(t, x)\| \leq \Pi(t, x) \quad (7)$$

To have a sliding mode control, it is necessary to fix a surface  $s = s(t, x) = 0$  and to synthesize a commutation law to force the system to reach the trajectory and then to slide in that surface.

The control law can be composed of two parts:

$$u = u_0 + u_1 \quad (8)$$

- $u_0$  the nominal control
- $u_1$  the discontinuous control allowing to reject the disturbances.

The discontinuous control  $u_1$  must satisfy the following condition:

$$g(x)u_1 = -h(t, x) \quad (9)$$

#### ❖ The nominal control

The nominal control  $u_0(x)$  is designed for systems with no disturbances. This control preserves the system asymptotic.

The system would be written as follow:

$$\dot{x} = f(x_0) + g(x_0)u_0 \quad (10)$$

where  $x_0$  is the system trajectory ensured by the nominal control  $u_0$ .

#### ❖ The discontinuous control

The discontinuous control  $u_1$  may have different forms.

In this way we can represent it by:

$$u_1 = -M(x)\text{sign}(s) \quad (11)$$

with  $M(x)$  is a linear function.

In this way, the system dynamic by sliding mode is represented in (12).

$$\dot{x} = f(x) + g(x)u_0(x) \quad (12)$$

We notice that this representation is equal to the one in the nominal case [13].

Other ways, there are three different sliding mode structures: in the first one, the commutation takes place on the control unit, the second structure uses commutation on the state feedback and the third one is a structure by commutation on the control unit with addition of the equivalent control.

The high order sliding mode control consists in computing the derivative of the sliding variable. This method allows the rejection of the chattering phenomenon while preserving the robustness of the approach. For that, two algorithms can be used: the twisting algorithm and the super twisting algorithm. A comparison between the two algorithms was achieved and shows that the super twisting algorithm is more efficient than the twisting algorithm, despite the approximate results, since it does not ensure the same robustness to perturbations [14-16]. The aim of the high order sliding mode control is to force the system trajectories to reach in finite time the sliding set of order  $r \geq \rho$  defined by:

$$S^r = \left\{ x \in \mathbb{R}^n : s = \dot{s} = \dots = s^{(r-1)} = 0 \right\}, r \in \mathbb{N} \quad (13)$$

with  $\rho > 0$ ,  $s(x, t)$  the sliding function: it is a differentiable function with its  $(r - 1)$  first time derivatives depending only on the state  $x(t)$  (that means they contain no discontinuities).

#### 2.2 Stabilizing conditions of the sliding mode control

Here the sliding mode control is designed for the nonlinear system (14).

$$\begin{cases} \dot{x} = Ax + Bu + \varphi(x, u) \\ y = Cx \end{cases} \quad (15)$$

with

$$A \in \mathbb{R}^{n \times n}, B \in \mathbb{R}^{n \times 1}, C = (c_1 \dots c_n); \quad c_i > 0, i = 1, \dots, n$$

and  $\varphi(x, u)$  the nonlinear part :

$$\varphi(x, u) = \begin{pmatrix} 0 \\ 0 \\ \vdots \\ \varphi_n \end{pmatrix}; \quad \|\varphi(x, u)\| < Mx \quad (16)$$

We start by considering a linear sliding surface (17).

$$s = Cx = 0 \quad (17)$$

To ensure the existence of such mode we design a switching control  $u_s$  that makes the system reach the sliding surface and satisfy the stability condition  $s\dot{s} < 0$ . This control may have several structure, here we choose the following one (12).

$$u_s = -ks = -k|s|\text{sign}(s) \quad (18)$$

with  $k > 0$ .

To study the stability of the sliding mode control for the system (15), we consider a quadratic Lyapunov function  $V = \frac{1}{2}s^2$ , then have to prove that  $\dot{V} = s\dot{s} < 0$ .

The first derivative of the considered sliding surface (19) is written below:

$$\dot{s} = CAx + CBu + C\varphi(x, u) \quad (20)$$

as we have:

$$\begin{aligned} -Mx < \varphi(x, u) < Mx \quad \text{then} \quad -CMx < C\varphi(x, u) < CMx \\ \Leftrightarrow s\dot{s} < s(CAx + CBu + CMx) \end{aligned}$$

Now, we have to prove that  $s(CAx + CBu + CMx) < 0$

Notice that in the converging phase to the sliding surface we have  $u_s = u$ , then equations (15), (17) and (20) give:

$$\Leftrightarrow x^T (C^T CA - C^T CBkC + C^T CM) x < 0$$

$$\Leftrightarrow k > (C^T CBC)^{-1} (C^T CA + C^T CM)$$

Then, to make the system converge to the sliding surface, we have to ensure the equation (21) that guarantees  $s\dot{s} < 0$ .

$$k > (BC)^{-1} (A + MI) \quad (21)$$

To evaluate the control law that makes the system stable in the reaching phase to the desired state, we use the fact that  $s\dot{s} < 0$ .

Equation (16) gives:

$$\begin{aligned} -Mx < \varphi(x,u) < Mx &\Rightarrow -CMx < C\varphi(x,u) < CMx \\ \Rightarrow CAx + CBu - CMx < \dot{s} < CAx + CBu + CMx \end{aligned}$$

Then In the reaching phase to the desired state, the following equation (15) gives the stabilizing control law of the system.

$$u = \begin{cases} -(CB)^{-1}(CA - CM)x - \varepsilon & \text{if } s > 0 \\ -(CB)^{-1}(CA + CM)x + \varepsilon & \text{if } s < 0 \end{cases} \quad (22)$$

with  $\varepsilon > 0$  and  $I$  the identity matrix.

Consider  $s$  a sliding surface such as:

$$s = C\hat{x} \quad (23)$$

with  $C=k_s$  and  $\hat{x} = x_d - x_r$ ,  $x_d$  the desired state and  $x_r$  the real state.

To carry out the system on the sliding surface  $s$ , we select a discontinuous control which commutates between two different values:  $u_s = -k \text{sign}(s)$ , with  $k$  a positive constant.

To ensure the system stability carried out by this control, we consider the Lyapunov candidate function  $v = \frac{1}{2}s^2$ ,  $\dot{v} = s\dot{s}$ , then we have to prove that  $\dot{v} < 0$ .

As we have  $\dot{s} = -m \text{sign}(s)$  we get:  $s\dot{s} = -m s \text{sign}(s)$ .

To make  $\dot{v} < 0$  we must choose  $m > 0$ .

### 2.3 The PID-Sliding mode control

To ensure the convergence of the system to the wished state, a high level switching control is often requested which generates the chattering phenomenon. In this way, a PID-sliding surface (24) with a saturation function will be proposed in this paper to solve this problem [17, 18].

$$s = \alpha_1(x_d - x_r) + \alpha_2 \frac{d(x_d - x_r)}{dt} + \alpha_3 \int_0^t (x_d - x_r) dt \quad (24)$$

then,

$$\dot{s} = \alpha_1 \frac{d(x_d - x_r)}{dt} + \alpha_2 \frac{d^2(x_d - x_r)}{dt^2} + \alpha_3(x_d - x_r)$$

The control law chosen for this approach will adopt the saturation function to reduce the discontinuity on the sliding surface. The control law will be given by:

$$u = \lambda \text{sat} \left( \frac{s}{\Omega} \right) \quad (25)$$

where,

$$u = \begin{cases} \lambda \text{sign}(s) & \text{if } |s| > \Omega \\ \lambda \left( \frac{s}{\Omega} \right) & \text{if } |s| \leq \Omega \end{cases} \quad (26)$$

with  $\lambda$  and  $\Omega > 0$ ,  $\Omega$  defines the half boundary layer thickness.

## 3. SIMULATION RESULTS

The simulation results are obtained using the following parameters: commutation constant  $k=1$  and the parameter of the sling surface  $\mu = 0.5$ . Knowing that during the experiment we keep completely  $V_1$  open and  $V_2$  half closed which induce a disturbance on the tank level, we obtained figures 2-7.

These results enable us to notice that the system controlled by a PID controller has a very great sensitivity to the disturbances created by  $V_2$ . This disturbance is about 20%. So this result shows us the no robust aspect of the PID (Figure 2). The second disadvantage of the PID appears in the commutation frequency and the level of the control (about 25) which are very high (figure 3). In another hand, by applying the sliding mode control, we notice that the system output is much more stable that ensure the system robustness to the disturbances (figure 4). The disturbances are about 3%; these oscillations are known as chattering phenomenon. In addition, the control level and its commutations frequency are much low than for the case of the PID (Figures 5 and 6). The sharp variations appeared on the sliding surface level (Figure 7), are due to the abrupt change of the set point.

In another hand, the PID-SMC with the saturation function gives us excellent results in term of stability and precision of the process output and control evolution. In this hand, Figure 8 shows the elimination of the chattering phenomenon in comparison with the Figure 5. Other ways, the control evolution (Figure 9) present a small discontinuous aspect before reaching the steady state in a short time. This lack of sharp commutations gives good operating conditions for the actuators.

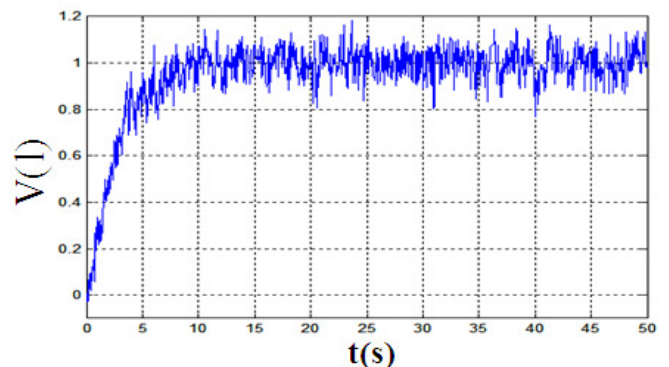

Figure 2. System evolution by PID

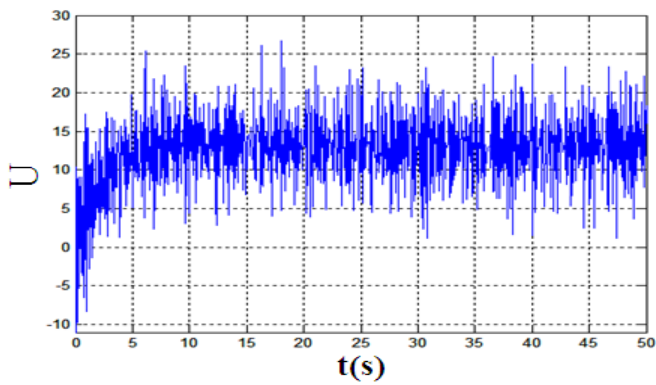

Figure 3. System control by PID

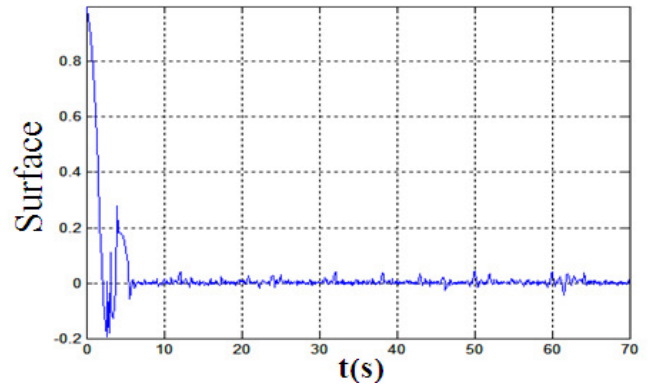

Figure 7. The sliding surface variation

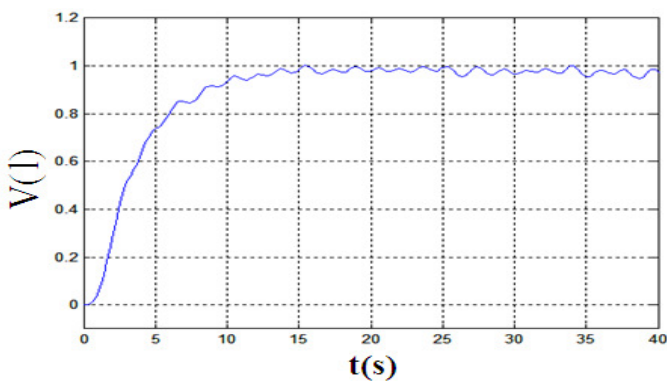

Figure 4. System evolution by sliding mode

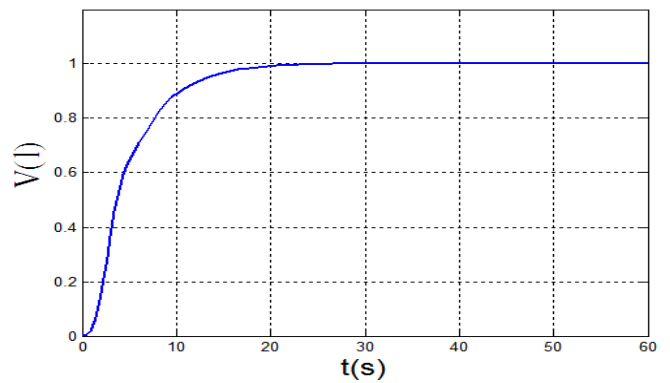

Figure 8. System evolution by PID-sliding mode

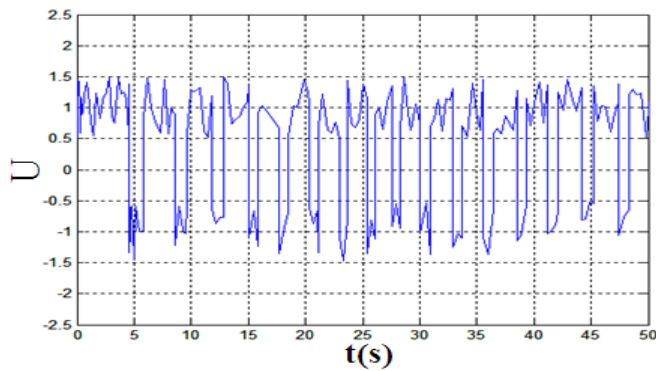

Figure 5. Sliding mode control evolution

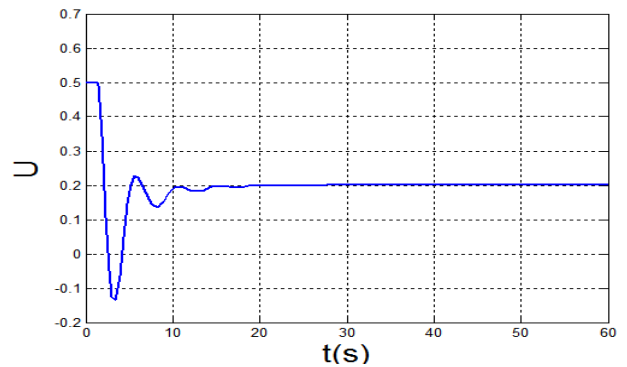

Figure 9. PID-Sliding mode control evolution

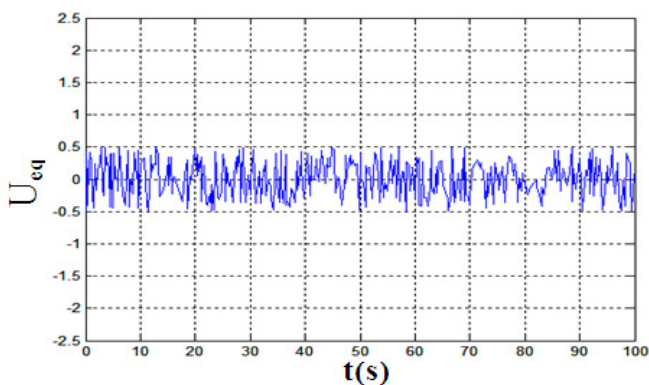

Figure 6. The equivalent control

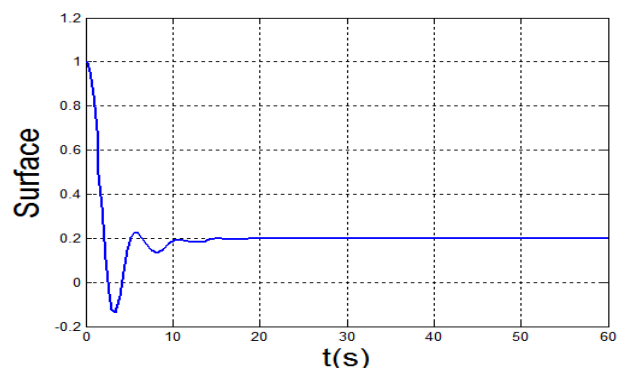

Figure 10. The sliding surface variation by PID-SMC

#### 4. CONCLUSION

In this work, we deal with the synthesis of a control law by sliding mode approach using a nonlinear sliding surface. In the first time, we presented the class and the properties of this sliding surface adopted. Then, a sliding mode control using the sliding surface developed together with stability studies were elaborated. After that, the PID-SMC approach was developed and compared with the other exposed methods. The simulations carried on the hydraulic system with coupled tank, show the effectiveness of this control (PID-SMC) in comparison with the other controls simulated such as sliding mode controller and PID controller.

#### REFERENCES

- [1] D.B. McDonald, "Lyapunov Optimizing Sliding Mode Control for Linear Systems with Bounded Disturbance," *Applied Mathematical Sciences*, Vol. 2, n.19, pp 901-918, USA, 2008.
- [2] N. Benhadj Braiek and F. Rotella, "Design of observers for nonlinear time variant systems", *IEEE Syst. Man and Cybernetics Conference*, vol. 4, pp. 219-225, 1993
- [3] V.I. Utkin, "Variable structure systems with sliding modes," *IEEE Transactions on Automatic Control*, vol. 22, no 2, pp. 212-222, 1977.
- [4] A.Rhif," Position Control Review for a Photovoltaic System: Dual Axis Sun Tracker", *IETE Technical Review*, Vol. 28, pp. 479-485, 2011.
- [5] A.Rhif," A Review Note for Position Control of an Autonomous Underwater Vehicle", *IETE Technical Review*, Vol. 28, pp. 486-492, 2011.
- [6] Z.Li, Q.Shui-sheng, "Analysis and Experimental Study of Proportional-Integral Sliding Mode Control for DC/DC Converter,"*Journal of Electronic Science and Technology of China*, vol. 3, n.2, 2005.
- [7] N. Benhadj Braiek, F. Rotella, M. Benrejeb, "Algebraic criteria for global stability analysis of nonlinear systems," *SAMS Journal*, Vol.17, pp. 211-227, 1995.
- [8] N.Hung, T.D.Viet, J.S.Im, H.K.Kim, S.B.Kim, "Motion Control of an Omnidirectional Mobile Platform for Trajectory Tracking Using an Integral Sliding Mode Controller", *International Journal of Control, Automation, and Systems*, vol. 8, no. 6, pp.1221-1231, 2010.
- [9] Hammoud Saari, Bernard Caron, Mohamed Tadjine," On the Design of Discrete Time Repetitive Controllers in Closed Loop Configuration", *Automatika*, vol. 51, pp.333-344, 2010.
- [10] M.Hanmandlu, "An AI based Governing Technique for Automatic Control of small Hydro Power Plants", *IETE Journal of Research*, pp. 119-126, Vol. 53, 2007.
- [11] Igor Erceg, Gorislav Erceg, Damir Sumina, "Development and Implementation of Control Algorithms for Synchronous Generator", *Automatika*, vol. 52, pp.95-106, 2011.
- [12] A.Rhif, Z.Kardous, N.Ben Hadj Braiek, "A high order sliding mode-multimodel control of non linear system simulation on a submarine mobile," Eighth International Multi-Conference on Systems, Signals & Devices, Sousse, Tunisia, March 2011.
- [13] M.Defoort, T.Floquet, A.Kokosy, W.Perruquetti, "A novel higher order sliding mode control scheme," *Systems & Control Letters*, Vol. 58, pp. 102-108, 2009.
- [14] A.Rhif, Z.Kardous, N.Ben Hadj Braiek, "A High Order Sliding Mode Observer: Torpedo Guidance Application," *Journal of Engineering & Technology*, vol. 2, pp.13-18, 2012.
- [15] W.J.Liu, K.K.Shyu, K.C.Hsu, "Design of Uncertain Multi-input Systems with State Delay and Input Deadzone Nonlinearity via Sliding Mode Control", *International Journal of Control, Automation, and Systems*, vol. 9, no. 3, pp.461-469, 2011.
- [16] S.Kamath, V.I.George and S.Vidyasagar,"Simulation study on closed loop control algorithm of type 1 diabetes mellitus patients", *IETE Journal of Research*, pp 230-235, Vol. 55, 2009.
- [17] A.Rhif, "A Sliding Mode Control with a PID sliding surface for Power output Maximizing of a Wind Turbine," *STM, Journal of Instrumentation and Control*, Vol.1, pp. 11-16, 2012.
- [18] A.Rhif, Z.Kardous, N.Ben Hadj Braiek, "A Sliding Mode Observer for a Sensorless Position Control Photovoltaic System", *Journal of Scientific and Industrial Research*, Vol.71, pp. 418-424, 2012.