

# Performing Quantum Measurement in Suitably Entangled States Originates the Quantum Computation Speed Up

Giuseppe Castagnoli\*, Dalida Monti<sup>†</sup>, and Alexander Sergienko<sup>‡</sup>

(October 1, 2018)

## Abstract

We provide a justification of the quantum speed-up based on the complementary roles played by the reversible preparation of an entangled state before measurement and by the final measurement action.

## I. INTRODUCTION

Why quantum computation can be more efficient than its classical counterpart is an open problem attracting increasing attention [1], [2]. The reason is naturally sought in the special features of quantum mechanics exploited in quantum computation, like state superposition, entanglement and quantum interference. Quantum measurement, instead, is generally considered necessary only to “read” the computation output. In the justification we shall provide, measurement does more than “reading” an output, it contributes in creating that output in a computationally efficient way.

We will show that the logical constraint that there is a single measurement outcome, acquires a striking function in existing quantum algorithms. It becomes a set of logical-mathematical constraints representing the problem to be solved, or the hard part thereof,

---

\*Elsag Bailey and Università di Genova, 1654 Genova, Italy

<sup>†</sup>Elsag Bailey and Università di Genova, 1654 Genova, Italy

<sup>‡</sup>Dept. of Electrical and Computer Engineering, Boston University, Boston, MA 02215, USA

whereas the measurement outcome, by satisfying these constraints, yields the solution.

In all these algorithms, the state before measurement is entangled with respect to a couple of observables<sup>1</sup>. It is a basic axiom of quantum measurement theory that the time required to measure an observable is independent of this possible entanglement: entanglement is interaction-free. The computational complexity of satisfying the above logical-mathematical constraints originates from entanglement and is transparent to measurement time.

On the basis of these arguments, we will justify the speed-up in all known quantum algorithms.

## II. OVERVIEW

For unity of exposition, we shall provide an overview of our justification of the speed-up based on a simplified version of Simon's algorithm. All details are deferred to the subsequent Sections.

The problem is as follows. Given  $B = \{0, 1\}$ , we consider a function  $f(x)$  from  $B^n$  to  $B^n$ . The argument  $x$  ranges over  $0, 1, \dots, N - 1$ , where  $N = 2^n$ ;  $n$  is said to be the size of the problem.

We assume that  $f(x)$  has the following properties:

- it is a 2-to-1 function, namely for any  $x \in B^n$  there is one and only one second argument  $x' \in B^n$  such that  $x \neq x'$  and  $f(x) = f(x')$ ;
- such  $x$  and  $x'$  are evenly spaced by a constant value  $r$ , namely:  $|x - x'| = r$ ;
- given a value  $x$  of the argument, computing the corresponding value of  $f(x)$  requires a time polynomial in  $n$  [ $\text{poly}(n)$ ]; whereas, given a value  $f$  of the function, finding an

---

<sup>1</sup>As we will see, also in Deutsch's and Grover's algorithms, provided that both the problem and the solution algorithm are represented in a physical way.

$x$  such that  $f(x) = f$ , requires a time exponential in  $n$  [ $\exp(n)$ ]; the function is “hard to reverse”.

Besides knowing the above properties, we can use a quantum computer that, given any input  $x$ , produces the output  $f(x)$  in  $\text{poly}(n)$  time. The problem is to find  $r$  in an efficient way, which turns out to be in  $\text{poly}(n)$  rather than  $\exp(n)$  time.

The computer operates on two registers  $a$  and  $v$ , each of  $n$  qubits;  $a$  contains the argument  $x$  and  $v$  – initially set at zero – will contain the result of computing  $f(x)$ . We denote by  $\mathcal{H}_{av} \equiv \text{span}\{|x\rangle_a, |y\rangle_v\}$ , with  $(x, y)$  running over  $B^n \times B^n$ , the Hilbert space of the two registers.

By using the quantum computer and standard operations like the Hadamard transform (see IV for details), we obtain in  $\text{poly}(n)$  time, at time  $t_2$ , the following state of the two registers (indexes are as in IV):

$$|\varphi, t_2\rangle_{av} = \frac{1}{\sqrt{N}} \sum_x |x\rangle_a |f(x)\rangle_v, \quad (1)$$

with  $x$  running over  $0, 1, \dots, N - 1$ .

We designate by  $[a]$  (an observable) the number stored in register  $a$ . Similarly  $[v]$  is the number stored in  $v$ . We measure  $[v]$  in state (1)<sup>2</sup>. Given the character of  $f(x)$ , measurement outcome has the form:

$$|\varphi, t_3\rangle_{av} = \frac{1}{\sqrt{2}} (|\bar{x}\rangle_a + |\bar{x} + r\rangle_a) |\bar{f}\rangle_v, \quad (2)$$

where  $\bar{f}$  is the value of the measured observable, and  $f(\bar{x}) = f(\bar{x} + r) = \bar{f}$ .

We will see that, under a reasonable criterion, the quantum speed-up has already been achieved by reaching state (2) – see also Section IV.

Since the speed-up is referred to an efficient classical computation that yields the same result, the quantum character of state (2) constitutes a difficulty. This difficulty can be

---

<sup>2</sup>This intermediate measurement can be skipped, but we will see that it is mathematically equivalent either performing or skipping it.

avoided by resorting to the notion of the computational cost of classically producing the *description* of state (2). This criterion yields a more universal way of comparing quantum and classical efficiency, and coincides with the usual one when the quantum algorithm has produced the “classical reading”. It will be instrumental in achieving an a-posteriori self-evident result.

Thus, we should assess the cost of classically producing description (2). Of course, we must think that  $\bar{x}$ ,  $\bar{x} + r$ , and  $\bar{f}$  are appropriate numerical values. Finding them requires solving the following system of numerical algebraic equations:

$$\begin{aligned} f(x_1) &= f(x_2), \\ x_1 &\neq x_2. \end{aligned} \tag{3}$$

Fig. 1

It is convenient to resort to the network representation of equations (3) – fig. 1. The gate  $c(x_1, x_2)$  imposes that, if  $x_1 \neq x_2$ , then the output is 1, if  $x_1 = x_2$ , then the output is 0, and vice-versa. To impose  $x_1 \neq x_2$ , the output must be set at 1. Note that the network represents a system of algebraic equations: time is not involved and gates are just logical constraints.

Each of the two gates  $f(x)$  imposes that, if the input is  $x$ , then the output is  $f(x)$  or, conversely, if the output is  $f$ , then the input is an  $x$  such that  $f(x) = f$ .

This network is hard to satisfy by classical means. Because of the looped network topology, finding a valuation of  $x_1, x_2$  and  $f$  satisfying the network requires reversing  $f(x)$  at least once, which takes, by assumption,  $\exp(n)$  time.

Instead, the time to produce state (2) with Simon’s algorithm, is the sum of the  $\text{poly}(n)$  time required to produce state (1), and the time required to measure the observable  $[v]$  in state (1). This latter is independent of the entanglement between registers  $v$  and  $a$  and is simply linear in the number of qubits of register  $v$ , namely in  $n$ . The overall time is  $\text{poly}(n)$ . Under the above criterion, the speed-up has already been achieved.

We shall provide two ways of seeing the active role played by the action of measuring  $[v]$ .

In Section III, we will show that measuring  $[v]$  introduces and satisfies, in linear( $n$ ) time, a system of algebraic equations in Hilbert space (the one-outcome constraint and consequent ones) equivalent, under the above criterion, to the system of algebraic equations (3).

Here, this active role will be discussed at a conceptual level. The previous criterion needs to be extended. The computational cost of producing a quantum state starting from another quantum state will be benchmarked with the cost of classically producing the description of the former starting from the description of the latter.

We shall instrumentally use the following way of thinking (opposite to our view):

quantum computation can produce a number of parallel outputs exponential in register size, at the cost of producing one output, but this “exponential wealth” is easily spoiled by the fact that quantum measurement reads only one output.

Let us examine the cost of classically deriving description (2) from description (1). The latter can be visualized as the print-out of the sum of  $2^n$  tensor products. Loosely speaking, two values of  $x$  such that  $f(x_1) = f(x_2)$ , must be  $\exp(n)$  spaced. Otherwise such a pair of values could be found in  $\text{poly}(n)$  time by classical “trial and error”.

The point is that the print-out would create a Babel Library<sup>3</sup> effect. Even for a small  $n$ , it would fill the entire known universe with, say, ...  $|x_1\rangle_a |f(x_1)\rangle_v$  ... here, and ...  $|x_2\rangle_a |f(x_2)\rangle_v$  ... [such that  $f(x_1) = f(x_2)$ ] in Alpha Centauri. Finding such a pair of print-outs would still require  $\exp(n)$  time. The capability of directly accessing that “exponential wealth” would be vanifed by its “exponential dilution”.

Quantum measurement, instead, *distills* the desired pair of arguments in a time linear in  $n$ . In fact, it does more than randomly selecting one measurement outcome; by selecting *one* outcome, it performs a logical operation (selecting the two values of  $x$  associated with the value of that outcome) crucial for solving the problem.

---

<sup>3</sup>From the story “The Library of Babel” by J.L. Borges.

The active role played by quantum measurement, complementary to the production of the parallel computation outputs, is self-evident. In Section III, this role will be pinpointed in a rigorous way.

### III. QUANTUM ALGEBRAIC COMPUTATION

It is easy to show that quantum measurement introduces and satisfies a system of algebraic equations equivalent to (3). By going through elementary notions, we will highlight the pattern of a new form of computation.

We shall first apply von Neumann’s model to the quantum measurement of  $[v]$  in state (1). This model is two steps. The first is a unitary evolution  $U$ , leading from the state before measurement to a “provisional description” of the state after measurement:

$$|\psi, t_2\rangle_{avp} = |\varphi, t_2\rangle_{av} |0\rangle_p \xrightarrow{U} \quad (4)$$

$$|\psi, t_3\rangle_{avp} = \frac{1}{\sqrt{N}} \sum_i (|x_i\rangle_a + |x_i + r\rangle_a) |f_i\rangle_v |f_i\rangle_p, \quad (5)$$

where  $f_i = f(x_i) = f(x_i + r)$ . Here  $p$  denotes a third register of  $n$  qubits used to represent the state of the “classical pointer” in Hilbert space. This is sharp in state (4), before measurement interaction. In the state after measurement (5),  $f_i$  runs over all the values of  $f(x)$ . As stated before, the elapsed time  $t_3 - t_2$  is linear in  $n$  (the number of qubits in register  $v$ ). As well known, description (5) represents the appropriate entanglement between measured observable and classical pointer, but it must be reconciled with the empirical evidence that the pointer is in a sharp state.

The second step of von Neumann’s model amounts to be a *reinterpretation* of description (5). The tensor products appearing in (5) become mutually exclusive measurement outcomes (still at the same time  $t_3$ ) of probability distribution the square modules of the respective probability amplitudes, as well known<sup>4</sup>. This yields a measurement outcome of

---

<sup>4</sup>It is the same in decoherence theory, where the elements of a mixture become mutually exclusive

the form:

$$|\varphi, t_3\rangle_{av} |\bar{f}\rangle_p = \frac{1}{\sqrt{2}} (|\bar{x}\rangle_a + |\bar{x} + r\rangle_a) |\bar{f}\rangle_v |\bar{f}\rangle_p.$$

We can disregard the factor  $|\bar{f}\rangle_p$ , and focus on the *quantum* part of the measurement outcome,  $|\varphi, t_3\rangle_{av}$ , resulting from the reinterpretational step. We should note that this reinterpretation, as it is, does not involve the notion of time and is transparent to dynamics. Interestingly, the speed-up stems out of the reinterpretation, i.e. by the constraint that there is only one measurement outcome.

In fact, we will show that  $|\varphi, t_3\rangle_{av}$  is the solution of a system of algebraic equations equivalent to (3). These equations represent the following usual conditions introduced by quantum measurement: (i) the outcome of measuring  $[v]$  must be a single eigenstate  $|f\rangle_v$ , anyone element of the set of all eigenstates  $\{|f\rangle_v\}$ ; (ii) this eigenstate must “drag” all the tensor products appearing in  $|\varphi, t_2\rangle_{av}$  that contain it; (iii) it must be a specific eigenstate  $|\bar{f}\rangle$ , selected according to probability amplitudes.

Let  $|\varphi\rangle_{av} = \sum_{x,y} \alpha_{x,y} |x\rangle_a |y\rangle_v$  be an “unknown” vector of  $\mathcal{H}_{av}$ ;  $(x, y)$  runs over  $B^n \times B^n$ , and  $\alpha_{x,y}$  are complex *variables* independent of each other up to normalization:  $\sum_{x,y} |\alpha_{x,y}|^2 = 1$ . The above conditions originate a system of three algebraic equations to be simultaneously satisfied by  $|\varphi\rangle_{av}$ :

$$P_v^f |\varphi\rangle_{av} = |\varphi\rangle_{av}, \quad (6)$$

where  $P_v^f = |f\rangle_v \langle f|_v$  is the projector on the Hilbert subspace  $\mathcal{H}_{av}^f = \text{span} \{|x\rangle_a, |f\rangle_v\}$  with  $x$  running over  $B^n$  and  $|f\rangle_v \in \{|f\rangle_v\}$  being fixed; a  $|\varphi\rangle_{av}$  satisfying eq. (6) is a free linear combination of all the tensor products of  $\mathcal{H}_{av}$  containing  $|f\rangle_v$ ; this is condition (i);

$$|\langle \varphi |_{av} |\varphi, t_2\rangle_{av}| \text{ must be maximum}; \quad (7)$$

$|\varphi\rangle_{av}$ , satisfying (6) and (7) becomes the projection of  $|\varphi, t_2\rangle_{av}$  on  $\mathcal{H}_{av}^f$  :  $|\varphi\rangle_{av} =$

---

measurement outcomes.

$\sqrt{\frac{N}{2}} |f\rangle_v \langle f|_v |\varphi, t_2\rangle_{av}$ ; this means that  $|f\rangle_v$  has “dragged” all the tensor products of  $|\varphi, t_2\rangle_{av}$  containing it; this is condition (ii);

$$|f\rangle = |\bar{f}\rangle \quad (8)$$

with  $|\bar{f}\rangle$  randomly selected as stated before.

The solution of equations (6-8) is  $|\varphi\rangle_{av} = \sqrt{\frac{N}{2}} |\bar{f}\rangle_v \langle \bar{f}|_v |\varphi, t_2\rangle_{av} = |\varphi, t_3\rangle_{av}$ , indeed the quantum state after measurement.

To sum up, satisfying equations (6-8) is equivalent to performing the reinterpretational step of von Neumann’s model. This is transparent to measurement dynamics, namely to the first step of the model. Thus, performing the first step gives “for free” (without incurring any further dynamical cost) the solution of (6-8)<sup>5</sup>. This is equivalent to solving equations (3), namely the classically hard part of the problem. This justifies the quantum speed-up.

The capability of directly solving a system of algebraic equations, without having to execute an algorithm, comes from a peculiar feature. The determination of the measurement outcome (i.e. of the solution) is *dually influenced* by both the initial actions, required to prepare the state before measurement, and the logical-mathematical constraints introduced by the final measurement action. These constraints are in fact *independent* of the initial actions since they hold unaltered for *all* initial actions.

In Simon’s algorithm, dual influence is what distills a proper pair of values of  $x$  among an exponential number of such values, thus yielding the speed-up. Conversely, the speed-up is the observable consequence of dual influence.

Dual influence can be seen as a special instance of time-symmetrized quantum measurement<sup>6</sup>. Whether this notion is purely interpretational or can have observable consequences

---

<sup>5</sup>In any way, the process of satisfying equations (6-8) must be comprised in the time interval  $[t_2, t_3]$ , which is linear in  $n$ . Ref. [3] provides a reformulation of von Neumann’s model that better fits the current approach.

<sup>6</sup>The notion of time-symmetrized quantum measurement has been developed by Aharonov et al.,



is a controversial issue – as well known. Unexpectedly, we have found a certainly observable consequence (the speed-up) in the context of quantum computation. It is worth noting that this consequence becomes observable *after* the action of quantum measurement and dual influence.

Summarizing, quantum computation turns out to belong to an entirely new paradigm where there is identity between implicit or algebraic definition of a solution and its physical determination.

It is worth noting that this paradigm blurs a long-standing distinction (of mathematical logic) between the notions of “implicit definition” and “computation”.

An implicit definition does not prescribe how to construct its object (say, a string in some formal language). It only says that, demonstratedly, there exists such an object. For example, the numerical problems we are dealing with, implicitly or algebraically define their solutions<sup>7</sup>. Let us consider factorization: given the known product  $c$  of two unknown prime numbers  $x$  and  $y$ , the numerical algebraic equation  $x \cdot y = c$  implicitly defines the values of  $x$  and  $y$  that satisfy it. Equations (3) constitute a similar example.

In order to find the object of an implicit definition, the latter must be changed into an equivalent constructive definition, namely into an algorithm (if possible, but it is always possible with the problems we are dealing with). An algorithm is an abstraction of the way things can be constructed in reality – inevitably in a model thereof – and prescribes a computation process that builds the object of the definition.

The current notion of algorithm still reflects the way things can be constructed in the traditional classical reality – namely through a sequential process. Turing machine computation and the Boolean network representation of computation are examples of sequential

---

still outside the context of entanglement and problem solving. See, e.g., refs. [7], [8].

<sup>7</sup>If the problem admits no solution, we should consider the meta-problem whether the problem admits a solution.

computation. An algorithm specifies a one-way propagation of logical implication from a completely defined input to a completely defined output which contains the solution. It is thus meant to be executable through a dynamical process, namely through a one-way causality propagation<sup>8</sup>.

We can see that the essence of quantum computation, dual influence, is extraneous to the sequential notions of both algorithm and dynamics. In particular, quantum computation *is not* “quantum Turing machine” computation.

#### IV. FOUR TYPES OF QUANTUM ALGORITHMS

##### A. Modified Simon’s algorithm

In order to make our interpretation of the quantum speed-up more visible, we will follow the simplified version [4] of Simon’s algorithm [5]. With respect to the original version, we must confine ourselves to the case that the oracle gives us a 2-to-1 function  $f : B^n \rightarrow B^n$  such that

$$\forall x \neq x' : f(x) = f(x') \iff x = x' \oplus r,$$

where  $\oplus$  denotes bitwise exclusive or. The problem is to find  $r$  in poly(n) time. With a further simplification, as anticipated in Section II, we replace the above condition with the condition  $|x - x'| = r$ .

For the sake of clarity, the following table gives a trivial example.

$x$	0	1	2	3
$f(x)$	0	1	0	1

Table I

---

<sup>8</sup>Classical analog computation is not considered here to be fundamentally different, being still performed through a one-way causality propagation.

The modified algorithm is given in Fig. 2 – we should disregard  $/F$  for the time being.

Fig. 2

Registers  $a$  and  $v$  undergo successive unitary transformations, either jointly or separately:

- The  $f(x)$  transform (a reversible Boolean gate in the time-diagram of computation – Fig. 3) leaves the content of register  $a$  unaltered, so that an input  $x$  is repeated in the corresponding output, and computes  $f(x)$  adding it to the former content of register  $v$  (which was set to zero). If the state is not sharp but is a quantum superposition, the same transformation applies to any tensor product appearing in it.

Fig. 3

- $H$  is the Hadamard transform. On a single qubit  $i$ , it operates as follows:  $|0\rangle_i \xrightarrow{H} \frac{1}{\sqrt{2}} (|0\rangle_i + |1\rangle_i)$ ,  $|1\rangle_i \xrightarrow{H} \frac{1}{\sqrt{2}} (|0\rangle_i - |1\rangle_i)$ . In the general case of a register of  $n$  qubits, containing the number  $\bar{x}$ , it yields  $|\bar{x}\rangle_a \xrightarrow{H} \frac{1}{\sqrt{N}} \sum_x (-1)^{\bar{x} \cdot x} |x\rangle_a$ , where  $N = 2^n$ ,  $x$  ranges over  $0, 1, \dots, N - 1$ , and  $\bar{x} \cdot x$  denotes the module 2 inner product of the two numbers in binary notation (they should be seen as row matrices).
- $M$  represents the action of measuring the numerical content of a register.

The algorithm proceeds through the following steps (also applied to table I example):

a) prepare:

$$|\varphi, t_0\rangle_{av} = |0\rangle_a |0\rangle_v;$$

perform the Hadamard transform on register  $a$ , this yields:

$$|\varphi, t_1\rangle_{av} = \frac{1}{\sqrt{N}} \sum_x |x\rangle_a |0\rangle_v = \frac{1}{2} (|0\rangle_a |0\rangle_v + |1\rangle_a |0\rangle_v + |2\rangle_a |0\rangle_v + |3\rangle_a |0\rangle_v);$$

c) compute  $f(x)$  and add the result to the former content (0) of register  $v$ , which yields:

$$|\varphi, t_2\rangle_{av} = \frac{1}{\sqrt{N}} \sum_x |x\rangle_a |f(x)\rangle_v = \frac{1}{2} (|0\rangle_a |0\rangle_v + |1\rangle_a |1\rangle_v + |2\rangle_a |0\rangle_v + |3\rangle_a |1\rangle_v);$$

this is the state before measurement;

d) measure  $[v]$  obtaining, say,  $\bar{f} = 1$ ; the state after measurement is thus:

$$|\varphi, t_3\rangle_{av} = \frac{1}{\sqrt{2}} (|\bar{x}\rangle_a + |\bar{x} + r\rangle_a) |\bar{f}\rangle_v = \frac{1}{\sqrt{2}} (|1\rangle_a + |3\rangle_a) |1\rangle_v,$$

We should note that, at this stage of the algorithm, it is *equivalent* to either perform or skip  $[v]$  measurement (see further below). It will be easier to understand the algorithm and the reason of the speed-up if we assume that this measurement has been performed. The measurement outcome,  $|\varphi, t_3\rangle_{av} = \sqrt{\frac{N}{2}} |\bar{f}\rangle_v \langle \bar{f} |_v |\varphi, t_2\rangle_{av}$ , is naturally dually influenced (Section III).

Ekert and Jozsa [1] have shown that quantum entanglement between qubits is essential for providing a computational speed up, in terms of time *or* resources, in the class of quantum algorithms we are dealing with (which yield an exponential speed up). After measuring  $f(x)$ , the state of the two registers becomes factorizable, and all entanglement is destroyed. The remaining actions, performed on register  $a$ , use interference (which generates no entanglement) to “extract”  $r$  out of the superposition  $\frac{1}{\sqrt{2}} (|\bar{x}\rangle_a + |\bar{x} + r\rangle_a)$ . Under the criterion introduced in Section II, we must conclude from another standpoint that the speed-up has been achieved by preparing  $|\varphi, t_3\rangle_{av}$ .

e) perform  $H$  on register  $a$ , this yields:

$$|\varphi, t_4\rangle_{av} = \frac{1}{\sqrt{2^N}} \sum_z (-1)^{\bar{x}\cdot z} [1 + (-1)^{r\cdot z}] |z\rangle_a |\bar{f}\rangle_v;$$

f) measure  $[a]$  in  $|\varphi, t_4\rangle_{av}$ ; we designate the result by  $z$ ;

$r \cdot z$  must be 0 – see the form of  $|\varphi, t_4\rangle_{av}$ . This holds unaltered if step (d) measurement is omitted, as well known;

g) by repeating the overall computation process a sufficient number of times,  $\text{poly}(n)$  on average, a number of constraints  $r \cdot z = 0$  sufficient to identify  $r$  is gathered.

How the speed-up is achieved in  $[t_0, t_3]$  has been anticipated in Sections II and III. Summarizing, measuring  $[v]$  in state  $|\varphi, t_2\rangle_{av}$ , creates the system of algebraic equations (6-8) [equivalent to (3)] and yields the superposition of a pair of values of  $x_1$  and  $x_2$  which

satisfy this system ( $r$  is “easily” extracted from the superposition). Solving equations (3) by classical computation would require  $\exp(n)$  time.

Finally, let us show that performing or skipping step (d) (i.e.  $[v]$  measurement in  $|\varphi, t_2\rangle_{av}$ ) is *equivalent*. Let us skip step (d) and measure  $[a]$  first, at time  $t_4$ . In Fig. 2,  $M$  on  $v$  should be shifted at least after  $t_5$ . Whether  $[v]$  is measured after  $t_5$  is indifferent, or mathematically equivalent. Let us think of measuring it. This induces a “wave function collapse”<sup>9</sup> of the state of register  $v$  on some  $|\bar{f}\rangle_v$ . Since  $|\bar{f}\rangle_v$  is disentangled from the state of register  $a$ , and no operation has been performed on register  $v$  since time  $t_2$  (see fig. 2, keeping in mind that  $M$  on  $v$  has been shifted after  $t_5$ ), back-dating collapse at time  $t_2$  means back-dating the result of collapse, namely  $|\bar{f}\rangle_v$ , as it is. This is equivalent to having performed step (d). Another way of seeing this is that, because of the entanglement between registers  $a$  and  $v$ , measuring  $[a]$  first, at time  $t_4$ , is equivalent to simultaneously measuring  $[v]$ ; the result of this virtual measurement can be backdated, and we can go on with a reasoning similar to the above one.

## B. Shor’s algorithm

The problem of factoring an integer  $L$  – the product of two unknown primes – is transformed into the problem of finding the period of the function  $f(x) = a^x \bmod L$ , where  $a$  is an integer between 0 and  $L - 1$ , and is coprime with  $L$  [6], [9]. Figure 2 can also represent Shor’s algorithm, provided that  $f(x)$  is defined as above and that the second Hadamard transform is substituted by the discrete Fourier transform  $F$ . The state before measurement has the

---

<sup>9</sup>The notion of “collapse” is not needed in any essential way; it is a mathematically legitimate notion that comes handy here for the sake of explanation; the result of collapse can be backdated any time during the unobserved evolution of the quantum system from  $t_0$  to  $t_3$ , provided that this result undergoes back in time (in an inverted way) the same transformations undergone by the time-forward evolution (the usual one).

form  $|\varphi, t_2\rangle_{av} = \frac{1}{\sqrt{L}} \sum_x |x\rangle_a |f(x)\rangle_v$ . Measuring or not measuring  $f(x)$  in  $|\varphi, t_2\rangle_{av}$  is still equivalent. By measuring it, the above quantum state changes into the superposition

$$\bar{k}(|\bar{x}\rangle_a + |\bar{x} + r\rangle_a + |\bar{x} + 2r\rangle_a + \dots) |\bar{f}\rangle_v, \quad (9)$$

where  $f(\bar{x}) = f(\bar{x} + r) = \dots = \bar{f}$ , and  $\bar{k}$  is a normalization factor.

The second part of the algorithm generates no entanglement and serves to “extract”  $r$  in polynomial time, by using Fourier-transform interference and auxiliary, off line, mathematical considerations. Under the current assumptions, the quantum speed-up has been achieved by preparing state (9): the discussion is completely similar to that of the previous algorithm.

### C. Deutsch’s 1985 algorithm

The seminal 1985 Deutsch’s algorithm has been the first demonstration of a quantum speed-up. In its current form, this algorithm yields a deterministic output, apparently ruling out the dual influence explanation. A thorough examination of both the problem and the solution algorithm will show that this is not the case.

Until now, the problem has been to efficiently reverse a hard-to-reverse function  $f(x)$ . In the language of game theory, this is a game against (mathematical) nature. Deutsch’s algorithm and more in general quantum oracle computing is better seen as a competition between two players. One produces the problem, the other should produce the solution. Sticking to Greek tradition, we shall call the former player Sphinx, the latter Oedipus.

The game is formalized as follows. Both players know everything of a set of software programs  $\{f_k\}$  (where  $k$  labels the elements of the set), whereas each program  $f_k$  computes some function  $f_k : B^n \rightarrow B^n$ . The Sphinx chooses  $k$  at random, loads program  $f_k$  on a computer (i.e., sets the oracle in its  $k$ -th mode) and passes it on to Oedipus. Oedipus knows nothing of the Sphinx’ choice and must efficiently find  $k$  by testing the computer (oracle) input-output behaviour. If the computer is quantum, then we speak of “quantum oracle computing”.

Deutsch's 1985 algorithm [10], as modified in [4], is as follows. Let  $\{f_k\}$  be the set of all possible functions  $f_k : B \rightarrow B$ , namely:

$x$	$f_{00}(x)$	$x$	$f_{01}(x)$	$x$	$f_{10}(x)$	$x$	$f_{11}(x)$
0	0	0	0	0	1	0	1
1	0	1	1	1	0	1	1

$\{f_k\}$  is divided into a couple of subsets: the balanced functions, characterized by an even number of zero and one values, thus labeled by  $k = 01, 10$ , and the unbalanced ones, labeled by  $k = 00, 11$ . Once set in its  $k$ -th mode, the oracle computes  $f_k(x)$ . Oedipus must find, with a minimum number of oracle runs, whether the oracle (whose mode has been randomly set by the Sphinx) computes a balanced or an unbalanced function. In other words, he must compute the functional  $\mathcal{F}(f_k)$  which is, say, 1 (0) when the function is balanced (unbalanced). The algorithm is illustrated in Fig. 4(a). The computation of  $f_k(x)$  is represented as a reversible Boolean gate like in the previous algorithms, but for the fact that the result of the computation is now module 2 added to the former content of register  $v$ .

Fig. 4(a),(b)

Given the Sphinx' choice  $k$ , the algorithm proceeds as follows; each point gives the action and the corresponding result.

a) prepare:

$$|\varphi_k, t_0\rangle_{av} = \frac{1}{\sqrt{2}} |0\rangle_a (|0\rangle_v - |1\rangle_v),$$

b) perform Hadamard on  $a$ :

$$|\varphi_k, t_1\rangle_{av} = \frac{1}{2} (|0\rangle_a + |1\rangle_a) (|0\rangle_v - |1\rangle_v),$$

c) we shall consolidate the next two steps – Fig. 4(a): compute  $f_k(x)$  adding it, module 2, to the former content of  $v$ , and perform Hadamard on  $a$ ; the result depends on the Sphinx’ choice:

$$|\varphi_{00}, t_3\rangle_{av} = \frac{1}{\sqrt{2}} |0\rangle_a (|0\rangle_v - |1\rangle_v)$$

$$|\varphi_{01}, t_3\rangle_{av} = \frac{1}{\sqrt{2}} |1\rangle_a (|0\rangle_v - |1\rangle_v)$$

$$|\varphi_{10}, t_3\rangle_{av} = -\frac{1}{\sqrt{2}} |1\rangle_a (|0\rangle_v - |1\rangle_v)$$

$$|\varphi_{11}, t_3\rangle_{av} = -\frac{1}{\sqrt{2}} |0\rangle_a (|0\rangle_v - |1\rangle_v)$$

d) measure  $[a]$ : it can be seen that the content of register  $a$  yields the functional  $\mathcal{F}(f_k)$ , namely Oedipus’ answer.

This algorithm is more efficient than any classical algorithm, where two runs of the oracle are required to compute  $\mathcal{F}(f_k)$ . However, the result is apparently reached in a deterministic way, without any active role of quantum measurement.

This must be ascribed to an incomplete physical representation of the problem. In Section III, we had a problem that implicitly defined its solution, whereas this mathematical fact was physically represented by the quantum measurement of an entangled state. This obviously requires that the problem is physically represented<sup>10</sup>, whereas presently an essential part of it, the Sphinx choosing the oracle mode, is not.

First, we shall follow a most simple way of completing the physical representation. The Sphinx’ random selection of the oracle mode will be performed through a suitable quantum measurement, after having run the algorithm.

We introduce the extended gate  $F(k, x)$  which computes the function  $F(k, x) = f_k(x)$  for all  $k$  and  $x$ . This gate has an ancillary input register  $m$  ( $m$  for mode) which contains  $k$ , namely the oracle mode [Figure 4(b) gives the extended algorithm]. This input is identically

---

<sup>10</sup>In Sections IV.A and IV.B, all knowledge of the function and ignorance about  $r$  were physically represented in a superposition of the form (1).



repeated in a corresponding output – to keep gate reversibility. Of course, Oedipus is forbidden to access register  $m$ . The preparation becomes

$$|\varphi, t_0\rangle_{mav} = \frac{1}{\sqrt{2}} |00\rangle_m |0\rangle_a (|0\rangle_v - |1\rangle_v).$$

After performing Hadamard on  $m$  and  $a$  we obtain:

$$|\varphi, t_1\rangle_{mav} = \frac{1}{4} (|00\rangle_m + |01\rangle_m + |10\rangle_m + |11\rangle_m) (|0\rangle_a + |1\rangle_a) (|0\rangle_v - |1\rangle_v). \quad (10)$$

Performing Hadamard on  $|00\rangle_m$  is a way of preparing the Sphinx’ random selection of an oracle mode (as will become clear). Let us go directly to the state before the first measurement – see Fig. 4(b)

$$|\varphi, t_3\rangle_{mav} = \frac{1}{2\sqrt{2}} [(|00\rangle_m - |11\rangle_m) |0\rangle_a + (|01\rangle_m - |10\rangle_m) |1\rangle_a] (|0\rangle_v - |1\rangle_v). \quad (11)$$

It can be seen that the entangled state (11) represents the *mutual definition* between the Sphinx’ choice  $k$  and Oedipus’ answer  $\mathcal{F}(f_k)$ . The former implicit definition of the problem solution appears here in the form of the mutual definition of the moves of the two players. Reaching state (11) with quantum parallel computation still requires one oracle run.

The action of measuring  $[m]$  in state (11), equivalent to the Sphinx’ choice of the oracle mode, by bringing in and satisfying equations (6-8)<sup>11</sup>, transforms mutual definition into correlation between individual outputs (like in an EPR situation). In other words, the Sphinx’ choice of  $k$  simultaneously determines Oedipus’ answer  $\mathcal{F}(f_k)$  – retrievable by measuring  $[a]$ . In the classical framework instead, the Sphinx’ choice should necessarily be propagated to Oedipus’ answer by means of an algorithm, in fact through the computation of  $\mathcal{F}(f_k)$  (requiring two oracle runs).

Achieving the speed-up still involves the interplay between the reversible preparation of an entangled state before measurement and a final measurement action, namely dual influence – here of an EPR kind.

---

<sup>11</sup>The “state before measurement”  $|\varphi, t_2\rangle_{av}$  of Section III must be changed into  $|\varphi, t_3\rangle_{mav}$ .

It should be noted that the above “complete physical representation” is not the original Deutsch’s algorithm. This can readily be fixed. To this end, the Sphinx must randomly select the mode before giving the oracle – i.e. the quantum gate  $F(k, x)$  – to Oedipus. This means that Oedipus receives the oracle in an input state randomly selected among four possible quantum states, corresponding to the modes  $k = 00, 01, 10, 11$ . This is indistinguishable from a mixture. Therefore, the preparation at time  $t_1$  becomes:

$$|\varphi, t_1\rangle_{mav} = \frac{1}{4} \left( |00\rangle_m + e^{i\delta_1} |01\rangle_m + e^{i\delta_2} |10\rangle_m + e^{i\delta_3} |11\rangle_m \right) (|0\rangle_a + |1\rangle_a) (|0\rangle_v - |1\rangle_v),$$

where  $\delta_1, \delta_2$  and  $\delta_3$  are independent random phases – this is the random phase representation of a mixture [14]. After  $t_1$ , the algorithm goes on as before yielding

$$|\varphi, t_3\rangle_{mav} = \frac{1}{2\sqrt{2}} \left[ (|00\rangle_m - e^{i\delta_3} |11\rangle_m) |0\rangle_a + (e^{i\delta_1} |01\rangle_m - e^{i\delta_2} |10\rangle_m) |1\rangle_a \right] (|0\rangle_v - |1\rangle_v).$$

Clearly, the roles of entanglement, quantum measurement and dual influence remain unaltered.

#### D. An instance of Grover’s algorithm

The rules of the game are the same as before. This time we have the set of the  $2^n$  functions  $f_k : B^n \rightarrow B$  such that  $f_k(x) = \delta_{k,x}$ , where  $\delta$  is the Kronecker symbol. We shall consider the simplest instance  $n = 2$ . This yields four functions  $f_k(x)$ , labeled by  $k = 0, 1, 2, 3$ . Figure 5(a) gives Grover’s algorithm [11] (in the standard version provided in [4] for  $n = 2$ ). Let us assume the Sphinx has chosen  $k = 2$ . The preparation is  $\frac{1}{\sqrt{2}} |0\rangle_a (|0\rangle_v - |1\rangle_v)$ . Without entering into detail, the state before measurement is:  $\frac{1}{\sqrt{2}} |2\rangle_a (|0\rangle_v - |1\rangle_v)$ . Measuring  $[a]$  deterministically yields Oedipus’ answer. This is more efficient than classical computation where three oracle runs are required to find the solution with certainty, whereas in Grover’s algorithm two runs are enough – Fig. 5(a).

Fig. 5(a),(b)

The extended algorithm is given in Fig. 5(b). The preparation becomes

$$\frac{1}{\sqrt{2}} |0\rangle_m |0\rangle_a (|0\rangle_v - |1\rangle_v);$$

the state before measurement becomes:

$$\frac{1}{2\sqrt{2}} (|0\rangle_m |0\rangle_a + |1\rangle_m |1\rangle_a + |2\rangle_m |2\rangle_a + |3\rangle_m |3\rangle_a) (|0\rangle_v - |1\rangle_v).$$

Again, we have the mutual definition of the Sphinx' choice and Oedipus' answer. Measuring  $[m]$  selects the Sphinx' choice and Oedipus' answer at the same time, as in the previous oracle problem.

## V. CONCLUSIONS

Quantum computation is concerned with the efficient solution of numerical algebraic problems. We shall first summarize the main results of this work.

We have shown that the action of measuring an observable in a suitably entangled state, introduces and satisfies a system of algebraic equations. In all existing quantum algorithms, this system represents the problem that algebraically defines its solution. Moreover, measurement time is independent of entanglement. This justifies the quantum speed-up in all types of quantum algorithms found so far. Quantum computation turns out to be an entirely new paradigm (extraneous to the notion of sequential computation) where there is identity between the algebraic definition of a solution and its physical determination.

The capability of directly solving<sup>12</sup> a system of algebraic equations, is related to the feature that the determination of the measurement outcome is dually influenced by both the reversible initial actions, leading to the state before measurement, and by the logical-mathematical constraints introduced by the final measurement action. Dual influence is extraneous to the notion of sequential process, namely of dynamical, one-way propagation.

Although our explanation of the speed-up appears a-posteriori to be simple and evident, it is likely to displace rather common views. In the first place, it is reasonable to assume that

---

<sup>12</sup>Without having to execute an algorithm, which would be necessary in the classical framework.

quantum algorithms are commonly thought to be, in fact, algorithms, namely the quantum transposition of sequential Turing machine. At the light of the results of this work, this way of thinking would be a classical vestige, ruling out the active role of quantum measurement and dual influence.

In the second place, there is a widespread belief that quantum theory can do without the measurement problem. In other words, the fact that the mutual exclusivity of the possible measurement outcomes comes from an ad-hoc reinterpretation of a state superposition (of a mixture, in decoherence theory) would be a price paid once for all. There would be no further consequences on quantum theory. In contrast with this, we have highlighted a striking consequence in the context of quantum computation. Here the “reinterpretation” implies dual influence, which yields a completely observable speed-up.

These appear to be important clarifications provided by this work.

From the one hand, the notion of dual influence, with its striking consequence, might lend itself to further development at a fundamental level.

From the other hand, having ascertained that quantum algorithms are more than sequential computation, might open the way to unforeseen prospects in the quest of new forms of computation. For example, quantum measurement of an observable in an entangled state is a *projection* on a Hilbert subspace subject to certain constraints whose satisfaction amounts to efficiently solving a problem. In some respect, this feature is similar to the projections due to particle statistics symmetrizations. Therefore, investigating the possibility of exploiting such symmetrizations in problem solving could be an interesting prospect. Refs. [12], [13] provide still abstract attempts in this direction.

More generally, this work highlights the essential role played by non-dynamical effects in quantum computation. Let us mention in passing that a form of quantum computation which is of geometric rather than dynamical origin has recently been provided [15]. This concretely shows that there are ways of getting out of the usual quantum computation paradigm.

Thanks are due to T. Beth, A. Ekert, D. Finkelstein and V. Vedral for stimulating discussions and valuable comments.

## REFERENCES

- [1] A. Ekert, R. Jozsa, quant-ph/9803072, to appear in *Phil. trans. Roy. Soc. (Lond.)* 1998, *Proc. of Roy. Soc. Discussion Meeting*, Nov. 97.
- [2] A.Yu. Kitaev, quant-ph/9707021.
- [3] G. Castagnoli, quant-ph/9912020, “A Quantum Logic Gate Representation of Quantum Measurement”, submitted to *Int. J. Theor. Phys.*
- [4] R. Cleve, A. Ekert, C. Macchiavello, M. Mosca, quant-ph/9708016, submitted to *Proc. Roy. Soc. Lond. A*.
- [5] D.R. Simon, *Proc. of the 35<sup>th</sup> Annual Symposium on the Foundation of Computer Science*, Santa Fe, IVM (1994).
- [6] P. Shor, *Proc. of the 35<sup>th</sup> Annual Symposium on the Foundation of Computer Science*, Los Alamitos, CA, 124 (1994).
- [7] A. Aharonov, P. Bergmann, J. Lebowitz, *Phys. Rev. B* **134**, 1410 (1964).
- [8] L. Vaidman, quant-ph/9807075, to appear in PSA 98.
- [9] R. Cleve, A. Ekert, L. Henderson, C. Macchiavello, M. Mosca, quant-ph/9903061, *Complexity* **4**, 33 (1998).
- [10] D. Deutsch, *Proc. of the Royal Society of London A*, **400**, 97 (1985).
- [11] L. Grover, *Proc. of 28th Annual ACM Symposium on Theory of Computing*, 212 (1996).
- [12] G. Castagnoli, *Physica D* **120**, 48 (1998).
- [13] G. Castagnoli, D. Monti, quant-ph/9811039, to be published in *Int. J. Theor. Phys.*
- [14] D. Finkelstein, “Quantum Relativity”, *Springer-Verlag Berlin Heidelberg* (1996).
- [15] J.A. Jones, V. Vedral, A. Ekert and G. Castagnoli, quant-ph/9910052, to appear in *Nature*.

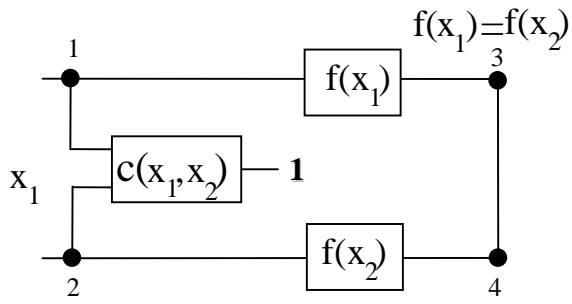

Fig. 1

$x_2$

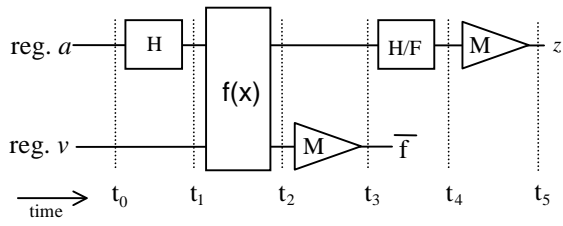

Fig. 2

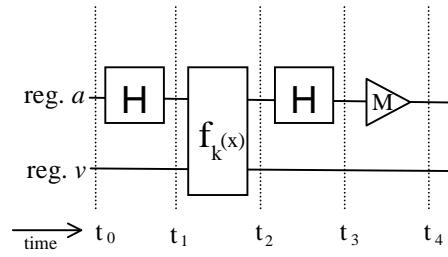

Fig. 4(a)

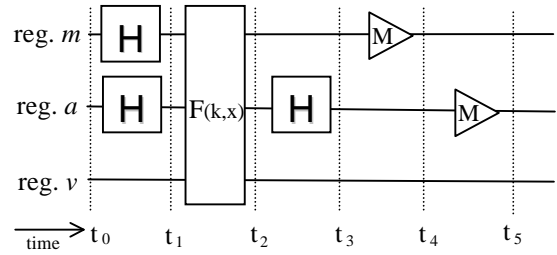

Fig. 4(b)

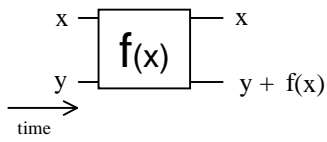

Fig. 3

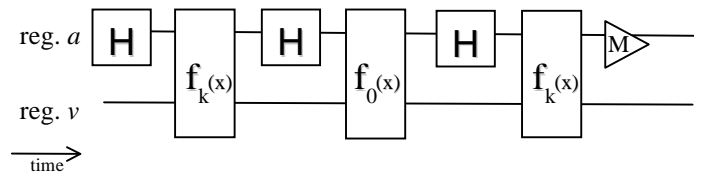

Fig. 5(a)

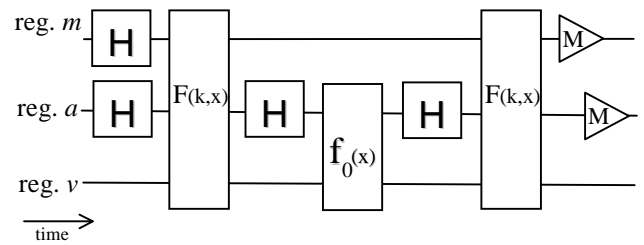

Fig. 5(b)