

# An Introduction to Quantum Complexity Theory

Richard Cleve  
University of Calgary\*

## Abstract

We give a basic overview of computational complexity, query complexity, and communication complexity, with quantum information incorporated into each of these scenarios. The aim is to provide simple but clear definitions, and to highlight the interplay between the three scenarios and currently-known quantum algorithms.

*Complexity theory* is concerned with the inherent cost required to solve information processing problems, where the cost is measured in terms of various well-defined resources. In this context, a *problem* can usually be thought of as a function whose input is a *problem instance* and whose corresponding output is the *solution* to it. Sometimes the solution is not unique, in which case the problem can be thought of as a relation, rather than a function. *Resources* are usually measured in terms of: some designated elementary operations, memory usage, or communication. We consider three specific complexity scenarios, which illustrate different advantages of working with quantum information:

1. **Computational complexity**
2. **Query complexity**
3. **Communication complexity.**

Despite the differences between these models, there are some intimate relationships among them. The usefulness of many currently-known quantum algorithms is ultimately best expressed in the computational complexity model; however, virtually all of these algorithms evolved from algorithms in the query complexity model. The query complexity model is a natural setting for discovering interesting quantum algorithms, which frequently have interesting counterparts in the computational complexity model. Quantum algorithms in the query complexity model can also be transformed into protocols in the

---

\*Department of Computer Science, University of Calgary, Calgary, Alberta, Canada T2N 1N4. Email: [cleve@cpsc.ucalgary.ca](mailto:cleve@cpsc.ucalgary.ca).

communication complexity model that use quantum information (and sometimes these are more efficient than any classical protocol can be). Also, this latter relationship, taken in its contrapositive form, can be used to prove that some problems are inherently difficult in the query complexity model.

## 1 Computational complexity

In the *computational complexity* scenario, an *input* is encoded as a binary string (say) and supplied to an algorithm, which must compute an *output* string corresponding to the input. For example, in the case of the factoring problem, for input 100011 (representing 35 in binary), the valid outputs might be 000101 or 000111 (representing the factors of 35). The algorithm must produce the required output by a series of *local* operations. By this, we do not necessarily mean “local in space”, but, rather, that each operation involves a small portion of the data. In other words, a local operation is a transformation that is confined to a small number of bits or qubits (such as two or three). The above property is satisfied by Turing machines and circuits, and also by quantum Turing machines [7, 21] and quantum circuits [22, 52] (see also [39]). We shall find it most convenient to work with circuit models here.

### 1.1 Classical circuits

For classical circuits, the basic operations can be taken as the binary  $\wedge$  (AND) gate, the binary  $\vee$  (OR) gate, and the unary  $\neg$  (NOT) gate. In Fig. 1 is a boolean circuit consisting of five gates that computes the parity of two bits. The inputs are denoted as  $x_0$  and  $x_1$ , and the “data-flow” is from left to right.

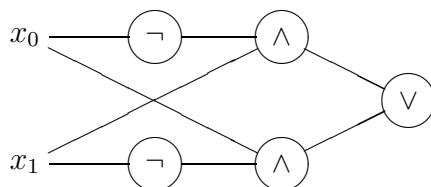

Figure 1: A classical circuit for computing the parity of two bits.

The rightmost gate is designated as the output, whose value is  $x_0 \oplus x_1$ , as required. This is the smallest circuit consisting of  $\wedge$ ,  $\vee$ , and  $\neg$  gates that computes the parity. Based on this fact, we could say that the computational complexity of the binary parity function is five. But note that this value is highly dependent on the specific set of basic operations that we started with. If we included the binary  $\oplus$  (EXCLUSIVE-OR) gate as a basic operation then a single gate suffices to compute the parity of two bits (Fig. 2).

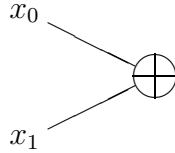

Figure 2: An alternative circuit for parity with one exclusive-or gate.

This illustrates a feature of the computational complexity model: the *exact* number of operations required to compute functions is quite sensitive to the technical choice of which basic operations to allow. The exact computational complexity of simple problems involving a small number of bits is somewhat arbitrary.

Computational complexity is more meaningful when larger problems that scale up are considered, such as the problem of computing the parity of  $n$  bits,  $x_0, x_1, \dots, x_{n-1}$ . Using  $\oplus$  gates, one can construct a tree with  $n - 1$  such gates that computes this parity. On the other hand, if only  $\wedge$ ,  $\vee$ , and  $\neg$  gates are available then it appears that something like  $5(n - 1)$  gates are needed. In both cases, the number of gates is  $O(n)$ , and it is also straightforward to prove that a constant times  $n$  gates are *necessary* for both cases. A similar property holds for *any* computational complexity problem: changing from one set of gates to any other set of gates (assuming that both sets are local and universal) can only affect computational complexity by a multiplicative constant. Thus, for any  $f : \{0, 1\}^* \rightarrow \{0, 1\}$ , its computational complexity is a well-defined function (of  $n$ , the length of the input to  $f$ ) up to a multiplicative constant.

This is one reason why it is common to denote the computational complexity of functions using asymptotic notation that suppresses multiplicative constants.  $O(T(n))$  means bounded above by  $cT(n)$  for some constant  $c > 0$  (for sufficiently large  $n$ ). Also,  $\Omega(T(n))$  means bounded below by  $cT(n)$  for some constant  $c > 0$ , and  $\Theta(T(n))$  means both  $O(T(n))$  and  $\Omega(T(n))$ . A circuit is *polynomially-bounded* in size if its size is  $O(n^d)$  for some constant  $d$ .

A matter that we have so far obscured concerns the treatment of the parameter  $n$  (denoting the input size). Although each circuit is for some *fixed* value of  $n$ , we are also speaking of  $n$  as a freely varying parameter. For problems where  $n$  is a variable (such as the problem of computing the parity of  $n$  bits), an algorithm in the circuit model must actually be a *circuit family*  $(C_1, C_2, C_3, \dots)$ , where circuit  $C_n$  is responsible for all input instances of size  $n$ . To be meaningful, a circuit family has to be *uniform* in that it can somehow be finitely specified. For example, for the aforementioned parity problem, a finite specification of a circuit family can be informally: “for input size  $n$ ,  $C_n$  is a binary tree of  $\oplus$ -gates with  $x_0, \dots, x_{n-1}$  at the leaves”. Formally, a

*specification* of a circuit family is an algorithm that maps each  $n$  to an explicit description of  $C_n$ . Technically, we ought to include the efficiency of the specification algorithm as part of the computational cost of a circuit family. This raises the question of what formalism one uses to describe the specification algorithm. Note that if we try to use another circuit family for this then *it* requires its own specification algorithm (and so on!), so this approach will not work. There are sophisticated ways of dealing with uniformity; a very simple way is to just use some non-circuit model, such as a Turing machine (running in time, say, polynomial in  $n$ ) for the circuit specification algorithm. At this point, the reader may wonder why one does not just use the Turing machine model to begin with. A big advantage of circuits is that their structural elements are simple and easy to work with—and this appears to hold for quantum circuits as well. Uniformity tends to be a straightforward technicality, that can be worked out after a circuit family is discovered; the discovery of the circuit family is usually the interesting part of the algorithm design process.

Let us now consider the problem of **primality testing**, where the input is a number  $x$  represented as an  $n$ -bit binary string, and the output is (say) 1 if  $x$  is prime and 0 if  $x$  is composite. Notice that, in the cases where  $x$  is composite, there is no requirement here that a factor of  $x$  be produced. It turns out that the smallest currently-known uniform circuit family for this problem has size  $O(n^{d \log \log n})$  (for some constant  $d$ ), which is shy of being polynomially-bounded [2].

There exist *probabilistic* circuit families that solve primality testing more efficiently. A *probabilistic circuit* is one that can flip coins during its execution, and the evolution of the computation can depend on the outcomes. Formally, a  $\phi$  (COIN-FLIP) gate, has no input and is understood to emit one uniformly-distributed random bit when executed during a computation. If  $m$  random bits are required then  $m$   $\phi$ -gates can be inserted into a circuit. Solovay and Strassen [49] discovered a remarkable probabilistic algorithm for primality testing that can be expressed in terms of probabilistic circuits. For any  $\varepsilon > 0$ , there is a probabilistic circuit of size  $O(n^3 \log(1/\varepsilon))$  that errs with probability at most  $\varepsilon$ . That is, given any  $x \in \{0, 1\}^n$  as input, the circuit correctly decides the primality of  $x$  with probability at least  $1 - \varepsilon$ . Note that the error probability is with respect to the  $\phi$ -gates, and not with respect to any assumed probability distribution on the input  $x$ . The circuit family is highly uniform, and there are versions of the algorithm that are quite efficient in practice, even when  $\varepsilon$  is very small (such as one billionth).

As an aside, we note that probabilistic circuit families can be translated into standard (deterministic) circuit families if one is willing to forfeit uniformity. For each  $n$ , by setting  $\varepsilon = 1/(2^n + 1)$ , we obtain a probabilistic circuit  $C_n$  of size  $O(n^4)$  for primality testing that errs with probability less than  $1/2^n$  for any input. Now consider the circuit  $C'_n$  that results if, for each  $\phi$ -gate in  $C_n$ , a

uniformly distributed random bit is independently generated and substituted for that gate. This is a probabilistic construction that yields a deterministic circuit  $C'_n$ . For  $x \in \{0,1\}^n$ , let  $p_x$  be the probability that the resulting  $C'_n$  errs on input  $x$ . Then, for each  $x$ ,  $p_x < 1/2^n$ , so the probability that  $C'_n$  errs for *any*  $x \in \{0,1\}^n$  is strictly less than  $\sum_{x \in \{0,1\}^n} 1/2^n = 1$ . Therefore, with probability greater than 0,  $C'_n$  is correct for all of its  $2^n$  possible input values. It follows that, for any  $n$ , a deterministic circuit of size  $O(n^4)$  must exist for primality testing. The problem is that there is no known efficient way to explicitly construct the coin flips which yield a correct circuit. Thus, the implied  $O(n^4)$ -size circuit family for primality testing is merely established by an existence proof; this is an example of a *non-uniform* circuit family. The fact that uniform probabilistic circuit families can be converted into non-uniform deterministic circuit families is theoretically noteworthy, but not practical.

A problem that is related to—but different from—primality testing is the **factoring problem**, where the input is an  $n$ -bit number  $x$ , and the output is a list of the prime factors of  $x$ . This is apparently much harder than primality testing, since the smallest currently-known circuit family for this problem is probabilistic and has size  $O(2^{d\sqrt{n \log n}})$  (where  $d$  is a constant) [36, 41], which is far from being polynomially-bounded. One of the reasons why quantum algorithms are of interest is that there exists a *quantum* circuit family of polynomial-size that solves the factoring problem (this will be discussed later).

A problem that is closely related to the factoring problem is the **order-finding problem**, where the input is a pair of natural numbers  $a$  and  $N$  that are coprime (i.e. such that  $\gcd(a, N) = 1$ ), and the goal is to find the smallest positive  $r$  such that  $a^r \bmod N = 1$  (there always exists such an  $r \in \{1, \dots, N-1\}$ ). It turns out that a polynomial-size circuit family for the order-finding problem can be converted into a polynomial-size probabilistic circuit family for the factoring problem (and vice versa). In fact, the quantum circuit for factoring is actually obtained via this relationship from a quantum circuit that solves the order-finding problem.

Although we have represented circuits pictorially as data-flow diagrams, it is useful to be able to encode circuits as binary strings. There are several reasonable encoding schemes. One such scheme encodes the graphical structure of a circuit  $C$  as an  $m \times m$  adjacency matrix (where  $m$  is the number of gates plus the number of inputs in  $C$ ), and then follows this by more bits that specify the labels of the nodes (e.g.  $\wedge, \vee, \neg, x_0, \dots, x_{n-1}$ ). Note that, using this encoding scheme, a circuit of size  $m$  has an encoding of  $O(m^2)$  bits. There are more efficient encoding schemes, where the encodings are of length  $O(m \log m)$ , and, for any “reasonable” encoding scheme, the length of the string that encodes  $C$  is polynomially-related to the size of  $C$ . Let  $e(C)$  denote a binary string that encodes the circuit  $C$  (relative to some reasonable

encoding scheme).

A fundamental problem in classical computational complexity is the **circuit satisfiability problem**, which is defined as follows. Call a circuit *satisfiable* if there exists an input string to the circuit for which the corresponding output value of the circuit is 1. For example, the circuit in Fig. 1 is satisfiable. The input to the circuit satisfiability problem is a binary string  $x = e(C)$  that encodes some boolean circuit  $C$ , and the output is 1 if  $C$  is satisfiable, and 0 otherwise. The best currently-known (deterministic or probabilistic) algorithm for circuit satisfiability is to simply try all possible inputs to  $C$ . When  $e(C)$  encodes a circuit  $C$  with  $n$  inputs and  $m$  gates, this procedure takes  $O(2^n m^d)$  steps, where  $d$  is a constant that depends on the encoding scheme used ( $d = 2$  suffices for most reasonable encoding schemes). In interesting cases,  $m$  is typically polynomial in  $n$ , so the dominant factor in this quantity is  $2^n$ . It is not known whether or not there is a polynomially-bounded circuit family for circuit satisfiability. In fact, circuit satisfiability is one of the so-called *NP*-complete problems [19, 26], for which a polynomially-bounded circuit family would yield polynomially-bounded circuits for *all* problems in *NP*.

## 1.2 Quantum circuits

To develop a theory of computational complexity for quantum information, it is natural to extend the notion of a circuit to a composition gates which perform *quantum* operations on *quantum bits* (called *qubits*). The most general quantum operations subsume all classical operations, which are frequently not reversible. It turns out that the quantum operations that seem to be the most useful in the context of quantum computation are those that are unitary (and hence reversible), as well as the von Neumann measurements.

Let us begin by recalling that the state of a system of  $m$  qubits can be described by associating an *amplitude*  $\alpha_x$  with each  $x \in \{0, 1\}^m$  (we restrict our attention to *pure* quantum states). Each amplitude is a complex number and there is a condition that  $\sum_{x \in \{0, 1\}^m} |\alpha_x|^2 = 1$ . Taken together, these amplitudes constitute a point in a  $2^m$ -dimensional vector space. The *computational basis* associated with this vector space is  $\{|x\rangle : x \in \{0, 1\}^m\}$ , and we follow the convention of writing states as linear combinations of these basis elements:

$$\sum_{x \in \{0, 1\}^m} \alpha_x |x\rangle. \tag{1}$$

Given a quantum state, it is impossible to access the values of the amplitudes directly. What one can do is perform a (von Neumann) measurement on each qubit. If such an operation is performed then the result is a random  $m$ -bit string  $y$ , distributed as  $\Pr[y = x] = |\alpha_x|^2$ , for each  $x \in \{0, 1\}^m$ . After this

measurement, the original quantum state is destroyed. One can also perform a unitary operation on an  $m$ -qubit system, which is a linear transformation  $U$  for which  $UU^\dagger = I$ , where  $U^\dagger$  is the conjugate transpose of  $U$ . Such a unitary transformation can be represented by a  $2^m \times 2^m$  matrix and will, in general, affect all of the  $m$  qubits.

For the purposes of quantum computation, we restrict the basic operations to local unitary transformations that only involve a small number (say, one or two) of the qubits. A one-qubit unitary operation can be described by  $2 \times 2$  unitary matrix  $U$ . In the case where  $m = 1$ , this  $U$  transforms the state  $\alpha|0\rangle + \beta|1\rangle$  to the state  $\alpha'|0\rangle + \beta'|1\rangle$ , where

$$\begin{pmatrix} \alpha' \\ \beta' \end{pmatrix} = U \begin{pmatrix} \alpha \\ \beta \end{pmatrix}. \quad (2)$$

In order to define the semantics of applying a one-qubit gate in the context of an  $m$ -qubit system for  $m > 1$ , we introduce a tensor product operation. Suppose that an  $m$ -qubit system is in state  $\sum_{x \in \{0,1\}^m} \alpha_x |x\rangle$  and an  $n$ -qubit system is in state  $\sum_{y \in \{0,1\}^n} \beta_y |y\rangle$ . Then the state of the combined system (consisting of  $m + n$  qubits) is defined to be the *tensor product* of the states of the individual systems, which is

$$\left( \sum_{x \in \{0,1\}^m} \alpha_x |x\rangle \right) \left( \sum_{y \in \{0,1\}^n} \beta_y |y\rangle \right) = \sum_{\substack{x \in \{0,1\}^m \\ y \in \{0,1\}^n}} \alpha_x \beta_y |xy\rangle. \quad (3)$$

For example,  $(\frac{1}{\sqrt{2}}|0\rangle - \frac{1}{\sqrt{2}}|1\rangle)(\frac{1}{\sqrt{2}}|0\rangle - \frac{1}{\sqrt{2}}|1\rangle) = \frac{1}{2}|00\rangle - \frac{1}{2}|01\rangle - \frac{1}{2}|10\rangle + \frac{1}{2}|11\rangle$ . Now, applying a one-qubit  $U$  to the  $k^{\text{th}}$  qubit of an  $m$ -qubit system is defined to be the unitary operation that maps each basis state

$$|x_0 \cdots x_{m-1}\rangle = |x_0 \cdots x_{k-2}\rangle |x_{k-1}\rangle |x_k \cdots x_{m-1}\rangle$$

to the state

$$|x_0 \cdots x_{k-2}\rangle (U |x_{k-1}\rangle) |x_k \cdots x_{m-1}\rangle$$

(for each  $x \in \{0,1\}^m$ ). Note that, by linearity, this completely defines a unitary operation on an  $m$ -qubit system.

For example, the one-qubit *Hadamard* gate corresponds to the matrix

$$H = \frac{1}{\sqrt{2}} \begin{pmatrix} 1 & 1 \\ 1 & -1 \end{pmatrix}, \quad (4)$$

and, when it is applied to the second qubit of a two-qubit system, the resulting operation is

$$\frac{1}{\sqrt{2}} \begin{pmatrix} 1 & 1 & 0 & 0 \\ 1 & -1 & 0 & 0 \\ 0 & 0 & 1 & 1 \\ 0 & 0 & 1 & -1 \end{pmatrix} \quad (5)$$

(with respect to the ordering of basis states  $|00\rangle, |01\rangle, |10\rangle, |11\rangle$ ). A quantum circuit corresponding to such an operation is in Fig. 3, which denotes that the first (top) qubit is left unaltered and  $H$  is applied to the second qubit.

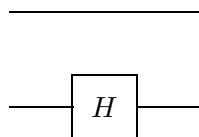

Figure 3: Quantum circuit applying a Hadamard gate to one of two qubits.

To construct nontrivial quantum circuits, it is necessary to include two-qubit unitary operations. A simple but quite useful two-qubit operation is the CONTROLLED-NOT gate (C-NOT, for short), which, for all  $x, y \in \{0, 1\}$ , transforms the basis state  $|x\rangle|y\rangle$  to the basis state  $|x\rangle|y \oplus x\rangle$  (and this extends to arbitrary quantum states by linearity). The notation for the C-NOT gate in quantum circuits is indicated in Fig. 4 (it is also known as the “reversible exclusive-or” gate).

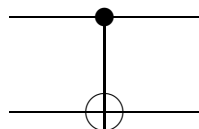

Figure 4: Notation for the CONTROLLED-NOT (C-NOT) gate.

Note that the C-NOT gate corresponds to the unitary transformation

$$\begin{pmatrix} 1 & 0 & 0 & 0 \\ 0 & 1 & 0 & 0 \\ 0 & 0 & 0 & 1 \\ 0 & 0 & 1 & 0 \end{pmatrix}. \quad (6)$$

The semantics of the C-NOT gate extends to the context of  $m$ -qubit systems with  $m > 2$  in a manner similar to that of the one-qubit gates.

For basis states  $|x\rangle|y\rangle$ , the effect of the C-NOT gate is essentially the same as the classical two-bit gate that maps  $(x, y)$  to  $(x, x \oplus y)$  (for all  $x, y \in \{0, 1\}$ ). This gate negates the second bit conditional on the first bit being 1. For arbitrary quantum states, the behavior of this gate is more subtle. For example, although the classical gate never changes the value of its first “control” bit, the quantum gate sometimes does: applying the C-NOT gate to



state  $(\frac{1}{\sqrt{2}}|0\rangle - \frac{1}{\sqrt{2}}|1\rangle)(\frac{1}{\sqrt{2}}|0\rangle - \frac{1}{\sqrt{2}}|1\rangle)$  yields the state  $(\frac{1}{\sqrt{2}}|0\rangle + \frac{1}{\sqrt{2}}|1\rangle)(\frac{1}{\sqrt{2}}|0\rangle - \frac{1}{\sqrt{2}}|1\rangle)$ .

A more general kind of two-qubit gate is the CONTROLLED- $U$  gate, where  $U$  is a  $2 \times 2$  unitary matrix. This gate maps  $|0\rangle|y\rangle$  to  $|0\rangle|y\rangle$  and  $|1\rangle|y\rangle$  to  $|1\rangle(U|y\rangle)$  (for all  $y \in \{0, 1\}$ ), and is denoted in Fig. 5.

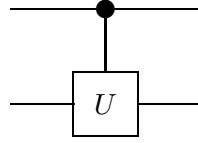

Figure 5: Notation for a CONTROLLED- $U$  gate.

Note that the C-NOT gate is a special case of a CONTROLLED- $U$  gate with

$$U = \begin{pmatrix} 0 & 1 \\ 1 & 0 \end{pmatrix} \quad (7)$$

(and this  $U$  itself is essentially a NOT gate).

Now, suppose that we want to compute the AND of two bits (i.e. take  $x_0$  and  $x_1$  as input and produce  $x_0 \wedge x_1$  as output) using only the one- and two-qubit gates of the above form. This can be done in a manner that avoids irreversible operations via the quantum circuit in Fig. 6, where  $H$  is the Hadamard gate (Eq. 4) and

$$V = \begin{pmatrix} 1 & 0 \\ 0 & i \end{pmatrix} \quad (8)$$

(where  $i = \sqrt{-1}$ ).

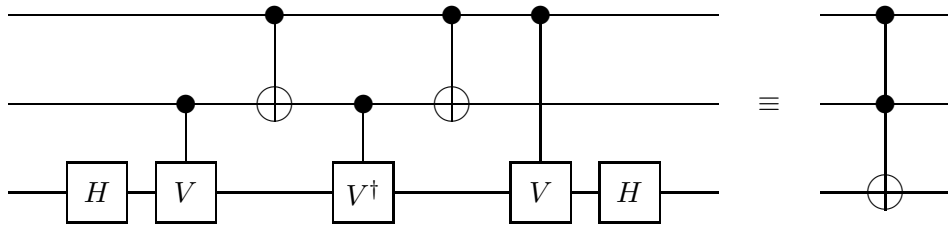

Figure 6: Quantum circuit simulating a  $C^2$ -NOT (Toffoli) gate.

For any  $x_0, x_1, y \in \{0, 1\}$ , setting the initial state of the qubits to  $|x_0\rangle|x_1\rangle|y\rangle$  and tracing through the execution of this circuit reveals that the final state

is  $|x_0\rangle|x_1\rangle|y \oplus (x_0 \wedge x_1)\rangle$ . Thus, when  $y$  is initialized to 0, the final state of the third qubit is  $|x_0 \wedge x_1\rangle$  (and the explicit classical data,  $x_0 \wedge x_1$ , can be extracted from this quantum state by a measurement). The three-qubit operation that is simulated in Fig. 6 is a so-called Toffoli gate (also called a CONTROLLED-CONTROLLED-NOT, or  $C^2$ -NOT for short). See [3, 23, 47] for some similar constructions.

For classical circuits, there are finite sets of gates which are universal in the sense that they can be used to simulate any other set of gates. For quantum circuits, the situation is different, since the set of all unitary operations is continuous, and hence uncountable—even when restricted to one-qubit gates. If one starts with any finite set of quantum gates then the set of all unitary operations that can be implemented is limited to some countable subset of all the unitary operations. In spite of this, there are meaningful ways to capture the important features associated with universal sets of gates.

First, it turns out that there are *infinite* sets consisting of one- and two-qubit gates that are universal in the exact sense. For example, if the C-NOT gate as well as all unitary one-qubit gates are available then any  $k$ -qubit unitary operation can be simulated with  $O(4^k k)$  such gates [3, 30]. Therefore, the overhead is constant when switching between different universal sets of local unitary gates (such as the set of all two-qubit gates and the set of all three-qubit gates).

Moreover, there are *finite* sets of one- and two-qubit gates that are universal in an *approximate* sense. The aforementioned one-qubit Hadamard gate  $H$  (Eq. 4) and the two-qubit CONTROLLED- $V$  gate (where  $V$  is defined in Eq. 8) are an example of such a set. The precise result is best stated as a theorem.

**Theorem 1 ([33, 48])** *Let  $B$  be any two-qubit gate and  $\varepsilon > 0$ . Then there exists a quantum circuit of size  $O(\log^d(1/\varepsilon))$  (where  $d$  is a constant) consisting of only  $H$  and CONTROLLED- $V$  gates which computes a unitary operation  $B'$  that approximates  $B$  in the following sense. There exists a unit complex number  $\lambda$  (i.e. with  $|\lambda| = 1$ ) such that  $\|B - \lambda B'\|_2 \leq \varepsilon$ .*

In the above theorem,  $\|\cdot\|_2$  is the norm induced by Euclidean distance and  $\lambda$  is a “global phase factor” (which can be disregarded). Consequently, if  $B'$  is substituted for  $B$  in some quantum circuit then the final state  $\sum_x \alpha'_x |x\rangle$  approximates the final state of the original circuit  $\sum_x \alpha_x |x\rangle$  in the sense that  $\sqrt{\sum_x |\lambda \alpha'_x - \alpha_x|^2} \leq \varepsilon$ . This implies that if the final state is measured then the probability of any event among the possible outcomes is affected by at most  $\varepsilon$ . The proof of Theorem 1 exploits the fact that the commutator of two unitary operators is not generally  $I$  (the identity operator), but it can converge very quickly to  $I$  (see [33, 48] for details).

An example of another finite set of gates that is universal in the approximate sense is:  $H$ ,  $W$ , and C-NOT, where

$$W = \begin{pmatrix} 1 & 0 \\ 0 & e^{i\pi/4} \end{pmatrix}. \quad (9)$$

In fact, with  $W$  and C-NOT gates, one can simulate a CONTROLLED- $V$  gate, as shown in Fig. 7 (see also [9]).

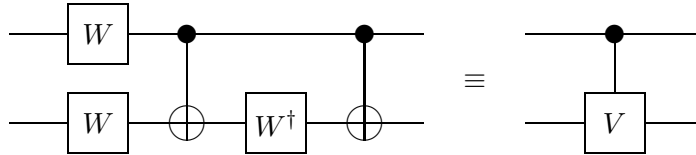

Figure 7: Simulation of a CONTROLLED- $V$  gate (note:  $W^\dagger = W^7$ ).

As in the classical case, the measure of computational complexity for quantum circuits is most interesting when large problems that scale up are considered. Using sets of gates that are universal in the exact sense, computational complexity can vary only by constant factors. On the other hand, using sets of gates that are universal in the approximate sense, computational complexity can vary by at most polylogarithmic factors: any circuit with  $m$  gates can be simulated within accuracy  $\varepsilon$  by a circuit in terms of a different set of basic operations with  $O(m \log^d(m/\varepsilon))$  gates. This is accomplished by simulating each of the  $m$  gates of the original circuit within accuracy  $\varepsilon/m$ , which results in a total accumulated error bounded by  $\varepsilon$ .

For example, consider the problem where the input is  $x_0, x_1, \dots, x_{n-1}$  and the goal is to compute the conjunction  $x_0 \wedge x_1 \wedge \dots \wedge x_{n-1}$ . In terms of  $H$ ,  $W$ , and C-NOT gates, the computational complexity can be shown to be  $\Theta(n)$ , and, with another set of approximately uniform gates, the complexity may be different, but it will remain between  $\Omega(n)$  and  $O(n \log^d(n/\varepsilon))$  (where  $d$  is some constant and  $\varepsilon$  is the accuracy level required).

Since it seems inconceivable that it would ever be possible to physically implement quantum gates with perfect accuracy, the need to ultimately work with approximations of quantum gates is inevitable. Fortunately, due the unitarity of quantum operations, inaccuracies only scale up linearly with the number of gates involved in a circuit. And, if one employs quantum error-correcting codes and fault-tolerant techniques then even gates with constant inaccuracies (and that are subject to “decoherence”) can in principle be employed in arbitrarily large quantum circuits [1, 31, 45] (see [42] for an extensive review).

For quantum circuit families, we must also consider the issue of uniformity: a legitimate quantum circuit family should be finitely specifiable in a compu-

tationally efficient way. This can be defined as a straightforward extension of the uniformity definitions for classical circuit families, where the specification algorithm is *classical* and a finite set of gates that is approximately universal (such as  $H$ ,  $W$ , and C-NOT) is used. All quantum algorithms proposed to date can be expressed as circuit families that are uniform in this sense (see [39] for further comments).

Notwithstanding the above issues, a convenient practice is to allow perfect universal sets of gates, bearing in mind that: (a) they can always be approximated using any finite set of gates that is approximately universal with only a polylogarithmic penalty in the circuit size (even if the implementations of these gates are approximate); and (b) uniformity tends to be a straightforward technicality (at least with the quantum algorithms discovered so far).

Perhaps the most remarkable quantum algorithm that has been discovered to date is the factoring algorithm, due to Peter Shor [44].

**Theorem 2 ([44])** *There exists a quantum circuit family of size  $O(n^2 \log^d(n/\varepsilon))$  that solves the factoring problem within accuracy  $\varepsilon$  (for some constant  $d$ ).*

Note that this circuit size is essentially exponentially smaller than the most efficient known classical probabilistic circuit for factoring (whose size is  $O(2^{\sqrt{n \log n}})$ ). The quantum factoring algorithm actually follows from an algorithm for the order-finding problem, which in turn evolved from an algorithm in the query complexity model (explained in the next section).

The above result shows that, based on our current state of knowledge, quantum algorithms may be exponentially more efficient than classical algorithms for some problems. The next result shows that the gain in computational efficiency cannot exceed one exponential.

**Theorem 3** *For any  $S(n)$ -qubit quantum circuit with  $T(n)$  gates there is a classical probabilistic circuit with  $O(2^{S(n)}T(n)^3 \log^2(1/\varepsilon))$  gates<sup>1</sup> that simulates it within accuracy  $\varepsilon$  in the following sense. After measuring the final state of the quantum circuit, the probability of any event among the outcomes differs from that of the classical circuit by at most  $\varepsilon$ .*

The idea behind the proof of Theorem 3 is to store the values of all  $2^{S(n)}$  amplitudes associated with an  $S(n)$ -qubit quantum system in classical bits (to an appropriate level of precision). Then, for each of the  $T(n)$  gates, these amplitudes are updated to reflect the effect of the gate. At the end, the absolute value of the square of each amplitude is computed and the resulting probability distribution is sampled by using  $\phi$ -gates. To obtain the upper bound in Theorem 3, it suffices to store each amplitude with  $T(n) + \log(1/\varepsilon)$  bits of precision, which

---

<sup>1</sup>The  $T(n)^3 \log^2(1/\varepsilon)$  factor can be replaced by a smaller but more complicated expression.

requires  $O(2^{S(n)}(T(n) + \log(1/\varepsilon)))$  bits in all. Since the effect of each quantum gate corresponds to multiplying the amplitude vector by a *sparse*  $2^{S(n)} \times 2^{S(n)}$  matrix, this entails  $O(2^{S(n)})$  arithmetic operations, which can be implemented by  $O(2^{S(n)}(T(n) + \log(1/\varepsilon))^2)$  bit operations. Thus, the total number of classical gates is  $O(2^{S(n)}T(n)(T(n) + \log(1/\varepsilon))^2) \subseteq O(2^{S(n)}T(n)^3 \log^2(1/\varepsilon))$ . Also, the measurement process can be simulated with  $O(2^{S(n)}T(n)^2 \log^2(1/\varepsilon))$  classical gates.

A more refined argument than the one above can be used to show that an  $S(n)$ -qubit circuit with  $T(n)$  gates can be simulated using *space* that is polynomial in  $S(n)$  and  $T(n)$  (but still with an exponential number of operations), and there are also more esoteric computational models that subsume the power of quantum circuit families [25].

Regarding the circuit satisfiability problem, it is currently unknown whether or not there exists a polynomially-bounded quantum circuit family that solves it. What is known is that quantum algorithms can solve this problem quadratically faster than the best currently-known classical algorithms for this problem.

**Theorem 4** *There exists a quantum circuit family of size  $O(\sqrt{2^n \log(1/\varepsilon)}m^d)$  that solves the circuit satisfiability problem within accuracy  $\varepsilon$  (for some constant  $d$ ). Here,  $n$  and  $m$  measure the size of the input instance:  $n$  is the number of inputs to circuit  $C$  and  $m$  is the number of gates of  $C$ .*

Note how this compares with the best currently-known classical circuit family for the circuit satisfiability problem, which has size  $O(2^n m^d)$ . Both quantities are exponential, but  $\sqrt{2^n}$  is nevertheless considerably smaller than  $2^n$  for large values of  $n$ . The quantum algorithm is a consequence of a remarkable algorithm in the query complexity model that was discovered by Lov Grover [27] (explained in the next section).

## 2 Query complexity

This is an abstract scenario which can be thought of as a game, like “twenty questions”. The goal is to determine some information by asking as few questions as possible. This differs from the computational complexity scenario in that the “input” is not presented as a binary string at the beginning of the computation. Rather, the input can be thought of as a “black box” computing a *function*  $f : S \rightarrow T$ , and the basic operations are *queries*, in which the algorithm specifies a  $t$  from the domain of the function and receives the value  $f(t)$  in response.

A natural example is that of “polynomial interpolation”, where  $f$  is an arbitrary polynomial of degree  $d$

$$f(t) = c_0 + c_1t + \cdots + c_d t^d \quad (10)$$

and the goal is to determine the coefficients  $c_0, c_1, \dots, c_d$ . It is well known that  $d + 1$  queries to  $f$  are necessary and sufficient to accomplish this.

In the classical case, an algorithm in this model can be represented by a circuit consisting of gates from some standard universal set (e.g.  $\wedge, \vee, \neg$ ) plus additional gates to perform queries. For  $f : S \rightarrow T$ , an  $f$ -query gate takes  $t \in S$  as input and produces  $f(t)$  as output. In this scenario, since there are no input bits related to the problem instance (the problem instance is embodied in  $f$ ), the inputs to the circuit are all set to constant values (such as 0).

In order to be able to adapt this model to settings involving quantum information, we slightly modify the form of the query gates so that they are reversible. For example, for  $f : \{0, 1\}^n \rightarrow \{0, 1\}$ , define a *reversible  $f$ -query* gate as the mapping  $\tilde{f} : \{0, 1\}^n \times \{0, 1\} \rightarrow \{0, 1\}^n \times \{0, 1\}$  such that  $\tilde{f}(x, y) = (x, y \oplus f(x))$  (for  $x \in \{0, 1\}^n$  and  $y \in \{0, 1\}$ ). Note that, for classical algorithms, reversible  $f$ -queries yield exactly the same information as the non-reversible kind. Any circuit that makes reversible  $f$ -queries can be converted into one that makes exactly the same number of non-reversible  $f$ -queries (and vice versa). Henceforth, all queries will be assumed to be in reversible form.

In the quantum case, an  $f$ -query is a unitary transformation that permutes the basis states according to the classical mapping determined by  $f$  (in reversible form). For example, for  $f : \{0, 1\}^n \rightarrow \{0, 1\}$ , an  $f$ -query gate is the unitary transformation that maps  $|x\rangle |y\rangle$  to  $|x\rangle |y \oplus f(x)\rangle$  (for all  $x \in \{0, 1\}^n$  and  $y \in \{0, 1\}$ ). One way of denoting  $f$ -queries in both classical and quantum circuits is shown in Fig. 8 (for the case where  $f : \{0, 1\}^2 \rightarrow \{0, 1\}$ ).

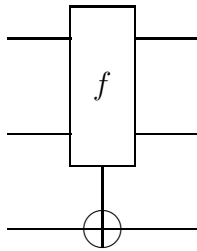

Figure 8: Notation for an  $f$ -query gate when  $f : \{0, 1\}^2 \rightarrow \{0, 1\}$ .

The first instance where a quantum algorithm was proven to outperform any classical algorithm was with **Deutsch’s problem** [21], where  $f : \{0, 1\} \rightarrow \{0, 1\}$  and  $f(t) = (c_0 + c_1t) \bmod 2$ , and the goal is to determine the value of

$c_1$  (note that  $c_1 = f(0) \oplus f(1)$ ). A classical circuit (in reversible form) that computes  $c_1$  with two  $f$ -queries is shown in Fig. 9.

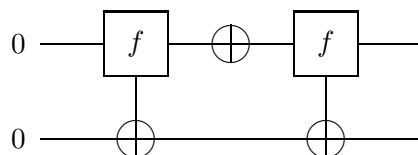

Figure 9: Classical circuit for Deutsch's problem using two queries.

The inputs to the circuit are both initialized to 0, and the unary  $\oplus$  operation between the two  $f$ -queries is a NOT gate. It is easy to see that the final values of the two bits are 1 and  $c_1$ . It can also be shown that no classical algorithm exists that computes  $c_1$  with a single  $f$ -query (since it is impossible to determine  $f(0) \oplus f(1)$  from just  $f(0)$  or  $f(1)$  alone).

But the quantum circuit in Fig. 10 [18, 21] computes  $c_1$  with a single  $f$ -query gate.

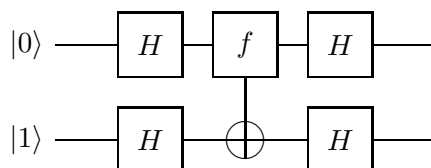

Figure 10: Quantum circuit for Deutsch's problem using one query.

Here the initial state of the two-qubit system is  $|0\rangle |1\rangle$  and its final state is  $(-1)^{c_0} |c_1\rangle |1\rangle$ , which yields  $c_1$  when the first qubit is measured.

Query complexity can be pinned down more precisely than computational complexity in that the “number of  $f$ -queries” is not sensitive to arbitrary technical conventions. So, it makes sense to consider the exact query complexity of a problem independent of linear factors, and to say that the classical query complexity of Deutsch's problem is two, whereas its quantum query complexity is one.

Although the above advantage is small, there are generalizations of Deutsch's problem for which the discrepancy between classical and quantum query complexity is much larger. One of these is **Simon's problem** [46], which is defined as follows. For a function  $f : \{0, 1\}^n \rightarrow \{0, 1\}^n$ , define  $s \in \{0, 1\}^n$  to be an *XOR-mask* of  $f$  if:  $f(x) = f(y)$  if and only if  $x \oplus y \in \{0^n, s\}$  (where  $\oplus$  is defined over  $\{0, 1\}^n \times \{0, 1\}^n$  bitwise). When  $s = 0^n$ ,  $f$  is a bijection, and when  $s \neq 0^n$ ,  $f$  is a two-to-one function with a special structure related to

$s$ . In Simon's problem,  $f : \{0, 1\}^n \rightarrow \{0, 1\}^n$  is promised to have an XOR-mask  $s \in \{0, 1\}^n$ , and the goal is to find  $s$  by making queries to  $f$ . In this case, an  $f$ -query is the mapping  $(x, y) \mapsto (x, y \oplus f(x))$  in the classical case and  $|x\rangle|y\rangle \mapsto |x\rangle|y \oplus f(x)\rangle$  in the quantum case ( $x, y \in \{0, 1\}^n$ ). Note that Deutsch's problem is the special case of Simon's problem where  $n = 1$  (the XOR-mask is  $\neg c_1$  in this case).

It can be proven that any classical algorithm in the query model for Simon's problem must make  $\Omega(\sqrt{2^n \log(1/\varepsilon)})$  queries to  $f$ , even for probabilistic circuits with query gates that are permitted to err with probability up to  $\varepsilon$ . On the other hand, there is a simple quantum circuit that solves this problem with only  $O(n \log(1/\varepsilon))$  queries to  $f$  (see [46] for the details). There is also a refinement to Simon's original algorithm that makes a polynomial number of queries and solves Simon's problem *exactly* [11].

Although the primary resource under consideration is the number of queries, the number of auxiliary operations (i.e. the non-query gates) is also of interest, and it is desirable to bound both quantities. For Simon's algorithm the total number of gates is  $O(n^2 \log(1/\varepsilon))$ .

Simon's problem demonstrates that, in the query complexity setting, there are quantum algorithms that are exponentially more efficient than any classical algorithm. Although the query complexity scenario is somewhat abstract, the significance of algorithms in this model will become clear when we examine the consequences of the **order-finding problem in the query scenario**, which is defined as follows. Let  $N$  be an  $n$ -bit integer and  $a \in \{1, \dots, N - 1\}$  be a number such that  $\gcd(a, N) = 1$ . In this version of the order-finding problem, the function  $f_{a,N} : \{0, 1\}^n \times \{0, 1\}^n \rightarrow \{0, 1\}^n \times \{0, 1\}^n$  is defined as

$$f_{a,N}(x, y) = (x, (a^x y) \bmod N). \quad (11)$$

This is invertible if  $y$  is restricted to  $\{0, \dots, N - 1\}$  (and can be extended to be invertible over its full domain by defining  $f_{a,N}(x, y) = (x, y)$  for the case where  $N \leq y < 2^n$ ). The goal is to find the minimum  $r \in \{1, \dots, N - 1\}$  such that  $a^r \bmod N = 1$  by making queries to  $f_{a,N}$  (in this case,  $f_{a,N}$  is already in reversible form). Although there is no polynomially-bounded classical circuit that solves this problem, Shor [44] discovered a quantum circuit that solves it with probability  $1 - \varepsilon$  using only  $O(\log(1/\varepsilon))$  queries to  $f_{a,N}$  and  $O(n^2 \log^d(n/\varepsilon))$  auxiliary gates (for some constant  $d$ ). Detailed explanations of the algorithm can be found in several sources, including [18, 32, 44].

A significant property of the function  $f_{a,N}$  is that there exists a classical circuit of size  $O(n^2 \log n \log \log n)$  that takes  $N$  (an  $n$ -bit number),  $a \in \{1, \dots, N - 1\}$  (such that  $\gcd(a, N) = 1$ ), and  $x, y \in \{0, 1\}^n$  as input, and produces  $f_{a,N}(x, y)$  as output. In other words, given  $a$  and  $N$ , one can efficiently *simulate* an  $f_{a,N}$ -query gate. Moreover, this simulation can be implemented in



terms of quantum gates, such as NOT, C-NOT, and C<sup>2</sup>-NOT (using techniques for reversible classical computation [5]). By doing this simulation for each  $f_{a,N}$ -query gate in the quantum circuit for the order-finding problem, one obtains a quantum circuit of size  $O(n^2 \log^d(n/\varepsilon))$  that takes  $a$  and  $N$  as input and produces the minimum positive  $r$  such that  $a^r \bmod N = 1$  as output with probability  $1 - \varepsilon$ . Thus, the algorithm in the query complexity model yields an algorithm in the computational complexity model for order-finding—and hence also for factoring. This is a specific instance of the following general result relating algorithms in the query complexity model to algorithms in the computational complexity model.

**Theorem 5** *Suppose that a function  $f_z : \{0, 1\}^m \rightarrow \{0, 1\}^k$  is associated with each  $z \in \{0, 1\}^n$  (where  $m$  and  $k$  are functions of  $z$ ), and that the classical computational complexity of the function that maps  $(z, x)$  to  $f_z(x)$  is bounded above by  $R(n)$ . Suppose also that there is a problem in the query complexity model where some property  $P(f_z)$  is to be determined in terms of  $f_z$ -queries, and that there is a quantum circuit that solves this problem using  $S(n)$  queries to  $f_z$  and  $T(n)$  auxiliary operations. Then the quantum computational complexity of the problem where the input is  $z \in \{0, 1\}^n$  and the output is the value of the property  $P(f_z)$  is  $O(R(n)S(n) + T(n))$ .*

The circuit for the computational complexity problem is merely the circuit for the query complexity problem with a circuit simulating each  $f_z$ -query gate substituted for that  $f_z$ -query gate.

A simple problem that seems natural in the query scenario is the **search problem** [27], where  $f : \{0, 1\}^n \rightarrow \{0, 1\}$ , and the goal is to find an  $x \in \{0, 1\}^n$  such that  $f(x) = 1$  (or to indicate that no such  $x$  exists). Any classical algorithm for this problem must make  $\Omega(2^n)$   $f$ -queries, even if it is allowed to err with probability (say)  $\frac{1}{3}$ . Lov Grover [27] discovered a remarkable quantum algorithm that accomplishes this with  $O(\sqrt{2^n})$  queries (some detailed explanations of the algorithm are found in [8, 27, 37]). Grover's result, with some later refinements [8, 10, 14, 37, 54] incorporated into it, is summarized as follows.

**Theorem 6 ([27])** *There is a quantum algorithm that solves the search problem for  $f : \{0, 1\}^n \rightarrow \{0, 1\}$  with  $O(\sqrt{2^n \log(1/\varepsilon)})$  queries to  $f$ , and errs with probability at most  $\varepsilon$ .*

The efficiency of the above algorithm has been shown to be optimal [6, 8, 14, 53].

Clearly, Grover's algorithm can also be used to solve the **existential search problem**, where the goal is just to determine whether or not there

exists an  $x \in \{0, 1\}^n$  such that  $f(x) = 1$  (a problem that also requires  $\Omega(2^n)$  queries in the classical case). Note the similarity between this existential search problem and the circuit satisfiability problem. In fact, using Theorem 5, this algorithm in the query model translates into the algorithm for the circuit satisfiability problem that is claimed in Theorem 4. The input is  $e(C)$ , an encoding of a circuit  $C$  with  $m$  gates and  $n$  inputs that computes a mapping  $C : \{0, 1\}^n \rightarrow \{0, 1\}$ , and the output should be 1 if there exists an  $x \in \{0, 1\}^n$  such that  $C(x) = 1$ , and 0 otherwise. The mapping that takes  $(e(C), x)$  to  $C(x)$  can be computed by a classical circuit with  $O(m^d)$  gates (where  $d$  is a constant that depends on the encoding scheme, and is usually small). Also, the algorithm in Theorem 6 makes  $O(\sqrt{2^n \log(1/\varepsilon)} n)$  auxiliary operations. Therefore, applying Theorem 5, one obtains a quantum circuit of size  $O(\sqrt{2^n \log(1/\varepsilon)} m^d)$  for the circuit satisfiability problem.

Let us now consider some variations and extensions of the existential search problem in the query model. We shall henceforth refer to the existential search problem as  $OR$ , defined as

$$OR(f) = (\exists x)f(x), \quad (12)$$

where  $f : \{0, 1\}^n \rightarrow \{0, 1\}$  is accessed through  $f$ -queries. The name  $OR$  seems natural since

$$OR(f) = f(00 \cdots 0) \vee f(00 \cdots 1) \vee \cdots \vee f(11 \cdots 1). \quad (13)$$

Note that the complementary problem  $AND(f) = (\forall x)f(x)$  has computational complexity somewhat similar to that of  $OR$ , since  $(\forall x)f(x) = \neg(\exists x)\neg f(x)$ .

Some non-trivial extensions of  $OR$  and  $AND$  are the **alternating quantifier problems**, such as  $OR$ - $AND$ , where there are two alternating quantifiers:

$$OR\text{-}AND(f) = (\exists x_1)(\forall x_2)f(x_1, x_2). \quad (14)$$

Here,  $f : \{0, 1\}^{n_1} \times \{0, 1\}^{n_2} \rightarrow \{0, 1\}$ , and  $n_1, n_2$  are implicit parameters satisfying  $n_1 + n_2 = n$ . By a suitable recursive application of Grover's algorithm for  $OR$ , this problem can be solved with  $O(\sqrt{2^n n \log(1/\varepsilon)})$  queries to  $f$  [13] (the extra factor of  $\sqrt{n}$  is to amplify the accuracy of the bottom level algorithm for  $AND$ ). In fact, one can extend the above to  $k$  alternations of quantifiers:

$$OR\text{-}AND\text{-}\cdots\text{-}Q(f) = (\exists x_1)(\forall x_2) \cdots (Qx_k)f(x_1, x_2, \dots, x_k), \quad (15)$$

where  $Q \in \{OR, AND\}$  and  $Q \in \{\exists, \forall\}$ , depending on whether  $k$  is even or odd, and  $f : \{0, 1\}^{n_1} \times \cdots \times \{0, 1\}^{n_k} \rightarrow \{0, 1\}$  with  $n_1 + \cdots + n_k = n$ . In this case, the recursive application of Grover's technique makes  $O(\sqrt{2^n n^{k-1} \log(1/\varepsilon)})$  queries to  $f$  (see [13]; also [40] for a related result).

For all of these variations of *OR* and *AND*, it can be shown that any classical algorithm for one of these problems must make  $\Omega(2^n)$  queries, and the quantum algorithms for these problems are all nearly quadratically more efficient than this in the sense that they make  $O((2^n)^{1/2+\delta})$  queries, for any  $\delta > 0$  and  $\varepsilon > 0$ . In fact, even if  $k$ , the number of alternations of *OR* and *AND*, is set to  $\delta n/2 \log n$  (instead of being held constant), the quantum algorithms make  $O((2^n)^{1/2+\delta})$  queries. All of these quantum algorithms also have counterparts for the corresponding problems in the computational model, where the function is specified by an encoding  $e(C)$  of a circuit  $C$ .

Another problem that has a similar flavor to these problems is the **parity problem (in the query scenario)**, defined as

$$PARITY(f) = \left( \sum_{x \in \{0,1\}^m} f(x) \right) \bmod 2. \quad (16)$$

It can be shown that any classical algorithm requires  $\Omega(2^n)$  queries to solve *PARITY*, and it is natural to ask whether quantum algorithms can be quadratically more efficient—or even  $O((2^n)^r)$ , for some  $r < 1$ . One of the applications of the communication complexity model (explained in the next section) is to show that this is not possible: at least  $\Omega(2^n/n)$  queries must be made by any quantum algorithm. In fact, a stronger lower bound of  $\frac{1}{2}2^n$  is also known [4, 24] (using different methods).

It is important to note that, although upper bounds in the query model translate into upper bounds in the computational model, the converse of this need not be true. For example, it is conceivable that there is a polynomially-bounded circuit that solves the **circuit parity problem**, where the input is  $e(C)$ , an encoding of a circuit  $C$  that computes a function  $f$ , and the output is *PARITY*( $f$ ). Note how this latter problem is different from another version of the parity problem in the computational scenario (discussed in Section 1.1), where the inputs are  $x_0, x_1, \dots, x_{n-1}$ , and the goal is to compute  $x_0 \oplus x_1 \oplus \dots \oplus x_{n-1}$ .

### 3 Communication complexity

In this model, there are two parties, traditionally referred to as Alice and Bob, who each receive an  $n$ -bit binary string as input ( $x = x_0x_1 \dots x_{n-1}$  for Alice and  $y = y_0y_1 \dots y_{n-1}$  for Bob) and the goal is for them to determine the value of some function of the of these  $2n$  bits. The resource under consideration here is the *communication* between the two parties, and an algorithm is a *protocol*, where the parties send information to each other (possibly in both directions and over several rounds) until one of them (say, Bob) obtains the answer. This

model was introduced by Yao [51] and has been widely studied in the classical context (see [35] for a survey).

An interesting example is the **equality problem**, where the function is  $EQ$ , defined as

$$EQ(x, y) = \begin{cases} 1 & \text{if } x = y \\ 0 & \text{if } x \neq y. \end{cases}$$

A simple  $n$ -bit protocol for  $EQ$  is for Alice to just send her bits  $x_0, \dots, x_{n-1}$  to Bob, after which Bob can evaluate the function by himself (in fact, there is a similar  $n$ -bit protocol for *any* function). The interesting question is whether or not the  $EQ$  function can be evaluated with fewer than  $n$  bits of communication—after all, the goal here is only for Bob to acquire one bit. The answer depends on whether or not any error probability is permitted.

If Bob must acquire the value of  $EQ(x, y)$  with certainty then it turns out that  $n$  bits of communication are necessary. Note that Alice sending the first  $n - 1$  bits of  $x$  will clearly *not* work, since the answer could critically depend on whether or not  $x_{n-1} = y_{n-1}$ . The number of possible protocols to consider is quite large and an actual *proof* that  $n$  bits communication are necessary is nontrivial. The interested reader is referred to [35] for a proof.

On the other hand, for probabilistic protocols (where Alice and Bob can flip coins and base their behavior on the outcomes), if an error probability of  $\varepsilon > 0$  is permitted then  $O(\log(n) \log(1/\varepsilon))$  bits of communication are sufficient. As usual, we are not assuming anything about a probability distribution on the input strings; the error probability is with respect to the random choices made by Alice and Bob, and it applies regardless of what  $x$  and  $y$  are.

We now describe an  $O(\log(n) \log(1/\varepsilon))$ -bit protocol for  $EQ$ . First of all, Alice and Bob agree on a finite field whose size is between  $2n$  and  $4n$  (such a field always exists, and its elements can be represented as  $O(\log(n))$ -bit strings). Now, consider the two polynomials

$$p_x(t) = x_0 + x_1 t + \dots + x_{n-1} t^{n-1} \tag{17}$$

$$p_y(t) = y_0 + y_1 t + \dots + y_{n-1} t^{n-1}. \tag{18}$$

For any value of  $t$  in the field, Alice can evaluate  $p_x(t)$  and Bob can evaluate  $p_y(t)$ . If  $x = y$  then the two polynomials are identical, so  $p_x(t) = p_y(t)$  for every value of  $t$ . But, if  $x \neq y$  then, since  $p_x(t)$  and  $p_y(t)$  are polynomials of degree  $n - 1$ , there can be at most  $n - 1$  distinct values of  $t$  for which  $p_x(t) = p_y(t)$ . Therefore, if a value of  $t$  is chosen randomly from the field then the probability that  $p_x(t) = p_y(t)$  is at most  $\frac{1}{2}$ . Now, the protocol proceeds as follows. Alice chooses  $k = \log(1/\varepsilon)$  independent random elements of the field,  $t_1, \dots, t_k$ , and then sends  $t_1, \dots, t_k$  and  $p_x(t_1), \dots, p_x(t_k)$  to Bob (this consists of  $O(\log(n) \log(1/\varepsilon))$  bits). Then Bob outputs 1 if and only if  $p_x(t_i) = p_y(t_i)$

for all  $i \in \{1, \dots, k\}$ . The probability that Bob erroneously outputs 1 when  $x \neq y$  is at most  $1/2^k = \varepsilon$ .

Two other interesting communication complexity problems are the **intersection problem**, where the function is  $IN$ , defined as

$$IN(x, y) = (x_0 \wedge y_0) \vee (x_1 \wedge y_1) \vee \dots \vee (x_{n-1} \wedge y_{n-1}) \quad (19)$$

and the **inner product problem**, where the function is  $IP$ , defined as

$$IP(x, y) = (x_0 \wedge y_0) \oplus (x_1 \wedge y_1) \oplus \dots \oplus (x_{n-1} \wedge y_{n-1}). \quad (20)$$

Intuitively, for  $IN$ , the inputs  $x$  and  $y$  can be thought as encodings of two subsets of  $\{0, \dots, n-1\}$  and the output is a bit indicating whether or not they intersect. Also,  $IP$  is the inner product of  $x$  and  $y$  as bit vectors in modulo two arithmetic. The deterministic communication complexity of each of these problems is the same as that of  $EQ$ : any deterministic protocol requires  $n$  bits of communication. Also, it has been shown that both of these problems are more difficult than  $EQ$  when probabilistic protocols are considered: any probabilistic protocol with error probability up to (say)  $\frac{1}{3}$  requires  $\Omega(n)$  bits of communication (see [15] for  $IP$ , and [29] for  $IN$ ; also [35]).

It is natural to ask whether any reduction in communication can be obtained by somehow using *quantum* information. Define a *quantum* communication protocol as one where Alice and Bob can exchange messages that consist of qubits. In a more formal definition of this model, there is an *a priori* system of  $m$  qubits, some of them in Alice's possession and some of them in Bob's possession. The initial state of all of these qubits can be assumed to be  $|0\rangle$ , and Alice and Bob can each perform unitary transformations on those qubits that are in their possession and they can also send qubits between themselves (thereby changing the ownership of qubits). The output is then taken as the outcome of some measurement of Bob's qubits. Various preliminary results about communication complexity with quantum information occurred in [12, 16, 20, 34, 52].

There are fundamental results in quantum information theory which imply that classical information cannot be "compressed" within quantum information [28]. For example, Alice cannot convey more than  $r$  classical bits of information to Bob by sending him an  $r$ -qubit message. Based on this, one might mistakenly think that there is no advantage to using quantum information in the communication complexity context. In fact, there exists a quantum communication protocol that solves  $IN$  whose qubit communication is approximately the square root of the bit communication of the best possible classical probabilistic protocol.

**Theorem 7 ([13])** *There exists a quantum protocol for the intersection problem (IN) that uses  $O(\sqrt{n \log(1/\varepsilon)} \log(n))$  qubits of communication and errs with probability at most  $\varepsilon$ .*

Moreover, the quantum protocol can be adapted to actually find a point in the intersection in the cases where  $IN(x, y) = 1$ . That is, to produce an  $i \in \{0, \dots, n-1\}$  such that  $x_i \wedge y_i = 1$ . This problem, like IN, has classical probabilistic communication complexity  $\Omega(n)$ .

To understand the protocol in Theorem 7, it is helpful to think of the inputs  $x$  and  $y$  as functions rather than strings, and we introduce some notation that makes this explicit. For convenience, assume that  $n = 2^k$  for some  $k$  (if not then  $x$  and  $y$  can be lengthened by padding them with zeroes), and define the functions  $f_x, f_y : \{0, 1\}^k \rightarrow \{0, 1\}$  as

$$f_x(i) = x_i \tag{21}$$

$$f_y(i) = y_i \tag{22}$$

where  $\{0, 1\}^k$  and  $\{0, 1, \dots, 2^k - 1\}$  are identified in the natural way. Alice and Bob's input data can be thought of as  $f_x$  and  $f_y$ , rather than  $x$  and  $y$  (respectively). In particular, given  $x$ , Alice can simulate an  $f_x$ -query that maps  $|i\rangle |j\rangle$  to  $|i\rangle |j \oplus f_x(i)\rangle$  (for all  $i \in \{0, 1\}^k$  and  $j \in \{0, 1\}$ ), and Bob can simulate  $f_y$ -queries. (Although the resource that is of interest in this model is not the number of basic operations that Alice and Bob perform, it is worth noting that, Alice and Bob's simulations of these queries can be explicitly implemented by reversible circuits with  $O(2^k k) = O(n \log(n))$  basic operations).

To construct an efficient quantum protocol for IN, define the function  $f_x \wedge f_y : \{0, 1\}^k \rightarrow \{0, 1\}$  as  $(f_x \wedge f_y)(i) = f_x(i) \wedge f_y(i)$  (for  $i \in \{0, 1\}^k$ ), and note that  $IN(x, y) = OR(f_x \wedge f_y)$ . Therefore, if Alice and Bob can somehow perform  $(f_x \wedge f_y)$ -queries then the value of  $IN(x, y)$  can be determined by making  $O(\sqrt{2^k \log(1/\varepsilon)}) = O(\sqrt{n \log(1/\varepsilon)})$  such queries. The problem is that neither Alice nor Bob individually have enough information to perform an  $(f_x \wedge f_y)$ -query (since this depends on both  $x$  and  $y$ ). If Alice were to begin by sending  $x$  to Bob then Bob could make  $(f_x \wedge f_y)$ -queries on his own, but note that this entails  $n$  bits of communication to begin with. Another, more efficient, approach is for Alice and Bob to collectively simulate  $(f_x \wedge f_y)$ -queries by combining  $f_x$ -queries (which Alice can perform) with  $f_y$ -queries (which Bob can perform), and a small amount of communication. To see how this is accomplished, consider the circuit in Fig. 11. First, ignoring the broken vertical lines, note that the quantum circuit (composed of two  $f_x$ -queries, two  $f_y$ -queries, and one Toffoli gate) is equivalent to an  $(f_x \wedge f_y)$ -query. That is, it implements the unitary transformation that maps the state  $|i\rangle |0\rangle |0\rangle |j\rangle$  to the state  $|i\rangle |0\rangle |0\rangle |j \oplus (f_x \wedge f_y)(i)\rangle$  (for all  $i \in \{0, 1\}^k$ ,  $j \in \{0, 1\}$ ). This circuit

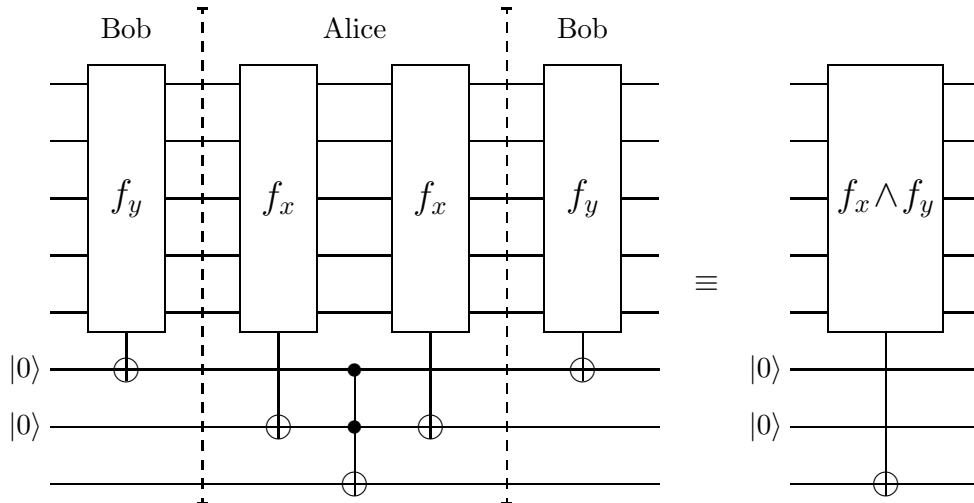

Figure 11: Simulation of an  $(f_x \wedge f_y)$ -query in terms of  $f_x$ -queries and  $f_y$ -queries.

uses two extra qubits that are each initialized in state  $|0\rangle$  and which incur no net change.

Now, the protocol for  $IN$  can be thought of as Bob executing the algorithm in the query model for  $OR$  with the function  $f_x \wedge f_y$ , except that, whenever an  $(f_x \wedge f_y)$ -query gate arises, he interacts with Alice to simulate the circuit in Fig. 11: first Bob performs an  $f_y$ -query gate, then he sends the  $k + 3$  qubits to Alice who performs some actions involving  $f_x$ -queries and a Toffoli gate (shown between the two broken lines) and sends the qubits back to Bob, who performs another  $f_y$ -query. Note that the total amount of communication that this entails is  $2(k + 3) \in O(\log n)$  qubits. Therefore, the total communication for Bob's simulation of the  $O(\sqrt{n \log(1/\varepsilon)})$  queries to  $(f_x \wedge f_y)$  is  $O(\sqrt{n \log(1/\varepsilon)} \log(n))$ , as claimed in Theorem 7.

More recently, Ran Raz has given an example of a communication complexity problem which a quantum protocol can solve with *exponentially* less communication than the best classical probabilistic protocol. The description of the problem is more complicated than  $EQ$ ,  $IN$ , and  $IP$ , and the reader is referred to [43] for the details.

The methodology used to establish Theorem 7 involved the conversion of an algorithm in the query model (for  $OR$ ) to a communication protocol (for  $IN(x, y) = OR(f_x \wedge f_y)$ ). This conversion can be stated in a more general form.

**Theorem 8 ([13])** *Suppose that there is a quantum algorithm in the query model that computes  $P(f)$  in terms of  $T(k, \varepsilon)$  queries to  $f$ , where  $f : \{0, 1\}^k \rightarrow$*

$\{0, 1\}$ , and  $\varepsilon$  is a bound on the error probability. For  $n = 2^k$ , define the communication problem  $P_\wedge : \{0, 1\}^n \times \{0, 1\}^n \rightarrow \{0, 1\}$  as  $P_\wedge(x, y) = P(f_x \wedge f_y)$ . Then there is a quantum protocol that solves  $P_\wedge$  with  $O(T(\log(n), \varepsilon) \log(n))$  qubits of communication. And a similar result holds for  $P_\vee(x, y) = P(f_x \vee f_y)$  and  $P_\oplus(x, y) = P(f_x \oplus f_y)$ .

We conclude with a discussion of the quantum communication complexity of the inner product function  $IP$ . It has been shown [34] (see also [17]) that even quantum protocols require communication  $\Omega(n)$  for this problem, even when the error probability is permitted to be as large as (say)  $\frac{1}{3}$ . This fact, combined with Theorem 8 applied in its contrapositive form, can be used to establish a lower bound for the parity problem in the query model (defined in Eq. 16). The main observation is that  $IP(x, y) = PARITY(f_x \wedge f_y)$ . Suppose that there is a quantum algorithm that computes  $PARITY(f)$  for  $f : \{0, 1\}^k \rightarrow \{0, 1\}$  by making  $T(k)$   $f$ -queries (assume that the error probability is bounded by  $\frac{1}{3}$ ). Then, by Theorem 8, there exists a quantum protocol that solves  $IP$  with  $O(T(k)k)$  qubits of communication, where  $n = 2^k$  is the size of the input instance to  $IP$ . Since there is a lower bound of  $\Omega(n) = \Omega(2^k)$  for the communication complexity of  $IP$ , we must have  $T(k)k \in \Omega(2^k)$ , which implies that  $T(k) \in \Omega(2^k/k)$ . This is an easy way to get a “ball park” lower bound for the query complexity of  $PARITY$ , whose exact value is known to be  $\frac{1}{2}2^k$  by other methods [4, 24].

## Acknowledgments

I would like to thank Michele Mosca for comments and help with the references. This research was partially supported by the Natural Sciences and Engineering Research Council of Canada.

## References

- [1] D. Aharonov and M. Ben-Or, “Fault-tolerant quantum computation with constant error”, *Proc. 29th Ann. ACM Symp. on Theory of Computing (STOC '97)*, pp. 176–188, 1997.
- [2] L. Adleman, C. Pomerance, R. Rumely, “On distinguishing prime numbers from composite numbers”, *Annals of Mathematics*, Vol. 117, pp. 173–206, 1983.
- [3] A. Barenco, C.H. Bennett, R. Cleve, D.P. DiVincenzo, N. Margolus, P. Shor, T. Sleator, J. Smolin, and H. Weinfurter, “Elementary gates for quantum computation”, *Phys. Rev. A*, Vol. 52, pp. 3457–3467, 1995.



- [4] R. Beals, H. Buhrman, R. Cleve, M. Mosca, R. de Wolf, “Quantum lower bounds by polynomials”, *Proc. 39th Ann. IEEE Symp. on Foundations of Computer Science (FOCS '98)*, pp. 352–361, 1998.
- [5] C.H. Bennett, “Logical reversibility of computation”, *IBM J. of Research and Development*, Vol. 17, pp. 525–532, 1973.
- [6] C.H. Bennett, E. Bernstein, G. Brassard, and U. Vazirani, “Strengths and weaknesses of quantum computing”, *SIAM J. on Computing*, Vol. 26, No. 5, pp. 1510–1523, 1997.
- [7] E. Bernstein and U.V. Vazirani, “Quantum complexity theory”, *SIAM J. on Comput.*, Vol. 26, No. 5, pp. 1411–1473, 1997.
- [8] M. Boyer, G. Brassard, P. Høyer, and A. Tapp, “Tight bounds on quantum searching”, *Fortschritte der Physik*, Vol. 46, pp. 493–505, 1998. (An earlier version appeared in *Physcomp '96*.)
- [9] P.O. Boykin, T. Mor, M. Pulver, V. Roychowdhury, and F. Vatan, “On universal and fault-tolerant quantum computing”, preprint quant-ph/9906054, 1999.
- [10] G. Brassard, P. Høyer, and A. Tapp, “Quantum counting”, *Proc. 25th ICALP*, Vol. 1443 of *Lecture Notes in Computer Science*, pp. 820–831 (Springer), 1998.
- [11] G. Brassard and P. Høyer, “An exact quantum polynomial-time algorithm for Simon’s problem”, *Proc. 5th Israeli Symp. on Theory of Computing and Systems (ISTCS '97)*, pp. 12–23, 1997.
- [12] H. Buhrman, R. Cleve, and W. van Dam, “Quantum entanglement and communication complexity”, preprint quant-ph/9705033, 1997.
- [13] H. Buhrman, R. Cleve, and A. Wigderson, “Quantum vs. classical communication and computation”, *Proc. 30th Ann. ACM Symp. on Theory of Computing (STOC '98)*, pp. 63–68, 1998.
- [14] H. Buhrman, R. de Wolf, “Lower bounds for quantum search and derandomization”, preprint quant-ph/9811046, 1998.
- [15] B. Chor and O. Goldreich, “Unbiased bits from sources of weak randomness and probabilistic communication complexity”, *SIAM J. Comput.*, Vol. 17, No. 2, pp. 230–261, 1988.
- [16] R. Cleve and H. Buhrman, “Substituting quantum entanglement for communication”, *Phys. Rev. A*, Vol. 56, No. 2, pp. 1201–1204, 1997.

- [17] R. Cleve, W. van Dam, M. Nielsen, and A. Tapp, “Quantum entanglement and the communication complexity of the inner product function”, to appear in *Proc. 1st NASA Intl. Conf. on Quantum Computing and Quantum Communications*, Vol. 1509 of *Lecture Notes in Computer Science* (Springer), 1998. preprint quant-ph/9708019, 1997.
- [18] R. Cleve, A. Ekert, C. Macchiavello, and M. Mosca, “Quantum algorithms revisited”, *Proc. of the Royal Society of London*, Vol. A454, pp. 339–354, 1998.
- [19] S.A. Cook, “The complexity of theorem proving procedures”, *Proc. 3rd Ann. ACM Symp. on Theory of Computing (STOC '71)*, pp. 151–158, 1971.
- [20] W. van Dam, P. Høyer, A. Tapp, “Multiparty quantum communication complexity”, preprint quant-ph/9710054, 1997.
- [21] D. Deutsch, “Quantum theory, the Church-Turing principle and the universal quantum computer”, *Proc. of the Royal Society of London*, Vol. A400, pp. 96–117, 1985.
- [22] D. Deutsch, “Quantum computational networks”, *Proc. of the Royal Society of London*, Vol. A425, pp. 73–90, 1989.
- [23] D.P. DiVincenzo, “Quantum gates and circuits”, *Proc. of the Royal Society of London*, Vol. A454, pp. 261–276, 1998.
- [24] E. Farhi, J. Goldstone, S. Gutmann, and M. Sipser, “A limit on the speed of quantum computation in determining parity.” *Phys. Rev. Lett.*, Vol. 81, pp. 5442–5444, 1998.
- [25] L. Fortnow and J. Rogers, “Complexity limitations on quantum computation”, *Proc. 13th IEEE Conf. on Computational Complexity*, pp. 202–209, 1998.
- [26] M.R. Garey and D.S. Johnson, *Computers and Intractability: A Guide to the Theory of NP-Completeness*, W.H. Freeman, 1979.
- [27] L.K. Grover, “A fast quantum mechanical algorithm for database search”, *Proc. 28th Ann. ACM Symp. on Theory of Computing (STOC '96)*, pp. 212–219, 1996.
- [28] A.S. Holevo, “Some estimates of the information transmitted by quantum communication channels”, *Problemy Peredachi Informatsii*, Vol. 9, pp. 3–11, 1973. English translation in *Problems of Information Transmission (USSR)*, Vol. 9, pp. 177–183, 1973.

- [29] B. Kalyanasundaram and G. Schnitger, “The probabilistic communication complexity of set intersection”, *Proc. 2nd Conf. on Structure in Complexity Theory*, pp. 41–49, 1987.
- [30] E. Knill, personal communication, 1996.
- [31] E. Knill, R. Laflamme, W. Zurek, “Threshold accuracy for quantum computation”, preprint quant-ph/9610011, 1996.
- [32] A.Y. Kitaev, “Quantum measurements and the Abelian stabilizer problem”, preprint quant-ph/9511026, 1995.
- [33] A.Y. Kitaev, “Quantum computations: algorithms and error correction”, *Russian Math. Surveys*, Vol. 52, No. 6, pp. 1191–1249, 1997.
- [34] I. Kremer, *Quantum Communication*, MSc Thesis, Computer Science Department, The Hebrew University, 1995.
- [35] E. Kushilevitz and N. Nisan, *Communication Complexity*, (Cambridge University Press), 1998.
- [36] H. Lenstra and C. Pomerance, “A rigorous time bound for factoring integers”, *J. of the AMS*, Vol. 5, No. 2, pp. 482–516, 1992.
- [37] M. Mosca, “Quantum searching, counting and amplitude amplification by eigenvector analysis”, *MFCS '98 workshop on Randomized Algorithms*, 1998.
- [38] M. Mosca and A. Ekert, “The hidden subgroup problem and eigenvalue estimation on a quantum computer”, to appear in *Proc. 1st NASA Intl. Conf. on Quantum Computing and Quantum Communications*, Vol. 1509 of *Lecture Notes in Computer Science* (Springer), 1998. preprint quant-ph/9903071, 1998.
- [39] H. Nishimura and M. Ozawa, “Computational complexity of uniform quantum circuit families and quantum Turing machines”, preprint quant-ph/9906095, 1999.
- [40] Y. Ozhigov, “Fast quantum verification for the formulas of predicate calculus”, preprint quant-ph/9809015, 1998.
- [41] C. Pomerance, “Fast rigorous factorization and discrete logarithm algorithms”, *Discrete Algorithms and Complexity (Proc. Japan-US Joint Seminar on Discrete Algorithms and Complexity theory)*, pp. 119–143, 1987.

- [42] J. Preskill, “Fault-tolerant quantum computation”, in *Introduction to Quantum Computation and Information*, edited by H.-K. Lo, S. Popescu, and T.P. Spiller (World Scientific), pp. 213–269, 1998.
- [43] R. Raz, “Exponential separation of quantum and classical communication complexity”, *Proc. 31st Ann. ACM Symp. on Theory of Computing (STOC ’99)*, pp. 358–367, 1999.
- [44] P.W. Shor, “Polynomial-time algorithms for prime factorization and discrete logarithms on a quantum computer”, *SIAM J. on Computing*, Vol. 26, No. 5, pp. 1484–1509, 1997. (An earlier version appeared in *FOCS ’94*.)
- [45] P.W. Shor, “Fault-tolerant quantum computation”, *Proc. 37th Ann. IEEE Symp. on Foundations of Computer Science (FOCS ’96)*, pp. 56–65, 1996.
- [46] D. Simon, “On the power of quantum computation”, *SIAM J. on Computing*, Vol. 26, No. 5, pp. 1474–1483, 1997. (An earlier version appeared in *FOCS ’94*.)
- [47] T. Sleator and H. Weinfurter, “Realizable universal quantum logic gates”, *Phys. Rev. Lett.*, Vol. 74, pp. 4087–4090, 1995.
- [48] R. Solovay, “Lie groups and quantum circuits”, paper in preparation, 1999.
- [49] R. Solovay and V. Strassen, “A fast Monte Carlo test for primality”, *SIAM J. on Computing*, Vol. 6, pp. 84–85, 1977. (Erratum in Vol. 7, p. 118, 1978.)
- [50] U.V. Vazirani, “Strong communication complexity or generating quasi-random sequences from two communicating slightly-random sources”, *Combinatorica*, Vol. 7, No. 4, pp. 375–392, 1987.
- [51] A. C.-C. Yao, “Some complexity questions related to distributive computing”, *Proc. 11th Ann. ACM Symp. on Theory of Computing (STOC ’79)*, pp. 209–213, 1979.
- [52] A. C.-C. Yao, “Quantum circuit complexity”, *Proc. 34th Ann. IEEE Symp. on Foundations of Computer Science (FOCS ’93)*, pp. 352–361, 1993.
- [53] C. Zalka, “Grover’s quantum searching algorithm is optimal”, preprint quant-ph/9711070, 1997.
- [54] C. Zalka, “A Grover-based quantum search of optimal order for an unknown number of marked elements”, preprint quant-ph/9902049, 1999.