

MULTIPLAYER QUANTUM MINORITY GAME WITH DECOHERENCE

ADRIAN P. FLITNEY

*Centre for Quantum Computer Technology, School of Physics, University of Melbourne
Parkville, VIC 3010, Australia*

LLOYD C. L. HOLLENBERG

*Centre for Quantum Computer Technology, School of Physics, University of Melbourne
Parkville, VIC 3010, Australia*

Received (received date)

Revised (revised date)

A quantum version of the Minority game for an arbitrary number of agents is considered. It is known that when the number of agents is odd, quantizing the game produces no advantage to the players, but for an even number of agents new Nash equilibria appear that have no classical analogue and have improved payoffs. We study the effect on the Nash equilibrium payoff of various forms of decoherence. As the number of players increases the multipartite GHZ state becomes increasingly fragile, as indicated by the smaller error probability required to reduce the Nash equilibrium payoff to the classical level.

Keywords: Quantum games, decoherence, Minority game, multiplayer games

Communicated by: to be filled by the Editorial

1 INTRODUCTION

Game theory is the formal description of conflict or competition situations where the outcome is contingent upon the interaction of the strategies of the various agents. For every outcome, each player assigns a numerical measure of the desirability to them of that outcome, known as their utility or payoff. (Strictly, the utility is a numerical measure and the payoff is a relative ordering, but for the purpose of the present work the two terms shall be used interchangeably.) A solution of a game-theoretic problem is a strategy profile that represents some form of equilibrium, the best known of which is the Nash equilibrium (NE) [1] from which no player can improve their payoff by a unilateral change in strategy. Originally developed for use in economics [2], game theory is now a mature branch of mathematics used in the social and biological sciences, computing and, more recently, in the physical sciences [3].

The Minority game (MG), initially proposed by Challet and Zhang [4], has received much attention as a model of a population of agents repeatedly buying and selling in a market [5, 6, 7, 8]. In its simplest form, at each step the agents must independently select among a pair of choices, labeled ‘0’ and ‘1.’ Players selecting the least popular choice are rewarded with a unit payoff while the majority emerge empty handed. Players’ strategies can be based on knowledge of previous selections and successes in past rounds. Examples of Minority games occur frequently in everyday life: selecting a route to drive into the city, choosing a checkout

queue in the supermarket etc. The idea behind the Minority game is neatly encapsulated by the following quote:

It is not worth an intelligent man's time to be in the majority. By definition there are already enough people to do that—*Geoffery Harold Hardy*.

The Minority game is generally restricted to an odd number of agents, but even numbers can be permitted with the proviso that when the number of players selecting 0 and 1 are equal all players lose.

A game can be considered an information processing system, where the players' strategies are the input and the payoffs are the output. With the advent of quantum computing and the increasing interest in quantum information [9, 10] it is natural to consider the combination of quantum mechanics and game theory. Papers by Meyer [11] and Eisert *et al.* [12] paved the way for the creation of the new field of quantum game theory. Classical probabilities are replaced by quantum amplitudes and players can utilize superposition, entanglement and interference.

In quantum game theory, new ideas arise in two-player [13, 14, 15, 16, 17, 18, 19] and multiplayer settings [20, 21, 22, 23, 24, 25, 26]. In the protocol of Eisert *et al.* [12], in two player quantum games there is no NE when both players have access to the full set of unitary strategies [27]. Nash equilibria exist amongst mixed quantum strategies [13] or when the strategy set is restricted in some way [12, 28, 29]. Strategies are referred to as pure when the actions of the player at any stage is deterministic and mixed when a randomizing device is used to select among actions. That is, a mixed strategy is a convex linear combination of pure strategies. In multiplayer quantum games new NE amongst unitary strategies can arise [20]. These new equilibria have no classical analogues. Reviews of quantum games and their applications are given by Flitney and Abbott [30] and Piotrowski and Śladowski [31, 32].

The realization of quantum computing is still an endeavour that faces great challenges [33]. A major hurdle is the maintenance of coherence during the computation, without which the special features of quantum computation are lost. Decoherence results from the coupling of the system with the environment and produces non-unitary dynamics. Interaction with the environment can never be entirely eliminated in any realistic quantum computer. Zurek gives a review of the standard mechanisms of quantum decoherence [34]. By encoding the logical qubits in a number of physical qubits, quantum computing in the presence of noise is possible. Quantum error correcting codes [35] function well provided the error rate is small enough, while decoherence free subspaces [36] eliminate certain types of decoherence.

The theory of quantum control in the presence of noise is little studied. Johnson has considered a three-player quantum game where the initial state is flipped to $|111\rangle$ from the usual $|000\rangle$ with some probability [37], while Özdemir *et al.* [38] have considered various two-player, two strategy (2×2) quantum games where the initial state is corrupted by bit flip errors. In both papers it was found that quantum effects impede the players: above a certain level of noise they are then better off playing the classical game. Chen *et al.* found that the NE in a set of restricted quantum strategies was unaffected by decoherence in quantum Prisoners' Dilemma [39], while Jing-Ling Chen *et al.* have considered Meyer's quantum Penny Flip game with various forms of decoherence [40]. Decoherence in various two player quantum games in the Eisert protocol is considered by Flitney and Abbott [41, 42]. The quantum

player maintains an advantage over a player restricted to classical strategies provided some level of coherence remains. The current work reviews the formalism for quantum games with decoherence and discusses the existing results for the quantum Minority game, before considering the quantum Minority game in the presence of decoherence.

2 QUANTUM GAMES WITH DECOHERENCE

The standard protocol for quantizing a game is well described in a number of papers [12, 30, 43] and will be covered here only briefly. If an agent has a choice between two strategies, the selection can be encoded in the classical case by a bit. To translate this into the quantum realm the bit is altered to a qubit, with the computational basis states $|0\rangle$ and $|1\rangle$ representing the original classical strategies. The initial game state consists of one qubit for each player, prepared in an entangled GHZ state by an entangling operator \hat{J} acting on $|00\dots 0\rangle$. Pure quantum strategies are local unitary operators acting on a player's qubit. After all players have executed their moves the game state undergoes a positive operator valued measurement and the payoffs are determined from the classical payoff matrix. In the Eisert protocol this is achieved by applying \hat{J}^\dagger to the game state and then making a measurement in the computational basis state. That is, the state prior to the measurement in the N -player case can be computed by

$$\begin{aligned} |\psi_0\rangle &= |00\dots 0\rangle \\ |\psi_1\rangle &= \hat{J}|\psi_0\rangle \\ |\psi_2\rangle &= (\hat{M}_1 \otimes \hat{M}_2 \otimes \dots \otimes \hat{M}_N)|\psi_1\rangle \\ |\psi_f\rangle &= \hat{J}^\dagger|\psi_2\rangle, \end{aligned} \tag{1}$$

where $|\psi_0\rangle$ is the initial state of the N qubits, and \hat{M}_k , $k = 1, \dots, N$, is a unitary operator representing the move of player k . The classical pure strategies are represented by the identity and the bit flip operator. The entangling operator \hat{J} commutes with any direct product of classical moves, so the classical game is simply reproduced if all players select a classical move.

Lee and Johnson [43] describe a more general quantum game protocol where the prepared initial state need not be a GHZ state and the final measurement need not be in the computational basis. Their protocol includes the method of Eisert. Wu [44] considers a further generalization to a game on quantum objects.

To consider decoherence it is most convenient to use the density matrix notation for the state of the system and the operator sum representation for the quantum operators. There are known limitations of this representation [45]; a variety of other techniques for calculating decoherence are considered by Brandt [46]. Decoherence includes dephasing, which randomizes the relative phase between the $|0\rangle$ and $|1\rangle$ states, and dissipation, that modifies the populations of the states, amongst other forms [9]. Pure dephasing can be expressed at the state level as

$$a|0\rangle + b|1\rangle \rightarrow a|0\rangle + b e^{i\phi}|1\rangle. \tag{2}$$

If the phase shift ϕ is a random variable with a Gaussian distribution of mean zero and variance 2λ , the density matrix obtained after averaging over all values of ϕ is [9]

$$\begin{pmatrix} |a|^2 & a\bar{b} \\ \bar{a}b & |b|^2 \end{pmatrix} \rightarrow \begin{pmatrix} |a|^2 & a\bar{b}e^{-\lambda} \\ \bar{a}be^{-\lambda} & |b|^2 \end{pmatrix}. \tag{3}$$

Thus, over time, dephasing causes an exponential decay of the off-diagonal elements of the density matrix and so is also known as phase damping.

An example of dissipation is amplitude damping. This could correspond, for example, to loss of a photon in an optical system. The effect on the density matrix is to reduce the amplitude of $|1\rangle\langle 1|$ as well as the off-diagonal elements.

Making a measurement with probability p in the $\{|0\rangle, |1\rangle\}$ basis on a qubit described by the density matrix ρ can be represented in the operator sum formalism by

$$\rho \rightarrow \sum_{j=0}^2 \hat{\mathcal{E}}_j \rho \hat{\mathcal{E}}_j^\dagger, \quad (4)$$

where $\mathcal{E}_0 = \sqrt{p}|0\rangle\langle 0|$, $\hat{\mathcal{E}}_1 = \sqrt{p}|1\rangle\langle 1|$, and $\hat{\mathcal{E}}_2 = \sqrt{1-p}\hat{I}$. By the addition of further $\hat{\mathcal{E}}_j$'s an extension to N qubits is achieved:

$$\rho \rightarrow \sum_{j_1, \dots, j_N=0}^2 \hat{\mathcal{E}}_{j_1} \otimes \dots \otimes \hat{\mathcal{E}}_{j_N} \rho (\hat{\mathcal{E}}_{j_1} \otimes \dots \otimes \hat{\mathcal{E}}_{j_N})^\dagger, \quad (5)$$

where, here, ρ is an N -qubit state. By identifying $1-p = e^{-\lambda}$, the measurement process as described has the same results as pure dephasing: the exponential decay of the off-diagonal elements of ρ .

In quantum computing it is usual to consider single qubit errors caused by bit flips, $\rho \rightarrow \hat{\sigma}_x \rho \hat{\sigma}_x$, phase flips, $\rho \rightarrow \hat{\sigma}_z \rho \hat{\sigma}_z$, and bit-phase flips, $\rho \rightarrow \hat{\sigma}_y \rho \hat{\sigma}_y$. Depolarization is a process where by a quantum state decays to an equal mixture of the $|0\rangle$ and $|1\rangle$ states. It can be considered to be a combination of bit, phase, and bit-phase flip errors:

$$\begin{aligned} \rho &\rightarrow \frac{pI}{2} + (1-p)\rho \\ &= (1-p)\rho + \frac{p}{3} \hat{\sigma}_x \rho \hat{\sigma}_x + \hat{\sigma}_y \rho \hat{\sigma}_y + \hat{\sigma}_z \rho \hat{\sigma}_z, \end{aligned} \quad (6)$$

where $I/2 = (|0\rangle\langle 0| + |1\rangle\langle 1|)/2$ is the completely mixed state. The errors given above are by no means an exhaustive list but consideration of them will give a good indication of the behaviour of our quantum system subject to random decoherence.

The physical implementation of a quantum system determines when the decoherence operators should be inserted in the formalism. For example, in a solid state implementation, errors, including qubit memory errors, need to be considered after each time step, while in an optical implementation memory errors only arise from infrequent photon loss, but errors need to be associated with each quantum gate. In addition, there may be errors occurring in the final measurement process. In this paper we shall describe a quantum game in the Eisert scheme with decoherence in the following manner

$$\begin{aligned} \rho_0 &= |\psi_0\rangle\langle\psi_0| && \text{(initial state)} \\ \rho_1 &= \hat{J}\rho_0\hat{J}^\dagger && \text{(entanglement)} \\ \rho_2 &= D(\rho_1, p) && \text{(partial decoherence)} \\ \rho_3 &= (\otimes_{k=1}^N \hat{M}_k) \rho_2 (\otimes_{k=1}^N \hat{M}_k)^\dagger && \text{(players' moves)} \\ \rho_4 &= D(\rho_3, p') && \text{(partial decoherence)} \\ \rho_5 &= \hat{J}^\dagger \rho_4 \hat{J} && \text{(preparation for measurement),} \end{aligned} \quad (7)$$

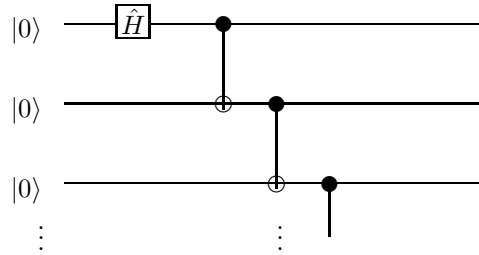

Fig. 1. A possible gate sequence to implement the entangling \hat{J} gate.

to produce the final state $\rho_f \equiv \rho_5$ upon which a measurement is taken. That is, errors are considered after the initial entanglement and after the players' moves. In all subsequent calculations we set $p' = p$. An additional error possibility could be included after the \hat{J}^\dagger gate but this gate is not relevant in the quantum Minority game since it only mixes states with the same player(s) winning [20]. Hence the gate and any associated decoherence will be omitted for the remainder of the paper. The \hat{J} gate can be implemented by a (generalized) Hadamard gate followed by a sequence of CNOT gates, as indicated in figure 1. When the number of qubits is large the possibility of errors occurring within the J gate needs to be considered but is not done so here. The function $D(\rho, p)$ is a completely positive map that applies some form of decoherence to the state ρ controlled by the probability p . For example, for bit flip errors

$$D(\rho, p) = (\sqrt{p} \hat{\sigma}_x + \sqrt{1-p} \hat{I})^{\otimes N} \rho (\sqrt{p} \hat{\sigma}_x + \sqrt{1-p} \hat{I})^{\otimes N}. \quad (8)$$

The scheme of Eq. (7) is shown in figure 2. The expectation value of the payoff to the k th player is

$$\langle \$^k \rangle = \sum_{\xi} \hat{\mathcal{P}}_{\xi} \rho_f \hat{\mathcal{P}}_{\xi}^{\dagger} \$_{\xi}^k, \quad (9)$$

where $\hat{\mathcal{P}}_{\xi} = |\xi\rangle\langle\xi|$ is the projector onto the computational state $|\xi\rangle$, $\$_{\xi}^k$ is the payoff to the k th player when the final state is $|\xi\rangle$, and the summation is taken over $\xi = j_1 j_2 \dots j_N$, $j_i \in \{0, 1\}$.

3 RESULTS FOR THE MULTIPLAYER MINORITY GAME

3.1 Without decoherence

In the classical Minority game the equilibrium is trivial: a maximum expected payoff is achieved if all players base their decision on the toss of a fair coin. The interest lies in studying the fluctuations that arise when agents use knowledge of past behaviour to predict a successful option for the next play. In the quantum game, as we shall see, a more efficient equilibrium can arise when the number of players is even. This paper only considers the situation where players do not make use of their knowledge of past behaviour. The classical pure strategies are then “always choose 0” or “always choose 1.” A pure quantum strategy is an $SU(2)$ operator:

$$\hat{M}(\theta, \alpha, \beta) = \begin{pmatrix} e^{i\alpha} \cos(\theta/2) & i e^{i\beta} \sin(\theta/2) \\ i e^{-i\beta} \sin(\theta/2) & e^{-i\alpha} \cos(\theta/2) \end{pmatrix}, \quad (10)$$

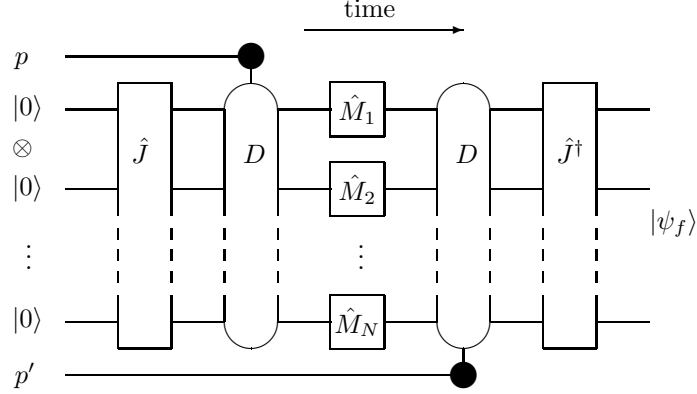

Fig. 2. The flow of information in an N -person quantum game with decoherence, where M_k is the move of the k th player and \hat{J} (\hat{J}^\dagger) is an entangling (dis-entangling) gate. The central horizontal lines are the players' qubits and the top and bottom lines are classical random bits with a probability p or p' , respectively, of being 1. Here, D is some form of decoherence controlled by the classical bits. Figure from Flitney and Abbott [42].

where $\theta \in [0, \pi]$ and $\alpha, \beta \in [-\pi, \pi]$. The k th player's move is $\hat{M}_k(\theta_k, \alpha_k, \beta_k)$. Here, $\hat{I} \equiv \hat{M}(0, 0, 0)$ and $i\hat{X} \equiv \hat{M}(\pi, 0, 0) = i\hat{\sigma}_x$ correspond to the two classical pure strategies. Entanglement, controlled by a parameter $\gamma \in [0, \pi/2]$, is achieved by

$$\hat{J}(\gamma) = \exp\left(i\frac{\gamma}{2}\sigma_x^{\otimes N}\right), \quad (11)$$

with $\gamma = \pi/2$ corresponding to maximal entanglement in a GHZ state. Operators of the form $\hat{M}(\theta, 0, 0)$ are equivalent to classical mixed strategies, with the mixing controlled by θ , since when all players use these strategies the quantum game reduces to the classical one. There is some arbitrariness about the representation of the operators. Other representations may lead to a different overall phase in the final state but this has no physical significance.

Benjamin and Hayden showed that in the four player quantum MG an optimal strategy arises [20]:

$$\begin{aligned} \hat{s}_{\text{NE}} &= \frac{1}{\sqrt{2}} \cos\left(\frac{\pi}{16}\right) (\hat{I} + i\hat{\sigma}_x) - \frac{1}{\sqrt{2}} \sin\left(\frac{\pi}{16}\right) (i\hat{\sigma}_y + i\hat{\sigma}_z) \\ &= \hat{M}\left(\frac{\pi}{2}, \frac{-\pi}{16}, \frac{\pi}{16}\right). \end{aligned} \quad (12)$$

The strategy profile $\{\hat{s}_{\text{NE}}, \hat{s}_{\text{NE}}, \hat{s}_{\text{NE}}, \hat{s}_{\text{NE}}\}$ results in a NE with an expected payoff of $\frac{1}{4}$ to each player, the maximum possible from a symmetric strategy profile, and twice that that can be achieved in the classical game, where the players can do no better than selecting 0 or 1 at random. The optimization is the result of the elimination of the states for which no player scores: those where all the players make the same selection or where the choices are balanced.

The strategy of Eq. (12) is seen to be a NE by observing the payoff to the first player when they vary from the NE profile by selecting the general strategy $\hat{M}(\theta, \alpha, \beta)$ while the others play \hat{s}_{NE} . Figure 3 shows the first player's payoff as a function of θ when $\beta = -\alpha = \pi/16$, and as a function of α and β when $\theta = \pi/2$. The latter figure indicates that the NE is not strict: varying

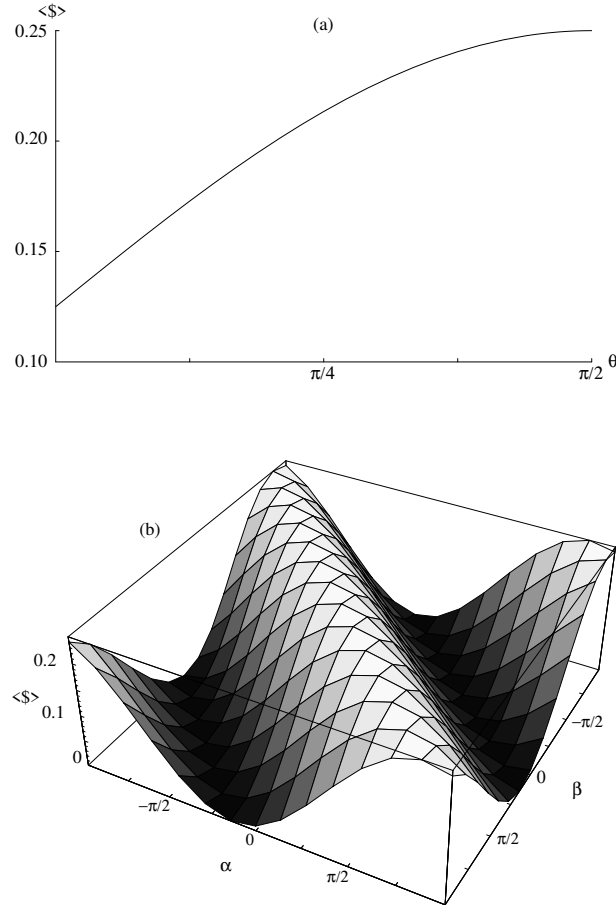

Fig. 3. The payoff to the first player in an $N = 4$ player quantum Minority game without decoherence when they choose the strategy (a) $\hat{M}(\theta, -\pi/16, \pi/16)$ or (b) $\hat{M}(\pi/2, \alpha, \beta)$, while the other players all select \hat{s}_{NE} .

the strategy to $\hat{M}(\pi/2, \eta - \pi/16, \eta + \pi/16)$, for arbitrary $\eta \in \{-15\pi/16, 15\pi/16\}$ leaves the payoff unchanged. Specifically, the payoff to the first player when they play $\hat{M}(\theta, \alpha, \beta)$ while the others select \hat{s}_{NE} is

$$\langle \$ \rangle = \frac{1}{8} + \frac{1}{8} \cos\left(\frac{\pi}{8} + \alpha - \beta\right) \sin \theta \quad (13)$$

which is maximized when $\theta = \pi/2$ and $\pi/8 + \alpha - \beta = 2n\pi$ for integer n . This demonstrates that the strategy given in Eq. (12) is a NE.

This result has been generalized to arbitrary N by Chen *et al.* who show that analogous NE occur for all even N [26]. A way of arriving at this result in our notation, with $p = p' = 0$, is to consider a symmetric strategy profile where all players choose

$$\hat{s}_\delta = \hat{M}\left(\frac{\pi}{2}, -\delta, \delta\right), \quad (14)$$

for some $\delta \in \mathbb{R}$ to be determined. Then,

$$|\psi_f\rangle = \left[\frac{1}{\sqrt{2}} \begin{pmatrix} e^{-i\delta} & ie^{i\delta} \\ ie^{-i\delta} & e^{i\delta} \end{pmatrix} \right]^{\otimes N} (|00\dots 0\rangle + i|11\dots 1\rangle). \quad (15)$$

Thus, for even N , the coefficient of states in $|\psi_f\rangle$ that have an equal number of ones and zeros is proportional to

$$(e^{-i\delta})^{N/2}(ie^{-i\delta})^{N/2} + i(e^{i\delta})^{N/2}(ie^{i\delta})^{N/2} = \pm(1+i)(\cos(N\delta) - \sin(N\delta)), \quad (16)$$

giving a probability for these states proportional to $1 - \sin(2N\delta)$. This probability vanishes when

$$\delta = \frac{(4n+1)\pi}{4N}, \quad n = 0, \pm 1, \pm 2, \dots \quad (17)$$

For the collective good, the vanishing of the balanced states is optimal since these are the ones for which no player scores. Each value of δ gives a NE for the N even player quantum MG. In addition, for each δ there is a continuum of symmetric NE strategies of the form $\hat{M}(\pi/2, \eta - \delta, \eta + \delta)$. Figure 4 indicates that $\hat{M}(-\pi/2, -\pi/24, \pi/24)$ is a NE for the six player MG. For $N > 4$ the payoffs for the NE strategies are not Pareto optimal. For example, for $N = 6$ each player scores $\frac{5}{16}$ compared with the Pareto optimal payoff of $\frac{1}{3}$ that would result if all the final states consisted of two players selecting one option while the other four chose the second option. An alternate way of expressing the lack of optimality is to say that the final state prior to measurement, in the six player game, has a probability of $\frac{15}{16}$ of giving a Pareto optimal result when a measurement of the state is taken in the computational basis.

The NE that arises from selecting $\delta = \pi/(4N)$ and $\eta = 0$ may serve as a focal point for the players and be selected in preference to the other equilibria. However, if the players select \hat{s}_{NE} corresponding to different values of n the result may not be a NE. For example, in the four player MG, if the players select n_A, n_B, n_C , and n_D , respectively, the resulting payoff depends on $(n_A + n_B + n_C + n_D) \pmod{4}$. If the value is zero, all players receive the quantum NE payoff of $\frac{1}{4}$, if it is one or three, the expected payoff is reduced to the classical NE value of $\frac{1}{8}$, while if it is two, the expected payoff vanishes. As a result, if all the players choose a random value of n the expected payoff is the same as that for the classical game ($\frac{1}{8}$) where all the players selected 0 or 1 with equal probability. Analogous results hold for the quantum MG with larger numbers of players.

When N is odd the situation is changed. The Pareto optimal situation would be for $(N-1)/2$ players to select one alternative and the remainder to select the other. In this way the number of players that receive a reward is maximized. In the entangled quantum game there is no way to achieve this with a symmetric strategy profile. Indeed, all quantum strategies reduce to classical ones and the players can achieve no improvement in their expected payoffs [26].

The NE payoff for the N even quantum game is precisely that of the $N-1$ player classical game where each player selects 0 or 1 with equal probability. The effect of the entanglement and the appropriate choice of strategy is to eliminate some of the least desired final states, those with equal numbers of zeros and ones. The difference in behaviour between odd and even N arises since, although in both cases the players can arrange for the final state to consist of a superposition with only even (or only odd) numbers of zeros, only in the case when N is even is this an advantage to the players. Figure 5 shows the maximum expected payoffs for the quantum and classical MG for even N .

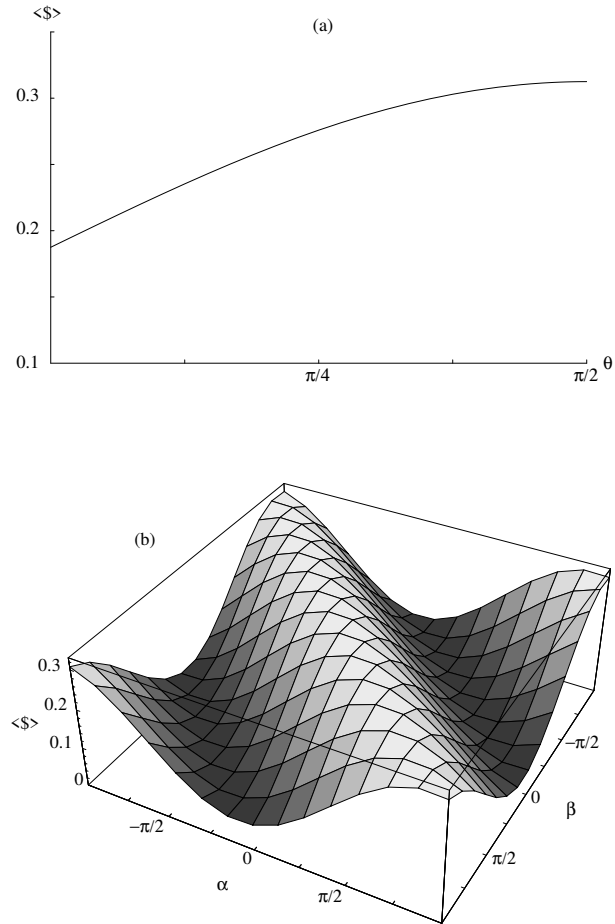

Fig. 4. The payoff to the first player in an $N = 6$ player quantum Minority game without decoherence when they choose the strategy (a) $\hat{M}(\theta, -\pi/24, \pi/24)$ or (b) $\hat{M}(\pi/2, \alpha, \beta)$, while the other players all select \hat{s}_{NE} .

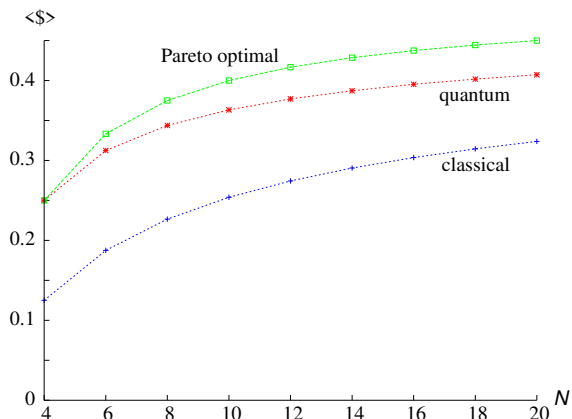

Fig. 5. The Nash equilibrium payoff as a function of the number of players (N) for even N for the fully entangled quantum case (*) and the classical case (+). Compare with the Pareto optimal payoffs (\square). The curves slowly converge to $\langle \$ \rangle = \frac{1}{2}$ as $N \rightarrow \infty$.

3.2 With decoherence

The addition of decoherence by dephasing (or measurement) to the four player quantum MG results in a gradual diminution of the NE payoff, ultimately to the classical value of $\frac{1}{8}$ when the decoherence probability p is maximized, as indicated in figure 6. However, the strategy given by Eq. (12) remains a NE for all $p < 1$. This is in contrast with the results of Johnson [37] for the three player “El Farol bar problem” [47] and Özdemir *et al.* [38] for various two player games in the Eisert scheme, who showed that the quantum optimization did not survive above a certain noise threshold in the quantum games they considered. Bit (or \hat{X}), phase (or \hat{Z}), and bit-phase (or \hat{Y}) flip errors result in a more rapid relaxation of the expected payoff to the classical value, as does depolarization, with similar behaviour for these error types for $p < 0.5$.

The results for the bit, phase, and bit-phase flip errors can be understood as follows. As the error probability is increased towards $\frac{1}{2}$ each qubit is reduced to an equal superposition of the $|0\rangle$ and $|1\rangle$ states, the optimal classical strategy, and hence the classical payoff results. Two phase flip errors per qubit will cancel each other out so the curve for phase flip errors is symmetrical about $p = \frac{1}{2}$ since the errors are applied twice (see figure 2). For bit flip errors, the system approaches an equal superposition of states with an even number of zeros and ones as the error rate approaches one, giving a zero payoff. This effect dominates in the case of bit-phase flip error. In these cases a new NE profile where all agents play $\hat{M}(\pi/2, \pi/16, -\pi/16)$ emerges for $p > \frac{1}{2}$. This profile yields the optimum (quantum) payoff.

Figures 7 and 8 show the results for the six and eight player quantum MG with decoherence. Decoherence reduces the expected payoff for the NE strategy to the classical level more quickly as N increases as a result of the increasing fragility of the GHZ state.

The entanglement that gives rise to the quantum enhancement in the payoff is a global property of the N qubits. Decoherence in any qubit affects all the players equally, not just the owner of the affected qubit. In the case of phase damping—see Eq. (5)—where N_1 players have decoherence probability p_1 and N_2 players have decoherence probability p_2 , the expected

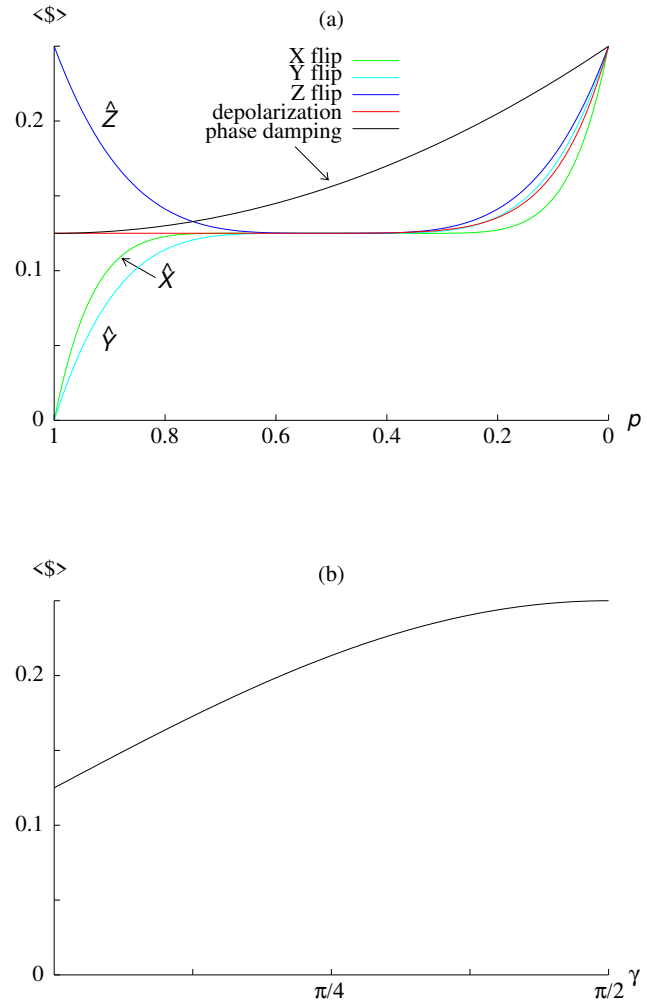

Fig. 6. (a) The Nash equilibrium payoff in an $N = 4$ player quantum Minority game as a function of the decoherence probability p . The decoherence goes from the unperturbed quantum game at $p = 0$ (right) to maximum decoherence at $p = 1$ (left). The curves indicate decoherence by phase damping (black), depolarization (red), bit flip errors (green), phase flip errors (blue) and bit-phase flip errors (blue-green). Compare this with (b) the Nash equilibrium payoff for $N = 4$ as a function of the entangling parameter γ [Eq. (11)].

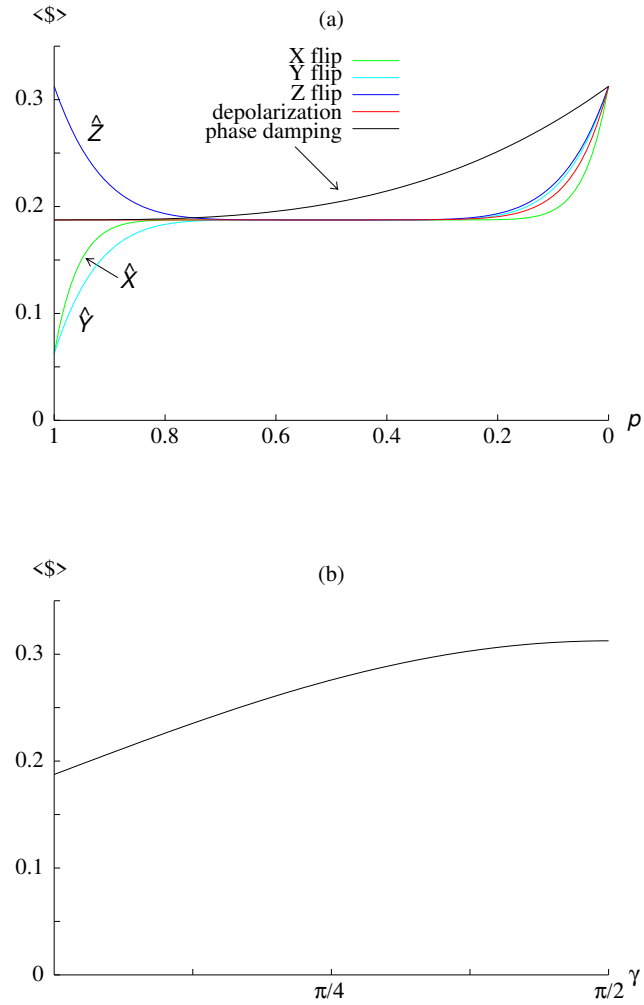

Fig. 7. (a) The Nash equilibrium payoff in an $N = 6$ player quantum Minority game as a function of the decoherence probability p . The decoherence goes from the unperturbed quantum game at $p = 0$ (right) to maximum decoherence at $p = 1$ (left). The curves indicate decoherence by phase damping (black), depolarization (red), bit flip errors (green), phase flip errors (blue) and bit-phase flip errors (blue-green). Compare this with (b) the Nash equilibrium payoff for $N = 6$ as a function of the entangling parameter γ [Eq. (11)].

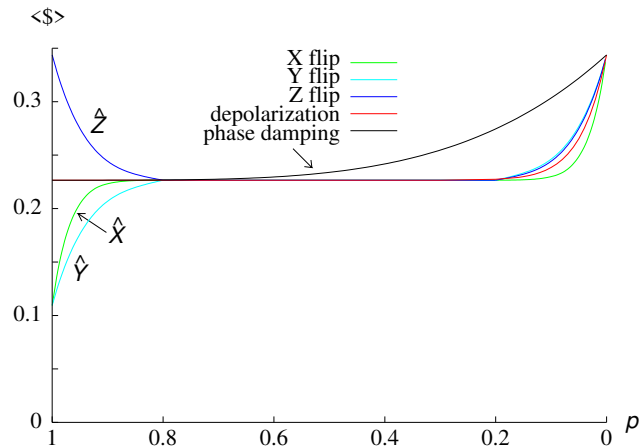

Fig. 8. The Nash equilibrium payoff in an $N = 8$ player quantum Minority game as a function of the decoherence probability p . The decoherence goes from the unperturbed quantum game at $p = 0$ (right) to maximum decoherence at $p = 1$ (left). The curves indicate decoherence by phase damping (black), depolarization (red), bit flip errors (blue), phase flip errors (green) and bit-phase flip errors (blue-green).

NE payoff for all the players can be expressed as

$$\langle \$ \rangle = \langle \$ \rangle_{C1} + (\langle \$ \rangle_Q - \langle \$ \rangle_{C1})(1 - p_1)^{(N_1/2)}(1 - p_2)^{(N_2/2)} \quad (18)$$

where the subscripts C1 and Q refer to classical and quantum, respectively. Expressions for other types of errors are more complex but remain equal for all players. The fact that all the players score equally has relevance to the application of quantum error correction: no player can advantage themselves over the other players by using quantum error correction on their qubit. Instead, all players benefit equally. The situation would be different, however, if a subset of the players shared an entangled set of qubits while the others were not entangled.

4 CONCLUSION

We have considered a quantum version of an N -player Minority game where agents individually strive to select the minority alternative out of two possibilities. Entanglement amongst the qubits representing the players' selection offers the possibility of enhancing the payoffs to the players compared with the classical case when the number of players is even.

When decoherence is added to the quantum Minority game, the Nash equilibrium payoff is reduced as the decoherence is increased, as one would expect. However, the Nash equilibrium remains the same provided the decoherence probability is less than $\frac{1}{2}$, and is still the best result for the group that can be achieved in the absence of cooperation. The effect of depolarization, bit, phase, or bit-phase flip errors reduces the expected payoff to the classical level for an error probability of greater than approximately 0.2, with the drop off being steeper as the number of players increases. A more gradual reduction is seen with phase damping, with an expected payoff above the classical level unless the decoherence is maximized.

All players are equally disadvantaged by decoherence in one of the qubits. Hence no player, or group of players, can gain an advantage over the remainder by utilizing quantum

error correction to reduce the error probability of their qubit. However, the consideration of different forms of entanglement, or partial-entanglement, in the initial state is an interesting area for future study. The simplicity and possible application of the Minority game suggests that the study of the quantum version is relevant to the theory of quantum information and quantum entanglement.

Acknowledgments

Thanks go to Derek Abbott of The University of Adelaide for reviewing an earlier draft of this manuscript, to my colleagues Austin Fowler and Andy Greentree of Melbourne University, to Charley Choe of Oxford University, and to Johannes Kofler of Universität Wien, for their ideas and helpful discussion. Funding for AF was provided by the Australian Research Council grant number DP0559273. LH is supported in part by the Australian Research Council, the Australian government, the US National Security Agency, the Advanced Research and Development Activity and the US Army Research Office under contract number W911NF-04-1-0290.

References

1. J. Nash (1950), *Equilibrium points in n -person games*, Proc. National Academy of Science, **36**, pp. 48–49.
2. J. von Neumann and O. Morgenstein (1944), *The Theory of Games and Economic Behaviour*, Princeton University Press (Princeton).
3. D. Abbott, P. C. W. Davies and C. R. Shalizi (2002), *Order from disorder: The role of noise in creative processes A special issue on game theory and evolutionary processes—overview*, Fluct. Noise Lett., **2**, pp. C1–C12.
4. D. Challet and Y-C. Zhang (1997), *Emergence of cooperation and organization in an evolutionary game*, Physica A, **24**, pp. 407–418.
5. R. Savit, R. Manuca and R. Riolo (1999), *Adaptive competition, market efficiency, and phase transitions*, Phys. Rev. Lett., **82**, pp. 2203–2206.
6. N. F. Johnson, S. Jarvis, R. Jonson, P. Cheung, Y. R. Kwong and P. M. Hui (1998), *Volatility and agent adaptability in a self-organizing market*, Physica A, **258**, pp. 230–236.
7. D. Challet, M. Marsili and Y-C Zhang (2000), *Modeling market mechanism with minority game*, Physica A, **276**, pp. 284–315.
8. E. Moro (2004), *The Minority game: an introductory guide*, in *Advances in Condensed Matter and Statistical Physics*, eds. E. Korutcheva and R. Cuperono, Nova Science Publishers Inc. (Hauppauge).
9. M. A. Nielsen and I. Chuang (2000), *Quantum Computation and Quantum Information*, Cambridge University Press (Cambridge).
10. J. Eisert and M. M. Wolf (2004), *Quantum computing*, in *Handbook of Innovative Computing*, Springer (Berlin-Heidelberg-Frankfurt).
11. D. A. Meyer (1999), *Quantum strategies*, Phys. Rev. Lett., **82**, pp. 1052–1055.
12. J. Eisert, M. Wilkins and M. Lewenstein (1999), *Quantum games and quantum strategies*, Phys. Rev. Lett., **83**, pp. 3077–3088.
13. J. Eisert and M. Wilkins (2000), *Quantum games*, J. Mod. Opt., **47**, pp. 2543–2556.
14. L. Marinatto and T. Weber (2000), *A quantum approach to games of static information*, Phys. Lett. A, **272**, pp. 291–303.
15. A. Iqbal and A. H. Toor (2001), *Evolutionary stable strategies in quantum games*, Phys. Lett. A, **300**, pp. 537–542.
16. A. Iqbal and A. H. Toor (2002), *Quantum repeated games*, Phys. Lett. A, **300**, pp. 537–542.

17. J. Du, X. Xu, H. Li, M. Shi, M. Zhou and R. Han (2002), *Quantum strategy without entanglement*, Chinese Physics Letters, **19**, p. 1221.
18. A. P. Flitney and D. Abbott (2002), *Quantum version of the Monty Hall problem*, Phys. Rev. A, **65**, 062318.
19. A. F. Huertas-Rosero (2004), *Classification of symmetric non-zero sum 2×2 games in the Eisert scheme*, M.Sc. thesis, Universidad de los Andes, Bogotá, Columbia, quant-ph/0402117.
20. S. C. Benjamin and P. M. Hayden (2001), *Multiplayer quantum games*, Phys. Rev. A, **64**, 030301(R).
21. R. Kay, N. F. Johnson and S. C. Benjamin (2001), *Evolutionary quantum game*, J. Phys. A, **34**, pp. L547–L552.
22. J. Du, H. Li, X. Xu, M. Shi and X. Zhou (2002), *Entanglement enhanced multiplayer quantum games*, Phys. Lett. A, **302**, pp. 229–233.
23. Y.-J. Han, Y.-S. Zhang and G.-C. Guo (2002), *W state and Greenberger-Horne-Zeilinger state in quantum three person Prisoner's Dilemma*, Phys. Lett. A, **295**, pp. 61–64.
24. A. Iqbal and A. H. Toor (2002), *Quantum mechanics gives stability to Nash equilibrium*, Phys. Rev. A, **65**, 022036.
25. A. P. Flitney, and D. Abbott (2004), *Quantum two and three person duels*, J. Opt. B, **6**, pp. S860–S866.
26. Q. Chen, Y. Wang, J.-T. Liu and K.-L. Wang (2004), *N-player quantum minority game*, Phys. Lett. A, **327**, pp. 98–102.
27. S. C. Benjamin and P. M. Hayden (2001), *Comment on "Quantum games and quantum strategies,"* Phys. Rev. Lett., **87**, 069801.
28. J. Du, X. Xu, H. Li, X. Zhou and R. Han (2001), *Entanglement playing a dominating role in quantum games*, Phys. Lett. A, **289**, pp. 9–15.
29. J. Du, H. Li, X. Xu, X. Zhou and R. Han (2003), *Phase transition-like behaviour of quantum games*, J. Phys. A, **36**, pp. 6551–6562.
30. A. P. Flitney and D. Abbott (2002), *An introduction to quantum game theory*, Fluct. Noise Lett., **2**, pp. R175–R187.
31. E. W. Piotrowski and J. Sładowski (2003), *An invitation to quantum game theory*, Int. J. Theor. Phys., **42**, p. 1089.
32. E. W. Piotrowski and J. Sładowski (2004), *The next stage: quantum game theory*, in *Mathematical Physics Research at the Cutting Edge*, ed. C. V. Benton, Nova Science Publishers (Hauppauge) pp. 251–272.
33. D. Abbott, C. R. Doering, C. M. Caves, D. M. Lidar, H. E. Brandt, A. R. Hamilton, D. K. Ferry, J. Gea-Banacloche, S. M. Bezrukov and L. B. Kish (2003), *Dreams versus reality: plenary debate session on quantum computing*, Quant. Inf. Proc., **2**, pp. 449–472.
34. W. H. Zurek (2003), *Decoherence, einselection and the quantum origins of the classical*, Rev. Mod. Phys., **75**, pp. 713–775.
35. J. Preskill (1998), *Reliable quantum computing*, Proc. Roy. Soc. A, **454**, pp. 385–410
36. D. A. Lidar and K. B. Whaley (2003), *Decoherence free subspaces and subsystems in Irreversible Quantum Dynamics*, Springer Lecture Notes in Physics, Vol. 622, eds. F. Benatti and R. Floreanini, Springer (Berlin), pp. 83–120.
37. N. F. Johnson (2001), *Playing a quantum game with a corrupted source*, Phys. Rev. A, **63**, 020302(R).
38. S. K. Özdemir, J. Shimamura and N. Imoto (2004), *Quantum advantage does not survive in the presence of a corrupt source: optimal strategies in simultaneous move game*, quant-ph/0402038
39. L. K. Chen and H. Ang and D. Kiang and L. C. Kwek and C. F. Lo (2003), *Quantum Prisoner Dilemma under decoherence*, Phys. Lett. A, **316**, pp. 317–323.
40. J.-L. Chen, L. C. Kwek and C. H. Oh (2002), *Noisy quantum game*, Phys. Rev. A, **65**, 052320.
41. A. P. Flitney and D. Abbott (2004), *Decoherence in quantum games in Proc. SPIE Symp. on Fluctuations and Noise in Photonics and Quantum Optics II* (Maspalomas, Spain), eds. P. Heszler, D. Abbott, J. R. Gea-Banacloche and P. R. Hemmer, pp. 313–321.

42. A. P. Flitney and D. Abbott (2005), *Quantum games with decoherence*, J. Phys. A, **38**, pp. 449–459.
43. C. F. Lee and N. F. Johnson (2003), *Efficiency and formalism of quantum games*, Phys. Rev. A, **67**, 022311.
44. J. Wu (2005), *Theory of games on quantum objects*, eprint: quant-ph/0503094.
45. A. Royer (1996), *Reduced dynamics with initial correlations and time-dependent environment and Hamiltonian*, Phys. Rev. Lett., **77**, pp. 3272–3275.
46. H. E. Brandt (1998), *Qubit devices and the issue of quantum decoherence*, Prog. Quant. Electronics, **22**, pp. 257–370.
47. W. B. Arthur (1994), *Inductive reasoning and bounded rationality*, American Economic Review, **84**, pp. 406–411.