

Information processing in generalized probabilistic theories

Jonathan Barrett*

Perimeter Institute for Theoretical Physics, 31 Caroline Street N, Waterloo, Ontario N2L 2Y5, Canada

I introduce a framework in which a variety of probabilistic theories can be defined, including classical and quantum theories, and many others. From two simple assumptions, I derive a tensor product rule for combining separate systems. Certain features, usually thought of as specifically quantum, turn out to be generic in this framework, meaning that they are present in all except classical theories. These include the non-unique decomposition of a mixed state into pure states, disturbance of a system on measurement (suggesting that the possibility of secure key distribution is generic), and a no-cloning theorem. I investigate in detail two particular theories. One of these includes states that can give rise to arbitrary non-signalling correlations, including the super-quantum correlations that have become known in the literature as non-local machines or PR boxes. By investigating these correlations in the context of a theory with well-defined dynamics, I hope to make further progress with a question raised by Popescu and Rohrlich, which is, why does quantum theory not allow these strongly non-local correlations? The existence of strongly non-local correlations forces much of the dynamics in this theory to be, in a certain sense, classical, with consequences for teleportation, cryptography and computation. I also investigate another theory in which all states are local. This has its own consequences for cryptography and computation. Finally, I raise the hypothesis that quantum theory is optimal for computation amongst theories in this framework. I also raise the question of what further axiom(s) could be added to the framework in order uniquely to identify quantum theory.

PACS numbers: 03.67.-a, 03.65.Ta

I. INTRODUCTION

The question is periodically raised, what is responsible for the power of quantum computation (or cryptography, or information processing in general)? At a recent meeting in Konstanz [1], speakers referred to quantum entanglement; the superposition principle; the exponentially growing size of Hilbert space with the number of qubits; nonlocality and contextuality; the possibility of continuous reversible transformations between pure states; and the so-called sign problem in Monte Carlo simulations of certain types of quantum system [2]. It is perhaps unsurprising that there are so many different answers. The problem is that the results of quantum information theory are already well understood as consequences of the quantum formalism, and it is not clear that simply pointing to aspects of that formalism tells us anything new. What we are really looking for is a better understanding of the connections between information processing and physical principles in general.

Such an understanding could be gained by studying information processing in a broader range of theories than classical and quantum, where different physical principles may hold. For any theory, whether it applies to Nature or not, one can consider the information processing possibilities of this theory, the differences from those of classical or quantum theory, and attempt to trace these possibilities back to the fundamental features of the theory. Some authors have indeed investigated unrealistic theo-

ries, with a view to understanding the relevant features [3, 4, 5, 6, 7, 8, 9, 10, 11, 12, 13, 14].

To make further progress along these lines, I introduce an operational framework for probabilistic theories in which a broad range of different theories can be defined. The framework, described in Sections II, III and IV, is based on that used by Hardy in his derivation of quantum theory from simple axioms [15]. The basic idea is that a state is represented as a vector of probabilities of measurement outcomes. Transformations of a system must correspond to linear transformations of this vector. By including probabilistic, that is normalization decreasing, transformations, a unified account of transformations and measurements can be given. Rather than employ any of Hardy's axioms, I introduce two assumptions that concern how separate systems combine to form a joint system. The first is that operations on the separate systems commute (this implies a no-signalling principle), and the second is that the state of the joint system can be completely specified by joint probabilities for local measurements. From these assumptions a tensor product rule can be derived. This removes at least some of the mystery from the quantum tensor product rule and generalizes a derivation by Fuchs [16].

The resulting framework includes classical probabilistic theories, quantum theory, and many other theories besides. The first thing one notices is that certain phenomena, usually thought of as specifically quantum, are in fact generic. This means that they either appear in all theories, or they appear in all theories except classical theories, which emerge as a very special case. As shown in Section V, these phenomena include the non-unique decomposition of a mixed state into pure states,

*Electronic address: jbarrett@perimeterinstitute.ca

the disturbance of a system on measurement and the no-cloning theorem. (These observations are complementary to those of Ref. [14], where it is noted that similar properties hold in nonlocal but non-signalling theories.)

In addition to looking at generic properties of theories, it is useful to analyze at least one or two novel theories in detail. These then provide well-understood examples that can be contrasted with the classical and quantum cases. Thus the rest of this work is devoted to an analysis of two theories that admit a particularly natural definition within the framework. The first of these allows arbitrary correlations between measurements on separated systems, as long as they are non-signalling. I call it Generalized Non-Signalling Theory (GNST). The correlations allowed by this theory can be more non-local than quantum theory allows, and include the super-quantum correlations that have come to be known variously in the literature as Popescu-Rohrlich (PR) boxes, or Non-Local Machines [17, 18, 19, 20, 21, 22, 23, 24, 25, 26, 27]. Popescu and Rohrlich raised the question of why quantum theory does not allow these correlations. An investigation of a complete theory, with dynamics, that does include the correlations may help to answer this question. The second theory allows the same states of single systems as GNST, but does not allow any violation of Bell inequalities. For this reason it is called Generalized Local Theory (GLT).

One of the interesting things about GNST is that there are many direct analogues of quantum phenomena (in addition to the generic phenomena mentioned above). These include entanglement, nonlocality, a form of contextuality, the Einstein-Podolski-Rosen (EPR) paradox, and the Jamiolkowski isomorphism between transformations and states [28]. (Interestingly, a quite different toy theory introduced by Spekkens displays many of these phenomena too [12].) However, there are also differences with quantum theory. A central insight of this work is that there is a trade-off between the allowed states of a theory and the allowed dynamics. This follows from the simple fact that dynamics has to act in such a way that allowed states are taken to allowed states. In the case of GNST, the fact that all non-signalling correlations are possible means that the dynamics is highly restricted. In fact, I show in Section VI that the dynamics of single systems in GNST is essentially classical, corresponding to no more than relabellings of measurements and outcomes. This result is extended to transformations and measurements on simple kinds of bipartite systems (more complicated cases are still open). GLT is in some sense intermediate, with transformations on single systems similarly simple, but with transformations on bipartite systems including other possibilities.

These conclusions about dynamics have consequences for information processing, discussed in Section VII. For example, there is no teleportation in GNST, despite the existence of highly non-local states that might have been thought to facilitate a task like teleportation. Key distribution is possible in GNST and 1-2 oblivious transfer

in both GNST and GLT. Other cryptographic possibilities, such as key distribution in GLT, or bit commitment in either theory, are open questions. A natural circuit-type model of computation can be defined for any theory in the framework. The states and dynamics together in GLT are sufficiently restricted that computation can be simulated easily by a classical computer. If the theorem concerning the simplicity of the dynamics of some bipartite systems in GNST can be extended to all systems, it would follow that computation in this theory is no better than classical either (*despite* the existence of super-entangled states). The fact that quantum theory, unlike GNST and GLT, achieves such a harmonious balance of states and dynamics leads to the following hypothesis that I leave open: *quantum theory is optimal for computation amongst theories in this framework.*

Finally, two motivations are not directly connected with information processing. On the face of it, most of the theories that can be written down in the framework described suffer from similar interpretational problems as quantum theory. For example, are pure states in one of these theories best regarded as direct descriptions of reality, as statistical in nature, or as descriptions of some agent's knowledge? Although I do not do this in this paper, consideration of these questions in a broader framework may shed new light on the quantum theoretical problems. The other motivation is to stimulate research into finding ways of deriving quantum theory from physical principles (instead of laying down a list of mathematical axioms, as per the standard textbook approach). What principles could be used to rule out the other theories described and leave only quantum theory? One reason for deriving quantum theory from physical principles is that by modifying one or another of the principles, we may discover new ways of going beyond quantum theory.

II. A FRAMEWORK FOR PROBABILISTIC THEORIES

This section describes in some detail a general operational framework in which probabilistic theories can be written down. All theories in this framework share the following features with classical and quantum theory.

1. Local operations on distinct subsystems commute. In the case of a bipartite system AB , for example, this means that if an operation is performed on system A alone, and an operation on system B alone, it does not matter what order the operations were performed in.
2. The global state of a composite system is determined by correlations between local measurements.

A. States and Operations

Consider a laboratory containing *preparation devices* and *operation devices*. Preparation devices prepare a system in a given state and operation devices act on a system, in general changing its state. When an operation device is used, there may be several different outcomes, each occurring with some probability. Each outcome is identified by a different macroscopic event (for example, a different light being illuminated on the device, or a different position of a pointer). Thus operation devices serve to perform both transformations and measurements. Given the state of a system, it should be possible to calculate the probabilities of measurement outcomes for any measurement. Conversely, if the probabilities of measurement outcomes for any measurement are known, then the state is known.

Suppose that systems come in different *types*, where in quantum theory, for example, the type of system corresponds to the dimension of its Hilbert space. For each type of system, there is some finite set \mathcal{F} of measurements, each with a finite number of outcomes, such that the state of the system can be completely specified by listing the probabilities for these outcomes. For example, in quantum theory, the state of a spin-1/2 particle can be specified by giving the probabilities of obtaining spin-up on measuring in the x , y and z directions. Call the measurements in \mathcal{F} *fiducial* measurements and \mathcal{F} the *fiducial set*. In general, there will be other measurements that can be performed on a system that are not contained in the fiducial set (a measurement of spin in some direction at 45° to the z -axis, say). The probabilities of outcomes of these measurements can nevertheless be determined from the state. We ignore the possibility of states requiring an infinite number of probabilities to be specified (despite the fact that quantum theory includes infinite dimensional systems and classical probability theory infinite sample sets). The set of fiducial measurements need not be unique. In general it will be possible to find a different set (perhaps involving a different number of measurements with different numbers of outcomes) that also suffices to specify the state.

This is essentially the framework described by Hardy [15], who introduced the term *fiducial* for the state-defining measurements. (See also [16, 29, 30, 31], where the idea of representing a state via probabilities for measurement outcomes is also explored.) Unlike Hardy, we shall assume for convenience that the degrees of freedom expressed in the state are internal degrees of freedom, and that all measurements are measurements of internal degrees of freedom. With respect to spacetime degrees of freedom, systems behave classically, having a definite position and velocity at all times. This seems the most natural position to take given that we are most interested in the information processing properties of the different theories considered. However, it would be interesting to extend this work, and to consider what Nature would be like if all degrees of freedom, including those of space-

time, were described by a theory like one of the ones presented here (but extended to allow for infinite-outcome measurements).

The above is summarized by

Assumption 1 *The state of a single system can be completely specified by listing the probabilities for the outcomes of some subset \mathcal{F} of all possible measurements. These are the fiducial measurements. These probabilities can be written arranged in a vector.*

$$\vec{P} \equiv \begin{pmatrix} P(a=0|X=0) \\ P(a=1|X=0) \\ \vdots \\ \hline P(a=0|X=1) \\ P(a=1|X=1) \\ \vdots \\ \hline \vdots \end{pmatrix}. \quad (1)$$

$P(a=i|X=j)$ is the probability of getting outcome i when fiducial measurement $j \in \mathcal{F}$ is performed on the system.

Normalization of the state would require that

$$\sum_i P(a=i|X=j) = 1 \quad \forall j, \quad (2)$$

where the sum ranges over all the values i that the outcome can take for a particular measurement. It is convenient also to give a meaning to unnormalized states (just as in quantum theory it is sometimes convenient to write down unnormalized density matrices). Suppose that a system is prepared in some (normalized) state and an operation performed with an outcome i that is obtained with probability less than 1. There is an unnormalized state associated with i , each entry of which is the joint probability of getting i followed by a particular outcome for a subsequent fiducial measurement. This implies that unnormalized states satisfy

$$\sum_i P(a=i|X=j) = \sum_i P(a=i|X=j') = c \quad \forall j, j' \quad (3)$$

with $0 \leq c \leq 1$. In the case described, c is the probability of the outcome i . This idea generalizes to chains of operations, thus operations should be defined on unnormalized states as well as on normalized ones. Define

$$|\vec{P}| \equiv \sum_i P(a=i|X=j), \quad (4)$$

where the right hand side is independent of the choice of j . The notation $|\vec{P}|$ is used throughout and should not be confused with more usual definitions of the norm of a vector.

Suppose that for each type of single system, the fiducial measurements are fixed. A particular theory will

specify, for each type of system, a set of allowed vectors \vec{P} . These correspond to physically possible states of a system, i.e., states that can actually be prepared using one of the preparation devices. There is no reason to suppose that all vectors \vec{P} that can be written down can actually be prepared. For example, in quantum theory, one cannot prepare a system that will with certainty return the outcome spin-up for spin measurements in both the z and x -directions. Call the set of allowed states \mathcal{S} (where there is a different \mathcal{S} for each type of system but we suppress this dependence).

Assumption 2 *For each type of system, the set of allowed normalized states is closed and convex. The complete set of states \mathcal{S} is the convex hull of the set of allowed normalized states and $\vec{0}$.*

$\vec{0}$ is the vector with all entries 0. The idea behind this assumption is that it is always possible to toss a biased coin and subsequently to be interested only in the joint probabilities of getting given measurement outcomes along with heads. In this way one can ‘prepare’ unnormalized states. If heads occurs with probability zero, the state $\vec{0}$ is prepared. Convexity of \mathcal{S} corresponds to the assumption that if it is possible to prepare states P_1 and P_2 , then it is also possible to prepare any probabilistic mixture of the two states. One may toss a coin, prepare either P_1 or P_2 depending on the outcome, and then forget the outcome.¹ Extreme points of \mathcal{S} apart from $\vec{0}$ are *pure states*. States that are neither pure nor $\vec{0}$ are *mixed*. Mixed states can be written as a convex sum of pure states and $\vec{0}$, but this sum need not be unique.

Notice from Eq. (3) that \mathcal{S} lies in a subspace of the complete vector space. In general, we allow for the possibility that \vec{P} is an over-complete description of the state of a system. Thus there may be other linear constraints that apply apart from Eq. (3) implying that \mathcal{S} lies in a smaller subspace still.

When an operation is performed, each outcome is associated with a transformation of the state of the system, i.e., with a map from states to states:

$$\vec{P} \rightarrow \vec{P}' = f(\vec{P}). \quad (5)$$

Some operations have only one outcome and the corresponding transformation preserves normalization of the state (in quantum theory, these are the trace-preserving completely positive maps). If an outcome in general occurs with probability < 1 , then it is associated with a transformation that in general decreases the normalization of the state (in quantum theory, these are trace-decreasing completely positive maps).

Consider a transformation acting on a system that is in a mixed state, that is a state \vec{P} such that

$$\vec{P} = \sum_i q_i \vec{P}_i, \quad (6)$$

where the \vec{P}_i are allowed states and where $0 \leq q_i \leq 1$ and $\sum_i q_i = 1$. One way of preparing a system in such a state would be to prepare a system in the state \vec{P}_i with probability q_i and then to forget the value of i . In this case the transformed \vec{P} must be the same convex combination of the transformed \vec{P}_i , that is

$$f(\vec{P}) = f\left(\sum_i q_i \vec{P}_i\right) = \sum_i q_i f(\vec{P}_i) \quad \forall \vec{P}_i \in \mathcal{S}. \quad (7)$$

It follows from this that the action of f on the set of allowed states \vec{P} can be represented as

$$\vec{P} \rightarrow M.\vec{P}, \quad (8)$$

where M is a matrix, i.e. f is a linear map. This is not completely obvious from Eq.(7), since the equation asserts only convex linearity, and furthermore only applies for those $\vec{P}_i \in \mathcal{S}$. A rigorous proof is given in Appendix A.

An operation corresponds to a set of matrices $\{M_i\}$.² The unnormalized state associated with the i th outcome is $M_i.\vec{P}$, and the probability of the i th outcome is

$$\frac{|M_i.\vec{P}|}{|\vec{P}|}. \quad (9)$$

For each type of system, a particular theory will specify a set of allowed operations. Denote this set \mathcal{O} . An element of \mathcal{O} is a set of transformations $\{M_i\}$, and must be such that the following holds.

Constraint 1

$$0 \leq \frac{|M_i.\vec{P}|}{|\vec{P}|} \leq 1 \quad \forall i, \vec{P} \in \mathcal{S}, \quad (10)$$

$$\sum_i \frac{|M_i.\vec{P}|}{|\vec{P}|} = 1 \quad \forall \vec{P} \in \mathcal{S}, \quad (11)$$

$$M_i.\vec{P} \in \mathcal{S} \quad \forall i, \vec{P} \in \mathcal{S}. \quad (12)$$

A further constraint is that each transformation M_i must result only in allowed states when it acts on a system that is part of a larger multi-partite system (see next section). The following assumption results in some loss of generality but also makes things simpler.

¹ The assumption is also stated in such a manner as to rule out the possibility of an unnormalized state without a corresponding normalized state.

² A note on terminology. I shall continue to use the term *operation* to refer to the experiment with a number of different outcomes corresponding to the set $\{M_i\}$, and the term *transformation* to refer to a single, in general normalization-decreasing, M_i .

Assumption 3 For each type of system, there is a set \mathcal{T} of allowed transformations. A set of transformations $\{M_i\}$ is an element of \mathcal{O} if and only if $M_i \in \mathcal{T} \forall i$, and Eq. (11) is satisfied. The set \mathcal{T} includes the transformation that maps all \vec{P} to $\vec{0}$ and is closed and convex.

With this assumption, once \mathcal{T} is given, a separate specification of \mathcal{O} is not needed. The reasons for convexity are similar to those given for Assumption 2.

As mentioned above, the formalism of operations already includes measurements. Sometimes one is not interested in the state after measurement but only in the probabilities of the different outcomes. In this case it is convenient to associate with an operation $\{M_i\}$ a set of vectors $\{R_i\}$ such that

$$\vec{R}_i \cdot \vec{P} = |M_i \cdot \vec{P}| \quad \forall \vec{P} \in \mathcal{S}. \quad (13)$$

Such a set can always be found. For a normalized \vec{P} , the probability of the i th outcome is then given by $\vec{R}_i \cdot \vec{P}$. It does not matter if the vector \vec{R}_i is not unique - this simply means that different vectors can represent the same measurement outcome. Denote by \mathcal{M} the set of all sets $\{R_i\}$ such that Eq. (13) holds for some $\{M_i\} \in \mathcal{O}$. \mathcal{M} is the set of allowed measurements. Denote by \mathcal{R} the set of allowed measurement vectors, that is, the set of vectors \vec{R} such that $\vec{R} \cdot \vec{P} = |M \cdot \vec{P}| \quad \forall \vec{P} \in \mathcal{S}$, for some $M \in \mathcal{T}$.³ (Notation: \mathcal{R} should not be confused with \mathbb{R} , the set of real numbers.)

B. Multi-partite systems

So far, the framework described is similar to that used by Hardy as a starting point for his derivation of quantum theory (although I have been more explicit about treating transformations and measurements in a unified manner). Hardy narrows things down with various axioms. Rather than adopt any of Hardy's axioms, however, I introduce a small number of non-trivial assumptions that concern how systems combine to make multi-partite systems. One reason for this is that most questions of information processing do not make sense without some notion of systems being composed of separate subsystems. From these assumptions I derive that systems combine according to a *tensor product rule*. This is of independent interest since it sheds light on where this rule comes from in quantum theory.

³ Recall that in quantum theory, an effect E is a positive operator such that $0 \leq E \leq 1$. \vec{R} vectors are essentially a generalization of the effects to our framework. In the usual quantum formalism, an effect can represent a yes/no measurement on a quantum state ρ , with the probability of the yes outcome given by $\text{Tr}(E\rho)$. A set of effects E_i such that $\sum_i E_i = I$, where I is the identity, is a positive operator-valued (POV) decomposition of the identity, and corresponds to a POV measurement.

From hereon, the notion of a *type* of system is broadened. Thus multi-partite systems can come in different types, where a particular type of multi-partite system is composed of n_A single systems of type A , n_B single systems of type B , and so on. In all of this section, a system A or B refers to a system of some specific type, that may itself be a composite system.

Begin with the idea that, given a system A , it is possible to identify some operations as *operations on system A alone* and that, in particular, the fiducial measurements for system A are operations on system A alone. (Without this, one might say that we have no business speaking of separate systems in the first place.)

Assumption 4 *Local Operations Commute.* Consider a joint system composed of systems A and B . Suppose that an operation is performed on system A alone with outcome o_A and an operation on system B alone with outcome o_B . The final unnormalized state of the joint system does not depend on the order in which the operations were performed. In particular, this implies that the joint probability of getting outcomes o_A and o_B does not depend on the ordering of the operations.

This assumption means that operations can be regarded as performed simultaneously on systems A and B without ambiguity. It also implies

Corollary 1 *The No-Signalling Principle.* If an operation is performed on system A , it is not possible to get information about which operation was performed by measuring system B .

The proof of the corollary should be obvious. Suppose that an operation is performed on system A first, followed by an operation on system B . Whichever operation was performed on system A , the marginal probability of outcome o_B is equal to the probability of o_B in the case that the operation on system B came first. The probability of o_B is thus independent of the operation on system A .

Assumption 5 *The Global State Assumption.* The global state of a multi-partite system can be completely determined by specifying joint probabilities of outcomes for fiducial measurements performed simultaneously on each subsystem.

Note that while the global state assumption is satisfied in quantum theory and in classical probability theory, it need not be satisfied in an arbitrary theory. For example, it is not true in the case of quantum theory defined over a real Hilbert space [32, 33, 34]. So this assumption has significant content.⁴

⁴ Arguably, this is not the case for the assumption that local operations commute, which may be regarded as part of the definition of what we mean by an operation being on system A alone. Not wishing to be dogmatic on this point, I have listed this prin-

It follows from these two assumptions that the global state of a multi-partite system can be written in the form of a vector of joint probabilities. For example, for a bipartite system AB , it will look like this:

$$\vec{P}^{AB} \equiv \begin{pmatrix} P(a=0, b=0|X=0, Y=0) \\ P(a=0, b=1|X=0, Y=0) \\ \vdots \\ \hline P(a=0, b=0|X=0, Y=1) \\ P(a=0, b=1|X=0, Y=1) \\ \vdots \\ \hline \vdots \end{pmatrix}. \quad (14)$$

$P(a=i, b=j|X=k, Y=l)$ is the joint probability of getting outcomes i and j when fiducial measurements k and l are performed on the two subsystems. The no-signalling principle implies

$$\begin{aligned} \sum_j P(a=i, b=j|X=k, Y=l) &= \\ \sum_{j'} P(a=i, b=j'|X=k, Y=l') &\quad \forall i, k, l, l', \end{aligned} \quad (15)$$

$$\begin{aligned} \sum_i P(a=i, b=j|X=k, Y=l) &= \\ \sum_{i'} P(a=i', b=j|X=k', Y=l) &\quad \forall j, k, k', l. \end{aligned} \quad (16)$$

The *reduced state* for system A (analogous to the reduced state in quantum theory, or marginal probabilities in classical probability theory) is given by

$$\vec{P}^A = \begin{pmatrix} P(a=0|X=0) \\ P(a=1|X=0) \\ \vdots \\ \hline P(a=0|X=1) \\ P(a=1|X=1) \\ \vdots \\ \hline \vdots \end{pmatrix}, \quad (17)$$

principle with the other assumptions. We should distinguish, however, the implied no-signalling principle from *the impossibility of super-luminal signalling*, which is a contingent fact that as far as we know is true in our universe. To see the difference, consider that in the non-relativistic quantum mechanics of particles, the no-signalling principle is valid, yet super-luminal signalling is possible. In the present framework, the impossibility of superluminal signalling would imply an upper bound on the velocity of systems and that Alice cannot carry out an operation on Bob's system if she is spacelike separated from it. But I shall not use such notions, or indeed any notion of spacetime structure.

where

$$P(a=i|X=j) = \sum_{i'} P(a=i, b=i'|X=j, Y=j'). \quad (18)$$

Here, a and X are the outcome and fiducial measurement for the system whose reduced state is defined, and b and Y are the outcome and fiducial measurement for the other system. The no-signalling conditions of Eqs. (15), (16) ensure that the sum on the right is independent of the choice of j' .

As seen in the last section, a particular theory specifies a set \mathcal{S} of allowed states for each type of system. This applies also for each type of multi-partite system. There is, however, a constraint.

Constraint 2 Suppose that $\vec{P}^{AB} \in \mathcal{S}^{AB}$, where \mathcal{S}^{AB} is the set of allowed states for the joint system. Suppose that \vec{P}^A is the reduced state for system A corresponding to \vec{P}^{AB} . Then $\vec{P}^A \in \mathcal{S}^A$, where \mathcal{S}^A is the set of allowed states for system A .

That systems combine according to a tensor product rule is asserted by the following three theorems. Proofs are in Appendix B.

Theorem 1 Suppose that $\vec{P}^{AB} \in V^{AB}$, $\vec{P}^A \in V^A$, and $\vec{P}^B \in V^B$. Then one can identify

$$V^{AB} = V^A \otimes V^B.$$

Theorem 2 Any $\vec{P}^{AB} \in \mathcal{S}^{AB}$ can be written

$$\vec{P}^{AB} = \sum_i r_i \vec{P}_i^A \otimes \vec{P}_i^B, \quad (19)$$

with $\vec{P}_i^A \in \mathcal{S}^A$ and $\vec{P}_i^B \in \mathcal{S}^B$. Both \vec{P}_i^A and \vec{P}_i^B can be taken to be normalized and pure.

Theorem 3 Consider a transformation on system A alone defined by

$$\vec{P}^A \rightarrow \vec{P}^{A'} = M^A \cdot \vec{P}^A.$$

The transformation of the joint system is given by

$$\vec{P}^{AB} \rightarrow \vec{P}^{AB'} = (M^A \otimes I) \cdot \vec{P}^{AB}.$$

Recall that transformations include probabilistic transformations that decrease the normalization of the state. Thus an immediate corollary of Theorem 3 is

Corollary 2 If a measurement is performed on system A alone, with state \vec{P}^A , the probability of a particular outcome is given by

$$\vec{R} \cdot \vec{P}^A = (\vec{R} \otimes \vec{I}) \cdot \vec{P}^{AB}. \quad (20)$$

Here, \vec{I} is a vector representing the identity measurement, that is $\vec{I} \cdot \vec{P}^B = |\vec{P}^B| \forall \vec{P}^B \in \mathcal{S}^B$. The way things are set up, \vec{I} is not unique but can always be taken to be $(1, \dots, 1|0, \dots, 0|0, \dots, 0|\dots)$.

Much follows from these theorems and corollary.

Collapsed states. Suppose that an operation is performed on a system A in a state \vec{P}^A . Suppose that the operation has outcomes i such that the final normalized state conditioned on outcome i is given by $\vec{P}_i^A \equiv M_i \vec{P}^A / |M_i \vec{P}^A|$. The change in the state of system A is analogous to the quantum mechanical collapse of the state vector. If systems A and B begin in some joint state \vec{P}^{AB} , and a measurement is performed on system A , then the final state of system B , conditioned on a particular outcome for the measurement, is also unambiguously determined. Thus this “collapse” is also well-defined “at a distance”. Typically, similar questions of interpretation arise in theories in this framework as do in quantum theory. Is this collapse a real process? A change in Alice’s knowledge following her measurement? And so on.

Entanglement and nonlocality. In Theorem 2, a joint state of a system AB is written as a linear sum of direct product states. Note that the theorem does not assert that a joint state of AB can be written as a convex combination of direct product states. In general, there will be joint states that cannot be written in this form. These are the *entangled* states of the theory. Entanglement is distinct from nonlocality, where the latter means violation of a Bell inequality. Thus i) there are theories such as classical theories that have no entanglement or nonlocality, ii) there may be theories that have entanglement but no nonlocality, and iii) there are theories such as quantum theory and GNST developed below that have both entanglement and nonlocality, although these may not coincide (they do in GNST but in quantum theory there are entangled mixed states that are local [35, 36]).

Multi-partite systems. The state of a multi-partite system can be written as a vector $\vec{P}^{AB\dots Z} \in V_A \otimes V_B \otimes \dots \otimes V_Z$. This vector can be written as a linear sum of direct product states $\sum_i r_i \vec{P}_i^A \otimes \vec{P}_i^B \otimes \dots \otimes \vec{P}_i^Z$, with $r_i \in \mathbb{R}$, $\vec{P}^A \in \mathcal{S}^A$, and so on. A transformation on system A alone takes the form $M \otimes I \otimes \dots \otimes I$, and similarly for transformations on B, \dots, Z alone. These extensions of the above theorems follow, since those theorems were stated for arbitrary bipartite systems AB and included the fact that A and B may themselves be composite.

Finally, recall that a theory, in addition to specifying the set \mathcal{S} of allowed states for each type of system, must also specify the set \mathcal{T} of allowed transformations.

Definition 1 *A transformation on system A is well-defined if $(M_i^A \otimes I) \cdot \vec{P}^{AB} \in \mathcal{S}^{AB}$ whenever $\vec{P}^{AB} \in \mathcal{S}^{AB}$, for all types of system B .*

This definition corresponds to the fact that in quantum theory, allowed transformations must be completely positive maps (and not, e.g., merely positive maps). An obvious constraint is

Constraint 3 *For each type of system, all transformations $\in \mathcal{T}$ must be well-defined.*

A natural assumption is

Assumption 6 *If $\vec{P}^A \in \mathcal{S}^A$ and $\vec{P}^B \in \mathcal{S}^B$, then $\vec{P}^A \otimes \vec{P}^B \in \mathcal{S}^{AB}$.*

A final assumption that is convenient is

Assumption 7 *A theory first specifies a set \mathcal{S} of allowed states for each type of system. All transformations that are well-defined are then allowed transformations.*

This assumption is indeed satisfied by all the theories considered below, including classical theories, quantum theory, generalized non-signalling theory, and generalized local theory. It is nice because it means that a theory is completely specified once the allowed types of system are specified, along with the set \mathcal{S} of allowed states for each type. In this case, Assumption 7 defines the set \mathcal{T} . The way things are set up, each of the sets \mathcal{O} , \mathcal{M} and \mathcal{R} is in turn defined by \mathcal{T} . Assumption 7 also ensures that certain other obvious constraints hold that do not then need to be stated separately. For example, it implies that if $M \in \mathcal{T}$ and $N \in \mathcal{T}$, then $M.N \in \mathcal{T}$. Along with Constraint 3, it implies that if $M^A \in \mathcal{T}^A$, then $M^A \otimes I^B \in \mathcal{T}^{AB}$. Finally, Assumption 7, along with Assumption 6 and Constraint 2, implies that if a procedure consists in introducing an ancilla to system A , performing some joint transformation on A and ancilla and then throwing away the ancilla, then the corresponding transformation on A alone is $\in \mathcal{T}^A$.

The fact that transformations have to be well-defined yields one of the main insights of this work. There is a rich interplay between the set of allowed states, the allowed dynamics, and the information processing possibilities that a theory offers. For example, if a theory is modified by enlarging the set of allowed states (adding super-correlated states to quantum theory, perhaps), one might naively think that this must increase the information processing possibilities. However, enlarging the set of allowed states may well have the effect of decreasing the set of allowed transformations, in which case the effect may well be the opposite.

III. A BRIEF NOTE ON AMBIGUITIES

There are a couple of points that deserve a mention here in case it be thought that they cause problems (this section may perhaps be omitted on a first reading). First, two theories may be identical in their structure, that is the sets \mathcal{S} , \mathcal{T} , \mathcal{O} , \mathcal{R} and \mathcal{M} of allowed states, transformations, operations, outcomes and measurements, could be mathematically identical in each theory, yet the theories be different physically because the mathematical objects are assigned to different physical objects. For example, a particular preparation device could be associated with one state in one theory and another state in the other theory.

Second, one theory could be made to look different, that is have different sets \mathcal{S} , \mathcal{T} , \mathcal{O} , \mathcal{R} and \mathcal{M} , simply because different measurement devices are chosen to correspond to fiducial measurements. Thus in quantum theory

the state of a qubit could be specified by the probabilities for the outcomes of spin measurements in the x , y and z directions. The set \mathcal{S} is then a sphere. Equally, the quantum state could be specified by the probabilities for measurements in the x , y and n directions, where $\vec{n} = 1/\sqrt{2}(\vec{x} + \vec{z})$. In this case, the set \mathcal{S} is a non-spherical ellipsoid. A fiducial set may even have different numbers of measurements and outcomes. For example, any quantum state can be expressed by giving the probabilities of the outcomes for a single, informationally complete POV measurement [16]. The important thing is that the outcomes of the fiducial measurements in the new formulation are represented by linearly independent vectors in the old formulation. Thus there is an invertible matrix N such that the two formulations are related by $\vec{P}' = N.\vec{P}$, $\vec{R}'^T = \vec{R}^T.N^{-1}$, and $M' = N.M.N^{-1}$. The theory makes the same predictions since $\vec{R}'.\vec{P}' = \vec{R}.\vec{P}$, and so on.

The first of these points means that in order to compare the predictions of two theories, one has to know which physical devices different preparations and operations correspond to. But being primarily interested in the information processing properties of theories, we can ignore this issue and concentrate on the structure of the theories. The second point ensures that we can do this unambiguously. The structure of a theory and the conclusions drawn for information processing do not depend on which measurements are chosen for the fiducial set.

IV. SOME DIFFERENT THEORIES

It is useful to see examples of theories that can be described in this framework. The most important are classical theories and quantum theory. Two others are GLT and GNST. All of these theories satisfy Assumption 7, which means that each is completely determined by the set \mathcal{S} of allowed states for each type of system.

A. Classical theories

Suppose that for some particular type of system, the fiducial set can be chosen as a single measurement with d outcomes, and that any (possibly sub-normalized) probability distribution over these outcomes corresponds to a (possibly sub-normalized) allowed state. In this case, the system is *classical*. A classical theory is one for which all systems are classical. The most comprehensive classical theory is the one for which there is a type of system for every $d \geq 1$. For a classical system, \mathcal{S} is a simplex. Pure states are represented by vectors \vec{e}_i , with a 1 for the i th component and 0s elsewhere. The state of a bipartite system of two classical systems is also represented by a vector from a probability simplex, the entries being the joint probabilities for outcomes i and j when the fiducial measurement is performed on each system. An allowed transformation M must map a pure state \vec{e}_i to another

allowed state. It is easy to show that each entry of M must be positive, and the sum of each column must be ≥ 0 and ≤ 1 . In the case that M preserves normalization, it is a stochastic matrix. The set \mathcal{R} is a hypercube.

Consider, for example, an ordinary die which can exist in six different deterministic states. The \vec{P} vector is six dimensional and gives the probabilities that the die's uppermost face is 1, 2, ..., 6. An example of a measurement is one that asks, is the uppermost face 1 or 2? The yes outcome corresponds to the vector $\vec{R} = (1, 1, 0, 0, 0, 0)$. The state of two dice, A and B , can be written as a 36-dimensional vector, whose entries are the probabilities for the uppermost faces being 11, 12, ..., 66.

Suppose that the reduced states of the two dice are given by $\vec{P}^A = \vec{P}^B = 1/6(1, 1, 1, 1, 1, 1)$. One possible joint state compatible with \vec{P}^A and \vec{P}^B is a direct product

$$\begin{aligned} \vec{P}^{AB} &= \vec{P}^A \otimes \vec{P}^B \\ &= \frac{1}{36} \begin{pmatrix} 1 \\ 1 \\ \vdots \\ 1 \end{pmatrix}. \end{aligned}$$

This corresponds to the two dice being uncorrelated. But another possible joint state with the same reduced states is

$$\vec{P}_{ij}^{AB} = \begin{cases} 1/6 & i = j, \\ 0 & \text{otherwise.} \end{cases}$$

This corresponds to perfect correlation and obviously cannot be written as a direct product. Of course there is no entanglement or nonlocality in this theory.⁵

B. Quantum Theory (in finite dimensions)

Quantum theory only allows certain types of system. For example, there are no systems that can be described with two fiducial measurements each with two outcomes. A qubit can be described by three fiducial measurements

⁵ There is nothing difficult in the preceding remarks. But part of the aim of Section IIB is to deflate the significance of the tensor product rule for combining systems in quantum theory. Thus it is useful to note that a similar rule arises quite naturally in what is essentially classical probability theory. The quantum tensor product rule does not have to be regarded, as it frequently is, as a mysterious replacement for the Cartesian product used in combining deterministic classical states. If quantum states (even pure ones) are more analogous to probabilistic classical states than anything else - in other words if some version of the *epistemic interpretation* of the quantum state is correct - then a tensor product rule is exactly what one would expect. Thus one way of viewing the tensor product is as evidence for the epistemic interpretation.

with two outcomes, e.g., spin measurements in the x , y and z directions. Once a set of fiducial measurements is chosen quantum theory tells us what the allowed states \vec{P} are. In the simple case of a qubit, the set of normalized states is the Bloch sphere. In the case of higher dimensional quantum systems it does not appear to be so easily characterized (except via the usual quantum formalism of course). The transformations that are well-defined, in the sense of Definition 1, correspond precisely to the linear completely positive maps. It is usually assumed that any such map corresponds to a physically possible operation, thus Assumption 7 is satisfied. Any set of \vec{R}_i with $0 \leq \vec{R}_i \cdot \vec{P} \leq 1 \forall i \forall \vec{P} \in \mathcal{S}$ and $\sum_i \vec{R}_i \cdot \vec{P} = 1 \forall \vec{P} \in \mathcal{S}$ is a positive operator-valued measurement in the usual formalism.

There is nothing new in the fact that quantum states can be represented as real vectors and transformations as matrices acting on these vectors. It is well known that Hermitian operators in d dimensions form a d^2 -dimensional real vector space, with a dot product given by $\text{Tr}(AB)$. Linear completely positive maps correspond to $d^2 \times d^2$ matrices acting on this space. But the present framework does not correspond exactly to this representation (e.g., it is possible that $\vec{P} \cdot \vec{P} > 1$), so it is useful to see an example. A qubit whose state is spin up in the z -direction can be written

$$\vec{P} = \begin{pmatrix} \frac{P(\uparrow|x)}{P(\downarrow|x)} \\ \frac{P(\uparrow|y)}{P(\downarrow|y)} \\ \frac{P(\uparrow|z)}{P(\downarrow|z)} \end{pmatrix} = \begin{pmatrix} 1/2 \\ 1/2 \\ 1 \\ 0 \end{pmatrix},$$

where $P(\uparrow|x)$ is the probability of obtaining spin up when measuring in the x direction, and so on. It can now be verified that if, for example, spin is measured in the n -direction, where $\vec{n} = 1/\sqrt{2}(\vec{x} + \vec{z})$, then the up outcome corresponds to the vector

$$\vec{R} = \left(\frac{1}{2\sqrt{2}}, \frac{-1}{2\sqrt{2}} \middle| \frac{1}{2}, \frac{1}{2} \middle| \frac{1}{\sqrt{2}}, \frac{-1}{\sqrt{2}} \right).$$

This vector is not unique. Any vector $\vec{R}' = \vec{R} + \vec{C}$, where $\vec{C} \cdot \vec{P} = 0 \forall \vec{P} \in \mathcal{S}$, represents the same measurement outcome. The unitary transformation usually written as the Pauli matrix σ_z would correspond to

$$M = \left(\begin{array}{cc|cc|cc} 0 & 1 & 0 & 0 & 0 & 0 \\ 1 & 0 & 0 & 0 & 0 & 0 \\ \hline 0 & 0 & 0 & 1 & 0 & 0 \\ 0 & 0 & 1 & 0 & 0 & 0 \\ \hline 0 & 0 & 0 & 0 & 1 & 0 \\ 0 & 0 & 0 & 0 & 0 & 1 \end{array} \right).$$

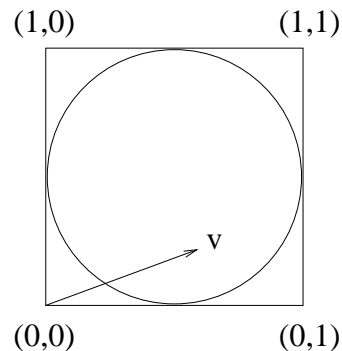

FIG. 1: The space of normalized states for a gbit in GNST corresponds to the square. If the measurements $X = 0$ and $X = 1$ are associated with spin measurements in the z and x directions, then the space of states for a quantum mechanical qubit corresponds to the circle.

C. Generalized Non-Signalling Theory

Suppose that for any pair $n, k > 1$, there is a corresponding type of single system, whose state can be described by a set of n fiducial measurements, each with k outcomes. Call this an (n, k) system.⁶ For a single system, allow any state \vec{P} , provided the entries of \vec{P} are between 0 and 1 and Eq. (3) is satisfied. For multi-partite systems, allow any state \vec{P} , provided entries are between 0 and 1, Eq. (3) is satisfied, and the no-signalling conditions of Eqs. (15),(16) are satisfied for all bipartite splittings. The resulting theory is Generalized Non-Signalling Theory.

It is useful to see some examples of systems in this theory. The simplest kind of single system has two binary fiducial measurements. This type of system plays a role somewhat analogous to that of a classical bit or a qubit, so from hereon it is called a *gbit* (for generalized bit). The space of possible normalized states is shown in Fig. 1. There are four pure states, which correspond to the four ways of assigning definite outcomes to the $X = 0$ and $X = 1$ fiducial measurements. In the figure, these are represented by $(0, 0)$, $(0, 1)$, $(1, 0)$, and $(1, 1)$, where $(0, 1)$, for example, is the state which returns $a = 0$ for the $X = 0$ measurement and $a = 1$ for the $X = 1$ measurement, and is also represented by $\vec{P} = (1, 0|0, 1)$. Thus pure states of single systems have a definite outcome for each fiducial measurement - there is no uncertainty principle. As noted in the figure, if the measurements $X = 0$ and $X = 1$ are associated with spin measurements in the z and x directions, then we can include possible states of

⁶ A more general theory would include further types of system with different numbers of outcomes for different fiducial measurements. I ignore this possibility. I do not believe that it would change much beyond introducing uninteresting complications into some of the proofs.

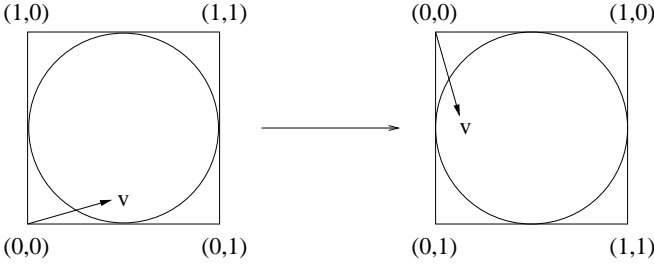

FIG. 2: An allowed transformation.

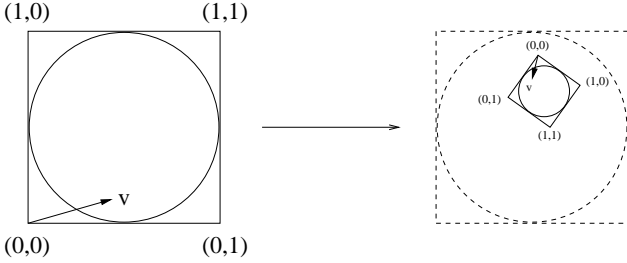

FIG. 3: Another allowed transformation.

a qubit in the diagram, and these form a circle inscribed in the square. Qubits of course have an extra degree of freedom, namely spin in the y direction. For $(3, 2)$ systems the space of states is a cube, with an inscribed sphere (the Bloch sphere) representing quantum states.

Consider the possible transformations of a qbit (for simplicity, restrict attention to those that preserve normalization). An allowed transformation will transform the square in such a manner that all points remain in the square, otherwise the transformation is not well-defined in the sense of Definition 1. The transformations of Figs. 2 and 3 are allowed. But the transformation of Fig. 4 is not allowed. Transformations in quantum theory are less restricted because the requirement is only that points in the circle are transformed into points in the circle. So a rotation of $\pi/4$, as in Fig. 4, is fine, and indeed corresponds to the well known $\pi/8$ gate.

It begins to look as if the dynamics of single systems in GNST is rather simple. Indeed, this is the case. Section VI contains a theorem that states that for single systems in GNST, allowed transformations correspond essentially to relabellings of measurements and outcomes,

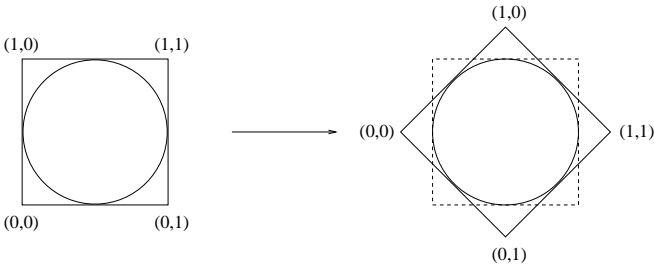

FIG. 4: A forbidden transformation.

and probabilistic combinations thereof. Thus in a sense, the dynamics is classical. Despite this, the dynamics does contain possibilities that quantum dynamics does not. Consider a $(3, 2)$ system, whose space of normalized states is a cube, with the quantum Bloch sphere inscribed. A possible transformation is a reflection in the center of the sphere. This corresponds to the so called Universal NOT gate of quantum theory, which is not an allowed transformation since it is not completely positive.

The multi-partite states of GNST are noteworthy in that they include states that are more non-local than quantum theory allows. For example, given a bipartite system of two qbits, the following is a possible state.

$$XY = \left. \begin{array}{l} 00 \\ 01 \\ 10 \end{array} \right\} \rightarrow P(a = 0, b = 0|XY) = \tag{21}$$

$$P(a = 1, b = 1|XY) = 1/2,$$

$$XY = 11 \rightarrow P(a = 0, b = 1|XY) = P(a = 1, b = 0|XY) = 1/2. \tag{22}$$

The correlations obtained from fiducial measurements on this state return a value of 4 for the left hand side of the following inequality

$$P(a = b|00) + P(a = b|01) + P(a = b|10) + P(a \neq b|11) \leq 3 \tag{23}$$

(this is the CHSH inequality [37] written in a slightly different form than usual). These correlations cannot be obtained from measurements on any quantum state since by Tsirelson's theorem [38], quantum states can only reach a maximum of $2 + \sqrt{2}$.⁷

Information processing in GNST is discussed in Section VII. The theory's permissiveness with respect to states implies that some things can be achieved that are impossible in quantum theory. These include 1-2 oblivious transfer, van Dam's scheme for the easy solution of communication complexity problems [26], and a kind of super-quantum memory. The restricted nature of the dynamics, however, implies that there is no teleportation or super-dense coding. The theorems of Section VI give evidence that computation is no better than classical.

D. Generalized Local Theory

Suppose that, as in GNST, for any pair $n, k > 1$, there is a corresponding type of system, whose state can be defined with n fiducial measurements with k outcomes. As

⁷ These non-signalling super-quantum correlations were written down by Khalil and Tsirelson [17], and were independently introduced by Popescu and Rohrlich [18]. Other examples of super-quantum correlations, involving more measurements or parties, are given in Ref. [19]. The latter are also allowed in GNST.

in GNST, all \vec{P} with entries between 0 and 1 satisfying Eq. (3) are allowed states. The only multi-partite states allowed, however, are those for which the fiducial measurements return local (non-Bell-violating) correlations. This defines Generalized Local Theory.

As in GNST, the pure states of single systems in this theory are those that have a deterministic outcome for each fiducial measurement. Since multi-partite states are local with respect to fiducial measurements, the pure states of a multi-partite system are precisely those in which each subsystem is in a deterministic pure state. An arbitrary state of a multi-partite system is a convex mixture of these. It follows that no state in this theory can violate a Bell inequality, even if non-fiducial measurements are performed. Hence the name.

GLT is more general than quantum theory in allowing arbitrary single system states, but more restricted in not allowing non-local states. As described in Section VII, GLT allows 1-2 oblivious transfer. Computation in GLT, however, is easily simulable by a classical computer.

E. Other possibilities

There are other possibilities that would be interesting to investigate. For example,

1. A theory that is essentially quantum theory but with only separable states allowed.
2. A theory in which the state of a single system must be a quantum state, but in which the state of a multi-partite system can be anything, as long as the no-signalling principle and the restriction that the reduced states for the individual subsystems must be quantum are satisfied. The latter idea has been investigated in Ref. [39], where it is shown, amongst other things, that Tsirelson's theorem still holds.

V. GENERIC PROPERTIES OF THEORIES

One of the reasons for introducing a framework encompassing many different theories is that it is interesting to identify properties of theories that are generic, in the sense that they are shared by all or most theories in the framework. It turns out that unambiguous state discrimination is possible in any theory, implying a weak form of cloning. Other features, usually thought of as specifically quantum, are present in all theories in our framework except theories that are classical (in the sense of Section IV A). Thus classical theories are very special! These features include the fact that mixed states do not always have a unique decomposition into pure states, disturbance of a system on measurement, and a no-go theorem for universal cloning. More exact statements of these claims are given in this section. Proofs are in Appendix C. It is tedious to write always *all theories*

in the framework, so from hereon this is shortened to *all theories*, taking the assumptions of Section II as read.

Theorem 4 *Suppose that for a particular type of system, every mixed state has a unique decomposition into pure states and $\vec{0}$. Then the system is classical.*

The next theorem concerns the disturbance of systems on measurement. First,

Definition 2 *A transformation is trivial if the corresponding matrix M can be chosen proportional to the identity.*

A trivial measurement can be thought of as an operation $\{M_i\}$ with each M_i trivial. Such a measurement has outcome probabilities that are independent of the state of the system. An example of such an operation would be to toss a coin, without interacting with the system at all, and to output the result. Now, say that a transformation *disturbs* a state \vec{P} if there is no constant c such that $M.\vec{P} = c\vec{P}$. This means that, conditioning on the outcome corresponding to this transformation, the state is no longer \vec{P} .

Theorem 5 *With the exception of classical systems, all non-trivial transformations disturb at least one pure state.*

Note that the theorem applies to *all* non-trivial transformations. Even classically, one may of course perform measurements that disturb if one wants. The point is that in a classical theory, there does exist a non-trivial, non-disturbing measurement.

Theorem 6 *In any theory, for any pair of pure states, it is possible to discriminate the two states unambiguously.*

This means that for two pure states \vec{P}_1 and \vec{P}_2 , there is a three-outcome measurement that can be performed such that the following holds: outcome 1 indicates that the state was definitely \vec{P}_1 , outcome 2 indicates definitely \vec{P}_2 , and outcome 3 is inconclusive. If the state is \vec{P}_1 then there is a non-zero probability of getting outcome 1 and if the state is \vec{P}_2 there is non-zero probability of getting outcome 2. For the quantum version of this problem, see Ref. [40] and references therein.

Theorems 5 and 6 have implications for cloning. Cloning refers to the following procedure:

1. Begin with a system A in a pure state. Denote its state \vec{P} .
2. Introduce a system B of the same type, prepared in a standard state \vec{Q} . The state of the joint system is $\vec{P} \otimes \vec{Q}$.
3. A joint transformation M acts on the pair of systems such that the final state is $(M)(\vec{P} \otimes \vec{Q}) \propto \vec{P} \otimes \vec{P}$.

Different types of cloning result can be imagined. In a given theory, any of the following may be true.

1. There is a *deterministic universal cloning procedure*. This type of cloning always succeeds and works on all pure states. It implies the existence of a normalization preserving M and a state \vec{Q} such that $(M)(\vec{P} \otimes \vec{Q}) = \vec{P} \otimes \vec{P}$ for all pure \vec{P} .
2. There is a *probabilistic universal cloning procedure*. This type of cloning procedure is allowed to output a fail outcome, but conditioned on success, the final state must be $\vec{P} \otimes \vec{P}$. It may even fail all of the time for some states, as long as it does not fail all the time on all states. It implies the existence of a non-zero M such that $(M)(\vec{P} \otimes \vec{Q}) \propto \vec{P} \otimes \vec{P}$ for all pure states \vec{P} .
3. For any pair of pure states, there is a deterministic cloning procedure for that pair. This implies that for each pair of pure states, \vec{P}_1 and \vec{P}_2 , there is an M and a \vec{Q} such that $(M)(\vec{P}_i \otimes \vec{Q}) = \vec{P}_i \otimes \vec{P}_i$, for $i = 1, 2$.
4. For any pair of pure states, \vec{P}_1 and \vec{P}_2 , there is a probabilistic cloning procedure for that pair. This type of procedure is allowed to output a fail outcome some of the time, but must succeed with non-zero probability for each of \vec{P}_1 and \vec{P}_2 . It implies that for each pair of pure states, there is a \vec{Q} and a non-zero M such that $(M)(\vec{P}_i \otimes \vec{Q}) \propto \vec{P}_i \otimes \vec{P}_i$ for $i = 1, 2$.

The following is a corollary of Theorem 6.

Theorem 7 *In any theory, there is a probabilistic cloning procedure for any pair of pure states.*

Note that there is a deterministic cloning procedure for any pair of pure states in a classical theory, and in GLT, but not in quantum theory (I leave the question open for GNST). Finally,

Theorem 8 *With the exception of classical systems, there is no probabilistic universal cloning procedure.*

This of course implies that with the exception of classical systems, there is no deterministic universal cloning procedure.

Theorems 4, 5 and 8 apply even to classical theories if extended to mixed states. Thus there are mixed states with a non-unique decomposition into mixed states. All non-trivial transformations disturb at least one mixed state.⁸ And cloning of classical mixed states is impossible.⁹ One possible interpretation of these remarks is as

⁸ This is not at all surprising if put into more prosaic terms. Consider that a die is in a state such that the probability of each face being uppermost is $1/6$. Suppose that the die is measured,

further evidence that quantum pure states are more akin to classical mixed states than classical pure states.

There are many other questions concerning properties that are common to all theories, or all except classical theories. It is shown elsewhere that all theories in the framework have an infinite de Finetti theorem [41], and that polynomially-sized computations in these theories can be simulated classically in polynomial space [42]. Features such as these can be regarded as arising solely from the assumptions that were made in setting up the framework. Other questions remain open. In which theories, for example, does a no-broadcasting theorem hold?

VI. DYNAMICS IN GNST AND GLT

Part of the motivation of this work is to consider which features of a theory, in particular those features related to information processing, arise from which assumptions. It is particularly interesting if significant features, such as the no-cloning theorem above, arise from very minimal assumptions and are thus shared by a broad class of theories. Another part of the motivation is to investigate theories that are different from those we already know about. These theories need not even be empirically adequate; a compare and contrast exercise will still be useful to learn more about those theories that *are* empirically

to find out which face is uppermost, and the value 1 found. Then, if it is assumed that the measurement operation was done in the most obvious way, the state after measurement is not $1/6(1, 1, 1, 1, 1, 1)$, but $(1, 0, 0, 0, 0, 0)$. Of course the measurement operation may be such that the die is recast after the outcome is obtained, resulting in a final state of $1/6(1, 1, 1, 1, 1, 1)$. But then an initial state of $(1, 0, 0, 0, 0, 0)$ would be disturbed. It is sometimes suggested that the change in a quantum state on measurement is *nothing other* than this kind of classical updating of knowledge, and that all the mystery of the projection postulate is thus removed. However, this cannot be the whole story. Consider a spin-1/2 particle in a spin-up- z state. It is known for certain that a measurement of z -spin will return the up outcome. Suppose that a measurement of x -spin is performed, and the up outcome obtained, such that the final state is spin-up- x . Now, if z -spin is measured, then half the time, the down outcome is obtained. The conclusion is that on those occasions when such an experiment is performed, at least half the time, the system is disturbed in a manner that cannot be accounted for by mere updating of classical knowledge.

⁹ Suppose that Alice prepares a die in one of two ways, each corresponding to a probability distribution over the different faces. The first prepares, say, the state $1/12(6, 2, 1, 1, 1, 1)$ and the second the state $1/6(1, 1, 1, 1, 1, 1)$. The die is given to Bob who is required to perform a cloning operation. This means that Bob must prepare another die such that if Alice used the first preparation, its state is $1/12(6, 2, 1, 1, 1, 1)$, and if she used the second, then $1/6(1, 1, 1, 1, 1, 1)$. Furthermore, if the dice are measured after Bob's operation, the results *must not be correlated*. This last clause prevents Bob from using a device that simply reads the uppermost face of the die and prepares another in the same state. It is easy to see that even if Bob's cloning procedure is allowed to be probabilistic, he cannot do it.

adequate. Thus the next two sections are devoted to a detailed investigation of GNST and GLT.

In Section IV C the dynamics of a gbit was briefly discussed. There are four pure states of a gbit, corresponding to the four ways of assigning definite outcomes, 0 and 1, to the two measurements. The space of normalized states is a square, with a normalization preserving transformation being a linear transformation of this square. Let us consider more general types of system in GNST and GLT, but continue to focus on normalized systems and normalization preserving transformations, i.e., operations corresponding to a single matrix, $\{M\}$. For this section and the next, *transformation* means *normalization preserving transformation*, with the investigation of probabilistic transformations left for future work.

The space of states of an (n, k) system is a polytope, the vertices corresponding to pure states. Pure states are of the form

$$\vec{P} = (0 \dots 1 \dots 0 | 0 \dots 1 \dots 0 | \dots).$$

Allowed transformations must take points in the polytope to points in the polytope. This condition is so restrictive that the following theorem holds.

Theorem 9 *Transformations of single systems in GNST or GLT are simple, corresponding essentially to relabellings of the measurements and outcomes, and convex combinations thereof. This means that an allowed transformation, thought of as active, can always be represented as a passive transformation that simply appends classical circuits to the system, as shown in Fig. 5, or as a convex combination of such.*

This implies

Corollary 3 *Measurements on single systems in GNST or GLT are simple, corresponding to procedures of the form of that shown in Fig. 6, or convex combinations thereof.*

The proofs of Theorem 9 and Corollary 3 are contained in Appendix D.

In the case of GNST, a similar theorem holds for transformations on bipartite systems of two gbits.

Theorem 10 *In GNST, transformations on bipartite systems of two gbits are classical, in the sense that they can always be represented as a passive transformation that simply appends classical circuits in the manner described in Fig. 7, or as a convex combination of such.*

Corollary 4 *In GNST, measurements on bipartite systems comprised of two gbits are classical, corresponding to procedures of the form of that shown in Fig. 8, and convex combinations thereof.*

The proof of Theorem 10 is also given in Appendix D. It is an open question whether transformations and measurements on arbitrary multi-partite systems in GNST

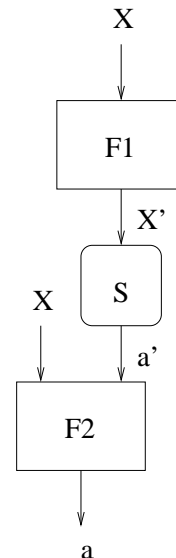

FIG. 5: Transformations of single systems in GNST and GLT can always be represented as the appending of classical circuits as shown here, or as convex combinations of transformations of this type. If a fiducial measurement X is performed on the transformed system, this can be thought of as performing fiducial measurement X' on the original system, where $X' = F1(X)$ for some function $F1$. When measurement X' is performed on the original system, outcome a' is obtained with some probability. The probability of obtaining outcome a for the measurement X on the transformed system is equal to the probability of obtaining an outcome a' such that $a = F2(X, a')$, for some function $F2$. This result is general enough that it applies to transformations that change the type of system, e.g., from one with n fiducial measurements with k outcomes to one with n' fiducial measurements with k' outcomes. In other words, X may take on more or fewer values than X' and similarly a and a' .

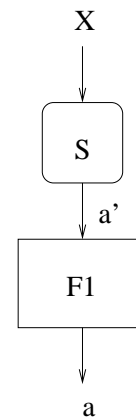

FIG. 6: Measurements on single systems in GNST or GLT can always be performed via a procedure of the type illustrated here, or via a convex combination of such procedures. First, fiducial measurement X is performed, for some X , and outcome a' is obtained. The outcome a of the complete measurement is then $a = F1(a')$. Note that a may take on more or fewer values than a' , thus this result applies to measurements with an arbitrary number of outcomes.

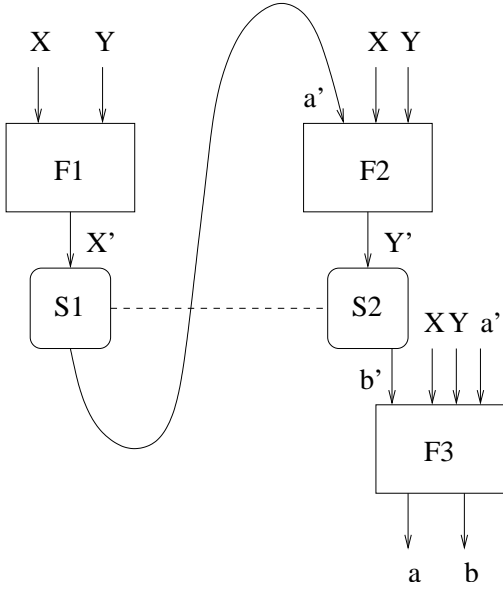

FIG. 7: In GNST, transformations on bipartite systems comprised of two qubits can always be represented by the appending of classical circuits as shown here, or by a similar construction inverted with respect to Alice and Bob, or by a convex combination of such. For the construction shown here, this means that if fiducial measurements X and Y are performed on the transformed systems, one may think of this as first performing a fiducial measurement X' on Alice's half of the original system, where $X' = F1(X, Y)$. This gives an outcome a' . Then, perform a fiducial measurement Y' on Bob's subsystem, where $Y' = F2(X, Y, a')$. The final outcome pair, a, b , is determined by a function $F3$ of X, Y, a' and b' . Again, this result is general enough that it applies to transformations that take the two-qubit system into a different type of system.

are similarly simple. It can be shown that in GLT, there definitely do exist possibilities for measurements and transformations on multi-partite systems that do not reduce to one of the forms presented in this section.

The proof in Appendix D also makes clear the following. The most fine-grained measurements on single systems in the GNST or GLT can be represented by a set of vectors \vec{R}_i , such that each \vec{R}_i has one element between 0 and 1 and the rest 0. Such an \vec{R}_i is analogous to an effect in quantum theory that is proportional to a 1-dimensional projector. A set of \vec{R}_i is analogous to a non-degenerate projective measurement if each \vec{R}_i is a basis vector (one element 1 and the rest 0) and $\sum_i \vec{R}_i \cdot \vec{P} = 1 \forall \vec{P} \in \mathcal{S}$. The corresponding measurement is simply a fiducial measurement, with an \vec{R}_i for each outcome. It is then immediate that, at least with respect to these measurements, there is no Kochen-Specker theorem for single systems in GNST or GLT. Not only is it possible to assign definite outcomes to these measurements in a non-contextual fashion, but each such assignment is in fact an allowed state of the theory. Nonetheless, both GNST and GLT exhibit a different kind of contextuality, introduced by Spekkens [43] and termed *preparation con-*

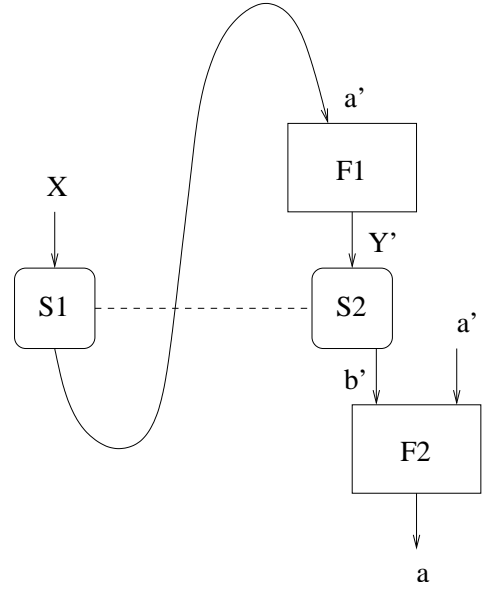

FIG. 8: In GNST, measurements on bipartite systems of two qubits can always be carried out by a procedure like that illustrated here, by a similar procedure inverted with respect to Alice and Bob, or by a convex combination of such. For the procedure shown here, this means that first, a fiducial measurement X is performed on Alice's subsystem, for some X , and outcome a' is obtained. Then fiducial measurement Y' is performed on Bob's subsystem, where $Y' = F1(a')$, and outcome b' is obtained. The outcome a of the complete measurement is given by $a = F2(a', b')$. Again, this result applies to measurements with an arbitrary number of outcomes.

textuality. Readers are referred to Ref. [43] for discussion of preparation contextuality. Given the definition, the proofs for GNST and GLT are obvious.

VII. INFORMATION PROCESSING

Using the results obtained for dynamics in GNST and GLT, the information processing possibilities of each theory can be investigated. Rather than attempt something like a general theory of information, this section contains remarks concerning some obvious tasks. Note that there has already been some work investigating the information processing properties of PR boxes, considered merely as abstract correlations. van Dam has shown that they are very powerful for communication complexity problems [26], and this result has recently been extended to noisy PR boxes in Ref. [27]. Others have claimed to show how to do oblivious transfer [20] and bit commitment [22] using PR boxes. However, as pointed out in Ref. [21], the fact that these latter works consider PR boxes only as abstract correlations means that they make assumptions

that may not hold in any theory that allows PR boxes.¹⁰ In general, a theory with well defined dynamics is needed before cryptography, or indeed other types of information processing, such as computation, can be discussed. GNST is such a theory.

The first results concern teleportation and super-dense coding (the quantum versions of these tasks were introduced in Refs. [44] and [45]). The natural analogue of a quantum mechanical singlet in the GNST is a state which, when fiducial measurements are performed, produces the PR box correlations:

$$\left. \begin{array}{l} 00 \\ XY = 01 \\ 10 \end{array} \right\} \rightarrow P(a = 0, b = 0|XY) =$$

$$P(a = 1, b = 1|XY) = 1/2,$$

$$XY = 11 \rightarrow P(a = 0, b = 1|XY) =$$

$$P(a = 1, b = 0|XY) = 1/2.$$

It can be shown that these correlations represent a pure state - that is a vertex of the polytope of states for two qubits. Further, all vertices of this polytope are either local deterministic correlations (product pure states) or are equivalent to the PR box under local transformations [19].

Theorem 11 *It is impossible to teleport an unknown qubit using a single shared PR box.*

Proof. This follows easily from Corollary 4. In order to teleport an unknown qubit, Alice must perform some sort of joint measurement on the qubit and her half of the shared PR box. But this measurement can be represented as a convex combination of procedures like that of Fig. 8. Such a procedure will always either begin by measuring $X = 0$ or $X = 1$ on the qubit, so that its state is irrevocably disturbed, or begin by measuring the PR box, in which case the shared state collapses into a product state which cannot achieve teleportation. \square

Theorem 12 *A single shared PR box cannot be used for super-dense coding.*

Proof. This follows from Theorem 9 and Corollary 4. Super-dense coding would require that there are four different operations that Alice can perform on her qubit such that, when it is sent to Bob, he can determine unambiguously which was performed by a joint measurement on the two qubits now in his possession. It is easy to see that this is not possible. \square

A. Cryptography

Theorem 13 *In GNST, key distribution is possible.*

Proof. Key distribution can be achieved in GNST using an Ekert-style protocol [46], in which Alice and Bob first share n pairs of qubits, with each pair in the PR box state. They then test some of their shared systems, to make sure that they really are PR box states, i.e., that they have not been disturbed en route by an eavesdropper. Finally, they measure each remaining qubit pair, using the fiducial measurements $X = 0$ and $Y = 0$. Assuming that they share perfect PR box states, their measurement outcomes will be perfectly correlated and can be used as a secret key. This protocol is secure because PR box states have a property of being monogamous, much as the entanglement of a singlet is monogamous in quantum theory. Thus consider a tripartite system shared between Alice, Bob and Eve. If Alice's and Bob's reduced state is the PR box state \vec{P}_{PR}^{AB} , then the global state must be of the form $\vec{P}_{PR}^{AB} \otimes \vec{P}^E$. The outcome of any measurement performed by Eve is uncorrelated with Alice's and Bob's outcomes. The fact that the PR box correlations are monogamous was shown in Ref. [19]. \square

Recall Theorem 5, which states that except for classical systems, all non-trivial transformations disturb at least one pure state. This motivates

Conjecture 1 *For any theory except classical theories, secure key distribution is possible.*

Finally,

Theorem 14 *1-2 oblivious transfer can be implemented securely in both GNST and GLT.*

Proof. In a 1-2 oblivious transfer (introduced in Ref. [48]), Alice must submit 2 bits to Bob in such a manner that Bob can choose to learn either one of the bits or the other, but not both. There is also a security requirement against Alice, who must not be able to learn which of the bits Bob chose. That this task is impossible to implement securely in quantum theory is shown in Ref. [49]. To implement this task in GNST or GLT, Alice sends a qubit to Bob, in a pure state, with the two bits encoded in the outcomes for the $X = 0$ measurement and the $X = 1$ measurement. Corollary 3 ensures that any strategy employed by Bob is equivalent to his measuring either $X = 0$ or $X = 1$, or to measuring $X = 0$ with some probability p and $X = 1$ with probability $1 - p$. Thus the protocol is secure against Bob. That it is secure against Alice follows from the fact that, by the no-signalling principle, she cannot determine which measurement Bob did. \square

In classical cryptography, it is known that 1-2 oblivious transfer is equivalent to oblivious transfer [50], and that either can be used to implement arbitrary secure distributed computation [51]. In particular, either can be used to implement bit commitment, hence coin tossing.

¹⁰ One such assumption that as far as I know has not been pointed out is that the shared boxes are trusted to behave like PR boxes by both parties. But one may reasonably ask where did they come from? By whom were they distributed?

However, one cannot assume that the standard reductions of classical cryptography hold in a different theory such as GLT, GNST or quantum theory. Thus it is open whether other two-party cryptographic tasks, such as oblivious transfer, bit commitment or coin tossing, can be implemented securely in GNST or GLT.

B. Computation

For any of the theories in the framework, a natural model of computation may be defined, based on the classical and quantum circuit models. I introduce this model only informally. A particular circuit is assumed to act on n systems, each of the same type, initially prepared in a product state corresponding to the problem input. k -bit or k -qubit gates are replaced by transformations acting jointly on k systems. At the end of the computation, the fiducial measurement $X = 0$ is performed on each system in order to obtain the output. For a particular theory, it may not be the case that bipartite and single system transformations together are universal, as they are in classical and quantum theory. Thus transformations that act jointly on k systems for any $k > 2$ are allowed. But for any circuit family C_n , there must exist some finite k such that all transformations act on k systems or fewer. In addition, it may not be the case that any particular type of system (such as a gbit) is universal for computation in a given theory. So one should keep in mind that circuits may act on other types of system. Finally, in order to define a notion of polynomial time, say, the usual caveats must be assumed. For example, it should be possible for a classical Turing machine to output a description of the i th circuit in time polynomial in i .

Theorem 15 *In GLT, any computation can be simulated efficiently by a probabilistic classical computer.*

Proof. In GLT, any allowed state of n systems can be written as a convex combination of local deterministic, or pure product, states, in which each system has a definite outcome for each fiducial measurement. A classical simulation of the GLT computation works by storing, at any given time, a local deterministic state of the n systems. This requires an amount of memory linear in n , rather than the exponential amount needed to store a complete description of an arbitrary convex combination. An allowed transformation T , acting on k systems, must take local deterministic states of the k systems to other allowed states of GLT, which in turn are convex combinations of local deterministic states:

$$T(\vec{P}^{LD}) = \sum_i p_i \vec{P}_i^{LD},$$

where superscript *LD* indicates a local deterministic state. The classical computer simulating the GLT computation simply updates the stored state \vec{P}^{LD} to \vec{P}_i^{LD}

with probability p_i . When the final $X = 0$ measurements are performed, the stored local deterministic state will determine the classical computer's output. \square

It is at present unclear what is the power of computation in GNST, but Theorems 9 and 10 and Corollaries 3 and 4 provide at least some evidence that it is no better than classical. In particular, with a restricted model of computation in GNST, in which circuits act on gbits and only single system or bipartite transformations are allowed, computations can be simulated efficiently classically.

There are two further related aspects of GNST.

Theorem 16 *Bipartite communication complexity problems in GNST are trivial, since if the parties share enough PR boxes, a constant amount of communication always suffices.*

Recall that in a bipartite communication complexity scenario, two separated parties each receive an input, and their task is to compute some joint function of their inputs. Their goal is to minimize the amount of communication. van Dam has shown that if the two parties have a supply of shared PR boxes, then any communication complexity problem can be solved with only constant communication [26]. This result has recently been strengthened: it continues to hold even if the shared PR boxes are noisy, provided the amount of noise is not too great [27]. Contrast the situation in quantum theory, where the inner product problem is known to require n bits of communication to be solved exactly, even with unlimited shared singlets [52].

Theorem 17 *Super-quantum memory. In the GNST, it is possible to store a 2^n bit string in only n gbits. Although the whole string cannot be recovered, it is possible to recover the i th bit without error.*

Proof. Suppose that the i th bit of the 2^n bit string we wish to store is given by $f(i_1, \dots, i_n) \in \{0, 1\}$, where $i_1 \dots i_n$ is the binary representation of i . To store the string, we prepare a state of n gbits such that

$$P(a_1, \dots, a_n | X_1, \dots, X_n) = \begin{cases} 1/2^{n-1} & a_1 \oplus \dots \oplus a_n = f(X_1, \dots, X_n) \\ 0 & \text{otherwise} \end{cases}, \quad (24)$$

where $a_1, \dots, a_n \in \{0, 1\}$ are outcomes, $X_1, \dots, X_n \in \{0, 1\}$ are fiducial measurements, and \oplus represents addition mod 2. In order to recover the i th bit of the stored string, simply perform the measurement $X_j = i_j$ on each gbit and sum the outcomes mod 2. One may check that the state of Eq. (24) is an allowed state, since it is normalized and non-signalling. Note that it is indeed impossible to store a 2^n bit string in only n qubits such that any bit may be recovered. Bounds on quantum memory are derived in Ref. [53]. \square

There are many other aspects of GNST and GLT that could be investigated. It is fascinating how many aspects of these theories, especially GNST, are analogous to aspects of quantum theory. These include the mixed state decompositions result and the no-cloning theorems of Section C above, but they also include features that are possessed by GNST and quantum theory but are not necessarily generic in the framework. For example, a proof is omitted, but the reader may like to verify an analogue of the Jamiolkowski isomorphism [28].

VIII. DISCUSSION

A. The framework

The framework introduced allows investigation of theories different from either quantum theory or classical theories. The general idea is that quantum theory can be better understood by viewing it in a context of different possibilities. More specific motivations include:

1. to understand the links between general physical principles and information processing;
2. to stimulate the study of computation in models that are more general than quantum theory;
3. to address Popescu's and Rohrlich's question of why quantum theory does not allow the PR box correlations;
4. to shed light on the interpretive problems of quantum theory by viewing those in a more general context;
5. to stimulate research into axioms for quantum theory.

As regards single systems the framework is very general indeed. It should be emphasized in particular that linearity of transformations is not assumed, but is derived from the fact that the vector \vec{P} is by definition a complete description of the system.¹¹ The most important requirements are that local operations commute

¹¹ So what of nonlinear modifications of quantum mechanics, such as those considered in Ref. [3]? These modifications are nonlinear in the sense that they involve a nonlinear Schrödinger equation. In this case, the usual density matrix is no longer a complete description of a quantum system, since the evolution of a system will in general depend not only on the density matrix, but on the particular decomposition into pure states (assuming a proper mixture). If the description of the state is expanded until it is complete, then the action of the dynamics on this new expanded state description will be linear. But such a theory will in general violate one or more of the other assumptions.

(Assumption 4), and the global state assumption (Assumption 5), both involving the manner in which separate systems combine to make joint systems. These imply a tensor product rule.

One of the interesting things to emerge from the framework is that certain features, usually thought of as specifically quantum, are possessed by all theories except classical theories. These include the non-unique decomposition of mixed states into pure states, disturbance of a system on measurement, and a no-cloning theorem. Thus rather than regarding quantum theory as special for having these features, a better attitude may be to regard classical theories as special for not having them.

How reasonable are Assumptions 4 and 5? Commutativity of local operations is arguably part of what it means to talk about separate systems. In a theory where it fails, any measurement or transformation is essentially a measurement or transformation on all systems at once. It is no longer obvious how to define a reasonable model of computation - how should resources be counted? The case for assuming the commutativity of local operations is also strengthened by the fact that in a spacetime framework, it can be independently motivated by special relativity. It is slightly more difficult to regard the global state assumption as independently compelling. Thus an interesting direction in which to extend this work would be to generalize the framework further by dropping this assumption.

B. The tensor product rule

It is interesting to compare the derivation of the tensor product rule with that of Fuchs [16]. Without going into too much detail, Fuchs assumes that local measurements on two separate systems, A and B , are represented by positive operator-valued measures on Hilbert spaces H_A and H_B . He derives a Gleason-like theorem [55, 56, 57] which states that the joint state of the two systems can be represented by an operator on the tensor product Hilbert space $H_A \otimes H_B$, with joint probabilities for outcomes of local measurements given by the standard trace rule.

As Fuchs acknowledges, the proof does not establish that the operator describing the joint state has to be positive, but only that it has to be positive with respect to local measurements. A consistent theory that is not ruled out would allow the state to be negative with respect to some joint measurements (the Bell basis measurement, for example), but would not allow such measurements. Furthermore, the assumption that local operations commute and the global state assumption are both implicit in Fuchs' analysis. Without the latter, the possibility remains that there are extra degrees of freedom, not accessible via local measurements, that are not described by an operator on the tensor product Hilbert space.

It follows that Fuchs' conclusion is not stronger than the tensor product rule derived in this paper. The latter may be regarded as a generalization of Fuchs' proof to the

case in which the subsystems A and B are not necessarily quantum.

C. Information theory, GNST and GLT

In addition to describing general properties of the framework, I investigated in detail two particular theories, GNST and GLT. I focussed on the information processing possibilities in these theories. One of the most interesting things to have emerged is that there is a trade-off between the states of a theory and the allowed dynamics. This arises for the simple reason that an allowed transformation must take allowed states into allowed states. Thus the dynamics of both GNST and GLT is very simple for single systems. In GNST, a similar result holds for the simplest kind of bipartite system. The surprising consequence is that GNST is less powerful than quantum theory in many ways, despite including super-quantum correlations. For example, teleportation and super-dense coding are impossible. If the theorems about dynamics extend to all dynamics in the theory, then computation in GNST can be simulated efficiently classically. It is already clear that computation in GLT can be simulated efficiently classically. Open questions include whether secure bit commitment or broadcasting are possible in either theory. Despite these remarks, it is surprising how many features of quantum theory have analogues in GNST. These obviously include the generic features demonstrated in Section C, along with entanglement and nonlocality. But they also include things I have not discussed in detail, such as the distinction between sharp and unsharp measurements, preparation contextuality, and the Jamiolkowski isomorphism. (Other authors have also found features of quantum theory reproduced in other contexts. Masanes et al. [14] show that various features, including a no-cloning theorem, are present in all theories that are non-local and non-signalling. Spekkens has introduced a toy theory that contains a remarkably wide range of quantum phenomena [12], although note that this theory is not contained in our framework as it does not allow arbitrary convex combinations of states.)

As mentioned above, one of the motivations of this work is to stimulate the study of computation in models that are more general than quantum theory. Some authors have already considered computation in non-standard theories. However, these theories are often modifications of quantum theory that appear to have unphysical consequences and immense computational power. It is suspected that quantum theory with a nonlinear Schrödinger equation is very powerful, enabling the solution of NP-complete problems in polynomial time, for example.¹² Aaronson has considered various modifica-

tions of quantum theory, including a model that assumes the ability to postselect measurement outcomes, and a hidden variable model in which the history of hidden states can be read out by the observer [5, 6, 7]. Various authors have considered classical and quantum computation in the presence of closed timelike curves [8, 9]. Most recently, Aaronson and Watrous have shown that BQP with closed timelike curves is equivalent to PSPACE [10]. The framework introduced in this paper is the natural place to investigate computation in theories that are different from quantum theory, yet not obviously physically unreasonable or immensely powerful. I suggest that NP-complete problems cannot be solved efficiently by any theory in the framework. I also raise the following

Conjecture 2 *Any problem that can be solved in polynomial time in some theory in the framework can be solved in polynomial time by a quantum computer.*

The intuition behind this is that quantum theory achieves in some sense an optimal balance of allowed states and dynamics.

D. Interpretation

On the face of it, many theories that can be written down in the framework have similar interpretive issues as quantum theory, if one tries to understand them in a way that goes beyond the purely operational. Consider a universe in which some theory other than quantum or classical (GNST perhaps) is verified in laboratory experiments. The denizens of such a universe would be having debates in many ways similar to the debates that surround quantum theory. Is a pure state better understood as a direct description of individual reality, as representing an ensemble, or as a state of knowledge of some agent?

Suppose that the inhabitants of this universe attempt to extend the theory to include a description of the measuring apparatus, and of the interaction between system and apparatus. This is always possible in classical and quantum theory. In quantum theory, this fact is expressed by saying that the *Heisenberg cut* can be moved upwards indefinitely. Are classical and quantum theories special in this regard, or can this be done in any theory?

Even when the inhabitants succeed in constructing a measurement theory along these lines, it is plausible that many theories will have a *measurement problem*. In these theories, the system and apparatus are typically in some entangled state after interaction. Some inhabitants may suggest hidden variables or some kind of collapse dynamics. Does any theory admit an Everettian interpretation,

¹² In Ref. [3], it is claimed that nonlinear quantum theory can solve NP-complete and even #P-complete problems efficiently. Aaron-

son complains [4] that in this particular case it is difficult to evaluate whether exponential precision is required.

or is there a special feature of quantum theory that is necessary for this to work?

I won't discuss these issues any further. I have raised them hoping that considering interpretive issues in a framework more general than quantum theory might give a much needed new lease of life to the quantum debates.

E. Axioms

Aside from Hardy's derivation [15], what different ways are there of uniquely identifying quantum theory from the other theories in the framework by adding as few extra assumptions as possible? One possibility would be to regard the states of these theories as *epistemic*, meaning that a state is taken to summarize an agent's knowledge about the outcomes of future measurements on a system. Each theory may be regarded as being picked out by an *epistemic constraint*, that is a constraint on the kind of knowledge that an agent can have. The constraint would determine the shape of the sets \mathcal{S} . One such constraint would identify quantum theory. That such a constraint could be a foundational principle for quantum theory has been argued by, for example, Fuchs

¹³ Whether they succeed in deriving the full structure of quantum theory is debatable. But they do establish the existence of non-

[16] and Spekkens [12].

Clifton, Bub and Halvorson (CBH) have taken a different approach and derived at least part of quantum theory from the assumption of (i) a no-signalling principle, (ii) a no-broadcasting principle, and (iii) the impossibility of secure bit commitment [58].¹³ CBH assume a C^* -algebraic framework, which is broad enough to include classical theories and quantum theory, but is not as broad as the framework presented here. An open question is whether something like CBH's proof would go through in the broader framework, or whether there is some theory (GNST perhaps) that satisfies (i)-(iii) and is clearly not quantum.

Acknowledgments

I should very much like to thank Howard Barnum, Nick Jones, Matthew Leifer, Lluís Masanes, Stefano Pironio, Sandu Popescu, Tony Short and Rob Spekkens for useful discussions.

Note added. Related independent work has appeared recently in Ref. [60].

commuting measurements and of entanglement.

-
- [1] Workshop titled *What is Quantum in Quantum Computing?* Konstanz, Germany, May 19-20, 2005.
- [2] M. Troyer and U.-J. Wiese, Phys. Rev. Lett. **94**, 170201 (2005).
- [3] D. S. Abrams and S. Lloyd, Phys. Rev. Lett. **81**, 3992 (1998).
- [4] S. Aaronson, ACM SIGACT News, Vol. 36, Issue 1 (March 2005), quant-ph/0502072.
- [5] S. Aaronson, quant-ph/0408035.
- [6] S. Aaronson, quant-ph/0408119.
- [7] S. Aaronson, Proc. Roy. Soc. A **461**, 3473 (2005).
- [8] T. A. Brun, Found. Phys. Lett. **16**, 245 (2003).
- [9] D. Bacon, Phys. Rev. A **70**, 032309 (2004).
- [10] S. Aaronson and J. Watrous, in preparation.
- [11] L. Hardy, quant-ph/9906123.
- [12] R. Spekkens, quant-ph/0401052.
- [13] J. A. Smolin, quant-ph/0310067.
- [14] L. Masanes, A. Acín and N. Gisin, Phys. Rev. A **73**, 012112 (2006).
- [15] L. Hardy, quant-ph/0101012.
- [16] C. A. Fuchs, quant-ph/0205039.
- [17] L. A. Khalifi and B. S. Tsirelson, in *Symposium on the Foundations of Modern Physics*, edited by P. Lahti and P. Mittelstaedt (World Scientific, Singapore, 1985), pp. 441-460.
- [18] S. Popescu and D. Rohrlich, Found. Phys. **24**, 379 (1994).
- [19] J. Barrett, N. Linden, S. Massar, S. Pironio, S. Popescu and D. Roberts, Phys. Rev. A **71**, 022101 (2005).
- [20] S. Wolf and J. Wullschleger, in *Proceedings of International Symposium on Information Theory (ISIT) 2005*, 2005.
- [21] A. Short, N. Gisin and S. Popescu, quant-ph/0504134.
- [22] H. Buhrman, M. Christandl, F. Unger, S. Wehner and A. Winter, quant-ph/0504133.
- [23] A. Broadbent and A. A. Méthot, quant-pt/0504136.
- [24] J. Barrett and S. Pironio, Phys. Rev. Lett. **95**, 140401 (2005).
- [25] N. S. Jones and L. Masanes, Phys. Rev. A **72**, 052312 (2005).
- [26] W. van Dam, quant-ph/0501159.
- [27] G. Brassard, H. Buhrman, N. Linden, A. A. Méthot, A. Tapp and F. Unger, quant-ph/0508042.
- [28] A. Jamiolkowski, Rep. Math. Phys. **3**, 275 (1972).
- [29] W. K. Wootters, Found. Phys. **16**, 391 (1986).
- [30] P. G. L. Mana, quant-ph/0305117.
- [31] P. G. L. Mana, in A. Y. Khrennikov (ed.), *Quantum Theory: Reconsideration of Foundations 2* (Vaxjo University Press, Vaxjo, 2004), e-print quant-ph/0403084.
- [32] E. C. G. Stueckelberg, Helv. Phys. Acta **33**, 727 (1960).
- [33] W. K. Wootters, in *Complexity, Entropy and the Physics of Information*, edited by W. H. Zurek (Addison-Wesley, 1990).
- [34] C. M. Caves, C. A. Fuchs and R. Schack, J. Math. Phys. **43**, 4537 (2002).
- [35] R. Werner, Phys. Rev. A **40**, 4277 (1989).
- [36] J. Barrett, Phys. Rev. A, **65**, 042302 (2002).
- [37] F. Clauser, M. A. Horne, A. Shimony and R. A. Holt, Phys. Rev. Lett. **23**, 880 (1969).
- [38] B. S. Cirel'son, Lett. Math. Phys. **4**, 93 (1980).
- [39] H. Barnum, C. A. Fuchs, J. M. Renes and A. Wilce, quant-ph/0507108.
- [40] T. Rudolph, R. W. Spekkens and P. S. Turner, Phys.

Rev. A **68**, 010301(R) (2003).

- [41] J. Barrett and M. Leifer, forthcoming.
- [42] J. Barrett, forthcoming.
- [43] R. Spekkens, Phys. Rev. A **71**, 052108 (2005).
- [44] C. H. Bennett, G. Brassard, C. Crépeau, R. Jozsa, A. Peres and W. K. Wootters, Phys. Rev. Lett. **70**, 1895 (1993).
- [45] C. H. Bennett and S. J. Wiesner, Phys. Rev. Lett. **69**, 2881 (1992).
- [46] A. K. Ekert, Phys. Rev. Lett. **67**, 661 (1991).
- [47] C. H. Bennett and G. Brassard, in *Proceedings of IEEE International Conference on Computers, Systems and Signal Processing* (IEEE, 1984), p.175.
- [48] S. Even, O. Goldreich and A. Lempel, in R. L. Rivest, A. Sherman and D. Chaum (Eds.), *Proceedings CRYPTO 82* (Plenum Press, New York, 1982), p.205.
- [49] H.-K. Lo, Phys. Rev. A **56**, 1154 (1997).
- [50] G. Brassard, C. Crépeau and J.-M. Robert, in *27th Symposium of Foundations of Computer Science* (IEEE, 1986), p.168.
- [51] J. Killian, in *Proceedings of 20th ACM Symposium on Theory of Computing* (ACM, Chicago, 1988), p.20.
- [52] R. Cleve, W. van Dam, M. Nielsen and A. Tapp, in *Proceedings of the first NASA International Conference on Quantum Computing and Quantum Communication*, LNCS **1509** (Springer-Verlag, Heidelberg, 1998), p.61.
- [53] A. Ambainis, A. Nayak, A. Ta-Shma and U. Vazirani, quant-ph/9804043.
- [54] S. Aaronson, seminar given at Perimeter Institute, March 2006.
- [55] A. M. Gleason, J. Math. Mech. **6**, 885 (1957).
- [56] P. Busch, Phys. Rev. Lett. **91**, 120403 (2003).
- [57] C. M. Caves, C. A. Fuchs, K. Manne and J. M. Renes, Found. Phys. **34**, 193 (2004).
- [58] R. Clifton, J. Bub and H. Halvorson, Found. Phys. **33**, 1561 (2003).
- [59] A. Barvinok, *A Course in Convexity*, Graduate Studies in Mathematics, Vol. 54 (American Mathematical Society, Providence, Rhode Island, 2002).
- [60] T. Short, S. Popescu and N. Gisin, quant-ph/0508120.

APPENDIX A: PROOF OF LINEARITY OF TRANSFORMATIONS

The proof in this appendix is similar to that of Hardy in Ref. [15]. It is included to keep this work self-contained.

A transformation is a map that takes an allowed state of a system into another allowed state. The map satisfies Eq.(7), reproduced here:

$$f\left(\sum_i q_i \vec{P}_i\right) = \sum_i q_i f(\vec{P}_i) \quad (\text{A1})$$

$$\forall \vec{P}_i \in \mathcal{S}, \text{ for } 0 \leq q_i \leq 1, \sum_i q_i = 1.$$

The map should also satisfy

$$f(\vec{0}) = \vec{0}.$$

This follows from our interpretation of unnormalized states. Consider an operation on some state, such that a

particular outcome x has probability zero. Suppose that this operation is performed, followed by transformation f , followed by a fiducial measurement. The probability of getting outcome x , followed by any particular outcome for the fiducial measurement is also zero.

Writing the first of these equations with $i = 1, 2$, and setting $\vec{P}_2 = \vec{0}$, gives

$$f(q\vec{P}) = qf(\vec{P}) \quad \forall \vec{P} \in \mathcal{S}, \text{ for } 0 \leq q \leq 1.$$

Suppose that \vec{P} is a pure state $\in \mathcal{S}$. Pure states are by definition normalized. Consider an r such that either $r > 1$ or $r < 0$. $f(r\vec{P})$ is initially undefined because $r\vec{P} \notin \mathcal{S}$, so we are free to stipulate that

$$f(r\vec{P}) = rf(\vec{P}) \quad \forall \vec{P} \in \mathcal{S}, r \in \mathbb{R}.$$

Define the convex set \mathcal{S}' as the set of all vectors that can be written in the form $r\vec{P}$ with $\vec{P} \in \mathcal{S}$ and $r \in \mathbb{R}$. Note that Eq.(A1) can be extended:

$$f\left(\sum_i q_i \vec{P}_i\right) = \sum_i q_i f(\vec{P}_i) \quad (\text{A2})$$

$$\forall \vec{P}_i \in \mathcal{S}' \text{ for } 0 \leq q_i \leq 1, \sum_i q_i = 1.$$

Consider $f\left(\sum_i r_i \vec{P}_i\right)$, where $r_i \in \mathbb{R}$, $\vec{P}_i \in \mathcal{S}$, and $\sum_i r_i \vec{P}_i \in \mathcal{S}$. Define

$$r'_i = \frac{\text{sgn}(r_i)r_i}{\sum_i \text{sgn}(r_i)r_i}, \quad \text{and} \quad \vec{P}'_i = \frac{r_i}{r'_i} \vec{P}_i.$$

Note that $\vec{P}'_i \in \mathcal{S}'$, $0 \leq r'_i \leq 1$, and that $\sum_i r'_i = 1$. Using Eq.(A2),

$$f\left(\sum_i r_i \vec{P}_i\right) = f\left(\sum_i r'_i \vec{P}'_i\right) = \sum_i r'_i f(\vec{P}'_i) = \sum_i r_i f(\vec{P}_i).$$

Finally, for any vector $\vec{Q} \notin \mathcal{S}'$, $f(\vec{Q})$ can be defined uniquely by linear extension if \vec{Q} lies in the subspace spanned by \mathcal{S} . The action of f on the rest of the vector space is arbitrary but may be defined to be linear. Hence

$$f\left(\sum_i r_i \vec{P}_i\right) = \sum_i r_i f(\vec{P}_i) \quad \forall r_i, \vec{P}_i,$$

and f is linear. \square

APPENDIX B: DERIVATION OF TENSOR PRODUCT RULE

As discussed in the main text, the state of a joint system AB can be written

$$\vec{P}^{AB} \equiv \begin{pmatrix} P(a=0, b=0|X=0, Y=0) \\ P(a=0, b=1|X=0, Y=0) \\ \vdots \\ \hline P(a=0, b=0|X=0, Y=1) \\ P(a=0, b=1|X=0, Y=1) \\ \vdots \\ \hline \vdots \end{pmatrix}.$$

Proof of Theorem 1. This theorem is trivial. Let $\vec{P}^{AB} \in V^{AB}$, $\vec{P}^A \in V^A$ and $\vec{P}^B \in V^B$. Define the vector \vec{Q}_{ijkl}^{AB} as the vector with a 1 for the entry corresponding to the joint outcome ij of the joint fiducial measurement kl , and 0s elsewhere. Similarly \vec{Q}_{ik}^A and \vec{Q}_{jl}^B . Now identify \vec{Q}_{ijkl}^{AB} with $\vec{Q}_{ik}^A \otimes \vec{Q}_{jl}^B$ and extend linearly. \square

Proof of Theorem 2. Consider a joint system AB . For each of the fiducial measurements that define the state of system B , there must be at least one operation on the joint system AB that corresponds to performing that measurement. Let this operation for the j th fiducial measurement be characterized by the set of matrices $\{M_{ij}\}$, where there is a value of i for each outcome and j is fixed. When the transformation M_{ij} acts on AB , the resulting state is the unnormalized state $\vec{P}_{ij}^{AB} \in \mathcal{S}^{AB}$. The corresponding reduced state for A is the unnormalized state \vec{P}_{ij}^A . By Constraint 2, $\vec{P}_{ij}^A \in \mathcal{S}^A$. If a fiducial measurement is now performed on A , the state \vec{P}_{ij}^A gives the (unnormalized) probabilities for the different outcomes. It follows that \vec{P}^{AB} can be written in the form

$$\vec{P}^{AB} = \sum_{ij} \vec{P}_{ij}^A \otimes \vec{Q}_{ij}^B, \quad (\text{B1})$$

with $\vec{P}_{ij}^A \in \mathcal{S}^A$ and \vec{Q}_{ij}^B as above. Now consider a vector $\vec{U} \otimes \vec{W} \in V^{AB}$, with $\vec{W} \in \mathcal{S}^B$ but $\vec{U} \perp \mathcal{S}^A$, where this means that \vec{U} is orthogonal to all vectors in \mathcal{S}^A . From Eq.(B1) it follows that $(\vec{U} \otimes \vec{W}) \cdot \vec{P}^{AB} = 0$. A similar result holds if $\vec{W} \perp \mathcal{S}^B$ and $\vec{U} \in \mathcal{S}^A$. Thus \vec{P}^{AB} lies in the subspace of V^{AB} that is spanned by vectors from $\mathcal{S}^A \otimes \mathcal{S}^B$. Eq. (19) follows. The vectors on the right hand side of this equation can be assumed normalized, since any multiplying factor can be subsumed into the corresponding r_i . They can be assumed pure, since a mixed state can always be expressed as a convex combination of pure states and $\vec{0}$. But any term with $\vec{0}$ will not contribute. Theorem 2 follows. \square

Proof of Theorem 3. Consider a joint system AB and a transformation T^A of system A alone. T^A corresponds to a matrix M^A such that $\vec{P}^A \rightarrow \vec{P}^{A'} = M^A \cdot \vec{P}^A$. The aim is to determine the effect of this transformation on the

joint state \vec{P}^{AB} . From Section II A, this will correspond to a matrix \tilde{M}^A such that $\vec{P}^{AB} \rightarrow \vec{P}^{AB'} = \tilde{M}^A \cdot \vec{P}^{AB}$. But what is the relation between M^A and \tilde{M}^A ?

Consider the following procedure. First, the transformation T^A is applied. Then fiducial measurements are performed on systems A and B . The (unnormalized) joint probabilities for the outcomes of these measurements are then the entries of the vector $\vec{P}^{AB'}$. However, by Assumption 4, the ordering of operations on systems A and B does not matter. Thus the following procedure is equivalent. First, a fiducial measurement is performed on system B . Note that the reduced state of system A conditioned on a particular outcome for this measurement is defined by the vector \vec{P}^{AB} . Next, the transformation T^A is performed on system A . Finally, a fiducial measurement is performed on system A .

In the second procedure, we know how to apply the transformation T^A , since it is enough to consider its action on system A alone, and we know that $\vec{P}^A \rightarrow \vec{P}^{A'} = M^A \cdot \vec{P}^A$. We obtain

$$\begin{aligned} \vec{P}_{ijkl}^{AB'} &= \sum_{i'k'} (M^A)_{ik;i'k'} \vec{P}_{i'jk'l}^{AB} \\ &= \sum_{i'k'j'l'} (M^A)_{ik;i'k'} \delta_{jj'} \delta_{ll'} \vec{P}_{i'j'k'l'}^{AB}. \end{aligned}$$

But

$$(M^A \otimes I^B)_{ijkl;i'j'k'l'} = (M^A)_{ik;i'k'} \delta_{jj'} \delta_{ll'},$$

thus

$$\vec{P}^{AB'} = (M^A \otimes I) \vec{P}^{AB}.$$

This holds for all $\vec{P}^{AB} \in \mathcal{S}^{AB}$, and the action of T^A on vectors $\vec{P}^{AB} \notin \mathcal{S}^{AB}$ is arbitrary. It follows that we lose no generality in identifying

$$\tilde{M}^A = M^A \otimes I^B. \quad \square$$

APPENDIX C: GENERIC FEATURES

This appendix contains proofs of the results of Section V.

Proof of Theorem 4. Consider a particular type of system in some theory. Suppose that the subspace spanned by allowed states of the system has dimension d and that every mixed state has a unique decomposition into pure states and $\vec{0}$. The only convex set with this property is a simplex with $d+1$ vertices. One of these vertices is the state $\vec{0}$. It is always possible to find a linear transformation N such that the other vertices are transformed into the vectors $(1, 0, 0, \dots, 0)$, $(0, 1, 0, \dots, 0)$, and so on. Recall from Section III that if this transformation acts on the set \mathcal{S} , then the theory is not changed, since

$\vec{R}^T \rightarrow \vec{R}^T.N^{-1}$ and $M \rightarrow N.M.N^{-1}$ for measurements and transformations. Hence the system is classical. \square

Proof of Theorem 5. Consider a system with a set of allowed states \mathcal{S} . If there is only one pure state then the system is classical and the theorem applies. So suppose that there are at least two pure states. I show that either the system is classical, and there are non-trivial non-disturbing transformations, or it is not classical, in which case, all non-disturbing transformations are trivial. Denote by V_S the subspace spanned by vectors in \mathcal{S} , and by d the dimension of V_S . Choose a set of d distinct pure states $\{\vec{P}_i\}$ that are linearly independent and collectively span V_S . Suppose that a particular transformation is non-disturbing. Its action on each of the \vec{P}_i is given by $M.\vec{P}_i = c_i\vec{P}_i$ with $0 \leq c_i \leq 1$. The transformation is non-trivial if and only if $c_i \neq c_j$ for some i, j . Now if the system is classical, then \mathcal{S} is a simplex and the set $\{\vec{P}_i\}$ must contain all the pure states. Since the \vec{P}_i are linearly independent, the c_i can be chosen independently without contradiction. Thus there are non-trivial non-disturbing transformations. For any other type of system, there are at least $d+1$ pure states. Thus there is at least one pure state, call it \vec{Q} , not contained in the set $\{\vec{P}_i\}$. It is possible to write $\vec{Q} = \sum_i d_i\vec{P}_i$, with d_i real. Thus $M.\vec{Q} = \sum_i d_i c_i\vec{P}_i$. The transformation is only non-disturbing if $M.\vec{Q} = e\vec{Q}$ for some e with $0 \leq e \leq 1$. But this is only possible if $d_i c_i = e d_i \forall i$, implying $c_i = e \forall i$, implying that M is trivial. \square

Proof of Theorem 6. Consider any theory, any type of system, and two distinct pure states, \vec{P}_1 and \vec{P}_2 . Using Assumption 7, I show that there is always a measurement $\{\vec{R}, \vec{I} - \vec{R}\}$ such that $\vec{R}.\vec{P}_1 > 0$ and $\vec{R}.\vec{P}_2 = 0$. First, define \mathcal{S}_+ as the set of all vectors of the form $r\vec{P}$, where $r \geq 0$ and $\vec{P} \in \mathcal{S}$. \mathcal{S}_+ is a convex cone [59]. Pure states of the system generate extremal rays of \mathcal{S}_+ . Define \mathcal{R}_+ as the set of vectors of the form $r\vec{R}$, where $r \geq 0$ and $\vec{R} \in \mathcal{R}$. \mathcal{R}_+ is the *dual cone* to \mathcal{S}_+ . Suppose first that the system in question has a finite number of pure states. In this case, \mathcal{S}_+ is a *polyhedral cone*. It can be shown that the set $\{\vec{V} : \vec{V} \in \mathcal{R}_+, \vec{V}.\vec{P}_2 = 0\}$ is a facet of \mathcal{R}_+ . If the dimension of \mathcal{S}_+ is d then this facet contains $d-1$ linearly independent extremal rays of \mathcal{R}_+ . Choose a representative vector \vec{R}_i from each extremal ray, short enough that $\vec{R}_i.\vec{P} \leq 1 \forall \vec{P} \in \mathcal{S}$. It must be the case that $\vec{R}_i.\vec{P}_1 > 0$ for at least one value of i , otherwise \vec{P}_1 lies in the same ray as \vec{P}_2 and they cannot be distinct pure states. This is the required measurement. To extend this result to systems with an infinite number of pure states, note that it is always possible to find a convex set \mathcal{S}' such that: \mathcal{S}' has a finite number of vertices; $\mathcal{S} \subseteq \mathcal{S}'$; \vec{P}_1 and \vec{P}_2 are vertices of \mathcal{S}' . The proof just given, when applied to \mathcal{S}' , implies that there is a vector \vec{R} such that $\vec{R}.\vec{P}_1 > 0$, $\vec{R}.\vec{P}_2 = 0$, and $0 \leq \vec{R}.\vec{P} \leq 1 \forall \vec{P} \in \mathcal{S}'$. But since $\mathcal{S} \subseteq \mathcal{S}'$, $0 \leq \vec{R}.\vec{P} \leq 1 \forall \vec{P} \in \mathcal{S}$. Thus \vec{R} is an allowed measurement with the required properties.

Finally, there is a similar measurement such that $\vec{S}.\vec{P}_1 = 0$ and $\vec{S}.\vec{P}_2 > 0$. The overall unambiguous state discrimination procedure uses the measurement $(1/2\vec{R}, 1/2\vec{S}, \vec{I} - 1/2\vec{R} - 1/2\vec{S})$. The $1/2\vec{R}$ outcome indicates that the state was definitely \vec{P}_1 , $1/2\vec{S}$ indicates \vec{P}_2 , and $\vec{I} - 1/2\vec{R} - 1/2\vec{S}$ is inconclusive. \square

Proof of Theorem 7. Consider any theory, any type of system, two distinct pure states \vec{P}_1 and \vec{P}_2 , and the unambiguous discrimination procedure of Theorem 6. A cloning procedure may consist of performing this measurement, outputting fail if the inconclusive outcome is obtained, and preparing two new copies of the state \vec{P}_i when outcome i is obtained.

Before regarding this proof as complete, a slightly subtle concern must be addressed. A procedure is given that consists of a number of instructions, described *at the level of the observer*. It is of the form: do this, do this, and if this happens do this. It needs to be verified that any procedure like this does indeed correspond to a single operation that is allowed in the theory, i.e., a set of transformation matrices $\{M_i\}$ with $M_i \in \mathcal{T}$. This is necessary since cloning is defined in terms of the existence of appropriate transformations. In general, it would be a reasonable constraint to require of a theory that any sequence of procedures carried out by the observer corresponds to an allowed operation $\{M_i\}$. Here we need only note that this constraint is implied by Assumption 7. \square

Proof of Theorem 8. This theorem is actually a corollary of Theorem 5. First, if there is only one pure state, then a system is classical and the theorem holds. So assume at least two pure states. I show that if there is a probabilistic universal cloning procedure, then there is a non-trivial non-disturbing transformation, implying that the system is classical. Suppose, then, that there is a standard state \vec{Q} and a transformation M such that $(M)(\vec{P} \otimes \vec{Q}) \propto \vec{P} \otimes \vec{P}$ for any pure state \vec{P} . There must be at least one state \vec{P} for which the constant of proportionality (the probability of success) is > 0 . So consider a procedure in which a system is in the state \vec{P} , an ancilla is added in the standard state \vec{Q} , and the transformation M performed on the joint system. Now perform a fiducial measurement on the ancilla. Output the result and throw away the ancilla. Write the operation corresponding to the fiducial measurement as $\{N_i\}$. The total procedure now consists of adding an ancilla to the initial state, performing an operation $O = \{(I \otimes N_i).M, F\}$ on the joint system and throwing away the ancilla. Here, F is a transformation corresponding to the fail outcome that has been added to make the operation O complete. It must be possible (see remarks at the end of Section IIB) to write the whole operation as an operation on the system alone, say as $O' = \{M'_i, F'\}$. By construction, each of the M'_i is non-disturbing. But there must exist a choice of fiducial measurement, an M'_i , and two pure states \vec{P}_1 and \vec{P}_2 such that the probability of getting outcome M'_i is different for \vec{P}_1 and \vec{P}_2 . Otherwise all pure states have

the same probabilities for all fiducial measurements, i.e., there is only one pure state, and we have the degenerate case mentioned above. Thus assuming at least two pure states, there is an M'_i that is non-disturbing and non-trivial. \square

APPENDIX D: DYNAMICS IN GNST AND GLT

This appendix contains proofs of Theorems 9 and 10 and Corollarys 3 and 4, all of which concern dynamics in

GNST or GLT.

Proof of Theorem 9. This theorem concerns transformations of single systems in either GNST or GLT. A transformation that takes an (n, k) system to an (n', k') system can be written

$$\begin{pmatrix} P(a' = 0|X' = 0) \\ \vdots \\ P(a' = k'|X' = 0) \\ \vdots \\ P(a' = 0|X' = n') \\ \vdots \\ P(a' = k'|X' = n') \end{pmatrix} = \begin{pmatrix} M_{00} & \cdots & M_{0n} \\ \vdots & & \vdots \\ M_{n'0} & \cdots & M_{n'n} \end{pmatrix} \begin{pmatrix} P(a = 0|X = 0) \\ \vdots \\ P(a = k|X = 0) \\ \vdots \\ P(a = 0|X = n) \\ \vdots \\ P(a = k|X = n) \end{pmatrix}. \quad (\text{D1})$$

It is useful to introduce some definitions. Let the transformation matrix be M , an $n'k' \times nk$ matrix. If the fiducial measurement $X' = 0$ has k' outcomes, then the top k' rows of this matrix determine the probabilities of outcomes when the $X' = 0$ measurement is performed on the transformed state \vec{P}' . Denote the $k' \times nk$ submatrix consisting of these rows M_0 . The next k' rows are associated with the fiducial measurement $X = 1$, so denote the corresponding submatrix by M_1 , and so on. It will also be useful to split M_i into subsubmatrices. The first k columns of M_i multiply into those components of \vec{P} that correspond to the fiducial measurement $X = 0$ being performed. Denote the $k' \times k$ subsubmatrix consisting of these columns M_{i0} . Similarly M_{i1} , and so on. Note that each row in M , considered as a vector \vec{R} , must represent a possible yes/no measurement. This is because if the transformation acts on a state \vec{P} , then $\vec{R} \cdot \vec{P}$ gives the corresponding entry in the transformed state \vec{P}' , which must be between 0 and 1 for all $\vec{P} \in \mathcal{S}$. Furthermore, when the transformation is normalization preserving, the rows \vec{R}_j from a particular M_i satisfy $\sum_j \vec{R}_j \cdot \vec{P} = 1$, whenever \vec{P} is normalized. Hence the rows from a particular M_i correspond to a multiple-outcome measurement. One way of performing this measurement is simply to perform the transformation M first, and then to perform fiducial measurement $X' = i$.

There is some redundancy in a measurement vector \vec{R}_j and in the matrix M . If $\vec{R} \cdot \vec{P} = \vec{R}' \cdot \vec{P} \forall \vec{P} \in \mathcal{S}$, then \vec{R}

and \vec{R}' represent the same measurement. In particular, if $\vec{R}' = \vec{R} + \vec{C}$, where $\vec{C} \cdot \vec{P} = 0 \forall \vec{P} \in \mathcal{S}$, then \vec{R} and \vec{R}' represent the same measurement. An example of such a \vec{C} is

$$\vec{C} = (1, \dots, 1 | -1, \dots, -1 | 0, \dots, 0 | \dots),$$

where $\vec{C} \cdot \vec{P} = 0 \forall \vec{P} \in \mathcal{S}$ is ensured by the normalization of \vec{P} . The first step in the proof is to show that any \vec{R} is equivalent in this sense to an \vec{R}' with all components ≥ 0 .

For this, consider the set of allowed normalized states. This is precisely the set of vectors satisfying the conditions

$$\sum_i P(a = i|X = j) = \sum_i P(a = i|X = k) \quad \forall j, k, \quad (\text{D2})$$

$$P(a = i|X = j) \geq 0 \quad \forall i, j, \quad (\text{D3})$$

$$\sum_i P(a = i|X = 0) = 1. \quad (\text{D4})$$

As in the proof of Theorem 6, define \mathcal{S}_+ as the set of vectors of the form $r\vec{P}$, with $r > 0$ and $\vec{P} \in \mathcal{S}$, and note that in the case of GNST or GLT, \mathcal{S}_+ is a polyhedral cone [59]. It can also be defined as the set of vectors satisfying conditions (D2) and (D3). The defining inequalities (D3) can each be written in the form $\vec{C}_i \cdot \vec{P} \geq 0$, where \vec{C}_i is a constant vector with a 1 in the i th position and 0s elsewhere. The equalities (D2) can each be written

as the conjunction of two inequalities: $\vec{D}_j \cdot \vec{P} \geq 0$ and $\vec{D}_j \cdot \vec{P} \leq 0$ for some constant D_j . Define \mathcal{R}_+ as the set of vectors \vec{R} such that $\vec{R} \cdot \vec{P} \geq 0 \forall \vec{P} \in \mathcal{S}_+$. This is the set of unnormalized measurements and is the dual cone to \mathcal{S}_+ . It can be shown that if a polyhedral cone is defined by $\{\vec{P} : \vec{A}_i \cdot \vec{P} \geq 0 \forall i\}$, then the dual cone is equal to the conic hull of the vectors \vec{A}_i . Thus elements of \mathcal{R}_+ can be written

$$\vec{R} = \sum_i \lambda_i \vec{C}_i + \sum_j \mu_j \vec{D}_j, \quad (\text{D5})$$

where $\lambda_i \geq 0$ and μ_j can be positive or negative. Finally, the vectors \vec{D}_j all satisfy $\vec{D}_j \cdot \vec{P} = 0 \forall \vec{P} \in \mathcal{S}_+$. Hence any \vec{R} of this form is equivalent to an \vec{R} of the form

$$\vec{R} = \sum_i \lambda_i \vec{C}_i, \quad (\text{D6})$$

and without loss of generality, the components of \vec{R} can be assumed ≥ 0 . This applies both to \vec{R} considered as a measurement and to \vec{R} considered as a row of a transformation matrix M .

Assume, then, that M is written in a form with all entries ≥ 0 . To conclude the proof, note that M acting on any properly normalized state (satisfying both Eqs. (D2) and Eq. (D4)) must result in a state that is also properly normalized. This implies the following. Consider the matrix M_{ij} . Denote the sum of the elements in the first column by S_1^{ij} , the sum of the elements in the second column by S_2^{ij} , and so on. Then $S_1^{ij} = S_2^{ij} = \dots = S_k^{ij}$ and $\sum_j S_1^{ij} = 1$. Hence the matrix M_{ij} is of the form α_{ij} times a stochastic matrix, with $0 \leq \alpha_{ij} \leq 1$ and $\sum_j \alpha_{ij} = 1$. One may easily check that any transformation that is equivalent to a procedure of the form of Fig. 5 is represented by a matrix of this form with $\alpha_{ik} = 1$ for some k and $\alpha_{ij} = 0$ for $j \neq k$. Hence we have obtained the general result that any allowed M is a convex mixture of transformations of the form of Fig. 5. \square

Proof of Corollary 3. Given any measurement represented by vectors \vec{R}_i , construct a transformation with these vectors as the rows of M_1 , and with, say, $M_1 = M_2 = \dots = M'_n$. By Theorem 9, this transformation will be a convex combination of transformations of the form of that of Fig. 5. One way of doing the measurement is then to implement one of these transformations with the corresponding probability, and then to perform the fiducial measurement $X' = 0$. This procedure is equivalent to that of Fig. 6. \square

Proof of Theorem 10. Begin as before by showing that without loss of generality, the matrix M can be taken to have all entries ≥ 0 . This part of the proof is identical, except that to conditions (D2), (D3) and (D4), one should add the no-signalling constraints

$$\sum_j P(a = i, b = j | X, Y = 0) =$$

$$\sum_j P(a = i, b = j | X, Y = 1) \quad \forall i, X \quad (\text{D7})$$

$$\sum_i P(a = i, b = j | X = 0, Y) =$$

$$\sum_i P(a = i, b = j | X = 1, Y) \quad \forall j, Y. \quad (\text{D8})$$

Like the conditions (D2), these constraints can be written as the conjunction $\vec{D}_j \cdot \vec{P} \geq 0$ and $\vec{D}_j \cdot \vec{P} \leq 0$, and \vec{R} can be written in the form of Eq. (D5), hence in the form of Eq. (D6). Now impose that $\vec{P}' = M \cdot \vec{P}$ is normalized for any allowed normalized \vec{P} , that is any \vec{P} that satisfies conditions (D2), (D3), (D4), (D7), and (D8). Proving that any such M represents a convex combination of transformations of the form of Fig. 7 (or the reversed form with respect to Alice and Bob) is a tedious brute force exercise that we omit. \square

Finally, the proof of Corollary 4 is essentially the same as the proof of Corollary 3. \square