

Creating Boolean Functions for the Five-EPR-Pair, Single-Error-Correcting Code

Jin-Yuan Hsieh¹ and Che-Ming Li²

¹Department of Mechanical Engineering, Ming Hsin University
of Science and Technology, Hsinchu 30401, Taiwan.

²Institute and Department of Electrophysics, National Chiao
Tung University, Hsinchu 30050, Taiwan.

December 4, 2018

Abstract

A quantum single-error-correcting scheme can be derived from a one-way entanglement purification protocol in purifying one Bell state from a finite block of five Bell states. The main issue to be concerned with in the theory of such an error-correction is to create specific linear Boolean functions that can transform the sixteen error syndromes occurring in the error-correcting code onto their mappings so that one Bell state is corrected whenever the other four in the finite block are measured. The Boolean function is performed under the effect of its associated sequence of basic quantum unilateral and bilateral operations. Previously, the Boolean function is created in use of the Monte Carlo computer search method. We introduce here a systematic scenario for creating the Boolean function and its associated sequence of operations so that we can do the job in an analytical way without any trial and error effort. Consequently, all possible Boolean functions can in principle be created by using our method. Furthermore, for a deduced Boolean function, we can also in the spirit of our method derive its best associated sequence of operations which may contain the least number of total operations or the least number of the bilateral XOR operations alone. Some results obtained in this work show the capability of our method in creating the Boolean function and its sequence of operations.

PACS: 03.67.Pp, 03.67.Hk, 42.50.Dv, 89.70.+c

1 Introduction

Entanglement plays an important role in quantum information processing for transmitting unknown quantum states via noisy channels from a sender to a receiver, such as quantum teleportation[1], quantum data compression[2], and quantum super-dense coding[3], etc.. To achieve a reliable transmission of the unknown states, pure maximally entangled pairs, typically the Einstein-Podolsky-Rosen (EPR) pairs, or the Bell-states, which are emerged from a

quantum resource and transmitted through a quantum channel, should be shared by the sender (Alice) and the receiver (Bob). Because of the presence of noise in the quantum channel, Alice and Bob therefore have to perform actions such as entanglement purification procedures in distilling pure entangled states from a larger number of impure entangled states. The entanglement purification protocol (EPP) allows Alice and Bob to perform local unitary transformations and measurements and even allows them to coordinate their actions through one-way or two-way classical communication. It, however, does not allow Alice and Bob to perform non-local actions nor to transmit fresh quantum states from one to the other. An EPP involving two-way communication is called a two-way EPP (2-EPP), in which both Alice and Bob need to know the results of measurement from each other. Typical 2-EPPs include the IBM protocol[4] and the Oxford protocol[5], which also belong to the recurrence method. On the other hand, a one-way EPP (1-EPP) requires only Alice to send her measurement result through classical channel to Bob, who when combining it with his own result can decide a following action to perform. Thus, the 1-EPP can produce pure maximally entangled pairs which are separated both in space and in time. The hashing protocol[6] and the breeding protocol[4] are examples of the 1-EPP.

Normally, the 2-EPP can be combined with the 1-EPP, such as a recurrence-hashing protocol, to produce a higher purification yield, defined by a ratio m/n , where m is the number of the purified useful pairs and n is the number of the input impure pairs. It is well known that if the final fidelity of the purified states $F \rightarrow 1$, i.e., if the the final state is almost of the wanted pure state, is required, then the initial number of the impure pairs should be $n \rightarrow \infty$ for both the 1-EPP and 2-EPP. As shown by Bennett et al.[6], the pure one way hashing and breeding protocols can produce a non-zero yield only when the fidelity of the purified states possessed by the input impure pairs is greater than $F \approx 0.8107$. Even the best 1-EPP, proposed by Shor and Smolin[7], can do the job only when the initial fidelity of the purified states exceeds $F \approx 0.8049$. When the 2-EPPs are performed, on the other hand, the input state becomes distillable if its fidelity of the purified states is greater than $F = 0.5$ [4][5]. So, in these senses, the 2-EPPs perform better than the 1-EPP when they are only used in conjunction with teleportation in offering a means of transmitting quantum information through noisy channels. The 1-EPP, however, by producing time-separated entanglement, can additionally be used to protect quantum states during storage in a noisy environment. This important feature then leads to the consequence that the 1-EPP, when combined with quantum teleportation, can always permit the creation of a quantum error-correcting code (QECC). Bennett et al.[6] have presented the equivalence between the 1-EPP and QECC. The QECC derived from a 1-EPP will have a code-rate equal to the yield of the 1-EPP and have a fidelity equal to the fidelity of the purified states produced by the 1-EPP. The one-way hashing protocol therefore can be interpreted as an error-correcting code which protects an arbitrary state in 2^m -dimensional Hilbert space from noise by employing qubit block of asymptotically large size n . It was shown[6] that the QECC derived from the one-way hashing protocol actually does its job better than the QECCs based on the linear-code theory of Calderbank and Shor[8] and Steane[9] in the sense that it has a higher rate than the latter ones. Nevertheless, as most of the QECCs [8-16] focused on employing qubits of finite block size n in protecting $m < n$ qubits from any error on no more than t qubits, Bennett et al.[6] have further discussed the possibility of transforming

the 1-EPP into a QECC in the same manner. They ended up with a QECC by showing how finite blocks of 5 EPR pairs can be purified in the presence of noise which only affects at most one of the Bell states. The theory of quantum error-corrections independently presented by Knill and Laflamme[17] has proved the block size $n = 5$ is the smallest and best case. So far, a 5-qubit, single-error-correcting code has been performed experimentally[18].

In the 5-EPR pair, single-error-correcting quantum block code, there are totally 16 possible blocks of Bell state (i.e., 16 error syndromes) to be dealt with; one corresponds to the Bell states without error and the remaining ones are those with one of three errors on only one of the five Bell states. When the block of Bell states is coded as a string of phase-amplitude bits, the quantum error-correction problem then turns out to create a classical Boolean function which can map exactly one on one the syndrome states onto others such that the first Bell state (if the five Bell states are numbered in order) is always the same when the remaining four are measured and found out to be the same. Associated with the Boolean function, there is a sequence of basic operations including uni-lateral and bi-lateral rotations acting on one Bell state and bi-lateral XORs (controlled-NOTs) acting on two Bell states to realize the QECC protocol. In fact, there are so many possible Boolean functions, and therefore so many corresponding sequences of operations, for such QECC protocols; some of them are more economic and feasible than the others because they need the least operations to complete the QECC procedures. Bennett et al.[6] have introduced the Monte Carlo method to numerically find out possible Boolean functions by randomly choosing the sequence of operations acting on randomly chosen states. Implementing the numerical Monte Carlo method, however, is not a systematic way and therefore is hard to find out all possible Boolean functions to complete the theory of the 5-EPR-pair QECC. Based on this reason, we are intended in this work to present a systemic method for establishing the Boolean functions and their corresponding sequences of operations for such QECCs.

The Monte Carlo method is a forward way of serial trial and error, i.e., during the procedure of creating the Boolean function, the mapped states of the 16 syndromes are consecutively checked to see if the Boolean words for measurement embedded in them are independent. In our method, an array of the independent Boolean words for measurements is prescribed, and then in the opposite direction of the Monte Carlo method, Boolean functions are established consistently in an easy way very similar to the transformation of an invertible matrix into the identity matrix by performing elementary row operations on the matrices following the theory of linear algebra. Since the transformation of a matrix is physically controlled by the operations mentioned above, the sequence of operations associated with the established Boolean function can be decided accordingly. It is therefore very easy to find out a Boolean function and its corresponding sequence of operations analytically and all possible solutions according to the prescribed array of Boolean words for measurement can be found if aided by a numerical program. In the next section, we will describe the derivation of the QECC from the 1-EPP used to purify a Bell state from a finite block of 5 Bell states. In section 3, we then describe in detail the systematic method for creating Boolean functions in the QECC. A typical example of the Boolean function is given to help interpreting the procedure of our method. In section 4, more results are given to show the capability of the present method and a brief discussion is also presented. A conclusion is given in the final section.

2 The 5-EPR-pair single-error-correcting code

The single-error-correcting code considered herein is schematically shown in Fig. 1, which plots the combination of the 1-EPP that purify finite blocks of five EPR pairs and the teleportation that safely transmit arbitrary states. Alice first prepares mixed states $\widehat{\mathbf{M}}$ by passing halves of one standard state among the Bell states $\Phi^\pm = (|00\rangle \pm |11\rangle)/\sqrt{2}$ and $\Psi^\pm = (|01\rangle \pm |10\rangle)/\sqrt{2}$ from source E and through noisy channel. For convenience, the state Φ^+ is considered as the standard Bell state in this work. The mixed state $\widehat{\mathbf{M}}$ is Bell diagonal under the restriction that the noise model is one-sided (i.e., N_A is absent), or effectively one-sided[6]. (In fact, any noise can be made effectively one-sided as a twirling operation performed by Alice and Bob can convert any bipartite mixed state into a Bell diagonal states or a Werner state.) Alice and Bob then perform the 1-EPP to yield perfectly entangled states (*, which may be singlets Ψ^- or any one of the triplets Ψ^+ and Φ^\pm) used to teleport an arbitrary state $|\xi\rangle$ safely from Alice to Bob, completing a QECC. In developing the theory of the 5-EPR-pair single-error-correcting code first introduced by Bennett et al.[6], the four Bell states are first coded as classical two-bit words, which read

$$\Phi^+ = 00, \Phi^- = 10, \Psi^+ = 01, \Psi^- = 11. \quad (1)$$

Here the left bits are high-order or phase bits used to identify the $+/-$ property and the right bits are low-order or amplitude bits used to identify the Φ/Ψ property. Consequently, each finite block of five Bell states used in the present QECC then can be represented by a ten-bit word, for example, $\Phi^+\Psi^-\Phi^+\Phi^+\Phi^+ = 0011000000$. Since only single error is allowed in the present model, and the error could be either a phase error ($\Phi^+ \rightarrow \Phi^-$), an amplitude error ($\Phi^+ \rightarrow \Psi^+$), or both ($\Phi^+ \rightarrow \Psi^-$)[11][13], therefore, after the action of noise N_B , there is a set of totally 16 possible ten-bit words defining the complete set of error syndromes to be dealt with. The error syndrome words are denoted by 16 Boolean valued ($\in \{0, 1\}$) vectors $x^{(i)}$, $i = 0, 1, 2, \dots, 15$, in a ten-dimensional vector space. Clearly, if we denote the null vector in the vector space by $x^{(0)} = 00\dots 00$, which represents the no-error state, and the three states in which the single error occurs on Bell state k , $k = 1, 2, \dots, 5$, by $x^{(3k-2)}$, $x^{(3k-1)}$, and $x^{(3k)}$, respectively, then the 16 error syndrome vectors can be subdivided into 5 four-groups denoted by $V_x^{(k)} = \{x^{(0)}, x^{(3k-2)}, x^{(3k-1)}, x^{(3k)}\}$, where $x^{(0)}$ is the identity element and the property $x^{(3k-2)} \oplus x^{(3k-1)} = x^{(3k)}$ holds (\oplus is the addition modulo 2). Excluding the null vector $x^{(0)}$, two distinct elements arbitrarily chosen from each of the 5 four-groups $V_x^{(k)}$ are independent to those chosen from the other four-groups, so 10 independent vectors can be chosen from the 5 four-groups to form a set of basis vectors spanning the 10-dimensional Boolean valued vector space. Meanwhile, all four-bit Boolean valued vectors, totally 16 and each denoted by $v^{(i)}$ in accord with error syndrome i , can also be subdivided into 5 four-groups $V_v^{(k)} = \{v^{(0)}, v^{(3k-2)}, v^{(3k-1)}, v^{(3k)}\}$, which are one-to-one isomorphic to the four-groups $V_x^{(k)}$ in the same manner that $v^{(0)} = 0000$ and

$$v^{(3k-2)} \oplus v^{(3k-1)} = v^{(3k)}, \quad k = 1, 2, \dots, 5. \quad (2)$$

One example of the correspondence between the four-groups $V_v^{(k)}$ and $V_x^{(k)}$ is shown in Table 1.

The 5-EPR-pair, single-error-correcting code then demands Alice and Bob to apply unitary transformations U_1 and U_2 in mapping $x^{(i)}$ onto other two-bit words $w^{(i)}$ which, when four of the five Bell states in a block are locally measured, should yield results represented by $v^{(i)}$. Thus the 16 vectors $w^{(i)}$ should also be subdivided into 5 four-groups $V_w^{(k)}$ accordingly. The measurement results should be distinguished by reading the low bits of the measured Bell states so the ten-bit word $w^{(i)}$ in fact has its four low bits of the measured Bell states denoted by $v^{(i)}$. Without loss of generality, in what follows the four components of $v^{(i)}$ are located at the 4th, 6th, 8th, and 10th components of $w^{(i)}$, respectively. The state of the remaining unmeasured EPR pair then is represented by a truncated word $w'^{(i)}$, the first two bits of the vector $w^{(i)}$, for every error syndrome i . A successful error-correction should require that, whatever $w'^{(i)}$ is, Bob can always perform a corresponding rotation $U_3^{(i)}$ on it and restore it to the standard state $\Phi^+ = 00$, or any one of the other Bell states, after learning the measurement results $v^{(i)}$. The unilateral rotation $U_3^{(i)}$ performed by Bob can be either one element of the Pauli group $\{\mathbf{1}, \sigma_x, \sigma_y, \sigma_z\}$, which, if the remaining unmeasured Bell state is to be restored to the standard Φ^+ , for example, can do the transformations

$$\begin{aligned}
\mathbf{1} & : \Phi^+(00) \rightarrow \Phi^+(00), \\
\sigma_x & : \Psi^+(01) \rightarrow \Phi^+(00), \\
\sigma_y & : \Psi^-(11) \rightarrow \Phi^+(00), \\
\sigma_z & : \Phi^-(10) \rightarrow \Phi^+(00).
\end{aligned} \tag{3}$$

respectively.

The unmeasured Bell states, coded by $w'^{(i)}$, and the corresponding Pauli rotations $U_3^{(i)}$, can be decided by Bob after he has learned the measurement results $v^{(i)}$, if both Alice and Bob have pre-agreed with prescribed unitary transformation U_1 and U_2 , which represent a sequence of unilateral and bilateral operations performing the transformations $x^{(i)} \rightarrow w^{(i)}$. In EPPs, and in the QECCs derived from them, a Bell state is transformed into another under some typical unitary operations performed by either Alice or Bob, but not both, and bilateral operations that require both Alice and Bob to perform a same transformation on their spins. The typical unilateral operations include the Pauli transformations σ_x , σ_y , and σ_z , which perform a π rotation of Alice or Bob's spin about the x -, y -, and z -axis, respectively. The typical bilateral operations, on the other hand, can be either the operations denoted by B_x , B_y , and B_z that require both Alice and Bob to perform a $\pi/2$ rotation of their spins in an EPR pair about the x -, y -, and z -axis, respectively, or a bilateral XOR (BXOR) that requires both Alice and Bob to perform a controlled NOT operation on their spins in common source and target pairs. In the present 5-EPR-pair QECC, however, Alice and Bob are only confined to performing a sequence of four particular operations which can do anything required in the transformations $x^{(i)} \rightarrow w^{(i)}$. The four basic operations include: (1) a BXOR, which, in our classical bit representation, performs the transformation $(x_S, y_S)(x_T, y_T) \rightarrow (x_S \oplus x_T, y_S)(x_T, y_S \oplus y_T)$, where the subscripts S and T denote the source and target pairs, respectively; (2) a bilateral $\pi/2$ rotation B_y , which performs $(x, y) \rightarrow (y, x)$; (3) a composite operation $\sigma_x B_x$, which performs $(x, y) \rightarrow (x, x \oplus y)$; and (4) a unilateral π rotation σ_z , which complements the high bit of an EPR pair, viz., $(x, y) \rightarrow (x \oplus 1, y)$.

The effect of such a sequence of the four basic operations mentioned above is to apply a linear Boolean function mapping $x^{(i)}$ onto $w^{(i)}$, which can also be written by a matrix equation

$$w^{(i)} = \mathbf{M}_{wx}x^{(i)} \oplus b, \quad (4)$$

where \mathbf{M}_{wx} is a 10×10 invertible matrix (i.e., $\det(\mathbf{M}_{wx}) = 1$) defined in the 10-dimensional Boolean valued vector space and the Boolean valued vector b corresponds to the mapping of the null vector $x^{(0)}$, $b = w^{(0)}$. Without loss of generality, in what follows, $b = 00\dots00$ is assumed so that the unilateral operation σ_z can be excluded from the sequence of operations, i.e., the Boolean function is reduced to be

$$w^{(i)} = \mathbf{M}_{wx}x^{(i)}, \quad (5)$$

where the null vector $x^{(0)}$ thus remains unchanged under the transformation. Usually, an n -dimensional vector is represented by an $n \times 1$ column matrix, then eq. (5) in fact implies

$$\mathbf{M}_w = \mathbf{M}_{wx}\mathbf{I}_x, \quad (6)$$

with

$$\mathbf{M}_w = [w^{(1)}w^{(2)}w^{(4)}w^{(5)}w^{(7)}w^{(8)}w^{(10)}w^{(11)}w^{(13)}w^{(14)}], \quad (7)$$

$$\mathbf{I}_x = [x^{(1)}x^{(2)}x^{(4)}x^{(5)}x^{(7)}x^{(8)}x^{(10)}x^{(11)}x^{(13)}x^{(14)}], \quad (8)$$

where $w^{(3k-2)}, w^{(3k-1)} \in V_w^{(k)}$ and $x^{(3k-2)}, x^{(3k-1)} \in V_x^{(k)}$, $k = 1, 2, \dots, 5$. Note that we can always convert the matrix \mathbf{I}_x (8) to the 10×10 identity matrix \mathbf{I}_{10} , by adding columns to columns (in their associated four-groups) and interchanging columns in \mathbf{I}_x . Since each column of the matrix \mathbf{M}_w (7) should have its 4th, 6th, 8th, and 10th components forming a measurement-result vector, an array for the measurement results can be written by

$$\begin{aligned} \mathbf{M}_v &= [v^{(1)}v^{(2)}v^{(4)}v^{(5)}v^{(7)}v^{(8)}v^{(10)}v^{(11)}v^{(13)}v^{(14)}] \\ &= \mathbf{M}_{vw}\mathbf{M}_w, \end{aligned} \quad (9)$$

where

$$\mathbf{M}_{vw} = \begin{bmatrix} 0 & 0 & 0 & 1 & 0 & 0 & 0 & 0 & 0 & 0 \\ 0 & 0 & 0 & 0 & 0 & 1 & 0 & 0 & 0 & 0 \\ 0 & 0 & 0 & 0 & 0 & 0 & 0 & 1 & 0 & 0 \\ 0 & 0 & 0 & 0 & 0 & 0 & 0 & 0 & 0 & 1 \end{bmatrix}. \quad (10)$$

In order to achieve a successful error-correction, the ten measurement-result vectors $v^{(3k-2)}$ and $v^{(3k-1)}$ appearing in \mathbf{M}_v (9), the distinct five vectors $v^{(3k)}$ derived from eq. (2), and the null vector $v^{(0)}$ should form the complete 4-dimensional Boolean valued vector space. Therefore, a suitable array of the measurement-result vectors can be given by

$$\mathbf{M}_v = \begin{bmatrix} 1 & 0 & 0 & 1 & 0 & 0 & 0 & 1 & 1 & 0 \\ 0 & 0 & 1 & 0 & 1 & 1 & 1 & 1 & 1 & 0 \\ 0 & 1 & 0 & 0 & 0 & 1 & 1 & 0 & 1 & 0 \\ 0 & 0 & 0 & 1 & 1 & 0 & 1 & 0 & 0 & 1 \end{bmatrix}, \quad (11)$$

for instance.

The main issue in the theory of the present QECC now turns out to be the creation of a Boolean function $x^{(i)} \rightarrow w^{(i)}$, or simply the creation of the matrix \mathbf{M}_w (7), the effect of a specific sequence of the basic operations BXOR, B_y , and $\sigma_x B_x$. To create Boolean functions, Bennett et al.[6] performed a Monte Carlo computer search for the corresponding sequence of the four basic operations representing the actions of unitary transformations U_1 and U_2 . Their program randomly selects one of the four basic operations and randomly selects a Bell state or pair of Bell states to which to apply the operation. Then the program checks if the resulting set of states $w^{(i)}$ results in the success of an error-correction; if not, the program then repeats the procedure by adding another random operation. Basically, the approach that Bennett et al. implemented is a tedious numerical method of trial and error performing the transformation $\mathbf{I}_x \rightarrow \mathbf{M}_w$ subject to a "forward" sequence of the four basic operations. In this work, we will present an analytical method for creating Boolean functions implemented in the present QECC. The method to be introduced is in fact an inverse way to the Monte Carlo method. In the method, the inverse transformation $\mathbf{M}_w \rightarrow \mathbf{I}_x$ is considered to be performed subject to a "backward" sequence of operations, which is exactly in reverse order of the "forward" one corresponding to the transformation $\mathbf{I}_x \rightarrow \mathbf{M}_w$ because each basic operation used in the QECC is its own inverse operation. The present method will be described in detail in the following section.

3 The present method

In deducing the analytical method for creating Boolean functions for the 5-EPR-pair, single-error-correcting code, the 10×10 matrix \mathbf{M}_w is sometimes rewritten in an alternative form of a 5×5 matrix whose elements are 2×2 matrices, namely, the matrix can be expressed by

$$\mathbf{M}_w = \begin{bmatrix} m_{11} & m_{12} & \cdots & m_{15} \\ m_{21} & m_{22} & \cdots & m_{25} \\ \vdots & \vdots & & \vdots \\ m_{51} & m_{52} & \cdots & m_{55} \end{bmatrix}, \quad (12)$$

where the rows enumerate the five Bell states in a block and the columns correspond to the five four-groups $V_w^{(k)}$, respectively. Similarly, the original 10×10 matrix \mathbf{I}_x can also be rewritten in a form of 5×5 matrix, such that each column and each row of the 5×5 matrix will have one 2×2 element of determinant 1 and four 2×2 zero matrices. Now, if an array of the measurement result vectors suitable for a successful error-correction is prescribed, the job in principle is to perform the transformation $\mathbf{M}_w \rightarrow \mathbf{I}_x$ using elementary row operations on the matrix subject to the effect of a sequence of the basic operations BXOR, B_y , and $\sigma_x B_x$.

The first step of the present method is to designate a suitable array of the measurement result vectors $v^{(i)}$, in which the five four-groups $V_v^{(k)}$ are constructed. In this work, the array of $v^{(i)}$ shown in (11) is taken as the designation and then a suitable matrix \mathbf{M}_w is assumed for a successful error-correction. The assumed matrix is written by

$$\mathbf{M}_w = \begin{bmatrix} a_1 & a_2 & a_3 & a_4 & a_5 & a_6 & a_7 & a_8 & a_9 & a_{10} \\ b_1 & b_2 & b_3 & b_4 & b_5 & b_6 & b_7 & b_8 & b_9 & b_{10} \\ c_1 & c_2 & c_3 & c_4 & c_5 & c_6 & c_7 & c_8 & c_9 & c_{10} \\ 1 & 0 & 0 & 1 & 0 & 0 & 0 & 1 & 1 & 0 \\ d_1 & d_2 & d_3 & d_4 & d_5 & d_6 & d_7 & d_8 & d_9 & d_{10} \\ 0 & 0 & 1 & 0 & 1 & 1 & 1 & 1 & 1 & 0 \\ e_1 & e_2 & e_3 & e_4 & e_5 & e_6 & e_7 & e_8 & e_9 & e_{10} \\ 0 & 1 & 0 & 0 & 0 & 1 & 1 & 0 & 1 & 0 \\ f_1 & f_2 & f_3 & f_4 & f_5 & f_6 & f_7 & f_8 & f_9 & f_{10} \\ 0 & 0 & 0 & 1 & 1 & 0 & 1 & 0 & 0 & 1 \end{bmatrix}, \quad (13)$$

where, in the representation of 5×5 matrix, the 2×2 elements are

$$m_{11} = \begin{bmatrix} a_1 & a_2 \\ b_1 & b_2 \end{bmatrix}, \quad m_{21} = \begin{bmatrix} c_1 & c_2 \\ 1 & 0 \end{bmatrix}, \quad \dots,$$

and so forth. Here all the unknowns $a_r, b_r, \dots, f_r, r = 1, 2, \dots, 10$, are Boolean valued. The next step of our method is a procedure of elementary row operations on the matrix \mathbf{M}_w (13), subject to a suitable sequence of the basic operations. When the assumed matrix \mathbf{M}_w is transformed into a matrix \mathbf{I}_x under the series of row operations, the unknowns a_r, b_r, \dots, f_r will be solved stepwise in accord with the structure of \mathbf{I}_x . It is easy to show a sequence of row operations can do the transformation on, say, Bell states α and β in a four-group enumerated by γ ,

$$\begin{bmatrix} m_{\alpha\gamma} \\ m_{\beta\gamma} \end{bmatrix} \rightarrow \begin{bmatrix} e \\ 0 \end{bmatrix}, \quad (14)$$

provided that $\det(m_{\alpha\gamma}) = 1$ and $\det(m_{\beta\gamma}) = 0$. Here e denotes any one of the six possibilities for a 2×2 matrix whose determinant is unity. ($m_{\alpha\gamma}$ in fact should belong to one of the possibilities.) For example, the consecutive transformation

$$\begin{bmatrix} m_{\alpha\gamma} \\ m_{\beta\gamma} \end{bmatrix} = \begin{bmatrix} 1 & 0 \\ 0 & 1 \\ 1 & 1 \\ 0 & 0 \end{bmatrix} \rightarrow \begin{bmatrix} 1 & 0 \\ 0 & 1 \\ 0 & 0 \\ 1 & 1 \end{bmatrix} \rightarrow \begin{bmatrix} 1 & 0 \\ 1 & 1 \\ 0 & 0 \\ 1 & 1 \end{bmatrix} \rightarrow \begin{bmatrix} 1 & 0 \\ 1 & 1 \\ 0 & 0 \\ 0 & 0 \end{bmatrix}$$

can be accomplished if the operation B_y is first performed on Bell state β , then a $\sigma_x B_x$ is performed on Bell state α followed by a BXOR performed on both states, as Bell state α being the source and Bell state β being the target. Based on the requirement for the transformation described in (14) and the unique structure of the matrix \mathbf{I}_x , the series of row operations is described stepwise in what follows. It then will be found that the present method is a systematic one for solving the unknowns assumed in the matrix \mathbf{M}_w (13).

In the first stage of row operations, we are confined to performing a transformation of the matrix \mathbf{M}_w (13) such that $m_{11} \rightarrow e$ and $m_{1k}, m_{k1} \rightarrow 0$, $k = 2, 3, 4, \text{and } 5$, according to the structure of I_x . Based on an extension of the requirement for the row operations (14), let $\det(m_{11}) = 1$ and $\det(m_{21}) = \dots = \det(m_{51}) = 0$, which imply

$$a_1 b_2 \oplus a_2 b_1 = 1, \quad c_2 = 0, \quad e_1 = 0, \quad \text{and } c_1, d_1, d_2, e_2, f_1, f_2 \in \{0, 1\}. \quad (15)$$

Clearly, there are totally 384 solutions for the unknowns appearing in (13) to be considered in this stage. (6 for the condition $a_1 b_2 \oplus a_2 b_1 = 1$, 2 for each of the 6 arbitrary Boolean valued unknowns, and thus totally $6 \times 2^6 = 384$ solutions) To show the systematic way of creating Boolean functions, however, only one among these 384 cases is considered. To proceed, let us consider the case in which

$$a_1 = b_2 = 1, \quad a_2 = b_1 = c_1 = c_2 = d_1 = d_2 = e_1 = e_2 = f_1 = f_2 = 0, \quad (16)$$

Then simply by performing the operations shown in Fig. 2(a), we have the transformation $\mathbf{M}_w \rightarrow \mathbf{M}'_w$,

$$\begin{aligned} \mathbf{M}'_w &= \begin{bmatrix} 1 & 0 & 0 & 0 & 0 & 0 & 0 & 0 & 0 & 0 \\ 0 & 1 & 0 & 0 & 0 & 0 & 0 & 0 & 0 & 0 \\ 0 & 0 & c_3 & c_4 & c_5 & c_6 & c_7 & c_8 & c_9 & c_{10} \\ 0 & 0 & a_3 & 1 \oplus a_4 & a_5 & a_6 & a_7 & 1 \oplus a_8 & 1 \oplus a_9 & a_{10} \\ 0 & 0 & d_3 & d_4 & d_5 & d_6 & d_7 & d_8 & d_9 & d_{10} \\ 0 & 0 & 1 & 0 & 1 & 1 & 1 & 1 & 1 & 0 \\ 0 & 0 & e_3 & e_4 & e_5 & e_6 & e_7 & e_8 & e_9 & e_{10} \\ 0 & 0 & 0 & 0 & 0 & 1 & 1 & 0 & 1 & 0 \\ 0 & 0 & f_3 & f_4 & f_5 & f_6 & f_7 & f_8 & f_9 & f_{10} \\ 0 & 0 & 0 & 1 & 1 & 0 & 1 & 0 & 0 & 1 \end{bmatrix} \\ &= \begin{bmatrix} e & 0 & 0 & 0 & 0 \\ 0 & m'_{22} & m'_{23} & m'_{24} & m'_{25} \\ 0 & m'_{32} & m'_{33} & m'_{34} & m'_{35} \\ 0 & m'_{42} & m'_{43} & m'_{44} & m'_{45} \\ 0 & m'_{52} & m'_{53} & m'_{54} & m'_{55} \end{bmatrix} \end{aligned} \quad (17)$$

and the equations

$$a_r \oplus e_r = 0, \quad (18)$$

$$b_r \oplus c_r = 0, \quad r = 3, 4, \dots, 10. \quad (19)$$

Here eqs. (18) and (19) are derived from the zero elements in the first row of the 5×5 \mathbf{M}'_w (17). So, we now have, in columns 2 to 5 of the 5×5 \mathbf{M}'_w (17), the unknowns c_r, d_r, e_r , and, f_r remained to be solved because $a_r = e_r$ and $b_r = c_r$, from eqs. (18) and (19). At the end of this stage, we should isolate Bell state 1 from being influenced by the following actions, i.e., we

from now on should maintain the first row and column of the 5×5 \mathbf{M}'_w . We emphasize here that the other 383 solutions can be analyzed following the same way of obtaining the resulting matrix \mathbf{M}'_w (17) in this stage. Of course, we can also obtain multi-solution cases rather than the present cases if we interchange the first column and the others in the assumed 5×5 matrix \mathbf{M}_w (13) and follow the same procedure of the first stage. But this is not an important issue to be considered in this work, for we are presenting a systematic method of creating Boolean functions involved in the present QECC.

In the second stage of row operations, we will consider the general cases that one of the elements in the second column of the 5×5 \mathbf{M}'_w . (17) has determinant of unity and the other elements in the same column have zero determinants. Three cases therefore need to be considered in this stage. These cases are

$$(A) \quad c_3(1 \oplus e_4) \oplus c_4e_3 = 1, \quad d_4 = 0, \quad f_3 = 0, \quad \text{and } d_3, d_4 \in \{0, 1\}; \quad (20)$$

$$(B) \quad c_3(1 \oplus e_4) \oplus c_4e_3 = 0, \quad d_4 = 1, \quad f_3 = 0, \quad \text{and } d_3, d_4 \in \{0, 1\}; \quad (21)$$

$$(C) \quad c_3(1 \oplus e_4) \oplus c_4e_3 = 0, \quad d_4 = 0, \quad f_3 = 1, \quad \text{and } d_3, d_4 \in \{0, 1\}. \quad (22)$$

In these cases, there are 104 possible solutions for the unknowns appearing in the above equations. We should, however, remember that these solutions only belong to the one case considered in the first stage. We also note here that if we interchange in the preceding stage the operating order of the two BXOR's and their accompanying B_y 's shown in Fig. 2(a), then in the present stage we will instead have only 72 possible solutions grouped into 4 cases. We therefore should consider the most general cases shown in eqs (20)-(22) in determining the assumed matrix \mathbf{M}_w . Let us now consider the solution, denoted by (A1), in which

$$(A1) \quad c_3 = 1 \text{ and } c_4 = d_3 = d_4 = e_3 = e_4 = f_3 = f_4 = 0, \quad (23)$$

to continue our analysis. Under this solution, we then perform the operations shown in Fig. 2(b), obtaining the resulting matrix

$$\mathbf{M}''_w = \begin{bmatrix} 1 & 0 & 0 & 0 & 0 & 0 & 0 & 0 & 0 & 0 & 0 \\ 0 & 1 & 0 & 0 & 0 & 0 & 0 & 0 & 0 & 0 & 0 \\ 0 & 0 & 1 & 0 & 0 & 0 & 0 & 0 & 0 & 0 & 0 \\ 0 & 0 & 0 & 1 & 0 & 0 & 0 & 0 & 0 & 0 & 0 \\ 0 & 0 & 0 & 0 & d_5 & d_6 & d_7 & d_8 & d_9 & d_{10} & \\ 0 & 0 & 0 & 0 & 1 & 1 & 1 & 1 & 1 & 1 & 0 \\ 0 & 0 & 0 & 0 & e_5 & e_6 & e_7 & e_8 & e_9 & e_{10} & \\ 0 & 0 & 0 & 0 & 0 & 1 & 1 & 0 & 1 & 0 & \\ 0 & 0 & 0 & 0 & f_5 & f_6 & f_7 & f_8 & f_9 & f_{10} & \\ 0 & 0 & 0 & 0 & 1 \oplus e_5 & e_6 & 1 \oplus e_7 & 1 \oplus e_8 & 1 \oplus e_9 & 1 \oplus e_{10} & \end{bmatrix}$$

$$= \begin{bmatrix} \mathbf{e} & 0 & 0 & 0 & 0 \\ 0 & \mathbf{e} & 0 & 0 & 0 \\ 0 & 0 & m''_{33} & m''_{34} & m''_{35} \\ 0 & 0 & m''_{43} & m''_{44} & m''_{45} \\ 0 & 0 & m''_{53} & m''_{54} & m''_{55} \end{bmatrix} \quad (24)$$

and the equations

$$c_r \oplus f_r = 0, \quad r = 5, 6, \dots, 10 \quad (25)$$

$$d_5 = e_5, \quad d_6 = e_6, \quad d_7 = e_7, \quad d_8 \oplus e_8 = 1, \quad d_9 \oplus e_9 = 1, \quad d_{10} = e_{10}. \quad (26)$$

Here, again, eqs. (25) and (26) are derived from the zero elements in the second row of the 5×5 matrix M''_w (24). Using eqs. (25) and (26), we now have only the remaining unknowns e_r and f_r , $r = 5, 6, \dots, 10$, to solve, so only one additional stage of row operations is needed in what follows. At the end of this stage, we should isolate both Bell state 1 and 2 from being influenced by the following actions.

Following the same procedure as in the above stages, in the final stage, we can perform transformations grouped into three cases and solve the remaining unknowns subject to the corresponding final operations, respectively. These three cases of transformation include

$$(A1\alpha) \quad m''_{33} \rightarrow e \text{ and } m''_{43}, m''_{53}, m''_{34}, m''_{35} \rightarrow 0; \quad (27)$$

$$(A1\beta) \quad m''_{43} \rightarrow e \text{ and } m''_{33}, m''_{53}, m''_{44}, m''_{45} \rightarrow 0; \quad (28)$$

$$(A1\gamma) \quad m''_{53} \rightarrow e \text{ and } m''_{33}, m''_{43}, m''_{54}, m''_{55} \rightarrow 0. \quad (29)$$

Then, when eqs. (25) and (26) are used, we should perform the transformations in cases (A1 α), (A1 β), and (A1 γ) under the constraints

$$e_5 \oplus e_6 = 1, \quad e_5 = 0, \quad f_5 e_6 \oplus f_6 (1 \oplus e_5) = 0, \quad \text{for case (A1}\alpha\text{)}; \quad (30)$$

$$e_5 \oplus e_6 = 0, \quad e_5 = 1, \quad f_5 e_6 \oplus f_6 (1 \oplus e_5) = 0, \quad \text{for case (A1}\beta\text{)}; \quad (31)$$

$$e_5 \oplus e_6 = 0, \quad e_5 = 0, \quad f_5 e_6 \oplus f_6 (1 \oplus e_5) = 1, \quad \text{for case (A1}\gamma\text{)}, \quad (32)$$

respectively. Each of the above equations leads to two final results. We shall denote them by

$$(A1\alpha 1) \quad e_5 = 0, \quad e_6 = 1, \quad f_5 = f_6 = 0; \quad (33)$$

$$(A1\alpha 2) \quad e_5 = 0, \quad e_6 = 1, \quad f_5 = f_6 = 1; \quad (34)$$

$$(A1\beta 1) \quad e_5 = e_6 = 1, \quad f_5 = f_6 = 0; \quad (35)$$

$$(A1\beta 2) \quad e_5 = e_6 = 1, \quad f_5 = 0, \quad f_6 = 1; \quad (36)$$

$$(A1\gamma1) \quad e_5 = e_6 = 0, \quad f_5 = 0, \quad f_6 = 1; \quad (37)$$

$$(A1\gamma2) \quad e_5 = e_6 = 0, \quad f_5 = f_6 = 1, \quad (38)$$

respectively. Again, if we in the second stage of row operations interchange the operating order of the two BXOR's shown in Fig.2(b), then we will instead in this stage have 5 solutions subgrouped into 3 cases. The solution of case (A1 β 2) will be missed in this situation, so we should consider the general cases given by (30)-(32), which lead to the 6 solutions (33)-(38). Now, let us consider the case (A1 α 1). Using the result shown in (33), we first perform the transformations $m''_{33} \rightarrow e$ and $m''_{43}, m''_{53} \rightarrow 0$ subject to suitable corresponding operations, then when letting the transformations $m''_{34}, m''_{35} \rightarrow 0$ to occur we obtain the final result for the remaining unknowns e_r and f_r for $r = 7, 8, 9, 10$. The final result itself then leads to the unique final transformations $m''_{44}, m''_{55} \rightarrow e$ and $m''_{54}, m''_{45} \rightarrow 0$ when suitable operations are performed correspondingly. The suitable operations performed in this stage are shown in Fig. 2(c) and the final result reads

$$\begin{aligned} e_7 &= 0, \quad e_8 = 1, \quad e_9 = 0, \quad e_{10} = 0, \\ f_1 &= 0, \quad f_8 = 0, \quad f_9 = 1, \quad f_{10} = 0, \end{aligned} \quad (39)$$

for case (A1 α 1).

Summarizing the results (39), (33), (23), (16), incorporated with (25), (26), (18), and (19), we now can construct the Boolean function for the case (A1 α 1) at the end of the final stage of row operations, in which the obtained matrix M_w is expressed by

$$\mathbf{M}_{w(A1\alpha1)} = \begin{bmatrix} 1 & 0 & 0 & 0 & 0 & 1 & 0 & 1 & 0 & 0 \\ 0 & 1 & 1 & 0 & 0 & 0 & 0 & 0 & 1 & 0 \\ 0 & 0 & 1 & 0 & 0 & 0 & 0 & 0 & 1 & 0 \\ 1 & 0 & 0 & 1 & 0 & 0 & 0 & 1 & 1 & 0 \\ 0 & 0 & 0 & 0 & 0 & 1 & 0 & 0 & 1 & 0 \\ 0 & 0 & 1 & 0 & 1 & 1 & 1 & 1 & 1 & 0 \\ 0 & 0 & 0 & 0 & 0 & 1 & 0 & 1 & 0 & 0 \\ 0 & 1 & 0 & 0 & 0 & 1 & 1 & 0 & 1 & 0 \\ 0 & 0 & 0 & 0 & 0 & 0 & 0 & 0 & 1 & 0 \\ 0 & 0 & 0 & 1 & 1 & 0 & 1 & 0 & 0 & 1 \end{bmatrix}, \quad (40)$$

which is exactly the same as the one given by Bennett et al.[6] (shown in eq. (77) of their article). A whole sequence of basic operations, as shown in Fig. 3(a), is obtained by combining the three sub-sequences shown in Figs. 2(a)-(c), which will transform the matrix $\mathbf{M}_{w(A1\alpha1)}$ (40) into the matrix \mathbf{I}_x expressed by

$$\mathbf{I}_x = \begin{bmatrix} 1 & 0 & & & & & & & & \\ 0 & 1 & & & & & & & & \\ & & 1 & 0 & & & & & & \\ & & 0 & 1 & & & & 0 & & \\ & & & & 0 & 1 & & & & \\ & & & & 1 & 0 & & & & \\ & & & & & & & & & \\ & & 0 & & & & 1 & 1 & & \\ & & & & & & 0 & 1 & & \\ & & & & & & & & & \\ & & & & & & & & & 1 & 0 \\ & & & & & & & & & 0 & 1 \end{bmatrix}. \quad (41)$$

Reading the sequence of operations shown in Fig. 3(a), and all in other figures, we should keep in mind that a "backward" transformation $\mathbf{M}_w \rightarrow \mathbf{I}_x$ is accomplished by performing the operations in the order from left to right, while a "forward" transformation $\mathbf{I}_x \rightarrow \mathbf{M}_w$ is implied to be undertaken by performing the operations exactly in the reverse order, i.e., from right to left.

The rule of row operations on a given matrix \mathbf{M}_w , such as the one shown in (40), however, indicates that we can transform the given matrix \mathbf{M}_w in several ways into its corresponding \mathbf{I}_x 's, implying there are several sequences of operations which can convert the same given matrix \mathbf{M}_w to distinct \mathbf{I}_x 's. Most importantly, this also implies that we can seek a best sequence of operations which consists of either the least number of total operations or the least number of the BXOR operations alone, under a fixed correspondence between the unmeasured states (the codewords in the first two rows of the given 10×10 \mathbf{M}_w) and the prescribed measurement result vectors (embedded in \mathbf{M}_w) obtained from the given \mathbf{M}_w . So, the final step of our method is to seek a shortened sequence of operations according to the rule of row operations on the matrix \mathbf{M}_w obtained in the preceding step. This step begins with the "starting" sequence of operations constructed simply by combining the three sub-sequences used in the preceding step in obtaining a specific matrix \mathbf{M}_w for a successful error-correction. A systematic way to shorten the starting sequence of operations, is to re-display the complete row operations in transforming the specific \mathbf{M}_w into its corresponding \mathbf{I}_x 's under all the permutations of the BXOR's appearing in the starting sequence. We show in Fig. 3(b) an example of the shortened sequence of operations involved in transforming the matrix \mathbf{M}_w shown in (40) into the matrix

$$\mathbf{I}_x = \begin{bmatrix} 1 & 0 & & & & & & & & \\ 0 & 1 & & & & & & & & \\ & & 0 & 1 & & & & & & \\ & & 1 & 0 & & & & 0 & & \\ & & & & 0 & 1 & & & & \\ & & & & 1 & 0 & & & & \\ & & & & & & & & & \\ & & 0 & & & & 0 & 1 & & \\ & & & & & & 1 & 1 & & \\ & & & & & & & & & 1 & 0 \\ & & & & & & & & & 1 & 1 \end{bmatrix} \quad (42)$$

Clearly, the new version shown in Fig 3 (b) is a result obtained when we interchange the first two BXOR's in the original sequence of operations shown in Fig. 3(a); It consists of only ten operations in which seven BXOR's are required. The two sequences shown in Fig. 3 are of course different, resulting in distinct \mathbf{I}_x 's, as shown in (41) and (42), but they are equivalent because they both lead to the same correspondence between the unmeasured states and the prescribed measurement result vectors, as tabulated in Table 2 and named by case (A1 α 1).

4 Results and Discussion

In the preceding section we have shown the complete procedure for creating Boolean functions involved in the present 5-EPR pair, single -error-correcting code. We have given an example of the Boolean functions derived by using the present method, namely, the given matrix \mathbf{M}_w in (40) and its best corresponding sequence of operations shown in Fig. 3(b). To show more examples, we have also analyzed the cases (A1 α 2), (A1 β 1), (A1 β 2), (A1 γ 1), and (A1 γ 2), in which the choices (16), (23), and (33)-(38) are taken, respectively. Their final correspondences between the unmeasured Bell states and the measurement results are shown in Table 2 and the gate arrays of the corresponding sequences of operations are shown in Fig. 4. It is found that the sequence of operations shown in Fig. 4(e) for the case (A1 γ 2) contains only six BXOR's, while the others, including the one shown in Fig. 3(b) and those shown in Figs. 4(a)-(d), all contain seven BXOR's. To perform a more reliable error-correcting protocol, we may require to construct a Boolean function under the effect of a sequence of operations containing fewer BXOR's since two-bit operations could be more difficult ones to implement in a physical apparatus [19], so the sequence of operations for the case (A1 γ 2) may be crucially important. Indeed, there are many Boolean functions in which the sequences of operations contain only six BXOR's. Using our systematic method, it becomes relatively easier than using the numerical Monte Carlo method to find out such Boolean functions. In principle, it can be easily done to find sequences containing only six BXOR operations if we can skillfully choose suitable solutions and apply operations in suitable order so that more zero elements are present both in the second column of the 5×5 matrix \mathbf{M}'_w (17) and the third column of 5×5 \mathbf{M}''_w matrix (24). For instance, if we maintain the same choice (16) in the first stage of row operations, then choose the solution in which $c_3 = c_4 = d_3 = d_4 = e_3 = e_4 = f_4 = 0$ and $f_3 = 1$ as one of the cases (C) in the second stage of row operations, and finally choose $e_5 = e_6 = f_5 = f_6 = 0$ in the final stage of row operations, we eventually will construct a Boolean function in which the matrix \mathbf{M}_w is given by

$$\mathbf{M}_{w(C1\beta1)} = \begin{bmatrix} 1 & 0 & 0 & 0 & 0 & 0 & 1 & 0 & 0 & 1 \\ 0 & 1 & 0 & 0 & 0 & 0 & 0 & 1 & 1 & 1 \\ 0 & 0 & 0 & 0 & 0 & 0 & 0 & 1 & 1 & 1 \\ 1 & 0 & 0 & 1 & 0 & 0 & 0 & 1 & 1 & 0 \\ 0 & 0 & 0 & 0 & 1 & 0 & 1 & 0 & 0 & 1 \\ 0 & 0 & 1 & 0 & 1 & 1 & 1 & 1 & 1 & 0 \\ 0 & 0 & 0 & 0 & 0 & 0 & 1 & 0 & 0 & 1 \\ 0 & 1 & 0 & 0 & 0 & 1 & 1 & 0 & 1 & 0 \\ 0 & 0 & 1 & 0 & 0 & 0 & 0 & 1 & 1 & 1 \\ 0 & 0 & 0 & 1 & 1 & 0 & 1 & 0 & 0 & 1 \end{bmatrix}, \quad (43)$$

and the corresponding sequence of operations is shown in Fig. 5. It is found that such a sequence of operations contains only six BXOR's and three other operations; it is even better than the one in the case (A1 γ 2) since the latter contains six BXOR's but four other operations. The correspondence between the measured Bell states and the measurement results of such Boolean function is also shown in Table 2, denoted as case (C1 β 1).

We have in this work presented some analytical results for the Boolean function under the fixed designation of measurement results as given by (11) and embedded in the assumed matrix shown by (13). If we name all of the solutions that can be obtained under the present designation of measurement results a solution group, then, following the same scenario in deducing the Boolean function, we can possibly obtain other solution groups under distinct arrangements of the measurement results. For example, based on the representation of 5×5 matrix for the assumed \mathbf{M}_w shown in (13), we in fact can choose any one of the five columns and locate it at the first column in accord with the confinement in the first stage of row operations interpreted in the preceding section. So, we conclude that there are totally 5 "independent" solution groups under such arrangements that can be obtained by using our method. Besides, possible designations of the array of measurement results can also be obtained by performing row operations on the given array (11). The solutions resulted from such designations, however, are distinct but "dependent" to those resulted from the original array (11) because they are distinct to each other only due to effects of some BXOR operations. For example, as we can change the first row of the array (11) by adding the second row to it and have a reduced array given by

$$\mathbf{M}_v = \begin{bmatrix} 1 & 0 & 1 & 1 & 1 & 1 & 1 & 0 & 0 & 0 \\ 0 & 0 & 1 & 0 & 1 & 1 & 1 & 1 & 1 & 0 \\ 0 & 1 & 0 & 0 & 0 & 1 & 1 & 0 & 1 & 0 \\ 0 & 0 & 0 & 1 & 1 & 0 & 1 & 0 & 0 & 1 \end{bmatrix}, \quad (44)$$

we then have dependent matrices \mathbf{M}_w different from those resulted from the designation (11) by only a BXOR operation acting on Bell states 2 (as the target) and 3 (as the source).

As a final result, there are so many possible Boolean functions subject to the prescribed array of measurement results (11) that can be implemented in the 5-EPR-pair, single-error-correcting code and they can be analytically derived by our systematic method. If all these Boolean functions are to be established, however, a computer program should be developed

following the present scenario to make it practical and feasible. The computer program to be developed should be capable to determine the suitable matrices M_w , then to reconstruct the best sequences of operations for the given matrices, and finally help to select the best Boolean functions which can be performed by least basic operations or least BXOR's. To develop the computer program, however, is not an issue to be concerned with in this work.

5 Conclusion

In this work a systematic method has been presented for creating Boolean functions required in the 5-EPR-pair, single-error-correcting code first introduced by Bennett et al.[6]. Although so far the 5-EPR-pair, single-error-correcting code has not been undertaken experimentally, we here have complemented the mathematical theory of the QECC by showing an analytical way for creating the required Boolean function. Distinct to the previously used Monte Carlo computer search, which may consume a lot of trial and error efforts, the present method can help creating the Boolean function in an analytical procedure. In the spirit of row operations on a matrix used in the present method, we are also capable to establish the best sequence of basic operations for every given Boolean function. We have given some analytical results of the Boolean function and the associated sequence of operations using the present method. Some of the results are better than the others because they require fewer number of total operations or fewer number of BXOR operations and then can make the QECC more reliable. The three systematic steps for deducing the present results that have been described in detail in the preceding sections have shown the scenario helpful in creating the Boolean function that are potentially useful in the 5-EPR-pair QECC. The effort to create all the Boolean functions, however, can be accomplished more efficiently if aided by a computer program designed in accord with the present scenario for creating the Boolean function.

i	$x^{(i)}$	$v^{(i)}$
0	0000000000	0000
1	1000000000	1000
2	0100000000	0010
3	1100000000	1010
4	0010000000	0100
5	0001000000	1001
6	0011000000	1101
7	0000100000	0101
8	0000010000	0110
9	0000110000	0011
10	0000001000	0111
11	0000000100	1100
12	0000001100	1011
13	0000000010	1110
14	0000000001	0001
15	0000000011	1111

Table 1. One possible correspondence between the error syndrome $x^{(i)}$ and the measurement-result vectors $v^{(i)}$. Note that the relations $x^{(3k-2)} \oplus x^{(3k-1)} = x^{(3k)}$ and $v^{(3k-2)} \oplus v^{(3k-1)} = v^{(3k)}$, $k = 1, 2, \dots, 5$, are satisfied.

i	$v^{(i)}$	$w^{(i)}(A1\alpha1)$	$(A1\alpha2)$	$(A1\beta1)$	$(A1\beta2)$	$(A1\gamma1)$	$(A1\gamma2)$	$(C1\beta1)$
0	0000	00	00	00	00	00	00	00
1	1000	10	10	10	10	10	10	10
2	0010	01	01	01	01	01	01	01
3	1010	11	11	11	11	11	11	11
4	0100	01	01	01	01	01	01	00
5	1001	00	00	00	00	00	00	00
6	1101	01	01	01	01	01	01	00
7	0101	00	01	10	10	00	01	00
8	0110	10	11	10	11	01	01	00
9	0011	10	10	00	01	01	00	00
10	0111	00	01	00	01	11	11	10
11	1100	10	10	00	01	01	00	01
12	1011	10	11	00	00	10	11	11
13	1110	01	00	11	11	01	00	01
14	0001	00	01	00	01	11	11	11
15	1111	01	01	11	10	10	11	10

Table 2. The correspondences between the measurement results, denoted by $v^{(i)}$, and the unmeasured Bell states, coded as $w'^{(i)}$, for the cases (A1 α 1) to (C1 β 1). The notation i enumerates the error syndromes in the QECC.

Figure caption.

Fig. 1. The 5-EPR-pair, single-error-correcting code is derived from the combination of the 1-EPR and teleportation schematically shown in this figure, with the notations used in the context. The 1-EPR results in perfectly entangled state (*) which are then used to teleport $|\xi\rangle$ safely from Alice to Bob, completing the QECC. The teleportation is initiated with Alice's Bell measurement M_4 and is completed by Bob's unitary transformation U_4 .

Fig. 2. The three quantum gate arrays performed in the stages of row operations: (a) for $\mathbf{M}_w \rightarrow \mathbf{M}'_w$; (b) for $\mathbf{M}'_w \rightarrow \mathbf{M}''_w$; and (c) for $\mathbf{M}''_w \rightarrow \mathbf{I}_x$.

Fig. 3. The quantum gate arrays used in the case (A1 α 1) for transforming the matrix $\mathbf{M}_{w(A1\alpha1)}$ into (a) \mathbf{I}_x (41) and (b) \mathbf{I}_x (42), respectively. In realistic situations, Alice and Bob should perform the sequences of operations in the direction from right to left.

Fig 4. The quantum gate arrays which may be used in the cases (A1 α 2), (A1 β 1), (A1 β 2), (A1 γ 1), and (A1 γ 2).

Fig. 5. The quantum gate array used in the case (C1 β 1). This sequence of operations contains only six BXOR's and three other operations.

References

- [1] C. H. Bennett, G. Brassard, C. Crepeau, R. Jozsa, A. Peres, and W. K. Wootters, "Teleporting an unknown quantum state via dual classical and Einstein-Podolsky-Rosen channels," *Phys. Rev. Lett.*, vol. 70, no. 13, pp. 1895-1899, 1993.
- [2] B. Schumacher, "Quantum Coding," *Phys. Rev. A*, vol. 51, no. 4, pp. 2738-2747, 1995.
- [3] C. H. Bennett and S. J. Wiesner, "Communication via One- and Two-particle Operators on Einstein-Podolsky-Rosen States," *Phys. Rev. Lett.*, vol. 69, pp. 2881-2884, 1992.
- [4] C. H. Bennett, G. Brassard, S. Popescu, B. Schumacher, J. A. Smolin, and W. K. Wootters, "Purification of Noisy Entanglement and Faithful Teleportation via Noisy Channels," *Phys. Rev. Lett.*, vol. 76, no.5, pp. 722-725, 1996.
- [5] D. Deutsch, A. Ekert, R. Jozsa, C. Macchiavello, S. Popescu, and A. Sanpera, "Quantum Privacy Amplification and the Security of Quantum Cryptography over Noisy Channels," *Phys. Rev. Lett.*, vol. 77, no. 13, pp. 2818-2821, 1996.
- [6] C. H. Bennett, D. P. DiVincenzo, J. A. Smolin, and W. K. Wootters, "Mixed-state Entanglement and Quantum Error Correction," *Phys. Rev. A*, vol. 54, no. 5, pp. 3824-3851, 1996.

- [7] P. W. Shor and J. A. Smolin, "Quantum Error-Correcting Codes Need Not Completely Reveal the Error Syndrome," Report No. quant-ph/9604006.
- [8] A. R. Calderbank and P. W. Shor, "Good Quantum Error-Correcting Codes Exist," *Phys. Rev. A* vol. 54, pp. 1098-1105, 1996.
- [9] A. M. Steane, "Error Correcting Codes in Quantum Theory," *Phys. Rev. Lett.*, vol. 76, pp. 793-797, 1996.
- [10] Isaac L. Chuang and Yoshihisa Yamamoto, "Quantum Bit Regeneration," *Phys. Rev. Lett.*, vol. 52, pp. 4281-4284, 1996.
- [11] P. W. Shor, "Scheme for Reducing Decoherence in Quantum Computer Memory," *Phys. Rev. A*, vol. 52, pp. 2493-2496, 1995.
- [12] Raymond Laflamme, Cesar Miquel, Juan Pablo Paz, and Wojciech Hubert Zurek, "Perfect Quantum Error Correcting Code," *Phys. Rev. Lett.*, vol. 77, pp. 198-201, 1996.
- [13] Artur Ekert and Chiara Macchiavello, "Quantum Error Correction for Communication," *Phys. Rev. Lett.*, vol. 77, pp. 2585-2588, 1996.
- [14] Samuel L. Braunstein, "Quantum Error Correction of Dephasing in 3 Qubits," Report No. quant-ph/9603024.
- [15] M. B. Plenio, V. Vedral, and P. L. Knight, "Conditional Generation of Error Syndromes in Fault-tolerant Error Correction," *Phys. Rev. A*, vol. 55, pp. 4593-4596, 1997.
- [16] Lev Vaidman, Lior Goldenberg, and Stephen Wiesner, "Error Prevention Scheme with Four Particles," *Phys. Rev. A*, vol. 54, pp. 1745-1748, 1996.
- [17] Emanuel Knill and Raymond Laflamme, "A Theory of Quantum Error-Correcting Codes," Report No. quant-ph/9604034; Emanuel Knill¹, Raymond Laflamme and Lorenza Viola, "Theory of Quantum Error Correction for General Noise," *Phys. Rev. Lett.*, vol. 84 pp. 2525-2528, 2000.
- [18] E. Knill, R. Laflamme, R. Martinez, and C. Negrevergne, "Benchmarking Quantum Computers: The Five-Qubit Error Correcting Code," *Phys. Rev. Lett.*, vol. 86, pp. 5811-5814, 2001.
- [19] Adriano Barenco, Charles H. Bennett, Richard Cleve, David P. DiVincenzo, Norman Margolus, Peter Shor, Tycho Sleator, John A. Smolin, and Harald Weinfurter, "Elementary Gates for Quantum Computation," *Phys. Rev. A*, vol. 52, pp. 3457-3467, 1995.

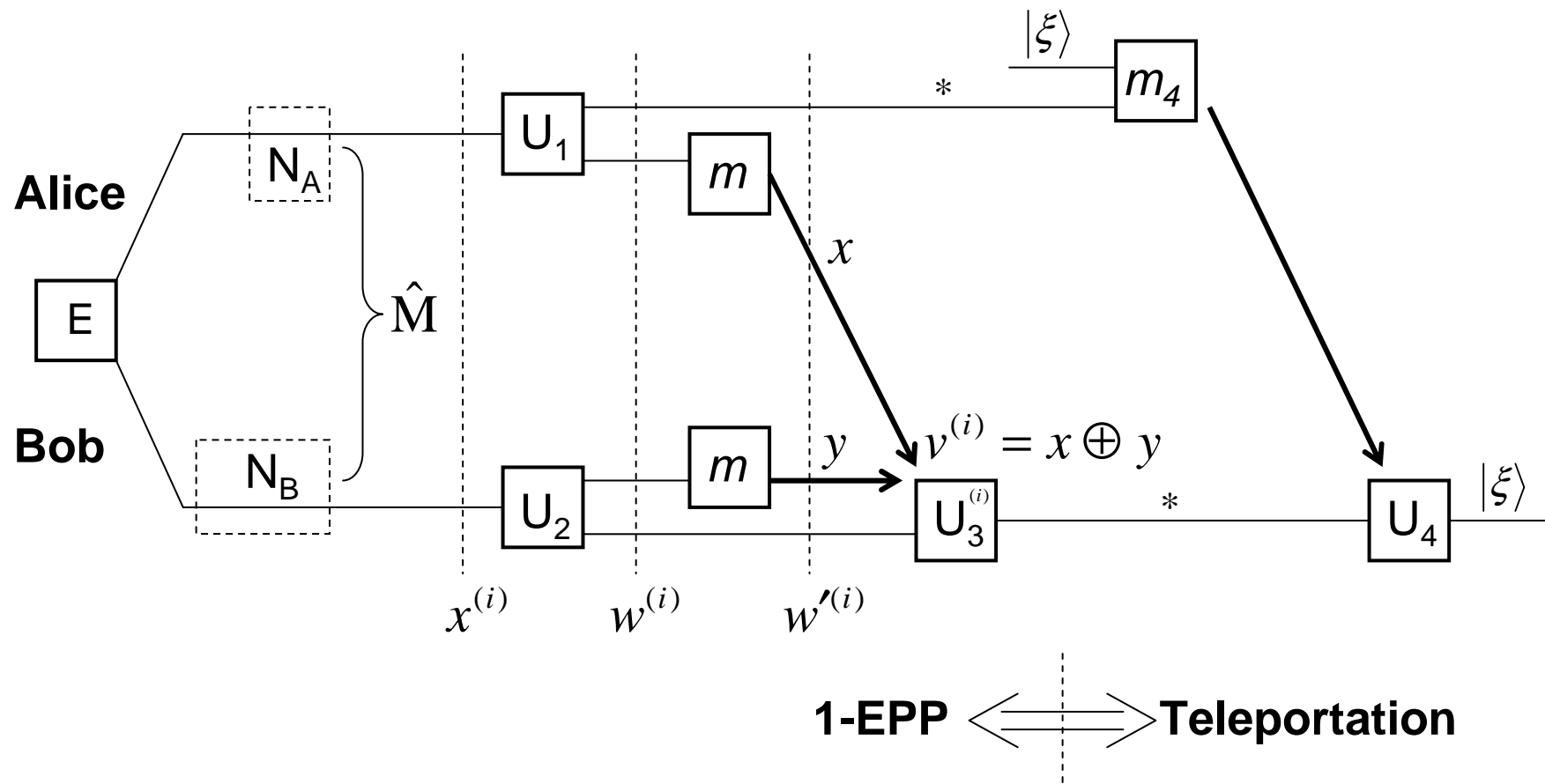
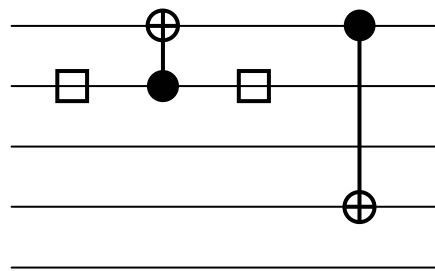
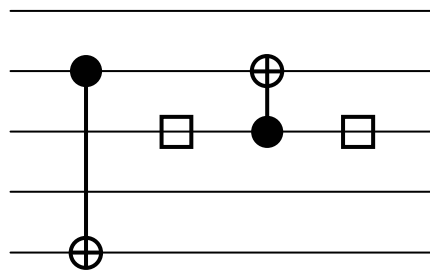

Fig. 1



(a)



(b)

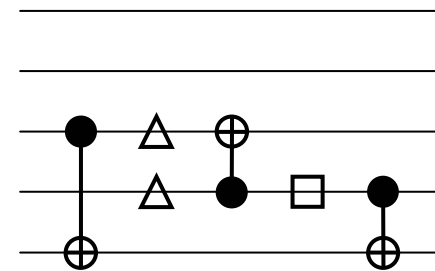

(c)

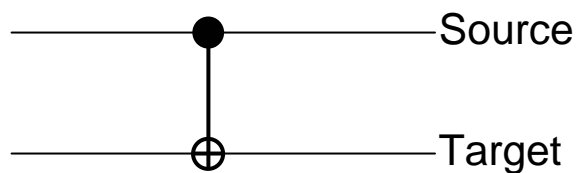

BXOR

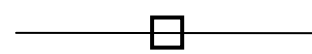

Bilateral Rotation



Composite $\sigma_x B_x$ Rotation

Fig. 2

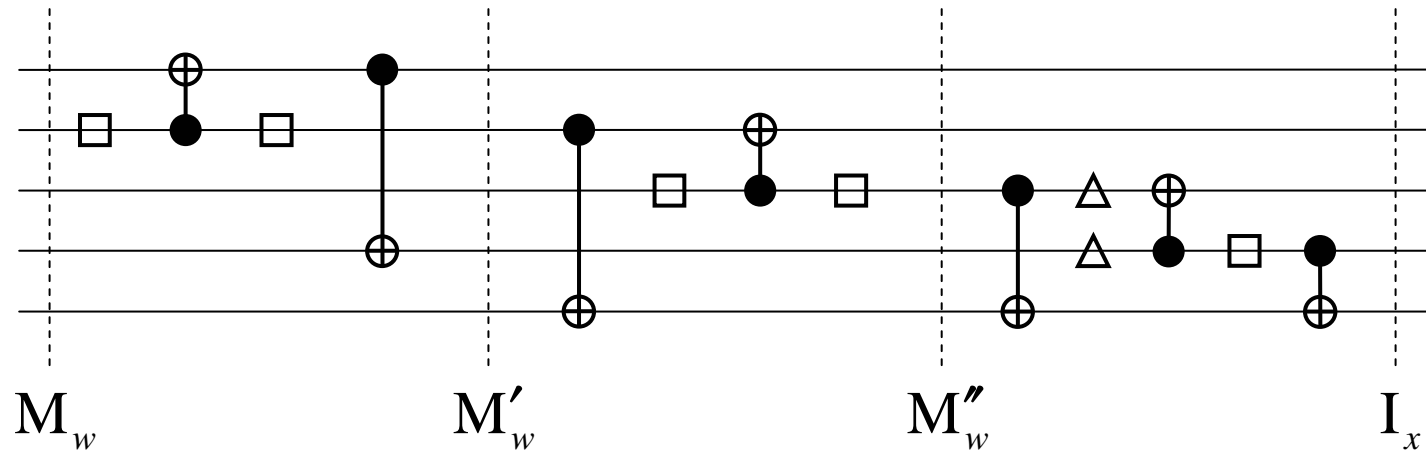

Fig. 3 (a)

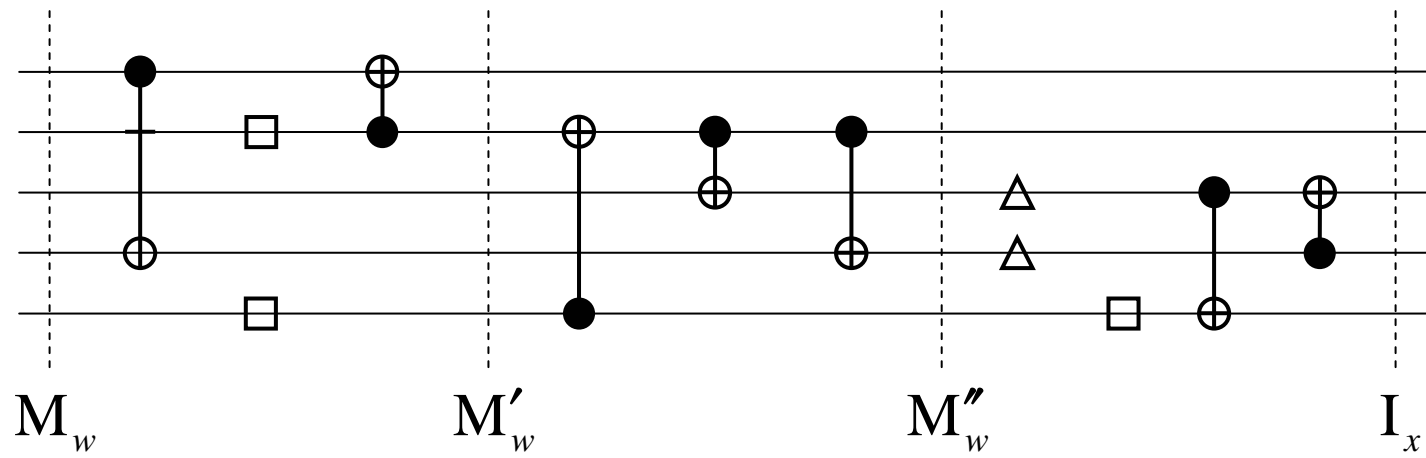

Fig. 3 (b)

(A1 α 2)

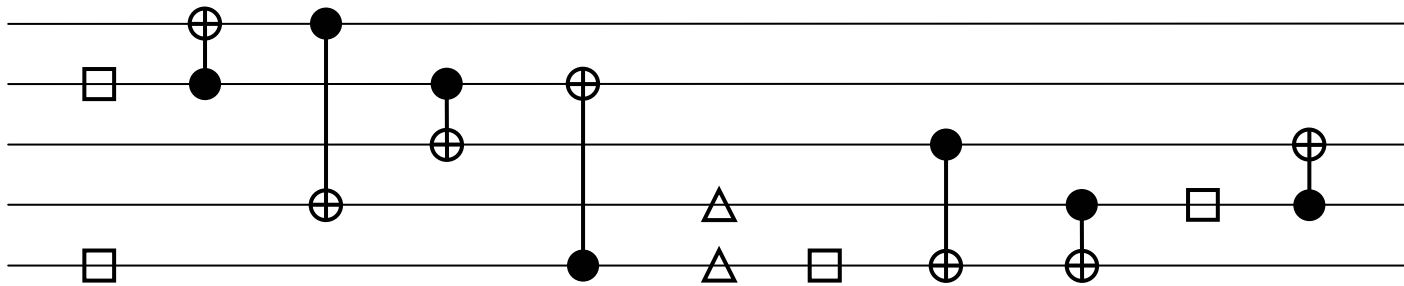

Fig. 4 (a)

$(A1\beta1)$

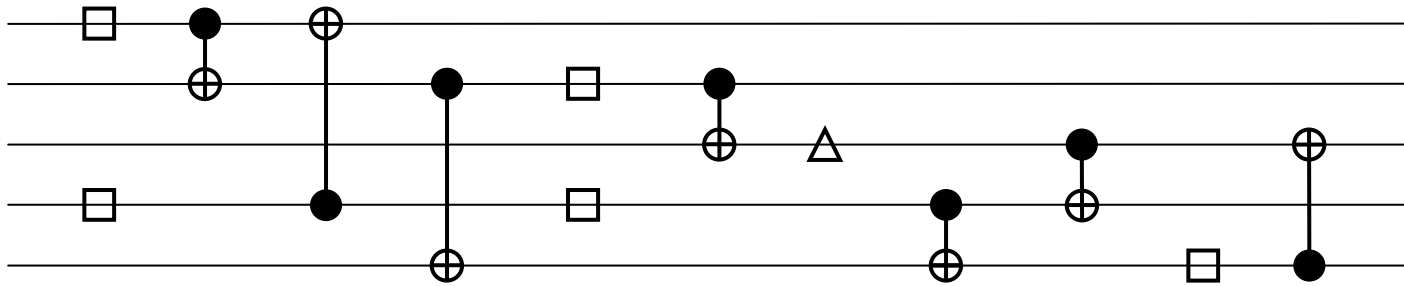

Fig. 4 (b)

$(A1\beta2)$

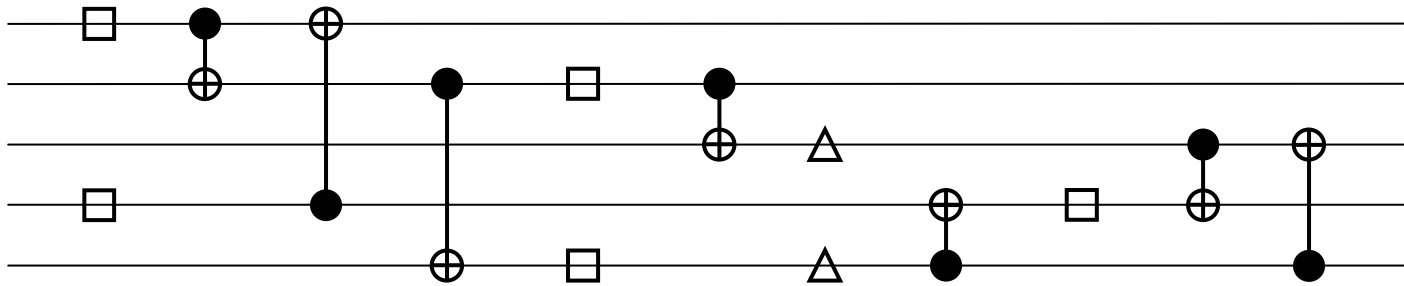

Fig. 4 (c)

(A1 γ 2)

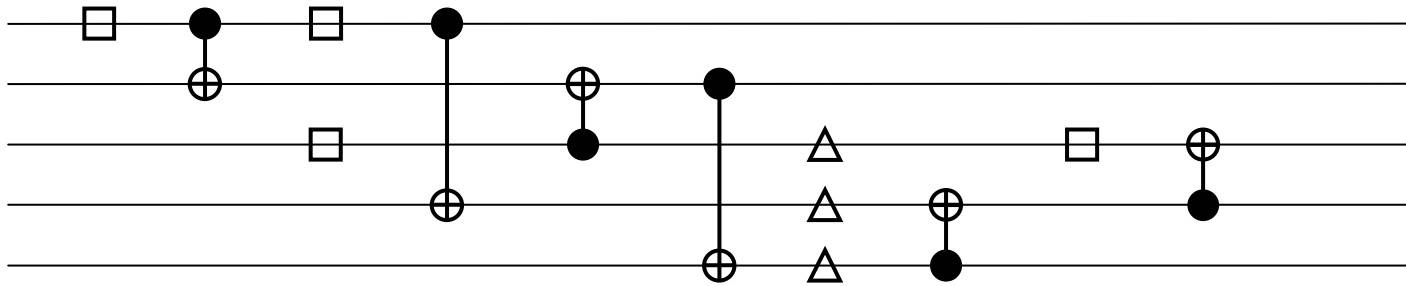

Fig. 4 (e)

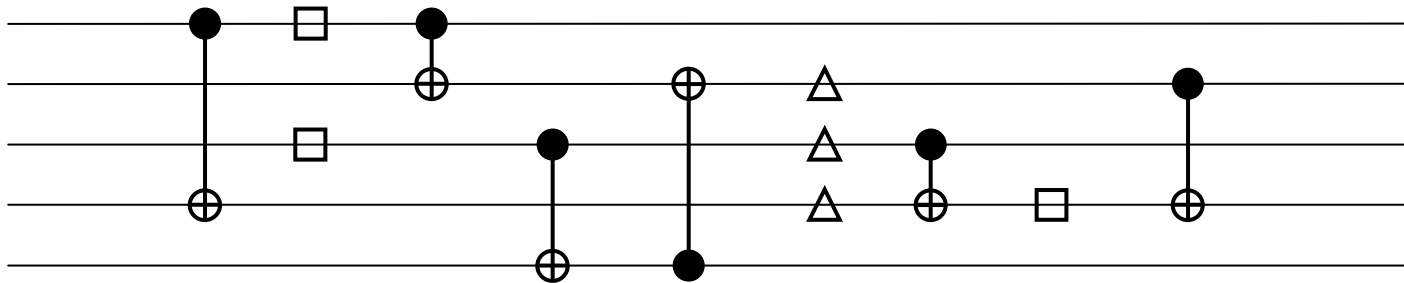

Fig. 5