

The Fundamental Theorem of Vassiliev Invariants

lecture notes by
DROR BAR-NATAN,
The Hebrew University, Jerusalem

Odense, July 1995

revised and prepared for publication by
ALEXANDER STOIMENOW,
Humboldt University, Berlin

These notes appeared in *Geometry and Physics* (J. .E. Andersen, J. Dupont, H. Pedersen, and A. Swann, eds.), lecture notes in pure and applied mathematics **184**, Marcel Dekker, New-York 1997. They are also available electronically at <http://www.ma.huji.ac.il/~drorbn>, <http://www.informatik.hu-berlin.de/~stoimeno>, at <ftp://ftp.ma.huji.ac.il/drorbn>, and at <http://xxx.lanl.gov/abs/q-alg/9702009>.

This edition: Feb. 06, 1997; First edition: Jan. 1, 1996.

Contents

| | | |
|----------|--|----------|
| 1 | Topology (and Combinatorics) | 3 |
| 1.1 | Vassiliev invariants and the Fundamental Theorem | 3 |
| 1.2 | Hutchings' combinatorial-topological approach | 6 |
| 1.2.1 | Hutchings' condition. | 6 |
| 1.2.2 | A possible strategy. | 7 |
| 1.3 | Why are we not happy? | 8 |
| 2 | Geometry | 8 |
| 2.1 | A short review of lecture 1. | 8 |
| 2.2 | A word about Lie algebras | 9 |
| 2.3 | Connections, curvature, and holonomy | 10 |
| 2.4 | The formal Knizhnik-Zamolodchikov connection | 11 |
| 2.5 | Kontsevich's integral invariants | 12 |
| 2.5.1 | Finiteness | 13 |
| 2.5.2 | Invariance under horizontal deformations | 13 |
| 2.5.3 | Moving critical points | 14 |
| 2.5.4 | The correction | 15 |
| 2.6 | Universality of the Kontsevich integral. | 16 |
| 2.7 | Why are we not happy? | 16 |

| | | |
|----------|---|-----------|
| 3 | Physics (sketch) | 17 |
| 3.1 | Invariants from path integrals. | 17 |
| 3.2 | A finite dimensional analogue. | 18 |
| 3.3 | Chern-Simons perturbation theory. | 19 |
| 3.4 | Why are we not happy? | 20 |
| 4 | Algebra (sketch) | 21 |
| 4.1 | Motivation from the Kontsevich-KZ integrals | 21 |
| 4.2 | Relations between R and Φ | 22 |
| 4.2.1 | Axioms for R and Φ | 22 |
| 4.2.2 | Automatic relations between R and Φ | 23 |
| 4.3 | An aside on quasi-Hopf algebras. | 24 |
| 4.4 | Constructing a pair (R, Φ) | 25 |
| 4.5 | Why are we not happy? | 29 |

Introduction (by the first author)

These notes grew out of four lectures I gave in a summer school titled “Geometry and Physics” in Odense, Denmark, in July 1995. I had two purposes in giving these lectures. The first was to expose the students to the theory of Vassiliev invariants and to some of its numerous connections with other parts of mathematics and mathematical physics. I chose to concentrate on only one theorem, the basic existence theorem for invariants with a given “ m th derivative” (which I call “The Fundamental Theorem” both for its fundamental nature and for its similarity with the fundamental theorem of calculus). Each lecture was a brief exposition of one of the four approaches I know for proving the theorem, with each approach related to a different branch of mathematics.

My second purpose in giving these lectures was to draw attention to the fact that even though the Fundamental Theorem is fundamental and is proven, we still don’t know the “right” proof. The naive and most natural topological approach discussed in the first lecture is not yet complete, and the slightly stronger theorem it requires (conjecture 1.13) may well be false. Each of the other three approaches does succeed, but always at some cost. Always the method is indirect and very complicated, and/or some a-priori unnatural choices have to be made, and/or the ground ring has to be limited. It seems like a conspiracy, and I hope that it really is a conspiracy. Maybe some small perturbation(s) of the theorem is(are) false? Light travels on straight lines, but not near very heavy objects. Maybe there’s some heavy object around here too, that prevents us from finding a direct proof? I hope that that object will be found one day. It may be fertile. Is it near conjecture 1.15?

As it’s often the case with lecture notes, these notes are not quite perfectly organized, and many of the details are insufficiently explained. I do hope, though, that they are clear enough at least to whet the reader’s appetite to read some of the references scattered within. The only new mathematics in these notes is the repackaging of Hutchings’ argument in terms of the snake lemma in section 1.2.

Acknowledgement. We wish to thank J. Andersen, H. Munkholm, H. Pedersen, and A. Swann, the organizers of the Odense summer school, for caring for all our special needs (especially the first author’s), for feeding us good food, for the T-shirts, and for bringing us (and all the others) together for a very enjoyable and productive period of time in Denmark.

1 Topology (and Combinatorics)

1.1 Vassiliev invariants and the Fundamental Theorem

Any invariant V of oriented knots in oriented space can be extended to an invariant of singular knots (allowing finitely many transverse double points as singularities) by inductive use of the formula¹:

$$V \left(\begin{array}{c} \nearrow \searrow \\ \times \\ \nwarrow \nearrow \end{array} \right) := V \left(\begin{array}{c} \nearrow \nearrow \\ \times \\ \nwarrow \nwarrow \end{array} \right) - V \left(\begin{array}{c} \nwarrow \nwarrow \\ \times \\ \nearrow \nearrow \end{array} \right) \quad (\text{verify consistency}).$$

Differences are cousins of derivatives, and it is tempting to think of V evaluated on an m -singular knot (a knot with exactly m double points) as “the m -th derivative of the original V ”. In analogy with polynomials of degree m we define:

Definition 1.1 (Goussarov [Go1, Go2], Vassiliev [Va1, Va2]) V is called “a Vassiliev invariant of type m ”, if

$$V \left(\underbrace{\begin{array}{c} \nearrow \searrow \quad \cdots \quad \nwarrow \nearrow \\ \times \quad \cdots \quad \times \end{array}}_{m+1} \right) = 0$$

(that is, if V vanishes when evaluated on a knot with more than m double points)

It is easy to show that *many* known knot invariants are Vassiliev, including, for example, all coefficients (in proper parametrizations) of the Conway, Jones, and HOMFLY polynomials. (See e.g. [B-N2, Bi, BL, Go1].)

With polynomials in mind, the following conjecture is just a variation of Taylor’s theorem:

Conjecture 1.2 *Vassiliev invariants separate knots.*

Little is known about conjecture 1.2. If “knots” are replaced by “braids” [B-N5, B-N7, Koh] or “string links up to homotopy²” [B-N5, Li1, Li2], it is verified. As it stands it sounds very appealing, but unfortunately, we cannot even yet affirm the following weaker

Question 1.3 (see [B-N4, sect. 7.2]) *Do Vassiliev invariants distinguish knot orientation?*

We will come back to this question in the next lecture.

Whatever you think of conjecture 1.2, it would clearly be nice to know what is the set of all Vassiliev invariants. Let us start:

Definition 1.4 $\mathcal{K}_m^0 = \text{span}\{m\text{-singular knots}\} / \text{differentiability relation}$,

where the differentiability relation is

$$\begin{array}{c} \nearrow \searrow \\ \times \end{array} \begin{array}{c} \nearrow \searrow \\ \times \end{array} - \begin{array}{c} \nwarrow \nwarrow \\ \times \end{array} \begin{array}{c} \nwarrow \nwarrow \\ \times \end{array} = \begin{array}{c} \nearrow \nearrow \\ \times \end{array} \begin{array}{c} \nwarrow \nwarrow \\ \times \end{array} - \begin{array}{c} \nwarrow \nearrow \\ \times \end{array} \begin{array}{c} \nwarrow \nearrow \\ \times \end{array}$$

Definition 1.5 Let $\delta : \mathcal{K}_{m+1}^0 \rightarrow \mathcal{K}_m^0$ be defined by

$$\begin{array}{c} \nearrow \searrow \\ \times \end{array} \longrightarrow \begin{array}{c} \nearrow \nearrow \\ \times \end{array} - \begin{array}{c} \nwarrow \nwarrow \\ \times \end{array}.$$

(The differentiability relation ensures that this is well defined.)

¹Here and throughout these notes we use the standard convention in knot theory, that if several almost equal knots (or singular knots) appear in an equation, only the parts in which they differ are drawn.

²allowing change of self-crossings of the strands

Again use the analogy between Vassiliev invariants and polynomials. If the $m + 1$ -st derivative vanishes, the m -th derivative should be a constant. Classifying these “constants” ($sym^m E^*$ in the case of polynomials in Euclidean spaces) is the same as classifying all polynomials. That is, if V is Vassiliev of type m , it is enough to understand V on \mathcal{K}_m^0 . Thus restricted, it is a linear functional on \mathcal{K}_m^0 , which vanishes on $\delta\mathcal{K}_{m+1}^0$. That is,

Proposition 1.6 *To every type m invariant V corresponds an element W_V of $(\mathcal{K}_m^0/\delta\mathcal{K}_{m+1}^0)^*$.*

Proposition-Definition 1.7

$$\mathcal{K}_m^0/\delta\mathcal{K}_{m+1}^0 = \mathcal{D}_m^0 \stackrel{\text{def}}{=} \text{span} \left\{ \begin{array}{c} \text{[Circle with } m \text{ chords]} \\ m \text{ chords} \end{array} \right\} = \text{span} \left\{ \begin{array}{c} \text{degree } m \\ \text{chord diagrams} \end{array} \right\}.$$

If a chord diagram $D \in \mathcal{D}_m^0$ is the image of an m -singular knot $K \in \mathcal{K}_m^0$ via the projection $F : \mathcal{K}_m^0 \rightarrow \mathcal{K}_m^0/\delta\mathcal{K}_{m+1}^0 = \mathcal{D}_m^0$ we say that D is the chord diagram underlying K and that the knot K represents the diagram D .

We leave the (easy) proof of the assertion in 1.7 to the reader.

Question 1.8 *When does $W \in (\mathcal{D}_m^0)^*$ integrate to a type m Vassiliev invariant V ?*

Today’s approach is: use induction. Set $V = W$ on \mathcal{K}_m^0 , try your luck integrating it to \mathcal{K}_{m-1}^0 , try it again to go on to \mathcal{K}_{m-2}^0 , and keep your fingers crossed hoping to meet no obstruction until you reach the goal — \mathcal{K}_0^0 .

The obvious question that comes in mind is:

Question 1.9 *When does an invariant in $(\mathcal{K}_m^0)^*$ integrate one step to an invariant in $(\mathcal{K}_{m-1}^0)^*$?*

The complete answer to this question is given by the following theorem, which appears implicitly in Vassiliev [Va1, Va2] and explicitly in Stanford [Sta], and is written as Mike Hutchings [Hu] writes it.

Theorem 1.10 *The sequence*

$$\mathcal{K}_m^1 \xrightarrow{\partial} \mathcal{K}_m^0 \xrightarrow{\delta} \mathcal{K}_{m-1}^0$$

is exact. Here \mathcal{K}_m^1 is the space spanned by all singular knots that have $m - 2$ double points and one triple point in which one of the strands is marked by a \star (called “Topological 4-Term” or “T4T” knots), and by all singular knots that have $m - 1$ double points and one marked point somewhere on them but not on a double point (called “Topological Framing Independence” or “TFI” knots), with everything moded out by the differentiability relation. In pictures,

$$\mathcal{K}_m^1 = \text{span} \left\{ \begin{array}{c} \text{[Diagram with } m-2 \text{ double points and } 1 \text{ triple point with marked strand]} \\ \text{[Diagram with } m-1 \text{ double points and } 1 \text{ marked point]} \\ \text{[Diagram with } m-2 \text{ double points]} \\ \text{[Diagram with } m-1 \text{ double points]} \end{array} \right\} / \text{differentiability.}$$

The map ∂ is given by

$$\begin{aligned} \partial \left(\begin{array}{c} \text{[Diagram with } m-2 \text{ double points and } 1 \text{ triple point with marked strand]} \end{array} \right) &= \text{[Diagram 1]} + \text{[Diagram 2]} - \text{[Diagram 3]} - \text{[Diagram 4]} \\ \partial \left(\begin{array}{c} \text{[Diagram with } m-1 \text{ double points and } 1 \text{ marked point]} \end{array} \right) &= \text{[Diagram 5]} \end{aligned}$$

The fact that $\delta \circ \partial = 0$ is easy, and it already implies a partial answer to question 1.8:

Proposition 1.11 *A necessary condition for $W \in (\mathcal{D}_m^0)^*$ to integrate to a Vassiliev invariant is that it vanishes on $\partial \mathcal{D}_m^1$, where*

$$\mathcal{D}_m^1 = \text{span} \left\{ \begin{array}{c} \text{Diagram 1: Circle with a vertical chord, a horizontal chord, and a star in the top-left quadrant.} \\ \text{Diagram 2: Circle with a vertical chord, a horizontal chord, and a dot in the top-right quadrant.} \end{array} \right\}$$

$$\partial \left(\begin{array}{c} \text{Diagram 1} \\ \text{Diagram 2} \end{array} \right) = \begin{array}{c} \text{Diagram 3: Circle with a vertical chord and a diagonal chord from top-left to bottom-right.} \\ \text{Diagram 4: Circle with a vertical chord and a diagonal chord from top-right to bottom-left.} \\ \text{Diagram 5: Circle with a vertical chord and a diagonal chord from top-left to bottom-right.} \\ \text{Diagram 6: Circle with a vertical chord and a diagonal chord from top-right to bottom-left.} \end{array},$$

(the 4T relation)

and

$$\partial \left(\begin{array}{c} \text{Diagram 7: Circle with a dot on the right side.} \end{array} \right) = \begin{array}{c} \text{Diagram 8: Circle with a vertical chord on the right side.} \end{array} \quad (\text{the FI relation})$$

Proof : Just consider the chord diagrams underlying the knots in $\partial \mathcal{K}_m^1$. □

Remark 1.12 *Notice that $\mathcal{D}_m^1 = \mathcal{K}_m^1 / \delta \mathcal{K}_{m+1}^1$, where the map $\delta : \mathcal{K}_{m+1}^1 \rightarrow \mathcal{K}_m^1$ is defined in the same way as the map $\delta : \mathcal{K}_{m+1}^0 \rightarrow \mathcal{K}_m^0$, and that the map $\partial : \mathcal{D}_m^1 \rightarrow \mathcal{D}_m^0$ is the only map that makes the following diagram commutative (with exact rows):*

$$\begin{array}{ccccccc} \mathcal{K}_{m+1}^1 & \xrightarrow{\delta} & \mathcal{K}_m^1 & \xrightarrow{F} & \mathcal{D}_m^1 & \longrightarrow & 0 \\ \partial \downarrow & & \partial \downarrow & & \partial \downarrow & & \\ \mathcal{K}_{m+1}^0 & \xrightarrow{\delta} & \mathcal{K}_m^0 & \xrightarrow{F} & \mathcal{D}_m^0 & \longrightarrow & 0 \end{array}$$

Proof of theorem 1.10 (sketch): We only need to show that $\ker \delta \subset \text{im } \partial$. Take a generic loop L in the set $\mathcal{K}_{\geq m-1}^0$ of all parametrized knots with at least $m-1$ double points, and possibly some worse singularities. Such a loop meets $\mathcal{K}_{\geq m}^0$ in finitely many points, that are m -singular knots. Let S_L be the (properly signed) sum of these m -singular knots. It is not hard to show that $\ker \delta$ is spanned by these S_L 's, so it is enough to show that S_L is in $\text{im } \partial$ for any L . Now notice that $\mathcal{K}_{\geq m-1}^0$ is simply connected, so L bounds some generic disk D in $\mathcal{K}_{\geq m-1}^0$. The intersection of D with the codimension 1 set of knots of a higher singularity is some graph G on \bar{D} (see figure 1), and the vertices of G correspond to points in the codimension 2 set of generic knots of an even higher singularities. One can check that this set is exactly the set of generators of \mathcal{K}_m^1 , and that $S_L = \delta S_D$ where S_D is the (properly signed) sum in \mathcal{K}_m^1 corresponding to the vertices of G . □

The Fundamental Theorem of Vassiliev invariants *The condition in proposition 1.11 is also sufficient.*

Let

$$\mathcal{A}_m^r = \mathcal{D}_m^0 / \delta \mathcal{D}_m^1 = \left(\begin{array}{c} \text{chord diagrams} \\ \text{mod } 4T \ \& \ FI \end{array} \right).$$

Then every weight system W (an element in $(\mathcal{A}_m^r)^*$) integrates to a Vassiliev invariant. It follows that the associated graded vector space of the filtered space of all Vassiliev invariants is

$$(\mathcal{A}^r)^* \stackrel{\text{def}}{=} \left(\bigoplus_{m=0}^{\infty} \mathcal{A}_m^r \right)^* \quad (\text{duals are taken in the graded sense}).$$

There are two problems with this lovely theorem

1. Although much is known about \mathcal{A}^r (and its equivalent but friendlier version \mathcal{A} in which the FI relation is not imposed), we are far from understanding it.
2. As indicated in the introduction, we know at least four approaches to the proof. The topological approach of this lecture, which fails, but comes close. And three other approaches, geometrical, physical, and algebraic, that all work, but have other defects.

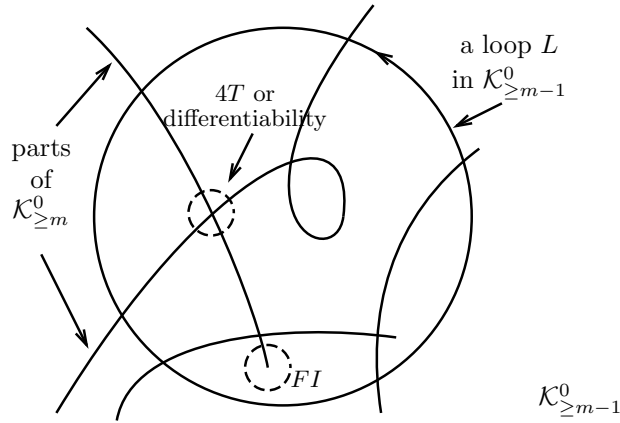

Figure 1. The proof of theorem 1.10.

1.2 Hutchings' combinatorial-topological approach

In view of theorem 1.10, the Fundamental Theorem follows from the following:

Conjecture 1.13 *Any invariant satisfying the T4T and TFI can be integrated one step to an invariant that does the same.*

In [Hu], M. Hutchings was able to reduce this conjecture to a statement that appears to be easier to verify (“Hutchings’ condition”, below), and to show that this statement follows from a completely combinatorial statement (conjecture 1.15).

1.2.1 Hutchings' condition.

Consider the following commutative diagram:

$$\begin{array}{ccccccc}
 & & 0 & & 0 & & 0 \\
 & & \downarrow & & \downarrow & & \downarrow \\
 & & \mathcal{K}_{m+1}^1 & \xrightarrow{\delta} & \ker \partial|_{\mathcal{K}_m^1} & \xrightarrow{F} & \ker \partial|_{\mathcal{D}_m^1} \\
 & & \downarrow & & \downarrow & & \downarrow \\
 & & \mathcal{K}_{m+1}^1 & \xrightarrow{\delta} & \mathcal{K}_m^1 & \xrightarrow{F} & \mathcal{D}_m^1 \longrightarrow 0 \\
 & & \downarrow & & \downarrow & & \downarrow \\
 & & 0 & & \partial & & \partial \\
 0 & \longrightarrow & \mathcal{K}_{m+1}^0 / \partial \mathcal{K}_{m+1}^1 & \xrightarrow{\delta} & \mathcal{K}_m^0 & \xrightarrow{F} & \mathcal{D}_m^0 \quad (\longrightarrow 0) \\
 & & \downarrow & & \downarrow & & \downarrow \\
 & & \mathcal{K}_{m+1}^0 / \partial \mathcal{K}_{m+1}^1 & \xrightarrow{\delta} & \mathcal{K}_m^0 / \partial \mathcal{K}_m^1 & \longrightarrow & \mathcal{A}_m^r \\
 & & \downarrow & & \downarrow & & \downarrow \\
 & & 0 & & 0 & & 0
 \end{array}$$

The columns of this diagrams are exact by definition. The second row is exact as in remark 1.12. The third row is exact (though we will not use its exactness at the right end) because it is a folding (on the left) of the sequence

$$\mathcal{K}_{m+1}^1 \xrightarrow{\partial} \mathcal{K}_{m+1}^0 \xrightarrow{\delta} \mathcal{K}_m^0 \xrightarrow{F} \mathcal{D}_m^0 \longrightarrow 0,$$

whose left half is exact by theorem 1.10 and whose right half is exact as in remark 1.12.

Rephrased in an algebraic language, conjecture 1.13 says that $\delta^* : (\mathcal{K}_m^0/\partial\mathcal{K}_m^1)^* \rightarrow (\mathcal{K}_{m+1}^0/\partial\mathcal{K}_{m+1}^1)^*$ is surjective. This is equivalent to the injectivity of $\delta : \mathcal{K}_{m+1}^0/\partial\mathcal{K}_{m+1}^1 \rightarrow \mathcal{K}_m^0/\partial\mathcal{K}_m^1$. By the snake lemma applied to the above diagram, this is equivalent to the surjectivity of

$$F : \ker \partial|_{\mathcal{K}_m^1} \longrightarrow \ker \partial|_{\mathcal{D}_m^1}$$

In other words, it is enough to prove ‘‘Hutchings’ condition’’, saying that

- * Every relation between $4T$ & FI relations (on the level of diagrams) lifts to a relation between $T4T$ & TFI relations (on the level of knots, and mod the differentiability relation).

1.2.2 A possible strategy.

1. Find many elements of $\ker \partial|_{\mathcal{D}_m^1}$. Namely, find a big \mathcal{D}_m^2 and a map $\partial : \mathcal{D}_m^2 \rightarrow \mathcal{D}_m^1$ so that

$$\mathcal{D}_m^2 \xrightarrow{\partial} \mathcal{D}_m^1 \xrightarrow{\partial} \mathcal{D}_m^0 \longrightarrow \mathcal{A}_m^r$$

is exact.

2. Prove that F is onto $\partial\mathcal{D}_m^2$.
3. Compute $H_\partial^1(\mathcal{D}_m^*)$. If it is 0, you win.

Remark 1.14 In [Hu], M. Hutchings proved conjecture 1.13 for braids (and hence the Fundamental Theorem for braids) by following this strategy.

Anyway, ignoring FI for simplicity, here’s a candidate for \mathcal{D}_m^2 (which worked well for braids):

$$\mathcal{D}_m^2 = \text{span} \left\{ \begin{array}{ccc} \text{3T} & \text{8T} & \text{14T} \end{array} \right\},$$

where

$$\begin{aligned} \partial \left(\text{3T} \right) &= \text{3T} + \text{3T} + \text{3T} \\ \partial \left(\text{8T} \right) &= \text{8T} - \text{8T} + \text{8T} - \text{8T} \\ &\quad - \text{8T} + \text{8T} - \text{8T} + \text{8T} \\ \partial \left(\text{14T} \right) &= \text{14T} - \text{14T} + \text{14T} \\ &\quad - \text{14T} + \text{14T} - \text{14T} \\ &\quad - \text{14T} + \text{14T} - \text{14T} + \text{14T} \end{aligned}$$

It is not hard to lift $3T$, $8T$ and $14T$ to a $T3T$, $T8T$ and $T14T$ in $\ker \partial|_{\mathcal{K}_m^1}$.

Conjecture 1.15 $H_{\partial}^1(\mathcal{D}_m^*) = 0$ (To be honest, we hope it's false. This will make life more interesting!)

Notice that this is a diagram level statement, which implies the Fundamental Theorem!

Conjecture 1.16 $H_{\partial}^1(\mathcal{D}_m^*)$ is isomorphic to (a certain twist of) Kontsevich's graph homology.

Proving conjecture 1.16 appears to be only a matter of labor.

Remark 1.17 See Domergue-Donato [DD] and Willerton [Wil] for some other partial results on the combinatorial-topological approach. Some enumerative results on chord diagrams appear in [Sto2].

1.3 Why are we not happy?

1. The construction of the diagram on which the snake lemma was applied was somewhat artificial. Is there something more basic going on?
2. We don't know that $H_{\partial}^1(\mathcal{D}_m^*) = 0$. We believe, our \mathcal{D}_m^2 is the right one, but it may well be that H_{∂}^1 does not vanish, and that its non-triviality means something. What does it mean?

2 Geometry

2.1 A short review of lecture 1.

Generalize a knot invariant V (a map {knots up to isotopy} $\rightarrow \mathbf{C}$) to singular knots by

$$V \left(\begin{array}{c} \diagup \diagdown \\ \diagdown \diagup \end{array} \right) := V \left(\begin{array}{c} \diagup \diagdown \\ \diagup \diagdown \end{array} \right) - V \left(\begin{array}{c} \diagdown \diagup \\ \diagdown \diagup \end{array} \right), \quad (2.1)$$

and then define a Vassiliev invariant

$$\left(\begin{array}{c} V \text{ is of} \\ \text{type } m \end{array} \right) \iff V \left(\underbrace{\begin{array}{c} \diagup \diagdown \quad \cdots \quad \diagup \diagdown \\ \diagdown \diagup \quad \cdots \quad \diagdown \diagup \end{array}}_{m+1} \right) = 0.$$

One can think of (2.1) as of “differentiating” an invariant and of a Vassiliev invariant as of a “polynomial”. So, to understand them we would like to know their “coefficients”. Here is a nice candidate.

$$(V \text{ of type } m) \implies V \left(\begin{array}{c} \diagup \diagdown \quad \cdots \quad \diagup \diagdown \\ \diagdown \diagup \quad \cdots \quad \diagdown \diagup \end{array} \right) = V \left(\begin{array}{c} \diagup \diagdown \quad \cdots \quad \diagup \diagdown \\ \diagdown \diagup \quad \cdots \quad \diagdown \diagup \end{array} \right),$$

and that's why V defines

$$W_V : \text{span} \left\{ \begin{array}{c} \text{circle with } m \text{ chords} \end{array} \right\} \rightarrow \mathbf{C}.$$

This W_V satisfies two relations ($4T$ and FI) because of topological reasons and hence it becomes a *weight system* $W_V \in (\mathcal{A}_m^r)^*$, where

$$\mathcal{A}^r = \text{span} \left\{ \begin{array}{c} \text{circle with } m \text{ chords} \end{array} \right\} / \begin{array}{l} 4T : \begin{array}{c} \text{circle with } m \text{ chords} \\ \text{circle with } m \text{ chords} \end{array} - \begin{array}{c} \text{circle with } m \text{ chords} \\ \text{circle with } m \text{ chords} \end{array} + \begin{array}{c} \text{circle with } m \text{ chords} \\ \text{circle with } m \text{ chords} \end{array} - \begin{array}{c} \text{circle with } m \text{ chords} \\ \text{circle with } m \text{ chords} \end{array} = 0 \\ FI : \begin{array}{c} \text{circle with } m \text{ chords} \\ \text{circle with } m \text{ chords} \end{array} = 0 \end{array}$$

Now the following theorem tells us that this is exactly what we were looking for.

The Fundamental Theorem Every $W \in (\mathcal{A}_m^r)^*$ is W_V for some type m invariant V .

It turns out to be interesting to explore these combinatorial objects. So, before we start proving the Fundamental Theorem, let's say something more about them.

2.2 A word about Lie algebras

(drop *FI* for convenience, i. e., consider *framed* knots)

There is a way to construct a weight system out of a Lie algebra representation. First we need the following

Theorem 2.1 ([B-N4]) *There is an equivalent representation of our diagram space \mathcal{A} in terms of diagrams in which some number of oriented internal trivalent vertices are also allowed. Namely*

$$\begin{aligned} \mathcal{A} &= \text{span} \left\{ \text{diagram with 4 crossings} \right\} / \begin{array}{l} 4T : \\ \text{diagram 1} - \text{diagram 2} + \text{diagram 3} - \text{diagram 4} = 0 \end{array} \\ &\cong \text{span} \left\{ \text{diagram with 1 crossing} \right\} / \begin{array}{l} AS : \text{diagram 1} = -\text{diagram 2}, \\ IHX : \text{diagram 1} = \text{diagram 2} - \text{diagram 3}, \\ STU : \text{diagram 1} = \text{diagram 2} - \text{diagram 3}, \end{array} \end{aligned}$$

Remark 2.2 *In fact, AS and IHX are consequences of STU, so they need not to be imposed explicitly here (they are more important in connection with another 3rd representation of \mathcal{A} , as in [B-N4, section 5]). However, we will use AS to turn every trivalent vertex to be oriented counterclockwise and then drop all orientation arrows.*

Proof : This is basically a consequence of the T-shirt identity

$$\text{diagram 1} - \text{diagram 2} = \text{diagram 3} = \text{diagram 4} - \text{diagram 5},$$

(with some more technical details). □

Now given a finite-dimensional Lie-algebra \mathfrak{g} with a metric and an orthonormal basis $\{\mathfrak{g}_a\}_{a=1}^{\dim \mathfrak{g}}$ and a finite dimensional representation R , set

$$W_{\mathfrak{g},R} \left(\text{diagram with arcs } a, b, c, d \right) = \sum_{a,b,c,d=1}^{\dim \mathfrak{g}} f_{bcd} \text{tr}_R(\mathfrak{g}_a \mathfrak{g}_b \mathfrak{g}_c \mathfrak{g}_d),$$

where f_{bcd} are the structure constants of \mathfrak{g} relative to the basis $\{\mathfrak{g}_a\}$. It should be clear how to extend this example and define $W_{\mathfrak{g},R}(D)$ for any diagram D of the kind appearing in theorem 2.1.

Proposition & Proof 2.3 *$W_{\mathfrak{g},R}$ is well defined (i. e., independent of the choice of the basis $\{\mathfrak{g}_a\}$) and satisfies:*

- * The AS relation by the anti-symmetry of the bracket.
- * The IHX relation because of the Jacobi identity.
- * The STU relation because representations represent.

Conjecture 2.4 *All weight systems ($\stackrel{\text{def}}{=} \text{elements of } \mathcal{A}^*$) come from this construction.*

A word about numbers

| m | 0 | 1 | 2 | 3 | 4 | 5 | 6 | 7 | 8 | 9 |
|---|---|---|---|---|---|----|-------------|-----------|-----------|-------------|
| $\dim \mathcal{A}_m^r$ | 1 | 0 | 1 | 1 | 3 | 4 | 9 | 14 | 27 | 44 |
| $\dim \mathcal{A}_m$ | 1 | 1 | 2 | 3 | 6 | 10 | 19 | 33 | 60 | 104 |
| $\dim \left(\begin{smallmatrix} \text{span of} \\ \text{all } W_{g,R} \end{smallmatrix} \right)$ | 1 | 1 | 2 | 3 | 6 | 10 | 19 | 33 | 60 | 104 |
| CPU time 190MHz Digital alpha Workstation | — | — | — | — | — | — | 0.64 sec | 27 sec | 19 min | 2.7 days |

Looking at this table, the case for conjecture 2.4 appears to be convincing. However,

Warning: From [B-N4] it was known that Conjecture 2.4, at least in the somewhat stronger form, where only semi-simple & Abelian algebras are allowed, would answer negatively question 1.3 and therefore contradicts Conjecture 1.2. Finally, recently Vogel [Vo] *disproved* this stronger version of Conjecture 2.4. However, all the Lie algebraic weight systems appearing in the table were generated using only the Lie algebras $so(N)$ and $gl(N)$. Beyond degree 9 we will have to deal with nilpotent (and ev. exceptional) Lie algebras too. But Vogel even announced to the second author that Conjecture 2.4 is wrong *in full generality*.

Anyway, the answer to question 1.3 and the fate of Conjecture 1.2 remain unclear.

In a way, this is good news. It means that we don't understand something, which means that we still have something left to do!

Now let's come back to our Fundamental Theorem. We will use the following

Equivalent Reformulation

There exists a "universal Vassiliev invariant"

$$\tilde{Z} : \{ \text{knots} \} \longrightarrow \bar{\mathcal{A}}^r \quad (\text{the graded completion of } \mathcal{A}^r)$$

such that if D is the degree m chord diagram underlying an m -singular knot K , then

$$\tilde{Z}(K) = D + \left(\begin{smallmatrix} \text{higher degree} \\ \text{diagrams} \end{smallmatrix} \right)$$

Proof of equivalence:

$$\begin{array}{ccc} \{ \text{knots} \} & \xrightarrow{\tilde{Z}} & \left\{ \begin{smallmatrix} \text{chord} \\ \text{diagrams} \end{smallmatrix} \right\} = \mathcal{A}^r \\ & \searrow V & \swarrow W_V \\ & & \mathbf{C} \end{array}$$

If you have \tilde{Z} and you're given a W , define V to be the obvious composition. If you know how to associate a V to any W in a basis of \mathcal{A}^r , there's a unique \tilde{Z} making the diagram commutative. \square

Here we will present Kontsevich's geometric approach for constructing such a \tilde{Z} .

2.3 Connections, curvature, and holonomy

Up to some (important, but not here) subtlety, a connection is a 1-form whose values are in the algebra of endomorphisms of the fiber. One would like to know how much of the theory of connections can be generalized to the case of 1-forms with values in an arbitrary associative algebra. As was shown by K-T. Chen [Ch], much of the theory persists in the more general case. Let us briefly review some aspects of Chen's theory.

Let X be a smooth manifold and let \mathfrak{A} be a topological algebra over the real numbers \mathbf{R} (or the complex numbers \mathbf{C}), with a unit 1. An \mathfrak{A} -valued connection Ω on X is an \mathfrak{A} -valued 1-form Ω on X . Its curvature F_Ω is the \mathfrak{A} -valued 2-form $F_\Omega = d\Omega + \Omega \wedge \Omega$, where the definitions of the exterior differentiation operator d and of the wedge product \wedge are precisely the same as the corresponding definitions in the case of matrix valued forms. The notion of “parallel transport” also has a generalization in the new context: Let $B : I \rightarrow X$ be a smooth map from some interval $I = [a, b]$ to X . Define the holonomy $hol_B(\Omega)$ of Ω along B to be the function $hol_B(\Omega) : I \rightarrow \mathfrak{A}$ which satisfies

$$hol_B(\Omega)(a) = 1; \quad \frac{\partial}{\partial t} hol_B(\Omega)(t) = \Omega(\dot{B}(t)) hol_B(\Omega)(t), \quad (t \in I)$$

if such a function exists and is unique. In many interesting cases, $hol_B(\Omega)$ exists and is given (see e.g. [Ch]) by the following “iterated integral” formula:

$$hol_B(\Omega)(t) = 1 + \sum_{m=1}^{\infty} \int_{a \leq t_1 \leq \dots \leq t_m \leq t} (B^*\Omega)(t_m) \cdot \dots \cdot (B^*\Omega)(t_1). \tag{2.2}$$

(In this formula $B^*\Omega$ denotes the pullback of Ω to I via B). Furthermore, just like in the standard theory of connections, if $F_\Omega \equiv 0$ (Ω is flat’), then $h_{B,\Omega}$ is invariant under homotopies of B that preserve its endpoints.

In the case of interest for us, \mathfrak{A} will be the completion of a graded algebra of finite type over the complex numbers — the direct product of the finite dimensional (over \mathbf{C}) homogeneous components of a graded algebra. The connection Ω will be homogeneous of degree 1. In this case the m th term $hol_B(\Omega)_m$ in (2.2) is homogeneous of degree m , and there is no problem with the convergence of the sum there. Also, as each term lives in a different degree, Chen’s theory implies that each term is invariant under homotopies of B that preserve its endpoints. These assertions are not very hard to verify directly from the definition of $hol_B(\Omega)_m$ as a multiple integral.

2.4 The formal Knizhnik-Zamolodchikov connection

Let $\mathcal{D}(n\uparrow)$ be the collection of all diagrams made of n ordered upward pointing arrows, and chords and oriented vertices as in the definition of \mathcal{A} , with the standard conventions about higher than trivalent vertices and about the orientation of vertices:

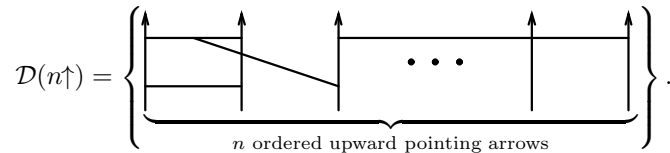

Let the ground field be \mathbf{C} and let $\mathcal{A}(n\uparrow)$ be the quotient

$$\mathcal{A}(n\uparrow) = \text{span}(\mathcal{D}(n\uparrow)) / \{STU \text{ relations}\} .$$

$\mathcal{A}(n\uparrow)$ is an algebra with ‘composition’ as its product:

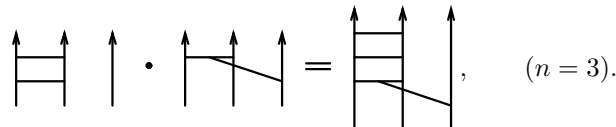

$\mathcal{A}(n\uparrow)$ is graded by half the number of vertices in a diagram, excluding the $2n$ endpoints of the n arrows; the degree of the above product is 4.

For $1 \leq i < j \leq n$ define $\Omega_{ij} \in \mathcal{A}(n\uparrow)$ by

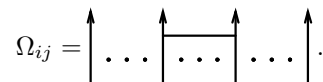

Let X_n be the configuration space of n distinct points in \mathbf{C} ; $X_n = \{(z_1, \dots, z_n) \in \mathbf{C}^n : z_i = z_j \Rightarrow i = j\}$, and let ω_{ij} be the complex 1-form on X_n defined by

$$\omega_{ij} = d(\log z_i - z_j) = \frac{dz_i - dz_j}{z_i - z_j}.$$

The formal Knizhnik-Zamolodchikov connection is the $\mathcal{A}(n\uparrow)$ -valued connection $\Omega_n = \sum_{1 \leq i < j \leq n} \Omega_{ij} \omega_{ij}$ on X_n .

Proposition 2.5 *The formal Knizhnik-Zamolodchikov connection Ω_n is flat.*

Proof : Clearly $d\Omega_n = 0$. Let us check that

$$\Omega_n \wedge \Omega_n = \sum_{i < j; i' < j'} \Omega_{ij} \Omega_{i'j'} \omega_{ij} \wedge \omega_{i'j'} = 0. \quad (2.3)$$

The above sum can be separated into three parts, according to the cardinality of the set $\{i, j, i', j'\}$. If this cardinality is 2 or 4 then Ω_{ij} and $\Omega_{i'j'}$ commute, while ω_{ij} and $\omega_{i'j'}$ anti-commute. It is easy to check that this implies that the corresponding parts of the sum (2.3) vanish. The only interesting case is when $|\{i, j, i', j'\}| = 3$, say $\{i, j, i', j'\} = \{1, 2, 3\}$. In this case,

$$\sum_{\{i, j, i', j'\} = \{1, 2, 3\}} \Omega_{ij} \Omega_{i'j'} \omega_{ij} \wedge \omega_{i'j'} = (\Omega_{12} \Omega_{23} - \Omega_{23} \Omega_{12}) \omega_{12} \wedge \omega_{23} + (\text{cyclic permutations}).$$

By the *STU* relation this is

$$= \Omega_{123} (\omega_{12} \wedge \omega_{23} + (\text{cyclic permutations})) = 0, \quad (2.4)$$

where Ω_{123} is given by

$$\Omega_{123} = \begin{array}{c} \uparrow \quad \uparrow \quad \uparrow \\ \diagdown \quad \diagup \quad | \\ \diagup \quad \diagdown \quad | \\ \uparrow \quad \uparrow \quad \uparrow \end{array} \cdot \dots \cdot \begin{array}{c} \uparrow \\ | \\ \uparrow \end{array} \in \mathcal{A}(n\uparrow).$$

The vanishing of $\omega_{12} \wedge \omega_{23} + (\text{cyclic permutations})$ is called ‘Arnold’s identity’ [Ar] and can be easily verified by a direct computation. \square

Remark 2.6 *The connection Ω_n has a simple generalization to the case when the underlying algebra is $\mathcal{A}(n\uparrow \amalg n\downarrow)$, the algebra generated by diagrams having $2n$ arrows, whose first n arrows point upward and whose next n arrows point downward. The only difference is a sign difference in the application of the *STU* relation in (2.4). Therefore if one defines*

$$\Omega_{n,n} = \sum_{1 \leq i \leq j \leq 2n} s_i s_j \Omega_{ij} \omega_{ij},$$

where $s_i = \begin{cases} +1 & i \leq n \\ -1 & i > n \end{cases}$, then the connection $\Omega_{n,n}$ is flat.

2.5 Kontsevich’s integral invariants

Choose a decomposition $\mathbf{R}^3 = \mathbf{C}_z \times \mathbf{R}_t$ of \mathbf{R}^3 to a product of a complex plane \mathbf{C}_z parametrized by z and a real line \mathbf{R}_t parametrized by t and let $K : S^1 \rightarrow \mathbf{R}^3$ be a parametrized knot on which the function t is a Morse function. Consider the following series, whose precise definition will be discussed below:

$$Z(K) = \sum_{m=0}^{\infty} (2\pi i)^{-m} \int_{t_1 < \dots < t_m} \sum_{\substack{\text{applicable pairings} \\ P = \{(z_i, z'_i)\}}} (-1)^{\#P\downarrow} D_P \prod_{i=1}^m \frac{dz_i - dz'_i}{z_i - z'_i} \in \bar{\mathcal{A}}^r. \quad (2.5)$$

In the above equation,

- an ‘applicable pairing’ is a choice of an unordered pair (z_i, z'_i) for every $1 \leq i \leq m$, for which (z_i, t_i) and (z'_i, t_i) are *distinct* points on K .
- $\#P_\downarrow$ is the number of points of the form (z_i, t_i) or (z'_i, t_i) at which K is decreasing. Remember that in this article we are only considering *oriented* knots.
- D_P is the chord diagram naturally associated with K and P as in figure 2. It is to be regarded as an element of $\bar{\mathcal{A}}^r$.
- every pairing defines a map $\{t_i\} \mapsto \{(z_i, z'_i)\}$ locally around the current values of the t_i ’s. Use this map to pull the dz_i ’s and dz'_i ’s to the m -simplex $t_{\min} < t_1 < \dots < t_m < t_{\max}$ (where t_{\min} (t_{\max}) is the minimal (maximal) value of t on K) and then integrate the indicated wedge product over that simplex.

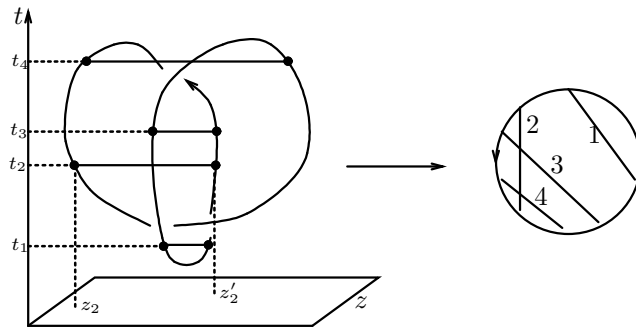

Figure 2. $m = 4$: a knot K with a pairing P and the corresponding chord diagram D_P . Notice that $D_P = 0$ in $\bar{\mathcal{A}}^r$ due to the isolated chord marked by 1.

2.5.1 Finiteness

Properly interpreted, the integrals in (2.5) are finite. There appears to be a problem in the denominator when $z_i - z'_i$ is small for some i . This can happen in either of two ways:

1. in this case the integration domain for z_{i+1} is as small as $z_i - z'_i$, and its ‘smallness’ cancels the singularity coming from the denominator.
2. in this case the corresponding diagram D_P has an isolated chord, and so it is 0 in $\bar{\mathcal{A}}^r$.

2.5.2 Invariance under horizontal deformations

For times $t_{\min} \leq a < b \leq t_{\max}$ define $Z(K, [a, b])$ in exactly the same way as (2.5), only restricting the domain of integration to be $a < t_1 < \dots < t_m < b$. Of course, $Z(K, [a, b])$ will not be in $\bar{\mathcal{A}}^r$, but rather in the completed vector space

$$\bar{\mathcal{A}}^{K, [a, b]} = \text{span} \left\{ \begin{array}{l} \text{diagrams whose solid lines} \\ \text{are as in the part of } K \text{ on} \\ \text{which } a \leq t \leq b \end{array} \right\} \Bigg/ \left\{ \begin{array}{l} STU \text{ relations and dia-} \\ \text{grams with subdiagrams} \\ \text{like } \begin{array}{c} \text{---} \text{---} \text{---} \\ \text{---} \text{---} \end{array} \end{array} \right\}.$$

For example, if t_1 , t_4 , and K are as in figure 2, then the following is a diagram in $\bar{\mathcal{A}}^{K,[t_1,t_4]}$:

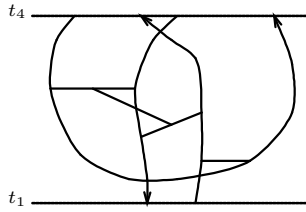

The same reasoning as in section 2.5.1 shows that $Z(K, [a, b])$ is finite. For $t_{\min} \leq a < b < c \leq t_{\max}$, there is an obvious product $\bar{\mathcal{A}}^{K,[a,b]} \otimes \bar{\mathcal{A}}^{K,[b,c]} \rightarrow \bar{\mathcal{A}}^{K,[a,c]}$, and it is easy to show that with this product $Z(K, [a, b])Z(K, [b, c]) = Z(K, [a, c])$.

Let $t_{\min} < a < b < t_{\max}$ be times for which K has no critical points in the time slice $a \leq t \leq b$, and let n be the number of upward (or downward) pointing strands of K in that slice. Then $\bar{\mathcal{A}}^{K,[a,b]} \equiv \bar{\mathcal{A}}(n \uparrow \amalg n \downarrow)$, and comparing with (2.2) and the definition of $\Omega_{n,n}$ we see that $Z(K, [a, b])$ is the holonomy of $\Omega_{n,n}$ along the braid defined by the intersection of K with the slice $a \leq t \leq b$. The flatness of $\Omega_{n,n}$ implies that this holonomy is invariant under horizontal deformations of that piece of K , and together with

$$Z(K) = Z(K, [t_{\min}, t_{\max}]) = Z(K, [t_{\min}, a])Z(K, [a, b])Z(K, [b, t_{\max}]) \tag{2.6}$$

we see that $Z(K)$ is invariant under horizontal deformations of K which ‘freeze’ the time slices in which K has a critical point.

2.5.3 Moving critical points

In this section we will show that (subject to some restrictions) $Z(K)$ is also invariant under deformations of K that do move critical points. The idea is to narrow the parts near critical points to sharp needles using horizontal deformations, and then show that very sharp needles contribute almost nothing to $Z(K)$ and therefore can be moved around freely. For example, here’s how this trick allows us to move two critical points across each other:

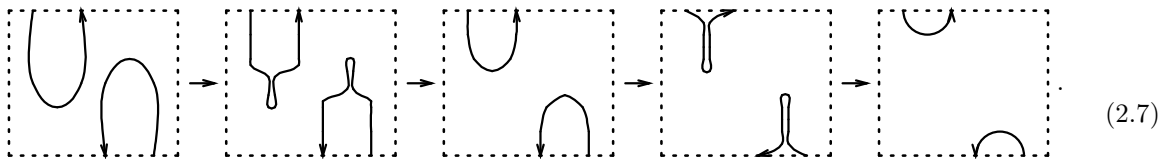

Lemma 2.7 *If the two knots $K_{1,2}$ both contain a sharp needle of width ϵ , and are the identical except possibly for the length and the directions of their respective needles, then*

$$\|Z_m(K_1) - Z_m(K_2)\| \sim \epsilon$$

where Z_m is the degree m piece of Z and $\|\cdot\|$ is some fixed norm on \mathcal{A}_m^r .

Proof : Clearly, the difference between $Z_m(K_1)$ and $Z_m(K_2)$ will come only from terms in (2.5) in which one of the z_i ’s (or z_i ’s) is on the needle. So let us show that if a knot K contains a needle N of width ϵ , then such terms in $Z_m(K)$ are at most proportional to ϵ . Without loss of generality we can assume that the needle N points upward. If the highest pair (z_i, z_i') that touches N connects the two sides of N , the corresponding diagram is 0 in $\bar{\mathcal{A}}^r$ and there is nothing to worry about. If there is no pair (z_j, z_j') that connects the two sides of N then again life is simple: in that case there are no singularities in (2.5) so nothing big prevents

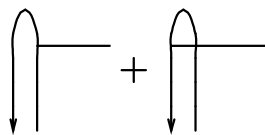

from being small. (Notice that these two terms appear in $Z(K)$ with opposite signs due to the factor $(-1)^{\#P_\downarrow}$ but otherwise they differ only by something proportional to ϵ). If (z_j, z'_j) is a pair that does connect the two sides of N , it has to do so in the top (round) part of N — otherwise $dz_j - dz'_j = 0$.

So the only terms that cause some worry are those that have some $k > 1$ pairs $(z_{j_1}, z'_{j_1}), \dots, (z_{j_k}, z'_{j_k})$ on the top part of N , with (z_{j_k}, z'_{j_k}) being the highest of these pairs and (z_{j_1}, z'_{j_1}) the lowest. We might as well assume that there are no pairs other than (z_i, z'_i) that touch N only once — such pairs just shorten the domain of integration in (2.5) without adding any singularity in the denominator. So what we have looks like:



Writing $\delta_\alpha = |z_{j_\alpha} - z'_{j_\alpha}|$, we see that the integral corresponding to (2.8) is bounded by a constant times

$$\int_0^\epsilon \frac{d\delta_1}{\delta_1} \int_0^{\delta_1} \frac{d\delta_2}{\delta_2} \dots \int_0^{\delta_{k-1}} \frac{d\delta_k}{\delta_k} \int_{z_{j_k}}^{z'_{j_k}} \frac{dz_i - dz'_i}{z_i - z'_i} \sim \epsilon.$$

Unfortunately, there is one type of deformation that (2.7) and lemma 2.7 cannot handle — the total number of critical points in K cannot be changed:

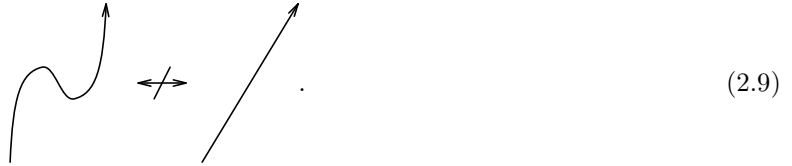

Even if the hump on the left figure is deformed into a needle and then this needle is removed, a (smaller) hump still remains.

2.5.4 The correction

Let the symbol ∞ stand for the embedding . Notice that

$$Z(\infty) = \bigcirc + (\text{higher order terms}) \tag{2.10}$$

and so using power series $Z(\infty)$ can be inverted and the following definition makes sense:

Definition 2.8 Let K be a knot embedded in $\mathbf{C} \times \mathbf{R}$ with c critical points. Notice that c is always even and ³set

$$\tilde{Z}(K) = \frac{Z(K)}{(Z(\infty))^{\frac{c}{2}}}.$$

Theorem 2.9 $\tilde{Z}(K)$ is invariant under arbitrary deformations of the knot K .

Proof : Clearly, $\tilde{Z}(K)$ is invariant under deformations that do not change the number of critical points of K , and the only thing that remains to be checked is its invariance under the move (2.9). So let K_c and K_s be two knots that are identical other than that in some place K_c has the figure in the left side of (2.9) while in the same place K_s has the figure on the right side of (2.9). We need to show that in $\bar{\mathcal{A}}^r$,

$$Z(K_c) = Z(\infty)Z(K_s).$$

³The non-invariance of $Z(K)$ under the move (2.9) was first noticed by R. Bott and the first author. The correction $\tilde{Z}(K)$ is due to Kontsevich [Kon].

Using deformations as in section 2.5.3 we can move the ‘humps’ of K_c to be very far from the rest of the knot, and shrink them to be very small. This done, we can ignore contributions to $Z(K_c)$ coming from pairings in which any of the pairs connect the humps to the rest of the knot. Hence $Z(K_c)$ factors to a part which is the same as in $Z(K_s)$ times contributions that come from pairings that pair the ‘humpy’ part of K_c to itself. But as the following figure shows, for the same reasons as in section 2.5.3, these contributions are precisely $Z(\infty)$:

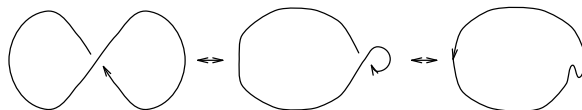

Exercise 2.10 Show that $\tilde{Z}(K)$ is in fact real, even though complex numbers do appear in (2.5).

Hint 2.11 Use the fact that the transformation $t \rightarrow -t$, $z \rightarrow \bar{z}$ maps a knot to an equivalent knot, while mapping $\Omega_{n,n}$ to minus its conjugate.

Remark 2.12 Le and Murakami [LM], building on work of Drinfel'd ([Dr1] and [Dr2]), proved that $\tilde{Z}(K)$ has rational coefficients.

2.6 Universality of the Kontsevich integral.

It is enough to show that if $D \in \mathcal{D}_m^0$ is a chord diagram of degree m underlying some m -singular knot K , then (for the natural extension of \tilde{Z} to knots with double points):

$$\tilde{Z}(K) = D + (\text{terms of degree } > m).$$

In view of (2.10), it is enough to prove the same for Z rather than for \tilde{Z} . If two knots K^o and K^u are identical except that two of their strands form an overcrossing in K^o and an undercrossing in K^u , it is clear that the only contributions to $Z(K^o) - Z(K^u)$ come from pairings in which these two strands are paired. $Z(K_D)$ is a signed sum of Z evaluated on 2^m knots, and this sum can be partitioned in pairs like the above $K^{o,u}$ around m different crossings — and thus contributions to $Z(K_D)$ come only from pairings that pair the strands near any of the m double points of K_D . This implies that the lowest degree contribution to $Z(K_D)$ is at least of degree m . In degree m the pairing P is determined by the above restriction. It is easy to see that in that case $D_P = D$, and therefore the piece of degree precisely m in $Z(K_D)$ is proportional to D . It remains to determine the constant of proportionality. This is a simple computation — in degree 1, the difference between $Z(K^o)$ and $Z(K^u)$ comes from the difference between integrating

$$\frac{dz - dz'}{z - z'}$$

along a contour in which z passes near but above z' and along a contour in which z passes near but under z' . By Cauchy's theorem this is $2\pi i$. Repeating this m times for each of the m double points of K_D , we get $(2\pi i)^m$ and this exactly cancels the $(2\pi i)^{-m}$ in (2.5). \square

2.7 Why are we not happy?

1. Why did we have to choose time axis?
2. Why did analysis (estimates for needles ...) come in?
3. Why did the real numbers come all together? The theorem can be formulated over an arbitrary Abelian group. Is it true in that generality?

3 Physics (sketch)

Remark 3.1 *This is the oldest approach, about 5-6 years old. Here we follow the presentation in [B-N1] and [B-N3].*

3.1 Invariants from path integrals.

Reminder: We are looking for a knot invariant

$$\tilde{Z} : \{\text{knots}\} \longrightarrow \bar{\mathcal{A}}^r = \text{span} \left\{ \left(\text{circle with chord} \right) \right\} / \begin{matrix} FI \\ AS \\ IHX \\ STU \end{matrix}$$

such that if K is singular, $\tilde{Z}(K) = D_K + (\text{higher degrees})$, where D_K is the chord diagram underlying K .

Idea Geometric invariants are cheaper than topological ones. So introduce a geometrical structure A , get an invariant and average out over all possible choices of A .

Example 3.2 *Define*

$$\mathcal{Z}_k(\mathbf{R}^3, K) = \int_{\Omega^1(\mathbf{R}^3, \mathfrak{g})} \mathcal{D}A \text{tr}_R \text{hol}_K(A) \cdot I_k \left(\frac{1}{4\pi} \int_{\mathbf{R}^3} \text{tr}(A \wedge dA + \frac{3}{4} A \wedge A \wedge A) \right)$$

where \mathfrak{g} is a Lie algebra, A is a \mathfrak{g} -connection on \mathbf{R}^3 , $\Omega^1(\mathbf{R}^3, \mathfrak{g})$ is the space of all such connections, R is a representation of \mathfrak{g} , π is the ratio of the circumference and the diameter of a circle, and $I_k(z)$ is the k 'th modified Bessel function of the first kind.

This is of course silly. Most of us don't even remember what a Bessel function is, and certainly not how to integrate Bessel functions on spaces of high dimension. None of us knows how to integrate things like that on infinite dimensional spaces. When we toss the question to our physicist friends, we find that they never really meant to say that integration on infinite dimensional spaces is possible. Only that

- * for *very* special types of integrands there is a very complicated *formal* integration technique,
- * which is very delicate and plagued with several layers of unexpected difficulties.

The integration technique is

Step 1 Find something you can do in \mathbf{R}^n for all n with a closed-form answer which depends lightly on n .

Step 2 Roughly, "substitute $n = \infty$ " and *hope* that everything still makes sense.

Step 1 basically restricts us to deal with integrals of the form

$$\int (\text{polynomial}) e^{\kappa \left(\text{quadratic} + \frac{\text{higher order}}{\text{perturbations}} \right)} \quad (3.1)$$

(step 2 will put even further restrictions). So we're left with

$$\mathcal{Z}_k(\mathbf{R}^3, K) = \int \mathcal{D}A \text{tr}_R \text{hol}_K(A) \cdot \exp \left(\frac{ik}{4\pi} \int_{\mathbf{R}^3} \text{tr}(A \wedge dA + \frac{3}{4} A \wedge A \wedge A) \right), \quad (3.2)$$

which is of the required form because

$$\text{hol}_k(A) = \sum_{m=0}^{\infty} \int_{0 \leq t_1 \leq \dots \leq t_m \leq 1} (K^* A)(t_m) \cdot \dots \cdot (K^* A)(t_1)$$

is a polynomial (oh well, power series) in A .

3.2 A finite dimensional analogue.

Let us start by showing how integrals like (3.1) are computed in \mathbf{R}^n . By rescaling \vec{x} and Taylor expanding,

$$\begin{aligned} \int_{\mathbf{R}^n} d\vec{x} e^{it(\frac{1}{2}\lambda_{ij}x^i x^j + \lambda_{ijk}x^i x^j x^k)} &\propto \int_{\mathbf{R}^n} d\vec{x} e^{\frac{i}{2}\lambda_{ij}x^i x^j + \frac{i}{t}\lambda_{ijk}x^i x^j x^k} \\ &= \int_{\mathbf{R}^n} d\vec{x} e^{\frac{i}{2}\lambda_{ij}x^i x^j} \sum_{m=0}^{\infty} \frac{(-1)^m}{(2m)! t^m} (\lambda_{ijk}x^i x^j x^k)^{2m}. \end{aligned}$$

Picking up just one term, for simplicity:

$$\begin{aligned} \int_{\mathbf{R}^n} d\vec{x} e^{\frac{i}{2}\lambda_{ij}x^i x^j} \frac{(-1)^m}{(2m)! t^m} (\lambda_{ijk}x^i x^j x^k)^{2m} &= \left(\lambda_{ijk} \frac{-i\partial}{\partial J_i} \frac{-i\partial}{\partial J_j} \frac{-i\partial}{\partial J_k} \right)^{2m} \int d\vec{x} e^{\frac{i}{2}\lambda_{ij}x^i x^j + iJ_i x^i} \Big|_{J=0} \\ &\propto \left(\lambda_{ijk} \frac{-i\partial}{\partial J_i} \frac{-i\partial}{\partial J_j} \frac{-i\partial}{\partial J_k} \right)^{2m} e^{-\frac{i}{2}\lambda^{\alpha\beta} J_\alpha J_\beta} \Big|_{J=0}, \end{aligned} \quad (3.3)$$

where $\lambda^{\alpha\beta}$ is the inverse of λ_{ij} .

Now comes a *combinatorial* challenge (notice that there are no integrals left). We need to understand the multiple differentiations in (3.3). When all the dust settles, this becomes:

$$\sum_{\text{Feynman diagrams } D} \left(\sum_{\text{labels}} \mathcal{E}(D) \right),$$

where $\mathcal{E}(D)$ is defined as in the following example



$$\lambda_{ijk} \lambda_{lmn} \lambda_{opq} \lambda_{rst} \lambda^{im} \lambda^{jp} \lambda^{ks} \lambda^{ot} \lambda^{nr} \lambda^{lq}.$$

The ellipticity problem: We see that in computing (3.1), we need to invert the quadratic piece. So to compute (3.2) we need to invert $A \wedge dA$. But it is not invertible because $\{dC\}$ is in the radical of this quadratic form.

Back to finite dimensions: If $L = \frac{1}{2}\lambda_{ij}x^i x^j + \lambda_{ijk}x^i x^j x^k$ is invariant under some l -dimensional group action you can integrate over a section:

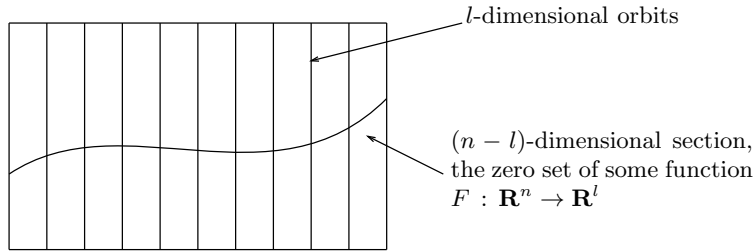

On the section, the quadratic form is non-degenerate. But the section may not be a linear space!

Solution: (The “Faddeev-Popov procedure”.) Integrate against a δ -function concentrated on the section, and include a Jacobian which measures both the volume of the orbit and the “angle” with which the orbit meets the section. That is, compute

$$\int d\vec{x} e^{it(\frac{1}{2}\lambda_{ij}x^i x^j + \lambda_{ijk}x^i x^j x^k)} \delta^l(F(\vec{x})) \det\left(\frac{\partial F^a}{\partial \mathfrak{g}_b}\right)(x)$$

By Fourier analysis

$$\delta^l(F(\vec{x})) = \int d\vec{\Phi} e^{iF^a(\vec{x})\Phi_a}.$$

By cheating (or by introducing “anti-commuting variables”)

$$\det\left(\frac{\partial F^a}{\partial \mathfrak{g}_b}\right) = \int d\vec{c} d\vec{c} e^{i\bar{c}_a \frac{\partial F^a}{\partial \mathfrak{g}_b} c^b}$$

We end up back again with a Gaussian, this time non-degenerate:

$$\int d\vec{x} d\vec{\Phi} d\vec{c} d\vec{c} \exp\left(t\left(\frac{1}{2}\lambda_{ij}x^i x^j + \lambda_{ijk}x^i x^j x^k\right) + F^a(\vec{x})\Phi_a + \bar{c}_a \frac{\partial F^a}{\partial \mathfrak{g}_b} c^b\right).$$

3.3 Chern-Simons perturbation theory.

Setting $\frac{3}{4} = \frac{2}{3}$, our Lagrangian becomes the Chern-Simons-functional

$$\int \text{tr}(A \wedge dA + \frac{2}{3}A \wedge A \wedge A),$$

which is gauge-invariant. Applying Faddeev-Popov (with some F) and then crunching Feynman diagrams, we get a messier Lagrangian, whose perturbation theory has the following general form:

$$\mathcal{Z}_k(K) \sim \sum_{m=0}^{\infty} \frac{1}{k^m} \sum_{\substack{\text{degree } m \\ \text{diagrams } D}} W(D) \sum_{\substack{\text{labels in } \{1, 2, 3\}, \\ \{1, 2, \dots, \dim \mathfrak{g}\}, \\ \mathbf{R}^3 \text{ and } S^1}} \mathcal{E}(D) \quad \left(\sum \text{ is a symbol that should have long been introduced into mathematics. It means “sum over discrete variables and integrate over continuous ones”.} \right)$$

Here $W(D)$ is the Lie-algebraic weight of D as in the previous lecture, and $\mathcal{E}(D)$ is a horrifying expression which is a big product of “vertex terms” corresponding to $\frac{2}{3} A \wedge A \wedge A$, “edge terms” that look like $\epsilon^{ijk} \frac{x^k - y^k}{\|x - y\|^3}$, corresponding to the singular integral-kernel of an inverse of $A \wedge dA$, and additional terms coming from the holonomy of A along K .

Example 3.3 When $m = 2$, we get (roughly):

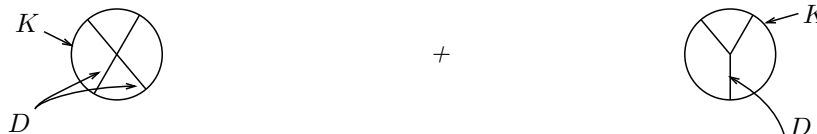

4-fold integration along K of 4 copies of

$$\epsilon^{ijk} \frac{x^k - y^k}{\|x - y\|^3}$$

3-fold integration along K , 1-fold integration on \mathbf{R}^3 of three copies of $\epsilon^{ijk} \frac{x^k - y^k}{\|x - y\|^3}$ and summation over many indices.

Idea There ought to be a direct “differentiating under the integral” proof of the invariance of $Z_k(K)$. That proof will use properties of the map $D \rightarrow W(D)$, and it seems that all that those can be is *AS*, *IHX*, and *STU*.

Therefore,

$$Z(K) = \sum_{m=0}^{\infty} \sum_D D \cdot \int_{\text{labels}} \mathcal{E}(D) \in \bar{A} = \left\{ \begin{array}{l} \text{Feynman} \\ \text{diagrams} \end{array} \right\} / \begin{array}{l} AS \\ IHX \\ STU \end{array}$$

ought to be an invariant (and a local computation near the double points shows it to be a universal Vassiliev invariant).

Problems

1. $\int \mathcal{E}(D)$ is naively **divergent**.
2. When differentiating under the integral $\int \mathcal{E}(D)$ gets worse, and in fact, the result is non-zero. I. e., we have an *ikke-invariant*.⁴

Solutions

1. Work harder to show convergence.
2. Add a local correction factor, in the same spirit as of $Z(\infty)$ of the previous lecture (but very different).

Costs

1. Lose some on elegance.
2. Reintroduce the Framing-Independence (*FI*) relation.

History The first knot invariants of this type were written (with no invariance proof) by Guadagnini, Martellini and Mintchev [GMM1, GMM2], following Witten’s discovery [Wit] that the Jones polynomial can be written in terms of the Chern-Simons quantum field theory. The same invariants were independently written (together with an invariance proof) somewhat later by the first author [B-N1], who was later [B-N3] able to write a general invariance proof in all orders of perturbation theory using only the *STU*, *AS*, and *IHX* relations, but assuming without proof the convergence of all the integrals appearing. Rather complete results on perturbative invariants of 3-manifolds were obtained later by Axelrod and Singer [AS1, AS2] and by Kontsevich (mostly unpublished). Recently Bott and Taubes [BT] reformulated the results of [B-N1] in a much cleaner and prettier topological language and suggested how this can be continued in higher orders, and Thurston [Th] was able to complete their work and write a proof of the Fundamental Theorem in these terms.

3.4 Why are we not happy?

1. In the Bott-Taubes formulation, much of the mess is gone, and the integrals become evaluations of the volume form of S^2 on various reasonably natural chains constructed out of configuration space of points on the knot and elsewhere in \mathbf{R}^3 . But still, this approach is very complicated and not quite the first thing you would come up with.
2. The relationship with the Kontsevich-KZ approach and with the Reshetikhin-Turaev invariants is still unclear.
3. The usual problem – what if you wanted to work over $\mathbf{Z}/3\mathbf{Z}$ or over \mathbf{Z} ?

⁴The Danish work “ikke” is better suited for our purposes than the English “not”, as it is not homophonous to “knot”.

4 Algebra (sketch)

Remark 4.1 *In this lecture we follow [B-N6], [Ca, Ka, LM, Pi, Sto1], and of course Drinfel'd [Dr1, Dr2].*

4.1 Motivation from the Kontsevich-KZ integrals

Recall the Kontsevich-KZ integrals, roughly given as

$$\sum_{\substack{\text{pairings} \\ P}} D_P \cdot \prod \frac{dz_i - dz'_i}{z_i - z'_i} \in \bar{\mathcal{A}}^r$$

and the Chern-Simons integrals

$$\sum_{\substack{\text{Feynman} \\ \text{diagrams} \\ D}} D \cdot \mathcal{E}(D) \in \bar{\mathcal{A}}$$

The KKZ integrals are “multiplicative” in the sense of (2.6). The CS integrals probably also become multiplicative once the knot is sufficiently “stretched”.

Maybe these integrals can be evaluated by first deforming the knot into some favorable position, and then by cutting along the time slices and computing each piece separately?

For example, here is a better presentation for the trefoil:

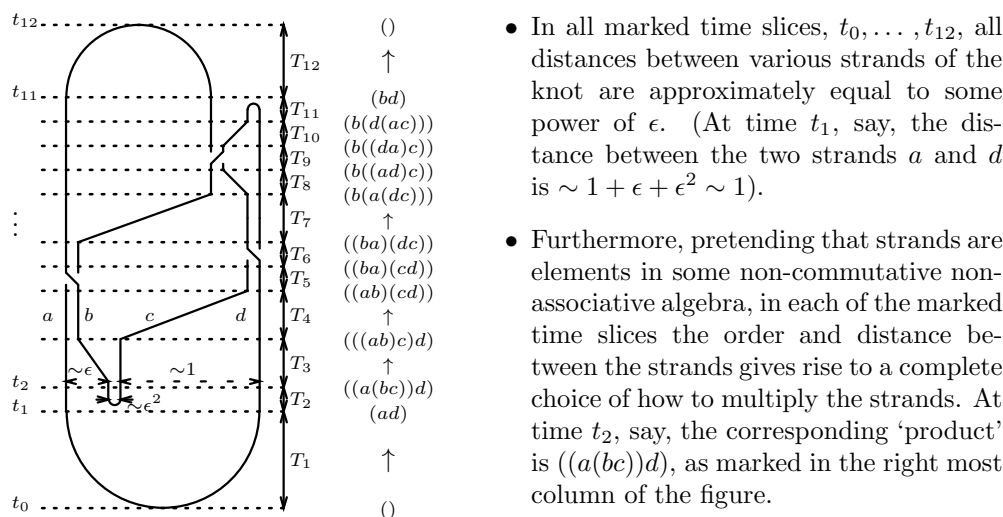

- In all marked time slices, t_0, \dots, t_{12} , all distances between various strands of the knot are approximately equal to some power of ϵ . (At time t_1 , say, the distance between the two strands a and d is $\sim 1 + \epsilon + \epsilon^2 \sim 1$).
- Furthermore, pretending that strands are elements in some non-commutative non-associative algebra, in each of the marked time slices the order and distance between the strands gives rise to a complete choice of how to multiply the strands. At time t_2 , say, the corresponding ‘product’ is $((a(bc))d)$, as marked in the right most column of the figure.

- In each of the time intervals T_1, \dots, T_{12} only one change occurs to the ‘product’ corresponding to the strands, and only three types of changes occur:
 - Pair creation (annihilation)*, in which a pair of *neighboring strands* is created (or annihilated). *Neighboring strands* are strands for which the distance between them is smaller than the distance between them and any other strand. (intervals T_1, T_2, T_{11} , and T_{12}).
 - Braiding morphism*, in which two neighboring strands are braided. (intervals T_5, T_6 , and T_9).
 - Associativity morphism*, in which the associative law is applied once. (intervals T_3, T_4, T_7, T_8 , and T_{10}).

In this presentation, the computation of the KKZ integral in each time interval is relatively simple. For example,

T_{12} : Id by the FI relation.

T_{11} : The left two strands are too far to matter (the contribution of diagrams with chords ending on them is too small), and the rest is as in T_{12} .

T_{10} : The left strand is irrelevant, so we are left with understanding what is the Kontsevich integral on



The result will be some Φ of the following shape

$$\Phi =: Z \left(\left| \begin{array}{c} \text{curve} \\ \text{strand} \end{array} \right| \right) = \sum \langle \text{coefficients} \rangle \langle \text{diagrams like } \left(\begin{array}{c} \text{strand} \\ \text{strand} \\ \text{strand} \end{array} \right) \rangle$$

T_9 :

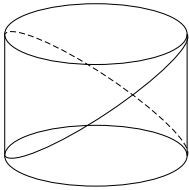

After ignoring the left most and the right most strands, we have a braiding. We may assume that the two braiding strands are parametrized uniformly around a cylinder as in the figure, and then $(dz - dz')/(z - z') = d\theta = dt$, so we can easily compute the value of the Kontsevich integral by directly integrating over the simplex $t_{\min} < t_1 < \dots < t_m < t_{\max}$. We get

$$Z \left(\begin{array}{c} \diagup \\ \diagdown \end{array} \right) = \begin{array}{c} \diagup \\ \diagdown \end{array} + \frac{1}{2 \cdot 1!} \begin{array}{c} \diagup \\ \diagdown \\ \diagup \\ \diagdown \end{array} + \frac{1}{2^2 \cdot 2!} \begin{array}{c} \diagup \\ \diagdown \\ \diagup \\ \diagdown \\ \diagup \\ \diagdown \end{array} + \frac{1}{2^3 \cdot 3!} \begin{array}{c} \diagup \\ \diagdown \\ \diagup \\ \diagdown \\ \diagup \\ \diagdown \\ \diagup \\ \diagdown \end{array} + \dots = R \cdot \begin{array}{c} \diagup \\ \diagdown \end{array},$$

where $R = \exp \left(\frac{1}{2} \left(\begin{array}{c} \uparrow \\ \uparrow \end{array} \right) \right)$.

T_8 : Here we have a variation of the inverse of Φ , obtained by “placing Φ^{-1} on strands 2, 3, and 4”. Symbolically, we write it as $(\Phi^{234})^{-1}$.

T_7 : In this time interval, the rightmost two strands are too close to each other for the other strands to tell them apart. In the Kontsevich integral, chords whose right end is on the 3rd strand appear with the same weight as chords whose right end is on the 4th strand, and with the same weight as the corresponding chords that appear in the computation of Φ . This means that

$$Z \left(\left| \begin{array}{c} \text{curve} \\ \text{strand} \\ \text{strand} \end{array} \right| \right) = (1 \otimes 1 \otimes \Delta)(\Phi),$$

where the operation Δ doubles a strand and sums over all possible ways of ‘lifting’ the chords that were connected to it to the two offspring chords.

4.2 Relations between R and Φ .

Now try to reconstruct the Kontsevich integral algebraically. As is clear from section 4.1, to know the Kontsevich integral on all knots (and, in fact, on all “parenthesized tangles”, the kind of objects that appear between any two time slices in knot presentations such as in section 4.1), it is enough to compute only two quantities, R and Φ , once and for all. As the computation of Φ appears hard, let’s just assign an arbitrary value to it (and to R as well), and check what axioms these R and Φ have to satisfy so that the computation algorithm implicitly defined in section 4.1 really does yield an invariant. One can check that the axioms are as follows:

4.2.1 Axioms for R and Φ .

- The pentagon axiom:

$$\Phi^{123} \cdot (1 \otimes \Delta \otimes 1)(\Phi) \cdot \Phi^{234} \cdot (1 \otimes 1 \otimes \Delta)(\Phi^{-1}) \cdot (\Delta \otimes 1 \otimes 1)(\Phi^{-1}) = 1 \quad (\diamond)$$

Needed because of the funny presentation of the trivial braid shown in figure 3.

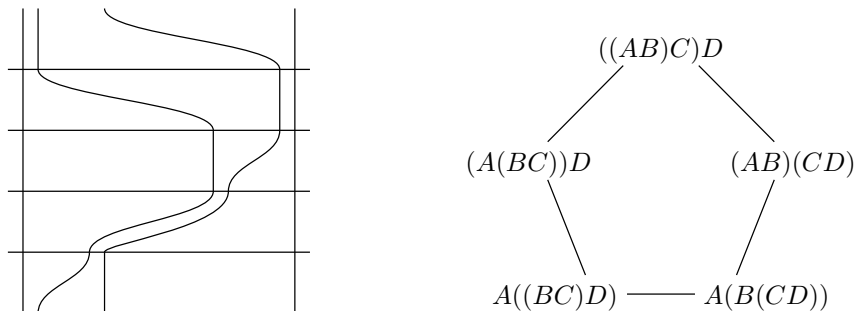

Figure 3. Left: The presentation of the trivial braid that leads to the pentagon axiom. Right: The reason for the name “pentagon”. When the arrangements at the indicated time slices of the strands on the left are written as ‘products’, we get a pentagon of associativities.

- The hexagon axioms: (See figure 4)

$$(\Delta \otimes 1)R^{\pm 1} = \Phi \cdot (R^{23})^{\pm 1} \cdot (\Phi^{-1})^{132} \cdot (R^{13})^{\pm 1} \cdot \Phi^{312} \quad (\odot_{\pm})$$

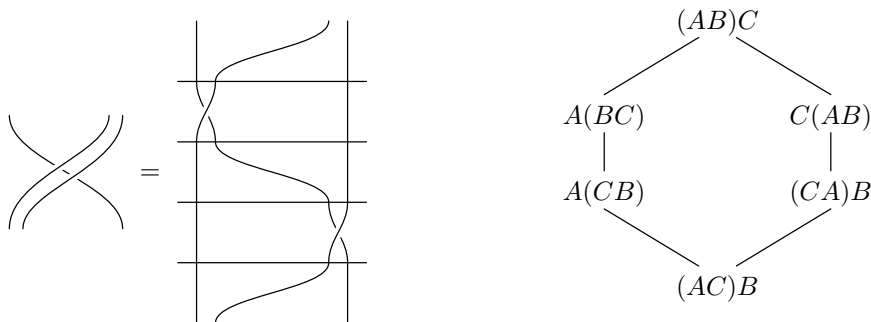

Figure 4. The braid equality leading to the “+” hexagon axiom, and the associativities hexagon that gave it its name. To get the “-” hexagon axiom, simply flip all crossings.

4.2.2 Automatic relations between R and Φ .

There are two other types of relations, that R and Φ satisfy automatically (and hence do not impose constraints on their possible values).

- Locality in space relations: Events that happen far away from each other commute. For example:

$$\begin{array}{c} \text{Diagram 1} \end{array} \quad \begin{array}{c} \text{Diagram 2} \end{array} = \begin{array}{c} \text{Diagram 3} \end{array} \quad \begin{array}{c} \text{Diagram 4} \end{array} \quad \text{or} \quad R^{12}\Phi^{345} = \Phi^{345}R^{12}.$$

These relations are a consequence of the fact that in chord diagrams the chords are not time-ordered; only their ends are ordered. And thus chords whose ends are on different strands always commute.

- Locality in scale relations: Events that happen at different scales commute. The third Reidemeister

move is an example for such a relation:

$$\begin{array}{c} \text{diagram 1} \end{array} = \begin{array}{c} \text{diagram 2} \end{array}, \quad \text{or} \quad (\Delta \otimes 1)R \cdot R^{12} = R^{12} \cdot (\Delta \otimes 1)R.$$

These relations are consequences of the 4T relation, written in the form

$$\begin{array}{c} \text{diagram 3} \end{array} + \begin{array}{c} \text{diagram 4} \end{array} = \begin{array}{c} \text{diagram 5} \end{array} + \begin{array}{c} \text{diagram 6} \end{array}.$$

4.3 An aside on quasi-Hopf algebras.

Just for the sake of completeness, let us spend just around one page on recalling where Drinfel'd first found the pentagon and the hexagon equations [Dr1]. The context is superficially very different, but the equations turn out to be exactly the same (though they are about different kinds of objects). The technique we use for solving these equations in section 4.4 is nothing but Drinfel'd's technique of [Dr2], adopted to our situation.

If R_1 and R_2 are representations of some algebra A , $R_1 \otimes R_2$ is a representation of $A \otimes A$, but (in general) not of A . To be able to take the tensor product of representations, we need to have a morphism $\Delta : A \rightarrow A \otimes A$ called "the co-product".

If we want the tensor product of representations to be associative, Δ must be "co-associative":

$$(\Delta \otimes 1)\Delta a = (1 \otimes \Delta)\Delta a \quad \forall a \in A$$

If this happens, (A, Δ) is a "Hopf-Algebra".

In [Dr1], Drinfel'd suggested relax the condition of associativity. Instead of

* " $R_1 \otimes (R_2 \otimes R_3)$ and $(R_1 \otimes R_2) \otimes R_3$ are the same"

we only require (roughly)

* " $R_1 \otimes (R_2 \otimes R_3)$ and $(R_1 \otimes R_2) \otimes R_3$ are equivalent in a functorial way".

This leads to a relaxation of the co-associativity condition on A :

$$\exists \Phi \in A^{\otimes 3} \quad \text{s.t.} \quad \forall a \in A \quad (\Delta \otimes 1)\Delta a = \Phi^{-1}((1 \otimes \Delta)\Delta a) \Phi$$

But then Φ needs to have some properties, if diagrams like

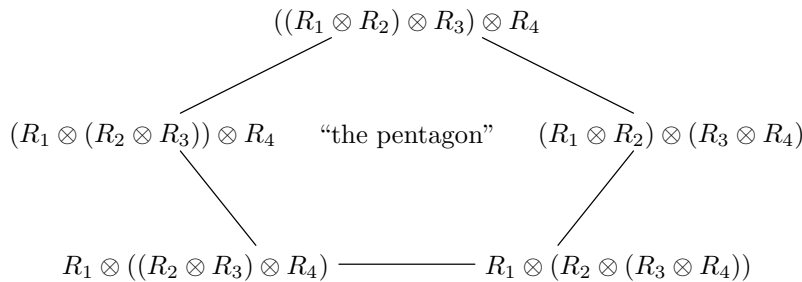

are to be commutative. A triple (A, Δ, Φ) for which these conditions are satisfied is called "a quasi-Hopf algebra".

Similarly, one may assume a relaxed form of commutativity for \otimes , introduce an $R \in A^{\otimes 2}$, and see what R has to satisfy for the hexagons to hold. The resulting gadget (A, Δ, Φ, R) is called "a quasitriangular quasi-Hopf algebra". When the conditions on $R \in A^{\otimes 2}$ and $\Phi \in A^{\otimes 3}$ are written explicitly, they are *formally* identical to the pentagon and the hexagon equations that we wrote.

Now, back to our construction. We need to find R and Φ satisfying \diamond and \circlearrowleft_{\pm} .

4.4 Constructing a pair (R, Φ) .

Idea: Use the grading of chord diagrams. Take $R_1 = 1 + \frac{1}{2} \uparrow \downarrow$ and $\Phi_1 = \uparrow \uparrow \uparrow$, and work inductively, degree by degree, to find R and Φ .

Assume, (R_m, Φ_m) satisfy \diamond and \circ_{\pm} up to degree m , and let μ and ψ_{\pm} be the corresponding error in degree $m + 1$ of putting (R_m, Φ_m) into \diamond and \circ_{\pm} modulo degree $m + 1$. Set $\Phi_{m+1} = \Phi_m + \phi$ and $R_{m+1} = R_m + r$.

We need to solve the two equations

$$\mu = \phi^{234} - (\Delta \otimes 1 \otimes 1)\phi + (1 \otimes \Delta \otimes 1)\phi - (1 \otimes 1 \otimes \Delta)\phi + \phi^{123} \tag{4.1}$$

and

$$\psi_{\pm} = \phi^{123} - \phi^{132} + \phi^{312} \pm (r^{23} - (\Delta \otimes 1)r + r^{13}), \tag{4.2}$$

which are the linearizations of \diamond and of \circ_{\pm} .

Notice that the first equation is $\mu = d\phi$ for the differential

$$d = \sum_{i=0}^{n+1} (-1)^i d_i^n : \mathcal{A}(n\uparrow) \stackrel{\text{def}}{=} \left\{ \underbrace{\uparrow \uparrow \uparrow \uparrow \uparrow}_n \right\} / 4T \longrightarrow \mathcal{A}((n+1)\uparrow) \stackrel{\text{def}}{=} \left\{ \underbrace{\uparrow \uparrow \uparrow \uparrow \uparrow}_{n+1} \right\} / 4T$$

defined by

$$d_0^n(\mathbb{D}) = \uparrow \mathbb{D}, \quad d_{n+1}^n(\mathbb{D}) = \mathbb{D} \uparrow$$

$$d_i^n(D) = (1 \otimes \cdots \otimes 1 \otimes \overset{i}{\Delta} \otimes 1 \otimes \cdots \otimes 1)(D) \quad 1 \leq i \leq n \quad \left(\begin{array}{c} \text{double} \\ i\text{th strand} \end{array} \right),$$

If we are to have any hope of solving (4.1) and (4.2), we must find relations between μ and ψ_{\pm} ! In particular, we'd better be able to prove that $d\mu = 0$.

Idea: One and the same morphism, say



appears in more than one variant of the pentagon, in which strands have been doubled or added on the left or on the right (and also in a few variants of the hexagons). So start from a schematic form of (say) the hexagon, in which we put tildes on top of letters instead of bothering to put all superscripts and Δ -symbols in place:

$$\tilde{\Phi} \tilde{R} \tilde{\Phi} \tilde{R} \tilde{\Phi} \tilde{R} = I + \tilde{\psi}.$$

expand one of the $\tilde{\Phi}$'s on the left hand side using (say) a \diamond and add an error term on the right:

$$\tilde{\Phi} \tilde{R} \tilde{\Phi} \tilde{\Phi} \tilde{\Phi} \tilde{R} \tilde{\Phi} \tilde{R} = I + \tilde{\psi} + \tilde{\mu}$$

Keep going this way while simplifying whenever you can, using some more variants of the pentagons and the hexagons, at the cost of some more error terms on the right, or using locality relations at no cost at all. If you're lucky, you can cancel all factors on the left (in a different way than you have expanded them), and you get to something like this:

$$I = I + \phi^{234} \pm (1 \otimes \Delta)\psi \pm \dots$$

or

$$0 = \phi^{234} \pm (1 \otimes \Delta)\psi \pm \dots$$

which is a relation of the kind we wanted.

There better be a systematic way of doing that! Here it is:

Let CA_n (the n 'th Commuto-Associahedron) be the two dimensional CW complex made of the following cells:

0-cells: All possible products of n elements a_1, \dots, a_n in a non associative non commutative algebra.

1-cells: All basic associativities and commutativities between such products.

- 2-cells: – A pentagon sealing every pentagon of the kind appearing in the pentagon relation.
 – A hexagon sealing every hexagon of the kind appearing in the hexagon relation.
 – A square sealing every locality relation of the type considered in section 4.2.2. Notice that every locality relation can be written as a product of four R 's and Φ 's, and so it corresponds to a square in the 1-skeleton of CA_n .

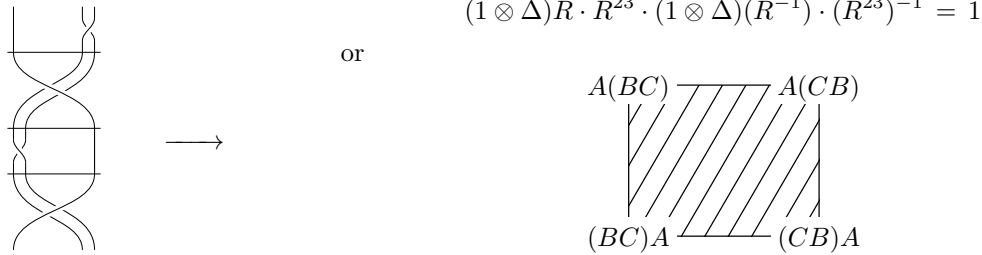

For an example, see figure 5.

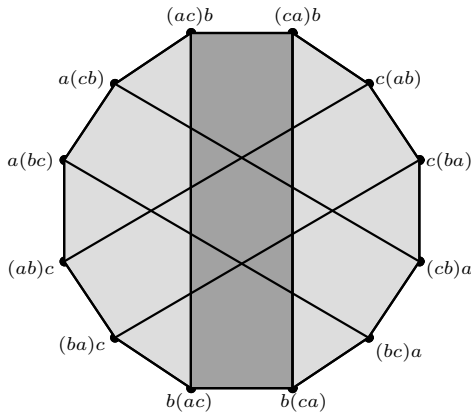

Figure 5. The third commuto-associahedron CA_3 . It is made by gluing three sets of a square and two hexagons each into a 12-gon. Only one of these sets is shaded in the figure; the other two are obtained from it by rotations by 60° and 120° respectively. Topologically, the result is a circle with three disks glued in, and has the homotopy type of a wedge of two spheres.

The faces corresponding to rules applied for obtaining a relation (as described above) form a subcomplex of CA_n homeomorphic to a closed surface. If we note each of the error terms in \diamond and \circ_{\pm} on the corresponding faces in CA_n (for locality relation this error is 0) this relation says that the sum of the terms on the faces of this surface vanishes. So, to find out (maximally) how many (independent) relations we may get, we need to know $b_2 = \dim H_2(CA_n)$. MacLane's coherence theorem says that CA_n is simply connected, so we are left with a simple counting for determining $\chi(CA_n)$. We find that

$$b_2 = \#\{\text{vertices}\} - \#\{\text{edges}\} + \#\{\text{faces}\} - 1$$

Example 4.2 Let $n = 3$. CA_3 is a circle with 3 disks attached (each of them separated into a rectangle and two hexagons), as shown in figure 5. So

$$b_2(CA_3) = 12 - 18 + 9 - 1 = 2,$$

and we can hope to find 2 relations. They turn out to be

$$\psi^{123} - \psi^{132} + \psi^{213} - \psi^{231} = 0 \tag{4.3}$$

and

$$\psi^{213} - \psi^{231} + \psi^{312} - \psi^{321} = 0. \tag{4.4}$$

Similarly, the polyhedra in figures 6, 7, and 8 prove equation 4.5, 4.6, and 4.7 respectively.

$$\mu^{1234} - \mu^{1243} + \mu^{1423} - \mu^{4123} = \psi_+^{234} - (\Delta \otimes 1 \otimes 1)\psi_+ + (1 \otimes \Delta \otimes 1)\psi_+ - \psi_+^{124} \quad (4.5)$$

$$\mu^{1234} - \mu^{1324} + \mu^{1342} + \mu^{3124} - \mu^{3142} + \mu^{3412} = (1 \otimes 1 \otimes \Delta)\psi_+ - \psi_+^{124} - \psi_+^{123} - (\Delta \otimes 1 \otimes 1)\psi_- + \psi_-^{234} + \psi_-^{134} \quad (4.6)$$

$$\mu^{2345} - (\Delta \otimes 1 \otimes 1 \otimes 1)(\mu) + (1 \otimes \Delta \otimes 1 \otimes 1)(\mu) - (1 \otimes 1 \otimes \Delta \otimes 1)(\mu) + (1 \otimes 1 \otimes 1 \otimes \Delta)(\mu) - \mu^{1234} = 0 \quad (4.7)$$

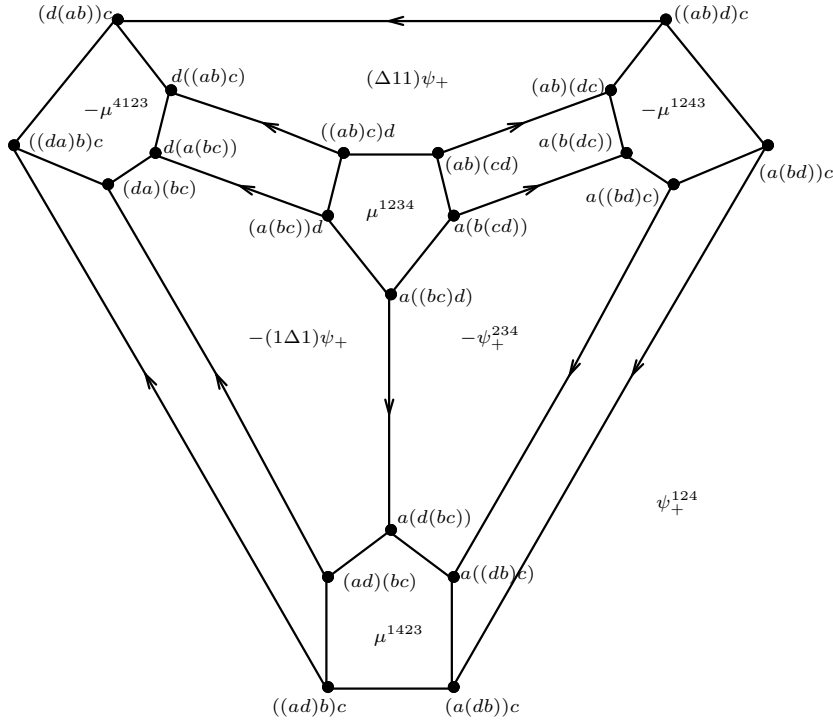

Figure 6. A relation from CA_4

Notice that equation (4.7) simply says that $d\mu = 0$. For simplicity, let's pretend now that only the pentagon has to be solved, and that only equation (4.7) is given. In reality we also need to solve (4.2), and we're also given equations (4.3), (4.4), (4.5), and (4.6). This additional requirement and that additional information makes matters more complicated, but the principles remain the same. Anyway, with our simplifying assumptions, equations (4.1) and (4.7) together mean that we're left with showing that $H^4(\mathcal{A}(n\uparrow)) = 0$.

Without our simplifying assumption we end up needing to show that some easily defined subcomplex of $\mathcal{A}(n\uparrow)$ has vanishing cohomology, $H_{sub}^4(\mathcal{A}(n\uparrow)) = 0$.

There are two possible interpretations for $\mathcal{A}(n\uparrow)$ —

* allowing non-horizontal chords:

In this case it is known that $H_{sub}^4(\mathcal{A}(n\uparrow)) = 0$, but explicit computations are almost impossible.

* allowing only horizontal chords:

In this case explicit computations are easy, but we don't know how to compute $H_{sub}^4(\mathcal{A}(n\uparrow))$. See [Sto1] for a partial result on this problem related to some combinatorial properties of a free resolution of $\mathcal{A}(n\uparrow)$.

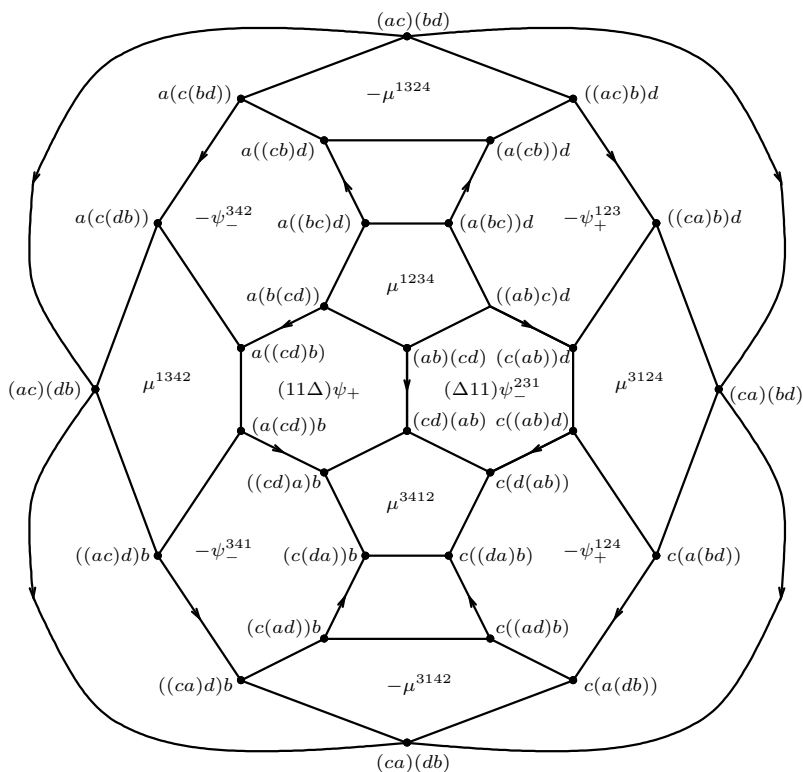

Figure 7. Another relation from CA_4

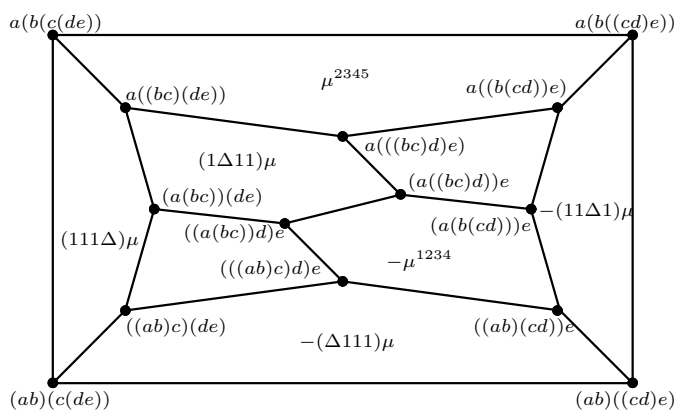

Figure 8. The Stasheff polyhedron — a relation from CA_5

4.5 Why are we not happy?

- Why is it that we can compute $H_{sub}^4(\mathcal{A}(n\uparrow))$ only in the less natural case in which non-horizontal chords are allowed? We know that a horizontal-chord-only Φ does exist; Drinfel'd constructed one using the KZ connection in [Dr1]. But we still don't have a proof of this fact that does not use analysis.
- The algorithm we sketched here finds a pair (R, Φ) . From the considerations in section 4.1 (and from [Dr1]) we know that we should be able to take $R = \exp\left(\frac{1}{2}\uparrow\text{---}\uparrow\right)$. But we don't know how to reproduce this fact algebraically.
- And we still don't know anything about $\mathbf{Z}/3\mathbf{Z}$ and many other rings.

References

- [Ar] V. I. Arnold, *The Cohomology Ring of the Group of Dyed Braids* (Russian), *Mat. Zametki* **5** (1969) 227–231.
- [AS1] S. Axelrod and I. M. Singer, *Chern-Simons Perturbation Theory*, Proc. XXth DGM Conference (New York, 1991) (S. Catto and A. Rocha, eds.) World Scientific, 1992, 3–45.
- [AS2] _____ and _____, *Chern-Simons Perturbation Theory II*, *Jour. Diff. Geom.*, **39** (1994) 173–213.
- [B-N1] D. Bar-Natan, *Perturbative Chern-Simons Theory*, *Jour. of Knot Theory and its Ramifications*, **4-4** (1995) 503–548.
- [B-N2] _____, *Weights of Feynman Diagrams and the Vassiliev Knot Invariants*, February 1991, preprint.
- [B-N3] _____, *Perturbative Aspects of the Chern-Simons Topological Quantum Field Theory*, Ph.D. thesis, Princeton Univ., June 1991, Dep. of Mathematics.
- [B-N4] _____, *On the Vassiliev Knot Invariants*, *Topology* **34** (1995) 423–472.
- [B-N5] _____, *Vassiliev Homotopy String Link Invariants*, *Jour. of Knot Theory and its Ramifications* **4** (1995) 13–32.
- [B-N6] _____, *Non-Associative Tangles*, to appear in the Georgia Inter. Topology Conference proceedings.
- [B-N7] _____, *Vassiliev and Quantum Invariants of Braids*, in Proc. of Symp. in Appl. Math. **51** (1995) *The Interface of Knots and Physics*, (L. H. Kauffman, ed.), Amer. Math. Soc., Providence.
- [Bi] J. S. Birman, *New Points of View in Knot Theory*, *Bull. Amer. Math. Soc.* **28** (1993) 253–287.
- [BL] _____ and X-S. Lin, *Knot Polynomials and Vassiliev's Invariants*, *Invent. Math.* **111** (1993) 225–270.
- [BT] R. Bott and C. Taubes, *On the Self-Linking of Knots*, *Jour. Math. Phys.* **35** (1994) 5247–5287.
- [Ca] P. Cartier, *Construction Combinatoire des Invariants de Vassiliev-Kontsevich des Nœuds*, *C. R. Acad. Sci. Paris* **316** Série I (1993) 1205–1210.
- [Ch] K-T. Chen, *Iterated Path Integrals*, *Bull. Amer. Math. Soc.* **83** (1977) 831–879.
- [DD] M. Domergue and P. Donato, *Integrating a Weight System of Order n to an Invariant of $(n-1)$ -Singular Knots*, *Jour. of Knot Theory and its Ramifications*, to appear.
- [Dr1] V. G. Drinfel'd, *Quasi-Hopf Algebras*, *Leningrad Math. J.* **1** (1990) 1419–1457.
- [Dr2] _____, *On Quasitriangular Quasi-Hopf Algebras and a Group Closely Connected with $\text{Gal}(\bar{\mathbb{Q}}/\mathbb{Q})$* , *Leningrad Math. J.* **2** (1991) 829–860.

- [Go1] M. Goussarov, *A New Form of the Conway-Jones Polynomial of Oriented Links*, in *Topology of Manifolds and Varieties* (O. Viro, editor), Amer. Math. Soc., Providence 1994, 167–172.
- [Go2] ———, *On n -Equivalence of Knots and Invariants of Finite Degree*, in *Topology of Manifolds and Varieties* (O. Viro, editor), Amer. Math. Soc., Providence 1994, 173–192.
- [GMM1] E. Guadagnini, M. Martellini and M. Mintchev, *Perturbative Aspects of the Chern-Simons Field Theory*, Phys. Lett. **B227** (1989) 111.
- [GMM2] ———, ——— and ———, *Chern-Simons Field Theory and Link Invariants*, Nucl. Phys. **B330** (1990) 575.
- [Hu] M. Hutchings, *Integration of Singular Braid Invariants and Graph Cohomology*, Harvard University preprint, May 1995.
- [Ka] C. Kassel, *Quantum Groups*, Springer-Verlag GTM **155**, Heidelberg 1994.
- [Koh] T. Kohno, *Vassiliev Invariants and De-Rham Complex on the Space of Knots*, Contemp. Math. **179** (1994) 123–138.
- [Kon] M. Kontsevich, *Vassiliev's Knot Invariants*, Adv. in Sov. Math., **16(2)** (1993), 137–150.
- [LM] T. Q. T. Le and J. Murakami, *The Universal Vassiliev-Kontsevich Invariant for Framed Oriented Links*, to appear in Compositio Math.
- [Li1] X-S. Lin, *Milnor Link Invariants are All of Finite Type*, Columbia University preprint, 1992.
- [Li2] ———, *Power Series Expansions and Invariants of Links*, to appear in the Georgia Inter. Topology Conference proceedings.
- [Pi] S. Piunikhin, *Combinatorial Expression for Universal Vassiliev Link Invariant*, Commun. Math. Phys. **168-1** 1–22.
- [Sta] T. Stanford, *Finite Type Invariants of Knots, Links, and Graphs*, to appear in Topology.
- [Sto1] A. Stoimenow, *Über Harrison-Kohomologie und die Drinfel'd-Vermutung*, Diplom thesis, Humboldt University Berlin, Sept. 1995. English version to appear in Jour. of Knot Theory and its Ramifications.
- [Sto2] ———, *On the number of chord diagrams*, Humboldt University Berlin preprint, January 1996.
- [Th] D. P. Thurston, *Integral Expressions for the Vassiliev Knot Invariants*, senior thesis, Harvard University 1995.
- [Va1] V. A. Vassiliev, *Cohomology of Knot Spaces*, Theory of Singularities and its Applications (Providence) (V. I. Arnold, ed.), Amer. Math. Soc., Providence, 1990.
- [Va2] ———, *Complements of Discriminants of Smooth Maps: Topology and Applications*, Trans. of Math. Mono. **98**, Amer. Math. Soc., Providence, 1992.
- [Vo] P. Vogel, *Algebraic Structures on Modules of Diagrams*, Université Paris VII preprint, July 1996.
- [Wil] S. Willerton, *A Combinatorial Half-Integration from Weight System to Vassiliev Knot Invariant*, to appear in Jour. of Knot Theory and its Ramifications.
- [Wit] E. Witten, *Quantum Field Theory and the Jones Polynomial*, Commun. Math. Phys. **121** (1989) 351-399.