

## The *BABAR* Muon System Upgrade

W. Menges

Department of Physics, Queen Mary, University of London  
Mile End Road, London, E1 4NS, UK  
(from the *BABAR* Collaboration)

### Abstract

Resistive Plate Chambers (RPCs) were used for the instrumentation of the iron flux return of the *BABAR* detector as a muon system. Unfortunately the efficiency of the original RPCs degraded rapidly with time. Limited Streamer Tubes (LSTs) were chosen for an upgrade of the barrel portion of the detector.

The phased installation started in summer 2004 with replacing two sextants of the *BABAR* barrel muon system with LSTs. The modules for the remaining four sextants are under long-term test at SLAC and ready for installation, expected in 2006. The modules become inaccessible once installed in *BABAR*, so it is critical to select only perfectly working tubes. To accomplish this a strong QC system was established during the prototype phase, and fully implemented throughout pre-production and construction. To spot any damage during transport, the final modules are subjected to comprehensive tests at SLAC immediately after arrival and kept under long-term test till installation into *BABAR*. Details of these tests and results from long-term testing will be discussed. Since spring 2005 the PEP-II accelerator is running and *BABAR* is collecting data. First experience from data taking with the LSTs will be presented and the performance of the detector discussed.

Contributed to the Proceedings of the  
2005 Nuclear Science Symposium and Medical Imaging Conference,  
10/23/2005—10/29/2005, Wyndham El Conquistador Resort, Puerto Rico

---

*Stanford Linear Accelerator Center, Stanford University, Stanford, CA 94309*

Work supported in part by Department of Energy contract DE-AC02-76SF00515.

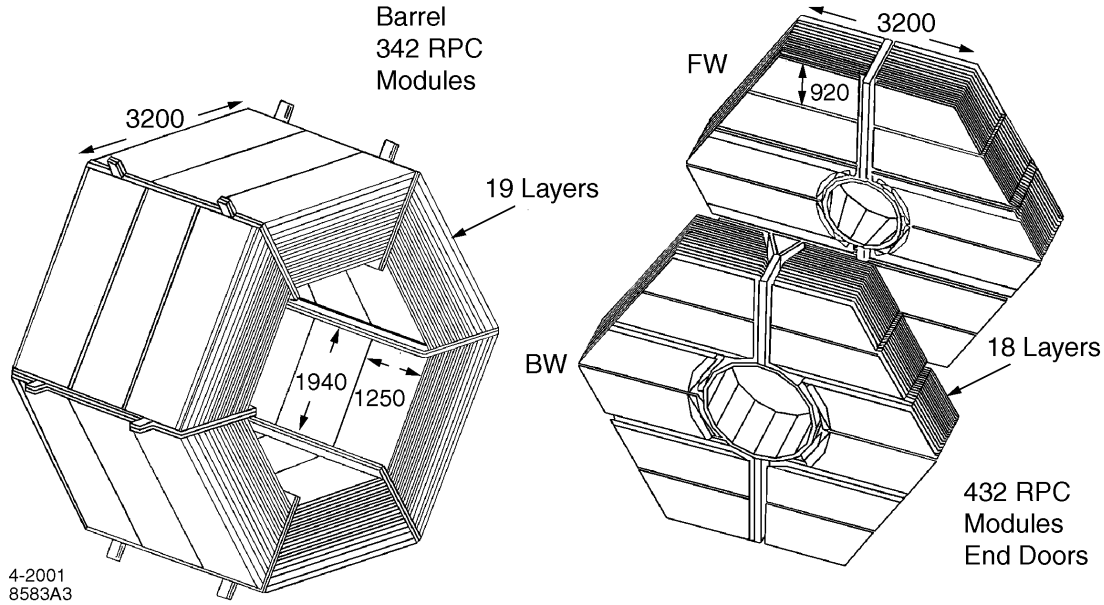

Figure 1: Overview of the IFR: Barrel sectors and forward (FW) and backward (BW) end doors; the shape of the RPC modules and their dimensions are indicated.

## 1 Introduction

Resistive Plate Chambers (RPCs) were used as the initial technology for the Instrumentation of the Flux Return (IFR) of the *BABAR* detector [1] for the identification of muons and  $K_L^0$ . Unfortunately, there were many issues with the production and operation of the RPCs, which led to significant decrease in the per-layer efficiency in the first years. For more details see [2, 3]. The *BABAR* collaboration decided to upgrade the forward system with improved RPCs [4] and to replace the RPCs in the barrel system with Limited Streamer Tubes (LSTs). The research and design phase started in 2002 with the first installation phase in summer 2004 and the second scheduled for autumn 2006.

The geometry of the muon system is shown in Fig. 1. Forward, backward and barrel system are sextant shaped. In the initial layout the barrel system consists of 19 layers, all equipped with RPCs. Layer 19 is not accessible and no LSTs will be installed there. The inner 18 layers will be used for the LSTs installation. To compensate for the loss of absorbing material between layers 18 and 19, brass will be installed in 6 layers. The optimal location is every second layer starting with layer 5. The remaining 12 layer will be filled with LSTs.

## 2 Detector Components

The physical principle of LSTs is quite simple. Each gas-filled cell has a single wire at High Voltage (HV). If a charged particle passed through the cell, the gas is ionised and a streamer builds up, which can be readout from the wire. Simultaneously a signal will be induced on a plane, which is mounted below the tube. The charge on the wire is used as the  $\phi$  coordinate and the induced charge on the plane is detected using strips perpendicular to the wire direction, giving a z-coordinate. The r-coordinate is taken from the layer information. Together this gives a 3d information of the hit.

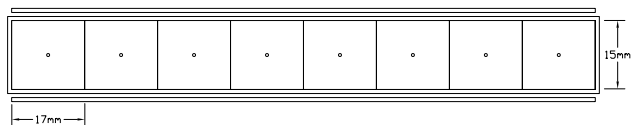

(a) Sketch.

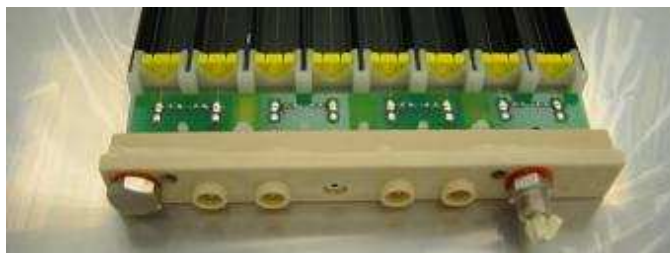

(b) Endcap with HV and gas connectors.

Figure 2: The cross section (a) and the HV endcap (b) of a tube is shown.

Therefore the basic components are limited streamer tubes and z-planes. Other components are a gas and HV system and the readout electronics.

## 2.1 Limited Streamer Tubes

The cross section of a tube is shown in Fig. reffig:tube:sketch. It consists of 7 or 8 cells. Each cell is 17 mm wide, 15 mm high and 380 mm long. In the middle of each cell, a gold-plated anode wire is clamped. Six wire holders are equally distributed over the length of a cell to prevent the wire from sagging and touching the PVC walls, which are painted with a water-based graphite paint and kept at ground potential. Both endcaps are equipped with gas connections. One endcap also hosts the HV connectors (Fig. 2(b)). Two wires are bundled into one HV channel. The streamer signal is readout via a capacitor on the HV connection.

## 2.2 Quality Control of LSTs

The experiences with the RPCs showed that a strict quality control at all production stages is essential to ensure excellent performance of the detector. An extensive list of quality control procedures was established during the prototype phase and fully implemented throughout the production phase.

The tubes were produced in Italy by Pol.Hi.Tech and then shipped to the US. At Princeton University and Ohio State University they were assembled into larger units and finally shipped to SLAC.

After production and before their final assembly into units each cell of a tube is scanned with a radioactive source. For a good tube the current is below  $1 \mu A$ , with six dips in the current, where the positions correspond to the wire holders. A typical failure is the occurrence of a continuous

discharge, where the current increases by at least  $1\ \mu\text{A}$ . In some cases the discharge is self sustained and does not stop when the source is removed from the cell. Tubes failing this test are opened in a clean room, cleaned up and assembled again. If they fail the source scan after a repair, the tube will be rejected. Failure modes are flakes of graphite paint in the cell or impurities on the wire.

After transportation the tubes are visually checked for mechanical defects and tested for transportation damage by measuring the resistance and capacitance of each HV channel. All tubes are tested for gas leaks, where a half life time of a few hours is necessary. Tubes which failed this test are manually searched for leaks and usually repaired with Epoxy.

Each tube is HV conditioned after each production stage and after arriving at SLAC. The HV is increased in steps of 200 V from 4900 V to 5900 V. A step is successfully completed when the current of the tube is below 200 nA for at least 2 minutes. At 5900 V the current limit is increased to 500 nA and the time limit to 10 minutes. For the final burn-in process the voltage is raised to 6000 V with the same current and time limit as at 5900 V. Afterwards the tube is kept at 5900 V for at least 10 hours. Fig. 3 shows for two different tubes the applied voltage and measured currents during the HV conditioning process. Fig. 3(a) shows the behaviour of an excellent tube. The current increased only minimally with voltage increase and the current is stable and  $\sim 100\ \text{nA}$  for the long-term part of the process. Fig. 3(b) shows the burn-in process. The current increases significant for the two highest voltage steps, and then decreases slowly over time. After 10 hours the current is stable and below 100 nA as in the case of an excellent tube. As long as the tube is kept on gas this behaviour will not change. The HV conditioning is repeated if the tube fails the process at any HV step. If a tube still fails the procedure after a few tries, it is rejected. Usually failed tubes develop a self-sustained discharge with a current well above  $1\ \mu\text{A}$ .

Finally the quality of each HV channel is checked by taking so called single rates. This is the counting rate of cosmic muons as a function of the HV. The HV is varied from 4900 V to 5900 V in steps of 100 V with a counting time of 100 seconds. Fig. 4 shows an example of the single rates for a good tube. The counting rate starts quite low and then increases exponentially around 5000 V. At 5100 – 5200 V the counting rate reaches a plateau, which should be at least a few 100 V. In the case of an excellent tube the plateau can go up to 5900 V. A long and flat plateau is characteristic of a good tube.

At the moment, the remaining  $\sim 1300$  tubes for the second installation phase are under long-term testing at SLAC. They are kept under gas flow and at the operating HV of 5500 V. If the current of a tube stays for 3 minutes above 500 nA, the HV is automatically ramped down to 0 V. The number of trips is recorded for later use in the final selection process and tubes exhibiting a continuous self-sustained discharge are disconnected from HV and rejected.

## 2.3 Z-Planes

The z-planes are 4 m long and up to 3.8 m wide, depending on the layer in the IFR. A plane consists of 96 copper strips, 35 mm wide with a spacing of 2 mm. They are glued on a copper ground plate, separated by Mylar. The complete plane is vacuum laminated with a Mylar foil. The readout of 16 strips is grouped together into one flat cable, where the strip and the cable are connected by a solder joint.

The design of the z-planes is very robust, nevertheless the planes have to be tested to ensure their proper functioning. In addition careful monitoring during installation is essential, when the planes may come under mechanical stress, in order to carry out repairs before the z-planes are inaccessible. For monitoring the capacitance between ground and each readout channel is measured. It should be around  $\sim 5\ \text{nF}$ . Very small or zero capacitance is a clear indication of a broken solder joint.

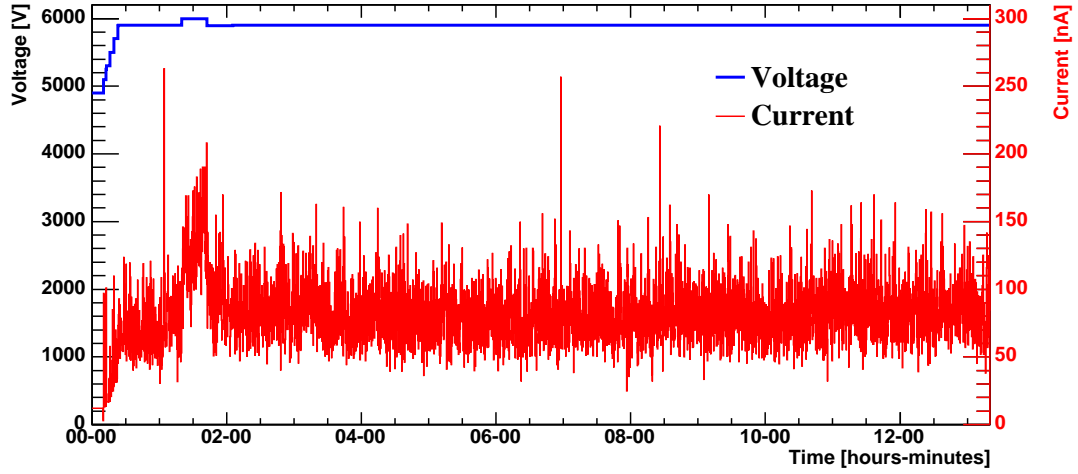

(a) Excellent tube.

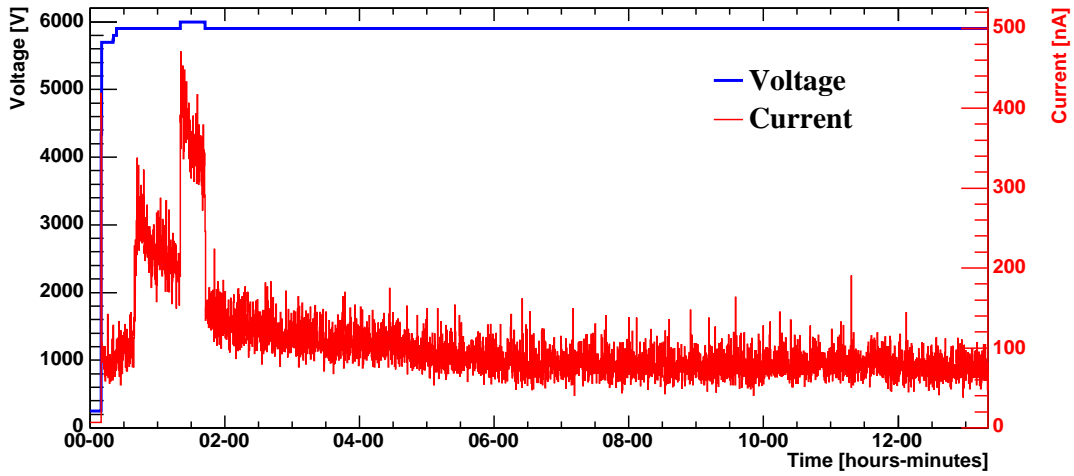

(b) Good tube after HV conditioning.

Figure 3: For the HV conditioning process the voltage (blue) and the current (red) is shown as a function of time.

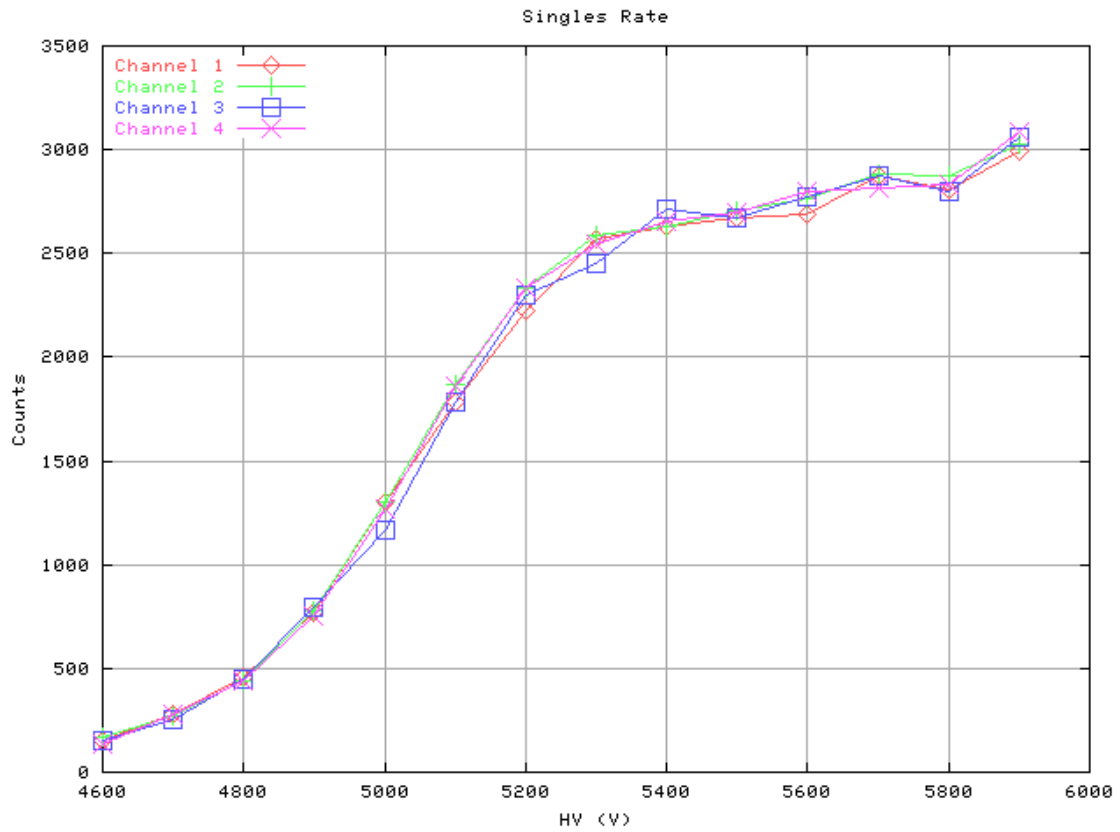

Figure 4: The counting rate using cosmic muons as a function of the HV is shown for the four signal channels in one tube.

Only a few broken solder joints have been found and most of them have been repaired well before installation or while installing them.

## 2.4 Gas System

The gas used for the tubes is a (89:3:8) mixture of CO<sub>2</sub>, Argon and iso-butane. It is non flammable and has good quenching properties. The gas mixing system is custom built. The mixing unit uses standard technology and is based on mass flow controllers.

Half of the tubes per layer are connected in sequence to one gas line. The gas flow is monitored at the outlet with digital bubblers[5]. The total flow rate of the system is 2.5l/min, which correspond to  $\sim 1$  volume changes per day.

## 2.5 High Voltage System

The requirements of the HV system is high granularity and easy accessibility. The segmentation of the system should be so good that a single readout channel of a tube can be removed from the supply so that the rest of the tube can be operated without any problems. On the other hand, HV control of a whole layer and current monitoring of a single tube is sufficient.

The design of the HV power supplies was guided by these requirements. They are custom built [6] and can operate between 0 and 6000 V. Each supply consists of 80 HV channels in four independent HV groups. The current monitoring, current limits and trip times are on a channel by channel basis. Each channel is equipped with a hardwired over-current protection circuit based on a design from the ZEUS muon system. Starting around  $3\mu A$  the effective voltage is lowered, depending on the drawn current.

Each HV channel is split into four pins allowing access to a quarter of a tube. If a readout channel of a tube evolves a recurring problem over a long period of time, this channel can be easily removed from the HV supply and the other three quarters of the tube can be operated without any problems.

The HV cables are built from multi-conductor Kerpen cable and consist of two parts connected with a custom-inline connector: a short-haul cable mounted on the tube and a long-haul cable going from the detector to the power supplies.

## 2.6 Front End Electronics

The front end electronics were specially developed for the needs of the LSTs. They interface to the existing RPC-FIFO and are then read out into the standard *BABAR*DAQ system. On each motherboard four daughter boards can be installed. The signal from the wires and the strips are different in polarity and shape and this difference is taken care of on the daughter board level. Common features are implemented on the motherboard. A daughter board has 16 analog input channels. The signals are amplified, discriminated with an adjustable threshold and converted to 1-bit digital hit signals. No other information is kept, e. g. timing, charge and other shaping information are not passed on to the DAQ system.

The crates with the front end electronics are located in the near vicinity of the *BABAR* detector inside the shielding wall. They are not mounted directly on the detector to give better accessibility.

### 3 First Installation Phase

The first installation phase was scheduled for August to October 2004. The RPCs from the inner 18 layers of the top and bottom sextant were removed. In 12 of the 18 layers z-planes and LSTs were installed. In the remaining 6 layers brass was installed to increase the total absorption length and compensate for the loss in absorption length between the 18th and 19th layer. In total 24 z-planes for a total of 2284 z strips and 388 tubes were installed, which results in 1522  $\phi$  readout channels. 188 HV cables were used and connected to 6 power supplies. One additional power supply was installed in the case it is needed for problematic tubes which need to be isolated. 332 signal cables were used and connected to 84 FEC boards.

### 4 Second Installation Phase

The second installation phase is scheduled for autumn 2006. The remaining 4 sextants of RPCs will be replaced with LSTs. This will be 776 tubes and 48 z-planes. Additionally, 14 HV power supplies and 168 FEC cards will be installed.

### 5 Operations

The LSTs have been maintained at the operational voltage of 5500 V since October 2004. After an extended shutdown, *BABAR* resumed data taking in March 2005 and collected until October 2005  $\sim 60 \text{ fb}^{-1}$  of  $e^+e^-$  collisions at the  $\Upsilon(4S)$  resonance. This dataset will be increased to  $\sim 250 \text{ fb}^{-1}$  by summer 2006, when the next shutdown and the second installation phase is scheduled. This dataset will be the same size as the one collected from the begin of *BABAR* up to summer 2004 but with two sextants of excellent working muon detectors.

The occupancy of each wire channel is constantly monitored online during data taking. The plateau of each cell is measured every month and all channels have a good plateau except for 5 channels. These channels trip often. The problems are diagnosed to be located between the power supplies and the cell wires. They are isolated in the extra HV supply. At the moment they are operated a few 100 V below the nominal operation voltage. In summary more than 99.6% of all channels are working perfectly with no decrease over time visible.

The z strip occupancy is also monitored online. All channels except 5 give good readings. These dead channels have been tracked down to broken solder joints and the number is constant over the time. In summary more than 99.7% of all channels are working perfectly.

The effect of these dead or not properly working channels on the physics performance is expected to be negligible because of the high granularity in wires, strips and layers.

For every run the efficiency per layer is determined from a radiative di-muon sample. The average efficiency is above 90%, consistent with the geometrical acceptance of the LST. The efficiency is constant over time.

Fig. 5 shows the pion rejection rate as a function of the muon efficiency for high energy muons ( $2 \text{ GeV} < p < 4 \text{ GeV}$ ) using a neural network based muon selection algorithm for the years 2000, 2004 and 2005. The year 2005 data is split up into LSTs and RPCs. The decrease in muon efficiency and pion rejection from 2000 to 2005 is clearly visible. In 2005 the maximal muon efficiency using RPCs is 88% with poor pion rejection compared to almost 94% muon efficiency with moderate pion rejection in 2000. With the LSTs the overall performance is even better than the initial performance of the RPCs in the first year of operation (2000). For a fixed muon efficiency, the LSTs always give



a higher pion rejection rate. The muon efficiency can reach almost 94% with a moderate pion fake rate. This is a very clear indication of the success of the muon system upgrade with LSTs.

## 6 Conclusion

The summer 2004 installation was very successful. Almost 100% of the  $\phi$ -readout and z-readout channels are working. The efficiency per layer is consistent with the geometrical acceptance. This excellent per-layer efficiency translates into an excellent muon selection efficiency of up to 94% with a moderate pion fake rate. The overall performance with LSTs is even better than the initial performance of the RPCs. This excellent performance is due to the stringent quality control of all detector components at all production stages.

## The *BABAR*-LST Group

The following institutes form the *BABAR*-LST group: Università di Ferrara and INFN, Laboratori Nazionali di Frascati dell'INFN, Università di Genova and INFN, Lawrence Livermore National Laboratory, Massachusetts Institute of Technology, Ohio State University, Università di Padova and INFN, Università di Perugia and INFN, Queen Mary, University of London, Princeton University, University of British Columbia, University of California at Santa Babara, University of Colorado, Colorado State University, Università di Torino and INFN, University of Oregon, Università di Roma La Sapienza and INFN, University of California at San Diego, and Stanford Linear Accelerator Center.

## Acknowledgment

The authors would like to thank the Stanford Linear Accelerator Center and the *BABAR*-LST group for the kind hospitality. This work is supported by the US Department of Energy, the Istituto Nazionale di Fisica Nucleare (Italy), and the Particle Physics and Astronomy Research Council (United Kingdom).

## References

- [1] B. Aubert *et al.* [*BABAR* Collaboration], Nucl. Instrum. Meth. A **479**, 1 (2002) [arXiv:hep-ex/0105044].
- [2] D. Piccolo *et al.*, Nucl. Instrum. Meth. A **515**, 322 (2003).
- [3] F. Anulli *et al.*, Nucl. Instrum. Meth. A **508**, 128 (2003).
- [4] F. Anulli *et al.*, Nucl. Instrum. Meth. A **539**, 155 (2005).
- [5] S. Foulkes *et al.*, Nucl. Instrum. Meth. A **538**, 801 (2005).
- [6] G. Benelli *et al.* "The *BABAR*LST Detector High Voltage System: Design and Implementation," these proceedings.

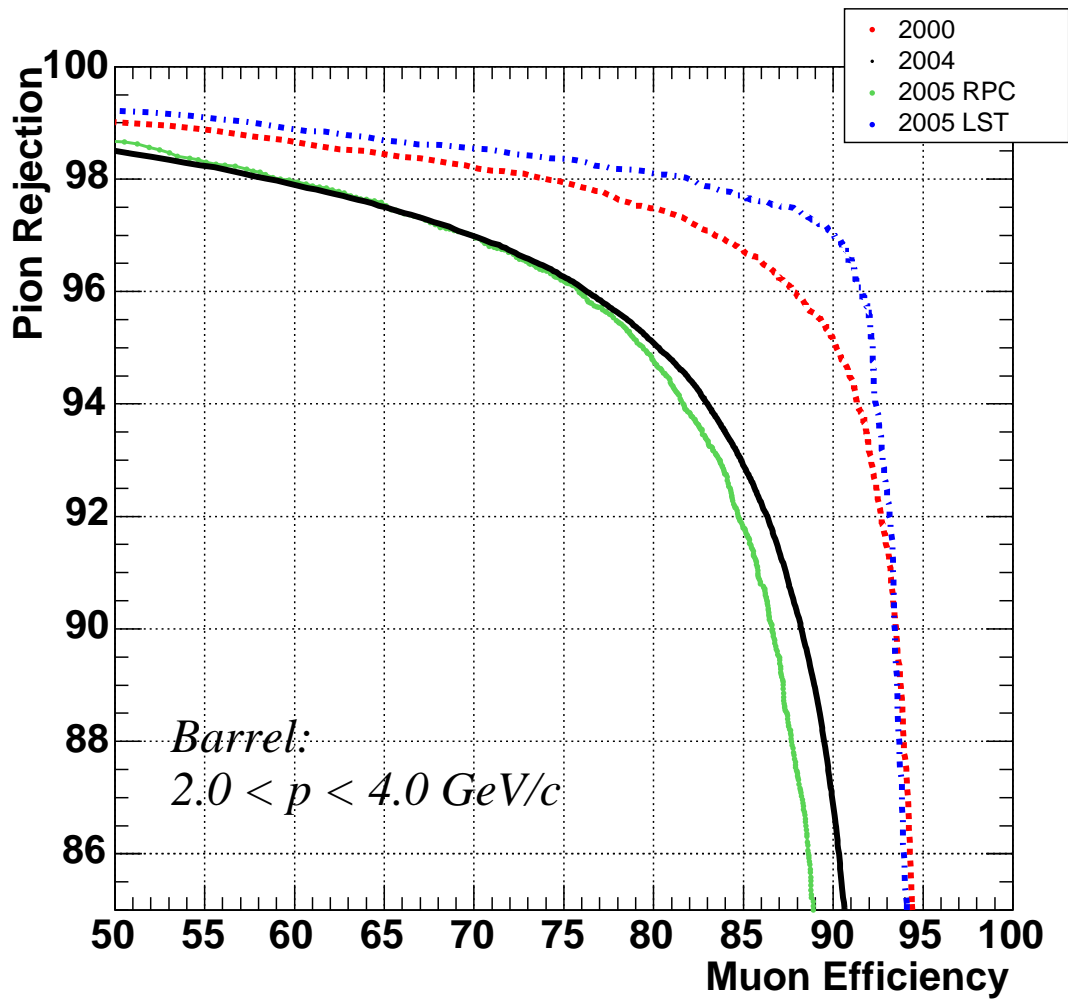

Figure 5: The pion rejection rate as a function of the muon efficiency is shown using a muon selector based on a neural network for high energy muon. The data for the RPCs in the years 2000, 2004 and 2005 is plotted in red, black and green, respectively. The data for the LSTs in the year 2005 is shown in blue.