

# Quandle Homology Groups, Their Betti Numbers, and Virtual Knots

J. Scott Carter  
 University of South Alabama  
 Mobile, AL 36688  
 carter@mathstat.usouthal.edu

Daniel Jelsovsky  
 University of South Florida  
 Tampa, FL 33620  
 jelsovsk@math.usf.edu

Seiichi Kamada  
 Osaka City University  
 Osaka 558-8585, JAPAN  
 kamada@sci.osaka-cu.ac.jp  
 skamada@mathstat.usouthal.edu

Masahico Saito  
 University of South Florida  
 Tampa, FL 33620  
 saito@math.usf.edu

April 10, 2018

## Abstract

Lower bounds of betti numbers for homology groups of racks and quandles will be given using the quotient homomorphism to the orbit quandles. Exact sequences relating various types of homology groups are analyzed. Geometric methods of proving non-triviality of cohomology groups are also given, using virtual knots. The results can be applied to knot theory as the first step towards evaluationg the state-sum invariants defined from quandle cohomology.

## 1 Introduction

In [2], the authors and L. Langford introduced a notion of cohomology groups of a quandle to define a state-sum invariant (the CJKLS invariant) of knotted curves and knotted surfaces. A similar notion for racks had been defined by R. Fenn, C. Rourke and B. Sanderson [5]. One of the purposes of this paper is to relate these two homology theories. To this end, we will define a short exact sequence of chain complexes associated with a quandle and define three kinds of homology (and cohomology) groups of the quandle. A second purpose is to give a lower bound on the Betti numbers of the three kinds of homology groups. This helps us to determine non-triviality of the homology groups of a quandle. The lower bound is valid also for a rack if the homology is in the sense of [5]. In this case, the methods generalize an idea of Greene [9] called orbit-writhe. A third purpose is to illustrate geometric techniques that use the CJKLS invariants and generalize some of Greene's methods. These techniques will also demonstrate that large classes of quandles have non-trivial homology. Since one needs non-trivial cocycles to define the CJKLS invariants, non-triviality of (co)homology groups provides the first step towards obtaining the invariants.

We thank Dan Silver for some useful comments.

## 2 Basic Notions

A *quandle*,  $X$ , is a set with a binary operation  $*$  such that

(I. IDEMPOTENCY) for any  $a \in X$ ,  $a * a = a$ ,

(II. RIGHT-INVERTIBILITY) for any  $a, b \in X$ , there is a unique  $c \in X$  such that  $a = c * b$ , and

(III. SELF-DISTRIBUTIVITY) for any  $a, b, c \in X$ , we have  $(a * b) * c = (a * c) * (b * c)$ , cf. [10].

A *rack* is a set with a binary operation that satisfies (II) and (III), cf. [4]. A similar notion is known as an *automorphic set*, cf. [1].

**2.1 Examples of quandles.** Any set  $X$  with the operation  $x * y = x$  for any  $x, y \in X$  is a quandle called the *trivial* quandle. The trivial quandle of  $n$  elements is denoted by  $T_n$ .

Any group is a quandle by conjugation as operation. Any subset that is closed under conjugation is also a quandle. For example, the set,  $QS(5)$ , of non-identity elements of the permutation group on 3 letters is a quandle.

Let  $n$  be a positive integer. For elements  $i, j \in \{0, 1, \dots, n-1\}$ , define  $i * j = 2j - i$  where the sum on the right is reduced mod  $n$ . Then  $*$  defines a quandle structure called the *dihedral quandle*,  $R_n$ . This set can be identified with the set of reflections of a regular  $n$ -gon with conjugation as the quandle operation.

Any  $\Lambda = \mathbf{Z}[T, T^{-1}]$ -module  $M$  is a quandle with  $a * b = Ta + (1 - T)b$ ,  $a, b \in M$ , called an *Alexander quandle*. Furthermore for a positive integer  $n$ , a *mod- $n$  Alexander quandle*  $\mathbf{Z}_n[T, T^{-1}]/(h(T))$  is a quandle for a Laurent polynomial  $h(T)$ . The mod- $n$  Alexander quandle is finite if the coefficients of the highest and lowest degree terms of  $h$  are  $\pm 1$ .

See [1], [4], [10], or [12] for further examples.

**2.2 Homomorphisms and orbits.** A function  $f : X \rightarrow Y$  between quandles or racks is a *homomorphism* if  $f(a * b) = f(a) * f(b)$ . Given a quandle homomorphism,  $f$ , define for  $x \in X$ ,

$$E_x = [x] = \{y \in X | f(x) = f(y)\} = f^{-1}(f(x)).$$

The set  $E_x$  is called the *equalizer* of  $x$ ; it is a subquandle of  $X$ . The equalizers form a partition or equivalence relation  $\equiv$  on  $X$ . Clearly,  $X/\equiv$  is a quandle isomorphic to the image of  $f$ . If  $f$  is surjective, then the quandle  $Y$  is said to be a *quotient quandle*.

Let  $X$  denote a quandle. From Axiom II, each element  $b \in X$  defines a bijection  $S(b) : X \rightarrow X$  with  $aS(b) = a * b$ . The bijection is an automorphism by Axiom III. For a word  $w = b_1^{\epsilon_1} \dots b_n^{\epsilon_n}$  where  $b_1, \dots, b_n \in X; \epsilon_1, \dots, \epsilon_n \in \{\pm 1\}$ , we define  $a * w = aS(w)$  by  $aS(b_1)^{\epsilon_1} \dots S(b_n)^{\epsilon_n}$ . An automorphism of  $X$  is called an *inner-automorphism* of  $X$  if it is  $S(w)$  for a word  $w$ . (The notation  $S(b)$  follows Joyce's paper [10] and  $a * w (= a^w)$  follows Fenn-Rourke [4].)

We define a relation on  $X$  by  $a \sim b$  if  $a$  is mapped to  $b$  by an inner-automorphism of  $X$ . The relation  $\sim$  is an equivalence relation. The *orbit* of  $a \in X$  is the equivalence class of  $a$ , which is denoted by  $\text{Orb}(a)$ . The set of equivalence classes of  $X$  by  $\sim$  is denoted by  $\text{Orb}(X)$ .

When we regard  $\text{Orb}(X)$  as a trivial quandle, the projection map  $\pi : X \rightarrow \text{Orb}(X)$  is a quandle homomorphism. In this case,  $\text{Orb}(X)$  is called the *orbit quandle* of  $X$ .

For  $a \in X$ , the *weak orbit* [10] of  $a$  is  $\{f(a) | f \text{ is an automorphism of } X\}$ . The orbit of  $a$  is  $\{f(a) | f \text{ is an inner-automorphism of } X\}$ . A quandle is *weakly homogeneous* [10] if it has only one weak orbit. A quandle is *homogeneous* if it has only one orbit. A quandle homomorphism  $f : X \rightarrow Y$  is said to be *locally-homogeneous* if each equalizer,  $E_a$  is a homogenous quandle.

**2.3 Lemma.** *Let  $h : X \rightarrow Y$  be a homomorphism.*

(1) *If  $a, b \in X$  are in the same orbit, then  $E_a$  and  $E_b$  are isomorphic.*

(2) *If  $h$  is surjective and  $Y$  is homogeneous, then for any  $a, b \in X$  the subquandles  $E_a$  and  $E_b$  are isomorphic.*

*Proof.* We prove (2); a similar argument gives (1). Let  $a, b \in X$ , let  $x = f(a)$  and  $y = f(b)$ . Since  $Y$  is homogeneous there is a word,  $w$ , in the free group on  $Y$  such that  $x = y * w$ . Say  $w = y_1^{\epsilon_1} \cdots y_n^{\epsilon_n}$ . Choose preimages  $x_i$  for each of the  $y_i$ , and define a word  $v = x_1^{\epsilon_1} \cdots x_n^{\epsilon_n}$  in the free group on  $X$ . Then the inner automorphism  $x \mapsto x * v$  defined on  $X$  when restricted to  $E_a$  is an isomorphism onto  $E_b$ .  $\square$

### 3 Homology and Cohomology

Let  $C_n^R(X)$  be the free abelian group generated by  $n$ -tuples  $(x_1, \dots, x_n)$  of elements of a rack/quandle  $X$ . Define a homomorphism  $\partial_n : C_n^R(X) \rightarrow C_{n-1}^R(X)$  by

$$\begin{aligned} \partial_n(x_1, x_2, \dots, x_n) &= \sum_{i=2}^n (-1)^i [(x_1, x_2, \dots, x_{i-1}, x_{i+1}, \dots, x_n) \\ &\quad - (x_1 * x_i, x_2 * x_i, \dots, x_{i-1} * x_i, x_{i+1}, \dots, x_n)] \end{aligned} \quad (1)$$

for  $n \geq 2$  and  $\partial_n = 0$  for  $n \leq 1$ . Then  $C_*^R(X) = \{C_n^R(X), \partial_n\}$  is a chain complex.

Let  $C_n^D(X)$  be the subset of  $C_n^R(X)$  generated by  $n$ -tuples  $(x_1, \dots, x_n)$  with  $x_i = x_{i+1}$  for some  $i \in \{1, \dots, n-1\}$  if  $n \geq 2$ ; otherwise let  $C_n^D(X) = 0$ . If  $X$  is a quandle, then  $\partial_n(C_n^D(X)) \subset C_{n-1}^D(X)$  and  $C_*^D(X) = \{C_n^D(X), \partial_n\}$  is a sub-complex of  $C_*^R(X)$ . Put  $C_n^Q(X) = C_n^R(X)/C_n^D(X)$  and  $C_*^Q(X) = \{C_n^Q(X), \partial'_n\}$ , where  $\partial'_n$  is the induced homomorphism. Henceforth, all boundary maps will be denoted by  $\partial_n$ .

For an abelian group  $G$ , define the chain and cochain complexes

$$C_*^W(X; G) = C_*^W(X) \otimes G, \quad \partial = \partial \otimes \text{id}; \quad (2)$$

$$C_W^*(X; G) = \text{Hom}(C_*^W(X), G), \quad \delta = \text{Hom}(\partial, \text{id}) \quad (3)$$

in the usual way, where  $W = R$  if  $X$  is a rack, or one of  $D, R, Q$  if  $X$  is a quandle.

**3.1 Definition.** The  $n$ th rack homology group and the  $n$ th rack cohomology group [5] of a rack/quandle  $X$  with coefficient group  $G$  are

$$H_n^R(X; G) = H_n(C_*^R(X; G)), \quad H_R^n(X; G) = H^n(C_R^*(X; G)). \quad (4)$$

The  $n$ th *degeneration homology group* and the  $n$ th *degeneration cohomology group* of a quandle  $X$  with coefficient group  $G$  are

$$H_n^D(X; G) = H_n(C_*^D(X; G)), \quad H_D^n(X; G) = H^n(C_D^*(X; G)). \quad (5)$$

The  $n$ th *quandle homology group* and the  $n$ th *quandle cohomology group* [2] of a quandle  $X$  with coefficient group  $G$  are

$$H_n^Q(X; A) = H_n(C_*^Q(X; G)), \quad H_Q^n(X; A) = H^n(C_Q^*(X; G)). \quad (6)$$

The homology group of a rack in the sense of [5] is  $H_n^R(X; G)$  and the cohomology of a quandle used in [2] is  $H_Q^n(X; A)$ . Refer to [5], [6], [8], [9] for some calculations and applications of the rack homology groups, and to [2], [3] for those of quandle cohomology groups.

The cycle and boundary groups (resp. cocycle and coboundary groups) are denoted by  $Z_n^W(X; G)$  and  $B_n^W(X; G)$  (resp.  $Z_W^n(X; G)$  and  $B_W^n(X; G)$ ), so that

$$H_n^W(X; G) = Z_n^W(X; G)/B_n^W(X; G), \quad H_W^n(X; G) = Z_W^n(X; G)/B_W^n(X; G)$$

where  $W$  is one of  $D, R, Q$ . We will omit the coefficient group  $G$  if  $G = \mathbf{Z}$  as usual. We denote by  $\beta_n^W(X)$  the *Betti numbers* of  $X$  determined by the homology group  $H_n^W(X)$ .

**3.2 Lemma.** *If  $X = X_m$  is a finite rack of  $m$  elements, then the ranks of the free abelian groups  $C_n^D(X)$ ,  $C_n^R(X)$ ,  $C_n^Q(X)$  are given by*

$$\text{rank}C_n^D(X_m) = a_n, \quad \text{rank}C_n^R(X_m) = m^n, \quad \text{rank}C_n^Q(X_m) = b_n, \quad (7)$$

where  $a_n + b_n = m^n$  and  $b_n = m(m-1)^{n-1}$  for  $n \geq 1$ .

*Proof.* We prove that

$$a_1 = 0, \quad a_n = (m-1)a_{n-1} + m^{n-1} \quad (n \geq 2), \quad (8)$$

by induction on  $n$ . By definition,  $C_1^D(X) = 0$  and  $a_1 = 0$ . The number of  $n$ -tuples  $(x_1, \dots, x_n)$  with  $x_{n-1} = x_n$  is  $m^{n-1}$ . By induction hypothesis, the number of  $(n-1)$ -tuples  $(x_1, \dots, x_{n-1})$  with  $x_i = x_{i+1}$  for some  $i$  is  $a_{n-1}$ . So the number of  $n$ -tuples  $(x_1, \dots, x_n)$  such that  $x_i = x_{i+1}$  for some  $i$  and  $x_{n-1} \neq x_n$  is  $a_{n-1} \times (m-1)$ . Thus we have  $a_n = (m-1)a_{n-1} + m^{n-1}$  for  $n \geq 2$ . By definition we have  $b_n = m^n - a_n$  and hence

$$b_1 = m, \quad b_n = (m-1)b_{n-1} \quad (n \geq 2). \quad (9)$$

Solving this recursion, we have  $b_n = m(m-1)^{n-1}$  for  $n \geq 1$ .  $\square$

For example,

$$\text{rank}C_n^D(X_2) = 2^n - 2, \quad \text{rank}C_n^R(X_2) = 2^n, \quad \text{rank}C_n^Q(X_2) = 2. \quad (10)$$

Thus, in general, calculation of the quandle homology of a finite quandle is easier than calculation of the rack homology if one calculates them directly from the definition.

Let  $f : X \rightarrow Y$  be a rack homomorphism. It induces a chain map  $f_\# : C_*^W(X) \rightarrow C_*^W(Y)$  in the natural way, and homomorphisms  $f_* : H_n^W(X; G) \rightarrow H_n^W(Y; G)$  and  $f^* : H_W^n(Y; G) \rightarrow H_W^n(X; G)$ , where  $W = R$  if  $X, Y$  are racks, or one of  $D, R, Q$  if  $X, Y$  are quandles. They are called the *homomorphisms induced from  $f$* .

**3.3 Proposition (Basic Homology Long Exact Sequence).** *If  $X$  is a quandle, there is a long exact sequence*

$$\dots \xrightarrow{\partial_*} H_n^D(X; G) \xrightarrow{i_*} H_n^R(X; G) \xrightarrow{j_*} H_n^Q(X; G) \xrightarrow{\partial_*} H_{n-1}^D(X; G) \rightarrow \dots \quad (11)$$

*which is natural with respect to homomorphisms induced from quandle homomorphisms.*

*Proof.* For each  $n$  the following short exact sequence is split.

$$0 \rightarrow C_n^D(X) \xrightarrow{i} C_n^R(X) \xrightarrow{j} C_n^Q(X) \rightarrow 0. \quad (12)$$

So we have an exact sequence of chain complexes

$$0 \rightarrow C_*^D(X) \otimes G \xrightarrow{i} C_*^R(X) \otimes G \xrightarrow{j} C_*^Q(X) \otimes G \rightarrow 0 \quad (13)$$

that induces the long exact sequence on homology.  $\square$

**3.4 Proposition (Universal Coefficient Theorem).** *There exist split exact sequences*

$$0 \rightarrow H_n^W(X) \otimes G \rightarrow H_n^W(X; G) \rightarrow \text{Tor}(H_{n-1}^W(X), G) \rightarrow 0 \quad (14)$$

$$0 \rightarrow \text{Ext}(H_{n-1}^W(X), G) \rightarrow H_n^W(X; G) \rightarrow \text{Hom}(H_n^W(X), G) \rightarrow 0, \quad (15)$$

*where  $W = R$  if  $X$  is a rack, or one of  $D, R, Q$  if  $X$  is a quandle.*

*Proof.* Since  $\{C_n^W(X)\}$  is a chain complex of free abelian groups, we have the result.  $\square$

By the universal coefficient theorem, it is sufficient to know the homology groups with integer coefficients. So we will investigate the basic homology long exact sequence with  $G = \mathbf{Z}$ .

**3.5 Example.** (1) Let  $R_3$  be the dihedral quandle of three elements. By a direct calculation from the definition, we have

$$H_1^Q(R_3) = \mathbf{Z}, \quad H_2^Q(R_3) = 0. \quad (16)$$

Thus we have that

$$H_2^Q(R_3; G) = 0, \quad H_Q^2(R_3; G) = 0 \quad (17)$$

for any coefficient group  $G$ .

(2) Let  $R_4$  be the dihedral quandle of four elements. By a direct calculation from the definition, we have

$$H_1^Q(R_4) = \mathbf{Z}^2, \quad H_2^Q(R_4) = \mathbf{Z}^2 \oplus (\mathbf{Z}_2)^2. \quad (18)$$

Thus we have that

$$H_2^Q(R_4; \mathbf{Z}_2) = (\mathbf{Z}_2)^4, \quad H_Q^2(R_4; \mathbf{Z}_2) = (\mathbf{Z}_2)^4 \quad (19)$$

and

$$H_2^Q(R_4; \mathbf{Z}_m) = (\mathbf{Z}_m)^2, \quad H_Q^2(R_4; \mathbf{Z}_m) = (\mathbf{Z}_m)^2 \quad (20)$$

for any positive odd integer  $m$ .

**3.6 Trivial quandle.** Let  $T_m$  be the trivial quandle with  $m$  ( $< \infty$ ) elements. Since  $\partial_n : C_n^{\mathbf{R}}(T_m) \rightarrow C_{n-1}^{\mathbf{R}}(T_m)$  is the 0-map, the boundary operators  $\partial_*$  in the basic homology long exact sequence (with  $G = \mathbf{Z}$ ) are 0-maps and it is decomposed into the short exact sequences

$$0 \rightarrow H_n^{\mathbf{D}}(T_m) \rightarrow H_n^{\mathbf{R}}(T_m) \rightarrow H_n^{\mathbf{Q}}(T_m) \rightarrow 0, \quad (21)$$

which are identified with the short exact sequences

$$0 \rightarrow C_n^{\mathbf{D}}(T_m) \rightarrow C_n^{\mathbf{R}}(T_m) \rightarrow C_n^{\mathbf{Q}}(T_m) \rightarrow 0. \quad (22)$$

In particular, we have

$$\beta_n^{\mathbf{D}}(T_m) = a_n, \quad \beta_n^{\mathbf{R}}(T_m) = m^n, \quad \beta_n^{\mathbf{Q}}(T_m) = b_n \quad (23)$$

where  $a_n$  and  $b_n$  are as before.

For simplicity, we assume that  $|\text{Orb}(X)| = m < \infty$  in what follows.

Let  $\pi : X \rightarrow \text{Orb}(X) = T_m$  be the projection from a quandle  $X$  to its orbit quandle identified with  $T_m$ . From the naturality of the basic homology long exact sequence, we have a commutative diagram

$$\begin{array}{ccccccccc} \dots & \xrightarrow{\partial_*} & H_n^{\mathbf{D}}(X) & \xrightarrow{i_*} & H_n^{\mathbf{R}}(X) & \xrightarrow{j_*} & H_n^{\mathbf{Q}}(X) & \xrightarrow{\partial_*} & \dots \\ & & \downarrow & & \downarrow & & \downarrow & & \\ 0 & \rightarrow & H_n^{\mathbf{D}}(T_m) & \xrightarrow{i_*} & H_n^{\mathbf{R}}(T_m) & \xrightarrow{j_*} & H_n^{\mathbf{Q}}(T_m) & \rightarrow & 0, \end{array} \quad (24)$$

where the vertical maps are the induced homomorphisms  $\pi_*$ .

**3.7 Remark (Orbit-Writhe).** Let  $\pi : X \rightarrow \text{Orb}(X) = T_m$  be the projection from a quandle  $X$  to its orbit quandle.  $C_n^{\mathbf{R}}(T_m)$  is freely generated by  $n$ -tuples  $\vec{\omega} = (\omega_1, \dots, \omega_n)$  of elements of  $T_m = \text{Orb}(X)$ . Let  $\vec{\omega}$  be one of the generators, and let  $p_{\vec{\omega}} : H_n^{\mathbf{R}}(T_m) = C_n^{\mathbf{R}}(T_m) \rightarrow \mathbf{Z}$  be the projection to the factor generated by  $\vec{\omega}$ . The composition  $p_{\vec{\omega}} \circ \pi_* : H_n^{\mathbf{R}}(X) \rightarrow \mathbf{Z}$  or  $Z_n^{\mathbf{R}}(X) \rightarrow H_n^{\mathbf{R}}(X) \rightarrow \mathbf{Z}$  is the  $\vec{\omega}$ -orbit writhe in the sense of Greene [9].

**3.8 Proposition.** For a quandle  $X$ ,  $H_1^{\mathbf{D}}(X) = 0$ .  $H_1^{\mathbf{R}}(X)$  and  $H_1^{\mathbf{Q}}(X)$  are free abelian groups of rank  $m = |\text{Orb}(X)|$ .

*Proof.* By definition,  $H_1^{\mathbf{D}}(X) = H_0^{\mathbf{D}}(X) = 0$  for any quandle  $X$ . By the basic homology long exact sequence,  $H_1^{\mathbf{R}}(X)$  is isomorphic to  $H_1^{\mathbf{Q}}(X)$ . The cycle group  $Z_1^{\mathbf{R}}(X)$  is freely generated by elements of  $X$ , and the boundary group  $B_1^{\mathbf{R}}(X)$  is generated by the images  $\partial_2((x, y)) = (x) - (x * y)$  for all pairs  $(x, y)$  of the elements of  $X$ . Therefore if  $x \sim y$ , then  $[x] = [y]$  in  $H_1^{\mathbf{R}}(X)$ . Hence  $H_1^{\mathbf{R}}(X)$  is generated by  $\{[x_{\omega}] | \omega \in \text{Orb}(X)\}$ , where  $x_{\omega}$  is a representative of an orbit  $\omega$  in  $\text{Orb}(X)$ . In the diagram (24) with  $n = 1$ ,  $H_1^{\mathbf{R}}(T_m)$  is the free abelian group generated by  $\{[\omega] | \omega \in \text{Orb}(X) = T_m\}$ , and  $\pi_* : H_1^{\mathbf{R}}(X) \rightarrow H_1^{\mathbf{R}}(T_m)$  maps  $[x_{\omega}]$  to  $[\omega]$ . Therefore  $\pi_* : H_1^{\mathbf{R}}(X) \rightarrow H_1^{\mathbf{R}}(T_m)$  is an isomorphism.  $\square$

**3.9 Proposition.** For a quandle  $X$ ,  $H_2^D(X)$  is a free abelian group of rank  $m = |\text{Orb}(X)|$ . The boundary operator  $\partial_* : H_3^Q(X) \rightarrow H_2^D(X)$  is the 0-map. Hence the basic homology long exact sequence has a short exact factor

$$0 \rightarrow H_2^D(X) \xrightarrow{i_*} H_2^R(X) \xrightarrow{j_*} H_2^Q(X) \rightarrow 0. \quad (25)$$

*Proof.*  $Z_2^D(X) = C_2^D(X)$ , which is generated by  $(x, x)$  for all  $x \in X$ .  $B_2^D(X)$  is generated by  $\partial_3((x, x, y)) = -(x, x) + (x * y, x * y)$  and  $\partial_3((x, y, y)) = -(x * y, y) + (x * y, y)$  for all  $x, y \in X$ . If  $x \sim y$ , then  $[x, x] = [y, y]$  in  $H_2^D(X)$ . Therefore  $H_2^D(X)$  is generated by  $\{[x_\omega, x_\omega] | \omega \in \text{Orb}(X)\}$ , where  $x_\omega$  is a representative of an orbit  $\omega$ . Since  $H_2^D(T_m)$  is the free abelian group generated by  $\{[\omega, \omega] | \omega \in \text{Orb}(X) = T_m\}$ , we see that  $\pi_* : H_2^D(X) \rightarrow H_2^D(T_m)$  is an isomorphism. Thus  $H_2^D(X)$  is a free abelian group of rank  $m = |\text{Orb}(X)|$ . In general, from the diagram (24), we see that  $\text{Ker}[i_* : H_n^D(X) \rightarrow H_n^R(X)]$  is contained in  $\text{Ker}[\pi_* : H_n^D(X) \rightarrow H_n^D(T_m)]$ . Therefore we have that  $i_* : H_2^D(X) \rightarrow H_2^R(X)$  is injective and hence  $\partial_* : H_3^Q(X) \rightarrow H_2^D(X)$  is the 0-map. Since  $\partial_* : H_2^Q(X) \rightarrow H_1^D(X)$  is the 0-map, we have the short exact sequence.  $\square$

**3.10 Example.** Let  $X = R_k$  be the dihedral quandle of  $k$  elements. Suppose that  $k$  is an odd integer. Then  $|\text{Orb}(R_k)| = 1$ . Thus

$$\begin{array}{ccccccccc} 0 & \rightarrow & H_2^D(X) & \xrightarrow{i_*} & H_2^R(X) & \xrightarrow{j_*} & H_2^Q(X) & \rightarrow & 0 \\ & & \downarrow \cong & & \downarrow & & \downarrow & & \\ 0 & \rightarrow & H_2^D(T_1) & \xrightarrow{i_*} & H_2^R(T_1) & \xrightarrow{j_*} & H_2^Q(T_1) & \rightarrow & 0 \\ & & \parallel & & \parallel & & \parallel & & \\ & & \mathbf{Z} & = & \mathbf{Z} & & 0 & & \end{array} \quad (26)$$

Greene proved that  $H_2^R(X)$  is generated by  $[(0, 0)]$  by a geometric argument, and the order is infinite by using the  $\vec{\omega}$ -orbit where  $\vec{\omega}$  is the generator of  $H_2^R(T_1)$ . Hence we have that  $H_2^Q(X) = 0$ . Conversely if we know that  $H_2^Q(X) = 0$ , then we have  $H_2^R(X) = \mathbf{Z}$ .

**3.11 Conjecture.** In the basic homology long exact sequence for any finite quandle  $X$ , the boundary operators  $\partial_* : H_n^Q(X) \rightarrow H_{n-1}^D(X)$  are 0-maps. Thus the sequence is decomposed into short exacts

$$0 \rightarrow H_n^D(X) \xrightarrow{i_*} H_n^R(X) \xrightarrow{j_*} H_n^Q(X) \rightarrow 0. \quad (27)$$

We define an index  $S(X)$  of  $X$  by the minimum integer  $n$  such that  $\partial_* : H_n^Q(X) \rightarrow H_{n-1}^D(X)$  is not the 0-map (if there exist no such integers  $n$ , then  $S(X) = \infty$ ). The conjecture is that  $S(X) = \infty$  for any finite quandle  $X$ .

By a computer calculation, we have that  $S(R_3) > 6$ ,  $S(R_4) > 5$ ,  $S(R_5) > 4$ ,  $S(QS(5)) > 4$ , etc. where  $QS(5)$  is the quandle of non-identity permutations on three letters.

## 4 Lower Bounds for Betti Numbers

**4.1 Theorem.** *Let  $\pi : X \rightarrow \text{Orb}(X) = T_m$  be the projection from a quandle  $X$  to its orbit quandle. If  $X$  is finite or if there is a homomorphism  $s : T_m \rightarrow X$  with  $\pi \circ s = \text{id}$ , Then*

$$\beta_n^{\text{D}}(X) \geq a_n, \quad \beta_n^{\text{R}}(X) \geq m^n, \quad \beta_n^{\text{Q}}(X) \geq b_n, \quad (28)$$

where  $a_n$  and  $b_n$  are as before.

Before proving this theorem, we give some remarks here.

(1) The inequalities of the theorem are best possible; namely, for any  $n$ , there is a quandle  $X$  such that the equalities hold. Actually, the trivial quandle  $T_m$  is such an example.

(2) In case  $\pi_*$  is not surjective, the cokernel has a meaning. Our proof of the theorem gives information on the cokernel that will be treated later.

(3) Consider  $X = \mathbf{R} \times T_2$  as a quandle with

$$(a, i) * (b, j) = \begin{cases} (2b - a, i) & \text{if } i = j \\ (a, i) & \text{if } i \neq j \end{cases}$$

Then this is a quandle with  $\text{Orb}(X) = T_2$  and with  $s(j) = (0, j)$ . In this case  $\pi \circ s = \text{id}$ . So the theorem applies to this infinite quandle.

Let  $X$  be a finite quandle, and let  $X \rightarrow \text{Orb}(X) = T_m$  be the projection. For an  $n$ -tuple  $\vec{\omega} = (\omega_1, \dots, \omega_n)$  of elements of  $\text{Orb}(X)$ , define an element  $T^{\text{R}}(\vec{\omega}) \in C_n^{\text{R}}(X)$  by

$$T^{\text{R}}(\vec{\omega}) = \sum_{x_j \in \omega_j (j=1, \dots, n)} (x_1, \dots, x_n), \quad (29)$$

where  $x_j$  runs over  $\omega_j$  for each  $j = 1, \dots, n$ .

For an  $n$ -tuple  $\vec{\omega} = (\omega_1, \dots, \omega_n)$  of elements of  $\text{Orb}(X)$  such that  $\omega_i = \omega_{i+1}$  for some  $i \in \{1, \dots, n-1\}$ , pick an index  $i_0$  such that  $\omega_{i_0} = \omega_{i_0+1}$ , and define an element  $T^{\text{D}}(\vec{\omega}; i_0) \in C_n^{\text{D}}(X)$  by

$$T^{\text{D}}(\vec{\omega}; i_0) = \sum_{x_j \in \omega_j (j=1, \dots, n), x_{i_0} = x_{i_0+1}} (x_1, \dots, x_n) \quad (30)$$

where  $x_j$  runs over  $\omega_j$  for each  $j$  ( $j = 1, \dots, n$ ) under the condition  $x_{i_0} = x_{i_0+1}$ .

### 4.2 Lemma.

- (1)  $T^{\text{R}}(\vec{\omega}) \in Z_n^{\text{R}}(X)$ .
- (2)  $T^{\text{D}}(\vec{\omega}, i_0) \in Z_n^{\text{D}}(X)$ .

*Proof.* (1) If  $n = 1$ , it is obvious. So we assume  $n \geq 2$ .

$$\begin{aligned} & \partial_n(T^{\text{R}}(\vec{\omega})) \\ &= \sum_{x_j \in \omega_j (j=1, \dots, n)} \partial_n(x_1, \dots, x_n) \end{aligned}$$



$$\begin{aligned}
&= \sum_{x_j \in \omega_j (j=1, \dots, n)} \left[ \sum_{i=2}^n (-1)^i [(x_1, x_2, \dots, x_{i-1}, x_{i+1}, \dots, x_n) \right. \\
&\quad \left. - (x_1 * x_i, x_2 * x_i, \dots, x_{i-1} * x_i, x_{i+1}, \dots, x_n)] \right] \\
&= \sum_{i=2}^n (-1)^i \left[ \sum_{x_j \in \omega_j (j=1, \dots, n)} [(x_1, x_2, \dots, x_{i-1}, x_{i+1}, \dots, x_n) \right. \\
&\quad \left. - (x_1 * x_i, x_2 * x_i, \dots, x_{i-1} * x_i, x_{i+1}, \dots, x_n)] \right] \tag{31}
\end{aligned}$$

Since  $S(x_i)|_{\omega_j} : \omega_j \rightarrow \omega_j$  is a bijection, there is a bijection between the sets

$$\{(x_1, x_2, \dots, x_{i-1}, x_{i+1}, \dots, x_n) | x_j \in \omega_j (j = 1, \dots, n)\}$$

and

$$\{(x_1 * x_i, x_2 * x_i, \dots, x_{i-1} * x_i, x_{i+1}, \dots, x_n) | x_j \in \omega_j (j = 1, \dots, n)\}.$$

Thus the sum is zero.

(2) is proved by the same calculation.  $\square$

**4.3 Proof of Theorem 4.1.** In the first case, the induced homomorphism  $s_* : H_n^W(T_m) \rightarrow H_n^W(X)$  is the right inverse of  $\pi_* : H_n^W(X) \rightarrow H_n^W(T_m)$ . By (23), we have the inequalities.

In the second case,  $H_n^R(T_m) = C_n^R(T_m)$  is a free abelian group generated by the  $n$ -tuples  $\vec{\omega} = (\omega_1, \dots, \omega_n)$ . Divide the generator set,  $\mathcal{G}_R$ , of  $C_n^R(T_m)$  into two subsets  $\mathcal{G}_D$  and  $\mathcal{G}_Q$  as follows:  $\mathcal{G}_D$  consists of  $n$ -tuples  $\vec{\omega} = (\omega_1, \dots, \omega_n)$  such that  $\omega_i = \omega_{i+1}$  for some  $i$ , and  $\mathcal{G}_Q$  is the complement. For each generator  $\vec{\omega} \in \mathcal{G}_D$ , fix an element  $T^D(\vec{\omega}, i_0) \in Z_n^R(X)$ ; for each generator  $\vec{\omega} \in \mathcal{G}_Q$ , consider the element  $T^R(\vec{\omega}) \in Z_n^R(X)$ . Obviously,  $\pi_*(T^D(\vec{\omega}, i_0)) = (\prod_{j=1}^n |\omega_j|) / |\omega_i| \vec{\omega}$ , and  $\pi_*(T^R(\vec{\omega})) = (\prod_{j=1}^n |\omega_j|) \vec{\omega}$ . Define a homomorphism  $T : H_n^R(T_m) \rightarrow H_n^R(X)$  by

$$T(\vec{\omega}) = \begin{cases} T^D(\vec{\omega}, i_0) & \text{if } \vec{\omega} \in \mathcal{G}_D, \\ T^R(\vec{\omega}) & \text{if } \vec{\omega} \in \mathcal{G}_R. \end{cases}$$

Then  $\pi_* \circ T : H_n^R(T_m) \rightarrow H_n^R(X)$  maps each generator in  $\mathcal{G}_D$  (resp.  $\mathcal{G}_Q$ ) to itself multiplied by  $(\prod_{j=1}^n |\omega_j|) / |\omega_i|$  (resp.  $\prod_{j=1}^n |\omega_j|$ ). Thus the image of  $T$  is a free abelian group in  $H_n^R(X)$  of rank  $m^n$ . Thus we have  $\beta_n^R(X) \geq m^n$ .

$H_n^D(T_m)$  is a subgroup of  $H_n^R(T_m)$  generated by  $\mathcal{G}_D$ . By Lemma 4.2, the image of the restriction of  $T$  to  $H_n^D(T_m)$  is contained in  $H_n^D(X)$ , which is a free abelian group of rank  $a_n$ . Thus we have  $\beta_n^D(X) \geq a_n$ .

The image of the restriction of  $T$  to the subgroup of  $H_n^R(T_m)$  generated by  $\mathcal{G}_Q$  is a free abelian group in  $H_n^R(X)$  of rank  $b_n$ . Since the subgroup of  $H_n^R(T_m)$  generated by  $\mathcal{G}_Q$  is mapped identically to  $H_n^Q(T_m)$ , there is a free abelian group in  $H_n^Q(X)$  of rank  $b_n$ . Thus we have  $\beta_n^Q(X) \geq b_n$ .  $\square$

**4.4 Corollary.** *Let  $R_k$  be the dihedral quandle of  $k$  elements.*

(1) *If  $k$  is even, then*

$$\beta_n^D(R_k) \geq 2^n - 2, \quad \beta_n^R(R_k) \geq 2^n, \quad \beta_n^Q(R_k) \geq 2. \quad (32)$$

*In particular,  $H_n^Q(R_k; G) \neq 0$  and  $H_n^R(R_k; G) \neq 0$  for any coefficient group  $G$ .*

(2) *If  $k$  is odd, then*

$$\beta_n^D(R_k) \geq 1, \quad \beta_n^R(R_k) \geq 1. \quad (33)$$

*Proof.* If  $k$  is even, then  $|\text{Orb}(R_k)| = 2$ . If  $k$  is odd, then  $|\text{Orb}(R_k)| = 1$ . By Theorem 4.1 and the universal coefficient theorem, we have the result.  $\square$

By a computer calculation, we have

$$\beta_2^D(R_4) = 2, \quad \beta_2^R(R_4) = 4, \quad \beta_2^Q(R_4) = 2. \quad (34)$$

$$\beta_3^D(R_4) = 6, \quad \beta_3^R(R_4) = 8, \quad \beta_3^Q(R_4) = 2. \quad (35)$$

Thus the lower bounds in the corollary (or Theorem 4.1) are the best possible.

## 5 The Cokernel of $\pi_*$

Suppose the quandle  $X$  is finite. Let  $X \rightarrow \text{Orb}(X) = T_m$  be the projection. For an  $n$ -tuple  $\vec{\omega} = (\omega_1, \dots, \omega_n)$  where  $\omega_j \in \text{Orb}(X)$ , fix a representative  $x_n \in \omega_n$ . Define

$$T^R(\vec{\omega}, x_n) = \sum_{x_j \in \omega_j (j=1, \dots, n-1)} (x_1, \dots, x_n). \quad (36)$$

The sum runs over  $x_j \in \omega_j$  for each  $j = 1, \dots, n-1$ . Then  $T(\vec{\omega}, x_n)$  is an element of  $C_n^R(X)$ .

Similarly, when  $\vec{\omega} = (\omega_1, \dots, \omega_n)$  and  $\omega_j \in \text{Orb}(X)$  is such that  $\omega_i = \omega_{i+1}$  for some  $i \in \{1, \dots, n-1\}$ , we fix representative  $x_n \in \omega_n$ . Define

$$T^D(\vec{\omega}, i_0, x_n) = \sum_{x_j \in \omega_j (j=1, \dots, n-1), x_{i_0} = x_{i_0+1}} (x_1, \dots, x_n) \quad (37)$$

where the sum runs over  $x_j \in \omega_j$  such that  $x_{i_0} = x_{i_0+1}$  and  $x_n$  is fixed. Then  $T^D(\vec{\omega}, i_0, x_n)$  is an element of  $C_n^D(X)$ .

By the same argument as in the proof of Lemma 4.2, we see that

(1)  $T^R(\vec{\omega}, x_n) \in Z_n^R(X)$ ,

(2)  $T^D(\vec{\omega}, i_0, x_n) \in Z_n^D(X)$ .

In the proof of Theorem 4.1, we may consider a homomorphism  $T' : H_n^R(T_m) \rightarrow H_n^R(X)$ , instead of  $T$ , such that

$$T'(\vec{\omega}) = \begin{cases} T^D(\vec{\omega}, i_0, x_n) & \text{if } \vec{\omega} \in \mathcal{G}_D \\ T^R(\vec{\omega}, x_n) & \text{if } \vec{\omega} \in \mathcal{G}_R \end{cases}$$

Then  $\pi_* \circ T' : H_n^R(T_m) \rightarrow H_n^R(T_m)$  maps each generator in  $\mathcal{G}_D$  (resp.  $\mathcal{G}_Q$ ) to itself multiplied by  $(\prod_{j=1}^{n-1} |\omega_j|)/|\omega_i|$  (resp.  $\prod_{j=1}^{n-1} |\omega_j|$ ). The cokernel of  $\pi_* : H_n^W(X) \rightarrow H_n^W(T_m)$  is generated by  $\mathcal{G}_D$ ,  $\mathcal{G}_R = \mathcal{G}_D \cup \mathcal{G}_Q$ , or  $\mathcal{G}_Q$ , according to  $W$  is  $D$ ,  $R$  or  $Q$ . If  $\vec{\omega}$  is in  $\mathcal{G}_D$ , its order in  $\text{Coker}[\pi_* : H_n^W(X) \rightarrow H_n^W(T_m)]$  ( $W = D, R$ ) is finite and divides  $(\prod_{j=1}^{n-1} |\omega_j|)/|\omega_i|$ . If  $\vec{\omega}$  is in  $\mathcal{G}_Q$ , its order in  $\text{Coker}[\pi_* : H_n^W(X) \rightarrow H_n^W(T_m)]$  ( $W = R, Q$ ) is finite and divides  $\prod_{j=1}^{n-1} |\omega_j|$ . Here we assume that a trivial element has order 1. Therefore we have the following.

**5.1 Proposition.** *Let  $\pi : X \rightarrow \text{Orb}(X) = T_m$  be the projection from a finite quandle  $X$  to its orbit quandle. The cokernel of  $\pi_* : H_n^W(X) \rightarrow H_n^W(T_m)$  is finite. The order of each generator  $[\vec{\omega}]$  in  $\text{Coker}[\pi_* : H_n^W(X) \rightarrow H_n^W(T_m)]$  divides  $(\prod_{j=1}^{n-1} |\omega_j|)/|\omega_i|$  if  $\vec{\omega} \in \mathcal{G}_D$  or  $\prod_{j=1}^{n-1} |\omega_j|$  if  $\vec{\omega} \in \mathcal{G}_Q$ .*

We abbreviate  $\text{Coker}[\pi_* : H_n^W(X) \rightarrow H_n^W(T_m)]$  to  $\text{Coker}_n^W(X)$ . For  $R_4$ ,  $|\text{Orb}(0)| = |\text{Orb}(1)| = 2$ . If  $n = 2$ , then  $\mathcal{G}_D = \{(\omega_0, \omega_0), (\omega_1, \omega_1)\}$  and  $\mathcal{G}_Q = \{(\omega_0, \omega_1), (\omega_1, \omega_0)\}$ , where  $\omega_i = \text{Orb}(i)$ . By Proposition 5.1, we have that  $\text{order}(\omega_0, \omega_0) = \text{order}(\omega_1, \omega_1) = 1$  and that  $\text{order}(\omega_1, \omega_0)$  and  $\text{order}(\omega_0, \omega_1)$  are 1 or 2. Thus

$$\text{Coker}_2^D(R_4) = 0, \quad \text{Coker}_2^R(R_4) = (\mathbf{Z}_2)^k, \quad \text{Coker}_2^Q(R_4) = (\mathbf{Z}_2)^k, \quad (38)$$

for some  $k \in \{0, 1, 2\}$ . By a computer calculation, we have

$$\text{Coker}_2^D(R_4) = 0, \quad \text{Coker}_2^R(R_4) = (\mathbf{Z}_2)^2, \quad \text{Coker}_2^Q(R_4) = (\mathbf{Z}_2)^2. \quad (39)$$

## 6 Another Relation between the Homology Groups

We will give an alternative relationship between the degeneration homology groups and the rack homology groups.

For a quandle  $X$ , let  $C_n^{\text{DD}}(X)$  be the free abelian group generated by  $n$ -tuples  $(x_1, \dots, x_n)$  such that  $x_1 = x_2$ , or  $C_n^{\text{DD}}(X) = 0$  if  $n < 2$ . Then  $C_*^{\text{DD}}(X) = \{C_n^{\text{DD}}(X), \partial_n\}$  is a sub-complex of  $C_*^D(X)$  and of  $C_*^R(X)$ . Putting  $C_n^{\text{D/DD}}(X) = C_n^D(X)/C_n^{\text{DD}}(X)$ , we have a chain complex  $C_*^{\text{D/DD}}(X) = \{C_n^{\text{D/DD}}(X), \partial_n\}$  and a long exact sequence

$$\cdots \xrightarrow{\partial_*} H_n^{\text{DD}}(X; G) \xrightarrow{i_*} H_n^D(X; G) \xrightarrow{j_*} H_n^{\text{D/DD}}(X; G) \xrightarrow{\partial_*} H_{n-1}^{\text{DD}}(X; G) \rightarrow \cdots \quad (40)$$

**6.1 Proposition.** *For a quandle  $X$ , there is a long exact sequence*

$$\cdots \rightarrow H_{n-1}^R(X; G) \rightarrow H_n^D(X; G) \xrightarrow{j_*} H_n^{\text{D/DD}}(X; G) \rightarrow H_{n-2}^R(X; G) \rightarrow \cdots \quad (41)$$

*This is natural with respect to homomorphisms induced from quandle homomorphisms.*

*Proof.* Let  $u_n : C_n^{\text{DD}}(X) \rightarrow C_{n-1}^{\text{R}}(X)$  be an isomorphism with  $u_n(x_1, \dots, x_n) = (x_1, x_3, \dots, x_n)$ . It is easily checked that  $u_{n-1} \circ \partial_n = -\partial_{n-1} \circ u_n$ , namely,  $u = \{u_n\} : C_*^{\text{DD}}(X) \rightarrow C_*^{\text{R}}(X)$  is a chain map of degree  $-1$ . It induces an isomorphism  $u_{n*} : H_n^{\text{DD}}(X) \rightarrow H_{n-1}^{\text{R}}(X)$ . Combine this isomorphism with (40).  $\square$

For a quandle  $X$ , let  $UH_n^{\text{DD}}(X)$  and  $UH_n^{\text{D}}(X)$  be the subgroups of  $H_n^{\text{DD}}(X)$  and  $H_n^{\text{D}}(X)$  generated by  $\{(x, \dots, x) \mid x \in X\}$ .

**6.2 Lemma.**  $\text{Ker}[i_* : H_n^{\text{DD}}(X) \rightarrow H_n^{\text{D}}(X)] \cap UH_n^{\text{DD}}(X) = 0$ .

*Proof.* Let  $\pi : X \rightarrow \text{Orb}(X) = T_m$  be the projection to its orbit quandle. From the naturality of the exact sequence (40), we have a commutative diagram

$$\begin{array}{ccccccccc} \dots & \xrightarrow{\partial_*} & H_n^{\text{DD}}(X) & \xrightarrow{i_*} & H_n^{\text{D}}(X) & \xrightarrow{j_*} & H_n^{\text{D/DD}}(X) & \xrightarrow{\partial_*} & \dots \\ & & \downarrow & & \downarrow & & \downarrow & & \\ 0 & \rightarrow & H_n^{\text{DD}}(T_m) & \xrightarrow{i_*} & H_n^{\text{D}}(T_m) & \xrightarrow{j_*} & H_n^{\text{D/DD}}(T_m) & \rightarrow & 0, \end{array} \quad (42)$$

where the vertical maps are the induced homomorphisms  $\pi_*$ . By a similar argument to the proof of Lemma 3.9, we see that  $UH_n^{\text{DD}}(X)$  and  $UH_n^{\text{D}}(X)$  are generated by  $\{(x_\omega, \dots, x_\omega) \mid \omega \in \text{Orb}(X)\}$ , where  $x_\omega$  is a representative of an orbit  $\omega$  and that  $\pi_* : UH_n^{\text{DD}}(X) \rightarrow UH_n^{\text{DD}}(T_m)$  and  $\pi_* : UH_n^{\text{D}}(X) \rightarrow UH_n^{\text{D}}(T_m)$  are isomorphisms. Note that  $UH_n^{\text{DD}}(T_m)$  and  $UH_n^{\text{D}}(T_m)$  are free abelian group generated by  $\{[\omega, \dots, \omega] \mid \omega \in \text{Orb}(X)\}$ . Thus we have the result.  $\square$

**6.3 Lemma.** *The boundary operators  $\partial_* : H_4^{\text{D/DD}}(X) \rightarrow H_3^{\text{DD}}(X)$  and  $\partial_* : H_3^{\text{D/DD}}(X) \rightarrow H_2^{\text{DD}}(X)$  are 0-maps.*

*Proof.* Let  $s_n : C_n^{\text{D/DD}}(X) \rightarrow C_n^{\text{D}}(X)$  be a homomorphism defined by  $(x_1, \dots, x_n) + C_n^{\text{DD}}(X) \mapsto (x_1, \dots, x_n)$  where  $(x_1, \dots, x_n)$  are  $n$ -tuples such that  $x_1 \neq x_2$  and there exists some  $i$  with  $x_i = x_{i+1}$ . There is a unique homomorphism  $\phi_n : C_n^{\text{D/DD}}(X) \rightarrow C_{n-1}^{\text{DD}}(X)$  such that  $i \circ \phi_n = \partial_n \circ s_n - s_{n-1} \circ \partial_n$ . Then  $\phi = \{\phi_n\}$  is a chain map of degree  $-1$ , i.e.,  $\partial_{n-1} \circ \phi_n = -\phi_{n-1} \circ \partial_n$ , and the induced homomorphism  $(\phi_n)_* : H_n^{\text{D/DD}}(X) \rightarrow H_{n-1}^{\text{DD}}(X)$  is the same as the boundary operator  $\partial_* : H_n^{\text{D/DD}}(X) \rightarrow H_{n-1}^{\text{DD}}(X)$ . For simplifying notation, we denote an element  $(x_1, \dots, x_n) + C_n^{\text{DD}}(X)$  of  $C_n^{\text{D/DD}}(X)$  by  $(x_1, \dots, x_n)$ .

$C_4^{\text{D/DD}}(X)$  is generated by  $(x_1, x_2, x_2, x_4)$  and  $(x_1, x_2, x_3, x_3)$  for  $x_1, \dots, x_4 \in X$  with  $x_1 \neq x_2$ . Since  $\phi_4((x_1, x_2, x_2, x_4)) = 0$  and  $\phi_4((x_1, x_2, x_3, x_3)) = 0$  or  $\pm(x_3, x_3, x_3)$ , the image  $\text{Im}[\partial_* : H_4^{\text{D/DD}}(X) \rightarrow H_3^{\text{D}}(X)]$  is in  $UH_3^{\text{DD}}(X)$ . By Lemma 6.2 and the exactness of (40), we have

$$\text{Im}[\partial_* : H_4^{\text{D/DD}}(X) \rightarrow H_3^{\text{D}}(X)] = 0.$$

Since  $H_2^{\text{DD}}(X) = UH_2^{\text{DD}}(X)$ , by Lemma 6.2 and the exactness of (40),

$$\text{Im}[\partial_* : H_3^{\text{D/DD}}(X) \rightarrow H_2^{\text{D}}(X)] = 0. \square$$

**6.4 Lemma.**  $\pi_* : H_3^{\text{D/DD}}(X) \rightarrow H_3^{\text{D/DD}}(T_m)$  is an isomorphism where  $T_m = \text{Orb}(X)$ .

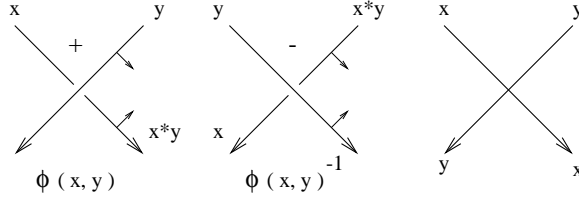

Figure 1: Three types of crossings of virtual knots

*Proof.*  $C_3^{\text{D/DD}}(X)$  is generated by  $(x_1, x_2, x_2)$  for  $x_1, x_2 \in X$  with  $x_1 \neq x_2$ . Since  $\partial_3((x_1, x_2, x_2)) = 0$ , we have that  $Z_3^{\text{D/DD}}(X) = C_3^{\text{D/DD}}(X)$  and  $H_3^{\text{D/DD}}(X)$  is generated by  $[(x_1, x_2, x_2)]$  ( $x_1 \neq x_2$ ). Since  $\partial_4(x_1, x_2, x_2, x_4) = (x_1, x_2, x_2) - (x_1 * x_4, x_2 * x_4, x_2 * x_4)$  and  $\partial_4(x_1, x_2, x_3, x_3) = (x_1, x_3, x_3) - (x_1 * x_2, x_3, x_3)$ , we see that if  $x_1 \sim x'_1$  and  $x_2 \sim x'_2$ , then  $[(x_1, x_2, x_2)] = [(x'_1, x'_2, x'_2)]$  in  $H_3^{\text{D/DD}}(X)$ . If  $x_1 \sim x_2$ , then  $[(x_1, x_2, x_2)] = [(x_1, x_1, x_1)] = 0$  in  $H_3^{\text{D/DD}}(X)$ . Thus  $H_3^{\text{D/DD}}(X)$  is generated by  $[(x_{\omega_1}, x_{\omega_2}, x_{\omega_2})]$  ( $\omega_1, \omega_2 \in \text{Orb}(X)$  with  $\omega_1 \neq \omega_2$ ), where  $x_\omega$  is a representative of  $\omega \in \text{Orb}(X)$ . Since  $H_3^{\text{D/DD}}(T_m)$  is a free abelian group generated by  $[(\omega_1, \omega_2, \omega_2)]$  ( $\omega_1, \omega_2 \in \text{Orb}(X)$  with  $\omega_1 \neq \omega_2$ ), we have the result.  $\square$

**6.5 Proposition.** For a quandle  $X$ , there exists a short exact sequence

$$0 \rightarrow H_2^{\text{R}}(X) \rightarrow H_3^{\text{D}}(X) \rightarrow \mathbf{Z}^{m^2-m} \rightarrow 0, \quad (43)$$

where  $m = |\text{Orb}(X)|$ .

*Proof.* By Lemma 6.3, we have a short exact sequence

$$0 \rightarrow H_2^{\text{R}}(X) \rightarrow H_3^{\text{D}}(X) \rightarrow H_3^{\text{D/DD}}(X) \rightarrow 0 \quad (44)$$

from (41). By Lemma 6.4,  $H_3^{\text{D/DD}}(X)$  is isomorphic to  $\mathbf{Z}^{m^2-m}$ .  $\square$

**6.6 Corollary.**  $\text{Torsion} H_2^{\text{R}}(X) \cong \text{Torsion} H_3^{\text{D}}(X)$ .

## 7 Quandle (Co)homology and Virtual Knots

A *virtual knot (diagram)* [11] is a generically immersed oriented 1-manifold in the plane together with the following three types of crossing information at double points. First, there are two types, positive and negative, crossings with over-under information as in the classical knot theory. The under-path is broken into two arcs. The left and the middle pictures of Fig. 1 depict positive and negative crossings, respectively. (The labels and the expression  $\phi$  will be used later.) The right of the figure depicts a crossing of the third type, called a *virtual crossing*, at which there is no over-under information.

Two virtual knot diagrams are *equivalent* if the diagrams are related by a sequence of Reidemeister moves depicted in Fig. 2, and ambient isotopy of the plane. A *virtual knot* is an equivalence class of a virtual knot diagram.

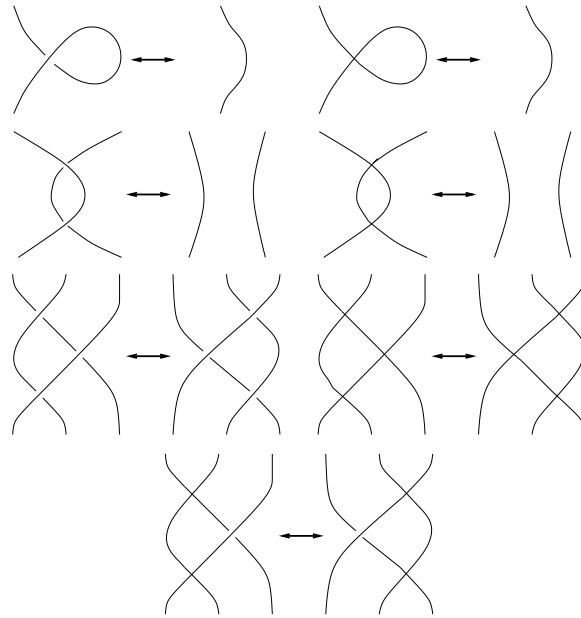

Figure 2: Reidemeister moves for virtual knots by Kauffman

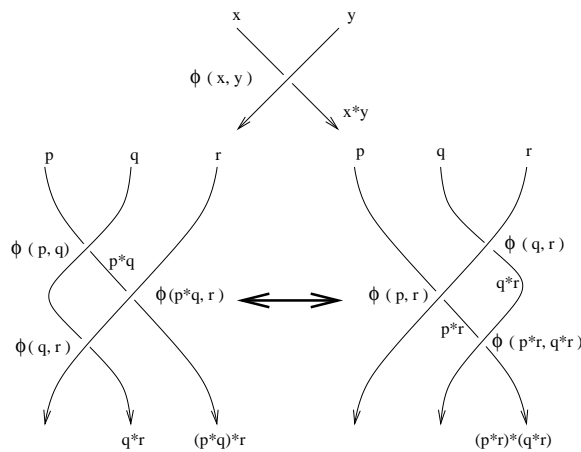

Figure 3: Colors at a crossing

At crossings of a virtual knot, the under-arc is broken. The complement consists of immersed arcs. These transverse components of arcs are called over-arcs of a virtual knot.

A *color* (or *coloring*) on a virtual knot diagram is a function  $\mathcal{C} : R \rightarrow X$ , where  $X$  is a fixed quandle and  $R$  is the set of over-arcs satisfying the condition depicted in the top of Fig. 3. In the top of Fig. 3, a crossing with over-arc,  $r$ , has color  $\mathcal{C}(r) = y \in X$ . The under-arcs are called  $r_1$  and  $r_2$  from top to bottom; they are colored  $\mathcal{C}(r_1) = x$  and  $\mathcal{C}(r_2) = x * y$ . Note that locally the colors do not depend on the orientation of the under-arc.

Assume that a finite quandle  $X$  is given. Pick a quandle 2-cocycle  $\phi \in Z_{\mathbb{Q}}^2(X, G)$ , and write the coefficient group,  $G$ , multiplicatively. Consider a non-virtual crossing in the diagram. For each coloring of the diagram, evaluate the 2-cocycle on the quandle colors that appear near the crossing as described as follows: The first argument is the color on the under-arc away from which the normal to the over-arc points. The second argument is the color on the over-arc. See Fig. 3.

Let  $\tau$  denote a non-virtual crossing, let  $\epsilon(\tau)$  denote its sign, and let  $\mathcal{C}$  denote a coloring. When the colors of the arcs are as describe above, the (*Boltzmann*) *weight of a crossing* is  $B(\tau, \mathcal{C}) = \phi(x, y)^{\epsilon(\tau)}$ .

The *partition function*, or a *state-sum*, is the expression

$$\sum_{\mathcal{C}} \prod_{\tau} B(\tau, \mathcal{C}).$$

The product is taken over all crossings of the given diagram, and the sum is taken over all possible colorings. The values of the partition function are taken to be in the group ring  $\mathbf{Z}[G]$  where  $G$  is the coefficient group. In fact, the value is in the group “rig”  $\mathbf{N}[G]$ .

By checking the equivalence relations we obtain

**7.1 Proposition.** *The state-sum is invariant under equivalence relations for virtual knots, thus defines invariants  $\Phi(K)$  (or  $\Phi_{\phi}(K)$  to specify the 2-cocycle  $\phi$  used).*

**7.2 Proposition.** *If  $\Phi_{\phi}$  and  $\Phi_{\phi'}$  denote the state-sum invariants defined from cohomologous 2-cocycles  $\phi$  and  $\phi'$  then  $\Phi_{\phi} = \Phi_{\phi'}$  (so that  $\Phi_{\phi}(K) = \Phi_{\phi'}(K)$  for any classical knot, or virtual knot). In particular, the state-sum is equal to the number of colorings of a given knot diagram if the 2-cocycle used for the Boltzmann weight is a coboundary.*

**7.3 Remark.** The definition of colors and the above propositions naturally generalize those in [2], stated for classical knots, to virtual knots. The state-sum invariants are defined also for knotted surfaces in 4-space in [2] and studied in [3]. For surfaces, 3-cocycles are used as Boltzmann weights assigned to triple points on projections. Virtual knots can also be defined in higher dimensions. A detailed study of these will be presented in a forthcoming paper.

We use the notion of linking numbers of virtual links [7] in the next section for construction of examples. Let  $L = K_1 \cup K_2$  be a virtual link, where  $K_i$  ( $i = 1, 2$ ) are distinct components. Let  $P$  and  $N$  be the numbers of positive and negative, respectively, crossing of  $L$  such that at the crossings  $K_1$  goes over  $K_2$ . Define the *virtual linking number*  $vlk(K_1, K_2) = P - N$ .

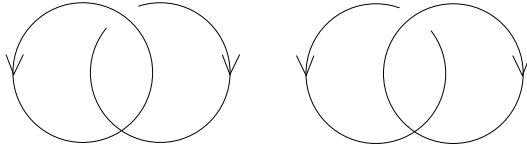

Figure 4: Negative and positive virtual Hopf links

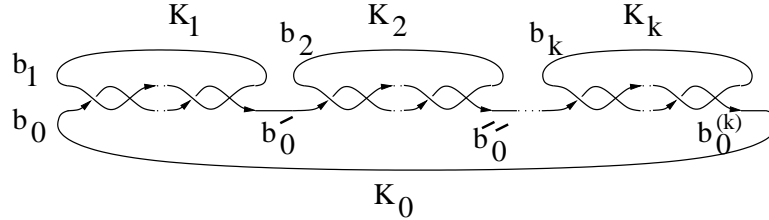

Figure 5: A family of virtual links

**7.4 Lemma.** *For any prescribed integers  $n_{ij}$ ,  $i, j = 1, \dots, k$ , there is a virtual link  $L = K_1 \cup \dots \cup K_k$  such that  $vlk(K_i, K_j) = n_{ij}$ .*

*Proof.* Consider a virtual Hopf link  $H_{\pm} = K_1 \cup K_2$ , the Hopf link diagram with one  $\pm$ -crossing respectively and one virtual crossing (Fig. 4). If the first component goes over the second,  $vlk(K_1, K_2) = \pm 1$  and  $vlk(K_2, K_1) = 0$ . The result follows by taking appropriate connected sum of copies of these.  $\square$

**7.5 Proposition.** *The cocycle invariants with trivial quandles  $T_n$  depends only on the virtual linking numbers.*

*Proof.* The colors are constant on each component. Any cocycle is written as a product of characteristic functions  $\chi_{(i,j)}$ , so the state-sum is described by  $vlk$ .  $\square$

## 8 Applications to Quandle (Co)homology

Let  $\pi : X \rightarrow Y$  be a surjective quandle homomorphism. Since  $Y$  is generally smaller, we try to use the information we already have for (co)homology groups of  $Y$  to obtain new information for those of  $X$ . Here, we apply this technique to a variety of quandles. The coefficients of the (co)homology groups are  $\mathbf{Z}$  unless otherwise specified.

**8.1 Proposition.** *Let a virtual knot or link diagram  $K$  be colored by a quandle  $X$ . Then  $K$  represents a 2-cycle in  $Z_2^W(X)$  where  $W = \mathbf{R}$  or  $\mathbf{Q}$ .*

*Proof.* Consider a (non-virtual) crossing of  $K$ . Then the colors  $(x, y)$  that are adjacent to the crossing represent a chain. As usual,  $x$  is the color on the under-arc away from which the normal to the over crossing points, and  $y$  is the color on the over-arc. We define the



sign of such a chain to be the sign of the crossing. The sum of these signed chains (taken over all crossings) is clearly a cycle.  $\square$

**8.2 Theorem.** *Let  $X = \mathbf{Z}[T, T^{-1}]/(h(T))$  be an Alexander quandle where  $h$  is a polynomial with  $h(1) = 0$ ,  $T_\infty = \mathbf{Z}$  be the trivial quandle, and  $\pi : X \rightarrow T_\infty$  be the quandle homomorphism defined by  $\pi(f(T)) = f(1)$ . Then the homomorphisms  $\pi_* : H_2^{\mathbf{Q}}(X) \rightarrow H_2^{\mathbf{Q}}(T_\infty)$  and  $\pi^* : H_2^{\mathbf{Q}}(T_\infty) \rightarrow H_2^{\mathbf{Q}}(X)$  are not 0-maps. In particular,  $H_2^{\mathbf{Q}}(X) \neq 0 \neq H_2^{\mathbf{Q}}(X)$ .*

*Proof.* For a given  $X$  with  $h(1) = 0$ , it will be proved in the lemma that follows this proof that there is a virtual link  $L$  (depicted in Fig. 5, connected sums of virtual torus links) such that (1)  $L$  has a nontrivial color with  $X$ , and (2) the color contributes a nontrivial  $t$ -term to the state-sum with the cocycle  $\pi^\sharp(\chi_{(a,b)})$  for some  $a, b \in T_\infty$ , where  $\chi$  denotes the characteristic function:

$$\chi_x(y) = \begin{cases} 1 & \text{if } x = y, \\ 0 & \text{if } x \neq y. \end{cases}$$

Hence by Proposition 7.2,  $\pi^\sharp(\chi_{(a,b)})$  is not a coboundary, and  $\pi^* : H_2^{\mathbf{Q}}(T_\infty) \rightarrow H_2^{\mathbf{Q}}(X)$  is not the 0-map.

The above color of  $L$  by  $X$  determines a 2-cycle  $\alpha$  in  $Z_2^{\mathbf{Q}}(X)$  as in the preceding proposition. The 2-cycle  $\pi_\sharp(\alpha)$  is represented by the same link  $L$  with the colors taken mod  $(T-1)$ , i.e., the colors with substitution  $T = 1$ . There are crossings in  $L$  with different colors  $(a, b)$ ,  $a \neq b \in T_\infty$  after substitution  $T = 1$ . Therefore  $\pi_\sharp(\alpha)$  is not a coboundary in  $Z_2^{\mathbf{Q}}(T_\infty)$ ; so  $\alpha$  is non-trivial in  $H_2^{\mathbf{Q}}(X)$ , and  $\pi_* : H_2^{\mathbf{Q}}(X) \rightarrow H_2^{\mathbf{Q}}(T_\infty)$  is not the 0-map.  $\square$

**8.3 Lemma.** *The virtual link  $L$  depicted in Fig. 5 (where the numbers of crossings will be determined in the proof for any given  $X$ ) is colored nontrivially by  $X$ , and has the nontrivial state-sum term with this color.*

*Proof.* Let  $h(T) = c_0 + \sum_{i=1}^k c_i T^{m_i}$  be a polynomial such that  $c_i \neq 0$  for  $i = 1, 2, \dots, n$  and  $\{m_i\}_{i=1}^k$  is a strictly increasing sequence of positive integers. Then any polynomial  $h(T)$  with  $h(1) = 0$  can be written as such a polynomial if and only if  $\sum_{i=0}^k c_i = 0$ , which is equivalent to  $c_k = -\sum_{i=0}^{k-1} c_i$ . In Fig. 5, the crossing repeats the sequence of a positive crossing followed by a virtual crossing, and for  $i = 1, 2, \dots, k$ , let  $vlk(K_i, K_0) = n_i$ , where  $n_i$  will be specified below, and all other virtual linking numbers to be 0. Color each  $K_i$  initially by  $b_i$ . Note that the color  $b_0$  changes to  $b'_0, b''_0, \dots, b_0^{(k)}$  as the string  $K_0$  links with the other components  $K_1, \dots, K_k$ , as depicted in the figure. Now, let  $n_k = m_1$  and for  $i = 1, 2, \dots, k-1$ ,  $n_{k-i} = m_{i+1} - m_i$ . We see that  $b_0^{(i)} = T^{n_i} b_0^{(i-1)} + (1 - T^{n_i}) b_i$ , so inductively,

$$b_0^{(k)} = b_k + \sum_{i=1}^k (b_{k-i} - b_{k-i+1}) T^{m_i}.$$

Take  $b_{k-j} = \sum_{i=0}^j c_i$  for  $j = 0, 1, \dots, k-1$  and  $b_0 = 0$ . From these definitions, we see that  $b_{k-i} - b_{k-i+1} = c_i$  for  $i = 1, 2, \dots, k-1$ , and  $-b_1 = -\sum_{i=0}^{k-1} c_i = c_k$ . The right-hand-side of the expression for  $b_0^{(k)}$  is  $h(T)$ . Since  $h(T)$  is equivalent to 0 in  $X$ , we have a coloring  $\mathcal{C}$  of  $L$ . With the 2-cocycle  $\pi^\sharp(\chi_{(0,b_1)})$ , the state-sum term,  $\prod_\tau B(\tau, \mathcal{C})$  is  $t$  to the power at least  $vlk(K_1, K_0)$ , which is not an integer.  $\square$

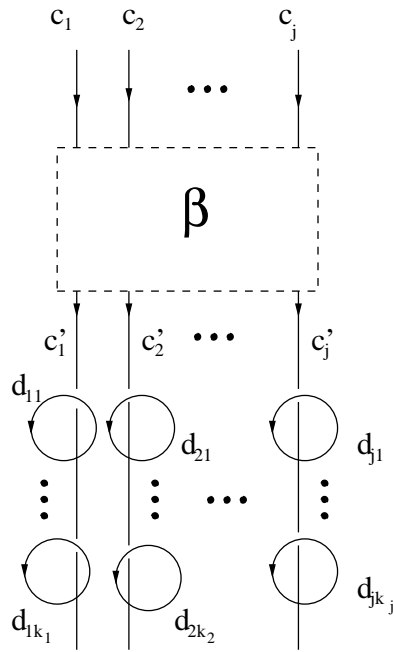

Figure 6: Braids with virtual circles

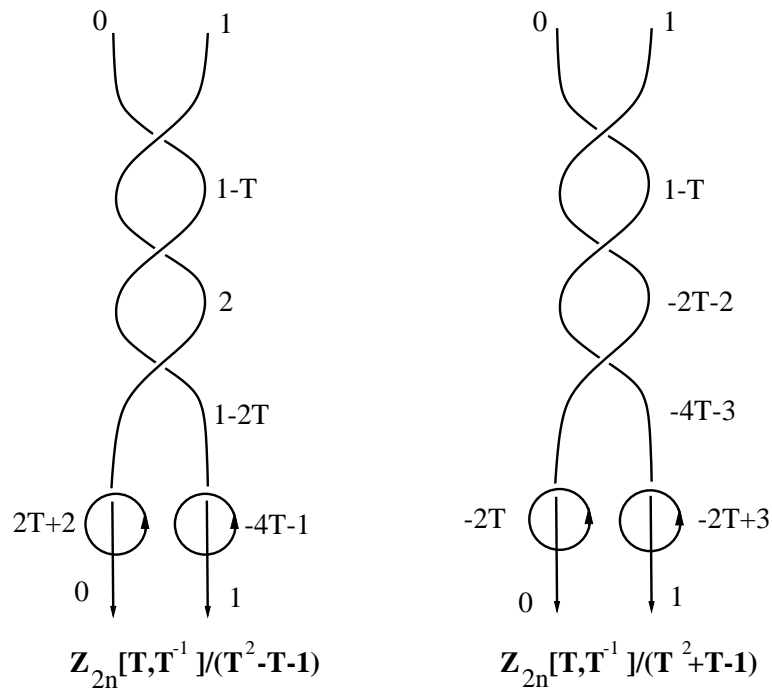

Figure 7: Trefoils with virtual circles

**8.4 Theorem.** *Let  $X$  and  $Y$  be quandles. Suppose there exists  $\pi : X \rightarrow Y$ , a surjective homomorphism that is locally-homogeneous, and there is a link  $L$  and a cocycle  $\phi$  in  $Z_{\mathbb{Q}}^2(Y, G)$  such that  $\Phi_{\phi}(L)$  is non-trivial. Then  $H_{\mathbb{Q}}^2(X, G) \neq 0$ .*

*Proof.* Let  $L$  be the link such that  $\Phi_{\phi}(L)$  is non-trivial (i.e., not an integer). To prove  $H_{\mathbb{Q}}^2(X, G) \neq 0$ , it is sufficient to show that there is a (virtual) link  $K$ , a cocycle  $\psi \in Z_{\mathbb{Q}}^2(X, G)$ , and a color  $\mathcal{C}$  such that  $\prod_{\tau} B(\tau, \mathcal{C})$ , the state-sum term for  $K$  associated to  $\mathcal{C}$ , is not an integer. To construct such a virtual link  $K$  and a color  $\mathcal{C}$ , first start with  $L$  colored by  $Y$ . Note that  $K$  may be considered as the closed form of a  $j$ -strand braid,  $\beta$ , for some  $j \in \mathbf{Z}$ . Since  $\Phi_{\phi}(L)$  is non-trivial, there exists a color  $\mathcal{C}'$  of  $L$  (regarded as a closed braid) such that the state-sum term associated to  $\mathcal{C}'$  is non-trivial. Observe that  $\mathcal{C}'$  can be uniquely represented as a choice of colors  $b_1, b_2, \dots, b_j$  on the initial (top) segments of  $\beta$ . We now start constructing a virtual link  $K$ , and its color  $\mathcal{C}$ . Begin with the braid  $\beta$ , and color it initially (at the top) by  $c_1, c_2, \dots, c_j$ , where  $c_i \in \pi^{-1}(b_i)$  for  $i = 1, 2, \dots, j$ , and extend the color to all the segments of the braid  $\beta$ . Note that since  $\pi$  is a homomorphism, if a segment of  $\beta$  is labeled  $g$  when colored by  $Y$ , the segment will be labeled  $\pi(g)$  when colored by  $X$ . Thus, the terminal ends of  $\beta$ , are colored by  $c'_1, c'_2, \dots, c'_j$ , with the property that  $\pi(c_i) = \pi(c'_i)$  for  $i = 1, 2, \dots, j$ . Since  $\pi$  is locally-homogeneous, there exists a word  $w_i = d_{j_1}^{\epsilon_1} d_{j_2}^{\epsilon_2} \cdots d_{j_{k_i}}^{\epsilon_{k_i}}$  where each  $d_{j_m} \in \pi^{-1}(b_i)$  such that  $c'_i * w_i = c_i$ . For each strand  $i$  of  $\beta$  attach  $k_i$  simple closed loops  $K_{i_1}, K_{i_2}, \dots, K_{i_{k_i}}$  that cross over strand  $i$  and returns via a virtual crossing such that  $vlk(K_{i_m}, K) = \epsilon_m$ , and  $vlk(K, K_{i_m}) = 0$ . See Fig. 6. Color each  $K_{i_m}$  by  $d_{i_m}$ . The closure of the braid with the virtual loops is the virtual link  $K$  we needed. Take  $\psi = \pi^{\sharp}(\phi)$ , and notice that the new crossings created by the added virtual links have trivial state-sum contributions. Hence, the state-sum term of  $K$  for  $\mathcal{C}$  with respect to  $\psi$  is equal to the state-sum term of  $K$  for  $\mathcal{C}'$  with respect to  $\phi$ , and so is non-trivial.  $\square$

Note that for a given link  $L$  and a color  $\mathcal{C}$ , the above argument applies if  $c_j \sim c'_j$  in  $E_{c_j}$  for all  $j$ , even if the condition of being locally-homogeneous is not satisfied.

**8.5 Example.** The trefoil knot has non-trivial invariant with respect to  $S_4$  and the cocycle  $\phi = \chi_{0,1} + \chi_{0,T+1} + \chi_{1,0} + \chi_{1,T+1} + \chi_{T+1,0} + \chi_{T+1,1}$  over  $\mathbf{Z}_2$  where  $S_4 = \mathbf{Z}_2[T, T^{-1}]/(T^2 + T + 1)$  (see [2]). In particular, the color generated by using the braid form  $\sigma_1^2$  with initial colors 0 and 1, gives a state-sum value of  $t$ . From this braid and the above construction, we show that for any  $n \in \mathbf{Z}$ ,  $H_{\mathbb{Q}}^2(\mathbf{Z}_{2n}[T, T^{-1}]/(T^2 - T - 1), \mathbf{Z}_2) \neq 0$  and  $H_{\mathbb{Q}}^2(\mathbf{Z}_{2n}[T, T^{-1}]/(T^2 + T - 1), \mathbf{Z}_2) \neq 0$  using the function  $\pi : X \rightarrow S_4, \pi(x) = x \pmod{2}$ , where  $X$  is the quandle for which we desire the result. For the first case we use virtual loops colored  $2T + 2$  and  $-4T - 1$ , and for the latter case we use loops colored  $-2T$  and  $-2T + 3$ . See Fig.7. Finally note that for the quandle  $\mathbf{Z}_{2n}[T, T^{-1}]/(T^2 - T + 1)$ , the standard trefoil with (in braid form) initial colors 0,1 and the cocycle  $\pi^{\sharp}(\phi)$  colors without need for virtual loops and so  $H_{\mathbb{Q}}^2(\mathbf{Z}_{2n}[T, T^{-1}]/(T^2 - T + 1), \mathbf{Z}_2) \neq 0$ .

In the spirit of the preceding example, we prove the following.

**8.6 Theorem.**  $H_{\mathbb{Q}}^2(\mathbf{Z}_2[T, T^{-1}]/(T^2 + T + 1)^2, \mathbf{Z}_2) \neq 0$ .

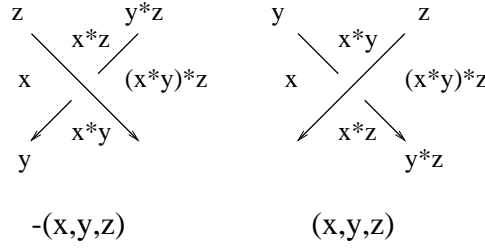

Figure 8: Shadow colorings of crossings

*Proof.* First we describe the virtual knot that we use. Let  $\sigma_1$  denote the standard braid generator in 2-string braid group, and  $v_1$  denote the virtual crossing. Consider  $K_m$  represented by  $(\sigma_1^2 v_1)^m$ . To compute the colors for  $K_m$ , the Burau representation is used, with the matrix  $B = \begin{bmatrix} 0 & T \\ 1 & 1 - T \end{bmatrix}$  replacing  $\sigma$  and the permutation matrix  $P = \begin{bmatrix} 0 & 1 \\ 1 & 0 \end{bmatrix}$  replacing  $p$ . Then if the colors assigned to the top two strings on left and right are  $[a, b]$ , the color assigned to the strings after the sequence  $A$  is computed by the matrix multiplication  $[a, b]A$ .

The matrix corresponding to  $K_3$  is

$$\begin{bmatrix} T - T^3 + T^5 - T^6 & T - T^3 + T^5 \\ 1 - T + T^3 - T^5 + T^6 & 1 - T + T^3 - T^5 \end{bmatrix}.$$

Note that  $(T^2 + T + 1)^2 \bmod 2$  is  $T^4 + T^2 + 1$ , and modulo  $T^4 + T^2 + 1$  the above matrix is equal to the identity. Therefore any assignment for the top two strings define a color on  $K_3$ .

Take for example  $[0, 1]$  as a color on the top two strings. The colors assigned to the two strings right above positive crossings can be computed as above, and they are (starting from the top colors),  $[0, 1]$ ,  $[1, 1 + T]$ ,  $[0, 1 + T]$ ,  $[1 + T, T]$ ,  $[0, T]$ , and  $[T, 1]$ , when reduced mod  $T^2 + T + 1$ . We use the cocycle  $\phi' = \pi^\sharp(\phi)$  where

$$\pi : \mathbf{Z}_2[T, T^{-1}]/(T^2 + T + 1)^2 \rightarrow \mathbf{Z}_2[T, T^{-1}]/(T^2 + T + 1) = S_4$$

is the quotient homomorphism and  $\phi$  is the cocycle described above. Hence the state-sum term for this color with the cocycle  $\phi'$  is  $t^3 = t$  with  $G = \mathbf{Z}_2$  coefficient, a nontrivial value. The result follows.  $\square$

In Fig. 8 a local picture for *shadow colorings of crossings* is given. The regions are colored by quandle elements, as well as over-arcs. If a region is colored by  $x$ , an element of a finite quandle  $X$ , then the adjacent region into which the normal of the arc points is colored by  $x * y$ , where  $y \in X$  is the color of the arc. The arcs are colored using the rule defined before. Figure 8 shows that this rule is well-defined at a crossing. Such crossings represent 3-chains as indicated. If a knot or link diagram is shadow colored by a quandle  $X$ , then the diagram represents a 3-cycle in  $Z_3^R(X)$ . Two isotopic shadow-colored diagrams represent the same homology class. We can use shadow colorings to find non-trivial homology groups as follows.

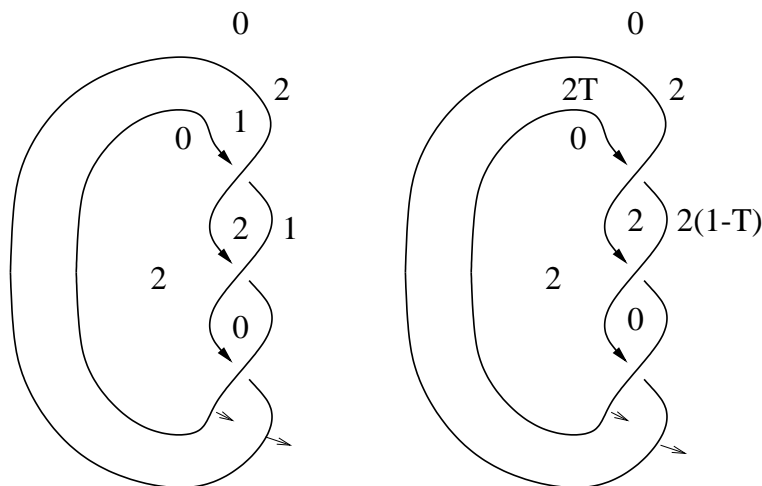

Figure 9: Shadow colors of trefoil

**8.7 Theorem.**  $H_3^R(\mathbf{Z}_3[T, T^{-1}]/(T+1)^2, \mathbf{Z}_3) \neq 0$ .

*Proof.* We use  $\pi : X = \mathbf{Z}_3[T, T^{-1}]/(T+1)^2 \rightarrow R_3$ ,  $\pi(f(T)) = f(-1)$ . On the left of Fig. 9, a shadow color by  $R_3$  of trefoil is depicted, which was used in [13] to show that the left and right handed trefoils are distinct. The diagram on the left of Fig. 9 represents the cycle  $h_0 = (2, 0, 2) + (2, 2, 1) + (2, 1, 0)$ , the class of which is a generator of  $H_3^R(R_3, \mathbf{Z}_3)$ . On the right of Fig. 9, it is shown that the trefoil is also colored nontrivially by elements of  $X$ . Let  $h_1$  be the class in  $H_3^R(X, \mathbf{Z}_3)$  represented by this face color. Then the 3-cycle  $h_1 = (2, 0, 2) + (2, 2, 2(1-T)) + (2, 2(1-T), 0)$  maps to a non-trivial element in  $H_3^R(R_3, \mathbf{Z}_3)$ . Hence  $h_1$  is a non-zero element in  $H_3^R(X, \mathbf{Z}_3)$ .  $\square$

## References

- [1] Brieskorn, E., *Automorphic sets and braids and singularities*, Contemp. Math. 78(1988), 45–115.
- [2] Carter, J.S.; Jelsovsky, D.; Kamada, S.; Langford, L.; Saito, M., *Quandle cohomology and state-sum invariants of knotted curves and surfaces*, preprint at <http://xxx.lanl.gov/abs/math.GT/9903135>.
- [3] Carter, J. Scott, Jelsovsky, Daniel, Kamada, Seiichi, and Saito, Masahico, *Computations of quandle cocycle invariants of knotted curves and surfaces*, preprint at <http://xxx.lanl.gov/abs/math.GT/9906115>.
- [4] Fenn, R.; Rourke, C., *Racks and links in codimension two*, Journal of Knot Theory and Its Ramifications Vol. 1 No. 4 (1992), 343-406.
- [5] Fenn, R.; Rourke, C.; Sanderson, B., *Trunks and classifying spaces*, Appl. Categ. Structures 3 (1995), no. 4, 321–356.

- [6] Fenn, R.; Rourke, C.; Sanderson, B., *James bundles and applications*, preprint at <http://www.maths.warwick.ac.uk/~bjs/>.
- [7] Goussarov, M., Polyak, M., Viro, O., *Finite type invariants of classical and virtual knots*, preprint, posted at <http://xxx.lanl.gov/abs/math.GT/9810073>.
- [8] Flower, Jean, *Cyclic Bordism and Rack Spaces*, Ph.D. Dissertation, Warwick (1995).
- [9] Greene, M. T. *Some Results in Geometric Topology and Geometry*, Ph.D. Dissertation, Warwick (1997).
- [10] Joyce, D., *A classifying invariant of knots, the knot quandle*, J. Pure Appl. Alg., 23 (1982), 37–65.
- [11] Kauffman, Louis, *Virtual knots*, preprint, posted at <http://xxx.lanl.gov/abs/math.GT/9811028>.
- [12] Matveev, S. *Distributive groupoids in knot theory*. (Russian) Mat. Sb. (N.S.) 119(161) (1982), no. 1, 78–88, 160.
- [13] Rourke, C., Sanderson, B., *Twice twist spun trefoils*, talk given at Brighton, posted at <http://www.maths.warwick.ac.uk/~bjs/>