

# Topological Mirror Symmetry.

Mark Gross\*

September 2nd, 1999, *revised* November 2nd, 1999

Mathematics Institute  
University of Warwick  
Coventry, CV4 7AL  
mgross@maths.warwick.ac.uk

## §0. Introduction.

The Strominger-Yau-Zaslow conjecture proposes that mirror symmetry can be explained by the existence, in a mirror pair of Calabi-Yau manifolds, of dual special Lagrangian  $T^n$ -fibrations. (See [19,8,6,7] for further clarification of this conjecture.) Recently, Zharkov in [21] proved that non-singular Calabi-Yau hypersurfaces in toric varieties have topological  $T^n$ -fibrations, and Ruan in [17] has shown further that the quintic threefold has a Lagrangian torus fibration. He in addition announced in that paper an extension of these results to arbitrary Calabi-Yau threefolds which are hypersurfaces in toric varieties. This gives initial evidence for the SYZ conjecture.

In order for the SYZ conjecture to be useful in constructing mirror manifolds, one should be able to produce the mirror manifold by dualizing and compactifying torus fibrations with no a priori knowledge of the mirror manifold. Typically, one expects to start with a fibration  $f : X \rightarrow B$  whose general fibre is a torus, and discriminant locus  $\Delta \subseteq B$  of  $f$  with  $B_0 = B - \Delta$ . One then has a diagram

$$\begin{array}{ccc} X_0 & \hookrightarrow & X \\ \downarrow f_0 & & \downarrow f \\ B_0 & \hookrightarrow & B \end{array}$$

with  $f_0$  being a  $T^n$ -fibre bundle. The dual of  $f_0$  can be described as the torus bundle  $\check{f}_0 : \check{X}_0 = R^1 f_{0*}(\mathbf{R}/\mathbf{Z}) \rightarrow B_0$ . A dual of  $f$  is then a compactification of  $\check{f}_0$  to  $\check{f} : \check{X} \rightarrow B$ . Thus important questions are: *Does there exist a class of torus fibrations for which duals can be constructed? Do these fibrations exist on Calabi-Yau manifolds such as the quintic threefold? If they do, does dualizing produce the mirror?* In this paper we answer these questions affirmatively in the three-dimensional case. This proves that in at least one non-degenerate case, the SYZ conjecture explains mirror symmetry on a topological level.

---

\* Supported in part by NSF grant DMS-9700761

To construct a compactification in some reasonably unique way, one expects that one needs the cohomology of the looked-for singular fibres to be determined by the fibration  $\check{X}_0 \rightarrow B_0$ . More specifically, in [6] and [7] a property called  $G$ -simplicity was introduced. A  $T^n$ -fibration  $f : X \rightarrow B$  is  $G$ -simple, for  $G$  an abelian group, if  $i_* R^p f_{0*} G = R^p f_* G$  for all  $p$ . This essentially says that the cohomology of the singular fibres is determined by the monodromy of the local system  $R^q f_{0*} G$  on  $B_0$ . Without this condition, it would appear to be difficult to construct a dual, and it is certainly difficult to relate the cohomology of  $X$  with that of a dual fibration. By contrast, if  $f : X \rightarrow B$  and  $\check{f} : \check{X} \rightarrow B$  are dual  $\mathbf{R}$ -simple  $T^3$  fibrations, then it was shown in [6] that  $H^{2*}(X, \mathbf{R}) \cong H^3(\check{X}, \mathbf{R})$  and  $H^3(X, \mathbf{R}) \cong H^{2*}(\check{X}, \mathbf{R})$ , the desired relationship of mirror symmetry.

For the fibrations of [17] and [21],  $\Delta$  is codimension one, and then such  $f : X \rightarrow B$  cannot be simple, making it unlikely one can construct the dual of  $f$  in a natural way. Ruan discusses this issue in [17], and points out that it should not be difficult to modify his fibration topologically to obtain one with a codimension two locus. He also announces that he can do this in such a way that the fibration is Lagrangian. This will come a long way towards addressing the above problems. However, the hypothetical fibration he analyzes in [17] in some depth with codimension two discriminant locus is also not simple, because the fibres are not all irreducible. It was argued in [6] that for a generic choice of complex structure all fibres of a special Lagrangian  $T^3$ -fibration would be irreducible. Thus it should be possible to construct a simple torus fibration on the quintic.

In this paper we delve more deeply into the structure of  $T^3$ -fibrations with sufficient regularity hypotheses, similar to the ones assumed in [7]. We call such fibrations “well-behaved”; see Definitions 1.1 and 1.2. These fibrations in particular are  $G$ -simple for  $G = \mathbf{Z}$  and  $\mathbf{Z}/n\mathbf{Z}$ , which prove to be very strong conditions. In §1, we study the local topology of well-behaved fibrations, and focus on what we term *semi-stable* singular fibres, i.e. singular fibres for which the local monodromy group is unipotent. We obtain a classification of possible monodromy groups of such singular fibres, and furthermore give a precise description of the discriminant locus near such fibres. In §2 we use this information to show how to construct well-behaved duals of such fibrations. The main result of §2 is

**Theorem 0.1.** *If  $f : X \rightarrow B$  is a well-behaved  $T^3$ -fibration, with only semi-stable fibres, then  $f$  has a well-behaved dual  $\check{f} : \check{X} \rightarrow B$ .*

This gives a class of  $T^3$ -fibrations whose duals can now be constructed.

§3 is a bit off of the main thrust of the paper. There we give a construction of topological  $T^{n-1} \times \mathbf{R}$ -fibrations on crepant resolutions of  $n$ -dimensional toric Gorenstein

canonical singularities. We make a connection with the local mirror symmetry of [4], and use this construction to motivate some of the choices made in §4, as well as aid in the identification of the mirror quintic.

In §4, we study the specific example of the quintic. We prove the main theorem of the paper:

**Theorem 0.2.** *The quintic threefold  $X \subseteq \mathbf{P}^4$  has a well-behaved  $T^3$ -fibration with semistable fibres  $f : X \rightarrow B$ . If  $\check{f} : \check{X} \rightarrow B$  is the dual fibration given by Theorem 0.1, then  $\check{X}$  is diffeomorphic to a specific non-singular minimal model of the mirror quintic.*

This theorem is proved by first constructing a  $T^3$ -fibrations  $f : X \rightarrow B$  “by hand,” making use of Ruan’s description of monodromy in [17], and then showing  $X$  is diffeomorphic to the quintic using Wall’s classification theory [20]. This classification theory is also applied to show  $\check{X}$  is diffeomorphic to the mirror quintic.

In doing this, we also discover a beautiful geometric explanation for the phenomenon of topology change in mirror symmetry discovered by Aspinwall, Greene and Morrison. In [1], arguments involving calculations of Yukawa couplings at large complex structure limits suggested that birationally equivalent Calabi-Yau threefolds have the same mirror, but correspond to different large complex structure limit points in the complex moduli of the mirror. In general it is conjectured that special Lagrangian fibrations only exist near large complex structure limit points. Thus one might well expect to find two distinct  $T^3$ -fibrations  $f_1 : X \rightarrow B$  and  $f_2 : X \rightarrow B$ , with duals  $\check{f}_1 : \check{X}_1 \rightarrow B$  and  $\check{f}_2 : \check{X}_2 \rightarrow B$ , such that  $\check{X}_1$  and  $\check{X}_2$  are topologically distinct manifolds, perhaps related by a flop. In fact, we will see this explicitly. In defining the  $T^3$ -fibration in the quintic, there will be some ambiguity in the construction which gives rise to distinct fibrations, and whose duals are related by flops.

There are several unsatisfactory aspects to the paper. It will be clear from the constructions of §4 that they should generalize to arbitrary Calabi-Yau hypersurfaces in toric varieties. However, the proof that we have constructed the quintic and the mirror quintic is, at this point, very ad hoc. Applying Wall’s classification result means that one has to identify the cubic intersection forms, and this means much messing about with explicit representatives of cohomology classes and orientations. Before generalising to arbitrary toric hypersurfaces, a more natural proof that the fibrations we have constructed in fact coincide with the desired hypersurfaces should be found. Another point missing is that we make no connections with special Lagrangian geometry, and at this point cannot argue that the fibrations we have constructed actually resemble hypothetical special Lagrangian

fibrations.

Finally, I note that shortly after the first version of this paper was released, Ruan released a paper [18] announcing a proof of existence of Lagrangian  $T^3$ -fibrations on the quintic and mirror quintic which are provably dual to each other via a comparison of monodromy. The technique used is quite different from the one given here, and makes use of a perturbation of the fibrations obtained by Ruan's symplectic flow technique. I expect however that these fibrations coincide with my own on the topological level.

I would like to thank D. Joyce, D. Matessi, M. Micallef and P.M.H. Wilson for useful discussions concerning the SYZ conjecture, and the hospitality of M. Kobayashi at RIMS where part of this work was inspired by a talk of I. Zharkov. I also thank Tenryuji for a key idea.

### §1. Torus Fibrations and Semistable Fibres.

We are interested in studying topological  $T^n$ -fibrations  $f : X \rightarrow B$ , i.e continuous proper maps with connected fibres between topological manifolds whose general fibres are tori. However, without any restrictions on the nature of such a map, there will be no useful theorems one can prove about such fibrations. We begin by giving the restrictions on such fibrations we will use in this paper. These restrictions are motivated by results of [7] on the structure of special Lagrangian fibrations.

**Definition 1.1.** *Let  $f : X \rightarrow B$  be a continuous, proper mapping of topological manifolds with connected fibres,  $\dim X = 2n$ ,  $\dim B = n$ , such that for a dense open set  $B_0 \subseteq B$ , the fibre  $X_b$  is an  $n$ -torus for all  $b \in B_0$ . We say  $f$  is admissible if there exists an open subset  $X^\# \subseteq X$  with  $f^\# : X^\# \rightarrow B$  the restriction of  $f$  to  $X^\#$ ,  $\text{Crit}(f) := X - X^\#$ , satisfying the following properties:*

- (1)  *$\text{Sing}(X_b) := \text{Crit}(f) \cap X_b$  is a union of a finite number of locally closed submanifolds of dimension at most  $n - 2$ , and  $\Delta := f(\text{Crit}(f)) = B - B_0$ .*
- (2) *For each  $b \in B$ , there exists an open neighbourhood  $U \subseteq B$  of  $b$ , a rank  $n$  vector bundle  $\mathcal{F}$  on  $U$ , and an exact sequence*

$$0 \rightarrow (R_c^{n-1} f_* \mathbf{Z})|_U \rightarrow \mathcal{F} \rightarrow f^{\#-1}(U) \rightarrow 0.$$

*Furthermore, the map  $\mathcal{F} \rightarrow f^{\#-1}(U)$  is a local isomorphism.*

- (3)  *$R^n f_* \mathbf{Z} \cong \mathbf{Z}$ .*

The last condition in this definition, besides providing a uniform orientation on fibres (which would be the case for a special Lagrangian fibration), also ensures the singular

fibres are irreducible in a certain sense. We don't expect this to be the case for all special Lagrangian fibrations (for example an elliptic fibration can have reducible fibres) but it was argued in [6] that generically this should be the case for  $n \leq 3$ .

We will also need some regularity assumptions involving the discriminant locus  $\Delta$ , which in dimensions 2 and 3 are encapsulated in

**Definition 1.2.** *Let  $f : X \rightarrow B$  be a  $T^n$ -fibration,  $n = 2$  or  $3$ . Let  $\Delta$  be the discriminant locus of  $f$ . We say  $f$  is well-behaved if it is admissible and either*

- (1)  $n = 2$  and  $\Delta$  is discrete; or,
- (2)  $n = 3$  and  $\Delta$  can be written as a disjoint union of two sets,  $\Delta_g$  and  $\Delta_d$ , where  $\Delta_d$  is a discrete set (the ‘‘dissident’’ points) and  $\Delta_g$  is a locally closed topological 1-submanifold (the ‘‘generic’’ points). For all  $b \in \Delta_g$ , there exists an open neighbourhood  $U$  of  $b \in B$ , a homeomorphism  $\alpha : U \rightarrow D \times (0, 1)$ ,  $D$  a two-dimensional disk, a homeomorphism  $\alpha' : f^{-1}(U) \rightarrow X' \times (0, 1) \times S^1$  with  $X'$  a four-manifold,  $g : X' \rightarrow D$  a well-behaved  $T^2$ -fibration, such that the diagram

$$\begin{array}{ccc} f^{-1}(U) & \xrightarrow{\alpha'} & X' \times (0, 1) \times S^1 \\ \downarrow f & & \downarrow f' \\ U & \xrightarrow{\alpha} & D \times (0, 1) \end{array}$$

is commutative, where  $f'$  is the composition of projection onto  $X' \times (0, 1)$  and  $g \times id$ . Also  $\alpha(\Delta_g \cap U) = \{v\} \times (0, 1)$  for some point  $v \in D$ . Furthermore, for each point  $b \in \Delta_d$ , there is an open neighbourhood  $U$  of  $\Delta_d$  such that there is a commutative diagram

$$\begin{array}{ccc} U - \Delta & \hookrightarrow & U - \Delta_d \\ \downarrow \cong & & \downarrow \cong \\ (S^2 - \{p_1, \dots, p_m\}) \times (0, 1) & \hookrightarrow & S^2 \times (0, 1). \end{array}$$

In addition, there is a five-manifold  $X'$  and a map  $g : X' \rightarrow S^2$  along with a commutative diagram

$$\begin{array}{ccc} f^{-1}(U - \Delta_d) & \xrightarrow{\cong} & X' \times (0, 1) \\ \downarrow f & & \downarrow g \times id \\ U - \Delta_d & \xrightarrow{\cong} & S^2 \times (0, 1). \end{array}$$

Let me emphasize that at this point we do not know that special Lagrangian fibrations are either admissible or well-behaved, but the arguments of [7] §1 and 2 show integral special Lagrangian fibrations are admissible given sufficient regularity assumptions, e.g.  $f$  real analytic. (However, this may be too strong a hypothesis.) On the other hand, the

fibrations we will construct in this paper are well-behaved, so we do not require any further justification of these definitions.

We make the observation that these restrictions are sufficient to prove simplicity.

**Theorem 1.3.** *If  $f : X \rightarrow B$  is a well-behaved  $T^2$ -fibration and  $G$  is an abelian group, then  $f$  is  $G$ -simple. If  $f : X \rightarrow B$  is a well-behaved  $T^3$ -fibration, then  $f$  is  $\mathbf{Z}$ -simple and  $\mathbf{Z}/n\mathbf{Z}$ -simple for all  $n$ .*

Proof. As remarked at the beginning of [7], §3,  $f_*G = G$  since the fibres of  $f$  are connected, and  $R^n f_*G = G$  follows from Definition 1.1, (3). Thus  $i_*R^p f_{0*}G = R^p f_*G$  for  $p = 0, n$ , where  $i : B - \Delta \rightarrow B$  is the inclusion. For  $p = 1$ , this follows from [7], Theorem 3.3, where it can be checked that the conditions of well-behaved are sufficient for the proof of that theorem in [7] to work. Thus, in particular, a well-behaved  $T^2$ -fibration is  $G$ -simple.

Furthermore, the proof of [7] Theorem 3.5 also applies to well-behaved  $T^3$ -fibrations, and thus such  $f$  are  $\mathbf{Z}$ -simple. To show  $f$  is  $\mathbf{Z}/n\mathbf{Z}$ -simple, we still need to show that  $i_*R^2 f_{0*}\mathbf{Z}/n\mathbf{Z} = R^2 f_*\mathbf{Z}/n\mathbf{Z}$ . The proof of [7], Theorem 3.5, and especially Lemma 3.4, does not carry over to the coefficient group  $\mathbf{Z}/n\mathbf{Z}$ . Thus a different proof must be given.

Let  $i_0 : B - \Delta_d \rightarrow B$  be the inclusion. We first need to show the equivalent of [7], Lemma 3.4, namely that

$$R^2 f_*\mathbf{Z}/n\mathbf{Z} \cong i_{0*}i_0^*R^2 f_*\mathbf{Z}/n\mathbf{Z}.$$

Let  $b_0 \in \Delta_d$ , and let  $U \subseteq B$  be an open neighbourhood of  $b_0$  as given in Definition 1.2. Thus  $U - \{b_0\} \cong S^2 \times (0, 1)$ ,  $f^{-1}(U - \{b_0\}) \cong X' \times (0, 1)$ , and the map  $f$  is induced by  $g : X' \rightarrow S^2$ . Put  $X^* = f^{-1}(U - \{b_0\})$ . Using the relative cohomology exact sequence, the fact that  $H^i(f^{-1}(U), \mathbf{Z}) \cong H^i(X_{b_0}, \mathbf{Z})$ , and  $H_{X_{b_0}}^i(f^{-1}(U), \mathbf{Z}) = H_{6-i}(X_{b_0}, \mathbf{Z})$ , one sees that

$$(1.1) \quad H^i(X^*, \mathbf{Z}) = \begin{cases} \mathbf{Z} & i = 0, 5 \\ \mathbf{Z}^{b_1} & i = 1, 4 \\ \mathbf{Z}^{b_2+1} & i = 2, 3, \end{cases}$$

where  $b_i = \text{rank } H^i(X_{b_0}, \mathbf{Z})$ . The only part of this calculation which requires comment is  $i = 2$  and  $3$ . Here we have a commutative diagram

$$\begin{array}{ccccccc} & & H^2(U - \{p\}, \mathbf{Z}) & \xrightarrow{\alpha'} & H_p^3(U, \mathbf{Z}) = \mathbf{Z} & & \\ & & \downarrow & & \downarrow \beta & & \\ 0 & \longrightarrow & H^2(f^{-1}(U), \mathbf{Z}) & \longrightarrow & H_{X_b}^3(f^{-1}(U), \mathbf{Z}) = \mathbf{Z} & \xrightarrow{\alpha} & \\ & & H^2(f^{-1}(U - \{p\}), \mathbf{Z}) & & & & \end{array}$$

Since  $\alpha'$  and  $\beta$  are isomorphisms,  $\alpha$  is surjective.

While we will need to make use of this full calculation later in the paper, the only part we need now is the conclusion that  $H^*(X^*, \mathbf{Z})$  is torsion-free, and so  $H^*(X^*, \mathbf{Z}/n\mathbf{Z}) = H^*(X^*, \mathbf{Z}) \otimes \mathbf{Z}/n\mathbf{Z}$ .

Now look at the Leray spectral sequence for  $f : X^* \rightarrow B^* = U - \{p\}$ , with coefficients in  $\mathbf{Z}$ . This looks like

$$\begin{array}{ccccc} & \mathbf{Z} & & 0 & & \mathbf{Z} \\ H^0(B^*, R^2 f_* \mathbf{Z}) & & H^1(B^*, R^2 f_* \mathbf{Z}) & & H^2(B^*, R^2 f_* \mathbf{Z}) \\ H^0(B^*, R^1 f_* \mathbf{Z}) & & H^1(B^*, R^1 f_* \mathbf{Z}) & & H^2(B^*, R^1 f_* \mathbf{Z}) \\ & \mathbf{Z} & & 0 & & \mathbf{Z} \end{array}$$

Admissible fibrations have local sections, so we can assume that  $f : X^* \rightarrow B^*$  has a section. Then standard arguments as in [6], Lemma 2.4 show that the only possible non-zero differential is  $d : H^0(B^*, R^2 f_* \mathbf{Z}) \rightarrow H^2(B^*, R^1 f_* \mathbf{Z})$ . However, in the proof of [7], Lemma 3.4, it was shown that  $H^2(X^*, \mathbf{Z}) \rightarrow H^0(B^*, R^2 f_* \mathbf{Z})$  was surjective, and hence  $d$  is zero. Thus the spectral sequence degenerates at the  $E_2$  term. In particular,  $H^2(B^*, R^i f_* \mathbf{Z})$  is torsion-free since  $H^{i+2}(X^*, \mathbf{Z})$  is torsion-free.

Now suppose that  $H^1(B^*, R^2 f_* \mathbf{Z})$  were not torsion-free. First note that because of the product structure of the map  $X^* \rightarrow B^*$ ,  $H^i(B^*, R^j f_* \mathbf{Z}) \cong H^i(S^2, R^j g_* \mathbf{Z})$ . We can then use Poincaré-Verdier duality to compare  $H^1(S^2, R^2 g_* \mathbf{Z})_{tors}$  with  $H^2(S^2, R^1 g_* \mathbf{Z})_{tors}$ . By  $\mathbf{Z}$ -simplicity,  $\underline{\text{Hom}}(R^1 g_* \mathbf{Z}, \mathbf{Z}) \cong R^2 g_* \mathbf{Z}$ , and thus by the local-global Ext spectral sequence,  $H^1(S^2, R^2 g_* \mathbf{Z})$  injects into  $\text{Ext}^1(R^1 g_* \mathbf{Z}, \mathbf{Z})$ , which in turn, by Poincaré-Verdier duality (as applied in the proof of [7] Theorem 3.9, see especially (3.2) there), is isomorphic to a  $\mathbf{Z}$ -module  $M$  fitting in the exact sequence

$$0 \rightarrow \text{Ext}^1(H^2(S^2, R^1 g_* \mathbf{Z}), \mathbf{Z}) \rightarrow M \rightarrow \text{Hom}(H^1(S^2, R^1 g_* \mathbf{Z}), \mathbf{Z}) \rightarrow 0.$$

Thus, if  $H^1(S^2, R^2 g_* \mathbf{Z})$  contains torsion, so does  $M$ , and hence so does  $H^2(S^2, R^1 g_* \mathbf{Z}) \cong H^2(B^*, R^1 f_* \mathbf{Z})$ , contradicting the torsion-freeness of this  $\mathbf{Z}$ -module. Thus  $H^1(B^*, R^2 f_* \mathbf{Z})$  is torsion-free. It then follows from the exact sequence

$$0 \rightarrow R^2 f_* \mathbf{Z} \xrightarrow{\cdot n} R^2 f_* \mathbf{Z} \rightarrow R^2 f_* \mathbf{Z}/n\mathbf{Z} \rightarrow 0$$

that  $H^0(B^*, R^2 f_* \mathbf{Z}/n\mathbf{Z}) = H^0(B^*, R^2 f_* \mathbf{Z}) \otimes \mathbf{Z}/n\mathbf{Z}$ . Since the restriction map

$$H^2(X_b, \mathbf{Z}) \cong H^0(U, R^2 f_* \mathbf{Z}) \rightarrow H^0(B^*, R^2 f_* \mathbf{Z})$$

is an isomorphism by  $\mathbf{Z}$ -simplicity, it then follows that the map

$$H^2(X_b, \mathbf{Z}/n\mathbf{Z}) \cong H^0(U, R^2 f_* \mathbf{Z}/n\mathbf{Z}) \rightarrow H^0(B^*, R^2 f_* \mathbf{Z}/n\mathbf{Z})$$

is an isomorphism, so that  $i_{0*}i_0^*R^2f_*\mathbf{Z}/n\mathbf{Z} = R^2f_*\mathbf{Z}/n\mathbf{Z}$ .

Finally, to show  $\mathbf{Z}/n\mathbf{Z}$ -simplicity, we have to show that if  $i_1 : B - \Delta \hookrightarrow B - \Delta_d$ , then the natural map

$$(R^2f_*\mathbf{Z}/n\mathbf{Z})|_{B-\Delta_d} \xrightarrow{\phi} i_{1*}i_1^*R^2f_*\mathbf{Z}/n\mathbf{Z}$$

is an isomorphism. The kernel of  $\phi$  is  $\underline{H}_{\Delta_g}^0(B - \Delta_d, R^2f_*\mathbf{Z}/n\mathbf{Z}) = 0$ , since  $\underline{H}_{\Delta_g}^i(B - \Delta_d, R^2f_*\mathbf{Z}) = 0$  for  $i = 0, 1$ , by  $\mathbf{Z}$ -simplicity. The cokernel of  $\phi$  is

$$\underline{H}_{\Delta_g}^1(B - \Delta_d, R^2f_*\mathbf{Z}/n\mathbf{Z}) = \ker(\underline{H}_{\Delta_g}^2(B - \Delta_d, R^2f_*\mathbf{Z}) \xrightarrow{\cdot n} \underline{H}_{\Delta_g}^2(B - \Delta_d, R^2f_*\mathbf{Z})).$$

Thus to show this is zero for any  $n$ , it is enough to show it for  $n$  prime.

To show this, we take a point  $b_0 \in \Delta_g$ , and  $\gamma$  a simple loop around  $b_0$  based at a nearby point  $b$ . Let  $T : H^2(X_b, \mathbf{Z}/n\mathbf{Z}) \rightarrow H^2(X_b, \mathbf{Z}/n\mathbf{Z})$  be the induced monodromy transformation. The map  $\phi$  on stalks at  $b_0$  is

$$H^2(X_{b_0}, \mathbf{Z}/n\mathbf{Z}) \rightarrow H^2(X_b, \mathbf{Z}/n\mathbf{Z})^T.$$

The map is injective, so we just need to show  $\dim H^2(X_b, \mathbf{Z}/n\mathbf{Z})^T = \dim H^2(X_{b_0}, \mathbf{Z}/n\mathbf{Z})$ . But  $\ker T^t - I = H^1(X_{b_0}, \mathbf{Z}/n\mathbf{Z})$ , and since  $X_{b_0} = X'_{b_0} \times S^1$ ,  $H^1(X_{b_0}, \mathbf{Z}/n\mathbf{Z})$  is the same dimension as  $H^2(X_{b_0}, \mathbf{Z}/n\mathbf{Z})$  by Künneth, so  $\dim \ker(T - I) = \dim \ker(T^t - I) = \dim H^1(X_{b_0}, \mathbf{Z}/n\mathbf{Z}) = \dim H^2(X_{b_0}, \mathbf{Z}/n\mathbf{Z})$ , as desired. •

We now show how simplicity enables one to obtain strong restrictions on monodromy about singular fibres in torus fibrations.

**Theorem 1.4.** *Let  $f : X \rightarrow B$  be a well-behaved  $T^2$ -fibration,  $b_0 \in \Delta \subseteq B$ ,  $b$  a nearby point, and  $T : H_1(X_b, \mathbf{Z}) \rightarrow H_1(X_b, \mathbf{Z})$  the monodromy transformation about a simple loop around  $b_0$  based at  $b$ . Then there is a basis  $e_1, e_2$  of  $H_1(X_b, \mathbf{Z})$  in which  $T = \begin{pmatrix} 1 & 1 \\ 0 & 1 \end{pmatrix}$ ,  $\begin{pmatrix} 0 & -1 \\ 1 & 1 \end{pmatrix}$  or  $\begin{pmatrix} 0 & -1 \\ 1 & 3 \end{pmatrix}$ . In the first case, the singular fibre is of type  $I_1$  (by which we mean the one-point compactification of  $S^1 \times \mathbf{R}$ ), while in the second and third cases the singular fibre is topologically an  $S^2$ .*

*Proof.* By simplicity,  $H_1(X_b, \mathbf{Z})^T = H_1(X_{b_0}, \mathbf{Z})$ , and since  $X_{b_0}$  is a singular fibre,  $\text{rank } H_1(X_{b_0}, \mathbf{Z}) = 0$  or  $1$ . Note that since  $\text{Sing}(X_{b_0})$  is connected (as can be shown by the same argument as in Lemma 2.5 of [7]),  $\text{Sing}(X_{b_0})$  consists of one point, and so  $X_{b_0}$  is just the one point compactification of  $X_{b_0}^\#$ . Since  $X_{b_0}^\# \cong \mathbf{R}^2/H_1(X_{b_0}^\#, \mathbf{Z})$ , this compactification is either an  $I_1$  fibre or  $S^2$ , topologically.



*Case 1.*  $\text{rank } H_1(X_{b_0}, \mathbf{Z}) = 1$ . Then  $\text{rank ker } T - I = 1$ , and choosing a basis  $e_1, e_2$  with  $e_1$  invariant yields  $T = \begin{pmatrix} 1 & a \\ 0 & 1 \end{pmatrix}$  (using also the fact that  $T \in SL_2(\mathbf{Z})$ ). Now by  $\mathbf{Z}/n\mathbf{Z}$ -simplicity,  $H_1(X_b, \mathbf{Z}/n\mathbf{Z})^{T^n} = H_1(X_{b_0}, \mathbf{Z}/n\mathbf{Z}) = \mathbf{Z}/n\mathbf{Z}$ , where  $T_n \in SL_2(\mathbf{Z}/n\mathbf{Z})$  is  $T \bmod n$ . Thus  $\text{rank ker } T_n - I = 1$  for all  $n \geq 2$ , and in particular  $a = \pm 1$ . Changing the sign of  $e_2$  if necessary, we obtain the first matrix. In this case the compactification is an  $I_1$  type fibre.

*Case 2.*  $H_1(X_{b_0}, \mathbf{Z}) = 0$ . In this case, there are no invariant vectors modulo  $n$ , so in particular  $T$  does not have the eigenvalue 1 modulo any  $n$ . Now the characteristic polynomial of  $T$  is  $f(x) = x^2 - \text{Tr}(T)x + 1$ , and we require  $f(1) \not\equiv 0 \pmod n$  for any  $n \geq 2$ . Thus  $f(1) = 2 - \text{Tr}(T) = \pm 1$ , or  $\text{Tr}(T) = 1$  or  $3$ .

First assume  $\text{Tr}(T) = 1$ . Then  $\mathbf{Z}[T] = \mathbf{Z}[(1 + \sqrt{-3})/2]$ , which is a PID. Thus  $H_1(X_b, \mathbf{Z})$  is a free  $\mathbf{Z}[T]$  module, and hence is  $H_1(X_b, \mathbf{Z}) = \mathbf{Z}[T]e_1$  for some  $e_1 \in H_1(X_b, \mathbf{Z})$ . Let  $e_2 = Te_1$ . Then  $e_1, e_2$  form a basis for  $H_1(X_b, \mathbf{Z})$ , and in this basis the matrix for  $T$  is  $\begin{pmatrix} 0 & -1 \\ 1 & 1 \end{pmatrix}$  as desired.

Next, suppose  $\text{Tr}(T) = 3$ . Then  $\mathbf{Z}[T] = \mathbf{Z}[(1 + \sqrt{5})/2]$ , the number ring of  $\mathbf{Q}(\sqrt{5})$ . This is also a PID, so the same argument allows us to find a basis in which  $T = \begin{pmatrix} 0 & -1 \\ 1 & 3 \end{pmatrix}$ . In both these cases,  $X_{b_0}$  is topologically a sphere. •

*Remark 1.5.* It does not seem possible to rule out the last matrix in Theorem 1.4 using only topological means, as such a topological fibration appears to exist. Of course, it does not occur in the elliptic curve case, or equivalently the special Lagrangian case.

We now move on to the three-dimensional case.

**Definition 1.6.** Let  $f : X \rightarrow B$  be a well-behaved  $T^3$ -fibration,  $b_0 \in \Delta$  a point. The monodromy group of  $f$  at  $b_0$  is the image of  $\pi_1(U - \Delta, b) \rightarrow SL(H_1(X_b, \mathbf{Z}))$ , where  $U$  is an open neighbourhood of  $b_0$  as given in Definition 1.2, and  $b \in U$  a base point.

**Theorem 1.7.** Let  $f : X \rightarrow B$  be a well-behaved  $T^3$ -fibration. If  $b_0 \in \Delta_g$ , then  $X_{b_0}$  is homeomorphic to  $I_1 \times S^1$  or  $S^2 \times S^1$ . There is a basis of  $H_1(X_b, \mathbf{Z})$  for  $b$  near  $b_0$  in which the monodromy group is generated by  $\begin{pmatrix} 1 & 1 & 0 \\ 0 & 1 & 0 \\ 0 & 0 & 1 \end{pmatrix}$ ,  $\begin{pmatrix} 0 & -1 & 0 \\ 1 & 1 & 0 \\ 0 & 0 & 1 \end{pmatrix}$ , or  $\begin{pmatrix} 0 & -1 & 0 \\ 1 & 3 & 0 \\ 0 & 0 & 1 \end{pmatrix}$ .

Proof. This follows immediately from the definition of well-behaved and Theorem 1.4.

•

**Definition 1.8.** Let  $f : X \rightarrow B$  be a well-behaved  $T^3$ -fibration. Let  $b_0 \in B$  be a point in the discriminant locus  $\Delta$  of  $f$ . We say  $X_{b_0}$  is semistable if the monodromy group at  $b_0$  is unipotent.

This terminology is in analogy with terminology for elliptic curves.

**Definition 1.9.** Let  $f : X \rightarrow B$  be a well-behaved  $T^3$ -fibration,  $b_0 \in B$ . We say the fibre  $X_{b_0}$  is of type  $(b_1, b_2)$  if  $b_i = \text{rank } H^i(X_{b_0}, \mathbf{Z})$ ,  $i = 1, 2$ .

**Theorem 1.10.** Let  $f : X \rightarrow B$  be a well-behaved  $T^3$ -fibration, and let  $b_0 \in \Delta$  with  $X_{b_0}$  be a semistable fibre with monodromy group  $G$ . Then either

(1)  $X_{b_0}$  is of type  $(2, 2)$  and  $G$  is conjugate to

$$\left\{ \left( \begin{array}{ccc} 1 & 0 & a \\ 0 & 1 & 0 \\ 0 & 0 & 1 \end{array} \right) \middle| a \in \mathbf{Z} \right\}.$$

(2)  $X_{b_0}$  is of type  $(2, 1)$  and  $G$  is conjugate to

$$\left\{ \left( \begin{array}{ccc} 1 & a & b \\ 0 & 1 & 0 \\ 0 & 0 & 1 \end{array} \right) \middle| a, b \in \mathbf{Z} \right\}.$$

(3)  $X_{b_0}$  is of type  $(1, 2)$  and  $G$  is conjugate to

$$\left\{ \left( \begin{array}{ccc} 1 & 0 & a \\ 0 & 1 & b \\ 0 & 0 & 1 \end{array} \right) \middle| a, b \in \mathbf{Z} \right\}.$$

(4)  $X_{b_0}$  is of type  $(1, 1)$  and  $G$  is conjugate to

$$\left\{ \left( \begin{array}{ccc} 1 & a & b \\ 0 & 1 & c \\ 0 & 0 & 1 \end{array} \right) \middle| a, b, c \in \mathbf{Z} \right\}.$$

Proof. Let  $b$  be a base-point near  $b_0$ . By the theorem of 17.5 of [12],  $H_1(X_b, \mathbf{C})$  contains an element invariant under  $G$ , and thus  $b_2(X_{b_0}) \geq 1$ . In particular, there is a  $G$ -invariant  $e_1 \in H_1(X_b, \mathbf{Z})$ . Applying the theorem again to  $H_1(X_b, \mathbf{C})/\mathbf{C}e_1$ , one finds a two dimensional subspace  $V \subseteq H_1(X_b, \mathbf{C})$  containing  $e_1$ , and invariant under  $G$ . Thus  $V$  yields an invariant element of  $\bigwedge^2 H_1(X_b, \mathbf{C})$ . Since  $H_2(X_b, \mathbf{C}) \cong \bigwedge^2 H_1(X_b, \mathbf{C})$ ,  $H_2(X_b, \mathbf{C})^G = H^1(X_b, \mathbf{C})^G \neq 0$ , so  $b_1(X_{b_0}) \neq 0$ . Furthermore, some element of  $H_2(X_b, \mathbf{Z})^G$  is of the form

$e_1 \wedge e_2$  for some  $e_2$  such that  $e_1, e_2$  span a primitive sublattice of  $H_1(X_b, \mathbf{Z})$ . Choosing  $e_3$  so that  $e_1, e_2, e_3$  span  $H_1(X_b, \mathbf{Z})$  we see that in this basis  $G$  is a subgroup of

$$G' = \left\{ \left( \begin{array}{ccc} 1 & a & b \\ 0 & 1 & c \\ 0 & 0 & 1 \end{array} \right) \middle| a, b, c \in \mathbf{Z} \right\}.$$

In particular,  $b_1(X_{b_0}), b_2(X_{b_0}) > 0$ , so only the types listed can occur. (It was shown in [7], §3, that  $b_i(X_{b_0}) = 3$  for  $i = 1$  or  $2$  implies  $X_{b_0}$  is non-singular.)

For  $X_{b_0}$  of type (2, 2), we can choose  $e_1$  and  $e_2$  to be a basis of the invariant cycles of  $H_1(X_b, \mathbf{Z})$  so that  $G$  is in fact contained in

$$H = \left\{ \left( \begin{array}{ccc} 1 & 0 & a \\ 0 & 1 & b \\ 0 & 0 & 1 \end{array} \right) \middle| a, b \in \mathbf{Z} \right\} \cong \mathbf{Z}^2.$$

$G$  is then a subgroup of  $H$ . Since  $G$  acts on  $H_2(X_b, \mathbf{Z}) \cong H_1(X_b, \mathbf{Z})^\vee$  via the transpose inverse matrices, we see the fact that  $H_2(X_b, \mathbf{Z})^G \cong \mathbf{Z}^2$  implies that  $G \cong \mathbf{Z} \subseteq \mathbf{Z}^2$ , i.e. is generated by some matrix  $T = \begin{pmatrix} 1 & 0 & a \\ 0 & 1 & b \\ 0 & 0 & 1 \end{pmatrix}$ . If  $n = \gcd(a, b) \neq 1$ , then  $T \equiv I \pmod{n}$ , violating  $\mathbf{Z}/n\mathbf{Z}$ -simplicity. Thus  $a$  and  $b$  are relatively prime, and a change of basis gives the desired form for  $G$ .

For type (1, 2),  $e_1$  and  $e_2$  are again chosen to be invariant as above, but now  $G \subseteq H$  must be a sublattice of rank 2 to ensure  $H_2(X_b, \mathbf{Z})^G \cong \mathbf{Z}$ . Let  $T_1 = \begin{pmatrix} 1 & 0 & a \\ 0 & 1 & b \\ 0 & 0 & 1 \end{pmatrix}$ ,  $T_2 =$

$\begin{pmatrix} 1 & 0 & c \\ 0 & 1 & d \\ 0 & 0 & 1 \end{pmatrix}$  be generators of this sublattice. Let  $e_1^*, e_2^*, e_3^*$  be the dual basis to  $e_1, e_2, e_3$ . From  $\mathbf{Z}/n\mathbf{Z}$ -simplicity it follows that  $H_2(X_b, \mathbf{Z}/n\mathbf{Z})^G = (\mathbf{Z}/n\mathbf{Z}) \cdot e_3^*$  for all  $n$ , hence modulo  $n$ , the kernel of the matrix  $\begin{pmatrix} a & b \\ c & d \end{pmatrix}$  is always zero. Thus  $\det \begin{pmatrix} a & b \\ c & d \end{pmatrix} \not\equiv 0 \pmod{n}$  for any  $n$ , so  $\det \begin{pmatrix} a & b \\ c & d \end{pmatrix} = \pm 1$ . Thus  $T_1$  and  $T_2$  generate  $H$ , as desired.

The argument for type (2, 1) is identical, interchanging the roles of  $H_1(X_b, \mathbf{Z})$  and  $H_2(X_b, \mathbf{Z})$ .

Finally, if  $X_{b_0}$  is type (1, 1), then  $G$  must be generated by transformations  $T_1, \dots, T_n$  where  $T_i$  is the monodromy transformation about a curve in  $\Delta_g$ , and hence, being unipotent, is conjugate to  $\begin{pmatrix} 1 & 1 & 0 \\ 0 & 1 & 0 \\ 0 & 0 & 1 \end{pmatrix}$ , by Theorem 1.7. If  $T_i$  is written in the basis  $e_1, e_2, e_3$

so that  $G \subseteq G'$ , then  $T_i = \begin{pmatrix} 1 & a_i & b_i \\ 0 & 1 & c_i \\ 0 & 0 & 1 \end{pmatrix}$  for some  $a_i, b_i, c_i \in \mathbf{Z}$ . However the requirement that  $\text{rank ker } T_i - I = 2$  guarantees that either  $a_i = 0$  or  $c_i = 0$  for each  $i$ . If  $a_i = 0$  for all  $i$ , then we must in fact be in the  $(1, 2)$  case; similarly, if  $c_i = 0$  for all  $i$ , then we must be in the  $(2, 1)$  case.

Now the group  $G'$  is in fact a central extension

$$0 \longrightarrow \mathbf{Z} \longrightarrow G' \xrightarrow{\psi} \mathbf{Z}^2 \longrightarrow 0,$$

where  $\psi \begin{pmatrix} 1 & a & b \\ 0 & 1 & c \\ 0 & 0 & 1 \end{pmatrix} = (a, c)$  (in fact  $G'$  is the Heisenberg group over  $\mathbf{Z}$ ). What we have now shown is that in the  $(1, 1)$  case  $\psi(G)$  must be a rank 2 sublattice generated by  $(a_0, 0)$  and  $(0, c_0)$  for some  $a_0, c_0 \in \mathbf{Z}$ . Furthermore,  $a_0 = \pm 1$  and  $c_0 = \pm 1$ , as can be seen via  $\mathbf{Z}/n\mathbf{Z}$  simplicity. Thus  $G$  contains elements of the form  $\begin{pmatrix} 1 & 1 & b_1 \\ 0 & 1 & 0 \\ 0 & 0 & 1 \end{pmatrix}$  and  $\begin{pmatrix} 1 & 0 & b_2 \\ 0 & 1 & 1 \\ 0 & 0 & 1 \end{pmatrix}$ . But these two elements generate  $G'$ , so  $G = G'$  as desired. •

Next we give a more detailed structure result. If  $b_0 \in \Delta_d$  is a dissident point, and  $U \subseteq B$  the open neighbourhood of  $b_0$  promised by Definition 1.2, we can write  $U - \Delta = (S^2 - \{p_1, \dots, p_n\}) \times (0, 1)$ . Take as generators of  $\pi_1(U - \Delta, b)$   $n$  loops  $\gamma_1, \dots, \gamma_n$  in  $S^2 \times \{1/2\}$  around the points  $p_1, \dots, p_n$  oriented so that  $\gamma_1 \cdots \gamma_n = 1$  in  $\pi_1(U - \Delta, b)$ . Let  $T_1, \dots, T_n$  be the corresponding monodromy transformations in  $SL(H_1(X_b, \mathbf{Z}))$ . Using this notation, we have

**Theorem 1.11.** *Let  $f : X \rightarrow B$  be a well-behaved  $T^3$ -fibration,  $b_0 \in \Delta_d$ , with  $X_{b_0}$  a semi-stable fibre,  $U, T_1, \dots, T_n$  as above. Then*

(1) *If  $X_{b_0}$  is of type  $(2, 2)$ , then  $n = 2$  and in a suitable basis,  $T_1 = \begin{pmatrix} 1 & 0 & 1 \\ 0 & 1 & 0 \\ 0 & 0 & 1 \end{pmatrix}$  and  $T_2 = T_1^{-1}$ .*

(2) *If  $X_{b_0}$  is of type  $(1, 2)$  or  $(2, 1)$ , then  $n = 3$  and in a suitable basis,  $T_1 = \begin{pmatrix} 1 & 0 & 1 \\ 0 & 1 & 0 \\ 0 & 0 & 1 \end{pmatrix}$ ,  $T_2 = \begin{pmatrix} 1 & 0 & 0 \\ 0 & 1 & 1 \\ 0 & 0 & 1 \end{pmatrix}$  and  $T_3 = \begin{pmatrix} 1 & 0 & -1 \\ 0 & 1 & -1 \\ 0 & 0 & 1 \end{pmatrix}$  in the  $(1, 2)$  case, and the transpose of these matrices in the  $(2, 1)$  case.*

(3) *If  $X_{b_0}$  is a fibre of type  $(1, 1)$ , then  $n = 4$ . Furthermore, in a suitable basis, possibly*

after relabelling the  $p_i$ 's,  $T_1 = \begin{pmatrix} 1 & 1 & 0 \\ 0 & 1 & 0 \\ 0 & 0 & 1 \end{pmatrix}$ ,  $T_2 = \begin{pmatrix} 1 & 0 & 0 \\ 0 & 1 & 1 \\ 0 & 0 & 1 \end{pmatrix}$ ,  $T_3 = \begin{pmatrix} 1 & -1 & a \\ 0 & 1 & 0 \\ 0 & 0 & 1 \end{pmatrix}$ ,

and  $T_4 = \begin{pmatrix} 1 & 0 & -a-1 \\ 0 & 1 & -1 \\ 0 & 0 & 1 \end{pmatrix}$ .

Proof. Let  $U \subseteq B$  be the open neighbourhood of  $b_0 \in \Delta_d$  as above, with  $f^{-1}(U - \{b_0\}) \cong X' \times (0, 1)$ . Then  $H^i(X', \mathbf{Z}) = H^i(f^{-1}(U - \{b_0\}), \mathbf{Z})$ , which was computed in the proof of Theorem 1.3, with the result given in (1.1).

We next study the Leray spectral sequence for  $g : X' \rightarrow S^2$ ,  $H^i(S^2, R^j g_* \mathbf{Q}) \Rightarrow H^n(X', \mathbf{Q})$ . This was shown in the proof of Theorem 1.3 to degenerate at the  $E_2$ -term even with coefficients in  $\mathbf{Z}$ . In addition, I claim the  $E_2$  term looks like

$$\begin{array}{ccc} \mathbf{Q} & 0 & \mathbf{Q} \\ \mathbf{Q}^{b_2} & 0 & \mathbf{Q}^{b_1} \\ \mathbf{Q}^{b_1} & 0 & \mathbf{Q}^{b_2} \\ \mathbf{Q} & 0 & \mathbf{Q} \end{array}$$

First, note that  $H^0(S^2, R^i g_* \mathbf{Q}) = H^0(f^{-1}(U), R^i f_* \mathbf{Q}) = H^i(X_b, \mathbf{Q})$ , giving the first column. The third column then follows from Poincaré-Verdier duality  $\text{Ext}^0(R^i g_* \mathbf{Q}, \mathbf{Q}) \cong H^2(S^2, R^i g_* \mathbf{Q})^\vee$ . From the knowledge of  $H^i(X', \mathbf{Q})$  as given in (1.1), and the degeneration of the  $E_2$  term, it follows that the middle column is indeed zero.

Now let  $\mathcal{F} = R^2 g_* \mathbf{Q}$  in the (1, 2) or (2, 2) cases and  $\mathcal{F} = R^1 g_* \mathbf{Q}$  in the (2, 1) case, so that  $\mathcal{F}$  has  $\mathbf{Q}^2$  as a subsheaf. We in fact have an exact sequence

$$0 \rightarrow \mathbf{Q}^2 \rightarrow \mathcal{F} \rightarrow \mathbf{Q}_V \rightarrow 0,$$

where  $V = S^2 - \{p_1, \dots, p_n\}$ , and  $\mathbf{Q}_V$  is the sheaf  $\mathbf{Q}$  on  $V$  extended by zero outside of  $V$ . Now  $H^i(S^2, \mathbf{Q}_V) = H_c^i(V, \mathbf{Q})$ , so we see that

$$\chi(S^2, \mathcal{F}) = \chi(S^2, \mathbf{Q}^2) + \chi(S^2, \mathbf{Q}_V) = 4 + (2 - n) = 6 - n.$$

Now in the (2, 2) case,  $\chi(S^2, \mathcal{F}) = b_1 + b_2 = 4$ , so  $n = 2$ , and the description of the monodromy is then clear. In the (1, 2) or (2, 1) case,  $\chi(S^2, \mathcal{F}) = b_1 + b_2 = 3$ , so  $n = 3$ . Since  $T_1 T_2 T_3 = I$ , we see  $T_1$  and  $T_2$  must generate the monodromy group, and it then follows from Theorem 1.10 that they must be of the form given in the statement of the theorem in some basis.

Next consider the (1, 1) case. Then  $\mathbf{Q}$  is a subsheaf of  $R^2 g_* \mathbf{Q}$ , and let  $\mathcal{F}$  be the quotient  $R^2 g_* \mathbf{Q} / \mathbf{Q}$ . Now there are two types of points in  $S^2 \cap \Delta$ . In the first, the monodromy takes

the form  $\begin{pmatrix} 1 & * & * \\ 0 & 1 & 0 \\ 0 & 0 & 1 \end{pmatrix}$ , and here  $\mathcal{F}|_V$  on an open neighbourhood  $V$  of such a point  $b$  is of the form  $\mathbf{Q}_V \oplus \mathbf{Q}_{V-\{b\}}$ . At the second type of point, the monodromy takes the form  $\begin{pmatrix} 1 & 0 & * \\ 0 & 1 & * \\ 0 & 0 & 1 \end{pmatrix}$ , in which case locally  $\mathcal{F}$  has a subsheaf  $\mathbf{Q}$  and the quotient  $\mathcal{F}/\mathbf{Q} = \mathbf{Q}_{V-\{b\}}$ . Now let  $V_1$  be the complement in  $S^2$  of points of the first type, and  $V_2$  be the complement in  $S^2$  of points of the second type. Then globally on  $S^2$  there is an exact sequence

$$0 \rightarrow \mathbf{Q}_{V_1} \rightarrow \mathcal{F} \rightarrow \mathbf{Q}_{V_2} \rightarrow 0,$$

where the inclusion  $\mathbf{Q}_{V_1}$  in  $\mathcal{F}$  is given by  $e_2$ . From this we now obtain

$$\begin{aligned} 2 &= \chi(S^2, R^2 g_* \mathbf{Q}) = \chi(S^2, \mathbf{Q}) + \chi(S^2, \mathcal{F}) = \chi(S^2, \mathbf{Q}) + \chi(S^2, \mathbf{Q}_{V_1}) + \chi(S^2, \mathbf{Q}_{V_2}) \\ &= 6 - \#(S^2 - V_1) - \#(S^2 - V_2) \end{aligned}$$

Thus  $n = 4$ , as desired.

Finally, consider  $T_1, \dots, T_4$  with  $T_1 T_2 T_3 T_4 = I$ . At least one of these must be of the first type and one of the second, and making a change of basis and reordering the points if necessary, we can assume  $T_1 = \begin{pmatrix} 1 & 1 & 0 \\ 0 & 1 & 0 \\ 0 & 0 & 1 \end{pmatrix}$  and  $T_2 = \begin{pmatrix} 1 & 0 & 0 \\ 0 & 1 & 1 \\ 0 & 0 & 1 \end{pmatrix}$ . Interchanging  $p_3$  and  $p_4$  if necessary,  $T_3$  and  $T_4$  must be of the given form. •

## §2. Semistable Compactifications.

We will now describe how to construct well-behaved topological compactifications of suitable  $T^3$  fibre bundles  $f_0 : X_0 \rightarrow B_0$ . This serves several purposes. First, it allows us to construct examples of  $T^3$ -fibrations with monodromy of the sort classified in §1. Second, it allows us to build up a set of techniques for constructing  $T^3$ -fibrations. Third, and most importantly, it gives compactifications of the dual fibration of a  $T^3$ -fibration.

We first describe the initial data required. In the rest of this section,  $B_0$  will be an open subset of a three-manifold  $B$ ,  $\Delta = B - B_0$ , and  $f_0 : X_0 \rightarrow B_0$  a  $T^3$  fibre bundle, which we will always take to have a section. One reason for insisting on the existence of a section is that a torus bundle with a section is completely determined by its monodromy; in particular, if  $\mathcal{E}$  is the total space of the vector bundle corresponding to the sheaf  $(R^{n-1} f_{0*} \mathbf{R}) \otimes C^\infty(B_0)$ ,  $f_0$  is isomorphic to  $\mathcal{E}/R^{n-1} f_{0*} \mathbf{Z}$ . (We normally just abuse notation and identify this space with  $R^{n-1} f_{0*}(\mathbf{R}/\mathbf{Z})$ .) Of course, the local system  $R^{n-1} f_{0*} \mathbf{Z}$  is completely determined by its monodromy.

We will require in addition the following conditions on  $\Delta$  and the monodromy of the fibre bundle:

- (1)  $\Delta$  decomposes as a disjoint union  $\Delta_d \cup \Delta_g$ , with  $\Delta_d$  discrete and  $\Delta_g$  a union of 1-manifolds which are open intervals or circles. Each endpoint of a component in  $\Delta_g$  is contained in  $\Delta_d$ . Thus  $\Delta$  is a graph, with the points of  $\Delta_d$  the vertices and components of  $\Delta_g$  the edges. Furthermore, because of Theorem 1.11, we insist that the valency of each vertex is 3 or 4.
- (2) The monodromy group of  $f_0 : X_0 \rightarrow B_0$  at each point in  $\Delta$  is unipotent. In addition,  $R^3 f_{0*} \mathbf{Z} = \mathbf{Z}$ . This latter condition is equivalent to the monodromy representation  $\pi_1(B_0, b) \rightarrow GL(H_1(X_b, \mathbf{Z}))$  taking values in  $SL(H_1(X_b, \mathbf{Z}))$ .
- (3) In suitable bases, the monodromy at each point of  $\Delta_g$  is as described in Theorem 1.7, and the monodromy at each point of  $\Delta_d$  is as described in Theorem 1.11, (2)-(4).

The main theorem of this section is

**Theorem 2.1.** *If  $f_0 : X_0 \rightarrow B_0$  satisfies the above properties, then there exists a topological manifold  $X$ ,  $X_0 \subseteq X$ , and a well-behaved  $T^3$ -fibration  $f : X \rightarrow B$  such that the diagram*

$$\begin{array}{ccc} X_0 & \hookrightarrow & X \\ \downarrow f_0 & & \downarrow f \\ B_0 & \hookrightarrow & B \end{array}$$

*commutes.*

The proof of this will be given after some basic constructions are discussed. But first the main application:

**Corollary 2.2.** *If  $f : X \rightarrow B$  is a well-behaved  $T^3$ -fibration with only semistable fibres, then  $f$  has a well-behaved dual  $\check{f} : \check{X} \rightarrow B$ .*

Proof. Conditions (1)-(3) hold for  $f_0 : X_0 \rightarrow B_0$ , by Definitions 1.1 and 1.2 and Theorems 1.7 and 1.11. Construct  $\check{f}_0 : \check{X}_0 \rightarrow B_0$  by identifying this with the family of tori  $R^1 f_{0*} \mathbf{R}/\mathbf{Z}$ . The monodromy matrices of the local system  $R^2 \check{f}_{0*} \mathbf{Z} \cong R^1 f_{0*} \mathbf{Z}$  are the transpose inverses of the monodromy matrices of the local system  $R^2 f_{0*} \mathbf{Z}$ . Thus all monodromy groups are still unipotent, and conditions (1)-(3) hold for  $\check{f}_0 : \check{X}_0 \rightarrow B_0$ . Then Theorem 2.1 implies there is a well-behaved compactification, which is the desired dual. •

The basic idea for producing semi-stable fibrations is as follows. In a small neighbourhood  $U$  of a point  $b_0 \in B$  such that  $X_{b_0}$  is a semi-stable fibre, and  $b \in U - \Delta$ ,

there will always be a non-zero subspace  $L \subseteq H_1(X_b, \mathbf{Z})^G$  of monodromy invariant cycles. One then expects the torus  $T(L) = L \otimes_{\mathbf{Z}} \mathbf{R}/L$  to act fibrewise by translation on the fibration  $f^{-1}(U) \rightarrow U$ , giving a lower dimensional fibration  $f^{-1}(U)/T(L) \rightarrow U$ . If one has a guess as to what this latter fibration is, one can try to reconstruct  $f^{-1}(U) \rightarrow U$ . Now  $\pi : f^{-1}(U) \rightarrow f^{-1}(U)/T(L)$  is not in general a  $T(L)$ -bundle because there will be fixed points of the  $T(L)$  action in  $f^{-1}(U)$ . However, there will be some dense open subset  $V \subseteq f^{-1}(U)/T(L)$  for which  $\pi^{-1}(V) \rightarrow V$  is a  $T(L)$ -bundle, with Chern class  $c_1 \in H^2(V, L)$ . Thus, if we want to construct examples of semistable  $T^n$ -fibrations, we want to understand the following question: given a manifold  $\bar{Y}$ , an open subset  $Y \subseteq \bar{Y}$ , and a principal  $T(L)$ -bundle  $\pi : X \rightarrow Y$  with Chern class  $c_1 \in H^2(Y, L)$ , when does there exist a manifold  $\bar{X}$  and a commutative diagram

$$\begin{array}{ccc} X & \hookrightarrow & \bar{X} \\ \downarrow \pi & & \downarrow \bar{\pi} \\ Y & \hookrightarrow & \bar{Y} \end{array}$$

such that the  $T(L)$  action on  $X$  extends to a  $T(L)$  action on  $\bar{X}$ ?

For us, the basic example of this sort of compactification is

*Example 2.3.* In [9], III.3.A, it was shown that the map  $f : \mathbf{C}^n \rightarrow \mathbf{R}^n$  given by

$$f(z_1, \dots, z_n) = (\operatorname{Im} \prod z_i, |z_1|^2 - |z_2|^2, \dots, |z_1|^2 - |z_n|^2)$$

was a special Lagrangian fibration. Now the map  $\bar{\pi} : \mathbf{C}^n \rightarrow \mathbf{C} \times \mathbf{R}^{n-1}$  given by

$$\bar{\pi}(z_1, \dots, z_n) = (\prod z_i, |z_1|^2 - |z_2|^2, \dots, |z_1|^2 - |z_n|^2)$$

is invariant under the  $T^{n-1}$  action

$$(z_1, \dots, z_n) \mapsto (e^{i\theta_1} z_1, \dots, e^{i\theta_n} z_n),$$

$\theta_1 + \dots + \theta_n = 0$ . It is convenient to identify  $T^{n-1}$  with  $T(L)$ , where  $L = \{(a_1, \dots, a_n) \in \mathbf{Z}^n \mid \sum a_i = 0\}$ . Then  $\bar{\pi}$  is the quotient map  $\mathbf{C}^n \rightarrow \mathbf{C}^n/T(L)$ . Furthermore, the set of points fixed by some subgroup of  $T(L)$  is  $\operatorname{Crit}(f) = \bigcup \{z_i = z_j = 0\}$ . Thus  $\bar{\pi}$  can be viewed as a (partial) compactification of the  $T(L)$ -bundle  $\pi : \mathbf{C}^n - \operatorname{Crit}(f) \rightarrow \mathbf{C} \times \mathbf{R}^{n-1} - \bar{\pi}(\operatorname{Crit}(f))$ .

We will in fact only make use of the cases  $n = 2$  and  $3$ , but more generally, much of what is done below can be extended to higher dimensions. However, in dimensions 2 and 3, we have a complete description of semistable monodromy, so we can produce a list of examples of all possible monodromies. We build up these examples using the following basic building blocks:



**Proposition 2.4.** (1) Let  $\pi : X \rightarrow Y = \mathbf{R}^3 - \{0\}$  be a principal  $S^1$ -bundle with Chern class  $c_1 \in H^2(Y, \mathbf{Z}) = \mathbf{Z}$ , and let  $\bar{Y} = \mathbf{R}^3 \supseteq Y$ . Then there is a unique topological space  $\bar{X} = X \cup \{p\}$  extending the topology on  $X$  such that there is a commutative diagram of continuous maps

$$\begin{array}{ccc} X & \hookrightarrow & \bar{X} \\ \downarrow \pi & & \downarrow \bar{\pi} \\ Y & \hookrightarrow & \bar{Y} \end{array}$$

with  $\bar{\pi}$  proper and  $\bar{\pi}(p) = 0$ . Furthermore,  $\bar{X}$  is a topological manifold if and only if  $c_1 = \pm 1$ .

*Proof.* A bundle over  $Y$  with Chern class  $c_1$  can be constructed as follows. Choose a hermitian metric on  $\mathcal{O}_{\mathbf{P}^1}(c_1)$ , and let  $X$  be the total space of  $\mathcal{O}_{\mathbf{P}^1}(c_1)$  minus the zero section. Then define  $\pi : X \rightarrow \mathbf{P}^1 \times \mathbf{R}_{>0} \cong Y$  by taking an element  $s$  in the fibre of  $\mathcal{O}_{\mathbf{P}^1}(c_1)$  at a point  $x \in \mathbf{P}^1$  to  $(x, \|s\|) \in Y$ . The map  $\pi$  defines an  $S^1$ -bundle with first Chern class  $c_1$ .

It is easy to see that the topology on  $\bar{X} = X \cup \{p\}$  is uniquely determined by the condition that  $\bar{\pi}$  be a proper continuous map. This topology has as basis the open sets in  $X$  plus the inverse images of open sets in  $\bar{Y}$  under  $\bar{\pi}$ . The space  $\bar{X}$  can then be described as being obtained from  $\mathcal{O}_{\mathbf{P}^1}(c_1)$  by contracting the zero section. This is well-known to have a quotient singularity if  $c_1 < -1$ ; if  $c_1 = -1$ , then  $\bar{X}$  is a manifold. If  $c_1 > 0$ , then  $\pi : X \rightarrow Y$  is topologically equivalent to the  $S^1$ -bundle with Chern class  $-c_1$ , but with the orientation of the  $S^1$  action reversed. If  $c_1 = 0$ , the fibration is trivial and  $\bar{X}$  is not a manifold. Thus  $\bar{X}$  is a manifold if and only if  $c_1 = \pm 1$ . •

We note that in the above Proposition, it is now clear that if  $c_1 = \pm 1$ , then  $\bar{\pi} : \bar{X} \rightarrow \bar{Y}$  coincides with  $\bar{\pi}$  of Example 2.3 with  $n = 2$ .

**Proposition 2.5.** Let  $Y$  be a manifold,  $\pi : X \rightarrow Y$  a principal  $S^1$ -bundle with  $Y \subseteq \bar{Y}$  a manifold and  $\bar{Y} - Y = S$  an oriented connected submanifold of codimension three. Let  $c_1 \in H^2(Y, \mathbf{Z})$  be the Chern class of  $\pi$ . Now  $H_S^3(\bar{Y}, \mathbf{Z}) = H^0(S, \mathbf{Z}) = \mathbf{Z}$ , and suppose the image of  $c_1$  under the natural map  $H^2(Y, \mathbf{Z}) \rightarrow H_S^3(\bar{Y}, \mathbf{Z})$  is  $\pm 1$ . Then there exists a unique topological space  $\bar{X} = X \cup S$  extending the topology on  $X$  such that there is a commutative diagram of continuous maps

$$\begin{array}{ccc} X & \hookrightarrow & \bar{X} \\ \downarrow \pi & & \downarrow \bar{\pi} \\ Y & \hookrightarrow & \bar{Y} \end{array}$$

with  $\bar{\pi}$  proper and  $\bar{\pi}|_S : S \rightarrow S$  the identity. Furthermore,  $\bar{X}$  is a topological manifold.

Proof. Again, the topology on  $\bar{X}$  with basis consisting of open sets in  $X$  and inverse images of open sets in  $\bar{Y}$  under  $\bar{\pi}$  is easily seen to be the unique topology in which  $\bar{\pi}$  is proper and  $\bar{\pi}|_S$  is the identity. Now if  $p \in S$  is a point, there exists an open neighbourhood  $U \subseteq \bar{Y}$  of  $p$  such that  $U \cong \mathbf{R}^{n-3} \times \mathbf{R}^3$  with  $U \cap S$  identified with  $\mathbf{R}^{n-3} \times \{0\}$ . Then the restriction of  $\pi$  to  $\{q\} \times (\mathbf{R}^3 - \{0\})$  for any point  $q \in U \cap S$  is an  $S^1$ -bundle with Chern class  $\pm 1$ . Thus by Proposition 2.4, we have a commutative diagram

$$\begin{array}{ccc} \pi^{-1}(U - S) & \hookrightarrow & \mathbf{R}^{n-3} \times \mathbf{C}^2 \\ \downarrow \pi & & \downarrow \bar{\pi}' \\ U - S & \hookrightarrow & \mathbf{R}^{n-3} \times \mathbf{R}^3 \end{array}$$

where  $\bar{\pi}'$  is the identity on the first factor and the map  $\bar{\pi}$  of Example 2.3 on the second factor. Thus, by uniqueness of the compactification,  $\bar{\pi}'$  coincides with  $\bar{\pi}^{-1}(U) \rightarrow U$ , and thus in particular,  $\bar{X}$  is a manifold. •

*Example 2.6.* (1) Let  $D^*$  be a punctured disk,  $f : X_0 \rightarrow D^*$  be a  $T^2$ -fibre bundle, with a section and monodromy  $\begin{pmatrix} 1 & 1 \\ 0 & 1 \end{pmatrix}$  in some suitable basis  $e_1, e_2$  of  $H_1$  of a fibre. Then translation on fibres by elements of  $\mathbf{R}e_1$  induces an  $S^1$  action on  $X_0$ , yielding an  $S^1$ -bundle  $\pi_0 : X_0 \rightarrow Y_0 = S^1 \times D^*$ . One easy way to see what is the Chern class of the bundle  $\pi_0$  is via the Leray spectral sequence for  $\pi_0$ : the image of  $1 \in H^0(Y_0, R^1\pi_{0*}\mathbf{Z})$  via the differential  $d : H^0(Y_0, R^1\pi_{0*}\mathbf{Z}) \rightarrow H^2(Y_0, \mathbf{Z})$  is the Chern class. The group  $H^2(X_0, \mathbf{Z})$  is easily seen to be torsion-free, and thus coker  $d$  must be also. Since  $H^2(Y_0, \mathbf{Z}) \cong H^1(S^1, \mathbf{Z}) \otimes H^1(D^*, \mathbf{Z}) \cong \mathbf{Z}$ , the Chern class  $c_1$  of the bundle  $\pi_0$  must be  $\pm 1$ .

To extend the fibration  $f : X_0 \rightarrow D^*$  to  $\bar{f} : \bar{X} \rightarrow D$ , we proceed as follows. We have  $Y_0 \subseteq \bar{Y} = S^1 \times D$ . Let  $Y = \bar{Y} - \{(p, 0)\}$ , where  $p$  is a point in  $S^1$ ,  $0 \in D$  the puncture point. Then  $H^2(Y, \mathbf{Z}) \cong H^3_{\{(p,0)\}}(\bar{Y}, \mathbf{Z}) = \mathbf{Z}$  and the restriction map  $H^2(Y, \mathbf{Z}) \rightarrow H^2(Y_0, \mathbf{Z})$  is an isomorphism. Thus the  $S^1$ -bundle  $\pi_0$  extends to an  $S^1$ -bundle  $\pi : X \rightarrow Y$ . Then Proposition 2.5 can be applied to obtain a manifold  $\bar{X} = X \cup \{pt\}$  and a map  $\bar{\pi} : \bar{X} \rightarrow \bar{Y}$ . When  $\bar{\pi}$  is composed with the projection  $\bar{Y} \rightarrow D$ , we get a map  $\bar{f} : \bar{X} \rightarrow D$ . This map is proper, and  $\bar{f}^{-1}(0)$  is an  $I_1$  fibre.

It is worth noting that the effect of changing the sign of  $c_1$  in this construction is simply to reverse the direction of the  $S^1$  action on  $X$ . This is equivalent to replacing  $e_1$  with  $-e_1$ , and hence the monodromy changes from  $\begin{pmatrix} 1 & 1 \\ 0 & 1 \end{pmatrix}$  to  $\begin{pmatrix} 1 & -1 \\ 0 & 1 \end{pmatrix}$ . Clearly though it gives the same  $T^2$ -fibration.

We also note that it is easy to see the fibration  $\bar{f} : \bar{X} \rightarrow D$  is well-behaved and has a section.

(2) This example will not be used, but demonstrates that the topology of the singular fibre may not be reflected in the monodromy about it. Let  $Y = S^1 \times D - \{(p_1, 0), (p_2, 0)\}$ ,  $\bar{Y} = S^1 \times D$ ,  $p_1$  and  $p_2$  two distinct points in  $S^1$ ,  $D$  a two-dimensional disk,  $0 \in D$ . Then  $H^2(Y, \mathbf{Z}) = H^3_{\{(p_1, 0)\}}(\bar{Y}, \mathbf{Z}) \oplus H^3_{\{(p_2, 0)\}}(\bar{Y}, \mathbf{Z})$ , and the restriction map  $H^2(Y, \mathbf{Z}) \rightarrow H^2(S^1 \times D^*, \mathbf{Z})$  is given by summation. Construct the  $S^1$ -bundle  $\pi : X \rightarrow Y$  with Chern class  $(1, -1) \in H^2(Y, \mathbf{Z})$ . Then  $\pi$  restricted to  $S^1 \times D^*$  is trivial. Also,  $\pi$  can be compactified as above to obtain a fibration  $\bar{f} : \bar{X} \rightarrow D$ , with central fibre being a union of two  $S^2$ 's. However, the monodromy about the central fibre is trivial. This of course could not happen for a holomorphic elliptic fibration.

(3) *Type (2, 2) fibres.* Let  $B = D \times (0, 1)$ ,  $B_0 = D^* \times (0, 1)$ ,  $\bar{Y} = T^2 \times B$ . Let  $S = S^1 \times \{0\} \times (0, 1) \subseteq T^2 \times \{0\} \times (0, 1) \subseteq \bar{Y}$  be a surface, where  $S^1 \subseteq T^2$  is a circle whose homology class is a primitive element  $ae_2 + be_3 \in H_1(T^2, \mathbf{Z})$ , and  $e_2, e_3$  is a basis for  $H_1(T^2, \mathbf{Z})$ . Let  $Y = \bar{Y} - S$ . There is an exact sequence

$$0 \rightarrow H^2(\bar{Y}, \mathbf{Z}) \rightarrow H^2(Y, \mathbf{Z}) \rightarrow H^3_S(\bar{Y}, \mathbf{Z}) \rightarrow 0.$$

$H^2(\bar{Y}, \mathbf{Z})$  is isomorphic to  $H^2(T^2, \mathbf{Z})$ , and the exact sequence is split via the restriction map  $H^2(Y, \mathbf{Z}) \rightarrow H^2(T^2 \times \{p\}, \mathbf{Z})$  for a point  $p \in B_0$ . Thus  $H^2(Y, \mathbf{Z}) = H^2(\bar{Y}, \mathbf{Z}) \oplus H^3_S(\bar{Y}, \mathbf{Z})$ . Also  $H^3_S(\bar{Y}, \mathbf{Z}) = H^0(S, \mathbf{Z}) = \mathbf{Z}$ .

Now let  $\pi : X \rightarrow Y$  be an  $S^1$ -bundle with first Chern class  $c_1 \in H^2(Y, \mathbf{Z})$  given by either 1 or  $-1$  in  $H^3_S(\bar{Y}, \mathbf{Z}) = \mathbf{Z}$ . (Note this equality depends on choices of orientation for  $\bar{Y}$  and  $S$ , so we won't worry about the sign.) Then applying Proposition 2.5, we can construct a compactification  $\bar{\pi} : \bar{X} \rightarrow \bar{Y}$ . By composing this with the projection  $\bar{Y} \rightarrow B$ , we obtain a map  $\bar{f} : \bar{X} \rightarrow B$  which is a  $T^3$ -bundle over  $B_0$ , and has fibres over  $\Delta = B - B_0$  homeomorphic to  $I_1 \times S^1$ . Furthermore, it is clear from the construction that we can write  $\bar{X} = \bar{X}' \times S^1 \times (0, 1)$ , where  $\bar{X}' \rightarrow D$  is a fibration of the type constructed in (3). In particular, choosing a basis for  $H_1(\bar{X}_b, \mathbf{Z})$ ,  $b \in B_0$  of the form  $e_1, e_2, e_3$ , where  $e_1$  is a fibre of  $\pi$  and  $e_2, e_3$  project to  $e_2, e_3 \in H_1(\bar{Y}_b, \mathbf{Z})$  under the map  $\pi$ , we see that  $e_1$  and  $ae_2 + be_3$  are a basis for the monodromy invariant cycles. Furthermore, the monodromy about a loop around  $\Delta$  is  $\begin{pmatrix} 1 & \pm b & \mp a \\ 0 & 1 & 0 \\ 0 & 0 & 1 \end{pmatrix}$ , where the choice of sign can be changed by replacing  $e_1$  with  $-e_1$ . In particular, this provides a compactification of a  $T^3$ -fibre bundle  $f : X_0 = \bar{f}^{-1}(B_0) \rightarrow B_0$  with this monodromy.

(4) *Type (2, 1) fibres.* Let  $B_0 = (S^2 - \{p_1, p_2, p_3\}) \times (0, 1)$ , and let  $B = B^3$ , the three-ball. Identify  $B - \{0\}$  with  $S^2 \times (0, 1)$  and embed  $B_0 \subseteq B$  via  $S^2 - \{p_1, p_2, p_3\} \subseteq S^2$ . Then  $\Delta = B - B_0$  is the cone over three points (best-visualized as a "Y"). Write  $\Delta =$

$\Delta_1 \cup \Delta_2 \cup \Delta_3 \cup \{0\}$ , where  $\Delta_i = \{p_i\} \times (0, 1)$  are the “legs” of the “Y”. Let  $\bar{Y} = T^2 \times B$ , and let  $e_2, e_3$  be a basis for  $H_1(T^2, \mathbf{Z})$ . Let  $S \subseteq \bar{Y}$  be a “pair of pants” sitting over  $\Delta$  constructed as follows:  $S \cap (T^2 \times \Delta_i)$  will be a cylinder  $S^1 \times \Delta_i$ , with the  $S^1$  of class  $-e_3, e_2$  and  $-e_2 + e_3$  for  $i = 1, 2, 3$  respectively. These three cylinders are then joined in  $T^2 \times \{0\}$  to form the pair of pants:

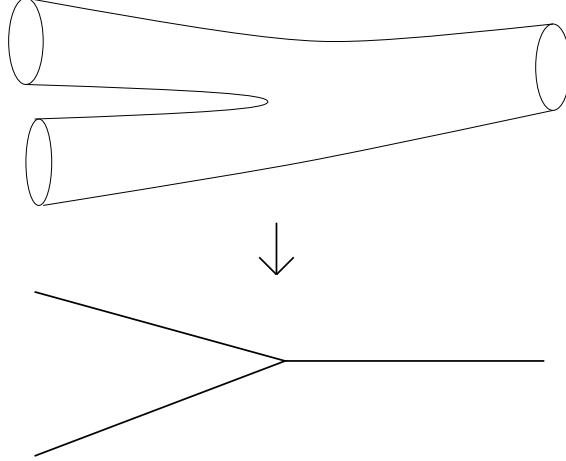

Figure 2.1

Note that there is some ambiguity as to the fibre of  $S \rightarrow \Delta$  over  $0 \in \Delta$ . This will affect the precise shape of the singular fibre, but not the topology of the total space. This could be a figure eight or else my preferred choice, suggested by Ruan (illustrated in [17], Figure 6), and shown in the following figure:

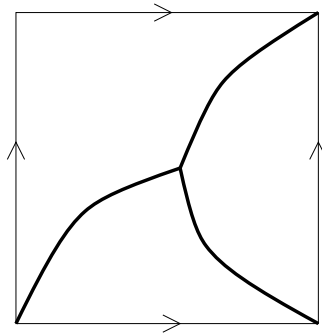

Figure 2.2

Here the torus has been depicted as a rectangle with opposite sides identified, and the darker lines represent the fibre of  $S$  over  $0 \in \Delta$ . We will not limit our choices at this point, and instead allow any choice, as we are currently just interested in the topology of the fibration. This choice might become clearer if a local model for a special Lagrangian fibration with this sort of singular fibre is found.

In any event, put  $Y = \bar{Y} - S$ , and then  $H^2(Y, \mathbf{Z}) = H^2(\bar{Y}, \mathbf{Z}) \oplus H_S^3(Y, \mathbf{Z}) = \mathbf{Z} \oplus \mathbf{Z}$  as in (3). Take  $c_1 = 1 \in H_S^3(Y, \mathbf{Z})$ , and we obtain an  $S^1$ -bundle  $X \rightarrow Y$ , which by Proposition

2.5 compactifies to  $\bar{X} \rightarrow \bar{Y}$ . By composing with the projection  $\bar{Y} \rightarrow B$ , we obtain a proper map  $\bar{f} : \bar{X} \rightarrow B$ . Now if  $\gamma_1, \gamma_2, \gamma_3$  are loops in  $B_0$  around  $\Delta_1, \Delta_2$  and  $\Delta_3$ , with  $\gamma_1\gamma_2\gamma_3 = 1$  in  $\pi_1(B_0, b)$ , then by (3) it follows that the monodromy matrices  $T_i$  about  $\gamma_i$  take the form (in the basis  $e_1, e_2, e_3$  of  $H_1(\bar{X}_b, \mathbf{Z})$  as in (3))

$$T_1 = \begin{pmatrix} 1 & \pm 1 & 0 \\ 0 & 1 & 0 \\ 0 & 0 & 1 \end{pmatrix}, T_2 = \begin{pmatrix} 1 & 0 & \pm 1 \\ 0 & 1 & 0 \\ 0 & 0 & 1 \end{pmatrix}, T_3 = \begin{pmatrix} 1 & 1 & 1 \\ 0 & 1 & 0 \\ 0 & 0 & 1 \end{pmatrix} \text{ or } \begin{pmatrix} 1 & -1 & -1 \\ 0 & 1 & 0 \\ 0 & 0 & 1 \end{pmatrix}$$

Using the additional requirement that  $T_1T_2T_3 = I$ , and possibly changing the sign of  $e_1$ , we see we must have

$$T_1 = \begin{pmatrix} 1 & 1 & 0 \\ 0 & 1 & 0 \\ 0 & 0 & 1 \end{pmatrix}, T_2 = \begin{pmatrix} 1 & 0 & 1 \\ 0 & 1 & 0 \\ 0 & 0 & 1 \end{pmatrix}, T_3 = \begin{pmatrix} 1 & -1 & -1 \\ 0 & 1 & 0 \\ 0 & 0 & 1 \end{pmatrix}$$

Thus  $\bar{f} : \bar{X} \rightarrow B$  provides a compactification of a fibration  $f_0 : X_0 \rightarrow B_0$  with the above monodromy.

The fibre over  $0 \in B$ ,  $\bar{X}_0$ , is described as follows. Let  $S_0 \subseteq T^2$  be the fibre of  $S \rightarrow \Delta$  over  $0 \in B$ . Then  $\bar{X}_0 = S^1 \times T^2 / \sim$ , where  $(x, y) \sim (x', y')$  if  $(x, y) = (x', y')$  or  $y = y' \in S_0$ . Thus  $S^1 \times S_0$  is contracted to  $S_0$ .

(5) *Type (1, 1) fibres.* Let  $B_0 = (S^2 - \{p_1, \dots, p_4\}) \times (0, 1)$ , and let  $B = B^3$ , the three-ball, with  $\Delta = B - B_0$  the cone over four points. Let  $\Delta_i = \{p_i\} \times (0, 1)$ , so that  $\Delta = \Delta_1 \cup \dots \cup \Delta_4 \cup \{0\}$ . Let  $l_1$  be the cone over  $\{p_1, p_3\}$  and  $l_2$  the cone over  $\{p_2, p_4\}$ , so that  $\Delta = l_1 \cup l_2$  and  $l_1 \cap l_2 = \{0\} \subseteq B$ . Let  $X' \rightarrow D$  be a  $T^2$ -fibration as constructed in (1) with monodromy  $\begin{pmatrix} 1 & 1 \\ 0 & 1 \end{pmatrix}$ , and identifying  $D \times (0, 1)$  with  $B$  so that  $\{0\} \times (0, 1)$  is identified with  $l_2$ , we obtain a  $T^2$ -fibration  $g : \bar{Y} = X' \times (0, 1) \rightarrow B$  with discriminant locus  $l_2$  and monodromy  $\begin{pmatrix} 1 & 1 \\ 0 & 1 \end{pmatrix}$  about  $l_2$  in a suitable basis  $e_2, e_3$  of  $H_1(\bar{Y}_b, \mathbf{Z})$ , for some  $b \in B_0$ .

Now construct a surface  $S \subseteq \bar{Y}$  as follows.  $S$  will be a cylinder fibred in circles over  $l_1$ . To specify the cohomology class of this  $S^1$  over  $\Delta_1$  and  $\Delta_3$ , we have to be careful about how we identify these classes. In particular, as  $e_3$  is not invariant under monodromy, it is not well-defined globally. We picture here the sphere  $S^2 - \{p_1, p_2, p_3, p_4\}$ , along with loops

$\gamma_1, \dots, \gamma_4$  and paths  $c_1$  and  $c_3$  joining  $p_1$  and  $p_3$  to  $b$ :

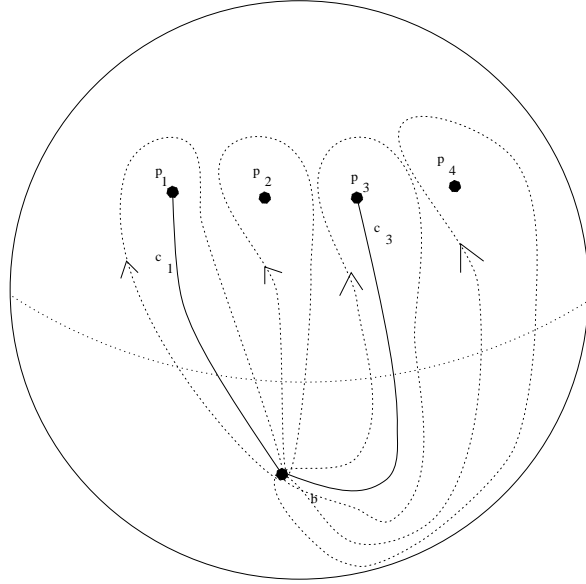

Figure 2.3

We can then identify  $H_1(\bar{Y}_{p_1}, \mathbf{Z})$  and  $H_1(\bar{Y}_{p_3}, \mathbf{Z})$  with  $H_1(\bar{Y}_b, \mathbf{Z})$  via the paths  $c_1$  and  $c_3$ . Using these identifications,  $S \cap g^{-1}(\Delta_1) = S^1 \times \Delta_1$ , with  $S^1 \subseteq T^2$  of class  $e_3$ , while  $S \cap g^{-1}(\Delta_3) = S^1 \times \Delta_3$  with  $S^1 \subseteq T^2$  of class  $ae_2 + e_3$ . These two circles specialise to circles of the same class in  $\bar{Y}_0$ , as  $e_2$  is the vanishing cycle. Thus these two cylinders can be joined up.

Now let  $Y = \bar{Y} - S$ . We have as usual a splitting  $H^2(Y, \mathbf{Z}) = H^2(\bar{Y}, \mathbf{Z}) \oplus H_S^3(\bar{Y}, \mathbf{Z})$ , and take an  $S^1$ -bundle  $\pi : X \rightarrow Y$  given by  $c_1 = 1 \in H_S^3(\bar{Y}, \mathbf{Z})$ . As usual, we compactify to obtain  $\bar{\pi} : \bar{X} \rightarrow \bar{Y}$ , with the composed map  $\bar{f} = g \circ \bar{\pi} : \bar{X} \rightarrow B$ . Then  $X_0 = \bar{f}^{-1}(B_0) \rightarrow B_0$  has monodromy as given in Theorem 1.11, (3), and we have constructed a compactification of such a  $T^3$ -bundle.

The fibre of type (1, 1) constructed here can then be described as  $S^1 \times I_1 / \sim$ , where  $(x, y) \sim (x', y')$  if  $(x, y) = (x', y')$  or  $y = y' \in S \cap g^{-1}(0)$ . The singular locus of this fibre is a circle.

We still need a construction for type (1, 2) fibres. An example of such a fibration with a type (1, 2) fibre has been given in [6], §1. However, I would like to give a different construction of that example, more in keeping with the previous construction techniques given here. To do so, we need to compactify  $T^2$  bundles.

Let  $L \cong \mathbf{Z}^2$  and let  $T(L) := L \otimes_{\mathbf{Z}} \mathbf{R}/L$ . The Chern class of a principal  $T(L)$ -bundle over  $Y$  is an element of  $H^2(Y, L)$ . Indeed, if  $\mathcal{R}$  denotes the sheaf of continuous real-valued functions on  $Y$ , then a principal  $T(L)$ -bundle is determined by an element

of  $H^1(Y, L \otimes_{\mathbf{Z}} \mathcal{R}/L)$ , which is isomorphic to  $H^2(Y, L)$ . The corresponding element in this latter group is the Chern class. It is also convenient to think of a  $T^2$ -bundle as a product of  $S^1$ -bundles: if  $e_1, e_2$  is a basis for  $L$ , giving a decomposition  $H^2(Y, L) \cong H^2(Y, \mathbf{Z})e_1 \oplus H^2(Y, \mathbf{Z})e_2$ , we can write  $c \in H^2(Y, L)$  as  $c = (a_1, a_2)$ ,  $a_i \in H^2(Y, \mathbf{Z})$ . If  $X_i \rightarrow Y$  is an  $S^1$ -bundle with Chern class  $a_i$ , then  $X = X_1 \times_Y X_2 \rightarrow Y$  is a  $T(L)$ -bundle with Chern class  $c$ . Note that  $X_1 = X/T(\mathbf{Z}e_2)$ ,  $X_2 = X/T(\mathbf{Z}e_1)$ . Here,  $T(\mathbf{Z}e_i)$  is the subtorus of  $T(L)$  generated by  $e_i$ .

**Proposition 2.7.** *Let  $Y$  be a manifold,  $\pi : X \rightarrow Y$  a principal  $T(L)$ -bundle with  $Y \subseteq \bar{Y}$  a manifold and  $\bar{Y} - Y = S$  an oriented connected submanifold of codimension three. Let  $c_1 \in H^2(Y, L)$  be the Chern class of  $\pi$ , and suppose the image of  $c_1$  under the natural map  $H^2(Y, L) \rightarrow H_S^3(\bar{Y}, L) = H^0(S, L) = L$  is a primitive class  $e_1 \in L$ . Then there exists a unique topological space  $\bar{X} = X \cup S'$  such that there is a commutative diagram of continuous maps*

$$\begin{array}{ccc} X & \hookrightarrow & \bar{X} \\ \downarrow \pi & & \downarrow \bar{\pi} \\ Y & \hookrightarrow & \bar{Y} \end{array}$$

with  $\bar{\pi}$  proper, the  $T(L)$  action on  $X$  extending to a  $T(L)$  action on  $\bar{X}$  so that  $\bar{\pi}|_{S'} : S' \rightarrow S$  is a  $T(L/\langle e_1 \rangle)$ -bundle. Furthermore,  $\bar{X}$  is a manifold.

*Proof.* Choose  $e_2$  so that  $e_1, e_2$  forms a basis for  $L$ . Then  $c_1 \in H^2(Y, L) = H^2(Y, \mathbf{Z})e_1 \oplus H^2(Y, \mathbf{Z})e_2$  can be written as  $c_1 = (a_1, a_2)$ , with the image of  $a_1$  under the natural map  $H^2(Y, \mathbf{Z}) \rightarrow H_S^3(\bar{Y}, \mathbf{Z})$  being 1 and the image of  $a_2$  under this same map being zero. Thus  $a_2$  lifts to an element  $\bar{a}_2 \in H^2(\bar{Y}, \mathbf{Z})$ . Note this lifting is unique because  $H_S^2(\bar{Y}, \mathbf{Z}) = 0$ . Let  $\pi_i : X_i \rightarrow Y$  be the  $S^1$ -bundle with Chern class  $a_i$ . Then by Proposition 2.5,  $\pi_1$  can be extended to  $\bar{\pi}_1 : \bar{X}_1 \rightarrow \bar{Y}$ , and we also have an  $S^1$ -bundle  $\bar{\pi}_2 : \bar{X}_2 \rightarrow \bar{Y}$  with Chern class  $\bar{a}_2$ , extending  $\pi_2$ . Then we can take  $\bar{\pi} : \bar{X} = \bar{X}_1 \times_{\bar{Y}} \bar{X}_2 \rightarrow \bar{Y}$  as the desired compactification of  $\pi$ .

To show uniqueness, suppose we are given  $\bar{\pi} : \bar{X} \rightarrow \bar{Y}$  with the desired properties. Letting  $\bar{X}_1 = \bar{X}/T(\mathbf{Z}e_2)$  and  $\bar{X}_2 = \bar{X}/T(\mathbf{Z}e_1)$ ,  $\bar{\pi}_i : \bar{X}_i \rightarrow \bar{Y}$  the projection, it is clear that  $\bar{\pi}_1 : \bar{X}_1 \rightarrow \bar{Y}$  restricts to the  $S^1$ -bundle  $\pi_1 : X_1 \rightarrow Y$ , and  $\bar{\pi}_1^{-1}(S) \cong S$ , so  $\bar{X}_1$  is uniquely determined by Proposition 2.5. On the other hand,  $\bar{\pi}_2 : \bar{X}_2 \rightarrow \bar{Y}$  is an  $S^1$ -bundle, necessarily with Chern class  $\bar{a}_2$ . Finally,  $\bar{X} = \bar{X}_1 \times_{\bar{Y}} \bar{X}_2$ , so  $\bar{X}$  is necessarily as constructed as above. •

*Example 2.8. Type (2, 2) fibres again.* One can apply Proposition 2.7 to give an alternate construction of type (2, 2) fibres. Take  $Y = S^1 \times D \times (0, 1) - \{p\} \times \{0\} \times (0, 1) \subseteq \bar{Y} = S^1 \times D \times (0, 1)$ . Then  $H^2(Y, L) = H_{\{p\} \times \{0\} \times (0, 1)}^3(\bar{Y}, L) = L$ , and choosing  $c_1 \in L$

primitive, one obtains a  $T(L)$ -bundle over  $Y$  which can be compactified to give a map  $\bar{\pi} : \bar{X} \rightarrow \bar{Y}$ . Composing with the projection  $\bar{Y} \rightarrow B = D \times (0, 1)$  gives a  $T^3$ -fibration  $\bar{f} : \bar{X} \rightarrow B$ . Let  $e_1, e_2$  be a basis for  $L$ , and take for  $H_1(\bar{X}_b, \mathbf{Z})$  a basis  $e_1, e_2, e_3$ , with  $e_3$  mapping under  $\bar{\pi}$  to a generator of  $H_1(S^1, \mathbf{Z})$ . Then it is easy to see that if  $c_1 = ae_1 + be_2$ , then the monodromy about a loop around  $\{0\} \times (0, 1)$  is

$$\begin{pmatrix} 1 & 0 & a \\ 0 & 1 & b \\ 0 & 0 & 1 \end{pmatrix} \text{ or } \begin{pmatrix} 1 & 0 & -a \\ 0 & 1 & -b \\ 0 & 0 & 1 \end{pmatrix}.$$

Either can occur by changing the sign of the  $T(L)$  action.

The final variant of this idea we need is

**Proposition 2.9.** *Let  $Y$  be a four-manifold,  $\pi : X \rightarrow Y$  a principal  $T(L)$ -bundle with  $Y \subseteq \bar{Y}$  a manifold and  $\bar{Y} - Y = \Delta$  a trivalent graph, i.e. a union of disjoint curves and vertices with each vertex being in the closure of precisely three curves. We do not assume  $\Delta$  is compact. Write  $\Delta = \Delta_g \cup \Delta_d$ , with  $\Delta_g$  the union of (open) edges and  $\Delta_d$  the union of vertices. Let  $c_1 \in H^2(Y, L)$  be the Chern class of  $\pi$ , and denote also by  $c_1$  its image under the natural map  $H^2(Y, L) \rightarrow H^2_\Delta(\bar{Y}, L)$ . Then  $H^3_\Delta(\bar{Y}, L) = H_1^{BM}(\Delta, L)$ , the Borel-Moore homology of  $\Delta$  with coefficients in  $L$ . If  $\bar{\Delta} = \Delta \cup \{\infty\}$  is the one-point compactification of  $\Delta$ , then  $H_1^{BM}(\Delta, L) \cong H_1(\bar{\Delta}, \{\infty\}, L)$ , the simplicial relative homology group. Then if  $c_1 \in H^2_\Delta(\bar{Y}, L)$  is represented by a relative simplicial 1-cycle on  $\bar{\Delta}$ , assigning to each oriented edge  $\Delta_i$  of  $\bar{\Delta}$  the element  $a_i \in L$ ;  $a_i$  is primitive for each  $i$ ; and  $a_i, a_j, a_k$  span  $L$  whenever  $\Delta_i, \Delta_j, \Delta_k$  have a common vertex, then there exists a unique topological space  $\bar{X} = X \cup S$  such that there exists a commutative diagram of continuous maps*

$$\begin{array}{ccc} X & \hookrightarrow & \bar{X} \\ \downarrow \pi & & \downarrow \bar{\pi} \\ Y & \hookrightarrow & \bar{Y} \end{array}$$

so that  $\bar{\pi}$  is proper,  $T(L)$  acts on  $\bar{X}$ ,  $\bar{\pi}^{-1}(\Delta_i \cap \Delta_g) \rightarrow \Delta_i \cap \Delta_g$  is a  $T(L/\langle a_i \rangle)$ -bundle for each edge  $\Delta_i$ , and  $\bar{\pi}^{-1}(\Delta_d) \rightarrow \Delta_d$  is an isomorphism. Furthermore,  $\bar{X}$  is a manifold.

Proof. That  $H^3_\Delta(\bar{Y}, L) = H_1^{BM}(\Delta, L)$  follows from a suitable form of Poincaré duality (see [3], V, Theorem 9.3). The description of  $H_1^{BM}(\Delta, L)$  follows from [3], V. Now using Proposition 2.7,  $\pi : Y \rightarrow X$  can be extended to  $\pi' : X' \rightarrow Y' = \bar{Y} - \Delta_d$  in a unique way to maintain the desired properties. Putting  $\bar{X} = X' \cup \Delta_d$ , there is a unique topology on  $\bar{X}$  inducing the topology on  $X'$  and making the extension of  $\pi'$  to  $\bar{\pi} : \bar{X} \rightarrow \bar{Y}$  proper. We only need to check  $\bar{X}$  is a manifold in a neighbourhood of a point  $p \in \Delta_d$ . To do so,



we use the local model in Example 2.3 for such a fibration. First note that we can take  $L \subseteq \mathbf{Z}^3$  with standard basis  $e_1, e_2, e_3$  and  $L = \{\sum b_i e_i \mid \sum b_i = 0\}$ . Let  $a_i$  be the coefficient of the oriented edge  $\Delta_i$  in the 1-cycle representing  $c_1$ . If edges, say,  $\Delta_1, \Delta_2, \Delta_3$  meet at  $p \in \Delta_d$ , then possibly after changing orientations of these three edges, we must have  $a_1 + a_2 + a_3 = 0$ . This is the cycle condition. Since we also assume the  $a_i$ 's are primitive and  $a_1, a_2, a_3$  span  $L$ , without loss of generality we can take  $a_1 = e_2 - e_3, a_2 = e_3 - e_1$ , and  $a_3 = e_1 - e_2$ . Now in the  $T(L)$ -action on  $\mathbf{C}^3$  given in Example 2.3,  $\{z_i = z_j = 0\}$  is fixed by  $T(a_k \mathbf{Z})$ , if  $\{i, j, k\} = \{1, 2, 3\}$ . This makes it clear that  $\pi_{2.3} : \mathbf{C}^3 - \{0\} \rightarrow \mathbf{C} \times \mathbf{R}^2 - \{0\}$  given in Example 2.3 coincides with  $\bar{\pi}^{-1}(U - \{p\}) \rightarrow U - \{p\}$ , where  $U \cong \mathbf{C} \times \mathbf{R}^2$  is a small open neighbourhood of  $p$ . Thus  $\bar{\pi}_{2.3}$  coincides with  $\bar{\pi} : \bar{\pi}^{-1}(U) \rightarrow U$ , and  $\bar{X}$  is a manifold. •

*Example 2.10. Type (1, 2) fibres.* Let  $B$  and  $B_0$  be as in Example 2.6, (4). Take  $Y = S^1 \times B - \{p\} \times \Delta \subseteq \bar{Y} = S^1 \times B$ , where  $p \in S^1$  is a point. Then  $H^2(Y, L) = H^3_{\{p\} \times \Delta}(\bar{Y}, L) \cong H_1(\bar{\Delta}, \infty, L)$ , and we can take  $((1, 0), (0, 1), (-1, -1)) \in H^2(Y, L)$  as the Chern class of a  $T^2$ -bundle  $\pi : X \rightarrow Y$ , which we then compactify using Proposition 2.9 to  $\bar{\pi} : \bar{X} \rightarrow \bar{Y}$ . It is then easy to see that the composed fibration  $\bar{f} : \bar{X} \rightarrow B$  has monodromy dual to that in Example 2.6, (4), and has a section. We note this construction coincides topologically with the example given in [6], §1.

*Proof of Theorem 2.1.* We simply piece together the examples above. First suppose we are given  $T^3$ -fibrations  $f_U : X_U \rightarrow U, f_V : X_V \rightarrow V, U, V \subseteq B$ , such that  $f_U$  and  $f_V$  have sections, and  $f_U : f_U^{-1}(U \cap V) \rightarrow U \cap V, f_V : f_V^{-1}(U \cap V) \rightarrow U \cap V$  are  $T^3$ -fibre bundles yielding the same monodromy representation  $\pi_1(U \cap V, b) \rightarrow SL_3(\mathbf{Z}), b \in U \cap V$  a basepoint. Then as observed earlier, because  $f_U$  and  $f_V$  have sections, there is an isomorphism  $\varphi$  in a commutative diagram

$$\begin{array}{ccc} f_U^{-1}(U \cap V) & \xrightarrow{\varphi} & f_V^{-1}(U \cap V) \\ \downarrow f_U & & \downarrow f_V \\ U \cap V & \xrightarrow{=} & U \cap V \end{array}$$

which takes a given section of  $f_U$  to a given section of  $f_V$ . Thus we can glue  $X_U$  and  $X_V$  via  $\varphi$  to obtain a  $T^3$ -fibration  $f : X \rightarrow U \cup V$ , with a section.

This gluing construction extends easily to the case that  $f_U : f_U^{-1}(U \cap V) \rightarrow U \cap V$  and  $f_V : f_V^{-1}(U \cap V) \rightarrow U \cap V$  are well-behaved  $T^3$ -fibrations whose discriminant loci coincide, and only have singular fibres of type (2, 2), assuming that locally the fibrations are of the form given in Example 2.6, (3). In this case, as long as the monodromy representations for  $f_U$  and  $f_V$  coincide, one can still find an isomorphism  $\phi : f_U^{-1}(U \cap V) \rightarrow f_V^{-1}(U \cap V)$  as above.

Now given  $f_0 : X_0 \rightarrow B_0$  satisfying the hypotheses of the theorem, choose an open covering  $\{U_i\}$  of  $\Delta$ ,  $U_i \subseteq B$ , such that  $X_{0,i} = f_0^{-1}(U_i \cap B_0) \rightarrow U_i \cap B_0$  is of the type given in Example 2.6, (3)-(5) or Example 2.10. In each case this is compactified to  $X_i \rightarrow U_i$  with a choice of section, and these compactifications can then be glued into  $f_0 : X_0 \rightarrow B_0$ , matching up the chosen sections, to give the desired fibration. It is easy to see this fibration is well-behaved. •

*Remark 2.11.* Theorem 2.1 has produced a topological manifold  $X$ , but it will be important to know that this manifold has a smooth structure if  $B$  and  $\Delta_g \subset B$  are smooth. It will not matter what the smooth structure is, because we will be interested in situations where [20], Theorem 6 applies, which implies that given suitable hypotheses, all smooth structures on  $X$  are diffeomorphic.

The construction of Proposition 2.5 produces a smooth manifold  $\bar{X}$  as long as  $\bar{Y}$  and  $S \subseteq \bar{Y}$  are smooth. Thus the only places in the constructions of Example 2.6 where we leave the smooth category are (4) and (5). In (4), the  $S$  we constructed in  $\bar{Y}$  is not smooth. However, one can find a homeomorphism  $\varphi$  of  $\bar{Y}$  which is the identity outside of some neighbourhood of  $T^2 \times \{0\}$ , such that  $\varphi^{-1}(S)$  is smooth. Then we can replace the projection  $p : \bar{Y} \rightarrow B$  with  $p' = p \circ \varphi$  and replace  $S \subseteq \bar{Y}$  with  $S' = \varphi^{-1}(S) \subseteq \bar{Y}$ . Using  $S'$ , we construct  $\bar{\pi} : \bar{X} \rightarrow \bar{Y}$  as before. Then  $\bar{X}$  does have a smooth structure. However, the map  $\bar{f} = p' \circ \bar{\pi} : \bar{X} \rightarrow B$  may not be differentiable, as  $\varphi$  will not be. It is not clear if we expect  $\bar{f}$  to be differentiable at such a singular fibre. However, we can guarantee at least that  $\bar{f}$  is differentiable on  $X^\#$ .

A similar argument produces a smooth structure in (5) on  $X$ .

We conclude this section with a few basic results about the topology of the  $T^3$ -fibrations constructed in this section.

**Theorem 2.12.** *Let  $f_0 : X_0 \rightarrow B_0$  be as in Theorem 2.1, and  $f : X \rightarrow B$  the compactification produced in the proof of Theorem 2.1. If  $B$  is simply connected and  $H^0(B, R^1 f_* \mathbf{Z}/n\mathbf{Z}) = 0$  for all  $n$ , then  $X$  is simply connected.*

*Proof.* Let  $\mu : \tilde{X} \rightarrow X$  be the universal cover of  $X$ , and define a space  $\tilde{B} = \tilde{X} / \sim$ , where  $x \sim y$  if  $f(\mu(x)) = f(\mu(y)) = b$  and  $x$  and  $y$  are in the same connected component of  $(f \circ \mu)^{-1}(b)$ . Then  $f \circ \mu$  factors as  $\tilde{X} \xrightarrow{\tilde{f}} \tilde{B} \xrightarrow{\gamma} B$ .

*Claim.*  $\gamma : \tilde{B} \rightarrow B$  is a covering, and thus since  $B$  is simply connected,  $\gamma$  is an isomorphism.

Proof. First for any point  $b \in B$ , there is a sufficiently small open neighbourhood  $U$  of  $b$  such that  $V = f^{-1}(U) \rightarrow U$  looks like one of the cases of Example 2.6, (3)-(5) or Example 2.10, or else  $V = T^3 \times U$ . Let  $\tilde{V} \rightarrow V$  be the universal covering. I claim  $\tilde{V} \rightarrow U$  has connected fibres. Indeed, if  $X_b$  is a non-singular fibre, then  $V = T^3 \times U$  and  $\tilde{V} = \mathbf{R}^3 \times U$ . If  $X_b$  is a fibre of type (2, 2) or (2, 1), then by construction there is an  $S^1$  action on  $V$  such that  $V/S^1 = T^2 \times U$ , and  $\tilde{V} = V \times_{T^2 \times U} \mathbf{R}^2 \times U$ . If  $X_b$  is of type (1, 2),  $\pi_1(V) = \mathbf{Z}$ , there is a local  $T^2$ -action on  $V$ ,  $V/T^2 = S^1 \times U$ , and  $\tilde{V} = V \times_{S^1 \times U} \mathbf{R} \times U$ . Finally, in the (1, 1) case,  $\pi_1(V) = \mathbf{Z}$  again, and if, as in Example 2.6, (5),  $\pi : V \rightarrow \bar{Y}$  is the quotient by the  $S^1$ -action and  $\tilde{Y} \rightarrow \bar{Y}$  is the universal cover of  $\bar{Y}$ , then  $\tilde{V} = V \times_{\bar{Y}} \tilde{Y}$ . In all these cases, one sees  $\tilde{V} \rightarrow B$  has connected fibres. Now we can conclude that  $\gamma : \tilde{B} \rightarrow B$  is a covering:  $(\mu \circ f)^{-1}(U)$  must consist of a number of connected components  $V_1, \dots, V_n$  which are quotients of the universal covering  $\tilde{V}$ , and hence the maps  $V_i \rightarrow U$  have connected fibres. We conclude that  $\gamma^{-1}(U)$  consists of  $n$  disjoint copies of  $U$ , so  $\gamma$  is a covering space, hence an isomorphism, as  $B$  is simply connected. •

It is now clear that  $\pi_1(X)$  is simply the Galois group of the covering  $\tilde{X}_b \rightarrow X_b$  for  $X_b$  a non-singular fibre. This is an abelian group, hence if non-zero, one would have  $H^1(X, \mathbf{Z}/n\mathbf{Z}) \neq 0$  for some  $n$ . But by the Leray spectral sequence, this is not possible if  $H^0(B, R^1 f_* \mathbf{Z}/n\mathbf{Z}) = 0$  for all  $n$ . •

For the remainder of the section, we assume we have put a differentiable structure on  $X$  as in Remark 2.5.

**Proposition 2.13.** *If  $f : X \rightarrow B$  is as in Theorem 2.1 and  $B \cong S^3$ , then  $w_2(X)$ , the second Steifel-Whitney class of  $X$ , vanishes.*

Proof. Since  $\text{Crit}(f)$  is a union of two-dimensional manifolds,

$$H^2(X, \mathbf{Z}/2\mathbf{Z}) \cong H^2(X^\#, \mathbf{Z}/2\mathbf{Z}),$$

and thus  $w_2(X) \in H^2(X, \mathbf{Z}/2\mathbf{Z})$  coincides with  $w_2(X^\#) \in H^2(X^\#, \mathbf{Z}/2\mathbf{Z})$ . However the tangent bundle of  $X^\#$  fits into an exact sequence

$$0 \rightarrow \mathcal{T}_{X^\#/B} \rightarrow \mathcal{T}_{X^\#} \rightarrow f^{\#*} \mathcal{T}_{S^3} \rightarrow 0,$$

with  $\mathcal{T}_{X^\#/B}|_{X_b^\#}$  the tangent bundle of  $X_b^\#$ . Now both  $\mathcal{T}_{S^3}$  and  $\mathcal{T}_{X^\#/B}$  are trivial vector bundles, and so  $\mathcal{T}_{X^\#}$  is also. Thus  $w_2(X^\#) = 0 = w_2(X)$ . •

The last calculation is that of the first Pontrjagin class of  $X$ . Before carrying this out, we would like to put an orientation on  $\text{Crit}(f)$  given an orientation on  $X$ . This will allow us to define a class  $\text{Crit}(f) \in H^4(X, \mathbf{Z})$  as the Poincaré dual of the corresponding oriented 2-cycle. We do this using the following definition.

**Definition 2.14.**

- (1) If  $g : X' \rightarrow D$  is a  $T^2$ -fibration over a disk as constructed in Example 2.6, (1), there is an immersion  $i : S^2 \rightarrow X'$  onto the singular fibre  $X'_0$ . This immersion fails to be an embedding precisely at the singular point of  $X'_0$ , where two sheets of the immersed  $S^2$  cross. This local structure can be seen in the map  $f : \mathbf{C}^2 \rightarrow \mathbf{R}^2$  of Example 2.3, or equivalently, in the map  $\mathbf{C}^2 \rightarrow \mathbf{C}$  given by  $(z_1, z_2) \mapsto z_1 z_2$ . Given an orientation on  $S^2$ , we call the orientation on  $X'$  for which these two sheets intersect positively the *positive orientation* on  $X'$ . Note this is independent of the choice of orientation on  $S^2$ .
- (2) Given  $f : X \rightarrow B$  a  $T^3$ -fibration produced by Theorem 2.1, and an orientation on  $X$ , then  $\text{Crit}(f)$  is a union of connected two-manifolds  $\bigcup S_i$  meeting at most at points. We can orient each  $S_i$  as follows. For a point  $b \in \Delta_g \cap f(S_i)$ , there is a neighbourhood  $U = D \times (0, 1)$  of  $b$  such that  $f^{-1}(U) = X' \times (0, 1) \times S^1$ , so that  $f$  is induced by a map  $g : X' \rightarrow D$ , as in Definition 1.2. Take the positive orientation on  $X'$  over  $U$ . Then  $S_i \cap f^{-1}(U)$  is the surface  $S = \text{Crit}(g) \times (0, 1) \times S^1$  meeting  $X' \times \{1/2\} \times \{p\}$  transversally. Orient  $S$  so that it meets this latter surface positively. If each  $S_i$  is orientable, this gives an orientation on  $S_i$  for each  $i$ , and hence makes  $\text{Crit}(f)$  into an oriented two-cycle. We call this orientation on  $\text{Crit}(f)$  the *canonical orientation*. We shall see in Theorem 2.17 that this orientation does not depend on the choice of  $b \in \Delta_g \cap f(S_i)$ , and that  $S_i$  is orientable.

*Example 2.15.* Let  $g : X' \rightarrow D$  be as constructed in Example 2.6, (1), a well-behaved  $T^2$ -fibration with a singular  $I_1$  fibre. Put an orientation  $\eta_D$  on  $D$  and choose a basis  $e_1, e_2$  of  $H_1(X'_b, \mathbf{Z})$  so that a positive (counter-clockwise) loop  $\gamma$  in  $D^*$  has monodromy  $\begin{pmatrix} 1 & 1 \\ 0 & 1 \end{pmatrix}$  in this basis. Take  $e_1 \wedge e_2$  to give an orientation on a fibre. Then the induced orientation  $\eta_D \wedge e_1 \wedge e_2$  on  $X'$  is positive. To see this, one can for example look at the standard family of degenerating elliptic curves, identifying  $D$  with the unit disk in  $\mathbf{C}$  with the standard orientation, and taking a family with period  $\tau = \frac{1}{2\pi i} \log z$ . Then the above described orientation on  $X'$  is the same as that given by the complex structure, and hence  $X'$  is positively oriented.

Let  $f : X = X' \times (0, 1) \times S^1 \rightarrow B = D \times (0, 1)$  be the induced fibration, with  $X'$  positively oriented by the orientation  $\eta_{X'}$ , and  $(0, 1) \times S^1$  given some orientation  $\eta_{(0,1) \times S^1}$ . Suppose  $X$  is assigned the induced product orientation  $\eta_{X'} \wedge \eta_{(0,1) \times S^1}$ . Then the canonical orientation on  $\text{Crit}(f) = \text{Crit}(g) \times (0, 1) \times S^1$  is then clearly the induced orientation  $\eta_{(0,1) \times S^1}$ .

*Example 2.16.* This is needed in the proof of Theorem 4.4. Consider a  $T^3$ -fibration  $f : \bar{X} \rightarrow B = \mathbf{R}^3$  with a line of type (2, 2) fibres constructed via the method of Example 2.8. In other words, one takes  $\bar{Y} = S^1 \times B$ ,  $p \in S^1$  a point,  $l \subseteq \mathbf{R}^3$  a line, and obtain  $\bar{X}$  by compactifying a  $T^2 = T(L)$ -bundle over  $Y = S^1 \times B - \{p\} \times l$  with Chern class  $c_1 \in L$  primitive. This yields a map  $\bar{\pi} : \bar{X} \rightarrow \bar{Y}$ , and  $f$  is obtained as the composition of  $\bar{\pi}$  and the projection  $\bar{Y} \rightarrow B$ .

Let  $H \subseteq \mathbf{R}^3$  be a plane containing  $l$ , and decompose  $H$  into two closed half-planes  $H_1$  and  $H_2$ , with  $H = H_1 \cup H_2$  and  $l = H_1 \cap H_2$ . Let  $D_i = \bar{\pi}^{-1}(\{p\} \times H_i)$ . Then  $D_i$  is a smooth four-manifold, and  $D_1$  and  $D_2$  intersect transversally along  $\text{Crit}(f)$ . Orient  $D_1$  and  $D_2$  as follows. Choose a basis  $v_1, v_2$  of the tangent space  $\mathcal{T}_H$  of  $H$ , and a basis  $w_1, w_2$  of  $L \otimes_{\mathbf{Z}} \mathbf{R}$ . For  $p_i \in \{p\} \times H_i$ , the tangent space  $\mathcal{T}_{D_i, y_i}$  to a point  $y_i \in \bar{\pi}^{-1}(p_i)$  can be decomposed as  $\mathcal{T}_H \oplus (L \otimes_{\mathbf{Z}} \mathbf{R})$ , with  $\bar{\pi}_*$  mapping  $\mathcal{T}_H$  isomorphically to the tangent space of  $\{p\} \times H$ . Orient  $D_i$  using  $\eta_{D_i} = v_1 \wedge w_1 \wedge v_2 \wedge w_2$ . The important thing here is that this gives orientations on  $D_1$  and  $D_2$  which are consistent in some sense. I claim that the oriented intersection  $D_1 \cap D_2$  is the canonical orientation on  $\text{Crit}(f)$ , irrespective of the orientation on  $\bar{X}$ . (Of course, the orientation of  $D_1 \cap D_2$  depends on the orientation on  $\bar{X}$ , as does the canonical orientation on  $\text{Crit}(f)$ .)

To see this, write as usual  $\bar{X} = X' \times \mathbf{R} \times S^1$ , with  $g : X' \rightarrow \mathbf{R}^2$  as in Example 2.6, (1). By construction of  $X'$ , an open neighbourhood  $U$  of  $\text{Crit}(g)$  can be identified with  $\mathbf{C}^2$ , so that  $g : U \rightarrow \mathbf{R}^2$  coincides with the Harvey-Lawson map  $f_{2.3} : \mathbf{C}^2 \rightarrow \mathbf{R}^2$  of Example 2.3. Furthermore, this can be done so that  $D_i \cap (U \times \{q\})$  (for a point  $q \in \mathbf{R} \times S^1$ ) coincides with  $\{z_i = 0\} \subseteq \mathbf{C}^2$ . Now the positive orientation  $\eta_{X'}$  on  $X'$  coincides with the orientation induced by the complex structure on  $\mathbf{C}^2 \cong U$ . Thus in particular, with orientations  $\eta_{D_i \cap (U \times \{q\})}$  being induced by the complex structure on  $\{z_i = 0\}$ ,  $D_1 \cap (U \times \{q\})$  and  $D_2 \cap (U \times \{q\})$  intersect positively at  $\text{Crit}(g)$ . Now choose an orientation  $\eta_{\mathbf{R} \times S^1}$  on  $\mathbf{R} \times S^1$  so that  $\eta_{X'} \wedge \eta_{\mathbf{R} \times S^1}$  is the given orientation on  $X$ . Then with  $D_i$  oriented by  $\eta_{D_i \cap (U \times \{q\})} \wedge \eta_{\mathbf{R} \times S^1}$ , it is clear that the orientation on the intersection  $D_1 \cap D_2 = \text{Crit}(g) \times \mathbf{R} \times S^1 = \text{Crit}(f)$  is  $\eta_{\mathbf{R} \times S^1}$ , which by Example 2.15 is the canonical orientation on  $\text{Crit}(f)$ . On the other hand, the  $\eta_{D_i}$  either both coincide with  $\eta_{D_i \cap (U \times \{q\})} \wedge \eta_{\mathbf{R} \times S^1}$  or both have the opposite sign. Hence, with the orientations  $\eta_{D_1}$  and  $\eta_{D_2}$ , the induced intersection orientation on  $D_1 \cap D_2$  coincides with the canonical orientation on  $\text{Crit}(f)$ .

**Theorem 2.17.** *If  $f : X \rightarrow B$  is as in Theorem 2.1,  $B \cong S^3$ , and  $\text{Crit}(f) = \bigcup S_i$  as in Definition 2.14, then*

- (1) *each  $S_i$  is orientable and the canonical orientation is well-defined.*

(2)  $p_1(X) = -2\text{Crit}(f) \in H^4(X, \mathbf{Q})$ .

(3) If  $X$  has an almost complex structure in which  $c_1(X) = 0$ , then  $c_2(X) = \text{Crit}(f)$ .

Proof. (3) follows from (2) and the fact that  $p_1(X) = p_1(\mathcal{T}_X) = -c_2(\mathcal{T}_X \otimes_{\mathbf{R}} \mathbf{C}) = -2c_2(\mathcal{T}_X) + c_1(\mathcal{T}_X)^2$  if  $\mathcal{T}_X$  is already a complex vector bundle.

For (2), the argument of the proof of Proposition 2.13. already shows that  $p_1(X)$  is a cohomology class supported on  $\text{Crit}(f)$ . Thus we will be able to reduce the calculation of  $p_1(X)$  to a local calculation near  $\text{Crit}(f)$ . To compute  $p_1(\mathcal{T}_X) = -c_2(\mathcal{T}_X \otimes_{\mathbf{R}} \mathbf{C})$ , note that  $ch(\mathcal{T}_X \otimes_{\mathbf{R}} \mathbf{C}) = 6 - c_2(\mathcal{T}_X \otimes_{\mathbf{R}} \mathbf{C}) \in H^*(X, \mathbf{Q})$ , as  $c_1(\mathcal{T}_X \otimes_{\mathbf{R}} \mathbf{C}) = c_3(\mathcal{T}_X \otimes_{\mathbf{R}} \mathbf{C}) = 0$ . Thus it is sufficient to calculate the degree 4 part of  $ch(\mathcal{T}_X \otimes_{\mathbf{R}} \mathbf{C})$ .

Let  $N \subseteq X$  be a small open tubular neighbourhood of  $\text{Crit}(f)$ . One then has an exact sequence in K-theory (see [13], I, §9 for notation used)

$$K(X, X - N) \rightarrow K(X) \rightarrow K(X - N).$$

From the proof of Proposition 2.13, there is an isomorphism  $\sigma : (\mathcal{T}_X \otimes \mathbf{C})|_{X-N} \rightarrow \mathbf{C}_{X-N}^6$  of vector bundles, where  $\mathbf{C}_{X-N}$  denotes the trivial vector bundle on  $X - N$ . Thus  $[\mathcal{T}_X \otimes_{\mathbf{R}} \mathbf{C}] - [\mathbf{C}_X^6] \in K(X)$  maps to zero in  $K(X - N)$ , and hence  $[\mathcal{T}_X \otimes_{\mathbf{R}} \mathbf{C}] - [\mathbf{C}_X^6]$  comes from an element of  $K(X, X - N)$ . Such an element is represented by  $[\mathcal{T}_X \otimes \mathbf{C}, \mathbf{C}_X^6, \sigma]$ . Now there is a commutative square

$$\begin{array}{ccc} K(X, X - N) & \longrightarrow & K(X) \\ \downarrow ch & & \downarrow ch \\ H^*(X, X - N, \mathbf{Q}) & \longrightarrow & H^*(X, \mathbf{Q}) \end{array}$$

A word of explanation is required for the first vertical map. To define  $ch : K(X, X - N) \rightarrow H^*(X, X - N, \mathbf{Q})$ , use the fact that  $K(X, X - N) = \tilde{K}(X/(X - N))$ , with base point  $p$  the image of  $X - N$  in  $X/(X - N)$ . Then there is the usual  $ch : \tilde{K}(X/(X - N)) \rightarrow \tilde{H}^*(X/(X - N), \mathbf{Q}) = H^*(X/(X - N), \{p\}, \mathbf{Q})$ , and this can be composed with the pull-back  $H^*(X/(X - N), \{p\}, \mathbf{Q}) \rightarrow H^*(X, X - N, \mathbf{Q})$ .

Thus, to compute the degree 4 part of  $ch(\mathcal{T}_X \otimes_{\mathbf{R}} \mathbf{C}) = ch([\mathcal{T}_X \otimes_{\mathbf{R}} \mathbf{C}] - [\mathbf{C}_X^6])$ , we compute the degree 4 part of  $ch([\mathcal{T}_X \otimes_{\mathbf{R}} \mathbf{C}, \mathbf{C}_X^6, \sigma])$  in  $H^4(X, X - N, \mathbf{Q})$ , and take its image under the map to  $H^4(X, \mathbf{Q})$ . Now  $H^4(X, X - N, \mathbf{Q}) \cong H_2(N, \mathbf{Q})$  by Lefschetz duality. First suppose that if  $\text{Crit}(f) = \bigcup S_i$  is the decomposition of  $\text{Crit}(f)$  into connected 2-manifolds, all the  $S_i$ 's are orientable. Then  $H_2(N, \mathbf{Q})$  is generated by the homology classes of the  $S_i$  (with some chosen orientation). In particular, given a class  $\alpha \in H^4(X, X - N, \mathbf{Q})$ , it can be determined by evaluating it on suitable 4-cycles in  $H_4(X, X - N, \mathbf{Q})$ . Explicitly, fixing

$i$ , let  $b_i \in f(S_i) \cap \Delta_g$ , and let  $U_i$  be an open neighbourhood of  $b$  as in Definition 1.2, so that  $f^{-1}(U_i) = X' \times (0, 1) \times S^1$ . Fixing  $p \in S^1$ , let  $X'_i = (X' \times \{1/2\} \times \{p\}) \cap \overline{N}$ . Furthermore, taking the positive orientation on  $X'$ , we obtain an orientation on  $X'_i$ , defining a class  $X'_i \in H_4(X, X - N, \mathbf{Q})$ . We take the canonical orientation on  $S_i$ , so that  $X'_i \cdot S_i = +1$ . Thus given a cohomology class  $\alpha \in H^4(X, X - N, \mathbf{Q})$ , we can write

$$\alpha = \sum (X_i \cdot \alpha) S_i.$$

We apply this analysis to  $ch([\mathcal{T}_X \otimes_{\mathbf{R}} \mathbf{C}, \mathbf{C}^6, \sigma])$ , noting that this lives entirely in  $H^4(X, X - N, \mathbf{Q})$ . Restricting  $\mathcal{T}_X \otimes_{\mathbf{R}} \mathbf{C}$  and  $\sigma$  to  $X'_i$ , one obtains an element of  $K(X'_i, \partial X'_i)$ , and one has an exact sequence

$$0 \rightarrow \mathcal{T}_{X'_i} \rightarrow \mathcal{T}_X|_{X'_i} \rightarrow \mathcal{N} \rightarrow 0.$$

The normal bundle  $\mathcal{N}$  is trivial. In addition, via the fibration  $g_i : X'_i \rightarrow D$  one obtains a trivialization  $\sigma'$  of  $\mathcal{T}_{X'_i}$  away from  $\text{Crit}(g_i)$ , as in Proposition 2.13, compatible with the trivialization of  $\mathcal{T}_X|_{X'_i}$ . Thus

$$[\mathcal{T}_X \otimes_{\mathbf{R}} \mathbf{C}|_{X'_i}, \mathbf{C}^6_{X'_i}, \sigma|_{\partial X'_i}] = [\mathcal{T}_{X'_i} \otimes_{\mathbf{R}} \mathbf{C}, \mathbf{C}^4_{X'_i}, \sigma']$$

in  $K(X'_i, \partial X'_i)$ . Note that  $H^p(X'_i, \partial X'_i, \mathbf{Q}) = 0$  if  $p \neq 4$  and  $\mathbf{Q}$  if  $p = 4$ . We observe that  $ch([\mathcal{T}_{X'_i} \otimes_{\mathbf{R}} \mathbf{C}, \mathbf{C}^4_{X'_i}, \sigma']) = -2 \in H^4(X'_i, \partial X'_i, \mathbf{Q})$  (with the positive orientation). To see this, one either performs a direct calculation or observes that on an elliptically fibred K3 surface  $Y$  with 24  $I_1$  fibres,  $\int_Y ch(\mathcal{T}_Y \otimes \mathbf{C}) = -48$ , and thus each singular fibre must contribute  $-2$  to  $ch$ . Thus  $X'_i \cdot ch([\mathcal{T}_X \otimes \mathbf{C}, \mathbf{C}^6, \sigma]) = -2$ , so  $ch([\mathcal{T}_X \otimes \mathbf{C}, \mathbf{C}^6, \sigma]) = -\sum 2S_i = -2\text{Crit}(f)$ . (Note this makes it clear that the orientation on  $S_i$  is independent of the choice of  $b_i \in \Delta_g \cap f(S_i)$ ; otherwise we would get two different values for  $ch([\mathcal{T}_X \otimes_{\mathbf{R}} \mathbf{C}, \mathbf{C}^6_X, \sigma])$ .) Thus the degree 4 piece of  $ch(\mathcal{T}_X \otimes \mathbf{C})$  is  $-2\text{Crit}(f) \in H^4(X, \mathbf{Q})$ . Thus  $p_1(X) = -2\text{Crit}(f)$ .

Finally suppose that some of the  $S_i$ 's were not orientable. Then  $H_2(N, \mathbf{Q})$  is generated only by those  $S_i$ 's which are orientable. In particular, if  $S_i$  is not orientable, then we can choose an  $X'_i$  as before intersecting  $S_i$  transversally. However, such an  $X'_i$  is now homologous to zero, and thus  $ch([\mathcal{T}_X \otimes_{\mathbf{R}} \mathbf{C}|_{X'_i}, \mathbf{C}^6_{X'_i}, \sigma|_{\partial X'_i}]) = 0$ , which is a contradiction with the earlier calculation of this Chern character. Thus all  $S_i$ 's must be orientable. This proves (1) and (2). •

### §3. Warm-up: Local Mirror Symmetry?

Let  $N \cong \mathbf{Z}^n$ , and let  $M = \text{Hom}(N, \mathbf{Z})$  be the dual lattice. Put  $N_{\mathbf{R}} := N \otimes_{\mathbf{Z}} \mathbf{R}$ . Let  $\sigma \subseteq N_{\mathbf{R}}$  be a strongly convex rational polyhedral cone. We will assume that  $\sigma$  is a

Gorenstein canonical cone. This means that if  $n_1, \dots, n_s \in N$  are the set of generators of 1-dimensional faces of  $\sigma$ , then there exists an  $m_0 \in M$  such that  $\langle m_0, n_i \rangle = 1$  for all  $i$  and  $\langle m_0, n \rangle \geq 1$  for all  $n \in \sigma \cap (N - \{0\})$ . Denote by  $Y_\sigma$  the corresponding affine toric variety.  $Y_\sigma$  has Gorenstein canonical singularities. Let  $P$  be the convex hull of  $n_1, \dots, n_s$ , and suppose there is a triangulation of  $P$  such that the fan  $\Sigma$  obtained as the cone over this triangulation yields a non-singular toric variety  $Y_\Sigma$ . Then  $Y_\Sigma \rightarrow Y_\sigma$  is a crepant resolution, and  $K_{Y_\Sigma} = 0$ .

We will construct a topological  $T^{n-1} \times \mathbf{R}$  fibration on  $Y_\Sigma$  which appears to be a natural generalization of the Harvey-Lawson example given in Example 2.3. This will prove to be a useful guide in constructing a  $T^3$ -fibration on the quintic in §4, and also offer a possible insight into the phenomenon of local mirror symmetry discussed in [4].

Let  $T_{\mathbf{C}}(N) := N \otimes_{\mathbf{Z}} \mathbf{C}^* = \text{Hom}(M, \mathbf{C}^*)$ ,  $T(N) := N \otimes_{\mathbf{Z}} U(1)$ . There is a map  $-\log |\cdot| : T_{\mathbf{C}}(N) \rightarrow N_{\mathbf{R}}$  with kernel  $T(N)$ . There is the standard action of  $T_{\mathbf{C}}(N)$  on  $Y_\Sigma$ , which restricts to a  $T(N)$  action. It is also standard (see [16], §1.3) that  $Mc(\Sigma) := Y_\Sigma / T(N)$  is a real  $n$ -dimensional manifold with corners. Let  $q : Y_\Sigma \rightarrow Mc(\Sigma)$  be the quotient map. By [16], Proposition 1.8,  $N_{\mathbf{R}}$  acts continuously on  $Mc(\Sigma)$  in such a way that  $q$  is equivariant with respect to  $-\log |\cdot| : T_{\mathbf{C}}(N) \rightarrow N_{\mathbf{R}}$ . The orbits of the  $N_{\mathbf{R}}$  action on  $Mc(\Sigma)$  are isomorphic to  $N_{\mathbf{R}} / \mathbf{R}\tau$  for  $\tau$  ranging through all cones in the fan  $\Sigma$ . Furthermore, if  $\mathcal{O}_\tau$  is the orbit corresponding to  $\tau$ , then  $\mathcal{O}_\tau \subseteq \overline{\mathcal{O}_{\tau'}}$  if and only if  $\tau' \subseteq \tau$ .

*Example 3.1.* (1) Let  $\sigma = \Sigma$  be generated by  $e_1, \dots, e_n \in N$  a basis for  $N$  so that  $Y_\Sigma = Y_\sigma = \mathbf{C}^n$ . Then  $Mc(\Sigma)$  is naturally identified with  $\mathbf{R}_{\geq 0}^n$ , via  $\mu : Y_\Sigma \rightarrow \mathbf{R}_{\geq 0}^n$  given by  $\mu(z_1, \dots, z_n) = (|z_1|, \dots, |z_n|)$ . The orbit  $\mathbf{R}_{>0}^n$  is  $\mathcal{O}_{\{0\}, \{0\}} \times \mathbf{R}_{>0}^{n-1} = \mathcal{O}_{\mathbf{R}_{\geq 0}e_1}$ ,  $\{(0, 0)\} \times \mathbf{R}_{>0}^{n-2} = \mathcal{O}_{\mathbf{R}_{\geq 0}e_1 + \mathbf{R}_{\geq 0}e_2}$ , etc.

(2) Let  $Y_\sigma = \mathbf{C}^3 / \mathbf{Z}_3$ , where the group action is generated by  $(z_1, z_2, z_3) \mapsto (\xi z_1, \xi z_2, \xi z_3)$  with  $\xi$  a primitive third root of unity. The cone  $\sigma$  is the cone generated by

$$(1, 0, 0), (0, 1, 0), (0, 0, 1)$$

in the lattice  $\mathbf{Z}^3 + \frac{1}{3}(1, 1, 1)\mathbf{Z}$ . The resolution is given by the fan  $\Sigma$  determined by the triangulation with interior vertex  $\frac{1}{3}(1, 1, 1)$  depicted here:

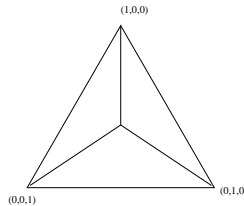

Figure 3.1



$Mc(\Sigma)$  is homeomorphic (but not as a manifold with corners) to  $\mathbf{R}_{\geq 0} \times \mathbf{R}^2$ , where  $\mathbf{R}_{> 0} \times \mathbf{R}^2$  is the dense orbit corresponding to the cone  $\{0\}$ , and  $\{0\} \times \mathbf{R}^2$  decomposes into orbits as depicted in Figure 3.2.

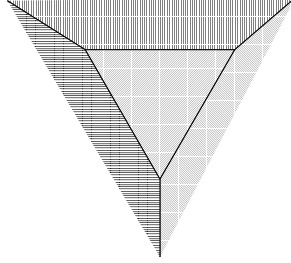

Figure 3.2

In general,  $Mc(\Sigma)$  is homeomorphic to  $\mathbf{R}_{\geq 0} \times \mathbf{R}^{n-1}$ , with the orbit  $\mathcal{O}_{\{0\}} = \mathbf{R}_{> 0} \times \mathbf{R}^{n-1}$ . The boundary of  $Mc(\Sigma)$  is the union of codimension  $\geq 1$  orbits. It will be useful to identify  $\partial Mc(\Sigma)$  with the  $n - 1$ -plane containing the polyhedron  $P$  in such a way that the union of codimension  $\geq 2$  orbits of  $N_{\mathbf{R}}$  is the  $n - 2$ -skeleton of the dual cell complex of the triangulation of  $P$  used to produce  $\Sigma$ . For example, we picture the 1-skeleton of Figure 3.2 as the dark lines in

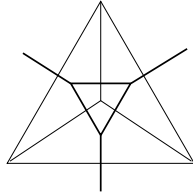

Figure 3.3

Now let  $N_{m_0} \subseteq N$  be the sublattice given by

$$N_{m_0} = \{n \in N \mid \langle m_0, n \rangle = 0\}.$$

Then  $q$  factors via

$$Y_{\Sigma} \xrightarrow{q_1} Y_{\Sigma}/T(N_{m_0}) \xrightarrow{q_2} Mc(\Sigma).$$

Consider first the map  $q_2$ . The fibres of  $q$  over  $\mathcal{O}_{\{0\}}$  are isomorphic to  $T(N)$ ; thus the fibres of  $q_2$  over  $\mathcal{O}_{\{0\}}$  are circles. On the other hand, for a point  $y \in Mc(\Sigma)$  in a codimension one orbit  $\mathcal{O}_{\tau}$ ,  $\tau$  a 1-dimensional cone in  $\Sigma$ ,  $y' \in q_2^{-1}(y)$ ,  $y'' \in q_1^{-1}(y')$ , the stabilizer of  $y''$  in the group  $T(N)$  is  $\mathbf{R}\tau/(\mathbf{R}\tau \cap N)$ . Since  $(\mathbf{R}\tau) \cap N_{m_0} = \{0\}$ , the fibre  $q_1^{-1}(y')$  is an  $n - 1$  dimensional torus, as is the fibre  $q^{-1}(y)$ . Thus  $q_2^{-1}(y) = \{y'\}$ . Thus we see that  $q_2^{-1}(\partial Mc(\Sigma)) \rightarrow \partial Mc(\Sigma)$  is a homeomorphism. In particular,  $Y_{\Sigma}/T(N_{m_0})$  can be identified with  $\mathbf{C} \times \mathbf{R}^{n-1}$ , with  $q_2$  given by  $(z, x) \mapsto (|z|, x) \in \mathbf{R}_{\geq 0} \times \mathbf{R}^{n-1}$ . We stress of

course that this identification is purely topological, and this may not be the most natural thing to do.

Now let  $B = \mathbf{R}^n$  and let  $f : Y_\Sigma \rightarrow B$  be the composition of  $q_1 : Y_\Sigma \rightarrow Y_\Sigma/T(N_{m_0}) \cong \mathbf{C} \times \mathbf{R}^{n-1}$  with  $r : (z, x) \mapsto (\text{Im } z, x) \in \mathbf{R} \times \mathbf{R}^{n-1} = B$ . Since  $q_2$  identifies  $\{0\} \times \mathbf{R}^{n-1} \subseteq \mathbf{C} \times \mathbf{R}^{n-1}$  with  $\{0\} \times \mathbf{R}^{n-1} \subseteq \mathbf{R}_{\geq 0} \times \mathbf{R}^{n-1}$ , we can use  $q_2$  to identify the union of codimension  $\geq 2$  orbits in  $Mc(\Sigma)$  with a subset  $\Delta'$  of  $Y_\Sigma/T(N_{m_0})$ . Let  $\Delta = r(\Delta') \subseteq B$ . It is then clear that  $f : Y_\Sigma \rightarrow B$  is a fibration with general fibre  $T^{n-1} \times \mathbf{R}$ , but for a point  $b \in \Delta$  in a dimension  $k$  orbit,  $f^{-1}(b) \cong T^{n-1} \times \mathbf{R}/T^{n-1-k} \times \{0\}$ , by which we mean we divide the torus  $T^{n-1} \times \{0\}$  out by the action of a  $T^{n-1-k}$ .

*Example 3.2.* (1) Continuing Example 3.1, (1), let  $\gamma : \mathbf{R}_{\geq 0}^n \rightarrow \mathbf{R}_{\geq 0} \times \mathbf{R}^{n-1}$  be given by  $\gamma(x_1, \dots, x_n) = (\prod x_i, x_1^2 - x_2^2, \dots, x_1^2 - x_n^2)$ . It is easy to see that  $\gamma$  is a homeomorphism. We can identify  $Y_\Sigma/T(N_{m_0})$  with  $\mathbf{C} \times \mathbf{R}^{n-1}$  so that the map  $q_1$  is given by  $q_1(z_1, \dots, z_n) = (\prod z_i, |z_1|^2 - |z_2|^2, \dots, |z_1|^2 - |z_n|^2) \in \mathbf{C} \times \mathbf{R}^{n-1}$ . Thus  $f : \mathbf{C}^n \rightarrow B$  is given by

$$f(z_1, \dots, z_n) = (\text{Im} \prod z_i, |z_1|^2 - |z_2|^2, \dots, |z_1|^2 - |z_n|^2).$$

This is precisely the Harvey-Lawson example given in Example 2.3.

(2) Continuing Example 3.1, (2), we note we obtain a  $T^2 \times \mathbf{R}$  fibration with discriminant locus  $\Delta$  as depicted by the dark lines in Figure 3.3.

In the three-dimensional case, the map  $Y_\Sigma - q_1^{-1}(\Delta') \rightarrow Y_\Sigma/T(N_{m_0}) - \Delta'$  is a principal  $T^2$ -fibre bundle, with fibres naturally isomorphic to  $T(N_{m_0})$ , and  $Y_\Sigma \rightarrow Y_\Sigma/T(N_{m_0})$  a compactification of this. Recall from Proposition 2.9 that  $H^2(Y_\Sigma/T(N_{m_0}) - \Delta', N_{m_0}) = H_{\Delta'}^3(Y_\Sigma/T(N_{m_0}), N_{m_0}) \cong H_1^{BM}(\Delta', N_{m_0})$ , whose elements can be identified with simplicial 1-chains on  $\Delta' \cup \{\infty\}$  whose boundary is supported on  $\infty$ .

**Proposition 3.3.** *Up to sign, the Chern class of the  $T(N_{m_0})$ -fibre bundle  $q_1 : Y_\Sigma - q_1^{-1}(\Delta') \rightarrow Y_\Sigma/T(N_{m_0}) - \Delta'$  is the 1-chain  $c_1$  on  $\Delta' \cup \{\infty\}$  described as follows. Choose an orientation on  $P$ . View  $\Delta'$  as the 1-skeleton of the dual cell complex of the triangulation of  $P$  determining  $\Sigma$ . Each oriented edge  $E$  of  $\Delta'$  intersects a unique edge  $\langle \tau_i, \tau_j \rangle$  in the triangulation of  $P$ , oriented so that  $E$  and  $\langle \tau_i, \tau_j \rangle$  intersect positively with respect to the chosen orientation on  $P$ . The 1-chain  $c_1$  assigns to the oriented edge  $E$  the element  $\tau_j - \tau_i$  of  $N_{m_0}$ . (See Figure 3.4) This 1-chain has the property that all coefficients of edges are primitive in  $N_{m_0}$ , and the three coefficients associated to edges with a common vertex span  $N_{m_0}$ . In particular, the compactification  $q_1 : Y_\Sigma \rightarrow Y_\Sigma/T(N_{m_0})$  of  $Y_\Sigma - q_1^{-1}(\Delta') \rightarrow Y_\Sigma/T(N_{m_0}) - \Delta'$  coincides with that given in Proposition 2.9.*

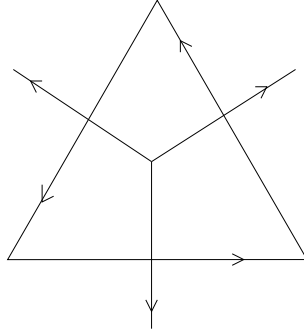

Figure 3.4

Proof. An edge  $E$  of  $\Delta'$  corresponds to a one-dimensional cone  $\tau$  generated by some  $\tau_i$  and  $\tau_j$ , and  $\langle \tau_i, \tau_j \rangle$  is the unique edge of the triangulation of  $P$  intersecting  $E$ . Now if  $y \in \mathcal{O}_\tau \subseteq Mc(\Sigma)$ ,  $y' \in q^{-1}(y)$ , then the stabilizer of  $y'$  in  $T(N_{m_0})$  is

$$\frac{(N_{m_0} \otimes \mathbf{R}) \cap \mathbf{R}\tau}{N_{m_0} \cap \mathbf{R}\tau} = T((\tau_i - \tau_j)\mathbf{Z}).$$

Thus the coefficient in  $c_1$  of the oriented edge  $E$  is  $\pm(\tau_i - \tau_j) \in N_{m_0}$ . Once the sign is chosen for one edge, there is a unique uniform choice of sign for every oriented edge to ensure that  $c_1$  is an element of  $H_1^{BM}(\Delta', N_{m_0})$ . The method of assigning signs given in the statement of the Proposition is one of the two possible choices, with the opposite sign arising from the opposite choice of orientation on  $P$ .

For the last statement, observe that given a three-dimensional cone  $\tau \subseteq \Sigma$ ,  $\tau$  is a simplicial cone, as  $Y_\Sigma$  is non-singular. In particular,  $\tau$  is spanned by  $e_1, e_2, e_3$ , a basis of  $N$ , and  $m_0 = e_1^* + e_2^* + e_3^*$ . Let  $\tau_i$  be the cone spanned by  $e_j$  and  $e_k$ ,  $\{i, j, k\} = \{1, 2, 3\}$ . The coefficients associated to the three edges corresponding to  $\tau_i$  are  $e_2 - e_3$ ,  $e_3 - e_1$  and  $e_1 - e_2$ . These span  $N_{m_0}$ , as desired. •

*Remark 3.4.* This is a rather technical remark which will only be used in the proof of Theorem 4.4. Note that the one-dimensional cones  $\tau$  of  $\Sigma$  correspond to divisors in  $Y_\Sigma$ . One way to identify these divisors is as follows. Identifying  $\mathcal{O}_\tau \subseteq Mc(\Sigma)$  with  $q_2^{-1}(\mathcal{O}_\tau) \subseteq Y_\Sigma/T(N_{m_0})$ , we see that the corresponding divisor  $D_\tau$  is  $q_1^{-1}(\overline{\mathcal{O}_\tau})$ .

Now  $D_\tau$  has an orientation induced by the complex structure on  $D_\tau$ . It is easy to see that in the  $n = 3$  case this orientation can be described as follows: Let  $\langle \tau, \tau_1, \tau_2 \rangle$  be a 2-simplex in the triangulation of  $P$ . Recall that we identified  $\partial Mc(\Sigma)$  with the plane containing  $P$  in such a way that the union of codimension  $\geq 2$  orbits is the 1-skeleton of the dual complex of  $P$ . Thus it is natural to think of  $\tau$  as a point in  $\mathcal{O}_\tau$  and  $\tau_1 - \tau$  and  $\tau_2 - \tau$  as tangent vectors  $v_1, v_2$  respectively in  $\mathcal{T}_{\mathcal{O}_\tau, \tau}$ , the tangent space of the orbit  $\mathcal{O}_\tau$  at

the point  $\tau \in \mathcal{O}_\tau$ . On the other hand, the tangent space of  $D_\tau$  at a point  $y \in q_1^{-1}(\tau)$  can be written as  $H \oplus (N_{m_0} \otimes_{\mathbf{Z}} \mathbf{R})$ , where  $H$  is a subspace mapped isomorphically to  $\mathcal{T}_{\mathcal{O}_\tau, \tau}$  by  $q_{1*}$ . Then the orientation on  $D_\tau$  is given by  $v_1 \wedge (\tau_1 - \tau) \wedge v_2 \wedge (\tau_2 - \tau)$ , thinking of  $v_1, v_2 \in H, \tau_1 - \tau, \tau_2 - \tau \in N_{m_0} \otimes_{\mathbf{Z}} \mathbf{R}$ .

To see this, note this is a local issue, allowing one to reduce to the case that  $\sigma$  is as in Examples 3.1 and 3.2, (1) with  $n = 3$ . Then taking  $\tau = e_1$ ,  $D_\tau$  is the divisor  $z_1 = 0$ , and then  $q_1|_{D_\tau}$  is  $(z_2, z_3) \mapsto (-|z_2|^2, -|z_3|^2)$ . It is then easy to see that the orientation on  $D_\tau$  is as described.

Note that changing the sign of the Chern class  $c_1$  of the  $T(N_{m_0})$ -bundle  $q_1 : Y_\Sigma - q_1^{-1}(\Delta') \rightarrow Y_\Sigma/T(N_{m_0}) - \Delta'$  has the affect of changing the sign of the  $T(N_{m_0})$  action, but doesn't change the above orientation (because  $n - 1 = 2$  is even). This is useful because we can get the right orientation on  $D_\tau$  even if we haven't gotten the sign of  $c_1$  right.

*Remark 3.5.* As a final bit of speculation in the  $n = 3$  case, suppose that there is an inclusion  $Y_\Sigma \subseteq \bar{Y}_\Sigma$  with an extension  $\bar{f} : \bar{Y}_\Sigma \rightarrow B$  of  $f$  with  $\bar{f}$  a well-behaved  $T^3$ -fibration. Then by Corollary 2.2, a dual fibration  $\check{f} : \check{Y}_\Sigma \rightarrow B$  can be constructed. Since  $\bar{f}$  only has singular fibres of type  $(2, 2)$  and  $(1, 2)$ , all singular fibres of  $\check{f}$  will be of type  $(2, 2)$  and  $(2, 1)$ . By the construction of Example 2.6, (4) of fibres of type  $(2, 1)$ , the critical locus of  $\check{f}$  is a topological two-manifold  $S$  fibred over  $\Delta$ . If  $\Sigma$  is a cone over a triangulation of the polygon  $P$  contained in  $\{n \in N | \langle m_0, n \rangle = 1\}$ , then the number of punctures of  $S$  is the number of edges of  $P$ , and the genus of  $S$  is the number of interior vertices of  $P$ . Here is a genus 2 example, the triangulated polygon  $P$  shown in lighter lines and  $\Delta$  shown in darker lines:

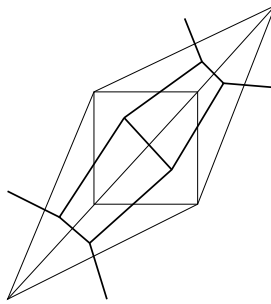

Figure 3.5

(see [4], Figure 3). Now [4] suggests through other arguments that the “mirror” of  $Y_\Sigma$  is a curve whose genus is precisely the number of interior vertices of  $P$ . This suggests that in this local setting, this “mirror curve” is the critical locus of  $\check{f}$ . Because it is quite likely one can write down explicit special Lagrangian versions of the fibrations given above in some simple cases, this may prove to be a useful laboratory in which to study the SYZ conjecture. This will be taken up elsewhere.

## §4. A Well-behaved Fibration on the Quintic.

We will now construct a torus fibration  $f : X \rightarrow B$  on the quintic threefold  $X \subseteq \mathbf{P}^4$ . We adopt a different approach to that given in [17] and [21], essentially constructing a  $T^3$ -fibration by hand and then showing the total space of this fibration is diffeomorphic to  $X$ . To do so, we make use of Ruan's description of the monodromy in his fibration, and construct the fibration directly from this data.

Recall the moment map  $\mu : \mathbf{P}^n \rightarrow \Xi$  given by

$$(z_0, \dots, z_n) \rightarrow \frac{\sum_{i=0}^n |z_i|^2 P_i}{\sum_{i=0}^n |z_i|^2},$$

where  $P_0, \dots, P_n$  are the vertices of an  $n$ -simplex  $\Xi \subseteq \mathbf{R}^n$ . Then it is obvious that the restriction of  $\mu$  to each linear subspace  $\{z_{i_1} = \dots = z_{i_{n-p}} = 0\}$  is just the moment map of  $\mathbf{P}^p$ , and the fibre of  $\mu$  over a  $p$ -dimensional face of  $\Xi$  is  $T^p$ . In particular, with  $n = 4$ , the moment map of  $\mathbf{P}^4$  restricted to  $F = \{z_0 z_1 z_2 z_3 z_4 = 0\}$  has image  $\partial\Xi$ , and  $\mu : F \rightarrow \partial\Xi$  is a three-torus fibration, with fibres dropping rank on lower dimensional simplices of  $\partial\Xi$ . We will construct  $X$  so as to be a topological resolution of  $F$ , and so that  $X$  fibres over  $\partial\Xi$ , with  $n = 4$ .

Begin by considering the graph  $\Gamma \subseteq \partial\Xi$  described by Ruan in [17], §4. Namely, if  $P_{ij}$  is the barycenter of the 1-simplex  $\langle P_i, P_j \rangle$ , and  $P_{ijk}$  is the barycenter of the 2-simplex  $\langle P_i, P_j, P_k \rangle$ , the vertices of  $\Gamma$  are  $\{P_{ij}, P_{ijk}\}$ , and the edges of  $\Gamma$  connect  $P_{ij}$  with  $P_{i'j'k'}$  whenever  $\{i, j\} \subseteq \{i', j', k'\}$ . This graph is trivalent. Now take a small tubular neighbourhood  $N_\Gamma$  of  $\Gamma$ , and let  $U = \partial\Xi - \overline{N_\Gamma}$ . Let  $\sigma_i$  be the maximal face of  $\partial\Xi$  given by  $\langle P_0, \dots, \hat{P}_i, \dots, P_4 \rangle$ , and let

$$U_i = \text{Int}(\sigma_i) - \overline{N_\Gamma}.$$

(Here,  $\text{Int}(\sigma) = \sigma - \partial\sigma$ .) Let

$$U^i = \{P = \sum a_i P_i \in \partial\Xi \mid a_i > a_j \text{ for all } j \neq i\} - \overline{N_\Gamma}.$$

Then  $U_i \cap U_j = \phi$ ,  $U^i \cap U^j = \phi$ , for all  $i$  and  $j$ , and  $U^i \cap U_j = \phi$  if and only if  $i = j$ . Also  $U_i$  and  $U^j$  are contractible. Furthermore,

$$U = \bigcup_{i=0}^4 (U^i \cup U_i).$$

We will begin by constructing a  $T^3$ -fibre bundle over  $U$ ,  $f_1 : X_1 \rightarrow U$ .  $f_1$  will be trivial over each  $U_i$  and  $U^i$ , as these sets are contractible, so  $f_1^{-1}(U_i) = T^3 \times U_i$  and

$f_1^{-1}(U^i) = T^3 \times U^i$ . However, we must be precise in identifying these tori. Fix a lattice  $N = \mathbf{Z}^5$  with basis  $e_0, \dots, e_4$ , and let  $N_i = N / \langle e_i, \sum_{j=0}^4 e_j \rangle$ . Then  $N_i^\vee$  is naturally identified with  $\{\sum a_j e_j^* \in N^\vee \mid a_i = \sum a_j = 0\}$ . For a lattice  $N$ , denote by  $T(N)$  as before the torus  $(N \otimes_{\mathbf{Z}} \mathbf{R})/N$ . Identify  $f_1^{-1}(U_i)$  with  $T(N_i) \times U_i$  and  $f_1^{-1}(U^i)$  with  $T(N_i^\vee) \times U^i$ . Define isomorphisms  $T_{ij} : N_i \rightarrow N_j^\vee$  for  $i \neq j$  by taking  $e_0, \dots, \hat{e}_i, \dots, \hat{e}_j, \dots, e_4$  as a basis for  $N_i$  and setting

$$T_{ij}(e_k) = e_k^* - e_i^*.$$

$T_{ij}$  then induces homeomorphisms  $T(N_i) \rightarrow T(N_j^\vee)$ . Glue  $T(N_i) \times U_i$  with  $T(N_j^\vee) \times U^j$  over  $U_i \cap U^j$  via this homeomorphism. This gives a  $T^3$ -bundle  $f_1 : X_1 \rightarrow U$  with a section.

We compute the monodromy of  $f_1 : X_1 \rightarrow U$  about a loop  $\gamma_{ij,k}$  passing around an edge  $\langle P_{ij}, P_{ijk} \rangle$  of the graph  $\Gamma$ . This calculation was also carried out in [17], §4. We first note that this edge lies in a two-simplex which is the common face of  $\sigma_l$  and  $\sigma_m$ , where  $\{i, j, k, l, m\} = \{0, \dots, 4\}$ . In addition,  $P_{ij}$  is contained in the 1-simplex spanned by  $P_i$  and  $P_j$ . Thus we can take  $\gamma_{ij,k}$  to be a simple loop based at  $b \in U_l$ , passing first into  $U^i$ , then  $U_m$ , then  $U^j$  and then back into  $U_l$ . In Figure 4.1 we have depicted the loops  $\gamma_{ij,k}, \gamma_{jk,i}$  and  $\gamma_{ik,j}$ . Note that  $\gamma_{ij,k} \cdot \gamma_{jk,i} = \gamma_{ik,j}$  in  $\pi_1(U, b)$ .

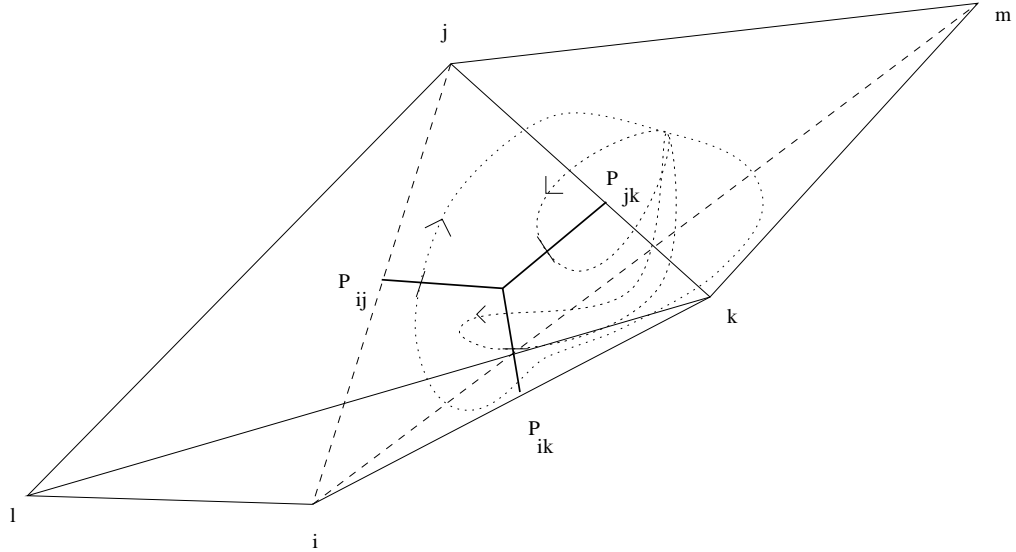

Figure 4.1

Thus the monodromy transformation associated to the loop  $\gamma_{ij,k}$  is  $T_{ij,k} = T_{lj}^{-1} T_{mj} T_{mi}^{-1} T_{li} : N_l \rightarrow N_l$ . In the basis  $e_j, e_k, e_m$  of  $N_l$ , it is easy to calculate that

$$(4.1) \quad \begin{aligned} T_{ij,k}(e_j) &= e_j + 5e_m, \\ T_{ij,k}(e_k) &= e_k, \\ T_{ij,k}(e_m) &= e_m. \end{aligned}$$

Note that from this general formula, we see that

$$T_{ik,j}(e_j) = e_j,$$

$$T_{ik,j}(e_k) = e_k + 5e_m,$$

$$T_{ik,j}(e_m) = e_m$$

and

$$T_{jk,i}(e_j) = e_j - 5e_m,$$

$$T_{jk,i}(e_k) = e_k + 5e_m,$$

$$T_{jk,i}(e_m) = e_m.$$

Now let  $N'_\Gamma$  be a slightly larger tubular neighbourhood of  $\Gamma$  than  $N_\Gamma$ , and let  $U_{ijk}$  be a ball with center  $P_{ijk}$  small enough so it doesn't intersect any dimension 1 faces of  $\partial\Xi$ . Let  $V_{ijk} := N'_\Gamma \cap U_{ijk}$ . To visualise this, we depict the intersection of  $V_{ijk}$  with the face  $\langle P_i, P_j, P_k \rangle$  of  $\partial\Xi$ :

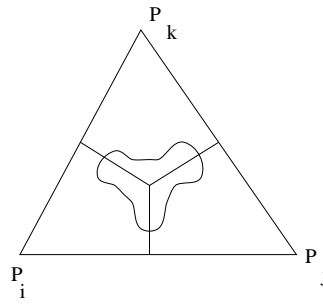

Figure 4.2

Now we build a  $T^3$ -fibration over  $V_{ijk}$  as follows: construct a surface  $S_{ijk} \subseteq T(N_l/\langle e_m \rangle) \times V_{ijk} = T^2 \times V_{ijk}$ . This will be a surface sitting over the following graph  $\Delta_{ijk}$  in  $V_{ijk} \cap \langle P_i, P_j, P_k \rangle$ , represented by the dark lines in the following picture:

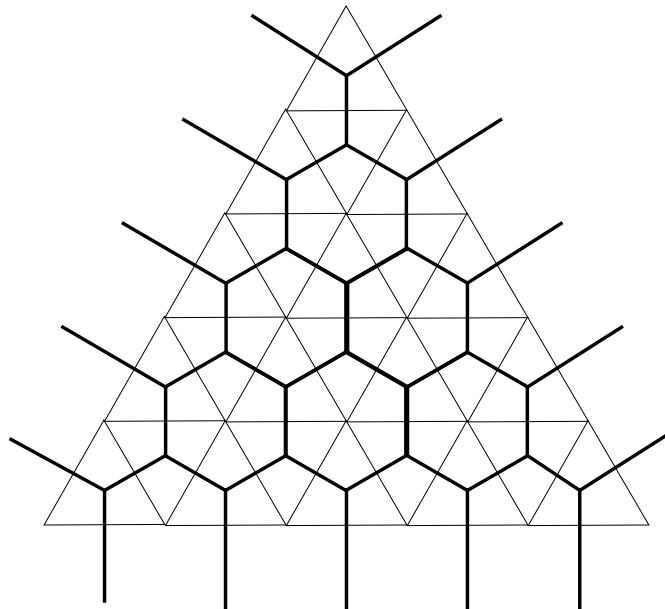

Figure 4.3

Over each edge  $E$  of the graph,  $S_{ijk}$  will be  $E \times S^1$ , with  $S^1 \subseteq T(N_l/\langle e_m \rangle)$  of class  $e_i$ ,  $e_j$  or  $e_k$  depending on whether  $E$  is running northeast-southwest (parallel to the edge  $\langle P_{jk}, P_{ijk} \rangle$  of  $\Gamma$ ), northwest-southeast (parallel to  $\langle P_{ik}, P_{ijk} \rangle$ ) or south-north (parallel to  $\langle P_{ij}, P_{ijk} \rangle$ ) respectively. At each vertex we glue up these cylinders as in Example 2.6 (4), which we can do by the relation  $e_i + e_j + e_k = 0$  in  $N_l/\langle e_m \rangle$ . The surface  $S_{ijk}$  has genus 6 with 15 punctures. Now build an  $S^1$ -bundle over  $T^2 \times V_{ijk} - S$  whose first Chern class is  $1 \in H_S^3(T^2 \times V_{ijk}, \mathbf{Z}) \subseteq H^2(T^2 \times V_{ijk} - S, \mathbf{Z})$ . Using Proposition 2.5, this can be compactified to obtain a  $T^3$ -fibration  $f_{ijk} : X_{ijk} \rightarrow V_{ijk}$  with discriminant locus  $\Delta_{ijk}$ .

Let  $b \in V_{ijk} \cap U_l$ . Take as a basis of  $H_1(f_{ijk}^{-1}(b), \mathbf{Z})$  elements  $e_j, e_k, e_m$ , the first two mapping to  $e_j$  and  $e_k$  in  $T(N_l/\langle e_m \rangle)$ , and  $e_m$  the class of the  $S^1$  fibre of  $X_{ijk} \rightarrow T(N_l/\langle e_m \rangle) \times V_{ijk}$ . Then by construction, possibly after changing the sign of  $e_m$ , the monodromy  $T$  about a suitably oriented loop around one of the edges of  $\Delta_{ijk}$  running parallel to  $\langle P_{ij}, P_{ijk} \rangle$  is given by  $T(e_j) = e_j + e_m, T(e_k) = e_k, T(e_m) = e_m$ . The monodromy about an edge parallel to  $\langle P_{jk}, P_{ijk} \rangle$  is given by  $T(e_j) = e_j - e_m, T(e_k) = e_k + e_m, T(e_m) = e_m$ . Finally, the monodromy about an edge parallel to  $\langle P_{ik}, P_{ijk} \rangle$  is given by  $T(e_j) = e_j, T(e_k) = e_k + e_m$ , and  $T(e_m) = e_m$ .

Now  $V_{ijk} \cap U$  is homotopic to a thrice-punctured sphere, and  $\pi_1(V_{ijk} \cap U, b)$  is generated by  $\gamma_{ij,k}, \gamma_{jk,i}$  and  $\gamma_{ik,j}$ , with the relation  $\gamma_{ij,k} \cdot \gamma_{jk,i} = \gamma_{ik,j}$ . Then by the above discussion of the monodromy about edges of  $\Delta_{ijk}$ , the monodromy of  $f_{ijk}$  around the three loops  $\gamma_{ij,k}, \gamma_{jk,i}$  and  $\gamma_{ik,j}$  coincides precisely with that of  $f_1 : X_1 \rightarrow U$ . Thus we can glue in  $f_{ijk} : X_{ijk} \rightarrow V_{ijk}$  to  $f_1 : X_1 \rightarrow U$ . Doing this for each simplex  $\langle P_i, P_j, P_k \rangle$ , we obtain a new fibration  $f_2 : X_2 \rightarrow U'$ , with  $U' = U \cup \bigcup V_{ijk}$ .

Next let  $U_{ij}$  be a ball centred at  $P_{ij}$ , so that  $\bigcup_{i,j} U_{ij} \cup \bigcup_{i,j,k} U_{ijk}$  covers  $\overline{N_\Gamma}$ . Let



$V_{ij} := U_{ij} \cap N'_\Gamma$ . The situation near  $V_{ij}$  is shown in Figure 4.4.

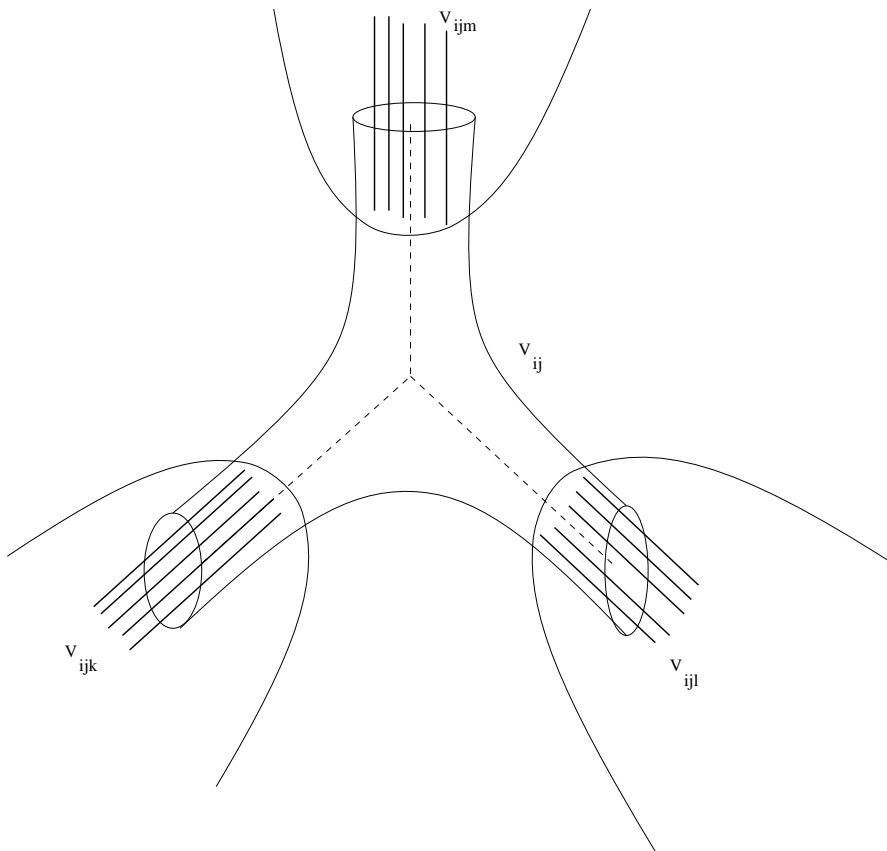

Figure 4.4

Note that the relevant monodromy transformations of loops based at  $b \in U_l$  about the three edges of  $\Gamma$  containing  $P_{ij}$  are  $T_{ij,k}$ ,  $T_{ij,m}$ , and  $T_{ij,m}^{-1} \circ T_{ij,k}^{-1}$ . Note that

$$\begin{aligned} T_{ij,m}(e_j) &= e_j + 5e_k, \\ T_{ij,m}(e_k) &= e_k, \\ T_{ij,m}(e_m) &= e_m. \end{aligned}$$

We then construct  $X_{ij} \rightarrow V_{ij}$  by producing a fibration with discriminant locus  $\Delta_{ij}$  as in

the dark lines of Figure 4.5:

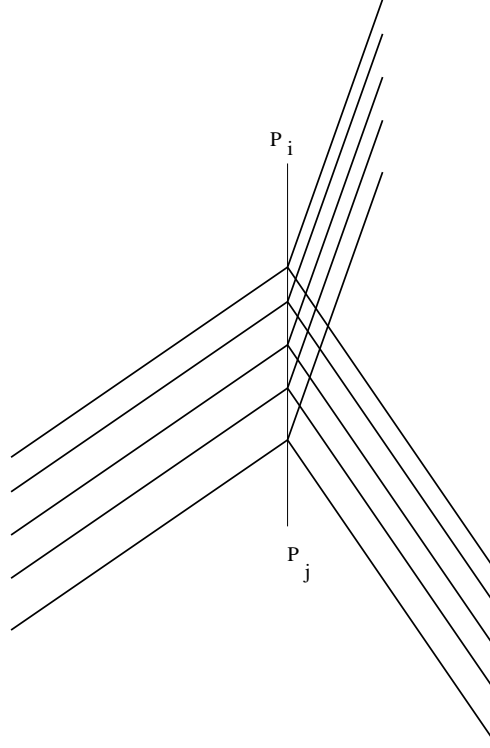

Figure 4.5

This is done so that  $\Delta_{ijk} \cap V_{ij} = \Delta_{ij} \cap V_{ijk}$ . We build this by taking 5 identical copies of the construction of Example 2.10 and gluing them in a chain so that  $X_{ij} \rightarrow V_{ij}$  has five fibres of type (1, 2) over  $V_{ij} \cap \langle P_i, P_j \rangle$ . As  $e_k$  and  $e_m$  are invariant under  $T_{ij,k}$  and  $T_{ij,m}$ , this can also be viewed as the compactification of a  $T^2$ -bundle over  $(T(N_l / \langle e_k, e_m \rangle) \times V_{ij}) - (\{p\} \times \Delta_{ij})$  for some point  $p \in T(N_l / \langle e_k, e_m \rangle)$ . This can be done with the desired monodromy so that  $X_{ij} \rightarrow V_{ij}$  can be glued in to  $f_2 : X_2 \rightarrow U'$  to obtain finally a fibration  $f : X \rightarrow B := \partial \Xi$  with a section.

We note that as in Remark 2.5, putting a differentiable structure on  $\partial \Xi \cong S^3$ , one can put a differentiable structure on  $X$ .

**Theorem 4.1.**  *$f : X \rightarrow B$  is a well-behaved  $T^3$ -fibration, and there is a continuous map  $\xi : X \rightarrow F = \{z_0 z_1 z_2 z_3 z_4 = 0\}$  such that  $f = \mu \circ \xi$ . Furthermore,  $X$  is diffeomorphic to a non-singular quintic threefold.*

*Proof.* The only part of admissibility which doesn't follow immediately from the construction is that  $R^3 f_* \mathbf{Z} = \mathbf{Z}$ . However, this is true locally, and since  $B$  is simply connected, it is true globally. Then well-behavedness is clear by construction.

Before continuing, we introduce some notation. Let  $F_{i_0 \dots i_p} := F_{i_0} \cap \dots \cap F_{i_p}$  where  $F_i = \{z_i = 0\} \subseteq \mathbf{P}^4$ . Let  $F^{[p]} = \coprod_{i_0 < \dots < i_p} F_{i_0 \dots i_p}$ . In particular,  $F^{[0]}$  is the normalization

of  $F$ . Let  $F^{(p)} = \bigcup_{i_0 < \dots < i_p} F_{i_0 \dots i_p}$ . Let  $F_0^{(p)} = F^{(p)} - F^{(p+1)}$ . Let  $i_p : F_0^{(p)} \rightarrow F^{(p)}$  be the inclusion map.

We now construct a map  $\xi : X \rightarrow F$ . Choose a maximal face  $\sigma_l$  of  $\partial\Xi$ . Then by construction,  $f^{-1}(Int(\sigma_l)) = T(N_l) \times Int(\sigma_l)$ . Note that the five-torus  $T(N)$  acts naturally on  $\mathbf{P}^4$  via the standard diagonal action, and  $T(N_l)$  has a natural induced action on  $F_l$ . The quotient map  $F_l - Sing(F) \rightarrow (F_l - Sing(F))/T(N_l)$  coincides with the moment map  $\mu : F_l - Sing(F) \rightarrow Int(\sigma_l)$ , and allows  $F_l - Sing(F)$  to be identified naturally with  $T(N_l) \times Int(\sigma_l) = f^{-1}(Int(\sigma_l))$ .

Now also by construction, if  $\sigma = \langle P_i, P_j, P_k \rangle$  is a face of  $\sigma_l$ , and  $\{i, j, k, l, m\} = \{0, 1, 2, 3, 4\}$ , then there is a natural  $S^1$ -action on  $f^{-1}(Int(\sigma))$  induced by  $e_m \in N_l$ . Again  $f^{-1}(Int(\sigma))/S^1 = T(N_l/\langle e_m \rangle) \times Int(\sigma)$  is naturally identified with  $F_{lm} - Sing(F)$ , so that the projection  $f^{-1}(Int(\sigma))/S^1 \rightarrow Int(\sigma)$  coincides with  $\mu : F_{lm} - Sing(F) \rightarrow Int(\sigma)$ . If  $\tau = \langle P_i, P_j \rangle$  is a dimension one facet of  $\sigma_l$ , there is a natural  $T^2$  action on  $f^{-1}(Int(\tau))$  induced by  $e_k$  and  $e_m$  in  $N_l$  and  $f^{-1}(Int(\tau))/T^2 = T(N_l/\langle e_k, e_m \rangle) \times Int(\tau)$  is naturally identified with  $F_{klm} - Sing(F)$  so that the projection  $f^{-1}(Int(\tau))/T^2 \rightarrow Int(\tau)$  coincides with  $\mu : F_{klm} - Sing(F) \rightarrow Int(\tau)$ .

Now take the topological quotient of  $X$  with respect to the following equivalence relation:

$x \sim y$  if and only if  $f(x) = f(y)$  and either (1)  $f(x)$  is in the interior of a three-dimensional face of  $\partial\Xi$  and  $x = y$ , or (2)  $f(x)$  is in the interior of a dimension two face of  $\partial\Xi$  and  $x$  and  $y$  are identified under the natural  $S^1$ -action described above, or (3)  $f(x)$  is in the interior of a dimension one face of  $\partial\Xi$  and  $x$  and  $y$  are identified under the natural  $T^2$  action described above, or (4)  $f(x)$  is a vertex of  $\Xi$ .

It is then clear that the quotient of  $X$  by this equivalence relation is homeomorphic to  $F$ . Take  $\xi : X \rightarrow F$  to be the quotient map. It is also clear by construction that  $f = \mu \circ \xi$ .

We note at this point that while  $X$  is orientable since  $H^6(X, \mathbf{Z}) = H^3(B, R^3 f_* \mathbf{Z}) = \mathbf{Z}$ , it is worth remarking that this orientation may be chosen to be compatible via the map  $\xi$  with the orientation on  $F - Sing(F)$  induced by the complex structure. Let us be completely explicit about this orientation, for future use. First, consider  $\mu : F_l - Sing(F) \rightarrow Int(\sigma_l)$ ,  $\sigma_l = \langle P_i, P_j, P_k, P_m \rangle$ . Then the fibre of  $\mu$  is  $T(N_l)$ , and the natural orientation coming from the complex structure on  $F_l$  can be represented as

$$(4.2) \quad (P_j - P_i) \wedge e_j \wedge (P_k - P_i) \wedge e_k \wedge (P_m - P_i) \wedge e_m.$$

Here, as always, we give orientations by giving an element in the top exterior power of the tangent bundle. We abuse notation by identifying  $N_l \otimes \mathbf{R}$  with the tangent space of a fibre, and identify the tangent space of  $\partial\Xi$  at a point in the interior of a maximal face of  $\partial\Xi$  with the obvious three-dimensional subspace of  $\mathbf{R}^4$ . We note this orientation is independent of the order of  $i, j, k$  and  $m$ . It is easy to check these orientations are compatible using the identifications  $T_{kj}^{-1} \circ T_{ij} : N_i \rightarrow N_k$ .

To show  $X$  is diffeomorphic to the quintic, we use Wall's classification of simply-connected 6-manifolds. To apply this result, we need to know: (1)  $X$  is simply connected. (2)  $H^*(X, \mathbf{Z})$  is torsion-free. (3)  $H^2(X, \mathbf{Z}) = \mathbf{Z}$ , generated by a class  $H$  with  $H^3 = 5$ . (4)  $\text{rank } H^3(X, \mathbf{Z}) = 204$ . (5)  $w_2(X) = 0$ . (6)  $p_1(X)$  coincides with the first Pontrjagin class of the quintic. If these six conditions hold, then it follows from [20], Theorem 5 that  $X$  is diffeomorphic to the quintic. We treat each of these in turn.

(1) This follows from Theorem 2.12: the precise description of the monodromy shows there are no invariant 1-cycles modulo any  $n$ .

(2)-(4) The map  $\xi : X \rightarrow F$  is proper, with fibres over points of  $F_0^{(p)}$  being  $p$ -tori except for points of  $\xi(\text{Crit}(f))$ . Furthermore,  $\xi|_{\text{Crit}(f)}$  is a homeomorphism onto its image. Note  $\xi(\text{Crit}(f))$  is a union of two-manifolds  $\bigcup C_{ij}$ ,  $C_{ij} \subseteq F_{ij}$  of genus 6,  $C_{ijk} := C_{ij} \cap F_{ijk} = C_{ik} \cap F_{ijk} = C_{jk} \cap F_{ijk}$  a set of five points, and  $C_{ij} \cap F^{(3)} = \phi$ .

We wish to use the Leray spectral sequence for  $\xi$  to compute the cohomology of  $X$ . We will need to understand the sheaves  $R^n \xi_* \mathbf{Z}$ . First, let  $p \in F_0^{(i)}$  and let  $q$  be a nearby point in  $F_0^{(i-l)}$ . Then  $(R^n \xi_* \mathbf{Z})_p \cong H^n(\xi^{-1}(U), \mathbf{Z})$  for some sufficiently small open neighbourhood  $U$  of  $p$ . If  $q \in U$ , then we have a restriction map  $H^n(f^{-1}(p), \mathbf{Z}) \cong H^n(f^{-1}(U), \mathbf{Z}) \rightarrow H^n(f^{-1}(q), \mathbf{Z})$ , which we call the specialisation map. To understand what this map is, connect  $p$  and  $q$  with a path  $\gamma : [0, 1] \rightarrow F$ ,  $\gamma(0) = p$  and  $\gamma(1) = q$ . Then  $\xi^{-1}(\gamma([0, 1])) \cong [0, 1] \times T^{i-l} \cup \{1\} \times T^i$ , with  $\{1\} \times T^{i-l}$  sitting inside  $\{1\} \times T^i$ . Then the specialisation map is just the restriction map  $H^n(T^i, \mathbf{Z}) \rightarrow H^n(T^{i-l}, \mathbf{Z})$ . This should be viewed as a map  $(R^n \xi_* \mathbf{Z})_p \rightarrow (R^n \xi_* \mathbf{Z})_q$ .

To understand this map in practice, we just need to see how  $T^{i-l}$  sits inside  $T^i$ . Explicitly, first let  $p = \mu^{-1}(P_i) \in F^{(3)}$ , and let  $q$  be a nearby point in  $\mu^{-1}(\langle P_i, P_j \rangle)$ . Then  $\xi^{-1}(p) = T(N_i^\vee)$ , while if  $\langle P_i, P_j \rangle$  is an edge of  $\sigma_l$ , then  $\xi^{-1}(q)$  can be identified with  $T(\langle e_k, e_m \rangle) \subseteq T(N_l)$  (where as usual  $\{i, j, k, l, m\} = \{0, \dots, 4\}$ ). Using  $T_{li}$  to identify  $N_l$  with  $N_i^\vee$ , we see the specialisation map is induced by the inclusion  $T(\langle e_k^* - e_l^*, e_m^* - e_l^* \rangle) \subseteq T(N_i^\vee)$ . If  $r \in \mu^{-1}(\langle P_i, P_j, P_k \rangle)$  near the point  $p$ , then the specialisation map  $(R^n \xi_* \mathbf{Z})_q \rightarrow (R^n \xi_* \mathbf{Z})_r$  is induced by the inclusion

$$T(\langle e_m^* - e_l^* \rangle) \subseteq T(N_i^\vee).$$

We now note the following facts:

(a)  $R^3\xi_*\mathbf{Z} = \mathbf{Z}_{F^{(3)}}$ . In particular,  $H^0(F, R^3\xi_*\mathbf{Z}) = \mathbf{Z}^5$ .

(b) There is an exact sequence

$$0 \rightarrow R^2\xi_*\mathbf{Z} \rightarrow \bigoplus_{i < j < k} \mathbf{Z}_{F_{ijk} - C_{ijk}} \rightarrow \mathbf{Z}_{F^{(3)}} \rightarrow 0,$$

where  $\mathbf{Z}_{F_{ijk} - C_{ijk}}$  is the sheaf supported on  $F_{ijk}$  obtained by extension by zero of the constant sheaf  $\mathbf{Z}$  on  $F_{ijk} - C_{ijk}$ . In particular,  $H^0(F, R^2\xi_*\mathbf{Z}) = 0$  and  $H^1(F, R^2\xi_*\mathbf{Z})$  is torsion-free.

Proof. First note that  $(R^2\xi_*\mathbf{Z})|_{F_0^{(2)}} = \bigoplus_{i < j < k} \mathbf{Z}_{F_{ijk} - C_{ijk}}|_{F_0^{(2)}}$ . Thus in particular,  $i_{2*}i_2^*R^2\xi_*\mathbf{Z} = \bigoplus_{i < j < k} \mathbf{Z}_{F_{ijk} - C_{ijk}}$ . The exact sequence given in (b) will be obtained from the natural map  $R^2\xi_*\mathbf{Z} \rightarrow i_{2*}i_2^*R^2\xi_*\mathbf{Z}$ . To find the kernel and cokernel of this map, one studies the map on stalks. Let  $p \in F^{(3)}$ ; without loss of generality we can take  $p = (1 : 0 : 0 : 0 : 0) = \mu^{-1}(P_0)$ . Then  $(i_{2*}i_2^*R^2\xi_*\mathbf{Z})_p = \bigoplus_{i=1}^4 (R^2\xi_*\mathbf{Z})_{p_i}$ , where  $p_i \in \mu^{-1}(\langle P_0, P_i \rangle)$  is a point near  $p$ , and the map  $\psi : (R^2\xi_*\mathbf{Z})_p \rightarrow \bigoplus_{i=1}^4 (R^2\xi_*\mathbf{Z})_{p_i}$  is given by specialisation. By the discussion of specialisation above, this coincides with the restriction map

$$H^2(T(N_0^\vee), \mathbf{Z}) \rightarrow \bigoplus_{i=1}^4 H^2(T_i, \mathbf{Z}),$$

with

$$T_1 = T(\langle e_2^* - e_4^*, e_3^* - e_4^* \rangle)$$

$$T_2 = T(\langle e_1^* - e_4^*, e_3^* - e_4^* \rangle)$$

$$T_3 = T(\langle e_1^* - e_4^*, e_2^* - e_4^* \rangle)$$

$$T_4 = T(\langle e_2^* - e_1^*, e_3^* - e_1^* \rangle)$$

From this, one sees the kernel of  $\psi$  is zero and the cokernel of  $\psi$  is  $\mathbf{Z}$ . This yields the desired exact sequence. Now since

$$H^i(F, \mathbf{Z}_{F_{ijk} - C_{ijk}}) = H_c^i(F_{ijk} - C_{ijk}, \mathbf{Z}),$$

we see from the exact sequence of (b) that  $H^0(F, R^2\xi_*\mathbf{Z}) = 0$  and  $H^1(F, R^2\xi_*\mathbf{Z})$  is torsion-free. •

(c) There is an exact sequence

$$0 \rightarrow R^1\xi_*\mathbf{Z} \rightarrow \bigoplus_{i < j} \mathbf{Z}_{F_{ij} - C_{ij}} \rightarrow \bigoplus_{i < j < k} \mathbf{Z}_{F_{ijk} - C_{ijk}} \rightarrow \mathbf{Z}_{F^{(3)}} \rightarrow 0.$$

In particular,  $H^0(F, R^1\xi_*\mathbf{Z}) = H^1(F, R^1\xi_*\mathbf{Z}) = 0$  and  $H^2(F, R^1\xi_*\mathbf{Z})$  is torsion-free.

Proof. Again  $(R^1\xi_*\mathbf{Z})|_{F_0^{(1)}} = \bigoplus_{i<j} \mathbf{Z}_{F_{ij}-C_{ij}}|_{F_0^{(1)}}$ , so  $i_{1*}i_1^*R^1\xi_*\mathbf{Z} = \bigoplus_{i<j} \mathbf{Z}_{F_{ij}-C_{ij}}$ . We study the kernel and cokernel of the map  $\varphi : R^1\xi_*\mathbf{Z} \rightarrow i_{1*}i_1^*R^1\xi_*\mathbf{Z}$ . Let  $\mathcal{F} = \text{coker } \varphi$ . Let  $p$  be a point in, without loss of generality,  $(F_{234} - C_{234}) \cap F_0^{(2)}$  near  $(1 : 0 : 0 : 0 : 0)$ . If  $p_i \in F_{2\dots\hat{i}\dots 4} - F^{(2)}$  are points near  $p$ ,  $i = 2, 3, 4$ , then the map on stalks  $\varphi_p : (R^1\xi_*\mathbf{Z})_p \rightarrow (i_{1*}i_1^*R^1\xi_*\mathbf{Z})_p$  coincides with the specialisation map  $H^1(\xi^{-1}(p), \mathbf{Z}) \rightarrow \bigoplus_{i=2}^4 H^1(\xi^{-1}(p_i), \mathbf{Z})$ . Now  $\xi^{-1}(p)$  is identified with  $T(\langle e_2^* - e_4^*, e_3^* - e_4^* \rangle)$ . Under this identification,  $\xi^{-1}(p_2) = T(\langle e_3^* - e_4^* \rangle)$ ,  $\xi^{-1}(p_3) = T(\langle e_2^* - e_4^* \rangle)$ , and  $\xi^{-1}(p_4) = T(\langle e_3^* - e_2^* \rangle)$ . From this one sees that  $\varphi_p$  is injective with cokernel  $\mathbf{Z}$ . A similar calculation for  $p = (1 : 0 : 0 : 0 : 0)$  yields  $\ker \varphi_p = 0$ . In particular, one obtains an exact sequence

$$0 \rightarrow R^1\xi_*\mathbf{Z} \rightarrow \bigoplus_{i<j} \mathbf{Z}_{F_{ij}-C_{ij}} \rightarrow \mathcal{F} \rightarrow 0. \quad (4.3)$$

Also,  $\mathcal{F}|_{F_0^{(2)}} = \bigoplus_{i<j<k} \mathbf{Z}_{F_{ijk}-C_{ijk}}|_{F_0^{(2)}}$ . Next one studies the map

$$\mathcal{F} \rightarrow i_{3*}i_3^*\mathcal{F} = \bigoplus_{i<j<k} \mathbf{Z}_{F_{ijk}-C_{ijk}}.$$

We have to study the map on stalks at  $p \in F^{(3)}$ . Without loss of generality take  $p = (1 : 0 : 0 : 0 : 0)$ . Choose  $p_{0i} \in F_{1\dots\hat{i}\dots 4} - F^{(3)}$  near  $p$  and  $p_{0ij} \in F_{1\dots\hat{i}\dots\hat{j}\dots 4} - F^{(2)}$  near  $p$ . We then have a diagram

$$\begin{array}{ccccccc} 0 & \longrightarrow & H^1(T(N_0^\vee), \mathbf{Z}) & \longrightarrow & \bigoplus_{1 \leq i < j \leq 4} H^1(\xi^{-1}(p_{0ij}), \mathbf{Z}) & \longrightarrow & \mathcal{F}_p \longrightarrow 0 \\ & & \downarrow \varphi_1 & & \downarrow \varphi_2 & & \downarrow \varphi_3 \\ 0 & \longrightarrow & \bigoplus_{i=1}^4 H^1(\xi^{-1}(p_{0i}), \mathbf{Z}) & \longrightarrow & \bigoplus_{\substack{i,j=1 \\ i \neq j}}^4 H^1(\xi^{-1}(p_{0ij}), \mathbf{Z}) & \longrightarrow & \bigoplus_{i=1}^4 \mathcal{F}_{p_{0i}} \longrightarrow 0 \end{array}$$

Here the first row is obtained by taking the stalks of (4.3) at  $p$ , and the second is obtained by taking the direct sum of the stalks of the exact sequence (4.3) at  $p_{0i}$ . The map  $\varphi_1$  is again specialisation, and  $\varphi_2$  is given by mapping  $\alpha \in H^1(\xi^{-1}(p_{0ij}), \mathbf{Z}) \mapsto \alpha \oplus \alpha \in H^1(\xi^{-1}(p_{0ij}), \mathbf{Z}) \oplus H^1(\xi^{-1}(p_{0ij}), \mathbf{Z})$ . Explicit calculation then shows that the map  $\varphi_3 : \mathcal{F}_p \rightarrow (i_{3*}i_3^*\mathcal{F})_p$  is injective with cokernel  $\mathbf{Z}$ . We omit the details. This shows that we have an exact sequence

$$(4.4) \quad 0 \rightarrow \mathcal{F} \rightarrow \bigoplus_{i<j<k} \mathbf{Z}_{F_{ijk}-C_{ijk}} \rightarrow \mathbf{Z}_{F^{(3)}} \rightarrow 0.$$

Pasting this in with (4.3) gives the desired long exact sequence.

Finally, to show the desired facts about  $H^k(F, R^1\xi_*\mathbf{Z})$ , just keep in mind that

$$H^k(F, \mathbf{Z}_{F_{ij}-C_{ij}}) = H_c^k(F_{ij} - C_{ij}, \mathbf{Z}).$$

This is zero if  $k = 0$  or  $1$  and is torsion-free if  $k = 2$ , from which it follows from the exact sequence of (c) that  $H^k(F, R^1\xi_*\mathbf{Z})$  is zero if  $k = 0$  or  $1$  and is torsion-free for  $k = 2$ . •

$$(d) \xi_*\mathbf{Z} = \mathbf{Z}, H^0(F, \mathbf{Z}) = H^2(F, \mathbf{Z}) = H^3(F, \mathbf{Z}) = \mathbf{Z}, \text{ and } H^1(F, \mathbf{Z}) = 0.$$

Proof. The first statement follows from the fact that  $\xi$  has connected fibres. To compute the cohomology of  $F$ , use the spectral sequence

$$E_1^{pq} = H^q(F^{[p]}, \mathbf{Z}) \Rightarrow H^n(F, \mathbf{Z})$$

(see e.g. [14]). Displaying the entries of this sequence for  $0 \leq p, q \leq 3$ , we obtain

$$\begin{array}{cccc} 0 & 0 & 0 & 0 \\ \mathbf{Z}^5 & \mathbf{Z}^{10} & \mathbf{Z}^{10} & 0 \\ 0 & 0 & 0 & 0 \\ \mathbf{Z}^5 & \mathbf{Z}^{10} & \mathbf{Z}^{10} & \mathbf{Z}^5 \end{array}$$

Only zeroes occur to the right. It is standard that the bottom row coincides with the Čech complex for the intersection graph of  $F$ , which is the simplicial complex  $\partial\Xi$  (see e.g. [14], pg. 105). The second row is a truncation of the same complex. Thus the  $E_2$  and  $E_3$  term of this spectral sequence, for  $0 \leq p, q \leq 3$ , is

$$\begin{array}{cccc} 0 & 0 & 0 & 0 \\ \mathbf{Z} & 0 & \mathbf{Z}^4 & 0 \\ 0 & 0 & 0 & 0 \\ \mathbf{Z} & 0 & 0 & \mathbf{Z} \end{array}$$

Since  $\text{Pic}(F)$  certainly contains a copy of  $\mathbf{Z}$  generated by the hyperplane section, so does  $H^2(F, \mathbf{Z})$ , and thus the differential  $d : E_{02}^3 \rightarrow E_{30}^3$  must be zero. From this one sees the desired identity on cohomology. •

Now to show (2)-(4). From (a)-(d), the Leray spectral sequence for  $\xi$ , for  $0 \leq p+q \leq 3$ , looks like

$$\begin{array}{cccc} \mathbf{Z}^5 & & & \\ 0 & M_1 & & \\ 0 & 0 & M_2 & \\ \mathbf{Z} & 0 & \mathbf{Z} & \mathbf{Z} \end{array}$$

where  $M_1$  and  $M_2$  are torsion-free. This makes it clear that  $H^2(X, \mathbf{Z}) = \mathbf{Z}$  and  $H^3(X, \mathbf{Z})$  is torsion-free. Furthermore,  $H^2(F, \mathbf{Z}) \cong H^2(X, \mathbf{Z})$ . If  $H$  is a hyperplane section of  $F$ , then  $H$  pulls back to a generator  $\xi^*H$  of  $H^2(X, \mathbf{Z})$ . Furthermore,  $(\xi^*H)^3 = 5$  since  $H^3 = 5$ . Finally,  $\text{rank } H^3(X, \mathbf{Z}) = 204$  since  $\chi(X) = -200$ . This is, for example, easily computed by counting singular fibres:

$$\begin{aligned} \chi(X) &= \# \text{ of type } (1, 2) \text{ fibres} - \# \text{ of type } (2, 1) \text{ fibres} \\ &= 10 \cdot 5 - 10 \cdot 25 \\ &= -200. \end{aligned}$$

(5) follows from Proposition 2.13.

(6) will follow from Theorem 2.17. Indeed,  $H \cdot c_2(\text{quintic}) = 50$ , so we just need to show that  $\xi^* H \cdot p_1(X) = -100$ . Since  $p_1(X) = -2\text{Crit}(f)$  by Theorem 2.17, and  $\xi(\text{Crit}(f)) = \bigcup C_{lm} \subseteq F \subseteq \mathbf{P}^4$ , we just need to show that  $H \cdot C_{lm} = 5$  for each  $l$  and  $m$ , with the orientation on  $C_{lm}$  induced by the canonical orientation on  $\text{Crit}(f)$ . To do so, consider  $C_{lm} \subseteq F_{lm} = \mathbf{P}^2$ . Then  $F_{klm}$  is a  $\mathbf{P}^1$  contained inside  $\mathbf{P}^2$ , and  $F_{klm} \cap C_{lm}$  consists of five points. If we show this intersection is transversal and positive, then  $H \cdot C_{lm} = 5$ . If we take coordinates  $(z_i, z_j, z_k)$  on  $F_{lm}$ , then  $F_{klm}$  is given by  $z_k = 0$ , and near a point  $p \in F_{klm} \cap C_{lm}$  the set  $\mu(C_{lm})$  is a line segment in  $\langle P_i, P_j, P_k \rangle$  meeting  $\langle P_i, P_j \rangle$ . Adjusting this line segment a bit if necessary and perturbing  $C_{lm}$ , we can assume that near  $p$ ,  $C_{lm}$  is given by  $z_i = 1, z_j = \text{constant}$ , making it clear the intersection with  $F_{klm}$  is transversal. If  $C_{lm}$  has the same orientation as that induced by the complex structure, then the intersection will be positive.

To see this, let  $q \in C_{lm}$  be a point near  $p$ . Take a small neighbourhood of  $\mu(q)$ , so that  $U = D \times (0, 1)$  with  $\mu(C_{lm}) \cap D = \{0\} \times (0, 1)$ . Let  $\gamma$  be a small loop in  $D^*$  in the same direction as  $\gamma_{ij,k}$  as shown in Figure 4.1. If  $D$  is given an orientation  $\eta_D$  so that  $\gamma$  is counterclockwise, and  $(0, 1)$  is given the orientation  $\eta_{(0,1)}$  in the direction from  $\mu(p)$  to  $\mu(q)$ , then the product orientation on  $D \times (0, 1)$  is the orientation  $\eta_D \wedge \eta_{(0,1)} = (P_j - P_i) \wedge (P_m - P_i) \wedge (P_k - P_i)$  on  $\sigma_l$ . The monodromy about  $\gamma$  in the basis  $e_m, e_j, e_k$  of  $N_l$  is  $\begin{pmatrix} 1 & 1 & 0 \\ 0 & 1 & 0 \\ 0 & 0 & 1 \end{pmatrix}$ . Then if  $g : X' \rightarrow D$  is the fibration obtained by  $X' = f^{-1}(D \times \{1/2\})/T(\langle e_k \rangle) \rightarrow D$ , then by Example 2.15, the orientation  $\eta_D \wedge e_m \wedge e_j$  is the positive orientation on  $X'$ . In addition, taking the orientation  $\eta_{(0,1)} \wedge e_k$  on  $(0, 1) \times S^1$ , the product orientation on  $f^{-1}(U) = X' \times (0, 1) \times S^1$  is

$$\begin{aligned} \eta_D \wedge e_m \wedge e_j \wedge \eta_{(0,1)} \wedge e_k &= \eta_D \wedge \eta_{(0,1)} \wedge e_j \wedge e_k \wedge e_m \\ &= -(P_j - P_i) \wedge (P_k - P_i) \wedge (P_m - P_i) \wedge e_j \wedge e_k \wedge e_m, \end{aligned}$$

which from (4.2) is the chosen orientation on  $X$ . Thus by Example 2.15,  $\text{Crit}(f) \cap f^{-1}(U)$  is oriented by the product orientation  $\eta_{(0,1)} \wedge e_k$ , as is  $C_{lm} \cap \mu^{-1}(U)$ . But this is precisely the orientation induced by the complex structure. •

Having constructed a well-behaved fibration  $f : X \rightarrow B$  on the quintic, we can now construct a dual  $\check{f} : \check{X} \rightarrow B$  from Corollary 2.2. It follows immediately from [7], Theorem 3.10, which applies as  $f$  and  $\check{f}$  are  $\mathbf{Z}$  and  $\mathbf{Z}/n\mathbf{Z}$ -simple, that  $H^2(\check{X}, \mathbf{Z}) = \mathbf{Z}^{101}$  and  $H^3(\check{X}, \mathbf{Z}) = \mathbf{Z}^4$ . This coincides with the cohomology of the mirror quintic. To show



that  $\tilde{X}$  is diffeomorphic to the mirror quintic, however, we need to show that the cubic form on  $H^2(\tilde{X}, \mathbf{Z})$  coincides with that of the mirror quintic, and this will require some work. We begin by reviewing the geometry of the mirror quintic.

Let  $\Xi$  be the simplex in  $\mathbf{R}^4$  with vertices  $P_0 = (-1, -1, -1, -1)$ ,  $P_1 = (4, -1, -1, -1)$ ,  $P_2 = (-1, 4, -1, -1)$ ,  $P_3 = (-1, -1, 4, -1)$ ,  $P_4 = (-1, -1, -1, 4)$ . Then as is well-known (see [2], 5.1),  $\Xi$  is a reflexive polyhedron and  $\mathbf{P}_\Xi$ , the toric four-fold corresponding to  $\Xi$ , is  $\mathbf{P}^4$ . Also the dual  $\Xi^*$  is the convex hull of  $(-1, -1, -1, -1), (1, 0, 0, 0), \dots, (0, 0, 0, 1)$ , and  $\mathbf{P}_{\Xi^*}$  is naturally identified with the hypersurface in  $\mathbf{P}^5$  with equation  $x_0 \cdots x_4 = x_5^5$ . A general hyperplane section of  $\mathbf{P}_{\Xi^*}$  is then a singular model for the mirror quintic. Fix such a hyperplane section  $W'$ . The singularities of  $W'$  are induced by the singularities of  $\mathbf{P}_{\Xi^*}$  and are as follows: there are ten curves of singularities,  $C_{ij}$ , isomorphic to  $\mathbf{P}^1$ , corresponding to the edges  $\langle P_i, P_j \rangle$  of  $\Xi$ . These are generically  $\mathbf{Z}_5$ -quotient singularities. There are in addition 10 singular points  $P_{ijk}$ , corresponding to the faces  $\langle P_i, P_j, P_k \rangle$  of  $\Xi$ , which are  $\mathbf{Z}_5^2$ -quotient singularities. Furthermore,  $C_{ij} \cap C_{ik} \cap C_{jk} = \{P_{ijk}\}$ .

To resolve these singularities, note that  $\mathbf{P}_{\Xi^*}$  can also be thought of as the toric variety  $Y_\Sigma$  associated to the fan  $\Sigma$  which is the union of cones over faces of  $\Xi$  with vertex the origin. A resolution of  $\mathbf{P}_{\Xi^*}$  is then obtained by choosing a suitable subdivision of  $\Sigma$ , or equivalently by choosing a suitable triangulation of  $\partial\Xi$ . Such a resolution will also yield a crepant resolution  $\eta : W \rightarrow W'$ . There is much choice in doing so, but we will make these choices so that each two-dimensional face of  $\Xi$  is triangulated as follows:

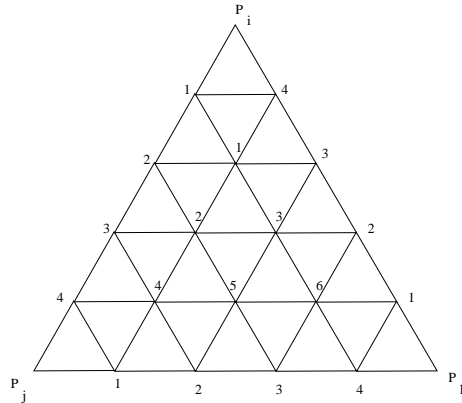

Figure 4.6

(See [15] or [2] for a more detailed description of the method of resolution of  $W'$ .) Each vertex of this triangulation gives rise to a toric divisor on  $W$ . We let  $L_0, \dots, L_4$  be the divisors corresponding to the points  $P_0, \dots, P_4$ . These are just the proper transforms of  $W' \cap \{x_i = x_5 = 0\} \subseteq \{x_0 \cdots x_4 = x_5^5\}$ . It is clear from the choice of toric resolution that  $\eta : L_i \rightarrow \mathbf{P}^2$  is an isomorphism. Let  $E_{ij}^l$ ,  $l = 1, \dots, 4$  be the divisors corresponding to the interior vertices of the edge  $\langle P_i, P_j \rangle$  as numbered in Figure 4.6. For each  $i, j$ , these four

divisors look like

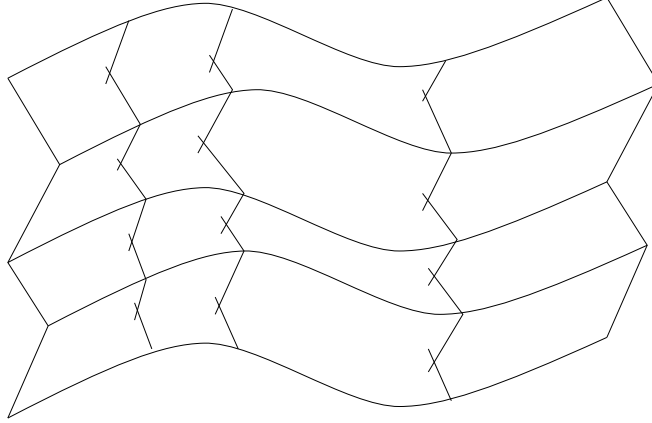

Figure 4.7

We will find it convenient to use the convention that  $E_{ij}^l = E_{ji}^{5-l}$ . Let  $E_{ijk}^l$  be the divisors corresponding to the interior vertices of  $\langle P_i, P_j, P_k \rangle$ , as numbered in Figure 4.6. Then  $\eta(E_{ijk}^l) = P_{ijk}$ ,  $\eta(E_{ij}^l) = C_{ij}$ , and the  $E_{ijk}^l, E_{ij}^l$  are the exceptional divisors of the resolution  $\eta : W \rightarrow W'$ . Furthermore, the pull-back of a hyperplane section of  $\mathbf{P}_{\Xi^*}$ , giving the embedding of  $\mathbf{P}_{\Xi^*}$  in  $\mathbf{P}^5$ , is just the anti-canonical divisor of the toric resolution of  $\mathbf{P}_{\Xi^*}$  restricted to  $W$ , and as such is the sum of all the toric divisors. We call this divisor

$$H := \sum_i L_i + \sum_{\substack{i < j \\ i}} E_{ij}^l + \sum_{\substack{i < j < k \\ i}} E_{ijk}^l.$$

We summarize the intersection data:

**Proposition 4.2.** *On  $W$ , the following holds:*

(1)  $H^3 = 5, H \cdot E_{ij}^l \cdot E_{ij}^{l+1} = 1, H \cdot (E_{ij}^l)^2 = -2, H^2 \cdot L_i = 1, H \cdot L_i \cdot E_{ij}^1 = 1, H \cdot L_i^2 = -3.$

(2)

$$\begin{aligned} L_i \cdot (E_{ij}^1)^2 &= 1, & L_i^2 \cdot E_{ij}^1 &= -3, \\ E_{ij}^1 \cdot (E_{ij}^2)^2 &= 0, & (E_{ij}^1)^2 \cdot E_{ij}^2 &= -2, \\ E_{ij}^2 \cdot (E_{ij}^3)^2 &= -1, & (E_{ij}^2)^2 \cdot E_{ij}^3 &= -1, \\ E_{ij}^3 \cdot (E_{ij}^4)^2 &= -2, & (E_{ij}^3)^2 \cdot E_{ij}^4 &= 0, \end{aligned}$$

and  $L_i^3 = 9, (E_{ij}^l)^3 = 5.$

(3) Fixing  $i, j$  and  $k$ , let

$$\{D_1, \dots, D_{21}\} = \{E_{ijk}^1, \dots, E_{ijk}^6, E_{ij}^1, \dots, E_{jk}^4, L_i, L_j, L_k\}$$

be the 21 divisors corresponding to the 21 vertices in the triangulation of Figure 4.6. Then  $D_i^2 \cdot D_j = -1$  if there is an edge  $\langle i, j \rangle$  joining vertex  $i$  and vertex  $j$  and  $\langle i, j \rangle$

is not an exterior edge. Also  $D_i \cdot D_j \cdot D_k = 1$  if vertices  $i, j, k$  are the vertices of a 2-simplex in Figure 4.6, and  $D_i^3 = 6$  if  $D_i$  corresponds to an interior vertex.

(4) All other intersection numbers involving  $H$ , the  $L_i$ 's, the  $E_{ij}^l$ 's and the  $E_{ijk}^l$ 's are zero.

(5) If  $c_2 \in H^4(W, \mathbf{Z})$  is the second Chern class, then

$$\begin{aligned} H \cdot c_2 &= 50, \\ E_{ij}^l \cdot c_2 &= 2, \\ E_{ijk}^l \cdot c_2 &= 0, \\ L_i \cdot c_2 &= -6. \end{aligned}$$

Proof. This sort of computation is standard, and can be extracted, for example, from [5], §5. We sketch it here: all values for cubes of divisors follow from the formula  $D^3 = K_D^2$  for a smooth divisor  $D$  in a Calabi-Yau; all formulae involving  $H$  are immediate from the fact that  $H$  induces the map  $\eta : W \rightarrow W' \subseteq \mathbf{P}^4$ . The formulae in (3) are clear from the toric geometry, and the rest follows from, for  $A$  and  $B$  two divisors meeting transversally in a Calabi-Yau threefold, the formulae  $A \cdot B^2 = (A \cap B)^2$ , where the square is computed on  $A$ , and  $A \cdot B^2 = (A \cap B) \cdot K_B$ , calculated on  $B$ . Finally the formulae for  $c_2$  follow from Riemann-Roch. •

**Lemma 4.3.** *Let  $M$  be an oriented, compact six-manifold with  $H^2(M, \mathbf{Z}) = \mathbf{Z}^{101}$ , and let  $S$  be a subset of 105 elements of  $H^2(M, \mathbf{Z})$ , named so that*

$$S = \{E_{ij}^l | 0 \leq i < j \leq 4, 1 \leq l \leq 4\} \cup \{E_{ijk}^l | 0 \leq i < j < k \leq 4, 1 \leq l \leq 6\} \cup \{L_0, \dots, L_4\}$$

*Suppose the elements of  $S$  have intersection numbers identical to those given in Proposition 4.2 (2)-(4). Then the set  $S$  generates  $H^2(M, \mathbf{Z})$ , and there is an isomorphism  $H^2(M, \mathbf{Z}) \cong H^2(W, \mathbf{Z})$  preserving the cubic form, taking each divisor in  $S$  to the identically named divisor in  $H^2(W, \mathbf{Z})$ .*

Proof. Let  $H = \sum_{D \in S} D$ , so that  $H$  has the same intersection numbers as in Proposition 4.2. Let  $L \subseteq H^2(M, \mathbf{Z})$  be the integral span of the 101 divisors  $\{H, E_{ij}^l, E_{ijk}^l\}$ . Let  $N \subseteq H^4(M, \mathbf{Z})$  be the span of  $\{D_1 \cdot D_2 | D_1, D_2 \in S\}$ . Let  $L_{sat} \subseteq L \otimes_{\mathbf{Z}} \mathbf{Q}$  be defined by

$$L_{sat} = \{D \in L \otimes_{\mathbf{Z}} \mathbf{Q} | D \cdot N \subseteq \mathbf{Z}\}.$$

*Claim.*  $L_{sat}/L \subseteq \mathbf{Z}_5^4$ , and  $L_{sat}/L$  is generated by  $L_0, \dots, L_4$ .

Proof. Let  $D \in L \otimes_{\mathbf{Z}} \mathbf{Q}/L$ , with

$$D = bH + \sum b_{ij}^l E_{ij}^l + \sum b_{ijk}^l E_{ijk}^l,$$

for  $b, b_{ij}^l, b_{ijk}^l \in \mathbf{Q}/\mathbf{Z}$ . Now  $D \in L_{sat}/L$  if and only if  $D \cdot D_1 \cdot D_2 \equiv 0 \pmod{\mathbf{Z}}$  for all  $D_1, D_2 \in S$ . We study what this condition tells us.

First focus on the divisors  $E_{ij}^l, 1 \leq l \leq 4$ . If

$$\begin{aligned} f_1 &= E_{ij}^1 \cdot (E_{ki}^4 + E_{ijk}^1) \\ f_2 &= E_{ij}^2 \cdot (E_{ijk}^1 + E_{ijk}^2) \\ f_3 &= E_{ij}^3 \cdot (E_{ijk}^2 + E_{ijk}^4) \\ f_4 &= E_{ij}^4 \cdot (E_{ijk}^4 + E_{ijk}^1) \end{aligned}$$

then these are elements of  $N$ . If  $a_{lm} = E_{ij}^l \cdot f_m$ , then from Figure 4.6 and the intersection numbers given in Proposition 4.2 (3), the matrix  $(a_{lm})$  is just the Cartan matrix of  $A_4$ . (In  $W$ ,  $f_l$  would be the class of a fibre of  $\eta : E_{ij}^l \rightarrow C_{ij}$ ). Furthermore,  $f_1, \dots, f_4$  intersect all other divisors  $H, E_{jk}^l, E_{ijk}^l$  trivially. Thus by inverting the Cartan matrix  $A_4$ , one sees that  $D \cdot f_m \equiv 0 \pmod{\mathbf{Z}}$  for  $m = 1 \dots 4$  if and only if there exists a  $b_{ij} \in \frac{1}{5}\mathbf{Z}/\mathbf{Z}$  such that  $b_{ij}^l = lb_{ij}$ .

Next focus on the simplex  $\langle P_i, P_j, P_k \rangle$  as depicted in Figure 4.6. For each trapezoid

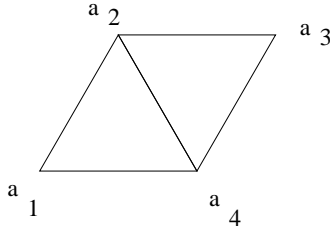

Figure 4.8

appearing in Figure 4.6, with corresponding divisors  $D_1, \dots, D_4 \in S$  and coefficients  $a_1, \dots, a_4$  in the expression for  $D$ , the requirement that  $D \cdot D_2 \cdot D_4 \equiv 0 \pmod{\mathbf{Z}}$  is equivalent to  $a_1 + a_3 \equiv a_2 + a_4 \pmod{\mathbf{Z}}$ . Using this relation, and given that  $b_{ij}^l = lb_{ij}$ ,  $b_{jk}^l = lb_{jk}$  and  $b_{ki}^l = lb_{ki}$  for  $b_{ij}, b_{jk}, b_{ki} \in \frac{1}{5}\mathbf{Z}/\mathbf{Z}$ , one finds that the coefficients of all classes corresponding to interior vertices are determined uniquely, subject to the additional constraint that  $b_{ij} + b_{jk} + b_{ki} \equiv 0 \pmod{\mathbf{Z}}$ . (Here we use the convention that  $b_{ij} = -b_{ji}$ .)

How many choices of  $b_{ij}$ 's are there which satisfy this congruence? The set of all such  $b_{ij}$ 's is the kernel of the map  $\partial_1 : \mathbf{Z}_5^{10} \rightarrow \mathbf{Z}_5^{10}$  defined by  $\partial_1((b_{ij})_{i < j}) = (b_{ij} + b_{jk} + b_{ki})_{i < j < k}$ . But this map  $\partial_1$  is precisely the coboundary map from 1-cochains to 2-cochains (with coefficients in  $\mathbf{Z}_5$ ) of the two-skeleton  $\Xi_2$  of  $\Xi$ . The full cochain complex of the simplicial complex  $\Xi_2$  is

$$\mathbf{Z}_5^5 \xrightarrow{\partial_0} \mathbf{Z}_5^{10} \xrightarrow{\partial_1} \mathbf{Z}_5^{10},$$

and as  $H^1(\Xi_2, \mathbf{Z}_5) = 0$ ,  $\ker \partial_1 = \text{Im } \partial_0$ . But  $\ker \partial_0 = H^0(\Xi_2, \mathbf{Z}_5) = \mathbf{Z}_5$ , so  $\ker \partial_1 \cong \mathbf{Z}_5^4$ .

Next, we note that the coefficient of  $H$  in  $D$  is completely determined from the relation  $D \cdot E_{ij}^1 \cdot L_i \equiv 0 \pmod{\mathbf{Z}}$  and the values of the  $b_{ij}$ 's, as  $H \cdot E_{ij}^1 \cdot L_i = 1$  for all  $i$  and  $j$ . This makes it clear that the map  $L_{sat}/L \rightarrow \mathbf{Z}_5^{10}$  given by  $D \mapsto (b_{ij})_{0 \leq i, j \leq 4}$  is injective, with image contained in  $\ker \partial_1$ . Thus  $L_{sat}/L \subseteq \mathbf{Z}_5^4$ .

Observe that these calculations imply that the 101 generators of  $L$  are in fact linearly independent. If not, then in the calculations above, we would have found some non-zero choice of coefficients  $b, b_{ij}^l, b_{ijk}^l$  such that  $\lambda D \cdot N \equiv 0 \pmod{\mathbf{Z}}$  for all  $\lambda \in \mathbf{Q}$ . We did not find such. Thus  $L \otimes_{\mathbf{Z}} \mathbf{Q} = H^2(M, \mathbf{Q})$ . Thus in particular  $L_p \in L_{sat}$ ,  $0 \leq p \leq 4$ , and we can write

$$L_p = b^p H + \sum lb_{ij}^p E_{ij}^l + \sum b_{ijk}^{l,p} E_{ijk}^l$$

for suitable rational coefficients,  $b^p, b_{ij}^p, b_{ijk}^{l,p}$ . It is then easy to see that  $(b_{ij}^p)_{i < j} \in (\frac{1}{5}\mathbf{Z})^{10}$  reduced modulo  $\mathbf{Z}$  is just  $\partial_0(e_p)$ , where  $e_0, \dots, e_4$  are the generators of the 0-cochain group of  $\Xi_2$  corresponding to the vertices  $P_0, \dots, P_4$ . Thus  $L_0, \dots, L_4$  generate  $L_{sat}/L$ , proving the claim. •

To prove the theorem, we just observe now that since  $L \otimes_{\mathbf{Z}} \mathbf{Q} = H^2(M, \mathbf{Q})$ ,  $H^2(M, \mathbf{Z}) \subseteq L_{sat}$ . On the other hand the claim shows  $L_{sat}$  is generated by  $S$ , and hence  $L_{sat} \subseteq H^2(M, \mathbf{Z})$ . Thus  $L_{sat} = H^2(M, \mathbf{Z})$ . As the former is generated by  $S$ , so is the latter. It is then clear that the linear map  $H^2(M, \mathbf{Q}) \rightarrow H^2(W, \mathbf{Q})$  taking  $H, E_{ij}^l, E_{ijk}^l$  to the corresponding divisors in  $H^2(W, \mathbf{Q})$  is defined over  $\mathbf{Z}$ , is an isomorphism over  $\mathbf{Z}$ , and under this map the cubic forms coincide. •

**Theorem 4.4.**  *$\check{X}$  is diffeomorphic to  $W$ .*

*Proof.* We again use Wall's classification theorem [20]. Because  $\check{X}$  and  $W$  are both simply connected and we already know that  $H^*(\check{X}, \mathbf{Z}) \cong H^*(W, \mathbf{Z})$  as  $\mathbf{Z}$ -modules, we just need to show there is a choice of isomorphism  $H^2(\check{X}, \mathbf{Z}) \cong H^2(W, \mathbf{Z})$  preserving the cubic form and intersection with  $p_1$ . To do so, by Lemma 4.3, we need to identify the relevant set  $S \subseteq H^2(\check{X}, \mathbf{Z})$  of cohomology classes.

Before doing so, we need to study the geometry of  $\check{f}$  in greater detail. Let  $U_i, U^i \subseteq \partial \Xi$  be the open sets defined in the construction of  $f$ . Then as  $f^{-1}(U_l) = T(N_l) \times U$ , we can naturally identify  $\check{f}^{-1}(U_l)$  with  $T(N_l^\vee) \times U$ . Next, let  $U_{lm}$  be an open set homeomorphic to  $\mathbf{R}^3$  contained in  $\sigma_l \cup \sigma_m$ , with  $U_{lm} \cap \sigma_l \cap \sigma_m = \text{Int}(\sigma_l \cap \sigma_m)$ . Here  $\sigma_l \cap \sigma_m = \sigma := \langle P_i, P_j, P_k \rangle$ , with  $\{0, 1, 2, 3, 4\} = \{i, j, k, l, m\}$ . Then the fibration  $\check{f}^{-1}(U_{lm}) \rightarrow U_{lm}$  has a two-dimensional space of cycles invariant under monodromy, and from the transpose inverse of the description of the monodromy given in (4.1), this space of cycles is given by  $N_l^\vee \cap N_m^\vee \subseteq N^\vee$ . Thus there is a  $T(N_l^\vee \cap N_m^\vee)$  action on  $\check{f}^{-1}(U_{lm})$ , with quotient map

$q_{lm} : \check{f}^{-1}(U_{lm}) \rightarrow \check{f}^{-1}(U_{lm})/T(N_l^\vee \cap N_m^\vee) = S^1 \times U_{lm}$ . From the construction method in Proposition 2.9, it is clear that the image of  $\text{Crit}(\check{f})$  under  $q_{lm}$  can be identified with  $\Delta' := \{p\} \times (\Delta \cap U_{lm})$  for some  $p \in S^1$ . The  $T(N_l^\vee \cap N_m^\vee)$ -bundle

$$q_{lm}^{-1}(S^1 \times U_{lm} - \Delta') \rightarrow S^1 \times U_{lm} - \Delta'$$

has Chern class

$$c_1 \in H_{\Delta'}^3(S^1 \times U_{lm}, N_l^\vee \cap N_m^\vee) = H_1^{BM}(\Delta', N_l^\vee \cap N_m^\vee).$$

Using the known monodromy about each edge of  $\Delta \cap U_{lm}$ , we can describe  $c_1$  up to sign as a 1-chain on  $\Delta' \cup \{\infty\}$ . Each edge of  $\Delta'$  parallel (and in the same direction) to the oriented edge  $\langle P_{ijk}, P_{ij} \rangle$  of  $\Gamma$  has coefficient  $e_j^* - e_i^*$ ; each edge of  $\Delta'$  parallel to  $\langle P_{ijk}, P_{ik} \rangle$  of  $\Gamma$  has coefficient  $e_i^* - e_k^*$ ; and each edge of  $\Delta'$  parallel to  $\langle P_{ijk}, P_{jk} \rangle$  has coefficient  $e_k^* - e_j^*$ .

On the other hand, let  $N' \cong \mathbf{Z}^3 \subseteq N^\vee$  be a lattice with basis  $e_i^*, e_j^*, e_k^*$ , and let  $\sigma$  be the cone in  $N' \otimes_{\mathbf{Z}} \mathbf{R}$  generated by  $e_i^*, 5e_j^* - 4e_i^*$  and  $5e_k^* - 4e_i^*$ . Then  $\sigma$  can be subdivided to obtain a fan  $\Sigma$  which is a cone over the diagram in Figure 4.6. In particular,  $Y_\Sigma \rightarrow Y_\sigma$  is a crepant resolution of  $Y_\sigma$ , as in §3. Also, in the notation of §3,  $N'_{m_0} = N_m^\vee \cap N_l^\vee$ . Let  $q_1 : Y_\Sigma \rightarrow \mathbf{C} \times \mathbf{R}^2$  be the  $T(N'_{m_0})$ -fibration constructed in §3,  $\Delta'_\Sigma \subseteq \mathbf{C} \times \mathbf{R}^2$  the locus over which  $q_1$  fails to be a  $T^2$ -bundle. By construction,  $\Delta'_\Sigma$  is homeomorphic to  $\Delta'$ , and by Proposition 3.3, the first Chern class  $c_1^\Sigma \in H_1^{BM}(\Delta'_\Sigma, N_m^\vee \cap N_l^\vee)$  of the  $T^2$ -bundle  $q_1 : Y_\Sigma - q_1^{-1}(\Delta'_\Sigma) \rightarrow \mathbf{C} \times \mathbf{R}^2 - \Delta'_\Sigma$  coincides with  $c_1 \in H_1^{BM}(\Delta', N_m^\vee \cap N_l^\vee)$ . Now choose, for some point  $p' \in S^1 - \{p\}$ , a homeomorphism  $\varphi_{lm} : (S^1 - \{p'\}) \times U_{lm} \rightarrow \mathbf{C} \times \mathbf{R}^2$  so that  $\varphi_{lm}^{-1}(\{0\} \times \mathbf{R}^2) = \{p\} \times \text{Int}(\sigma)$  and  $\varphi_{lm}^{-1}(\Delta'_\Sigma) = \Delta'$ . Then this induces a homeomorphism

$$\psi_{lm} : q_{lm}^{-1}((S^1 - \{p'\}) \times U_{lm}) \rightarrow Y_\Sigma.$$

Now  $Y_\Sigma$  contains a number of toric divisors which are submanifolds of  $Y_\Sigma$ , and these yield (possibly open) submanifolds of  $\check{X}$  via  $\psi_{lm}$ . These can be identified as follows. There is one connected component of  $\text{Int}(\sigma) - \Delta$  for each vertex  $\tau$  of Figure 4.6 (see Figure 4.3). The component containing  $\tau$  we will call  $\mathcal{O}_\tau \subseteq U_{lm}$ . Then  $q_{lm}^{-1}(\{p\} \times \overline{\mathcal{O}_\tau})$  is a smooth submanifold of  $\check{f}^{-1}(U_{lm})$ , and  $\psi_{lm}(q_{lm}^{-1}(\{p\} \times \overline{\mathcal{O}_\tau}))$  is the toric divisor corresponding to  $\tau$  (modulo orientation, to be discussed shortly).

Of these 21 submanifolds, 6 correspond to interior vertices, and these submanifolds are compact. We label them  $E_{ijk}^p$ ,  $1 \leq p \leq 6$ , as in Figure 4.6. An additional 12 correspond to the interior vertices of the three edges in Figure 4.6. These are non-compact submanifolds of  $\check{X}$ , and we label these  $E_{ij,ijk}^p, E_{ik,ijk}^p$  and  $E_{jk,ijk}^p$ ,  $1 \leq p \leq 4$ , as numbered in Figure 4.6.

Finally, the three exterior vertices,  $P_i, P_j$  and  $P_k$ , correspond to non-compact submanifolds  $L_{i,ijk}, L_{j,ijk}$  and  $L_{k,ijk}$  of  $\check{X}$ .

Next we want to orient these submanifolds. If  $D_\tau$  is one of the submanifolds introduced above, which is a  $T(N_l^\vee \cap N_m^\vee)$ -fibration over  $\overline{\mathcal{O}_\tau}$ , then  $e_j^* - e_i^*, e_k^* - e_i^*$  can be taken as a basis for  $N_l^\vee \cap N_m^\vee$ , and we can orient  $D$  via

$$(P_j - P_i) \wedge (e_j^* - e_i^*) \wedge (P_k - P_i) \wedge (e_k^* - e_i^*).$$

This orientation is independent of the ordering of  $i, j$  and  $k$ . By Remark 3.4, these orientations coincide with the orientations induced by the complex structure on  $\psi_{lm}(D_\tau) \subseteq Y_\Sigma$ .

We now wish to glue together the three submanifolds  $E_{ij,ijk}^p, E_{ij,ijl}^p$  and  $E_{ij,ijm}^p$ . These are sitting over the shaded region in  $B$  depicted in Figure 4.9:

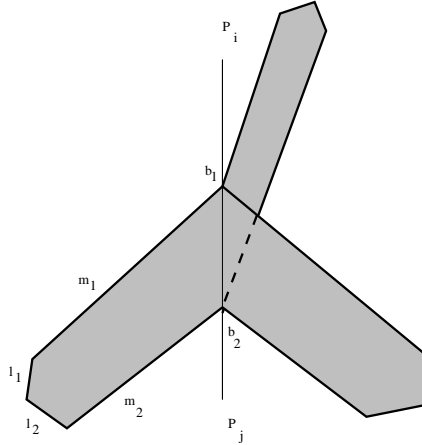

Figure 4.9

For notational simplicity, we refer to these three submanifolds as  $E_k, E_l$  and  $E_m$ . In this diagram  $b_1$  and  $b_2$  are points on  $\langle P_i, P_j \rangle$  where three branches of  $\Delta$  intersect.

First we look at a local model in a neighbourhood  $V \subseteq B$  of the line segment  $[b_1, b_2] \subseteq \langle P_i, P_j \rangle$ . This neighbourhood can be written as  $V \cong D \times (0, 1)$ ,  $D$  a disk, so that  $V \cap \langle P_i, P_j \rangle = \{0\} \times (0, 1)$ ,  $b_1, b_2 \in (0, 1)$ , and there is a “Y” shape  $\Delta' \subseteq D$  with vertex at 0 such that  $\Delta \cap V = \Delta' \times \{b_1, b_2\}$ , and  $V \cap \check{f}(\bar{E}_k \cup \bar{E}_m \cup \bar{E}_n) = \Delta' \times [b_1, b_2]$ . Then by the construction of Example 2.6, (4), there is an  $S^1$ -fibration  $\pi : \check{f}^{-1}(V) \rightarrow T^2 \times V$ , with  $\pi(\text{Crit}(\check{f}) \cap \check{f}^{-1}(V)) = S_1 \cup S_2$ , with  $S_1$  and  $S_2$  pairs of pants sitting over  $\Delta' \times \{b_1\}$  and  $\Delta' \times \{b_2\}$  respectively. Furthermore, we can assume that there is an  $S \subseteq T^2 \times \Delta' \subseteq T^2 \times D$  such that  $S_1 = S \times \{b_1\}$  and  $S_2 = S \times \{b_2\}$ . Let  $T = S \times [b_1, b_2] \subseteq T^2 \times V$ . Then  $\pi^{-1}(T)$  is a submanifold of  $\check{f}^{-1}(V)$ , and  $E_k \cap \check{f}^{-1}(V)$  can be glued up to  $\pi^{-1}(T)$ , possibly by perturbing  $E_k$  a bit. The same goes for  $E_l$  and  $E_m$ . Thus using  $\pi^{-1}(T)$ , we can glue together  $E_k, E_l$  and  $E_m$  to obtain a closed submanifold without boundary  $E_{ij}^p$  of  $\check{X}$ .

We need to make sure that this gluing can be done compatibly with the choice of orientations made on these submanifolds. To do this, we need to check that with this choice of orientation,  $\partial\bar{E}_k + \partial\bar{E}_l + \partial\bar{E}_m$  is homologous to zero. First consider  $\partial\bar{E}_k$ . This is a fibration over the line segment  $[b_1, b_2] \subseteq \langle P_i, P_j \rangle$ , with fibres over points of  $(b_1, b_2)$  homologous to the torus  $T(\langle e_j^* - e_i^*, e_k^* - e_i^* \rangle) \subseteq T(N_l^\vee)$ , using a path from a chosen basepoint  $b_l \in U_l$  to  $b \in (b_1, b_2)$  to identify the fibre  $X_b$  with  $T(N_l^\vee)$ . The orientation  $\eta_{\partial\bar{E}_k}$  on  $\partial\bar{E}_k$  is induced by the orientation  $\eta_{\bar{E}_k}$  on  $\bar{E}_k$  by the rule that  $\nu \wedge \eta_{\partial\bar{E}_k} = \eta_{\bar{E}_k}$ , where  $\nu$  is an outward pointing normal vector on  $\partial\bar{E}_k$ . Thus the orientation on  $\partial\bar{E}_k$  is

$$(P_i - P_j) \wedge (e_j^* - e_i^*) \wedge (e_k^* - e_i^*),$$

as  $P_i - P_k$  is an outward pointing normal vector. Similarly,  $\partial\bar{E}_l \cap X_b = T(\langle e_j^* - e_i^*, e_l^* - e_i^* \rangle) \subseteq T(N_k^\vee)$ , (using a different basepoint  $b_k \in U_k$ ) and  $\partial\bar{E}_l$  has orientation

$$(P_i - P_j) \wedge (e_j^* - e_i^*) \wedge (e_l^* - e_i^*).$$

Finally  $\partial\bar{E}_m \cap X_b = T(\langle e_j^* - e_i^*, e_m^* - e_i^* \rangle) \subseteq T(N_l^\vee)$ , using the same basepoint  $b_l \in U_l$  and path joining  $b_l$  and  $b$ , and  $\partial\bar{E}_m$  has orientation

$$(P_i - P_j) \wedge (e_j^* - e_i^*) \wedge (e_m^* - e_i^*).$$

To compare these three boundaries, we choose a path joining  $b_k$  and  $b_l$ , and identify  $T(N_k^\vee)$  with  $T(N_l^\vee)$  using this path. Choose this path to pass from  $U_k$  into  $U^i$  into  $U_l$ , thus identifying  $N_k^\vee$  and  $N_l^\vee$  via  $T_{il} \circ T_{ik}^{-1}$ . Now  $T_{il} \circ T_{ik}^{-1}(e_j^* - e_i^*) = e_j^* - e_i^*$ , and  $T_{il} \circ T_{ik}^{-1}(e_l^* - e_i^*) = -(e_j^* - e_i^*) - (e_k^* - e_i^*) - (e_m^* - e_i^*)$ . Thus the orientation on  $\partial\bar{E}_l$  is

$$(P_i - P_j) \wedge (e_j^* - e_i^*) \wedge (-(e_k^* - e_i^*) - (e_m^* - e_i^*)).$$

Since  $(e_j^* - e_i^*) \wedge (e_k^* - e_i^*)$ ,  $(e_j^* - e_i^*) \wedge (e_m^* - e_i^*)$  and  $(e_j^* - e_i^*) \wedge (-(e_k^* - e_i^*) - (e_m^* - e_i^*))$  add up to zero in  $H_2(X_b, \mathbf{Z})$ , it is then clear that the orientations on  $\bar{E}_k$ ,  $\bar{E}_l$  and  $\bar{E}_m$  are compatible with the gluing process. Thus  $E_{ij}^p$  is oriented by these compatible orientations.

Next for each  $i$  we glue together the 6 submanifolds  $\{L_{i,ijk} | \{j, k\} \subseteq \{0, \dots, 4\} - \{i\}\}$ . The triple  $L_{i,ijk}, L_{i,ijl}$  and  $L_{i,ijm}$  glue together as above over  $\langle P_i, P_j \rangle$ , with compatible orientations, so all six of these submanifolds can be glued together to obtain  $L_i$  which is a manifold except possibly over  $\check{f}^{-1}(P_i)$ . We need to clarify this structure. I claim in fact that this gluing can be done in such a way that there is an orientation preserving homeomorphism of  $L_i$  with  $\mathbf{P}^2$ .



To do this, we divide  $\mathbf{P}^2$  into six pieces which can be identified with the  $L_{i,ijk}$ 's. Without loss of generality take  $i = 4$ , and identify  $\mathbf{P}^2$  with  $\{z_0 + \cdots + z_3 = 0\} \subseteq \mathbf{P}^3$ . Let  $L_{jk} \subseteq \mathbf{P}^2$  be defined by

$$L_{jk} = \{(z_0, \dots, z_3) \in \mathbf{P}^2 \mid |z_j|, |z_k| < |z_l|, |z_m|, \{j, k, l, m\} = \{0, 1, 2, 3\}\}.$$

Then it is not difficult to see that  $L_{jk}$  can be identified with  $L_{i,ijk}$  in such a way that  $(\{z_j = 0\} \cap L_{jk}) \cup (\{z_k = 0\} \cap L_{jk})$  is identified with  $Crit(\check{f}) \cap L_{i,ijk}$ . We leave as an exercise to the reader to verify that the  $L_{i,ijk}$ 's can then be glued together inside  $\check{X}$  in the same way that the  $L_{jk}$ 's glue together to form  $\mathbf{P}^2$ . This gives a homeomorphism between  $L_i$  and  $\mathbf{P}^2$  which identifies  $Crit(\check{f})$  with the four lines  $\bigcup_{j=0}^3 \{z_j = 0\} \subseteq \mathbf{P}^2$ .

We have now identified the relevant set  $S \subseteq H^2(\check{X}, \mathbf{Z})$  of elements, namely the Poincaré dual cohomology classes of the oriented manifolds  $E_{ij}^p$ ,  $E_{ijk}^p$  and  $L_i$  defined above. We will also think of  $S$  as the set of these oriented manifolds. Note that while the cohomology classes in  $S$  still depend on a choice of orientation on  $\check{X}$ , the intersection numbers  $D_1 \cdot D_2 \cdot D_3 \in \mathbf{Z}$ , for  $D_1, D_2, D_3 \in S$ , do not depend on the choice of orientation: a change of orientation changes the signs of  $D_1, D_2$  and  $D_3$ , and the sign of the identification  $H^6(\check{X}, \mathbf{Z}) \cong \mathbf{Z}$ . Thus in particular, if we wish to compute one of the intersection numbers corresponding to those described in Proposition 4.2 (3), this intersection number can in fact be calculated by performing this intersection in  $Y_\Sigma$ . It is then clear that all intersection numbers described in Proposition 4.2 (3) are valid in  $\check{X}$ . The same is also true for those intersection numbers given in Proposition 4.2, (4): all of the intersection numbers  $D_1 \cdot D_2 \cdot D_3$  not mentioned explicitly in Proposition 4.2 (2) and (3) are zero because the intersection of the corresponding submanifolds is empty.

Thus there remains the intersection numbers in Proposition 4.2, (2); these require more work. It is easy to see that all intersection numbers given in Proposition 4.2, (2) follow from the following five claims:

*Claim 1.*

$$(E_{ij}^{p-1})^2 \cdot E_{ij}^p + E_{ij}^p \cdot (E_{ij}^{p+1})^2 = -3, \quad 1 \leq p \leq 4,$$

with the convention that  $E_{ij}^0 = L_i$  and  $E_{ij}^5 = L_j$ .

Proof. As toric divisors,  $E_{ij,ijk}^p, E_{ij,ijl}^p$  and  $E_{ij,ijm}^p$  are ruled surfaces over the affine line  $\mathbf{C}$ , each with one reducible fibre consisting of a union of two  $-1$  curves. One way to see this structure topologically is as follows. Recall  $E_{ij,ijk}^p = q_{lm}^{-1}(\{p\} \times \overline{\mathcal{O}_\tau})$  for suitable  $\tau$ . The set  $\overline{\mathcal{O}_\tau}$  can be seen as one of the three sheets in Figure 4.9. Write the boundary of  $\overline{\mathcal{O}_\tau}$  as the union of five line segments:  $l_1$  and  $l_2$  being the image of the two  $-1$  spheres

under the map  $q_{lm} : E_{ij,ijk}^p \rightarrow \{p\} \times \overline{\mathcal{O}_\tau}$ ,  $m_1$  and  $m_2$  being the upper and lower edges of  $\overline{\mathcal{O}_\tau}$ , as depicted in Figure 4.9, and  $[b_1, b_2]$  being the fifth line segment. Now fibre  $\{p\} \times \overline{\mathcal{O}_\tau}$  in line segments by a map  $\gamma : \{p\} \times \overline{\mathcal{O}_\tau} \rightarrow [0, 1]$  so that  $\gamma^{-1}(0) = l_1 \cup l_2$ ,  $\gamma^{-1}(x)$  for  $x > 0$  is a line segment connecting  $m_1$  and  $m_2$ , and  $\gamma^{-1}(1) = [b_1, b_2]$ . Clearly  $q_{lm}^{-1}(\gamma^{-1}(0))$  is the union of the two  $-1$  spheres, while  $q_{lm}^{-1}(\gamma^{-1}(x))$  for  $x \in (0, 1)$  is easily seen to be  $S^1 \times S^2$ , in such a way that  $q_{lm} : \{q\} \times S^2 \rightarrow \gamma^{-1}(x)$  is the standard projection of a two-sphere to a line segment for any  $q \in S^1$ . Thus the map  $\gamma \circ q_{lm} : E_{ij,ijk}^p \rightarrow [0, 1]$  factors through an  $S^2$ -fibration  $\rho : E_{ij,ijk}^p \rightarrow D$ , where  $D$  is a disk. It is clear that these three fibrations on  $E_{ij,ijk}^p$ ,  $E_{ij,ijl}^p$  and  $E_{ij,ijm}^p$  glue together to yield a map  $\rho : E_{ij}^p \rightarrow S^2$  whose general fibre is an  $S^2$ , and three fibres being the union of two  $-1$  spheres. In addition,  $C_1 = E_{ij}^{p-1} \cap E_{ij}^p$  and  $C_2 = E_{ij}^p \cap E_{ij}^{p+1}$  are sections of  $\rho$ . Let  $\beta : E_{ij}^p \rightarrow E$  be the blow-down of three  $-1$  spheres, one on each singular fibre. Then  $\rho$  induces a map  $\rho' : E \rightarrow S^2$  with  $\rho = \rho' \circ \beta$ , and  $E$  is an  $S^2$  bundle over  $S^2$ , hence homeomorphic to  $\mathbf{P}(\mathcal{O}_{\mathbf{P}^1} \oplus \mathcal{O}_{\mathbf{P}^1}(n))$  for some  $n$ . In particular,  $\beta(C_1)$  and  $\beta(C_2)$  are still disjoint sections of  $\rho'$ , so  $\beta(C_1)^2 + \beta(C_2)^2 = 0$ . Thus, on the blow-up  $E_{ij}^p$ ,  $C_1^2 + C_2^2 = -3$ . But  $C_1^2 = E_{ij}^p \cdot (E_{ij}^{p-1})^2$  and  $C_2^2 = E_{ij}^p \cdot (E_{ij}^{p+1})^2$ , hence Claim 1 follows. •

*Claim 2.*  $(E_{ij}^p)^3 = 5$ ,  $1 \leq p \leq 4$ .

*Proof.* Before starting, let us note that by Example 2.16, the canonical orientation on  $\text{Crit}(\check{f})$  can be described as follows. Every component of  $\text{Crit}(\check{f})$  is the intersection  $D_1 \cap D_2$  of some two oriented submanifolds  $D_1, D_2 \in S$ . The canonical orientation of this component of  $\text{Crit}(\check{f})$  is that of the oriented intersection  $D_1 \cap D_2$ . As remarked in Example 2.16, this is independent of the choice of orientation on  $\check{X}$ .

Now perturb  $E_{ij}^p$  to  $\tilde{E}_{ij}^p$  by perturbing  $\check{f}(E_{ij}^p)$ . This can be done as pictured in Figure 4.10:

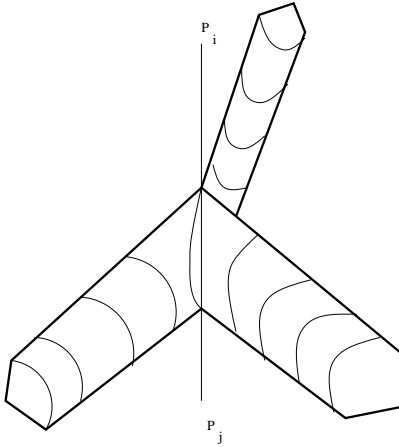

Figure 4.10

We keep  $\partial\check{f}(E_{ij}^p)$  fixed but move the interior. This can be done in such a way that

$\check{f}(E_{ij}^p) \cap \check{f}(\tilde{E}_{ij}^p)$  consists of the union of  $\check{f}(E_{ij}^p) \cap \Delta$  and a line segment  $s$  with endpoints  $b_1$  and  $b_2$ . It is clear that the contribution to  $E_{ij}^p \cap \tilde{E}_{ij}^p$  sitting over  $\check{f}(E_{ij}^p) \cap \Delta$  is  $Crit(\check{f}) \cap E_{ij}^p = C_1 \cup C_2 \cup e_1 \cup \dots \cup e_6$ , where  $C_1$  and  $C_2$  are the two sections of  $\rho$  as in the proof of Claim 1, and  $e_1, \dots, e_6$  are the 6 toric  $-1$   $\mathbf{P}^1$ 's. The orientation on these components of the oriented intersection  $E_{ij}^p \cap \tilde{E}_{ij}^p$  is the opposite orientation to the canonical orientation on  $Crit(\check{f})$ . One way to see this is to do a similar procedure with one of the divisors  $E_{ijk}^p$  fibering over  $\overline{\mathcal{O}_\tau}$ ,  $\tau$  a vertex in the interior of the triangulation of Figure 4.6. The self-intersection  $(E_{ijk}^p)^2$  can be computed by perturbing  $\overline{\mathcal{O}_\tau}$ , to obtain  $\tilde{E}_{ijk}^p$ , so that  $E_{ijk}^p \cap \tilde{E}_{ijk}^p = Crit(\check{f}) \cap E_{ijk}^p$ . However, from the toric geometry of  $Y_\Sigma$  it is known that  $(E_{ijk}^p)^2$  can be represented by the two-cycle supported on  $Crit(\check{f}) \cap E_{ijk}^p$  with the opposite orientation to the canonical orientation. Since the  $E_{ij}^p$ 's were oriented in the same manner as the  $E_{ijk}^p$ 's, the same must be true for the former self-intersection.

The contribution to  $E_{ij}^p \cap \tilde{E}_{ij}^p$  sitting over the line segment  $s$  is seen to be an  $S^2$ , homologous to a fibre  $f$  of  $\rho$ , oriented so that  $f \cdot C_1 = f \cdot C_2 = 1$  with  $C_1, C_2$  having the canonical orientation. Thus as a cohomology class in  $H^2(E_{ij}^p, \mathbf{Z})$ , with  $e_1, \dots, e_6$  also oriented by the canonical orientation,  $E_{ij}^p \cap \tilde{E}_{ij}^p = -C_1 - C_2 - \sum e_i + f$ . Now  $(E_{ij}^p)^3$  coincides with  $(-C_1 - C_2 - \sum e_i + f)^2$  computed on  $E_{ij}^p$ . This is

$$\begin{aligned} & C_1^2 + C_2^2 + \sum e_i^2 + f^2 + 2 \sum_{i < j} e_i \cdot e_j + 2 \sum e_i \cdot (C_1 + C_2) - 2f \cdot C_1 - 2f \cdot C_2 \\ &= C_1^2 + C_2^2 - 6 + 0 + 6 + 12 - 2 - 2 \\ &= C_1^2 + C_2^2 + 8. \end{aligned}$$

But in the proof of Claim 1 it was shown that  $C_1^2 + C_2^2 = -3$ , hence  $(E_{ij}^p)^3 = 5$ . •

*Claim 3.*  $E_{ij}^{p-1} \cdot (E_{ij}^p)^2 + (E_{ij}^p)^2 \cdot E_{ij}^{p+1} = -1$ ,  $1 \leq p \leq 4$ .

*Proof.* Recall the index  $I(M)$  of an oriented 4-dimensional manifold  $M$  is  $q_+ - q_-$ , where the intersection form on  $H^2(M, \mathbf{Q})$  has signature  $(q_+, q_-)$ . By [10], 9.2, page 88,  $I(E_{ij}^p) = \frac{1}{3}(-(E_{ij}^p)^3 + p_1(\check{X}) \cdot E_{ij}^p)$ . Now from the proof of Claim 1 it is clear that  $I(E_{ij}^p) = 1 - 4 = -3$ , so by Claim 2,  $p_1(\check{X}) \cdot E_{ij}^p = -4$ . On the other hand,  $p_1(\check{X}) = -2Crit(\check{f})$ . It is easy to see from the description of the canonical orientation on  $Crit(\check{f})$  at the beginning of the proof of Claim 2 that

$$p_1(\check{X}) \cdot E_{ij}^p = -2(E_{ij}^{p-1} \cdot E_{ij}^p + E_{ij}^p \cdot E_{ij}^{p+1}) \cdot E_{ij}^p - 2(-6 + 9)$$

where the second term is the contribution from the six toric  $-1$   $\mathbf{P}^1$ 's on  $E_{ij}^p$  and nine additional curves of  $Crit(\check{f})$  not contained in  $E_{ij}^p$ , but intersecting it. From this one derives the formula of Claim 3. •

*Claim 4.*  $L_i \cdot (E_{ij}^1)^2 = 1$ .

Proof.  $L_i$  is homeomorphic to  $\mathbf{P}^2$ , and by construction of this homeomorphism,  $L_i \cap E_{ij}^1$  is a generator of  $H^2(L_i, \mathbf{Z})$ . Thus in  $L_i$ ,  $(L_i \cap E_{ij}^1)^2 = 1$ . But  $(L_i \cap E_{ij}^1)^2 = L_i \cdot (E_{ij}^1)^2$ . •

*Claim 5.*  $L_i^3 = 9$ .

Proof. As in the proof of Claim 3,

$$1 = I(L_i) = \frac{1}{3}(-L_i^3 + p_1(\check{X}) \cdot L_i)$$

so

$$\begin{aligned} L_i^3 &= p_1(\check{X}) \cdot L_i - 3 \\ &= -2\text{Crit}(\check{f}) \cdot L_i - 3 \\ &= -2 \left( \sum_{j \neq i} E_{ij}^1 \cdot L_i^2 + 6 \right) - 3. \end{aligned}$$

Here the contribution of 6 is for the six components of  $\text{Crit}(\check{f})$  intersecting  $L_i$  but not contained in it. It follows from Claims 1, 3 and 4 that  $E_{ij}^1 \cdot L_i^2 = -3$ , and hence

$$L_i^3 = -2(4 \cdot (-3) + 6) - 3 = 9. \bullet$$

Finally, it is clear that all intersections of  $p_1(\check{X})$  agree with those given in Proposition 4.2, (5) (with  $p_1(W) = -2c_2(W)$ ). Indeed, these were already calculated in the proof of Claims 3 and 5 for  $E_{ij}^l$  and  $L_i$ , and one sees easily that  $E_{ijk}^l \cdot \text{Crit}(\check{f}) = 0$ . Thus we can conclude, by Wall's theorem, that  $\check{X}$  is diffeomorphic to the mirror quintic  $W$ . •

*Remark 4.5.* We end this paper with the question: what if we had chosen a different toric resolution of the singular mirror quintic  $W'$ ? It is clear that our particular choice of resolution was already present in the construction of our  $T^3$ -fibration on the quintic, in Figure 4.3, as dictated by the construction of §3. Now two different toric resolutions differ by a sequence of toric flops. A toric flop is given by making the following change to a trapezoid in Figure 4.6:

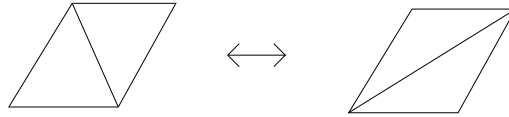

Figure 4.11

Such a flop gives a resolution  $W_2$  of  $W'$ . The point is that we can at the same time alter the fibration  $f : X \rightarrow B$  on the quintic to a fibration  $f' : X' \rightarrow B$ , simply by making a

change in the discriminant locus pictured in Figure 4.3. This change is represented by the following diagram:

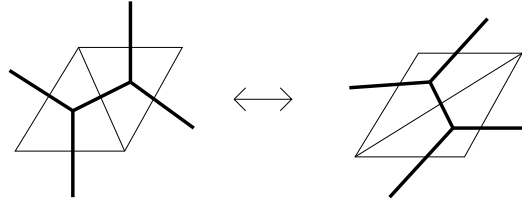

Figure 4.12

It is clear that the new fibration  $f' : X' \rightarrow B$  so constructed is still a  $T^3$ -fibration on the quintic. Nowhere in the details of the proof that  $X$  was diffeomorphic to the quintic did we make use of the detailed structure of  $\Delta$ . Furthermore, by running through the proof that  $\check{X}$  is diffeomorphic to  $W$ , one finds that  $\check{X}'$  is diffeomorphic to  $W_2$ . Thus we see how a change in the fibration  $f : X \rightarrow B$ , but *not* a change in  $X$  itself, gives rise to two duals related by a flop.

This is an interesting enough phenomenon that it is worth noting it really is a local one. One can construct over a closed 3-ball  $B$  two different  $T^3$ -fibrations,  $f_1 : X_1 \rightarrow B$  and  $f_2 : X_2 \rightarrow B$  by applying the construction of Proposition 2.5 to  $S_1, S_2 \subseteq \bar{Y} = T^2 \times B$ , where  $S_1$  and  $S_2$  are both homeomorphic to  $S^2 - \{p_1, p_2, p_3, p_4\}$ , and are fibred over the two discriminant loci  $\Delta_1, \Delta_2$  pictured below, with classes in  $T^2$  over each branch as labelled. Here  $\Delta_1 \cap \partial B = \Delta_2 \cap \partial B$ , and  $S_1$  and  $S_2$  can be chosen so that  $\partial \bar{Y} \cap S_1 = \partial \bar{Y} \cap S_2$ .

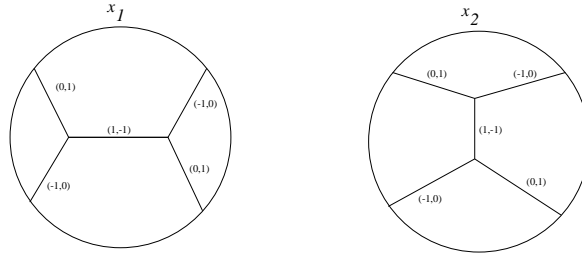

Figure 4.13

There is in fact an isotopy  $I : \bar{Y} \times [0, 1] \rightarrow \bar{Y} \times [0, 1]$  which is the identity on  $\partial \bar{Y}$ ,  $I_0 = id$  and  $I_1(S_1) = S_2$ . This can be seen by first constructing an isotopy  $I' : S_1 \times [0, 1] \rightarrow \bar{Y} \times [0, 1]$  with  $I'_0 : S_1 \rightarrow \bar{Y}$  the embedding of  $S_1$  into  $\bar{Y}$ , and  $I'_1 : S_1 = S_2 \rightarrow \bar{Y}$  the embedding of  $S_2$  into  $\bar{Y}$ . One then applies Corollary 2.4 of [11] to obtain  $I$ . In particular,  $I_1$  induces a homeomorphism  $\varphi : X_1 \rightarrow X_2$  which is the identity on  $\partial X_1 = \partial X_2$ .

Now the duals of  $f_1$  and  $f_2$  can be constructed, giving  $\check{f}_1 : \check{X}_1 \rightarrow B$  and  $\check{f}_2 : \check{X}_2 \rightarrow B$ . It is clear that  $\check{X}_1$  and  $\check{X}_2$  are related by a flop. On the other hand,  $\varphi : \partial X_1 \rightarrow \partial X_2$  is the identity, and this induces an isomorphism  $\check{\varphi} : \partial \check{X}_1 \rightarrow \partial \check{X}_2$ . However, it is possible to show that this homeomorphism does not extend to a homeomorphism  $\check{\varphi} : \check{X}_1 \rightarrow \check{X}_2$ .

We will not show this here, but point out that we should expect this, for otherwise every toric resolution of  $W'$  would be homeomorphic, which we don't expect to be the case. We also note that if we naively tried to construct such a homeomorphism, we might try to proceed as follows.  $\check{X}_1$  and  $\check{X}_2$  are both expressed as  $T^2$ -fibrations over  $S^1 \times B$ , with these fibrations failing to be  $T^2$ -bundles over  $\{p\} \times \Delta_1$  and  $\{p\} \times \Delta_2 \subseteq S^1 \times B$ . We might try to construct a homeomorphism  $S^1 \times B$  taking  $\{p\} \times \Delta_1$  to  $\{p\} \times \Delta_2$ , while being the identity on  $\partial(S^1 \times B)$ . This is clearly impossible, because the two discriminant loci

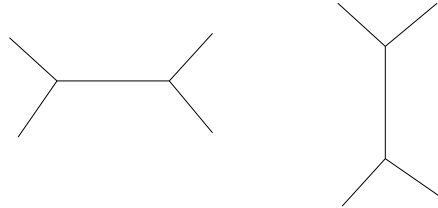

Figure 4.14

are clearly not the same if the end-points are marked. On the other hand,  $X_1$  and  $X_2$  were diffeomorphic because the two surfaces  $S_1$  and  $S_2$  were the same:

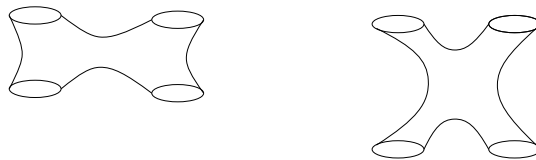

Figure 4.15

This might remind the reader of one of the basic features underlying string theory.

## Bibliography

- [1] Aspinwall, P., Greene, B., and Morrison, D., “Calabi-Yau Moduli Space, Mirror Manifolds and Spacetime Topology Change in String Theory,” *Nuclear Phys. B*, **416**, (1994), 414–480.
- [2] Batyrev, V., “Dual Polyhedra and Mirror Symmetry for Calabi-Yau Hypersurfaces in Toric Varieties,” *J. Alg. Geom.*, **3**, (1994), 493–535.
- [3] Bredon, G., *Sheaf Theory*, 2nd edition, Springer-Verlag, 1997.
- [4] Chiang, T.-M., Klemm, A., Yau, S.-T. and Zaslow, E., “Local Mirror Symmetry: Calculations and Interpretations,” preprint, hep-th/9903053.
- [5] Dais, D., “Enumerative Combinatorics of Invariants of Certain Complex Threefolds with Trivial Canonical Bundle,” *Bonner Mathematische Schriften*, **279**, (1995).
- [6] Gross, M., “Special Lagrangian Fibrations I: Topology,” in *Integrable Systems and Algebraic Geometry*, eds. M.-H. Saito, Y. Shimizu and K. Ueno, World Scientific, 1998, 156–193.

- [7] Gross, M., “Special Lagrangian Fibrations II: Geometry,” to appear in *Surveys in Differential Geometry*.
- [8] Gross, M., and Wilson, P.M.H., “Mirror Symmetry via 3-tori for a Class of Calabi-Yau Threefolds,” *Math. Ann.*, **309**, (1997) 505–531.
- [9] Harvey, R., and Lawson, H.B. Jr., “Calibrated Geometries,” *Acta Math.* **148**, 47-157 (1982).
- [10] Hirzebruch, F., *Topological Methods in Algebraic Geometry*, Second corrected printing to Third edition, Springer-Verlag, 1978.
- [11] Hudson, J.F.P., and Zeeman, E.C., “On Combinatorial Isotopy,” *Inst. Hautes Études Sci. Publ. Math.*, **19**, (1964) 69–94.
- [12] Humphreys, J., *Linear Algebraic Groups*, Springer-Verlag, 1975.
- [13] Lawson, H.B. Jr., and Michelsohn, M.-L., *Spin Geometry*, Princeton University Press, 1989.
- [14] Morrison, D., “The Clemens-Schmid Exact Sequence and Applications,” in *Topics in Transcendental Algebraic Geometry*, edited by P. Griffiths, Princeton University Press.
- [15] Morrison, D., “Mirror Symmetry and Rational Curves on Quintic Threefolds: A Guide for Mathematicians,” *J. Amer. Math. Soc.*, **6**, (1993), 223–247.
- [16] Oda, T., *Convex Bodies and Algebraic Geometry*, Springer, 1988.
- [17] Ruan, W.-D., “Lagrangian Tori Fibration of Toric Calabi-Yau Manifold I,” preprint, math.DG/9904012.
- [18] Ruan, W.-D., “Lagrangian Tori Fibration of Toric Calabi-Yau Manifold III: Symplectic Topological SYZ Mirror Construction for General Quintics,” preprint, math.DG/9909126.
- [19] Strominger, A., Yau, S.-T., and Zaslow, E., “Mirror Symmetry is T-Duality,” *Nucl. Phys.* **B479**, (1996) 243–259.
- [20] Wall, C.T.C., “Classification Problems in Differential Topology. V. On Certain 6-manifolds,” *Inv. Math.* **1**, (1966), 355–374.
- [21] Zharkov, I., “Torus Fibrations of Calabi-Yau Hypersurfaces in Toric Varieties and Mirror Symmetry,” preprint, alg-geom/9806091, to appear in *Duke Math. J.*