

To my teacher Igor Frenkel

A categorification of the Jones polynomial

Mikhail Khovanov

February 1, 2008

Contents

1	Introduction	2
2	Preliminaries	5
2.1	The ring R	5
2.2	The algebra A	6
2.3	Algebra A and $(1+1)$ -dimensional cobordisms	7
2.4	Kauffman bracket	8
3	Cubes	9
3.1	Complexes of R -modules	9
3.2	Commutative cubes	10
3.3	skew-commutative cubes	11
3.4	skew-commutative cubes and complexes	12
4	Diagrams	13
4.1	Reidemeister moves	13
4.2	Constructing cubes and complexes from plane diagrams	14
4.3	Surfaces and cube morphisms	18
5	Transformations	20
5.1	Left-twisted curl	20
5.2	Right-twisted curl	24
5.3	The tangency move	26
5.4	Triple point move	31
6	Properties of cohomology groups	34
6.1	Some elementary properties	34
6.2	Computational shortcuts and cohomology of $(2, n)$ torus links	35
6.3	Link cobordisms and maps of cohomology groups	39
7	Setting c to 0	40
7.1	Cohomology groups $\mathcal{H}^{i,j}$	40
7.2	Properties of $\mathcal{H}^{i,j}$: Euler characteristic, change of orientation	41
7.3	Cohomology of the mirror image	42
7.4	Cohomology of the disjoint union and connected sum of knots	43
7.5	A spectral sequence	45
7.6	Examples	45

This paper will appear in Duke Mathematical Journal

7.7	An application to the crossing number	46
8	Invariants of (1, 1)-tangles	47
8.1	Graded A -modules	47
8.2	Non-closed (1+1)-cobordisms	48
8.3	(1, 1)-tangles	49
8.4	Invariants	49

1 Introduction

During the past 15 years many new structures have arisen in the topology of low-dimensional manifolds: the Jones and HOMFLY polynomials of links, Witten-Reshetikhin-Turaev invariants of 3-manifolds, Floer homology groups of homology 3-spheres, Donaldson and Seiberg-Witten invariants of 4-manifolds. These invariants of 3- and 4-manifolds naturally split into two groups. Members of the first group are combinatorially defined invariants of knots and 3-manifolds, such as various link polynomials, finite type invariants and quantum invariants of 3-manifolds. Floer and Seiberg-Witten homology groups of 3-manifolds and Donaldson-Seiberg-Witten invariants of 4-manifolds constitute the second group. While invariants from the first group have a combinatorial description and in each instance can be computed algorithmically, invariants from the second group are understood through moduli spaces of solutions of suitable differential-geometric equations and the infinite-dimensional Morse theory and have evaded all attempts at a finite combinatorial definition. These invariants have been computed for many 3- and 4-manifolds, yet the methods of computation use some extra structure on these manifolds, such as Seifert fibering or complex structure and the problem of finding an algorithmic construction of these invariants remains open.

It is probably due to this striking difference in the origins and computational complexity that so far not many direct relations have been found between invariants from different groups. The most notable connection is the Casson invariant of homology 3-spheres [AM], which is equal to the Euler characteristic of Floer homology [F]. Yet the Casson invariant is computable and intimately related to the Alexander polynomial of knots and (see [M]) to Witten-Reshetikhin-Turaev invariants, which are examples of invariants from the first group. A similar relation has recently been discovered between Seiberg-Witten invariants and Milnor torsion of 3-manifolds ([MT]). In summary, Euler characteristics of Floer and Seiberg-Witten homology groups bear an algorithmic description, while no such procedure is known for finding the groups themselves.

A speculative question now comes to mind: quantum invariants of knots and 3-manifolds tend to have good integrality properties. What if these invariants can be interpreted as Euler characteristics of some homology theories of 3-manifolds?

Our results suggest that such an interpretation exists for the Jones polynomial of links in 3-space ([Jo]). We give an algorithmic procedure that to a generic plane projection D of an oriented link L in \mathbb{R}^3 associates cohomology groups $\mathcal{H}^{i,j}(D)$ that depend on two integers i, j . If two diagrams D_1 and D_2 of the same link L are related by a Reidemeister move, a canonical isomorphism of groups $\mathcal{H}^{i,j}(D_1)$ and $\mathcal{H}^{i,j}(D_2)$ is constructed. Thus, isomorphism classes of these groups are invariants of the link L . These groups are finitely generated and may have non-trivial torsion. Tensoring these groups with \mathbb{Q} we get a two-parameter family $\{\dim_{\mathbb{Q}}(\mathcal{H}^{i,j}(D) \otimes \mathbb{Q})\}_{i,j \in \mathbb{Z}}$ of integer-valued link invariants.

From our construction of groups $\mathcal{H}^{i,j}(D)$ we immediately conclude that the graded Euler characteristic

$$\sum_{i,j} (-1)^i q^j \dim_{\mathbb{Q}}(\mathcal{H}^{i,j}(D) \otimes \mathbb{Q}) \tag{1}$$

is equal, up to a simple change of variables, to the Jones polynomial of L , multiplied by $q + q^{-1}$.

We conjecture that not just the isomorphism classes of $\mathcal{H}^{i,j}(D)$ but the groups themselves are invariants of links. We will consider this conjecture in a subsequent paper.

To define cohomology groups $\mathcal{H}^{i,j}(D)$ we start with the Kauffman state sum model [Ka] for the Jones polynomial and then, roughly speaking, turn all integers into complexes of abelian groups. In the Kauffman model a link is projected generically onto the plane so that the projection has a finite number of double transversal intersections. There are two ways to “smooth” the projection near the double point, i.e., erase

the intersection of the projection with a small neighbourhood of the double point and connect the four resulting ends by a pair of simple, nonintersecting arcs:

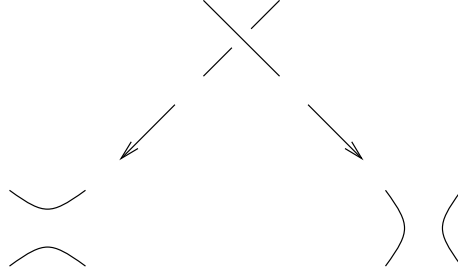

A diagram D with n double points admits 2^n resolutions of these double points. Each of the resulting diagrams is a collection of disjoint simple closed curves on the plane. In [Ka] Kauffman associates Laurent polynomial $(-q - q^{-1})^k$ to a collection of k simple curves and then forms a weighted sum of these numbers over all 2^n resolutions. After normalization, Kauffman obtains the Jones polynomial of the link L . The principal constant in this construction is $-q - q^{-1}$, the number associated to a simple closed curve.

In our approach $q + q^{-1}$ becomes a certain module A over the base ring $\mathbb{Z}[c]$. In detail, we work over the graded ring $\mathbb{Z}[c]$ of polynomials in c , where c has degree 2, and we define A to be a free $\mathbb{Z}[c]$ -module of rank two with generators in degrees 1 and -1 . This is the object we associate to a simple closed curve in the plane.

Given a diagram D , to each resolution of all double points of D we associate the graded $\mathbb{Z}[c]$ -module $A^{\otimes k}$, where k is the number of curves in the resolution. Then we glue these modules over all 2^n resolutions into a complex $C(D)$ of graded $\mathbb{Z}[c]$ -modules. The gluing maps come from commutative algebra and cocommutative coalgebra structure on A . When two diagrams D_1 and D_2 are related by a Reidemeister move, we construct a quasi-isomorphism between the complexes $C(D_1)$ and $C(D_2)$.

The cohomology groups $H^i(D)$ of the complex $C(D)$ are graded R -modules and we prove that isomorphism classes of $H^i(D)$ do not depend of the choice of a diagram of the link. We then look at some elementary properties of these groups and introduce several cousins of $H^i(D)$.

Outline of the paper. In Section 2 we define an algebra A over the ring $R = \mathbb{Z}[c]$ and use A to construct a 2-dimensional topological quantum field theory. In our case this topological quantum field theory is a functor from the category of two-dimensional cobordisms between one-dimensional manifolds to the category of graded $\mathbb{Z}[c]$ -modules. In Section 2.4 we review the Kauffman state sum model [Ka] for the Jones polynomial of oriented links.

In Section 4.2, we associate a complex of $\mathbb{Z}[c]$ -modules to a plane diagram of a link. As an intermediate step, to a diagram D we associate a commutative cube V_D of $\mathbb{Z}[c]$ -modules and maps between them, i.e., we consider an n -dimensional cube with its edges standardly oriented and, given a plane projection with n double points of a link, to each vertex of the cube we associate a $\mathbb{Z}[c]$ -module and to each oriented edge a map of modules so that all square facets of this diagram are commutative squares. This is done in Section 4.2. In the same section we pass from commutative cubes to complexes of $\mathbb{Z}[c]$ -modules and to a diagram D we associate a complex $C(D)$ of graded $\mathbb{Z}[c]$ -modules.

Earlier, in Section 3, we review the notions of a commutative cube and a map between commutative cubes.

In Section 4.1 we review Reidemeister moves. In Section 5, which is the technical core of the paper, to a Reidemeister move between diagrams D_1 and D_2 we associate a quasi-isomorphism between the complexes $C(D_1)$ and $C(D_2)$. These isomorphisms seem to be canonical. We conjecture that the quasi-isomorphisms are coherent, which would naturally associate cohomology groups to links. Our quasi-isomorphism result shows that the isomorphism classes of the cohomology groups are invariants, but not necessarily that the groups are functorial under link isotopy.

We define $H^i(D)$ to be the i -th cohomology group of the complex $C(D)$. These cohomology groups are graded $\mathbb{Z}[c]$ -modules, and the isomorphism class of each $H^i(D)$ is a link invariant. If we split these groups into the direct sum of their graded components,

$$H^i(D) = \bigoplus_{j \in \mathbb{Z}} H^{i,j}(D), \quad (2)$$

we get a two-parameter family of “abelian group valued” link invariants. These results are stated earlier, at the end of Section 4.2, as Theorems 1 and 2. For a diagram D , the groups $H^{i,j}(D)$ are trivial for $j \ll 0$. Moreover, for each j only finitely many of the groups $H^{i,j}(D)$ are non-zero. Consequently, the graded Euler characteristic of $C(D)$, defined as

$$\widehat{\chi}(C(D)) = \sum_{i,j \in \mathbb{Z}} (-1)^i q^j \dim_{\mathbb{Q}}(H^{i,j}(D) \otimes \mathbb{Q}), \quad (3)$$

is well-defined as a Laurent series in q . Since our construction of $C(D)$ lifts Kauffman’s construction of the Jones polynomial, it is not surprising that the graded Euler characteristic of $C(D)$ is related to the Jones polynomial. Namely, $\widehat{\chi}(C(D))$, multiplied by $\frac{1-q^2}{q+q^{-1}}$, is equal, after a simple change of variables, to the Jones polynomial of L .

In Section 7 we explain how a version of our construction when the base algebra $\mathbb{Z}[c]$ is reduced to \mathbb{Z} by taking $c = 0$ produces graded cohomology groups $\mathcal{H}^{i,j}(D)$. The complex which is used to define $\mathcal{H}^{i,j}(D)$ is given by tensoring $C(D)$ with \mathbb{Z} over $\mathbb{Z}[c]$. As before, the isomorphism classes of these groups are invariants of links. These groups are “smaller” than the groups $H^{i,j}(D)$. In particular, for each D , these groups are non-zero for only finitely many pairs (i, j) of integers. As with the groups $H^{i,j}(D)$, the graded Euler characteristic

$$\sum_{i,j} (-1)^i q^j \dim_{\mathbb{Q}}(\mathcal{H}^{i,j}(D) \otimes \mathbb{Q}), \quad (4)$$

divided by $q + q^{-1}$, is equal to the Jones polynomial of the link represented by the diagram D . In Section 7.5 we exhibit a spectral sequence whose E_1 -term is made of $\mathcal{H}(D)$ and which converges to $H(D)$. Apparently, $H(D)$ is a kind of S^1 -equivariant version of the groups $\mathcal{H}^{i,j}(D)$. In Section 7.7 we use these cohomology groups to reprove a result of Thistlethwaite on the crossing number of adequate links.

If a link in \mathbb{R}^3 has cohomology groups, then cobordisms between links, i.e., surfaces embedded in $\mathbb{R}^3 \times [0, 1]$, should provide maps between the associated groups. A surface embedded in the 4-space can be visualized as a sequence of plane projections of its 3-dimensional sections (see [CS]). Given such a presentation J of a compact oriented surface S properly embedded in $\mathbb{R}^3 \times [0, 1]$ with the boundary of S being the union of two links $L_0 \subset \mathbb{R}^3 \times \{0\}$ and $L_1 \subset \mathbb{R}^3 \times \{1\}$, we explain in Section 6.3 how to associate to J a map of cohomology groups

$$\theta_J : H^{i,j}(D_0) \longrightarrow H^{i,j+\chi(S)}(D_1), \quad i, j \in \mathbb{Z}, \quad (5)$$

$\chi(S)$ being the Euler characteristic of the surface S and D_0 and D_1 – diagrams of L_0 and L_1 induced by J . We conjecture that, up to an overall minus sign, this map does not depend on the choice of J , in other words, $\pm\theta_J$ behaves invariantly under isotopies of S .

If this conjecture is true, we get a 4-dimensional topological quantum field theory, restricted to links in \mathbb{R}^3 and $\mathbb{R}^3 \times [0, 1]$ -cobordisms between them. Because the theory has a combinatorial definition, all cohomology groups and maps between them will be algorithmically computable. If successful, this program will realize the Jones polynomial as the Euler characteristic of a cohomology theory of link cobordisms.

Section 8 presents mild variations on cohomology groups $H^i(D)$ and $\mathcal{H}^{i,j}(D)$. There we switch from links to $(1, 1)$ -tangles. We consider the category $A\text{-mod}_0$ of graded A -modules and grading-preserving homomorphisms between them. Given a plane diagram D of a $(1, 1)$ -tangle L and a graded A -module M , in Section 8.3 we define cohomology groups $H^i(D, M)$ which are graded A -modules. The arguments of Sections 4-5 go through without a single alteration and show that isomorphism classes of $H^i(D, M)$ do not depend on the choice of D and are invariants of the underlying $(1, 1)$ -tangle L . In fact, to every $(1, 1)$ -tangle and an integer i we associate an isomorphism class of functors from the category of graded A -modules to itself.

Motivations for this work and its relations to representation theory. What is the representation-theoretical meaning of the cohomology groups $H^{i,j}(D)$? The Jones polynomial of links is encoded in the finite-dimensional representation theory of the quantum group $U_q(\mathfrak{sl}_2)$. It was shown in [FK] and [K] that the integrality and positivity properties of the Penrose-Kauffman q -spin networks calculus, of which the Jones polynomial is a special instance, are related to Lusztig canonical bases in tensor products of finite-dimensional $U_q(\mathfrak{sl}_2)$ -representations. Lusztig’s theory [L], among other things, says that various structure coefficients of quantum

groups can be obtained as dimensions of cohomology groups of sheaves on quiver varieties. This suggests a “categorification” of quantum groups and their representations, i.e. that there exist certain categories and 2-categories whose Grothendieck groups produce quantum groups and their representations.

Louis Crane and Igor Frenkel [CF] conjectured that quantum \mathfrak{sl}_2 invariants of 3-manifolds can be lifted to a 4-dimensional topological quantum field theory via canonical bases of Lusztig. They also introduced a notion of Hopf category and associated to it 4-dimensional invariants. Representations of a Hopf category form a 2-category, and a relation between 2-categories and invariants of 2-knots in \mathbb{R}^4 was established in [Fs].

In joint work with Bernstein and Frenkel [BFK], we propose a categorification of the representation theory of $U_q(\mathfrak{sl}_2)$ via categories of highest weight representations for Lie algebras \mathfrak{gl}_n for all natural n . This approach can be viewed as an algebraic counterpart of Lusztig’s original geometric approach to canonical bases. Motivated by the geometric constructions of [BLM] and [GrL], we obtain a categorification of the Temperley-Lieb algebra and Schur quotients of $U(\mathfrak{sl}_2)$ via projective and Zuckerman functors. We consider categories \mathcal{O}_n that are direct sums of certain singular blocks of the category \mathcal{O} for \mathfrak{gl}_n . Given a tangle L in the 3-space with n bottom and m top ends and a plane projection P of L , we associate to P a functor between derived categories $D^b(\mathcal{O}_n)$ and $D^b(\mathcal{O}_m)$. Properties of these functors suggest that their isomorphism classes, up to shifts in the derived category, are invariants of tangles. When the tangle is a link L , we expect to get cohomology groups $\mathbb{H}^i(L)$ as invariants of links. These groups will be a special case of the cohomology groups constructed in this paper: conjecturally

$$\mathbb{H}^i(L) = \bigoplus_j (\mathcal{H}^{i,j}(L) \otimes \mathbb{C}). \quad (6)$$

Acknowledgements. This work was started during a visit to the Institut des Hautes Etudes Scientifiques and finished at the Institute for Advanced Study. I am grateful to these institutions for creating a wonderful working atmosphere. During my stay at the Institute for Advanced Study I was supported by grant DMS 9304580 from the NSF.

I am indebted to Joseph Bernstein for interesting discussions, to Greg Kuperberg for reading and correcting the first version of the manuscript and explaining to me a natural way to hide minus signs, and to Oliver Dasbach and Arkady Vaintrob for pointing out that Corollary 13 was proved by Thistlethwaite [T].

On numerous occasions Igor Frenkel, who was my supervisor at Yale University, advised me to look for a lift of the Penrose-Kauffman quantum spin networks calculus to a calculus of surfaces in \mathbb{S}^4 . This work can be seen as a partial answer to his questions. It is a pleasure to dedicate this paper to my teacher Igor Frenkel.

2 Preliminaries

2.1 The ring R

Let $R = \mathbb{Z}[c]$ denote the ring of polynomials with integral coefficients. Introduce a \mathbb{Z} -grading on R by

$$\deg(1) = 0, \quad \deg(c) = 2. \quad (7)$$

Denote by $R\text{-mod}_0$ the abelian category of graded R -modules. Denote the i -th graded component of an object M of $R\text{-mod}_0$ by M_i . Morphisms in the category $R\text{-mod}_0$ are grading-preserving homomorphisms of modules. For $n \in \mathbb{Z}$ denote by $\{n\}$ the automorphism of $R\text{-mod}_0$ given by shifting the grading down by n . Thus for a graded R -module $N = \bigoplus_i N_i$, the shifted module $N\{n\}$ has graded components $N\{n\}_i = N_{i+n}$.

In this paper we will sometimes consider graded, rather than just grading-preserving, maps. A map $\alpha : M \rightarrow N$ of graded R -modules is called graded of degree i if $\alpha(M_j) \subset N_{i+j}$ for all $j \in \mathbb{Z}$.

Let $R\text{-mod}$ be the category of graded R -modules and graded maps between them. This category has the same objects as the category $R\text{-mod}_0$, but more morphisms. It is not an abelian category.

A graded map α is a morphism in the category $R\text{-mod}_0$ if and only if the degree of α is 0. At the end we will favor grading-preserving maps and when at some point we look at a graded map $\alpha : M \rightarrow N$ of degree i , later we will make it grading-preserving by appropriately shifting the degree of one of the modules. For example, α gives rise to a grading-preserving map $M \rightarrow N\{i\}$, also denoted α .

Let M be a finitely-generated graded R -module. As an abelian group, M is the direct sum of its graded components: $M = \bigoplus_{j \in \mathbb{Z}} M_j$, where each M_j is a finitely-generated abelian group. Define the *graded Euler characteristic* $\widehat{\chi}(M)$ of M by

$$\widehat{\chi}(M) = \sum_{j \in \mathbb{Z}} \dim_{\mathbb{Q}}(M_j \otimes_{\mathbb{Z}} \mathbb{Q}) q^j \quad (8)$$

Since

$$\widehat{\chi}(R) = 1 + q^2 + q^4 + \cdots = \frac{1}{1 - q^2}, \quad (9)$$

$\widehat{\chi}(M)$ is not, in general, a Laurent polynomial in q , but an element of the Laurent series ring. Moreover, for any M as above, there are Laurent polynomials $a, b \in \mathbb{Z}[q, q^{-1}]$ such that

$$\widehat{\chi}(M) = a + \frac{b}{1 - q^2} \quad (10)$$

2.2 The algebra A

Let A be a free graded R -module of rank 2 spanned by $\mathbf{1}$ and X with

$$\deg(\mathbf{1}) = 1, \quad \deg(X) = -1 \quad (11)$$

We equip A with a commutative algebra structure with the unit $\mathbf{1}$ and multiplication

$$\mathbf{1}X = X\mathbf{1} = X, \quad X^2 = 0. \quad (12)$$

We denote by ι the unit map $R \rightarrow A$ which sends 1 to $\mathbf{1}$. This map is a graded map of graded R -modules and it increases the degree by 1.

We equip A with a coalgebra structure with a coassociative cocommutative comultiplication

$$\Delta(\mathbf{1}) = \mathbf{1} \otimes X + X \otimes \mathbf{1} + cX \otimes X \quad (13)$$

$$\Delta(X) = X \otimes X \quad (14)$$

and a counit

$$\epsilon(\mathbf{1}) = -c, \quad \epsilon(X) = 1. \quad (15)$$

A , equipped with these structures, is not a Hopf algebra. Instead, the identity

$$\Delta \circ m = (m \otimes \text{Id}) \circ (\text{Id} \otimes \Delta) \quad (16)$$

holds.

Grading \deg , given by (7),(11), induces a grading, also denoted \deg , on tensor powers of A by

$$\deg(a_1 \otimes \cdots \otimes a_n) = \deg(a_1) + \cdots + \deg(a_n) \text{ for } a_1, \dots, a_n \in A \quad (17)$$

Here and further on all tensor products are taken over the ring R unless specified otherwise.

We next describe the effect of the structure maps $\iota, m, \epsilon, \Delta$ on the gradings. We say that a map f between two graded R -modules $V = \bigoplus V_n$ and $W = \bigoplus W_n$ has degree k if $f(x) \in W_{n+k}$ whenever $x \in V_n$.

Proposition 1 *Each of the structure maps $\iota, m, \epsilon, \Delta$ is graded relative to the grading \deg . Namely,*

$$\deg(\iota) = 1, \quad \deg(m) = -1, \quad \deg(\epsilon) = 1, \quad \deg(\Delta) = -1. \quad (18)$$

Proposition 2 *We have an R -module decomposition*

$$A \otimes A = (A \otimes \mathbf{1}) \oplus \Delta(A) \quad (19)$$

which respects the grading \deg .

2.3 Algebra A and (1+1)-dimensional cobordisms

Consider the surfaces $S_2^1, S_1^2, S_0^1, S_1^0, S_2^2$ and S_1^1 , depicted below

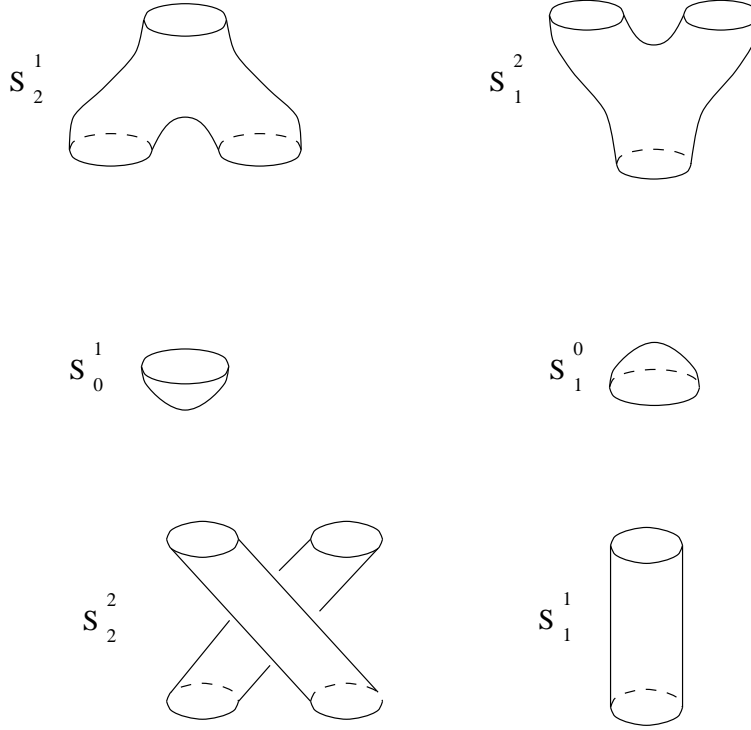

Each of these surfaces S_a^b defines a cobordism from a union of a circles to a union of b circles. We denote by \mathcal{M} the category whose objects are closed one-dimensional manifolds and morphisms are two-dimensional cobordisms between these manifolds generated by the above cobordisms. Specifically, objects of \mathcal{M} are enumerated by nonnegative integers $\text{Ob}(\mathcal{M}) = \{\bar{n} | n \in \mathbb{Z}_+\}$. A morphism between \bar{n} and \bar{m} is a compact oriented surface S with boundary being the union of $n + m$ circles. The boundary circles are split into two sets $\partial_0 S$ and $\partial_1 S$ with $\partial_0 S$ containing n and $\partial_1 S$ containing m circles. An ordering of elements of each of these two sets is fixed. The surface S is presented as a concatenation of disjoint unions of elementary surfaces, depicted above. Morphisms are composed in the usual way by gluing boundary circles. Two morphisms are equal if the surfaces S, T representing these morphisms are diffeomorphic via a diffeomorphism that extends the identification $\partial_0 S \cong \partial_0 T, \partial_1 S \cong \partial_1 T$ of their boundaries. \mathcal{M} is a monoidal category with tensor product of morphisms defined by taking the disjoint union of surfaces.

Let us construct a monoidal functor from \mathcal{M} to the category $R\text{-mod}_0$ of graded R -modules and graded module maps. Assign graded R -module $A^{\otimes n}$ to the object \bar{n} and to the elementary surfaces $S_2^1, S_1^2, S_0^1, S_1^0, S_2^2, S_1^1$ assign morphisms $m, \Delta, \iota, \epsilon, \text{Perm}, \text{Id}$

$$\begin{aligned} F(S_2^1) &= m, & F(S_1^2) &= \Delta, & F(S_0^1) &= \iota, \\ F(S_1^0) &= \epsilon, & F(S_2^2) &= \text{Perm}, & F(S_1^1) &= \text{Id}, \end{aligned} \tag{20}$$

where $\text{Perm} : A \otimes A \rightarrow A \otimes A$ is the permutation map, $\text{Perm}(u \otimes v) = v \otimes u$, and Id is the identity map $\text{Id} : A \rightarrow A$.

To check that F is well-defined one must verify that for any two ways to glue an arbitrary surface S in $\text{Mor}(\mathcal{M})$ from copies of these six elementary surfaces, the two maps of R -modules, defined by these two decompositions of S , coincide. This follows from the commutative algebra and cocommutative coalgebra axioms of A and the identity (16).

Remark: Suppose that a surface $S \in \mathcal{M}$ contains a punctured genus two surface as a subsurface. Then $F(S)$ is the zero map. Indeed, we only need to check this when S has genus two and one boundary component. Then that $F(S) = 0$ follows from $m \circ \Delta \circ m \circ \Delta = 0$.

Maps $F(S_2^1), F(S_1^2), F(S_0^1), F(S_1^0), F(S_2^2)$ and $F(S_1^1)$ between tensor powers of A are graded relative to \deg with degrees

$$\begin{aligned} \deg(F(S_2^1)) &= \deg(F(S_1^2)) = -1, \\ \deg(F(S_0^1)) &= \deg(F(S_1^0)) = 1, \\ \deg(F(S_2^2)) &= \deg(F(S_1^1)) = 0 \end{aligned}$$

From this we deduce

Proposition 3 *For a surface $S \in \text{Mor}(\mathcal{M})$, the degree of the map $F(S)$ of graded R -modules is equal to the Euler characteristic of S .*

2.4 Kauffman bracket

In this section we review the Kauffman bracket and its relation to the Jones polynomial following Kauffman [Ka]. Fix an orientation of the 3-space \mathbb{R}^3 . A plane projection D of an oriented link L in \mathbb{R}^3 is called generic if it has no triple intersections, no tangencies and no cusps. In this paper by a plane projection we will mean a generic plane projection. Given a plane projection D , we assign a Laurent polynomial $\langle D \rangle \in \mathbb{Z}[q, q^{-1}]$ to D by the following rules

1. A simple closed loop evaluates to $q + q^{-1}$:

$$\langle \bigcirc \rangle = q + q^{-1}$$

2. Each over and undercrossing is a linear combination of two simple resolutions of this crossing:

$$\langle \times \rangle = \langle \smile \rangle - q \langle \rangle \langle \rangle$$

3. $\langle D_1 \sqcup D_2 \rangle = \langle D_1 \rangle \langle D_2 \rangle$ where $\langle D_1 \sqcup D_2 \rangle$ stands for the disjoint union of the diagrams D_1 and D_2 .

From these rules we deduce that

$$\langle \bigcirc \rangle = -q^2 \langle \cap \rangle, \quad \langle \bigcirc \rangle = q^{-1} \langle \cap \rangle$$

$$\langle \times \rangle = -q \langle \parallel \rangle$$

$$\langle \times \rangle = \langle \times \rangle$$

Curves of the diagram D inherit orientations from that of L . Let $x(D)$ be the number of double points in the diagram D that look like

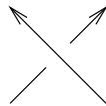

and $y(D)$ the number of double points that look like

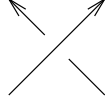

Then the quantity

$$K(D) = (-1)^{x(D)} q^{y(D)-2x(D)} \langle D \rangle \quad (21)$$

does not depend on the choice of a diagram D of the oriented link L and is an invariant of L . We denote this invariant by $K(L)$. Up to a simple normalization, $K(L)$ is the Kauffman bracket of link L and equal to the Jones polynomial of L . The Kauffman bracket, $f[L]$, as defined in [Ka], is a Laurent polynomial in an indeterminate A (this A has no relation to the algebra A in Section 2.2 of this paper). One easily sees that setting our q to $-A^{-2}$ and dividing by $(-A^2 - A^{-2})$ we get $f[L]$:

$$K(L)_{(q=-A^{-2})} = (-A^2 - A^{-2})f[L] \quad (22)$$

In this paper we will call $K(L)$ *the scaled Kauffman bracket*.

Let L_1, L_2 and L_3 be three oriented links that differ as shown below.

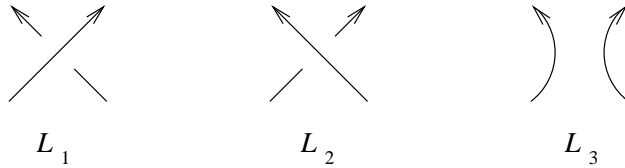

The rules for computing the Kauffman bracket imply

$$q^{-2}K(L_1) - q^2K(L_2) = (q^{-1} - q)K(L_3) \quad (23)$$

Moreover, $K(L) = q + q^{-1}$ if L is the unknot.

The Jones polynomial $V(L)$ of an oriented link L is determined by two properties:

1. The Jones polynomial of the unknot is 1.
2. For oriented links L_1, L_2, L_3 as above

$$t^{-1}V(L_1) - tV(L_2) = (\sqrt{t} - \frac{1}{\sqrt{t}})V(L_3) \quad (24)$$

Therefore, the scaled Kauffman bracket and the Jones polynomial are related by

$$V(L)_{\sqrt{t}=-q} = \frac{K(L)}{q + q^{-1}} \quad (25)$$

3 Cubes

3.1 Complexes of R -modules

Denote by $\text{Kom}(\mathcal{B})$ the category of complexes of an abelian category \mathcal{B} . An object N of $\text{Kom}(\mathcal{B})$ is a collection of objects $N^i \in \mathcal{B}, i \in \mathbb{Z}$ together with morphisms $d^i : N^i \rightarrow N^{i+1}, i \in \mathbb{Z}$ such that $d^{i+1}d^i = 0$. A morphism $f : M \rightarrow N$ of complexes is a collection of morphisms $f^i : M^i \rightarrow N^i$ such that $f^{i+1}d^i = d^i f^i, i \in \mathbb{Z}$. A morphism $f : M \rightarrow N$ is called a quasi-isomorphism if the induced map of the cohomology groups $H^i(f) : H^i(M) \rightarrow H^i(N)$ is an isomorphism for all $i \in \mathbb{Z}$.

For $n \in \mathbb{Z}$ denote by $[n]$ the automorphism of $\text{Kom}(\mathcal{B})$ that is defined on objects by $N[n]^i = N^{i+n}, d[n]^i = (-1)^n d^{i+n}$ and continued to morphisms in the obvious way.

The cone of a morphism $f : M \rightarrow N$ of complexes is a complex $C(f)$ with

$$C(f)^i = M[1]^i \oplus N^i, \quad d_{C(f)}(m^{i+1}, n^i) = (-d_M m^{i+1}, f(m^{i+1}) + d_N n^i). \quad (26)$$

The automorphism $\{n\}$ of shifting the grading down by n , introduced in Section 2.1, can be naturally extended to an automorphism of the category $\text{Kom}(R\text{-mod}_0)$ of complexes of graded R -modules. This automorphism of $\text{Kom}(R\text{-mod}_0)$ will also be denoted $\{n\}$.

To a complex M of graded R -modules we associate a graded R -module $\bigoplus_{i \in \mathbb{Z}} M^i$. Each M^i is a graded R -module, $M^i = \bigoplus_{j \in \mathbb{Z}} M_j^i$ and thus $\bigoplus_{i \in \mathbb{Z}} M^i$ is a bigraded R -module when we extend our usual grading of R to a bigrading with $c \in R$ having degree $(0, 2)$.

From this viewpoint the differential d_M of a complex M is a homogeneous map of degree $(1, 0)$ of bigraded R -modules.

3.2 Commutative cubes

Let \mathcal{I} be a finite set. Denote by $|\mathcal{I}|$ the cardinality of \mathcal{I} and by $r(\mathcal{I})$ the set of all pairs (\mathcal{L}, a) where \mathcal{L} is a subset of \mathcal{I} and a an element of \mathcal{I} that does not belong to \mathcal{L} . To simplify notation we will often

- (a) denote a one-element set $\{a\}$ by a ,
- (b) denote a finite set $\{a, b, \dots, d\}$ by $ab \dots d$,
- (c) denote the disjoint union $\mathcal{L}_1 \sqcup \mathcal{L}_2$ of two sets $\mathcal{L}_1, \mathcal{L}_2$ by $\mathcal{L}_1 \mathcal{L}_2$, in particular, we denote by $\mathcal{L}a$ the disjoint union of a set \mathcal{L} and a one-element set $\{a\}$, similarly, $\mathcal{L}ab$ means $\mathcal{L} \sqcup \{a\} \sqcup \{b\}$, etc.

Definition 1 Let \mathcal{I} be a finite set and \mathcal{B} a category. A commutative \mathcal{I} -cube V over \mathcal{B} is a collection of objects $V(\mathcal{L}) \in \text{Ob}(\mathcal{B})$ for each subset \mathcal{L} of \mathcal{I} , morphisms

$$\xi_a^V(\mathcal{L}) : V(\mathcal{L}) \longrightarrow V(\mathcal{L}a) \quad (27)$$

for each $(\mathcal{L}, a) \in r(\mathcal{I})$, such that for each triple (\mathcal{L}, a, b) , where \mathcal{L} is a subset of \mathcal{I} and $a, b, a \neq b$ are two elements of \mathcal{I} that do not lie in \mathcal{L} , there is an equality of morphisms

$$\xi_b^V(\mathcal{L}a)\xi_a^V(\mathcal{L}) = \xi_a^V(\mathcal{L}b)\xi_b^V(\mathcal{L}), \quad (28)$$

i.e., the following diagram is commutative

$$\begin{array}{ccc} V(\mathcal{L}) & \xrightarrow{\xi_a^V(\mathcal{L})} & V(\mathcal{L}a) \\ \downarrow \xi_b^V(\mathcal{L}) & & \downarrow \xi_b^V(\mathcal{L}a) \\ V(\mathcal{L}b) & \xrightarrow{\xi_a^V(\mathcal{L}b)} & V(\mathcal{L}ab) \end{array}$$

We will call a commutative \mathcal{I} -cube an \mathcal{I} -cube or, sometimes, a *cube* when it is clear what \mathcal{I} is. Maps ξ_a^V are called the structure maps of V .

Example If \mathcal{I} is the empty set, an \mathcal{I} -cube is an object in \mathcal{B} . If \mathcal{I} consists of one element, an \mathcal{I} -cube is a morphism in \mathcal{B} . If \mathcal{I} consists of two elements, $\mathcal{I} = \{a, b\}$, an \mathcal{I} -cube is a commutative square of objects and morphisms in \mathcal{B} :

$$\begin{array}{ccc} V(\emptyset) & \longrightarrow & V(a) \\ \downarrow & & \downarrow \\ V(b) & \longrightarrow & V(ab) \end{array}$$

In general, an \mathcal{I} -cube can be visualized in the following manner. Let n be the cardinality of \mathcal{I} . We take an n -dimensional cube in standard position in the Euclidean n -dimensional space, i.e. each vertex has coordinates (a_1, \dots, a_n) where $a_i \in \{0, 1\}$ and orient each edge in the direction of the vertex with the bigger sum of the coordinates. Then the edges of any 2-dimensional facet of this cube are oriented as shown on the diagram below.

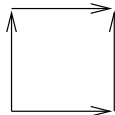

Choose a bijection between elements of \mathcal{I} and coordinates of \mathbb{R}^n . This bijection defines a bijection between vertices of the n -cube and subsets of \mathcal{I} , with the $(0, \dots, 0)$ vertex associated to the empty set. Oriented edges of the n -cube correspond to pairs $(\mathcal{L}, a) \in r(\mathcal{I})$.

Given an \mathcal{I} -cube V , put object $V(\mathcal{L})$ into the vertex associated to the set \mathcal{L} and assign morphism $\xi_a^V(\mathcal{L})$ to the arrow going from the vertex associated to \mathcal{L} to the vertex associated to $\mathcal{L}a$. Equation (28) is equivalent to the commutativity of diagrams in all 2-dimensional faces of the n -cube.

Given two \mathcal{I} -cubes V, W over a category \mathcal{B} , an \mathcal{I} -cube map $\psi : V \rightarrow W$ is a collection of maps

$$\psi(\mathcal{L}) : V(\mathcal{L}) \rightarrow W(\mathcal{L}), \quad \text{for all } \mathcal{L} \subset \mathcal{I}$$

that make diagrams

$$\begin{array}{ccc} V(\mathcal{L}) & \xrightarrow{\psi(\mathcal{L})} & W(\mathcal{L}) \\ \downarrow \xi_a^V(\mathcal{L}) & & \downarrow \xi_a^W(\mathcal{L}) \\ V(\mathcal{L}a) & \xrightarrow{\psi(\mathcal{L}a)} & W(\mathcal{L}a) \end{array} \quad (29)$$

commutative for all $(\mathcal{L}, a) \in r(\mathcal{I})$. The map ψ is called an isomorphism if $\psi(\mathcal{L})$ is an isomorphism for all $\mathcal{L} \subset \mathcal{I}$. The map ψ of \mathcal{I} -cubes over an abelian category \mathcal{B} is called injective/surjective if $\psi(\mathcal{L})$ is injective/surjective for all $\mathcal{L} \subset \mathcal{I}$.

The class of \mathcal{I} -cubes over an abelian category \mathcal{B} and maps between \mathcal{I} -cubes constitute an abelian category in the obvious way. In particular, direct sums of \mathcal{I} -cubes are defined.

For a finite set \mathcal{I} and $a \in \mathcal{I}$, let \mathcal{J} be the complement, $\mathcal{I} = \mathcal{J} \sqcup \{a\}$. Given an \mathcal{I} -cube V , let $V_a(*0), V_a(*1)$ be \mathcal{J} -cubes defined as follows:

$$V_a(*0)(\mathcal{L}) = V(\mathcal{L}), \quad V_a(*1)(\mathcal{L}) = V(\mathcal{L}a), \quad \text{for } \mathcal{L} \subset \mathcal{J} \quad (30)$$

and the structure maps of $V_a(*0), V_a(*1)$ are determined by the structure maps $\xi_b^V, b \in \mathcal{I}_1$ of V in the obvious fashion. Sometimes we will write $V(*0)$ for $V_a(*0)$, etc. The structure map ξ_a^V of V defines an \mathcal{I}_1 -cube map $\xi_a^V : V_a(*0) \rightarrow V_a(*1)$. This provides a one-to-one correspondence between \mathcal{I} -cubes and maps of \mathcal{I}_1 -cubes.

We say that a map $\psi : V \rightarrow W$ of \mathcal{I} -cubes over the category $R\text{-mod}$ of graded R -modules and graded maps is graded of degree i if the map $\psi(\mathcal{L}) : V(\mathcal{L}) \rightarrow W(\mathcal{L})$ has degree i for all $\mathcal{L} \subset \mathcal{I}$.

For a cube V over $R\text{-mod}_0$ denote by $V\{i\}$ the cube V with the grading shifted by i :

$$V\{i\}(\mathcal{L}) = V(\mathcal{L})\{i\} \text{ for all } \mathcal{L} \subset \mathcal{I} \quad (31)$$

and the structure maps being appropriate shifts of the structure maps of V . A degree i map $\psi : V \rightarrow W$ of \mathcal{I} -cubes over $R\text{-mod}_0$ induces a grading-preserving map $V \rightarrow W\{i\}$, also denoted ψ .

3.3 skew-commutative cubes

We next define skew-commutative \mathcal{I} -cubes over an additive category \mathcal{B} . A skew-commutative \mathcal{I} -cube is almost the same as a commutative \mathcal{I} -cube but now we require that for every square facet of the cube the associated diagram of objects and morphisms of \mathcal{B} anticommutes.

Definition 2 *Let \mathcal{I} be a finite set and \mathcal{B} an additive category. A skew-commutative \mathcal{I} -cube V over \mathcal{B} is a collection of objects $V(\mathcal{L}) \in \text{Ob}(\mathcal{B})$ for $\mathcal{L} \subset \mathcal{I}$ and morphisms*

$$\xi_a^V(\mathcal{L}) : V(\mathcal{L}) \rightarrow V(\mathcal{L}a).$$

such that for each triple (\mathcal{L}, a, b) , where \mathcal{L} is a subset of \mathcal{I} and $a, b, a \neq b$ are two elements of \mathcal{I} that do not lie in \mathcal{L} , there is an equality

$$\xi_b^V(\mathcal{L}a)\xi_a^V(\mathcal{L}) + \xi_a^V(\mathcal{L}b)\xi_b^V(\mathcal{L}) = 0.$$

We will call a skew-commutative \mathcal{I} -cube over \mathcal{B} a *skew \mathcal{I} -cube* or, without specifying \mathcal{I} , a *skew cube*.

Given \mathcal{I} -cubes or skew \mathcal{I} -cubes V and W over $R\text{-mod}_0$, their tensor product is defined to be an \mathcal{I} -cube (if V and W are both cubes or both skew cubes) or a skew \mathcal{I} -cube (if one of V, W is a cube and the other is a skew cube), denoted $V \otimes W$, given by

$$\begin{aligned} (V \otimes W)(\mathcal{L}) &= V(\mathcal{L}) \otimes W(\mathcal{L}), & \mathcal{L} \subset \mathcal{I}, \\ \xi_a^{V \otimes W}(\mathcal{L}) &= \xi_a^V(\mathcal{L}) \otimes \xi_a^W(\mathcal{L}), & (\mathcal{L}, a) \in r(\mathcal{I}), \end{aligned}$$

where, recall, the tensor products are taken over R .

For a finite set \mathcal{L} denote by $o(\mathcal{L})$ the set of complete orderings or elements of \mathcal{L} . For $x, y \in o(\mathcal{L})$ let $p(x, y)$ be the parity function, $p(x, y) = 0$ if y can be obtained by from x via an even number of transpositions of two neighboring elements in the ordering, otherwise, $p(x, y) = 1$. To a finite set \mathcal{L} associate a graded R -module $E(\mathcal{L})$ defined as the quotient of the graded R -module, freely generated by elements x for all $x \in o(\mathcal{L})$, by relations $x = (-1)^{p(x, y)}y$ for all pairs $x, y \in o(\mathcal{L})$. Module $E(\mathcal{L})$ is a free graded R -module of rank 1. For $a \notin \mathcal{L}$ there is a canonical isomorphism of graded R -modules $E(\mathcal{L}) \rightarrow E(\mathcal{L}a)$ induced by the map $o(\mathcal{L}) \rightarrow o(\mathcal{L}a)$ that takes $x \in o(\mathcal{L})$ to $xa \in o(\mathcal{L}a)$. Moreover, for $a, b, a \neq b$, the diagram below anticommutes

$$\begin{array}{ccc} E(\mathcal{L}) & \longrightarrow & E(\mathcal{L}a) \\ \downarrow & & \downarrow \\ E(\mathcal{L}b) & \longrightarrow & E(\mathcal{L}ab) \end{array} \quad (32)$$

Denote by $E_{\mathcal{I}}$ the skew \mathcal{I} -cube with $E_{\mathcal{I}}(\mathcal{L}) = E(\mathcal{L})$ for $\mathcal{L} \subset \mathcal{I}$ and the structure map $E_{\mathcal{I}}(\mathcal{L}) \rightarrow E_{\mathcal{I}}(\mathcal{L}a)$ being canonical isomorphism $E(\mathcal{L}) \rightarrow E(\mathcal{L}a)$.

We will use $E_{\mathcal{I}}$ to pass from \mathcal{I} -cubes over $R\text{-mod}_0$ to skew \mathcal{I} -cubes over $R\text{-mod}_0$ by tensoring an \mathcal{I} -cube with $E_{\mathcal{I}}$.

3.4 skew-commutative cubes and complexes

Let V be a skew \mathcal{I} -cube over an abelian category \mathcal{B} . To V we associate a complex $\overline{\mathcal{C}}(V) = (\overline{\mathcal{C}}^i(V), d^i), i \in \mathbb{Z}$ of objects of \mathcal{B} by

$$\overline{\mathcal{C}}^i(V) = \bigoplus_{\mathcal{L} \subset \mathcal{I}, |\mathcal{L}|=i} V(\mathcal{L}) \quad (33)$$

The differential $d^i : \overline{\mathcal{C}}^i(V) \rightarrow \overline{\mathcal{C}}^{i+1}(V)$ is given on an element $x \in V(\mathcal{L}), |\mathcal{L}| = i$ by

$$d^i(x) = \sum_{a \in \mathcal{I} \setminus \mathcal{L}} \xi_a^V(\mathcal{L})x. \quad (34)$$

Examples:

1. If $|\mathcal{I}| = 1, \mathcal{I} = \{a\}$,

$$\overline{\mathcal{C}}^i(V) = \begin{cases} V(\emptyset) & \text{if } i = 0 \\ V(a) & \text{if } i = 1 \\ 0 & \text{otherwise} \end{cases}$$

The differential $d^0 = \xi_a^V(\emptyset)$ and $d^i = 0$ if $i \neq 0$, so $\overline{\mathcal{C}}(V)$ is the complex

$$\dots \longrightarrow 0 \longrightarrow V(\emptyset) \xrightarrow{\xi_a^V(\emptyset)} V(\mathcal{I}) \longrightarrow 0 \longrightarrow \dots \quad (35)$$

2. If \mathcal{I} contains two elements, say, $\mathcal{I} = \{a, b\}$, then

$$\overline{\mathcal{C}}^i(V) = \begin{cases} V(\emptyset) & \text{if } i = 0 \\ V(a) \oplus V(b) & \text{if } i = 1 \\ V(ab) & \text{if } i = 2 \\ 0 & \text{otherwise} \end{cases}$$

and differentials

$$\begin{aligned}
d^0 &: V(\emptyset) \longrightarrow V(a) \oplus V(b) \\
d^0 &= \xi_b^V(\emptyset) + \xi_a^V(\emptyset) \\
d^1 &: V(b) \oplus V(a) \longrightarrow V(ab) \\
d^1 &= (\xi_a^V(b), \xi_b^V(a))
\end{aligned}$$

Proposition 4 *Let V be a skew \mathcal{I} -cube over an abelian category \mathcal{B} and suppose that for some $a \in \mathcal{I}$ and any $\mathcal{L} \subset \mathcal{I} \setminus \{a\}$ the map $\xi_a^V : V(\mathcal{L}) \rightarrow V(\mathcal{L}a)$ is an isomorphism. Then the complex $\overline{\mathcal{C}}(V)$ is acyclic.*

Proof: The complex $\overline{\mathcal{C}}(V)$ is isomorphic to the cone of the identity map of the complex $\overline{\mathcal{C}}(V_a(*1))[-1]$ and, therefore, acyclic. \square

Every map of \mathcal{I} -cubes $\phi : V \longrightarrow W$ over $R\text{-mod}_0$ induces a map of complexes

$$\overline{\mathcal{C}}(\phi) : \overline{\mathcal{C}}(V \otimes E_{\mathcal{I}}) \longrightarrow \overline{\mathcal{C}}(W \otimes E_{\mathcal{I}}). \quad (36)$$

If ϕ is an isomorphism of commutative cubes, $\overline{\mathcal{C}}(\phi)$ is an isomorphism of complexes.

Proposition 5 *Let V be an \mathcal{I} -cube over $R\text{-mod}_0$ and suppose that for some $a \in \mathcal{I}$ the structure map*

$$\xi_a^V : V_a(*0) \longrightarrow V_a(*1) \quad (37)$$

is an isomorphism. Then the complex $\overline{\mathcal{C}}(V \otimes E_{\mathcal{I}})$ is acyclic.

Proof: Immediate from Proposition 4. \square

The following proposition and its corollary are obvious.

Proposition 6 *We have a canonical splitting of complexes*

$$\overline{\mathcal{C}}(V \oplus W) = \overline{\mathcal{C}}(V) \oplus \overline{\mathcal{C}}(W) \quad (38)$$

where V and W are skew-commutative \mathcal{I} -cubes over an abelian category and $V \oplus W$ is the direct sum of V and W .

Corollary 1 *We have a canonical splitting of complexes*

$$\overline{\mathcal{C}}((V \oplus W) \otimes E_{\mathcal{I}}) = \overline{\mathcal{C}}(V \otimes E_{\mathcal{I}}) \oplus \overline{\mathcal{C}}(W \otimes E_{\mathcal{I}}) \quad (39)$$

where V and W are \mathcal{I} -cubes over $R\text{-mod}_0$.

4 Diagrams

4.1 Reidemeister moves

Given a link L in \mathbb{R}^3 we can take its generic projection on the plane. A generic projection is the one without triple points and double tangencies. An isotopy class of such projections is called a *plane diagram* of L , or, simply, a *diagram*. The following four types of transformations of plane diagrams preserve the isotopy type of the associated link.

I. Addition/removal of a left-twisted curl:



II. Addition/removal of a right-twisted curl:

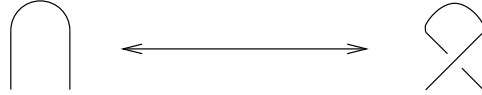

III. Tangency move:



IV. Triple point move:



Proposition 7 *If plane diagrams D_1 and D_2 represent isotopic oriented links, these diagrams can be connected by a chain of moves I-IV.*

□

4.2 Constructing cubes and complexes from plane diagrams

Fix a plane diagram D with n double points of an oriented link L . Denote by \mathcal{I} the set of double points of D . To D we will associate an \mathcal{I} -cube V_D over the category $R\text{-mod}_0$ of graded R -modules. This cube will not depend on the orientation of components of L .

Given a double point of a diagram D , it can be resolved in two possible ways:

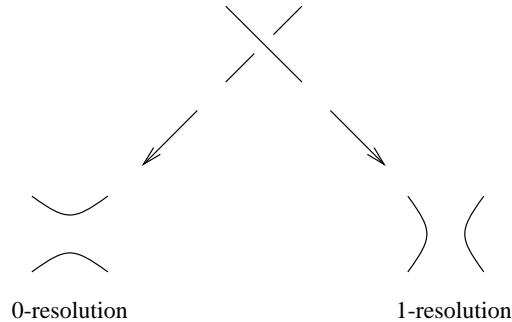

Let us call the resolution on the left the 0-resolution, and the one on the right the 1-resolution. A *resolution* of D is a resolution of each double point of D . Thus, D admits 2^n resolutions. There is a one-to-one correspondence between resolutions of D and subsets \mathcal{L} of the set \mathcal{I} of double points. Namely, to $\mathcal{L} \subset \mathcal{I}$ we associate a resolution, denoted $D(\mathcal{L})$, by taking 1-resolution of each double point that belongs to \mathcal{L} and 0-resolution if the double point does not lie in \mathcal{L} .

A resolution of a diagram D is always a collection of simple disjoint curves on the plane and is thus a 1-manifold embedded in the plane. Now the functor F from $(1+1)$ cobordisms to R -modules (see Section 2.3) comes into play. To a union of k circles it assigns the k -th tensor power of A . The functor F , applied to the diagram $D(\mathcal{L})$, considered as a one-dimensional manifold, produces a graded R -module $A^{\otimes k}$ where k is the

number of components of $D(\mathcal{L})$. We raise the grading of $A^{\otimes k}$ by $|\mathcal{L}|$, the cardinality of \mathcal{L} , and assign the R -module $F(D(a))\{-|\mathcal{L}|\}$ to the vertex $V_D(\mathcal{L})$ of the cube V_D :

$$V_D(\mathcal{L}) = F(D(\mathcal{L}))\{-|\mathcal{L}|\} \quad (40)$$

(Recall from Section 3.1 that the automorphism $\{1\}$ of the category $R\text{-mod}_0$ lowers the grading by 1.) Let us now define maps between vertices of V_D . Choose $(\mathcal{L}, a) \in r(\mathcal{I})$. We want to have a map

$$\xi_a^{V_D}(\mathcal{L}) : V_D(\mathcal{L}) \longrightarrow V_D(\mathcal{L}a). \quad (41)$$

The diagrams $D(\mathcal{L})$ and $D(\mathcal{L}a)$ differ only in the neighborhood of the double point a of D , as an example below (for $n = 1$, so that D has one double point, $\mathcal{I} = \{a\}$) demonstrates (D is the leftmost diagram, $D(\emptyset)$ is the diagram in the center and $D(a)$ is depicted on the right):

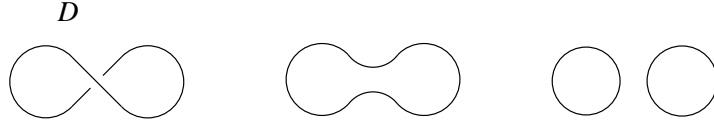

Take the direct product of the plane \mathbb{R}^2 and the interval $[0, 1]$. We identify the diagram $D(\mathcal{L})$ (resp. $D(\mathcal{L}a)$) with a one-dimensional submanifold of $\mathbb{R}^2 \times \{0\}$ (resp $\mathbb{R}^2 \times \{1\}$.) We can choose a small neighbourhood U of a such that $D(\mathcal{L})$ and $D(\mathcal{L}a)$ coincide outside U and inside they look as follows:

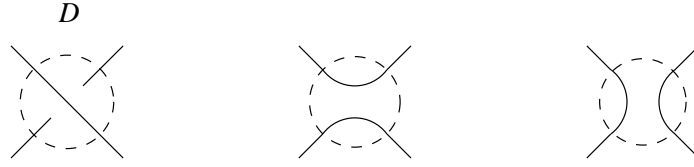

The boundary of U is depicted by a dashed circle, the central picture shows the intersection of $D(\mathcal{L})$ and U , the rightmost picture shows the intersection of $D(\mathcal{L}a)$ and U . Let S be a surface properly embedded in $\mathbb{R}^2 \times [0, 1]$ such that

1. The boundary of S is the union of the diagrams $D(\mathcal{L})$ and $D(\mathcal{L}a)$.
2. Outside of $U \times [0, 1]$ surface S is the direct product of $D(\mathcal{L}) \cap (\mathbb{R}^2 \setminus U)$ and the interval $[0, 1]$.
3. The connected component of S that has a nonempty intersection with $U \times [0, 1]$ is homeomorphic to the two-sphere with three holes.
4. The projection $S \longrightarrow [0, 1]$ onto the second component of the product $\mathbb{R}^2 \times [0, 1]$ has only one critical point – the saddle point that lies inside $U \times [0, 1]$.

Example: Let D be a diagram with two double points, $\mathcal{I} = \{a, b\}$, diagram $D(a)$, respectively $D(ab)$, consists of 2, respectively 3 simple curves:

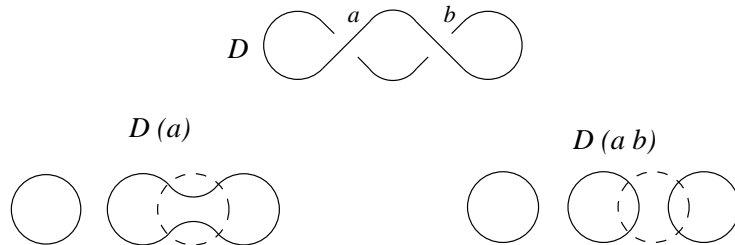

The boundary of the neighbourhood U of the double point a is depicted by the dashed circle on the diagram above. Then the surface S looks like

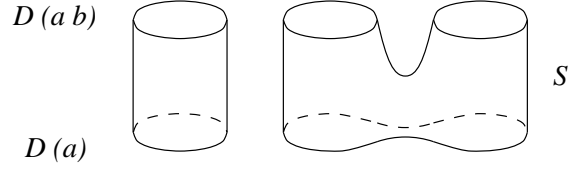

Recall that earlier we defined $V_D(\mathcal{L})$ to be $F(D(\mathcal{L}))$ for $\mathcal{L} \subset \mathcal{I}$, with the degree raised by $|\mathcal{L}|$. Now define the map

$$\xi_a^{V_D}(\mathcal{L}) : V_D(\mathcal{L}) \longrightarrow V_D(\mathcal{L}a)$$

to be given by

$$F(S) : F(D(\mathcal{L})) \longrightarrow F(D(\mathcal{L}a)).$$

Note that the degree of $F(S)$ is equal to -1 , the Euler characteristic of the surface S (Proposition 3). But $|\mathcal{L}a| = |\mathcal{L}| + 1$, so, with degrees shifted:

$$V_D(\mathcal{L}) = F(D(\mathcal{L}))\{-|\mathcal{L}|\} \tag{42}$$

$$V_D(\mathcal{L}a) = F(D(\mathcal{L}a))\{-|\mathcal{L}| - 1\} \tag{43}$$

and the map $\xi_a^{V_D}(\mathcal{L})$ is a grading-preserving map of graded R -modules.

Proposition 8 V_D , defined in this way, is an \mathcal{I} -cube over the category $R\text{-mod}_0$ of graded R -modules and grading-preserving maps.

The proof consists of verifying commutativity relations (28) for maps $\xi_a^{V_D}(\mathcal{L})$. They follow immediately from the functoriality of F .

□

Example: Let D be the diagram

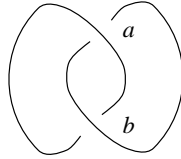

The four resolutions of this diagram are given below

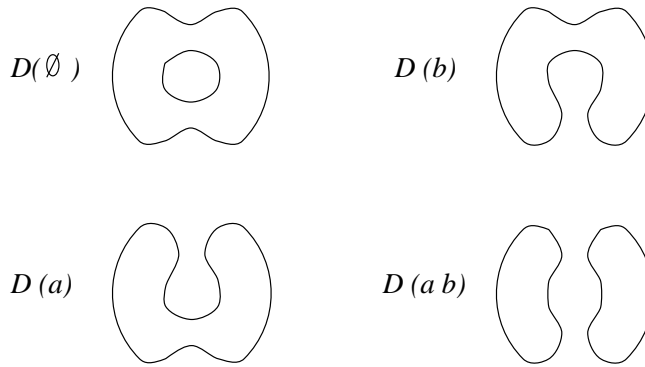

Applying the functor F , we get

$$\begin{aligned} F(D(\emptyset)) &= A^{\otimes 2}, & F(D(a)) &= A, \\ F(D(b)) &= A, & F(D(ab)) &= A^{\otimes 2}. \end{aligned}$$

The cube V_D has the form

$$\begin{array}{ccc} A^{\otimes 2} & \xrightarrow{m} & A\{-1\} \\ \downarrow m & & \downarrow \Delta \\ A\{-1\} & \xrightarrow{\Delta} & A^{\otimes 2}\{-2\} \end{array}$$

□

Let us now go back to our construction. So far, to a plane diagram D with the set \mathcal{I} of double points we associated a \mathcal{I} -cube V_D over the category $R\text{-mod}_0$ of graded R -modules. We would like to build a complex of graded R -modules out of V_D . We know how to build a complex from a skew-commutative \mathcal{I} -cube (see Section 3.4). To make a skew-commutative \mathcal{I} -cube out of an \mathcal{I} -cube V_D we put minus sign in front of some structure maps ξ^{V_D} of V_D so that for any commutative square of V_D an odd number out of the four maps constituting the square change signs. A more intrinsic way to do this is to tensor V_D with the skew-commutative \mathcal{I} -cube $E_{\mathcal{I}}$, defined at the end of Section 3.3.

To the skew-commutative \mathcal{I} -cube $V_D \otimes E_{\mathcal{I}}$ there is associated the complex $\overline{C}(V_D \otimes E_{\mathcal{I}})$ of graded R -modules (see Section 3.4). Denote this complex by $\overline{C}(D)$:

$$\overline{C}(D) \stackrel{\text{def}}{=} \overline{C}(V_D \otimes E_{\mathcal{I}}) \quad (44)$$

Thus, $\overline{C}(D)$ is a complex of graded R -modules and grading-preserving homomorphisms. It does not depend on the orientations of the components of the link L .

Recall (Section 3.1) that the category $\text{Kom}(R\text{-mod}_0)$ has two commuting automorphisms: $[1]$, which shifts a complex one term to the left; and $\{1\}$, which lowers the grading of each component of the complex by 1.

To the diagram D of link L we associated (Section 2.4) two numbers, $x(D)$ and $y(D)$. Define a complex $C(D)$ by

$$C(D) = \overline{C}(D)[x(D)]\{2x(D) - y(D)\} \quad (45)$$

Define $H^i(D)$ as the i -th cohomology group of $C(D)$. It is a finitely-generated graded R -module.

Theorem 1 *If D is a plane diagram of an oriented link L , then for each $i \in \mathbb{Z}$, the isomorphism class of the graded R -modules $H^i(D)$ is an invariant of L .*

The proof of this theorem occupies Section 5, together with some preliminary material contained in Section 4.3.

Define $H^{i,j}(D)$ as the i -th cohomology group of the degree j subcomplex of $C(D)$. Thus, $H^{i,j}(D)$ is the graded component of $H^i(D)$ of degree j and we have a decomposition of abelian groups

$$H^i(D) = \bigoplus_{j \in \mathbb{Z}} H^{i,j}(D). \quad (46)$$

We denote by $H^i(L)$ the isomorphism class of $H^i(D)$ in the category of graded R -modules. For an oriented link L only finitely many of $H^i(L)$ are non-zero as i varies over all integers.

Corollary 2 *If D a plane diagram of an oriented link L , then for each $i, j \in \mathbb{Z}$, the isomorphism class of the abelian group $H^{i,j}(D)$ is an invariant of L .*

We next show that the Kauffman bracket is equal to a suitable Euler characteristic of these cohomology groups.

Proposition 9 *For an oriented link L ,*

$$K(L) = (1 - q^2) \sum_{i \in \mathbb{Z}} (-1)^i \widehat{\chi}(H^i(D)) \quad (47)$$

where $K(L)$ is the scaled Kauffman bracket, defined in Section 2.4, $\widehat{\chi}$ is the Euler characteristic (see Section 2.1) and D is any diagram of L .

Proof: First notice that $\widehat{\chi}(M\{n\}) = q^{-n}\widehat{\chi}(M)$ for a finitely-generated graded R -module M . Given a bounded complex

$$M : \quad \dots \rightarrow M^i \rightarrow M^{i+1} \rightarrow \dots \quad (48)$$

of finitely-generated graded R -modules, define

$$\widehat{\chi}(M) = \sum_{i \in \mathbb{Z}} (-1)^i \widehat{\chi}(M^i) \quad (49)$$

Since

$$\widehat{\chi}(C(D)) = \sum_{i \in \mathbb{Z}} (-1)^i \widehat{\chi}(H^i(D)), \quad (50)$$

it is enough to prove

$$K(L) = (1 - q^2)\widehat{\chi}(C(D)) \quad (51)$$

For three diagrams D_1, D_2 and D_3 that differ as shown below

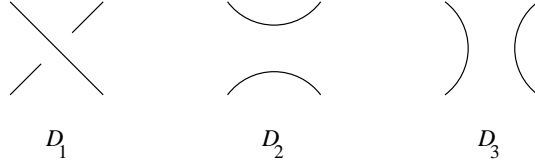

the complex $\overline{C}(D_1)[1]$ is isomorphic, up to a shift, to the cone of a map of complexes $\overline{C}(D_2) \rightarrow \overline{C}(D_3)\{-1\}$. Therefore,

$$\widehat{\chi}(\overline{C}(D_1)) = \widehat{\chi}(\overline{C}(D_2)) - \widehat{\chi}(\overline{C}(D_3)\{-1\}) = \widehat{\chi}(\overline{C}(D_2)) - q\widehat{\chi}(\overline{C}(D_3)) \quad (52)$$

On the other hand, for diagrams D_1, D_2, D_3 as above, we have

$$\langle D_1 \rangle = \langle D_2 \rangle - q \langle D_3 \rangle \quad (53)$$

(see Section 2.4, where $\langle D \rangle$ is defined). If the diagram D is a disjoint union of k simple plane curves then

$$\widehat{\chi}(\overline{C}(D)) = \widehat{\chi}(A^{\otimes k}) = (q + q^{-1})^k \widehat{\chi}(R) = \frac{(q + q^{-1})^k}{1 - q^2} \quad (54)$$

and $\langle D \rangle = (q + q^{-1})^k$. Therefore, for any diagram D

$$\langle D \rangle = (1 - q^2)\widehat{\chi}(\overline{C}(D)). \quad (55)$$

Since

$$\widehat{\chi}(C(D)) = \widehat{\chi}(\overline{C}(D))[x(D)]\{2x(D) - y(D)\} = (-1)^{x(D)} q^{y(D) - 2x(D)} \widehat{\chi}(\overline{C}(D)), \quad (56)$$

and in view of (21), proposition follows. \square

4.3 Surfaces and cube morphisms

Let U be a closed disk in the plane \mathbb{R}^2 and \dot{U} the interior of U so that $U = \partial U \cup \dot{U}$. Let T' be a tangle in $(\mathbb{R}^2 \setminus \dot{U}) \times [0, 1]$ with m points (where m is even) on the boundary $\partial U \times [0, 1]$ and T a generic projection of T' on $\mathbb{R}^2 \setminus \dot{U}$. The intersection of T with ∂U consists of m points. Denote them by p_1, \dots, p_m (see an example on the diagram below, ∂U is shown by a dashed circle).

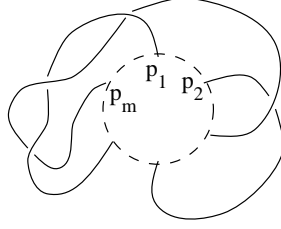

Let \mathcal{I} be the set of double points of T . Pick two systems Q_0 and Q_1 of $\frac{m}{2}$ simple disjoint arcs in U with ends in points p_1, \dots, p_m :



Then $Q_0 \cup T$ and $Q_1 \cup T$ (here and further on we denote them by P_0 and P_1 respectively) can be considered as two plane diagrams of links in \mathbb{R}^3 :



To P_0 and P_1 there are associated \mathcal{I} -cubes V_{P_0} and V_{P_1} .

Let S be a compact oriented surface in $U \times [0, 1]$ such that the boundary of S is the union of $Q_0 \times \{0\}$, $Q_1 \times \{1\}$ and $(p_1 \cup \dots \cup p_m) \times [0, 1]$. To S we associate an \mathcal{I} -cube map

$$\psi_S : V_{P_0} \longrightarrow V_{P_1}$$

as follows. For each $\mathcal{L} \subset \mathcal{I}$ we must construct a map

$$\psi_{S, \mathcal{L}} : V_{P_0}(\mathcal{L})\{-|\mathcal{L}|\} \longrightarrow V_{P_1}(\mathcal{L})\{-|\mathcal{L}|\} \quad (57)$$

and check the commutativity of diagrams (29).

To \mathcal{L} there is associated a resolution $T(\mathcal{L})$ of double points of T . Thus $T(\mathcal{L})$ is a collection of simple closed curves and arcs in $\mathbb{R}^2 \setminus \dot{U}$ with ends in p_1, \dots, p_m . Then (by (40))

$$V_{P_0}(\mathcal{L}) = F(T(\mathcal{L}) \cup Q_0)\{-|\mathcal{L}|\} \quad (58)$$

$$V_{P_1}(\mathcal{L}) = F(T(\mathcal{L}) \cup Q_1)\{-|\mathcal{L}|\} \quad (59)$$

where F is the functor described in Section 2.3 ($T(\mathcal{L}) \cup Q_0$ and $T(\mathcal{L}) \cup Q_1$ are collections of simple closed curves on the plane, so that we can apply functor F to them).

Let S' be a surface in $\mathbb{R}^2 \times [0, 1]$ which is S inside $U \times [0, 1]$ and $T(\mathcal{L}) \times [0, 1]$ outside $U \times [0, 1]$. Map $F(S')$

$$F(S') : F(T(\mathcal{L}) \cup Q_0) \longrightarrow F(T(\mathcal{L}) \cup Q_1) \quad (60)$$

is a graded map of R -modules of degree $\chi(S') = \chi(S) - \frac{m}{2}$. Define $\psi_{S, \mathcal{L}}$ as this map, shifted by $|\mathcal{L}|$:

$$\psi_{S, \mathcal{L}} = F(S')\{-|\mathcal{L}|\} : V_{P_0}(\mathcal{L})\{-|\mathcal{L}|\} \longrightarrow V_{P_1}(\mathcal{L})\{-|\mathcal{L}|\} \quad (61)$$

The commutativity condition (29) is immediate. We sum up our result as

Proposition 10 *The map*

$$\psi_S : V_{P_0} \longrightarrow V_{P_1} \tag{62}$$

is a degree $\chi(S) - \frac{m}{2}$ map of \mathcal{I} -cubes.

Everything in this section extends to the case when the diagrams Q_0 and Q_1 are allowed to have simple closed circles in addition to $\frac{m}{2}$ simple disjoint arcs joining points p_1, \dots, p_m . For instance, Q_0 may look like

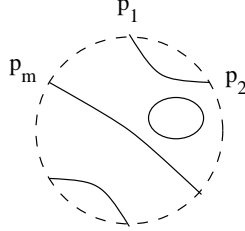

In this more general case to each compact oriented surface S in $U \times [0, 1]$ such that the boundary of S is the union of $Q_0 \times \{0\}$, $Q_1 \times \{1\}$ and $(p_1 \cup \dots \cup p_m) \times [0, 1]$, in exactly the same fashion as before, we associate an \mathcal{I} -cube map

$$\psi_S : V_{P_0} \longrightarrow V_{P_1} \tag{63}$$

This map is a graded map of cubes over $R\text{-mod}_0$ of degree equal to the Euler characteristic of S minus $\frac{m}{2}$.

Tensoring the map ψ_S with the identity map of the skew-commutative n -cube $E_{\mathcal{I}}$ and passing to associated complexes, we obtain a map of complexes of graded R -modules

$$\psi'_S : \overline{C}(P_0) \longrightarrow \overline{C}(P_1) \tag{64}$$

In general this map is not a morphism in the category $\text{Kom}(R\text{-mod}_0)$ of complexes of graded R -modules and grading-preserving homomorphism, as it shifts the grading by $\chi(S) - \frac{m}{2}$, but ψ'_S becomes a morphism in $\text{Kom}(R\text{-mod}_0)$ when the grading of $\overline{C}(P_0)$ or $\overline{C}(P_1)$ is appropriately shifted.

5 Transformations

In this section we associate a quasi-isomorphism of complexes of graded R -modules $C(D) \longrightarrow C(D')$ to a Reidemeister move between two plane diagrams D and D' of an oriented link L .

5.1 Left-twisted curl

Let D be a plane diagram with $n - 1$ double points and let D_1 be a diagram constructed from D by adding a left-twisted curl. Denote by \mathcal{I}' the set of double points of D_1 , by a the double point in the curl and by \mathcal{I} the set of double points of D . There is a natural bijection of sets $\mathcal{I} \rightarrow \mathcal{I}' \setminus \{a\}$, coming from identifying a double point of D with the corresponding double point of D_1 . We will use this bijection to identify the two sets \mathcal{I} and $\mathcal{I}' \setminus \{a\}$.

The crossing a of D_1 can be resolved in two ways. The 0-resolution of a is a diagram D_2 which is a disjoint union of D and a circle. The 1-resolution is a diagram isotopic to D and we will identify this diagram with D .

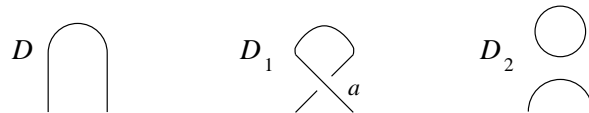

In this section we will define a quasi-isomorphism of the complexes $C(D)$ and $C(D_1)$. This quasi-isomorphism arises from a splitting of the \mathcal{I}' -cube V_{D_1} as a direct sum of two cubes, $V_{D_1} = V' \oplus V''$. This splitting will induce a decomposition of the complex $C(D_1)$ into a direct sum of an acyclic complex and a complex isomorphic to $C(D)$.

Recall that V_D, V_{D_1} and V_{D_2} are the cubes associated with the diagrams D, D_1 and D_2 respectively. V_{D_1} has index set \mathcal{I}' , while V_D and V_{D_2} are \mathcal{I} -cubes.

From the decomposition of D_2 as a union of D and a simple circle we get a canonical isomorphism of cubes

$$V_{D_2} = V_D \otimes A \tag{65}$$

where $V_D \otimes A$ is the \mathcal{I} -cube obtained from V_D by tensoring graded R -modules $V_D(\mathcal{L}), \mathcal{L} \subset \mathcal{I}$ with A and tensoring the structure maps $\xi_a^{V_D}(\mathcal{L})$ with the identity map of A .

Let $U \subset \mathbb{R}^2$ be a small neighborhood of a that contains the curl:

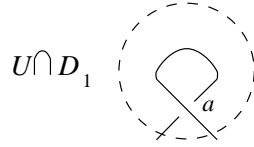

The picture above depicts how the diagram D_1 looks inside U . The boundary of U is shown by a dashed circular line. Intersections of U with diagrams D and D_2 are depicted below



Outside of U diagrams D, D_1 and D_2 coincide. It is explained in Section 4.3 how surfaces in $U \times [0, 1]$, satisfying certain conditions, give rise to cube maps. Using this construction we now define three cube maps between cubes V_D and V_{D_2} :

$$m_a : V_{D_2} \longrightarrow V_D \tag{66}$$

$$\Delta_a : V_D \longrightarrow V_{D_2} \tag{67}$$

$$\iota_a : V_D \longrightarrow V_{D_2} \tag{68}$$

The map m_a is associated to the following surface:

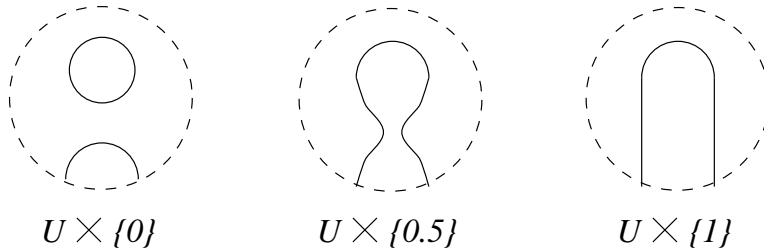

Here and further on we depict surfaces embedded in $U \times [0, 1]$ by a sequence of their cross-sections $U \times \{t\}, t \in [0, 1]$, the leftmost one being the intersection of the surface with $U \times \{0\}$, the rightmost being the intersection with $U \times \{1\}$. For such a surface $S \in U \times [0, 1]$ we will call the projection $S \rightarrow [0, 1]$ *the height function* of S . These surfaces will have only nondegenerate critical points relative to the height function. We depict enough sections of S to make it obvious what surface we are considering, sometimes adding extra information, i.e., that the above surface has one saddle point and no other critical points relative to the height function.

The intersections $S \cap U \times \{0\}, S \cap U \times \{1\}$ of the surface S depicted above with the boundary disks $U \times \{0\}, U \times \{1\}$ are isomorphic to the intersections $D_2 \cap (U \times \{0\})$, respectively $D \cap (U \times \{1\})$. Thus, S defines a map m_a from the cube V_{D_2} to V_D .

The cube map Δ_a is associated to the surface



This surface has one saddle point and no other critical points relative to the height function. ι_a is associated to

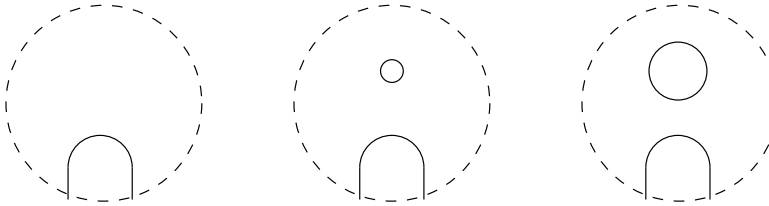

The only critical point of the height function is a local minimum.

The cube maps m_a, Δ_a, ι_a are graded maps and change the grading by $-1, -1, 1$ respectively. So let's keep in mind that m_a, Δ_a, ι_a become grading-preserving if we appropriately shift gradings of our cubes, for example,

$$m_a : V_{D_2} \longrightarrow V_D\{-1\} \quad (69)$$

$$\Delta_a : V_D \longrightarrow V_{D_2}\{-1\} \quad (70)$$

$$\iota_a : V_D \longrightarrow V_{D_2}\{1\} \quad (71)$$

are grading-preserving maps of cubes over $R\text{-mod}_0$.

The composition $m_a \iota_a$ is equal to the identity map from V_D to itself. Denote by J_a the map

$$J_a \stackrel{\text{def}}{=} \Delta_a - \iota_a m_a \Delta_a : V_D \longrightarrow V_{D_2} \quad (72)$$

The map J_a is a graded map of degree -1 .

Proposition 11 *The \mathcal{I} -cube V_{D_2} splits as a direct sum:*

$$V_{D_2} = \iota_a(V_D) \oplus J_a(V_D). \quad (73)$$

Proof: It is enough to consider the case when D is a single circle. Then $\mathcal{I}' = \{a\}, \mathcal{I} = \emptyset, V_D = A$ and $\iota_a(V_D) = \mathbf{1} \otimes A$. But

$$\begin{aligned} J_a \mathbf{1} &= (\Delta_a - \iota_a m_a \Delta_a) \mathbf{1} = X \otimes \mathbf{1} - \mathbf{1} \otimes X + cX \otimes X \\ J_a X &= (\Delta_a - \iota_a m_a \Delta_a) X = X \otimes X \end{aligned}$$

and, thus, $A \otimes A$ is a direct sum of $\mathbf{1} \otimes A$ and the R -submodule spanned by $J_a \mathbf{1}$ and $J_a X$.

□

Note that

$$m_a J_a = m_a (\Delta_a - \iota_a m_a \Delta_a) = 0 \quad (74)$$

because $m_a \iota_a = Id$.

The \mathcal{I}' -cube V_{D_1} contains V_D and V_{D_2} as subcubes of codimension 1. Namely, we have canonical isomorphisms

$$V_{D_1}(*0) \cong V_{D_2} \quad (75)$$

$$V_{D_1}(*1) \cong V_D\{-1\} \quad (76)$$

Recall from Section 3.2 that $V_{D_1}(*0)$ denotes the $\mathcal{I}' \setminus \{a\}$ -cube (i.e. \mathcal{I} -cube) with $V_{D_1}(*0)(\mathcal{L}) = V_{D_1}(\mathcal{L})$ for $\mathcal{L} \subset \mathcal{I}$, etc.

Under these isomorphisms the structure map $\xi_a^{V_{D_1}}$ (denoted below by ξ_a) for the \mathcal{I}' -cube V_{D_1}

$$\xi_a : V_{D_1}(*0) \longrightarrow V_{D_1}(*1) \quad (77)$$

is equal to the map m_a of \mathcal{I} -cubes, i.e., the following diagram is commutative

$$\begin{array}{ccc} V_{D_1}(*0) & \xrightarrow{\xi_a} & V_{D_1}(*1) \\ \downarrow \cong & & \downarrow \cong \\ V_{D_2} & \xrightarrow{m_a} & V_D\{-1\} \end{array}$$

Using the splitting (73) of V_{D_2} we can decompose the \mathcal{I}' -cube V_{D_1} as a direct sum of two \mathcal{I}' -cubes as follows:

$$V_{D_1} = V' \oplus V'' \quad (78)$$

where

$$V'(*0) = j_a(V_D) \quad (79)$$

$$V'(*1) = 0 \quad (80)$$

$$V''(*0) = \iota_a(V_D) \quad (81)$$

$$V''(*1) = V_{D_1}(*1) \quad (82)$$

Some explanation: in the formula (79) $j_a(V_D)$ is a subcube of V_{D_2} and, due to (75), $j_a(V_D)$ sits inside V_{D_1} as a subcube of codimension 1. Equation (80) means that $V'(*1)(\mathcal{L}) = 0$ for all $\mathcal{L} \subset \mathcal{I}'$. Thus, $V'(\mathcal{L}) = j_a(V_D(\mathcal{L})) \subset V_{D_1}(\mathcal{L})$ for $\mathcal{L} \subset \mathcal{I}'$, if \mathcal{L} does not contain a . If \mathcal{L} contains a , $V'(\mathcal{L}) = 0$.

Tensoring (78) with $E_{\mathcal{I}'}$ we get a splitting of skew-commutative \mathcal{I}' -cubes

$$V_{D_1} \otimes E_{\mathcal{I}'} = (V' \otimes E_{\mathcal{I}'}) \oplus (V'' \otimes E_{\mathcal{I}'}) \quad (83)$$

This induces a splitting of complexes associated to these skew-commutative \mathcal{I}' -cubes

$$\overline{\mathcal{C}}(V_{D_1} \otimes E_{\mathcal{I}'}) = \overline{\mathcal{C}}(V' \otimes E_{\mathcal{I}'}) \oplus \overline{\mathcal{C}}(V'' \otimes E_{\mathcal{I}'}) \quad (84)$$

Proposition 12 *The complex $\overline{\mathcal{C}}(V'' \otimes E_{\mathcal{I}'})$ is acyclic.*

Proof: The complex $\overline{\mathcal{C}}(V'' \otimes E_{\mathcal{I}'})$ is isomorphic to the cone of the identity map of the complex $\overline{\mathcal{C}}(V_D \otimes E_{\mathcal{I}})[-1]\{-1\}$.

□

Proposition 13 *The complexes $\overline{\mathcal{C}}(V' \otimes E_{\mathcal{I}'})$ and $\overline{\mathcal{C}}(V_D \otimes E_{\mathcal{I}})\{1\}$ are isomorphic.*

Proof: We have a chain of isomorphisms of complexes

$$\begin{aligned} \overline{\mathcal{C}}(V' \otimes E_{\mathcal{I}'}) &= \overline{\mathcal{C}}(V'(*0) \otimes E_{\mathcal{I}'}) \\ &= \overline{\mathcal{C}}(V_D\{1\} \otimes E_{\mathcal{I}'}) \\ &= \overline{\mathcal{C}}(V_D \otimes E_{\mathcal{I}})\{1\} \end{aligned}$$

Corollary 3 *The complexes $\overline{C}(D_1)$ and $\overline{C}(D)\{1\}$ are quasiisomorphic.*

Proof: We have

$$\begin{aligned}\overline{C}(D_1) &= \overline{C}(V_{D_1} \otimes E_{\mathcal{I}'}) \\ &= \overline{C}(V' \otimes E_{\mathcal{I}'} \oplus V'' \otimes E_{\mathcal{I}'}) \\ &= \overline{C}(V_D \otimes E_{\mathcal{I}}\{1\} \oplus V'' \otimes E_{\mathcal{I}'}) \\ &= \overline{C}(D)\{1\} \oplus (\text{Acyclic complex})\end{aligned}$$

□

Note that $x(D_1) = x(D)$ and $y(D_1) = y(D) + 1$. By (45)

$$C(D) = \overline{C}(D)[x(D)]\{2x(D) - y(D)\} \quad (85)$$

and

$$\begin{aligned}C(D_1) &= \overline{C}(D_1)[x(D_1)]\{2x(D_1) - y(D_1)\} \\ &= \overline{C}(D_1)[x(D)]\{2x(D) - y(D) - 1\}.\end{aligned}$$

Therefore, complexes $C(D)$ and $C(D_1)$ are quasiisomorphic. Q.E.D.

5.2 Right-twisted curl

Let D be a diagram with $n - 1$ double points and let D_1 be a diagram constructed from D by adding a right-twisted curl. Denote by a the new crossing that appears in the curl. Let \mathcal{I} be the set of crossings of D and \mathcal{I}' the set of crossings of D_1 . We have a natural bijection of sets $\mathcal{I} \rightarrow \mathcal{I}' \setminus \{a\}$ and use it to identify these two sets.

Crossing a can be resolved in two ways. 0-resolution gives a diagram, isotopic to D and canonically identified with D . 1-resolution produces a diagram, denoted D_2 , which is a disjoint union of D and a simple circle.



Note that diagrams D and D_2 are the same as diagrams D and D_2 from Section 5.1 and we will be using cube maps m_a, Δ_a, ι_a defined in that section. Also define a map

$$\epsilon_a : V_{D_2} \longrightarrow V_D \quad (86)$$

where ϵ_a is associated to the surface

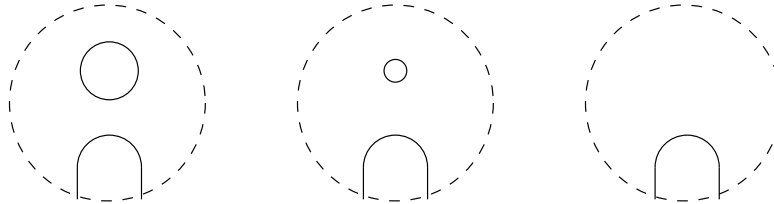

This surface has one critical point relative to the height function and it is a local maximum. The cube map ϵ_a changes the grading by 1 and becomes grading preserving after an appropriate shift:

$$\epsilon_a : V_{D_2} \longrightarrow V_D\{1\} \quad (87)$$

Let \aleph be the map

$$\aleph = \iota_a - c\iota_a m_a \Delta_a : V_D \longrightarrow V_{D_2} \quad (88)$$

\aleph is graded of degree 1.

Proposition 14 *We have a cube splitting*

$$V_{D_2} = \aleph(V_D) \oplus \Delta_a(V_D) \quad (89)$$

Proof: It suffices to check this when D is a simple circle. Then

$$\begin{aligned} \aleph(\mathbf{1}) &= \mathbf{1} \otimes \mathbf{1} - 2c\mathbf{1} \otimes X \\ \aleph(X) &= \mathbf{1} \otimes X \end{aligned}$$

The R -submodule of $A \otimes A$ generated by these two vectors complements $\Delta(A)$ and there is direct sum decomposition of R -modules

$$A \otimes A = R \cdot \aleph(\mathbf{1}) \oplus R \cdot \aleph(X) \oplus \Delta(A)$$

□

Denote by \wp the cube map

$$\wp = m_a - m_a \Delta_a \epsilon_a : V_{D_2} \longrightarrow V_D. \quad (90)$$

Note that \wp is a graded map of degree -1 .

Lemma 1 *We have equalities*

$$\wp \Delta_a = 0 \quad (91)$$

$$\wp \aleph = \text{Id}(V_D) \quad (92)$$

Proof: Map $\wp \Delta_a : V_D \longrightarrow V_D$ is the zero map because

$$\wp \Delta_a = m_a \Delta_a - m_a \Delta_a \epsilon_a \Delta_a = m_a \Delta_a - m_a \Delta_a = 0 \quad (93)$$

(the second equality uses that $\epsilon_a \Delta_a = \text{Id}$.)

The equality (92) is checked similarly:

$$\begin{aligned} \wp \aleph &= (m_a - m_a \Delta_a \epsilon_a)(\iota_a - c\iota_a m_a \Delta_a) \\ &= m_a \iota_a - c m_a \iota_a m_a \Delta_a - m_a \Delta_a \epsilon_a \iota_a + c m_a \Delta_a \epsilon_a \iota_a m_a \Delta_a \\ &= \text{Id} - c m_a \Delta_a + c m_a \Delta_a - c^2 m_a \Delta_a m_a \Delta_a \\ &= \text{Id} - c^2 m_a \Delta_a m_a \Delta_a \\ &= \text{Id} \end{aligned}$$

The third equality in the computation above follows from the identities

$$m_a \iota_a = \text{Id}, \quad \epsilon_a \iota_a = -c. \quad (94)$$

The fifth equality is implied by $m_a \Delta_a m_a \Delta_a = 0$. This identity follows from the nilpotence property $m \Delta m \Delta = 0$ of the structure maps m and Δ of A .

Using the splitting (89) of V_{D_2} and Lemma 1, we can decompose the \mathcal{I}' -cube V_{D_1} as a direct sum of two \mathcal{I}' -cubes as follows:

$$V_{D_1} = V' \oplus V'' \quad (95)$$

where

$$V'(*0) = 0 \quad (96)$$

$$V'(*1) = \aleph(V_D)\{-1\} \subset V_{D_2}\{-1\} = V_{D_1}(*1) \quad (97)$$

$$V''(*0) = V_D = V_{D_1}(*0) \quad (98)$$

$$V''(*1) = \Delta_a(V_D)\{-1\} \subset V_{D_2}\{-1\} = V_{D_1}(*1) \quad (99)$$

Tensoring (95) with $E_{\mathcal{I}'}$ we get a splitting of skew-commutative \mathcal{I}' -cubes

$$V_{D_1} \otimes E_{\mathcal{I}'} = (V' \otimes E_{\mathcal{I}'}) \oplus (V'' \otimes E_{\mathcal{I}'}) \quad (100)$$

This induces a splitting of complexes associated to these skew \mathcal{I}' -cubes

$$\overline{C}(V_{D_1} \otimes E_{\mathcal{I}'}) = \overline{C}(V' \otimes E_{\mathcal{I}'}) \oplus \overline{C}(V'' \otimes E_{\mathcal{I}'}) \quad (101)$$

Proposition 15 *The complex $\overline{C}(V'' \otimes E_{\mathcal{I}'})$ is acyclic.*

Proof: The complex $\overline{C}(V'' \otimes E_{\mathcal{I}'})$ is isomorphic to the cone of the identity map of the complex $\overline{C}(V_D \otimes E_{\mathcal{I}})[-1]$.
□

Proposition 16 *The complexes $\overline{C}(V' \otimes E_{\mathcal{I}'})$ and $\overline{C}(D)[-1]\{-2\}$ are isomorphic.*

Proof: We have a chain of isomorphisms of complexes

$$\begin{aligned} \overline{C}(V' \otimes E_{\mathcal{I}'}) &= \overline{C}(V'(*1) \otimes E_{\mathcal{I}})[-1] \\ &= \overline{C}(V_D\{-2\} \otimes E_{\mathcal{I}})[-1] \\ &= \overline{C}(V_D \otimes E_{\mathcal{I}})[-1]\{-2\} \\ &= \overline{C}(D)[-1]\{-2\} \end{aligned}$$

The first isomorphism here follows from (96) and is obtained by fixing an isomorphism between skew-commutative \mathcal{I} -cubes $E_{\mathcal{I}'}(*1)$ and $E_{\mathcal{I}}$. The second isomorphism comes from an isomorphism $V'(*1) = V_D\{-2\}$, induced by \aleph .
□

Corollary 4 *The complexes $\overline{C}(D_1)$ and $\overline{C}(D)[-1]\{-2\}$ are quasiisomorphic.*

Proof: We have

$$\begin{aligned} \overline{C}(D_1) &= \overline{C}(V_{D_1} \otimes E_{\mathcal{I}'}) \\ &= \overline{C}(V' \otimes E_{\mathcal{I}'}) \oplus \overline{C}(V'' \otimes E_{\mathcal{I}'}) \\ &= \overline{C}(D)[-1]\{-2\} \oplus \overline{C}(V'' \otimes E_{\mathcal{I}'}) \\ &= \overline{C}(D)[-1]\{-2\} \oplus (\text{Acyclic complex}) \end{aligned}$$

□

Note that $x(D_1) = x(D) + 1$ and $y(D_1) = y(D)$. By (45)

$$C(D) = \overline{C}(D)[x(D)]\{2x(D) - y(D)\} \quad (102)$$

and

$$\begin{aligned} C(D_1) &= \overline{C}(D_1)[x(D_1)]\{2x(D_1) - y(D_1)\} \\ &= \overline{C}(D_1)[x(D) + 1]\{2x(D) - y(D) + 2\} \end{aligned}$$

Therefore, complexes $C(D)$ and $C(D_1)$ are quasiisomorphic. Q.E.D.

5.3 The tangency move

Let D and D_1 be two diagrams that differ as depicted below



In this section we will construct a quasi-isomorphism of complexes $C(D)$ and $C(D_1)$.

We assume that D has $n - 2$ double points. Consequently, D_1 has n double points. Let \mathcal{I}' be the set of double points of D_1 , let \mathcal{I} be $\mathcal{I}' \setminus \{a, b\}$ where a and b are double points of D_1 depicted above. We identify \mathcal{I} with the double points set of D .

Denote by d the differential of the complex $\overline{C}(D_1)$. Consider diagrams $D_1(*00), D_1(*01), D_1(*10), D_1(*11)$ obtained by resolving double points a and b of D_1 :

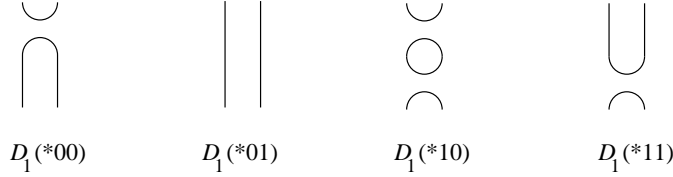

(e.g., $D_1(*01)$ is constructed from D_1 by taking 0-resolution of a and 1-resolution of b , etc.) Each of these four diagrams has \mathcal{I} as the set of its double points.

To a diagram $D_1(*uv)$ where $u, v \in \{0, 1\}$ there is associated the complex $\overline{C}(D_1(*uv))$ of graded R -modules. Denote by d_{uv} the differential in this complex:

$$d_{ab} : \overline{C}(D_1(*uv)) \longrightarrow \overline{C}(D_1(*uv)). \quad (103)$$

We denote by $d_{uv}^{(i)}$ the differential in shifted complexes

$$d_{uv}^{(i)} : \overline{C}(D_1(*uv))[i]\{i\} \longrightarrow \overline{C}(D_1(*uv))[i]\{i\} \text{ for } i \in \mathbb{Z}. \quad (104)$$

The commutative \mathcal{I} -cube V_{D_1} can be viewed as a commutative square of \mathcal{I}' -cubes

$$\begin{array}{ccc} V_{D_1(*00)} & \xrightarrow{\phi_2} & V_{D_1(*01)}\{-1\} \\ \phi_1 \downarrow & & \downarrow \phi_3 \\ V_{D_1(*10)}\{-1\} & \xrightarrow{\phi_4} & V_{D_1(*11)}\{-2\} \end{array}$$

where $\phi_i, 1 \leq i \leq 4$ denote the corresponding cube maps. Recall that these cube maps are associated to certain elementary surfaces (see Sections 4.2, 4.3) that have one saddle point relative to the height function and no other critical points. For example, ϕ_1 is associated to the surface

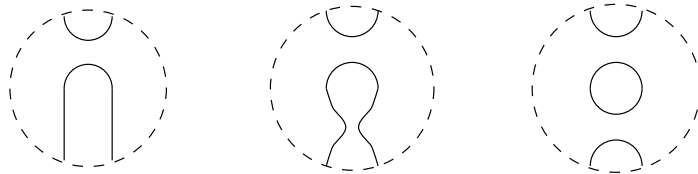

The maps ϕ_i induce maps ψ_i between complexes:

$$\begin{aligned} \psi_1 & : \overline{C}(D_1(*00)) \longrightarrow \overline{C}(D_1(*10))\{-1\} \\ \psi_2 & : \overline{C}(D_1(*00)) \longrightarrow \overline{C}(D_1(*01))\{-1\} \\ \psi_3 & : \overline{C}(D_1(*01))[-1]\{-1\} \longrightarrow \overline{C}(D_1(*11))[-1]\{-2\} \\ \psi_4 & : \overline{C}(D_1(*10))[-1]\{-1\} \longrightarrow \overline{C}(D_1(*11))[-1]\{-2\} \end{aligned}$$

We can decompose $\overline{C}(D_1)$, considered as a $\mathbb{Z} \oplus \mathbb{Z}$ -graded R -module (see the end of Section 3.1), into the following direct sum of $\mathbb{Z} \oplus \mathbb{Z}$ -graded R -modules.

$$\begin{aligned} \overline{C}(D_1) & = \overline{C}(D_1(*00)) \oplus \overline{C}(D_1(*01))[-1]\{-1\} \\ & \oplus \overline{C}(D_1(*10))[-1]\{-1\} \oplus \overline{C}(D_1(*11))[-2]\{-2\} \end{aligned}$$

Let's say a few words about this decomposition: $\overline{C}(D_1)$ is the direct sum of R -modules $V_{D_1}(\mathcal{L})$ which sit in the vertices of the \mathcal{I}' -cube V_{D_1} . Since we presented this cube as a commutative square of \mathcal{I} -cubes $V_{D_1(*uv)}\{-u-v\}$ for $u, v \in \{0, 1\}$, the above decomposition results. Well, almost. Indeed, when we pass from \mathcal{J} -cubes to complexes we tensor with the fixed skew cube $E_{\mathcal{J}}$. To define the left hand side of the above formula we tensor V_{D_1} with the skew \mathcal{I}' -cube $E_{\mathcal{I}'}$, while for the right hand side similar tensor products are formed with the skew \mathcal{I} -cube $E_{\mathcal{I}}$. Therefore, we must say how we identify R -modules which sit in the vertices of $E_{\mathcal{I}'}$ with R -modules sitting in the vertices of $E_{\mathcal{I}}$. For $D_1(*00)$: we map $E_{\mathcal{I}}(\mathcal{L})$ where $\mathcal{L} \subset \mathcal{I}$ to $E_{\mathcal{I}'}(\mathcal{L})$ by sending $z \in o(\mathcal{L})$ to $z \in o(\mathcal{L})$. For $D_1(*10)$: map $E_{\mathcal{I}}(\mathcal{L})$ where $\mathcal{L} \subset \mathcal{I}$ to $E_{\mathcal{I}'}(\mathcal{L}a)$ by sending $z \in o(\mathcal{L})$ to $za \in o(\mathcal{L}a)$. Similarly for $D_1(*01)$. For $D_1(*11)$: map $E_{\mathcal{I}}(\mathcal{L})$ to $E_{\mathcal{I}'}(\mathcal{L}ab)$ by sending $z \in o(\mathcal{L})$ to $zab \in o(\mathcal{L}ab)$. This is not a canonical choice, since we could have sent z to zba and would have gotten minus the original map. So, to define the latter map, we implicitly fix an ordering of a and b .

Note that the above decomposition is not a direct sum of complexes, as the differential $d_{uv}^{(-u-v)}$ of $\overline{C}(D_1(*uv))$ differs from d restricted to $\overline{C}(D_1(*uv))[-u-v]\{-u-v\} \subset \overline{C}(D_1)$, except when $u = v = 1$. Exactly, we have

$$\begin{aligned} dx &= d_{00}x + [-1]\psi_1x + [-1]\psi_2x & \text{for } x \in \overline{C}(D_1(*00)) \\ dx &= -d_{01}^{(-1)}x - [-1]\psi_3x & \text{for } x \in \overline{C}(D_1(*01))[-1]\{-1\} \\ dx &= -d_{10}^{(-1)}x + [-1]\psi_4x & \text{for } x \in \overline{C}(D_1(*10))[-1]\{-1\} \\ dx &= d_{11}^{(-2)}x & \text{for } x \in \overline{C}(D_1(*11))[-2]\{-2\} \end{aligned}$$

Some explanation: applying ψ_1 to $x \in \overline{C}(D_1(*00))$ we get an element of $\overline{C}(D_1(*10))\{-1\}$, so that we shift ψ_1x by $[-1]$ to land it in $\overline{C}(D_1(*10))[-1]\{-1\} \subset \overline{C}(D_1)$, etc. Various signs in the above formulas come from our previous four identifications of the skew cube $E_{\mathcal{I}}$ with codimension 2 faces of $E_{\mathcal{I}'}$.

Let α be the map of complexes

$$\alpha : \overline{C}(D_1(*01))[-1]\{-1\} \longrightarrow \overline{C}(D_1(*10))[-1]\{-1\} \quad (105)$$

associated to the surface

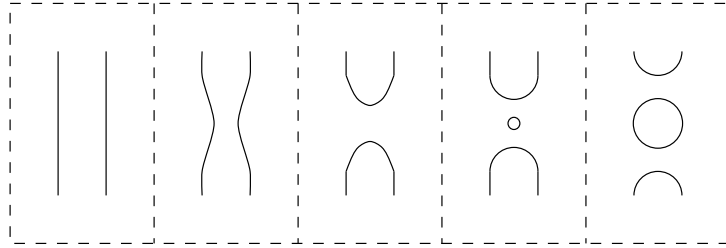

Considered as a map of $\mathbb{Z} \oplus \mathbb{Z}$ -graded R -modules, α is grading-preserving.

Let β be the map of complexes

$$\beta : \overline{C}(D_1(*11))[-2]\{-2\} \longrightarrow \overline{C}(D_1(*10))[-1]\{-1\} \quad (106)$$

associated to the surface

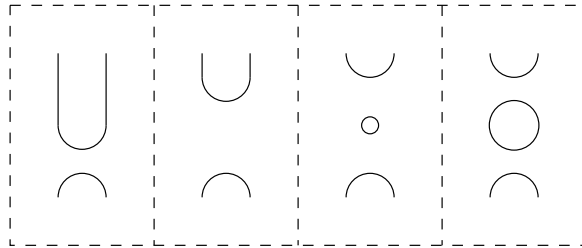

Note that β is a graded map of degree $(-1, 0)$.

Let X_1, X_2, X_3 be R -submodules of $\overline{\mathcal{C}}(D_1)$ given by

$$X_1 = \{z + \alpha(z) | z \in \overline{\mathcal{C}}(D_1(*01))[-1]\{-1\}\} \quad (107)$$

$$X_2 = \{z + dw | z, w \in \overline{\mathcal{C}}(D_1(*00))\} \quad (108)$$

$$X_3 = \{z + \beta(w) | z, w \in \overline{\mathcal{C}}(D_1(*11))[-2]\{-2\}\} \quad (109)$$

Proposition 17 *These submodules are stable under d :*

$$dX_i \subset X_i \quad (110)$$

and respect the $\mathbb{Z} \oplus \mathbb{Z}$ -grading of $\overline{\mathcal{C}}(D_1)$.

Proof: Let us first check that X_1, X_2 and X_3 are direct sums of their graded components. For X_2 it follows from the fact that $\overline{\mathcal{C}}(D_1(*00))$ is a direct sum of its graded components and d is graded of degree $(1, 0)$. Submodule X_3 is graded because $\overline{\mathcal{C}}(D_1(*11))[-2]\{-2\}$ is a direct sum of its graded components and β is a graded map. Finally, X_1 is graded since α is grading-preserving.

We now verify that these three submodules are stable under d . For X_2 this is obvious. To see it for X_3 , notice that $dz \in \overline{\mathcal{C}}(D_1(*11))[-2]\{-2\}$ whenever $z \in \overline{\mathcal{C}}(D_1(*11))[-2]\{-2\}$. Moreover, for such a z ,

$$d\beta(z) = -d_{10}^{(-1)}\beta(z) + [-1]\psi_4\beta(z) = -d_{10}^{(-1)}\beta(z) + z = \beta d_{11}^{(-2)}(z) + z \quad (111)$$

The second equality is implied by $[-1]\psi_4\beta = \text{Id}$. Map $\psi_4\beta$ is associated to the surface

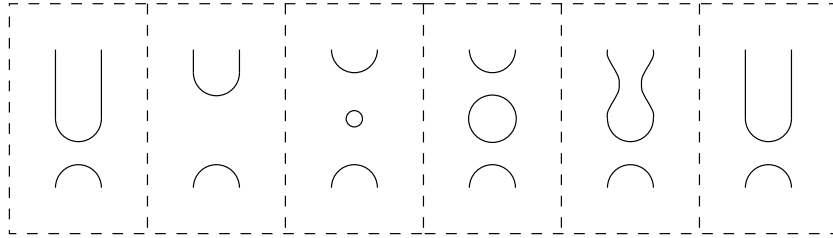

obtained by composing surfaces to which ψ_4 and β are associated. This surface is isotopic, through an isotopy fixing the boundary, to the surface

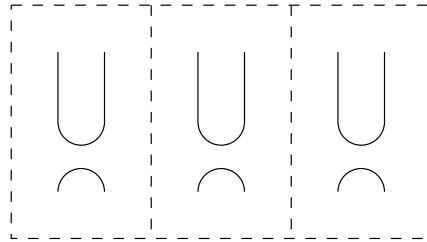

representing the identity map. Hence $[-1]\psi_4\beta = \text{Id}$.

Formula (111) implies that X_3 is stable under d , since the rightmost term $\beta d_{11}^{(-2)}(z) + z$ lies in X_3 .

Finally, to check the d -stability of X_1 , we compute, for $z \in \overline{\mathcal{C}}(D_1(*01))[-1]\{-1\}$,

$$\begin{aligned} d(z + \alpha(z)) &= dz + d\alpha(z) \\ &= -d_{01}^{(-1)}z - [-1]\psi_3z - d_{10}^{(-1)}\alpha(z) + [-1]\psi_4\alpha(z) \\ &= -(d_{01}^{(-1)}z + d_{10}^{(-1)}\alpha(z)) + [-1](\psi_3z + \psi_4\alpha(z)) \\ &= -(d_{01}^{(-1)}z + d_{10}^{(-1)}\alpha(z)) \\ &= -(d_{01}^{(-1)}z + \alpha d_{01}^{(-1)}z) \in X_1 \end{aligned}$$

In the fourth equality we used that $\psi_4\alpha = \psi_3$, in the fifth that $\alpha d_{01}^{(-1)} = d_{10}^{(-1)}\alpha$, since α is a grading-preserving map of complexes.

□

Corollary 5 *Submodules X_1, X_2, X_3 are graded subcomplexes of the complex $\overline{C}(D_1)$.*

Proposition 18 1. *We have a direct sum decomposition*

$$\overline{C}(D_1) = X_1 \oplus X_2 \oplus X_3 \quad (112)$$

in the category $\text{Kom}(R\text{-mod}_0)$ of complexes of graded R -modules.

2. *The complexes X_2 and X_3 are acyclic.*

3. *The complex X_1 is isomorphic to the complex $\overline{C}(D)[-1]\{-1\}$.*

Proof: Since we already know that X_1, X_2 and X_3 are graded subcomplexes of $\overline{C}(D_1)$, it suffices to check (112) on the level of underlying abelian groups. We have $\alpha = \beta\psi_3$ and, therefore, for $z \in \overline{C}(D_1(*01))[-1]\{-1\}$

$$\alpha z = \beta\psi_3 z \in X_3 \quad (113)$$

Subcomplex X_1 consists of elements $z + \alpha z$ and we know that $\alpha z \in X_3$. We are thus reduced to proving the following direct sum splitting of abelian groups

$$\overline{C}(D_1) = \overline{C}(D_1(*01))[-1]\{-1\} \oplus X_2 \oplus X_3 \quad (114)$$

Next recall that X_2 consists of elements $z + dw$ for $z, w \in \overline{C}(D_1(*00))$. The differential dw reads

$$dw = d_{00}w + [-1]\psi_1 w + [-1]\psi_2 w \quad (115)$$

Note that $[-1]\psi_2(w) \in \overline{C}(D_1(*01))[-1]\{-1\}$ and $d_{00}w \in \overline{C}(D_1(*00))$. Let X'_2 be the subgroup of $\overline{C}(D_1)$ given by

$$X'_2 = \{z + [-1]\psi_1 w \mid z, w \in \overline{C}(D_1(*00))\} \quad (116)$$

Then it is enough to verify that $\overline{C}(D_1)$ is a direct sum of its subgroups $\overline{C}(D_1(*01))[-1]\{-1\}, X'_2$ and X_3 :

$$\overline{C}(D_1) = \overline{C}(D_1(*01))[-1]\{-1\} \oplus X'_2 \oplus X_3. \quad (117)$$

Note that X_3 contains $\overline{C}(D_1(*11))[-2]\{-2\}$ and X'_2 contains $\overline{C}(D_1(*00))$. Recall the direct sum decomposition

$$\begin{aligned} \overline{C}(D_1) &= \overline{C}(D_1(*00)) \oplus \overline{C}(D_1(*01))[-1]\{-1\} \\ &\oplus \overline{C}(D_1(*10))[-1]\{-1\} \oplus \overline{C}(D_1(*11))[-2]\{-2\} \end{aligned}$$

of $\overline{C}(D_1)$. Let X''_2 and X'_3 be the following abelian subgroups of $\overline{C}(D_1(*10))[-1]\{-1\}$:

$$\begin{aligned} X''_2 &= \{[-1]\psi_1(w) \mid w \in \overline{C}(D_1(*00))\} \\ X'_3 &= \{\beta(w) \mid w \in \overline{C}(D_1(*11))[-2]\{-2\}\} \end{aligned}$$

Now we are reduced to proving the direct sum decomposition

$$\overline{C}(D_1(*10))[-1]\{-1\} = X''_2 \oplus X'_3 \quad (118)$$

in the category of abelian groups. As an abelian group, $\overline{C}(D_1(*10))[-1]\{-1\}$ is a direct sum of $F(D_1(\mathcal{L}a))$ over all possible resolutions of the $(n-2)$ -double points of D_1 . Similar direct sum splittings can be formed for X''_2 and X'_3 and one sees then that it suffices to check (118) when D_1 has only two double points. There are two such D_1 's:

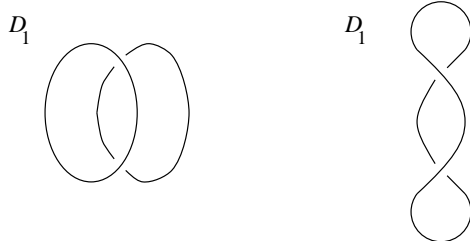

In each of these two cases decomposition (118) follows from the splitting (2). That proves part 1 of the proposition.

We next prove part 2. The complex $\overline{C}(X_2)$ is isomorphic to the cone of the identity map of $\overline{C}(D_1(*00))[-1]$ and, therefore, acyclic. Similarly, $\overline{C}(X_3)$ is acyclic, being isomorphic to the cone of the identity map of $\overline{C}(D_1(*11))\{-2\}[-2]$.

To prove part 3 of the proposition, notice that the diagrams D and $D_1(*01)$ are isomorphic. This induces an isomorphism between the complexes

$$\overline{C}(D) = \overline{C}(D_1(*01)) \quad (119)$$

An isomorphism

$$\gamma : \overline{C}(D_1(*01))[-1]\{-1\} \xrightarrow{\cong} X_1 \quad (120)$$

is given by

$$\gamma(z) = (-1)^i(z + \alpha(z)) \quad (121)$$

for $z \in \overline{C}(D_1(*01))[-1]\{-1\}$. We need $(-1)^i$ in the above formula to match the differentials in these two complexes.

□

Corollary 6 *The complexes $\overline{C}(D)[-1]\{-1\}$ and $\overline{C}(D_1)$ are quasiisomorphic.* □

Note that $x(D_1) = x(D) + 1$ and $y(D_1) = y(D) + 1$. From (45) we get

$$\begin{aligned} C(D) &= \overline{C}(D)[x(D)]\{2y(D) - x(D)\} \\ C(D_1) &= \overline{C}(D_1)[x(D) + 1]\{2y(D) - x(D) + 1\} \end{aligned}$$

which, together with Corollary 6, implies that $C(D)$ is quasiisomorphic to $C(D_1)$. Q.E.D.

5.4 Triple point move

We are given two diagrams with n double points each, D_1 and D_2 , that differ as depicted below.

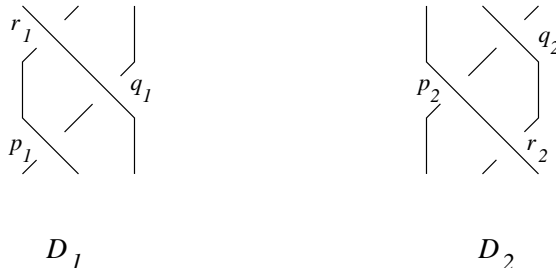

In this section we will construct a quasi-isomorphism of complexes $C(D_1)$ and $C(D_2)$.

Let \mathcal{I}' be the set of double points of D_1 . We have $\mathcal{I}' = \mathcal{I} \sqcup \{p_1, q_1, r_1\}$ where \mathcal{I} are all double points not shown on the above picture. In particular, we can identify $\mathcal{I} \sqcup \{p_2, q_2, r_2\}$ with the set of double points of D_2 .

For starters, consider the diagrams $D_1(*0)$, $D_1(*1)$, $D_2(*0)$, $D_2(*1)$, obtained by resolving double points r_1 of D_1 and r_2 of D_2 :

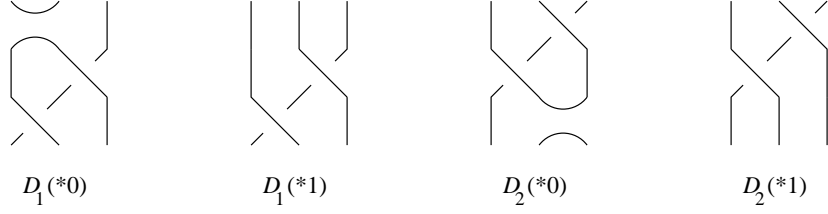

Note that diagrams $D_1(*1)$ and $D_2(*1)$ are isomorphic and that diagrams $D_1(*0)$ and $D_2(*0)$ represent isotopic links.

We decompose $\overline{\mathcal{C}}(D_1)$ and $\overline{\mathcal{C}}(D_2)$ into following direct sums:

$$\overline{\mathcal{C}}(D_i) = \overline{\mathcal{C}}(D_i(*1))[-1]\{-1\} \oplus \bigoplus_{u,v \in \{0,1\}} \overline{\mathcal{C}}(D_i(*uv0))[-u-v]\{-u-v\} \quad (122)$$

These are direct sum decompositions of $\mathbb{Z} \oplus \mathbb{Z}$ -graded R -modules, not complexes. The diagrams $D_i(*uv0)$ for $i = 1, 2$ and $u, v \in \{0, 1\}$ are depicted below

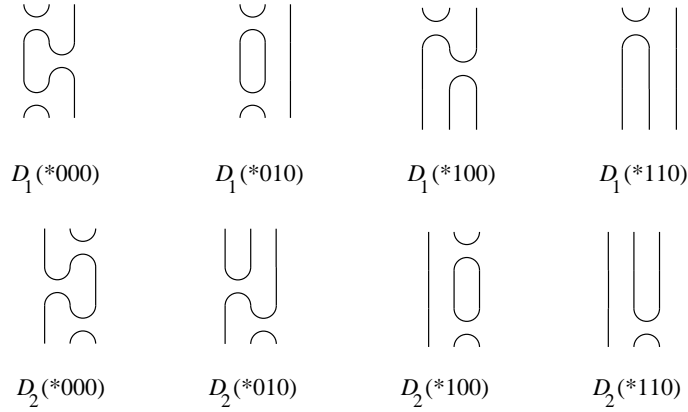

For all i, u, v as above, we identify the set of double points of $D_i(*uv0)$ with \mathcal{I} . To fix the direct decomposition (122) we need identifications between the skew cube $E_{\mathcal{I}}$ and codimension 3 facets of $E_{\mathcal{I}'}$. From the discussion in the previous section it should be clear how these identifications are chosen. For instance, for $D_1(*110)$, we map $E_{\mathcal{I}}$ to a codimension 3 facet of $E_{\mathcal{I}'}$ via maps $E_{\mathcal{I}}(\mathcal{L}) \rightarrow E_{\mathcal{I}'}(\mathcal{L}p_1q_1)$ given by $o(\mathcal{L}) \ni z \mapsto zp_1q_1 \in o(\mathcal{L} \sqcup \{p_1, q_1\})$.

Let τ_1 be the map of complexes

$$\tau_1 : \overline{\mathcal{C}}(D_1(*100))[-1]\{-1\} \longrightarrow \overline{\mathcal{C}}(D_1(*010))[-1]\{-1\} \quad (123)$$

associated to the surface

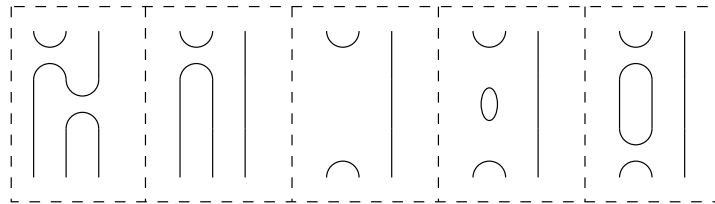

Relative to the height function this surface has two critical points, one of which is a saddle point and the other – a local minimum. Considered as a map of $\mathbb{Z} \oplus \mathbb{Z}$ -graded R -modules, τ_1 is grading-preserving.

Let δ_1 be the map of complexes

$$\delta_1 : \overline{\mathcal{C}}(D_1(*110))[-2]\{-2\} \longrightarrow \overline{\mathcal{C}}(D_1(*010))[-1]\{-1\} \quad (124)$$

associated to the surface

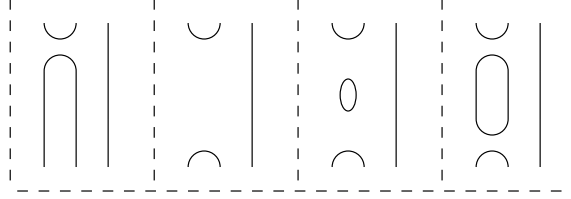

Let X_1, X_2, X_3 be R -submodules of $\overline{\mathcal{C}}(D_1)$ given by

$$\begin{aligned}
X_1 &= \{x + \tau_1(x) + y | x \in \overline{\mathcal{C}}(D_1(*100))[-1]\{-1\}, y \in \overline{\mathcal{C}}(D_1(*1))[-1]\{-1\}\} \\
X_2 &= \{x + d_1 y | x, y \in \overline{\mathcal{C}}(D_1(*000))\} \\
X_3 &= \{\delta_1(x) + d_1 \delta_1(y) | x, y \in \overline{\mathcal{C}}(D_1(*110))[-2]\{-2\}\}
\end{aligned} \tag{125}$$

where d_1 denotes the differential of $\overline{\mathcal{C}}(D_1)$. *Warning:* These X_1, X_2, X_3 have no relation to the complexes X_1, X_2, X_3 considered in Section 5.3.

Propositions 19-21 below can be proved in the same fashion as Propositions 17 and 18 of the previous section. For this reason and to keep this paper from being too lengthy the proofs are omitted.

Proposition 19 *Submodules X_1, X_2, X_3 are stable under d_1 and respect the $\mathbb{Z} \oplus \mathbb{Z}$ -grading of $\overline{\mathcal{C}}(D_1)$.*

Corollary 7 *Submodules X_1, X_2, X_3 are graded subcomplexes of the complex $\overline{\mathcal{C}}(D_1)$.*

Let τ_2 be the map of complexes

$$\tau_2 : \overline{\mathcal{C}}(D_2(*010))[-1]\{-1\} \longrightarrow \overline{\mathcal{C}}(D_1(*100))[-1]\{-1\} \tag{126}$$

associated to the surface

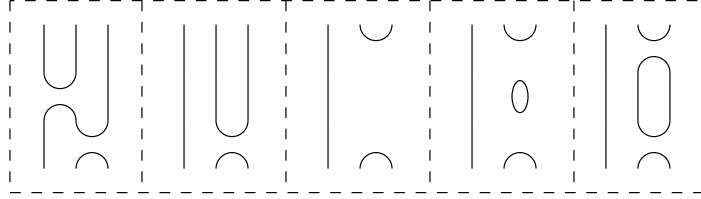

Considered as a map of $\mathbb{Z} \oplus \mathbb{Z}$ -graded R -modules, τ_2 is grading-preserving.

Let δ_2 be the map of complexes

$$\delta_2 : \overline{\mathcal{C}}(D_2(*110))[-2]\{-2\} \longrightarrow \overline{\mathcal{C}}(D_2(*100))[-1]\{-1\} \tag{127}$$

associated to the surface

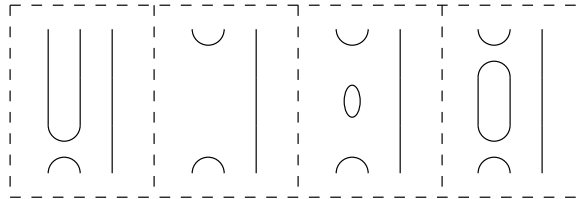

Let Y_1, Y_2, Y_3 be R -submodules of $\overline{\mathcal{C}}(D_2)$ given by

$$\begin{aligned}
Y_1 &= \{x + \tau_2(x) + y | x \in \overline{\mathcal{C}}(D_2(*010))[-1]\{-1\}, y \in \overline{\mathcal{C}}(D_2(*1))[-1]\{-1\}\} \\
Y_2 &= \{x + d_2 y | x, y \in \overline{\mathcal{C}}(D_2(*000))\} \\
Y_3 &= \{\delta_2(x) + d_2 \delta_2(y) | x, y \in \overline{\mathcal{C}}(D_2(*110))[-2]\{-2\}\}
\end{aligned} \tag{128}$$

where d_2 stands for the differential of $\overline{\mathcal{C}}(D_2)$.

Proposition 20 *These submodules are stable under d_2 and respect the $\mathbb{Z} \oplus \mathbb{Z}$ -grading of $\overline{C}(D_2)$.*

Corollary 8 *Subcomplexes Y_1, Y_2, Y_3 are graded subcomplexes of the complex $\overline{C}(D_2)$.*

Proposition 21 1. *We have direct sum decompositions*

$$\overline{C}(D_1) = X_1 \oplus X_2 \oplus X_3 \quad (129)$$

$$\overline{C}(D_2) = Y_1 \oplus Y_2 \oplus Y_3 \quad (130)$$

2. *The complexes X_2, X_3, Y_2 and Y_3 are acyclic.*

3. *The complexes X_1 and Y_1 are isomorphic.*

Proof: Parts 1 and 2 of this proposition are proved similarly to Proposition 18. The isomorphism $X_1 \cong Y_1$ comes from the diagram isomorphisms

$$\begin{aligned} D_1(*100) &= D_2(*010), \\ D_1(*1) &= D_2(*1). \end{aligned} \quad (131)$$

These diagram isomorphisms induce isomorphisms of complexes

$$\begin{aligned} \overline{C}(D_1(*100)) &= \overline{C}(D_2(*010)) \\ \overline{C}(D_1(*1)) &= \overline{C}(D_2(*1)) \end{aligned} \quad (132)$$

which allow us to identify x in the definition (125) of X_1 with x in the definition (128) of Y_1 and, similarly, identify y 's. An isomorphism $X_1 \cong Y_1$ of complexes is then given by

$$X_1 \ni x + \tau_1(x) + y \longmapsto x + \tau_2(x) + y \in Y_1. \quad (133)$$

□

Corollary 9 *Complexes $\overline{C}(D_1)$ and $\overline{C}(D_2)$ are quasiisomorphic.*

The above isomorphism of complexes X_1 and Y_1 induces a quasi-isomorphism of $\overline{C}(D_1)$ and $\overline{C}(D_2)$. Note that $x(D_1) = x(D_2)$ and $y(D_1) = y(D_2)$. Therefore, the complexes $C(D_1)$ and $C(D_2)$ are quasi-isomorphic and the cohomology groups $H^i(D_1)$ and $H^i(D_2)$ are isomorphic as graded R -modules. Q.E.D.

This finishes the proof of Theorem 1.

6 Properties of cohomology groups

6.1 Some elementary properties

Pick an oriented link L and a component L' of L . Let L_0 be L with the orientation of L' reversed and let l be the linking number of L' and $L \setminus L'$. Fixing a plane diagram D of L , we count l as half the number of double intersection points in D of L' with $L \setminus L'$ with weights $+1$ or -1 according to the following convention



Denote by D_0 the diagram D with the reversed orientation of L' . Since D_0 and D are the same as unoriented diagrams, $\overline{C}(D_0) = \overline{C}(D)$. Also

$$x(D_0) = x(D) - 2l, y(D_0) = y(D) + 2l \quad (134)$$

We obtain

Proposition 22 For L, L_0 as above, there is an equality

$$H^i(L_0) = H^{i+2l}(L)\{2l\} \quad (135)$$

of isomorphism classes of graded R -modules.

Let K, K_1 be oriented knots and $(-K)$ be K with orientation reversed. In a similar fashion we deduce

Proposition 23 There is an equality

$$H^i(K \# K_1) = H^i((-K) \# K_1) \quad (136)$$

of isomorphism classes of graded R -modules.

Let D be a diagram of an oriented link L and denote by $\text{cm}(L)$ the number of connected components of L . Then it is easy to see that $C_j^i(D) = 0$ if parities of j and $\text{cm}(L)$ differ. This observation implies

Proposition 24 For an oriented link L

$$H^{i,j}(L) = 0 \quad (137)$$

if $j + 1 \equiv \text{cm}(L) \pmod{2}$.

6.2 Computational shortcuts and cohomology of $(2, n)$ torus links

Given a plane diagram D , a straightforward computation of cohomology groups $H^i(D)$ is daunting. These groups are cohomology groups of the graded complex $C(D)$ and the ranks of the abelian groups $C_j^i(D)$ grow exponentially in the complexity of D . Probably there is no fast algorithm for computing $H^i(D)$, since these groups carry full information about the Jones polynomial, computing which is $\#P$ -hard ([JVV]).

Yet, one can try to reduce $C(D)$ to a much smaller complex, albeit still exponentially large, but more practical for a computation. In this section we provide an example by simplifying $C(D)$ in the case when D contains a chain of positive half-twists and apply our result by computing cohomology groups of $(2, n)$ torus links.

Let D be a plane diagram with n crossings and suppose that D contains a subdiagram pictured below

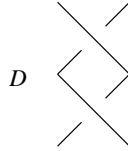

Four possible resolutions of these two double points of D produce diagrams $D(*00), D(*01), D(*10), D(*11)$:

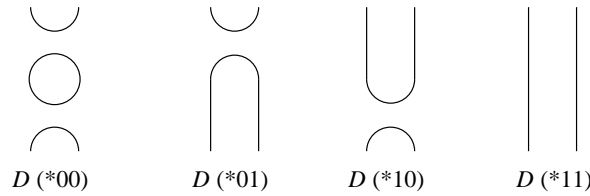

Note that diagrams $D(*01)$ and $D(*10)$ are isomorphic and $D(*00)$ is isomorphic to a union of $D(*01)$ and a simple circle. The complex $\overline{C}(D)$ is isomorphic to the total complex of the bicomplex

$$\begin{aligned} \cdots \longrightarrow 0 &\longrightarrow \overline{C}(D(*00)) \xrightarrow{\partial^0} \overline{C}(D(*01))\{-1\} \oplus \overline{C}(D(*10))\{-1\} \xrightarrow{\partial^1} \\ &\xrightarrow{\partial^1} \overline{C}(D(*11))\{-2\} \longrightarrow 0 \longrightarrow \cdots \end{aligned}$$

where the differentials ∂^0 and ∂^1 are determined by the structure maps of the skew \mathcal{I} -cube $V_D \otimes E_{\mathcal{I}}$ (where \mathcal{I} is the set of crossings of D). Denote this bicomplex by C . To simplify notation we denote the diagram $D(*01)$ by D_0 and $D(*11)$ by D_1 .



Then the bicomplex C becomes

$$\begin{array}{ccccccc} \cdots & \longrightarrow & 0 & \longrightarrow & \overline{C}(D_0) \otimes A & \xrightarrow{\partial^0} & \overline{C}(D_0)\{-1\} \oplus \overline{C}(D_0)\{-1\} \xrightarrow{\partial^1} \\ & & & & \xrightarrow{\partial^1} & \overline{C}(D_1)\{-2\} & \longrightarrow 0 \longrightarrow \cdots \end{array}$$

Clearly, the differential ∂^0 , if restricted to the subcomplex $\overline{C}(D_0) \otimes \mathbf{1}$ of $\overline{C}(D_0) \otimes A$, is injective, and so the total complex of the subbicomplex

$$0 \longrightarrow C(D_0) \otimes \mathbf{1} \xrightarrow{\partial^0} C(D_0)\{-1\} \longrightarrow 0 \quad (138)$$

of C is acyclic. Denote this subbicomplex by C_s and the quotient bicomplex by C/C_s . The total complexes $\text{Tot}(C)$ and $\text{Tot}(C/C_s)$ of C and C/C_s are quasi-isomorphic, so to compute the cohomology of $\overline{C}(D) = \text{Tot}(C)$ it suffices to find the cohomology of $\text{Tot}(C/C_s)$.

We next give a precise description of the bicomplex $\text{Tot}(C/C_s)$. Let u, l, w be maps of complexes

$$u : \overline{C}(D(*00)) \longrightarrow \overline{C}(D_0) \quad (139)$$

$$l : \overline{C}(D(*00)) \longrightarrow \overline{C}(D_0) \quad (140)$$

$$w : \overline{C}(D_0) \longrightarrow \overline{C}(D_1) \quad (141)$$

induced by surfaces

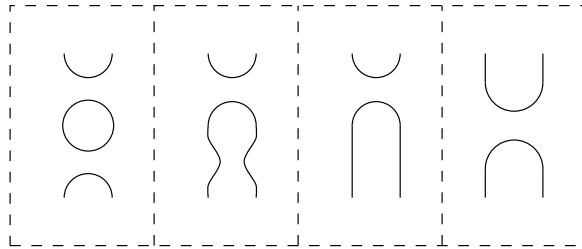
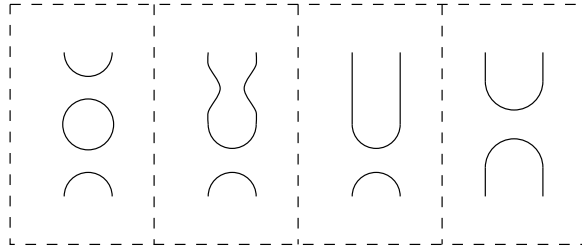

and

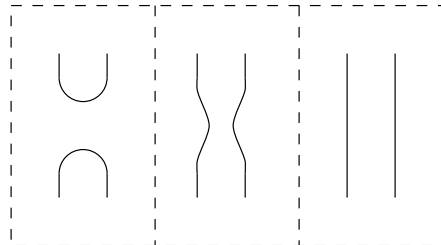

respectively. Note that each of these maps have degree -1 , and to make them homogeneous we need to shift gradings of our complexes appropriately. We will use the same notations for shifted maps since it will always be clear what the shifts are.

Let

$$v : \overline{C}(D_0) \longrightarrow \overline{C}(D_0) \otimes A = \overline{C}(D(*00)) \quad (142)$$

be the map of complexes $v(t) = t \otimes X, t \in \overline{C}(D_0)$. The map v has degree -1 . Denote by u_X and l_X the compositions

$$u_X = u \circ v, \quad l_X = l \circ v. \quad (143)$$

These are degree -2 maps of complexes and for each i they induce degree 0 maps $\overline{C}(D_0)\{i\} \longrightarrow \overline{C}(D_0)\{i-2\}$, also denoted u_X and l_X .

Lemma 2 *The bicomplex C/C_s is isomorphic to the bicomplex*

$$0 \longrightarrow \overline{C}(D_0)\{1\} \xrightarrow{u_X - l_X} \overline{C}(D_0)\{-1\} \xrightarrow{w} \overline{C}(D_1)\{-2\} \longrightarrow 0 \quad (144)$$

We skip the proof which is a simple linear algebra. \square

Corollary 10 *Cohomology groups $\overline{H}^i(D)$ are isomorphic to the cohomology of the total complex of the bicomplex (144).*

We thus see that the cohomology $\overline{H}^i(D)$ of the diagram D can be computed via the quotient complex $\text{Tot}(C/C_s)$ of $\overline{C}(D)$. The quotient complex is smaller than the original one and computing its cohomology requires less work. This reduction is not drastic since ranks of homogeneous components of complexes $\overline{C}(D)$ and $\text{Tot}(C/C_s)$ have the same order of magnitude, but a similar reduction (described next, when D contains a long chain of positive twists) leads to an effective computation of $H^i(D)$ for certain diagrams D .

Suppose that a diagram D contains a chain of k positive half-twists

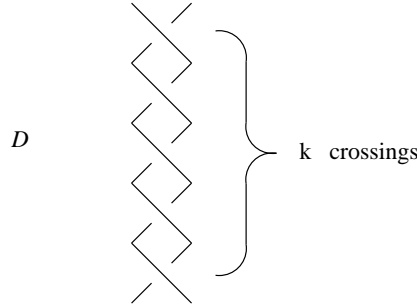

As before, denote by D_0 and D_1 diagrams that are suitable resolutions of the k -chain of D .



From our previous discussion we retain degree -2 maps u_X, l_X and degree -1 map w between (appropriately shifted) complexes $\overline{C}(D_0)$ and $\overline{C}(D_1)$. Let C' be the bicomplex

$$\begin{array}{ccccccc} 0 & \longrightarrow & \overline{C}(D_0)\{k-1\} & \xrightarrow{\partial^0} & \overline{C}(D_0)\{k-3\} & \xrightarrow{\partial^1} & \dots \\ & & \xrightarrow{\partial^{k-3}} & \overline{C}(D_0)\{3-k\} & \xrightarrow{\partial^{k-2}} & \overline{C}(D_0)\{1-k\} & \xrightarrow{\partial^{k-1}} \overline{C}(D_1)\{-k\} \longrightarrow 0 \end{array}$$

where

$$\begin{aligned}
\partial^{k-1} &= w \\
\partial^{k-2} &= u_X - l_X \\
\partial^{k-3} &= u_X + l_X \\
\partial^{k-4} &= u_X - l_X \\
&\dots \\
\partial^0 &= u_X - (-1)^k l_X,
\end{aligned}$$

i.e.

$$\partial^{k-i} = u_X - (-1)^i l_X, \quad \text{for } 2 \leq i \leq k. \quad (145)$$

Proposition 25 *The complex $\overline{C}(D)$ is quasiisomorphic to the total complex $\text{Tot}(C')$ of the bicomplex C' . Cohomology groups $\overline{H}^i(D)$ are isomorphic to the cohomology groups of $\text{Tot}(C')$.*

The proof goes by induction on k , induction base $k = 2$ being given by Corollary 10, and consists of finding a suitable acyclic subcomplex to quotient by. We omit the details. \square

We conclude this section by applying this proposition to compute cohomology groups of $(2, k)$ torus links. Fix $k > 0$ and denote by D the diagram

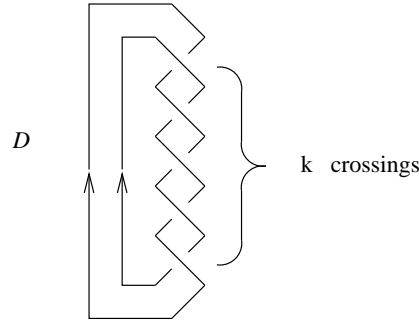

of the $(2, k)$ torus link $T_{2,k}$.

The diagram D_0 is isomorphic to a simple circle and D_1 to a disjoint union of two simple circles. Then $u_X = l_X$ is the operator $A \rightarrow A$ of multiplication by X and the bicomplex C' becomes a complex

$$\begin{aligned}
0 &\longrightarrow A\{k-1\} \longrightarrow A\{k-3\} \longrightarrow \dots \\
&\xrightarrow{0} A\{5-k\} \xrightarrow{2X} A\{3-k\} \xrightarrow{0} A\{1-k\} \xrightarrow{\Delta} A \otimes A\{-k\} \longrightarrow 0
\end{aligned}$$

Recalling that $x(D) = k$ and $y(D) = 0$, we get

Proposition 26 *The isomorphism classes of the graded R -modules $H^i(T_{2,k})$ are given by*

$$\begin{aligned}
H^i(T_{2,k}) &= 0 \quad \text{for } i < -k \text{ and } i > 0, \\
H^0(T_{2,k}) &= R\{k\} \oplus R\{k-2\}, \\
H^{-1}(T_{2,k}) &= 0, \\
H^{-2j}(T_{2,k}) &= (R/2R)\{4j+k\} \oplus R\{4j-2+k\} \quad \text{for } 1 \leq j \leq \frac{k-1}{2}, \\
&\quad j \in \mathbb{Z}, \\
H^{-2j-1}(T_{2,k}) &= R\{4j+2+k\} \quad \text{for } 1 \leq j \leq \frac{k-1}{2}, j \in \mathbb{Z}, \\
H^{-k}(T_{2,k}) &= R\{3k\} \oplus R\{3k-2\} \quad \text{for even } k.
\end{aligned}$$

6.3 Link cobordisms and maps of cohomology groups

In this section by a surface S in \mathbb{R}^4 we mean an oriented, compact surface S , possibly with boundary, properly embedded in $\mathbb{R}^3 \times [0, 1]$. The boundary of S is then a disjoint union

$$\partial S = \partial_0 S \sqcup -\partial_1 S \quad (146)$$

of the intersections of S with two boundary components of $\mathbb{R}^3 \times [0, 1]$:

$$\begin{aligned} \partial_0 S &= (S \cap \mathbb{R}^3 \times \{0\}) \\ -\partial_1 S &= (S \cap \mathbb{R}^3 \times \{1\}) \end{aligned}$$

Note that $\partial_0 S$ and $\partial_1 S$ are oriented links in \mathbb{R}^3 .

The surface S can be represented by a sequence J of plane diagrams of oriented links where every two consecutive diagrams in J are related either by one of the Reidemeister moves I-IV (Section 4.1) or by one of the four moves depicted below (see [CS] where such representations by sequences of plane diagrams are studied in detail).

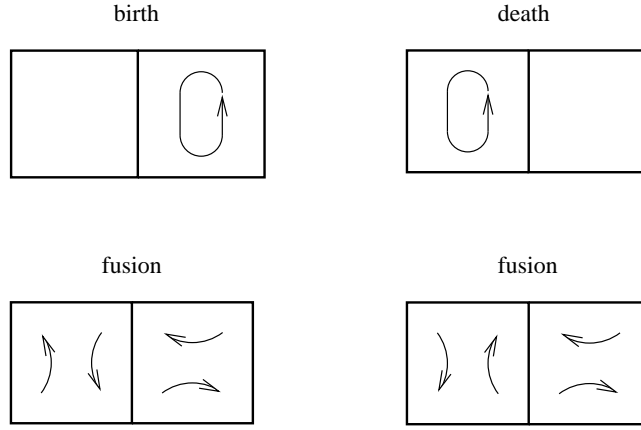

Following Carter-Saito [CS] and Fisher [Fs], we call these moves *birth*, *death*, *fusion* ([CS] and [Fs] deal with the non-oriented version of these moves). We call J a *representation of S* . The first diagram in the sequence J is necessarily a diagram of oriented link $\partial_0 S$, and the last diagram is a diagram of $\partial_1 S$.

The birth move consists of adding a simple closed curve to a diagram D . Denote the new diagram by D_1 . Then $C(D_1) = C(D) \otimes_R A$ and the unit map $\iota : R \rightarrow A$ of the algebra A induces a map of complexes $C(D) \rightarrow C(D_1)$. This is the map we associate to the birth move.

The death move consists of removing a simple circle from a diagram D_1 to get a diagram D . In this case the counit $\epsilon : A \rightarrow R$ induces a map of complexes $C(D_1) \rightarrow C(D)$.

Finally, to a fusion move between diagrams D_0 and D_1 we associate a map $C(D_0) \rightarrow C(D_1)$ corresponding to the elementary surface with one saddle point in the manner discussed in Section 4.3.

In Section 5 to each Reidemeister move between diagrams D_0 and D_1 we associated a quasi-isomorphism map of complexes $C(D_0) \rightarrow C(D_1)$.

Given a representation J of a surface S by a sequence of diagrams, denote the first and last diagrams of J by J_0 and J_1 respectively. Then to J we can associate a map of complexes

$$\varphi_J : C(J_0) \rightarrow C(J_1) \quad (147)$$

which is the composition of maps associated to elementary transformations between consecutive diagrams of J . The map φ_J induces a map of cohomology groups

$$\theta_J : H^{i,j}(J_0) \rightarrow H^{i,j+\chi(S)}(J_1), \quad i, j \in \mathbb{Z}. \quad (148)$$

We now ready to state our main conjecture.

Conjecture 1 *If two representations J, \tilde{J} of a surface S have the property that*

(a) diagrams J_0 and \tilde{J}_0 are isomorphic,

(b) diagrams J_1 and \tilde{J}_1 are isomorphic,

then the maps θ_J and $\theta_{\tilde{J}}$ are equal, up to an overall minus sign, $\theta_J = \pm\theta_{\tilde{J}}$.

In other words, we conjecture that, after a suitable \mathbb{Z}_2 extension of the link cobordism category, our construction associates honest cohomology groups $H^i(L)$ to oriented links L in \mathbb{R}^3 (and not just isomorphism classes of groups) and associates homomorphisms between these groups to isotopy classes of oriented surfaces embedded in $\mathbb{R}^3 \times [0, 1]$. In the categorical language, we expect to get a functor from the category of (\mathbb{Z}_2 -extended) oriented link cobordisms to the category of bigraded R -modules and module homomorphisms.

Suppose that the above conjecture is true. Then, in the case of a closed oriented surface S embedded in \mathbb{R}^4 , the map θ_S of cohomology groups is a homomorphism from R to itself (since $\partial S = \emptyset$ and the cohomology of the empty link is equal to the ground ring R). This homomorphism has degree $\chi(S)$ and is automatically 0 when $\chi(S) < 0$. Thus, the conjectural invariants are zero whenever S has empty boundary and the Euler characteristic of S is negative. If, again, $\partial S = \emptyset$ and the Euler characteristic of S is nonnegative (when S is connected, S is then necessarily a 2-sphere or a 2-torus), the homomorphism $\theta_S : R \rightarrow R$ is determined by $\theta_S(1) = kc^{\frac{\chi(S)}{2}}$ and amounts to an integer number k . Hence, we expect to have integer-valued invariants of closed oriented surfaces with non-negative Euler characteristic, embedded in \mathbb{R}^4 .

7 Setting c to 0

7.1 Cohomology groups $\mathcal{H}^{i,j}$

Setting $c = 0$ and taking \mathbb{Z} instead of $R = \mathbb{Z}[c]$ as the base ring, everything we did in Sections 2, 4 and 5 goes through in exactly the same manner. The role of the ring A will be played by the free graded abelian group \mathcal{A} of rank 2 with generators $\mathbf{1}$ and X in degrees 1 and -1 correspondingly. \mathcal{A} has commutative algebra and cocommutative coalgebra structures:

$$\mathbf{1}^2 = \mathbf{1}, \quad \mathbf{1}X = X\mathbf{1} = X, \quad X^2 = 0 \quad (149)$$

$$\Delta(\mathbf{1}) = \mathbf{1} \otimes X + X \otimes \mathbf{1}, \quad \Delta(X) = X \otimes X \quad (150)$$

and the identity (16) holds. By abuse of notations, we use m and Δ to denote multiplication and comultiplication in \mathcal{A} . Earlier m and Δ were used to denote multiplication and comultiplication in A . As in Section 2.3, we construct a functor \mathcal{F} from the category \mathcal{M} of closed one-manifolds and cobordisms between them to the category of graded abelian groups and graded homomorphisms. To a disjoint union of k circles functor \mathcal{F} assigns the group $\mathcal{A}^{\otimes k}$. To elementary surfaces $S_2^1, S_1^2, S_0^1, S_1^0, S_2^2$ and S_1^1 (see Section 2.3) functor \mathcal{F} assigns maps $m, \Delta, \iota, \epsilon, \text{Perm}$ and Id between suitable tensor powers of \mathcal{A} . The maps $\iota : \mathbb{Z} \rightarrow \mathcal{A}$ and $\epsilon : \mathcal{A} \rightarrow \mathbb{Z}$ are given by

$$\iota(\mathbf{1}) = \mathbf{1}, \quad \epsilon(\mathbf{1}) = 0, \quad \epsilon(X) = 1, \quad (151)$$

while Perm is just the permutation map $\mathcal{A} \otimes \mathcal{A} \rightarrow \mathcal{A} \otimes \mathcal{A}$.

To a diagram D of an oriented link L we can then associate a commutative \mathcal{I} -cube \mathcal{V}_D of graded abelian groups and grading-preserving homomorphism, by the same procedure as the one described in Section 4.2, using the functor \mathcal{F} instead of F . In particular, for $\mathcal{L} \subset \mathcal{I}$ we have $\mathcal{V}_D(\mathcal{L}) = \mathcal{F}(D(\mathcal{L}))\{-|\mathcal{L}|\}$ where $\{k\}$ shifts the grading down by k .

Let \mathcal{AB} be the category of graded abelian groups and grading-preserving homomorphisms. Let $\mathcal{E}_{\mathcal{I}}$ be the skew-commutative \mathcal{I} -cube $E_{\mathcal{I}} \otimes_R \mathbb{Z}$ over \mathcal{AB} .

Tensoring \mathcal{V}_D with $\mathcal{E}_{\mathcal{I}}$ over \mathbb{Z} , we get a skew commutative \mathcal{I} -cube $\mathcal{V}_D \otimes \mathcal{E}_{\mathcal{I}}$ over the category \mathcal{AB} . From this skew-commutative \mathcal{I} -cube we get a complex $\overline{\mathcal{C}}(\mathcal{V}_D \otimes \mathcal{E}_{\mathcal{I}})$ of graded abelian groups with a grading-preserving differential (Section 3.4). Denote this complex by $\overline{\mathcal{C}}(D)$ and by $\mathcal{C}(D)$ the shifted complex

$$\mathcal{C}(D) = \overline{\mathcal{C}}(D)[x(D)]\{2x(D) - y(D)\} \quad (152)$$

If we consider \mathbb{Z} as a graded R -module, concentrated in degree 0, so that $c\mathbb{Z} = 0$, then

$$\overline{\mathcal{C}}(D) = \overline{\mathcal{C}}(D) \otimes_R \mathbb{Z} \quad \text{and} \quad \mathcal{C}(D) = C(D) \otimes_R \mathbb{Z}. \quad (153)$$

To a plane diagram D of an oriented link L we thus associate a complex of graded abelian groups $\mathcal{C}(D)$. Denote the i -th cohomology group of the j -th graded summand of $\mathcal{C}(D)$ by $\mathcal{H}^{i,j}(D)$. These cohomology groups are finitely-generated abelian groups. For each diagram D as we vary i and j over all integers, only a finite number of these groups are non-zero.

Theorem 2 *For an oriented link L , isomorphism classes of abelian groups $\mathcal{H}^{i,j}(D)$ do not depend on the choice of a diagram D of L and are invariants of L .*

Proof: Set $c = 0$ in the proof of Theorem 1. \square

For a diagram D of the link L , denote the isomorphism classes of $\mathcal{H}^{i,j}(D)$ by $\mathcal{H}^{i,j}(L)$.

Denote by $\overline{\mathcal{C}}^i(D)$ (respectively, $\mathcal{C}^i(D)$) the i -th group of the complex $\overline{\mathcal{C}}(D)$ (respectively, $\mathcal{C}(D)$) and by $\overline{\mathcal{C}}_j^i(D)$ (respectively, by $\mathcal{C}_j^i(D)$) the j -th graded component of $\overline{\mathcal{C}}^i(D)$ (respectively, $\mathcal{C}^i(D)$), so that $\overline{\mathcal{C}}^i(D) = \bigoplus_{j \in \mathbb{Z}} \overline{\mathcal{C}}_j^i(D)$, respectively, $\mathcal{C}^i(D) = \bigoplus_{j \in \mathbb{Z}} \mathcal{C}_j^i(D)$. For an diagram D denote by $\mathcal{H}^i(D)$ the graded abelian group $\bigoplus_{j \in \mathbb{Z}} \mathcal{H}^{i,j}(D)$. In other words, $\mathcal{H}^i(D)$ is the i -th cohomology group of $\mathcal{C}(D)$. Denote by $\overline{\mathcal{H}}^i(D)$ the i -th cohomology group of the complex $\overline{\mathcal{C}}(D)$ and by $\overline{\mathcal{H}}^{i,j}(D)$ the j -th graded component of $\overline{\mathcal{H}}^i(D)$, so that $\overline{\mathcal{H}}^i(D) = \bigoplus_{j \in \mathbb{Z}} \overline{\mathcal{H}}^{i,j}(D)$.

7.2 Properties of $\mathcal{H}^{i,j}$: Euler characteristic, change of orientation

The Kauffman bracket of an oriented link L is equal to the graded Euler characteristic of the cohomology groups $\mathcal{H}^{i,j}(L)$, as stated in the following proposition.

Proposition 27 *For an oriented link L ,*

$$K(L) = \sum_{i,j \in \mathbb{Z}} (-1)^i q^j \dim_{\mathbb{Q}}(\mathcal{H}^{i,j}(L) \otimes \mathbb{Q}), \quad (154)$$

where $K(L)$ is the scaled Kauffman bracket (see Section 2.4).

The proof is completely analogous to that of formula (47). \square

The statements and proofs of Propositions 22-24 transfer without change to the case of cohomology groups $\mathcal{H}^{i,j}$, as indicated below.

Let L be an oriented link and L' a component of L . Denote by l the linking number of L' with its complement $L \setminus L'$ in L . Let L_0 be the link L with the orientation of L' reversed.

Proposition 28 *For $i, j \in \mathbb{Z}$ there is an equality of isomorphism classes of abelian groups*

$$\mathcal{H}^{i,j}(L_0) = \mathcal{H}^{i+2l,j+2l}(L). \quad (155)$$

Proposition 29 *Let K and K_1 be oriented knots and $(-K)$ be K with the reversed orientation. Then*

$$\mathcal{H}^{i,j}(K \# K_1) = \mathcal{H}^{i,j}((-K) \# K_1) \quad (156)$$

Similarly to Proposition 24 we can prove

Proposition 30 *For an oriented link L*

$$\mathcal{H}^{i,j}(L) = 0 \quad (157)$$

if $j + 1 \equiv \text{cm}(L) \pmod{2}$.

7.3 Cohomology of the mirror image

Let L be an oriented link and denote by $L^!$ the mirror image of L . Let D be a diagram of L with n crossings, \mathcal{I} the set of these crossings, and $D^!$ the corresponding diagram of $L^!$:

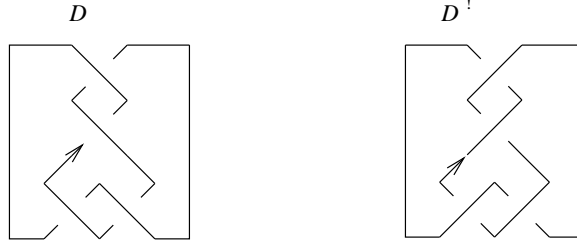

If M is a graded abelian group, $M = \bigoplus_{j \in \mathbb{Z}} M_j$, define the dual graded abelian group M^* by $(M^*)_j = \text{Hom}(M_{-j}, \mathbb{Z})$. The dual map $f^* : N^* \rightarrow M^*$ of a map $f : M \rightarrow N$ is defined as the dual of f in the sense of linear algebra.

For $\mathcal{L} \subset \mathcal{I}$ denote by $\tilde{\mathcal{L}}$ the complement $\mathcal{I} \setminus \mathcal{L}$.

Let \mathcal{V} be a commutative \mathcal{I} -cube over the category \mathcal{AB} of graded abelian groups and grading-preserving homomorphisms. Define the dual cube \mathcal{V}^* by

$$\mathcal{V}^*(\mathcal{L}) = (\mathcal{V}(\tilde{\mathcal{L}}))^* \quad (158)$$

and the structure map

$$\xi_a^{\mathcal{V}^*} : \mathcal{V}^*(\mathcal{L}) \longrightarrow \mathcal{V}^*(\mathcal{L}a) \quad (159)$$

of \mathcal{V}^* being the dual of the structure map

$$\xi_a^{\mathcal{V}} : \mathcal{V}(\tilde{\mathcal{L}} \setminus a) \longrightarrow \mathcal{V}(\tilde{\mathcal{L}}) \quad (160)$$

of \mathcal{V} .

Denote by $\{s\}$ the automorphism of the category \mathcal{AB} that shifts the grading down by s . If \mathcal{V} is a commutative \mathcal{I} -cube over \mathcal{AB} , denote by $\mathcal{V}\{s\}$ the commutative \mathcal{I} -cube \mathcal{V} with the grading of each group $\mathcal{V}(\mathcal{L})$ shifted down by s .

Proposition 31 *Let D be a diagram with n crossings and $D^!$ the dual diagram (see above). Then the commutative \mathcal{I} -cube $\mathcal{V}_{D^!}\{-n\}$ is isomorphic to the dual $(\mathcal{V}_D)^*$ of the \mathcal{I} -cube \mathcal{V}_D .*

Proof: Introduce a basis $\{\mathbf{1}^*, X^*\}$ in the abelian group $\mathcal{A}^* = \text{Hom}(\mathcal{A}, \mathbb{Z})$ by

$$\mathbf{1}^*(\mathbf{1}) = 0, \mathbf{1}^*(X) = 1, X^*(\mathbf{1}) = 1, X^*(X) = 0 \quad (161)$$

Denote by m^*, Δ^* maps dual to Δ and m respectively:

$$\begin{aligned} m^* & : \mathcal{A}^* \otimes \mathcal{A}^* \longrightarrow \mathcal{A}^* \\ \Delta^* & : \mathcal{A}^* \longrightarrow \mathcal{A}^* \otimes \mathcal{A}^* \end{aligned}$$

Then, in the basis $\{\mathbf{1}^*, X^*\}$ these maps are

$$\begin{aligned} m^*(\mathbf{1}^* \otimes X^*) &= m^*(X^* \otimes \mathbf{1}^*) = X^* \\ m^*(\mathbf{1}^* \otimes \mathbf{1}^*) &= \mathbf{1}^* \\ m^*(X^* \otimes X^*) &= 0 \\ \Delta^*(\mathbf{1}^*) &= \mathbf{1}^* \otimes X^* + X^* \otimes \mathbf{1}^* \\ \Delta^*(X^*) &= X^* \otimes X^* \end{aligned}$$

Hence, under the isomorphism $\mu : \mathcal{A} \rightarrow \mathcal{A}^*$ of graded abelian groups, given by $\mu(\mathbf{1}) = \mathbf{1}^*$ and $\mu(X) = X^*$, maps m, Δ become m^*, Δ^* .

Note that the $\tilde{\mathcal{L}}$ -resolution $D(\tilde{\mathcal{L}})$ of diagram D and the \mathcal{L} -resolution $D^!(\mathcal{L})$ of $D^!$ are isomorphic. Let k be the number of circles in $D(\tilde{\mathcal{L}})$. Then

$$\mathcal{F}(D(\tilde{\mathcal{L}})) = \mathcal{F}(D^!(\mathcal{L})) = \mathcal{A}^{\otimes k} \quad (162)$$

and, via μ , we can identify

$$\mathcal{F}(D(\tilde{\mathcal{L}})) = (\mathcal{A}^*)^{\otimes k} = (\mathcal{F}(D^!(\mathcal{L})))^* \quad (163)$$

Since μ maps m, Δ to m^*, Δ^* , we see that after suitable shifts (recall that $\mathcal{V}_D(\mathcal{L})$ is equal to $\mathcal{F}(D(\mathcal{L}))$ shifted up by $|\mathcal{L}|$) the identification (163) extends to an isomorphism of \mathcal{I} -cubes $\mathcal{V}_{D^!}\{-n\}$ and $(\mathcal{V}_D)^*$.

□

Given a complex C of graded abelian groups and grading-preserving homomorphisms

$$\dots \longrightarrow C^i \xrightarrow{d^i} C^{i+1} \longrightarrow \dots \quad (164)$$

define the dual complex C^* by $(C^*)^i = (C^{-i})^*$ and the differential $(d^*)^i$ being the dual of the differential d^{-i-1} of C .

From the last proposition we easily obtain

Proposition 32 *The complex $\mathcal{C}(D^!)$ is isomorphic to the dual of the complex $\mathcal{C}(D)$.*

This implies

Corollary 11 *For an oriented link L and integers i, j there are equalities of isomorphism classes of abelian groups*

$$\mathcal{H}^{i,j}(L^!) \otimes \mathbb{Q} = \mathcal{H}^{-i,-j}(L) \otimes \mathbb{Q} \quad (165)$$

$$\text{Tor}(\mathcal{H}^{i,j}(L^!)) = \text{Tor}(\mathcal{H}^{1-i,-j}(L)) \quad (166)$$

where Tor stands for the torsion subgroup.

Note that this corollary provides a necessary condition for a link to be amphicheiral.

7.4 Cohomology of the disjoint union and connected sum of knots

Pick diagrams D_1, D_2 of oriented links L_1, L_2 and consider a diagram $D_1 \sqcup D_2$ of the disjoint union $L_1 \sqcup L_2$. We then have an isomorphism of cochain complexes

$$\mathcal{C}(D_1 \sqcup D_2) = \mathcal{C}(D_1) \otimes \mathcal{C}(D_2) \quad (167)$$

of free graded abelian groups. From the Künneth formula we derive

Proposition 33 *There is a short split exact sequence of cohomology groups*

$$\begin{aligned} 0 &\rightarrow \bigoplus_{i,j \in \mathbb{Z}} (\mathcal{H}^{i,j}(D_1) \otimes \mathcal{H}^{k-i,m-j}(D_2)) \rightarrow \mathcal{H}^{k,m}(D_1 \sqcup D_2) \rightarrow \\ &\rightarrow \bigoplus_{i,j \in \mathbb{Z}} \text{Tor}_1^{\mathbb{Z}}(\mathcal{H}^{i,j}(D_1), \mathcal{H}^{k-i+1,m-j}(D_2)) \rightarrow 0 \end{aligned}$$

Corollary 12 *For each $k, m \in \mathbb{Z}$ there is an equality of isomorphism classes of abelian groups*

$$\begin{aligned} \mathcal{H}^{k,m}(L_1 \sqcup L_2) = & \bigoplus_{i,j \in \mathbb{Z}} (\mathcal{H}^{i,j}(L_1) \otimes \mathcal{H}^{k-i,m-j}(L_2)) \oplus \\ & \bigoplus_{i,j \in \mathbb{Z}} \text{Tor}_1^{\mathbb{Z}}(\mathcal{H}^{i,j}(L_1), \mathcal{H}^{k-i+1,m-j}(L_2)) \end{aligned}$$

Let D_1, D_2 be diagrams of oriented knots K_1, K_2 . We picture D_1 and D_2 schematically as

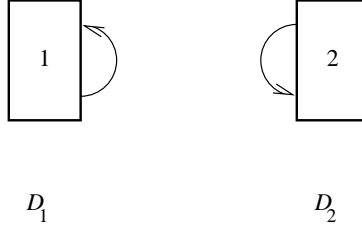

Consider diagrams D_3, D_4 and D_5 , depicted below, of oriented links $K_1 \sqcup K_2$, $K_1 \# K_2$, and $K_1 \# (-K_2)$:

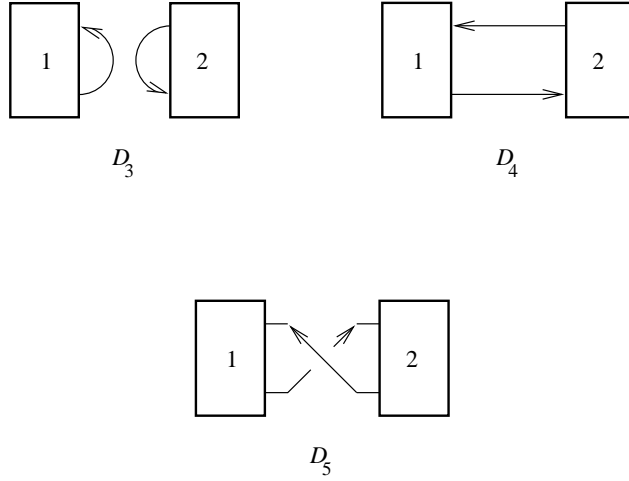

By resolving the central double point of D_5 , we get a short exact sequence of complexes of graded abelian groups

$$0 \longrightarrow \bar{\mathcal{C}}(D_3)[-1]\{-1\} \longrightarrow \bar{\mathcal{C}}(D_5) \longrightarrow \bar{\mathcal{C}}(D_4) \longrightarrow 0 \quad (168)$$

After shifts, we obtain an exact sequence

$$0 \longrightarrow \mathcal{C}(D_3)[-1]\{-1\} \longrightarrow \mathcal{C}(D_5)[-1]\{-2\} \longrightarrow \mathcal{C}(D_4) \longrightarrow 0 \quad (169)$$

which induces, for every integer j , a long exact sequence of cohomology groups

$$\begin{aligned} \dots &\rightarrow \mathcal{H}^{i-1, j-1}(D_3) \rightarrow \mathcal{H}^{i-1, j-2}(D_5) \rightarrow \mathcal{H}^{i, j}(D_4) \rightarrow \\ &\rightarrow \mathcal{H}^{i, j-1}(D_3) \rightarrow \mathcal{H}^{i, j-2}(D_5) \rightarrow \mathcal{H}^{i+1, j}(D_4) \rightarrow \dots \end{aligned} \quad (170)$$

Since the diagrams D_3, D_4 and D_5 represent oriented links $K_1 \sqcup K_2, K_1 \# K_2$ and $K_1 \# (-K_2)$, respectively, then in view of Proposition 29, we obtain

Proposition 34 *For oriented knots K_1, K_2 , the isomorphism classes of the abelian groups $\mathcal{H}^{i, j}(K_1 \sqcup K_2), \mathcal{H}^{i, j}(K_1 \# K_2)$ can be arranged into long exact sequences*

$$\begin{aligned} &\rightarrow \mathcal{H}^{i-1, j-1}(K_1 \sqcup K_2) \rightarrow \mathcal{H}^{i-1, j-2}(K_1 \# K_2) \rightarrow \mathcal{H}^{i, j}(K_1 \# K_2) \rightarrow \\ &\rightarrow \mathcal{H}^{i, j-1}(K_1 \sqcup K_2) \rightarrow \mathcal{H}^{i, j-2}(K_1 \# K_2) \rightarrow \mathcal{H}^{i+1, j}(K_1 \# K_2) \rightarrow \end{aligned} \quad (171)$$

7.5 A spectral sequence

Let D be an plane diagram of a link. In this section we construct a spectral sequence whose E_1 -term is made of groups $\mathcal{H}^{i,j}(D)$ and which converges to cohomology groups $H^{i,j}(D)$.

Due to the direct sum decomposition $R = \bigoplus_{k \geq 0} c^k \mathbb{Z}$ of abelian groups, we have an abelian group decomposition

$$C_j^i(D) = \bigoplus_{k \geq 0} C_{j-2k}^i(D) \quad (172)$$

where, recall, $C_j^i(D)$ and $\mathcal{C}_j^i(D)$ were defined in Sections 4.2 and 7.1 respectively. Let us fix a $j \in \mathbb{Z}$. Denote by d the differential in the weight j subcomplex of the complex $C(D)$:

$$\dots \xrightarrow{d} C_j^{i-1}(D) \xrightarrow{d} C_j^i(D) \xrightarrow{d} C_j^{i+1}(D) \xrightarrow{d} \dots \quad (173)$$

and by ∂ the differential in the complex

$$\dots \xrightarrow{\partial} \mathcal{C}_{j-2k}^{i-1}(D) \xrightarrow{\partial} \mathcal{C}_{j-2k}^i(D) \xrightarrow{\partial} \mathcal{C}_{j-2k}^{i+1}(D) \xrightarrow{\partial} \dots \quad (174)$$

where we suppress the dependence of ∂ on k . Under the identification (172) differential d becomes a differential of the complex

$$\dots \xrightarrow{d} \bigoplus_{k \geq 0} C_{j-2k}^i(D) \xrightarrow{d} \bigoplus_{k \geq 0} C_{j-2k}^{i+1}(D) \xrightarrow{d} \dots \quad (175)$$

Consider a bigraded abelian group

$$C = \bigoplus_{k \geq 0, i \in \mathbb{Z}} C_{j-2k}^i(D) \quad (176)$$

where we set the grading of $C_{j-2k}^i(D)$ to $(i, -k)$. We thus have a bigraded abelian group C and two maps, d and ∂ , from C to C . Map ∂ is bigraded of degree $(1, 0)$ while d is only graded relative to the first grading. However, we can decompose

$$d = \partial + \tilde{\partial} \quad (177)$$

where $\tilde{\partial}$ has grading $(1, -1)$ and satisfies

$$\tilde{\partial}\tilde{\partial} = 0, \quad (178)$$

$$\partial\tilde{\partial} + \tilde{\partial}\partial = 0 \quad (179)$$

Besides, since ∂ is a differential, $\partial\partial = 0$. Therefore, $H^{i,j}(D)$ is equal to the i -th cohomology group of the total complex of the bicomplex $(C, \partial, \tilde{\partial})$. Group $\mathcal{H}^{s,j-2k}(D)$ is equal to the s -th cohomology group of the subcomplex (relative to the differential ∂)

$$\dots \xrightarrow{\partial} C^{i-1,j-2k}(D) \xrightarrow{\partial} C^{i,j-2k}(D) \xrightarrow{\partial} C^{i+1,j-2k}(D) \xrightarrow{\partial} \dots \quad (180)$$

of C . Therefore, for each $j \in \mathbb{Z}$ we get a spectral sequence whose E_1 -term is given by cohomology groups $\mathcal{H}^{s,j-2k}(D)$, $s \in \mathbb{Z}, k \geq 0$ and which converges to cohomology groups $H^{i,j}(D)$. In the few cases where we managed to compute cohomology groups, we have $H^{i,j}(D) = \bigoplus_{k \geq 0} \mathcal{H}^{i,j-2k}(D)$ and, consequently, the spectral sequence degenerates at E_1 . We have no idea whether this is true for any diagram D .

7.6 Examples

Perhaps the graded groups $\mathcal{H}^i(D)$ are easier to compute than $H^i(D)$. The latter are computed via the complex $C(D)$ of free graded R -modules, and a complex for $\mathcal{H}^i(D)$ is obtained by tensoring $C(D)$ with \mathbb{Z} over R , so that free graded R -modules become free abelian groups of the same rank. In practice, the computation of $\mathcal{H}^i(D)$ faces the problem of effectively simplifying complexes of abelian groups of exponentially high rank. The shortcut for the computation of $H^i(D)$ described in Section 6.2 works equally well for groups $\mathcal{H}^i(D)$, with Proposition 25 generalized to complexes $\overline{C}(D)$. This easily leads to a computation of cohomology groups $\mathcal{H}^{i,j}(T_{2,k})$ of the $(2, k)$ torus link $T_{2,k}$, oriented as in Section 6.2.

Proposition 35 Cohomology groups $\mathcal{H}^{i,j}(T_{2,k}), k > 1$ are isomorphic to

$$\begin{aligned}
\mathcal{H}^{0,-k}(T_{2,k}) &= \mathbb{Z}, \\
\mathcal{H}^{0,2-k}(T_{2,k}) &= \mathbb{Z}, \\
\mathcal{H}^{-2j-1,-4j-2-k}(T_{2,k}) &= \mathbb{Z} \quad \text{for } 1 \leq j \leq \frac{k-1}{2}, j \in \mathbb{Z}, \\
\mathcal{H}^{-2j,-4j-k}(T_{2,k}) &= \mathbb{Z}_2 \quad \text{for } 1 \leq j \leq \frac{k-1}{2}, j \in \mathbb{Z}, \\
\mathcal{H}^{-2j,-4j+2-k}(T_{2,k}) &= \mathbb{Z} \quad \text{for } 1 \leq j \leq \frac{k-1}{2}, j \in \mathbb{Z}, \\
\mathcal{H}^{-k,-3k}(T_{2,k}) &= \mathbb{Z} \quad \text{for even } k, \\
\mathcal{H}^{-k,2-3k}(T_{2,k}) &= \mathbb{Z} \quad \text{for even } k, \\
\mathcal{H}^{i,j}(T_{2,k}) &= 0 \quad \text{for all other values of } i \text{ and } j
\end{aligned}$$

7.7 An application to the crossing number

Definition 3 A plane diagram D with the set \mathcal{I} of double points is called *+adequate* if for each double point a the diagram $D(\mathcal{I} \setminus \{a\})$ has one circle less than $D(\mathcal{I})$.

Definition 4 A plane diagram D with the set \mathcal{I} of double points is called *-adequate* if for each double point a the diagram $D(\{a\})$ has one circle less than $D(\emptyset)$.

Definition 5 A plane diagram D is called *adequate* if it is both *+* and *-adequate*.

These definitions are from [LT] and [T].

Proposition 36 Let D be a diagram with n crossings. Then $\overline{\mathcal{H}}^0(D) \neq 0$ if and only if D is *-adequate* and $\overline{\mathcal{H}}^n(D) \neq 0$ if and only if D is *+adequate*.

Proof: The differential $\partial^0 : \overline{\mathcal{C}}^0(D) \rightarrow \overline{\mathcal{C}}^1(D)$ is not injective and, hence, $\overline{\mathcal{H}}^0(D) \neq 0$ if and only if D is *-adequate*. Similarly for $\overline{\mathcal{H}}^n(D)$ and *+adequate* diagrams (groups $\overline{\mathcal{H}}^i(D)$ were defined at the end of Section 7.1). \square

Definition 6 Homological length $\text{hl}(L)$ of an oriented link L is the difference between the maximal i such that $\mathcal{H}^i(L) \neq 0$ and the minimal i such that $\mathcal{H}^i(L) \neq 0$.

Denote by $c(L)$ the crossing number of L . It is the minimal number of crossings in a plane diagram of L .

Proposition 37 For an oriented link L

$$c(L) \geq \text{hl}(L) \tag{181}$$

Proof: Let D be a diagram of L with $c(L)$ crossings. Then $\overline{\mathcal{C}}^i(D) = 0$ for $i < 0$ and for $i > \text{hl}(L)$. Consequently, $\overline{\mathcal{H}}^i(D) = 0$ for $i < 0$ and $i > \text{hl}(L)$. \square

Corollary 13 Let D be an adequate diagram with n crossings of a link L . Then $c(L) = n$.

Proof: By Proposition 36 $\overline{\mathcal{H}}^0(D) \neq 0$ and $\overline{\mathcal{H}}^n(D) \neq 0$. Therefore, $c(L) \geq \text{hl}(L) \geq n$. But since D is an n -crossing diagram of L , the crossing number of L is n . \square

Corollary 13 was originally obtained by Thistlethwaite (Corollary 3.4 of [T]) through the analysis of the 2-variable Kauffman polynomial (not to be confused with the Kauffman bracket).

8 Invariants of $(1, 1)$ -tangles

8.1 Graded A -modules

Recall that in Section 2.2 we defined algebra A as a free module of rank 2 over the ring $R = \mathbb{Z}[c]$, generated by $\mathbf{1}$ and X , with the multiplication rules

$$\mathbf{1}\mathbf{1} = \mathbf{1}, \quad \mathbf{1}X = X\mathbf{1} = X, \quad X^2 = 0. \quad (182)$$

Gradings of $\mathbf{1}$ and X are equal to 1 and -1 , respectively, so that the multiplication in A is a graded map of degree -1 .

Definition 7 A graded A -module M is a \mathbb{Z} -graded abelian group $M = \bigoplus_{i \in \mathbb{Z}} M_i$, together with group homomorphisms

$$X : M_i \longrightarrow M_{i-2}, \quad i \in \mathbb{Z}, \quad (183)$$

$$c : M_i \longrightarrow M_{i+2}, \quad i \in \mathbb{Z}, \quad (184)$$

that satisfy relations

$$Xc = cX \quad \text{and} \quad X^2 = 0. \quad (185)$$

Definition 8 A homomorphism of graded A -modules M and N is a grading-preserving homomorphism of abelian groups $f : M \rightarrow N$ that intertwines the action of X and c in M and N :

$$Xf = fX, \quad cf = fc. \quad (186)$$

Denote by $A\text{-mod}_0$ the category with objects being graded A -modules and morphisms being grading-preserving homomorphisms of graded A -modules. Note that $A\text{-mod}_0$ is an abelian category. Denote by $\{n\}$ the automorphism of $A\text{-mod}$ that shifts the grading down by n . Let $A\text{-mod}$ be the category of graded A -modules and graded maps. $A\text{-mod}$ has the same objects as $A\text{-mod}_0$, but more morphisms.

Given a graded A -module M , define the multiplication map

$$m_M : A \otimes_R M \longrightarrow M \quad (187)$$

by

$$m_M(\mathbf{1} \otimes t) = t, \quad m_M(X \otimes t) = Xt, \quad t \in M. \quad (188)$$

The multiplication map m_M is a degree -1 map with the grading on $A \otimes_R M$ defined as the product grading of gradings of A and M .

To a graded A -module M associate a map

$$\Delta_M : M \longrightarrow A \otimes M \quad (189)$$

(recall that all tensor products are over $R = \mathbb{Z}[c]$) by

$$\Delta_M(t) = X \otimes t + \mathbf{1} \otimes Xt + cX \otimes Xt, \quad t \in M. \quad (190)$$

Then Δ_M equips M with the structure of a cocommutative comodule over A . Map Δ_M has degree -1 . The following relation between Δ_M and m_M is straightforward to check

$$\Delta_M m_M = (Id_A \otimes m_M)(\Delta \otimes Id_M) = (m \otimes Id_M)(Id_A \otimes \Delta_M) \quad (191)$$

Denote by ι_M the map $M \longrightarrow A \otimes M$ given by $\iota_M(t) = \mathbf{1} \otimes t$ for $t \in M$.

Introduce an A -module structure on $A^{\otimes n} \otimes M$ by

$$a(x \otimes y) = x \otimes ay \text{ for } a \in A, x \in A^{\otimes n}, y \in M, \quad (192)$$

where ay means $m_M(a \otimes y)$. Then m_M, Δ_M and ι_M , after appropriate shifts by $\{1\}$ or $\{-1\}$, are maps of graded A -modules.

Proposition 38 For any graded A -module M we have direct sum decompositions of $A \otimes M$, considered as a graded A -module

$$A \otimes M = \Delta_M M \oplus \iota_M M \quad (193)$$

$$A \otimes M = \iota_M M \oplus (\Delta_M - \iota_M m_M \Delta_M) M \quad (194)$$

$$A \otimes M = \Delta_M M \oplus (\iota_M - c \iota_M m_M \Delta_M) M \quad (195)$$

Proof: Let us check (194), for instance. We have a decomposition

$$A \otimes M = (\mathbf{1} \otimes M) \oplus (X \otimes M). \quad (196)$$

Denote by p the projection $A \otimes M \rightarrow X \otimes M$, orthogonal to $\mathbf{1} \otimes M$. Since $\iota_M M = \mathbf{1} \otimes M$, it suffices to check that

$$p(\Delta_M - \iota_M m_M \Delta_M) : M \rightarrow X \otimes M \quad (197)$$

is an A -module isomorphism. This map is given by

$$t \mapsto X \otimes (1 + cX)t, \quad \text{where } t \in M. \quad (198)$$

The inverse map is

$$X \otimes t \mapsto (1 - cX)t \quad (199)$$

Decompositions (193) and (195) can be verified analogously. \square .

8.2 Non-closed (1+1)-cobordisms

Let \mathcal{M}_1 be the category whose objects are one-dimensional manifolds that are unions of a finite number of circles and one interval. An ordering of the ends of this interval is fixed. Morphisms between objects α and β of \mathcal{M}_1 are oriented surfaces whose boundary is the union of α, β and 2 intervals that join corresponding ends of the intervals of α and β . An example is depicted below.

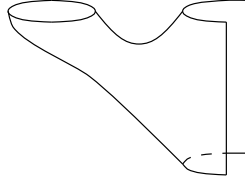

This surface represents a morphism from an interval to a union of a circle and an interval. We require that a surface can be presented as a composition of disjoint unions of surfaces $S_2^1, S_1^2, S_0^1, S_1^0, S_2^2, S_1^1$, defined in Section 2.3, and surfaces T_1, T_2 , depicted below



We compose morphisms in this category by concatenating surfaces.

Category \mathcal{M}_1 is a module-category over \mathcal{M} , defined in Section 2.3. The bifunctor $\mathcal{M} \otimes \mathcal{M}_1 \rightarrow \mathcal{M}_1$ is defined on objects and morphisms by taking disjoint unions.

Recall from the previous section that $A\text{-mod}$ denotes the category of graded A -modules and graded homomorphisms. Given a graded A -module M , define a monoidal functor

$$F_M : \mathcal{M}_1 \rightarrow A\text{-mod}$$

by assigning the graded A -module $A^{\otimes n} \otimes M$ to a union of n circles and one interval, maps Δ_M and m_M (defined in the previous section) to the elementary surfaces T_1 and T_2 :

$$F_M(T_1) = \Delta_M, \quad F_M(T_2) = m_M. \quad (200)$$

To the other six elementary surfaces $S_2^1, S_1^2, S_0^1, S_1^0, S_2^2, S_1^1$ (Section 2.3) associate the same maps as for the functor F :

$$\begin{aligned} F_M(S_2^1) &= m, & F_M(S_1^2) &= \Delta, & F_M(S_0^1) &= \iota, \\ F_M(S_1^0) &= \epsilon, & F_M(S_2^2) &= \text{Perm}, & F_M(S_1^1) &= \text{Id}. \end{aligned} \quad (201)$$

8.3 (1, 1)-tangles

A $(1, 1)$ -tangle is a proper smooth embedding $e : T \hookrightarrow \mathbb{R}^2 \times [0, 1]$ of a finite collection T of circles and one interval $[0, 1]$ into $\mathbb{R}^2 \times [0, 1]$ such that the boundary points of $[0, 1]$ go to the corresponding boundary component of $\mathbb{R}^2 \times [0, 1]$:

$$e(0) \in \mathbb{R}^2 \times \{0\}, \quad e(1) \in \mathbb{R}^2 \times \{1\}. \quad (202)$$

Two $(1, 1)$ -tangles are called equivalent if they are isotopic via an isotopy that fixes the boundary. Oriented $(1, 1)$ -tangles are $(1, 1)$ -tangles with a chosen orientation of each component, orientation of $[0, 1]$ always chosen in the direction from 0 to 1.

Define a marked oriented link (in \mathbb{R}^3) as an oriented link with a marked component. Obviously, there is a natural one-to-one correspondence between marked oriented links and oriented $(1, 1)$ -tangles: the closure of a $(1, 1)$ -tangle is a marked oriented link. Denote this map from oriented $(1, 1)$ -tangles to oriented marked links by cl .

8.4 Invariants

A plane diagram D of an oriented $(1, 1)$ -tangle L is a generic projection of L onto $\mathbb{R} \times [0, 1]$.

If D is a plane diagram of an oriented $(1, 1)$ -tangle, define $x(D)$ and $y(D)$ in the same way as for plane diagrams of oriented links (see Section 2.4).

Fix a graded A -module M . Let n be the number of double points of D , so that $n = x(D) + y(D)$ and \mathcal{I} the set of double points of D . To M and D associate a commutative \mathcal{I} -cube V_D^M over the category $A\text{-mod}_0$ of graded A -modules as follows.

For $\mathcal{L} \subset \mathcal{I}$ the \mathcal{L} -resolution $D(\mathcal{L})$ of D consists of a disjoint union of circles and an interval. The functor F_M (see Section 8.2) assigns a graded A -module to $D(\mathcal{L})$. Define

$$V_D^M(\mathcal{L}) = F_M(D(\mathcal{L}))\{-|\mathcal{L}|\}. \quad (203)$$

Maps between $V_D^M(\mathcal{L})$ for various subsets \mathcal{L} are defined by the procedure completely analogous to the one described in Section 4.2. Due to shifts $\{-|\mathcal{L}|\}$, these maps of graded A -modules are grading-preserving, rather than just graded maps, so that V_D^M is a commutative cube over $A\text{-mod}_0$.

Example: For a diagram D , depicted below,



resolutions of D are



so that

$$\begin{aligned} V_D^M(\emptyset) &= A \otimes M \\ V_D^M(\mathcal{I}) &= M\{-1\} \end{aligned}$$

and the structure map $V_D^M(\emptyset) \rightarrow V_D^M(\mathcal{I})$ is the multiplication map $m_M : A \otimes M \rightarrow M\{-1\}$.

Next we transform the commutative \mathcal{I} -cube V_D^M into a skew commutative \mathcal{I} -cube by putting minus signs in front of some structure maps of V_D^M , or, equivalently, by tensoring it with $E_{\mathcal{I}}$. Denote by $\overline{C}_M(D)$ the complex $\overline{C}(V_D^M \otimes E_{\mathcal{I}})$ of graded A -modules. Define

$$C_M(D) = \overline{C}_M(D)[x(D)]\{y(D) - 2x(D)\} \quad (204)$$

Denote the i -th cohomology group of the complex $C_M(D)$ by $H^i(D, M)$. These cohomology groups are graded A -modules. Denote the j -th graded component of $H^i(D, M)$ by $H^{i,j}(D, M)$

Theorem 3 *For a graded A -module M , an oriented $(1, 1)$ -tangle L and a diagram D of L , isomorphism classes of graded A -modules $H^i(D, M)$ do not depend on the choice of D and are invariants of L .*

Our proof of Theorem 1 immediately generalizes without essential modifications to a proof of Theorem 3. Proposition 38 is used to establish direct sum decompositions of $C_M(D)$, analogous to decompositions of $C(D)$, for suitable D , given by Propositions 11, 14, 18.1, 21.1.

□

Cohomology groups $H^i(D)$, defined in Section 4.2, is a special case of groups $H^i(D, M)$, as the next proposition explains.

Proposition 39 *Let D be a diagram of an oriented $(1, 1)$ -tangle L and denote by $\text{cl}(D)$ the associated diagram of the marked oriented link $\text{cl}(L)$. Considering A as a graded A -module, we have a canonical isomorphism of cohomology groups (as graded R -modules)*

$$H^i(D, A) \cong H^i(\text{cl}(D)), \quad i \in \mathbb{Z}. \quad (205)$$

□

Given a finitely-generated graded A -module M , define the graded Euler characteristic $\widehat{\chi}(M)$ by

$$\widehat{\chi}(M) = \sum_{j \in \mathbb{Z}} \dim_{\mathbb{Q}}(M_j \otimes_{\mathbb{Z}} \mathbb{Q}) \quad (206)$$

Proposition 40 *Let M be a finitely-generated graded A -module, L an oriented $(1, 1)$ -tangle and D a diagram of L . Then*

$$\frac{K(\text{cl}(L))\widehat{\chi}(M)}{q + q^{-1}} = \sum_{i,j \in \mathbb{Z}} (-1)^i q^j \dim_{\mathbb{Q}}(H^{i,j}(D, M) \otimes_{\mathbb{Z}} \mathbb{Q}). \quad (207)$$

that is, the Kauffman bracket of $\text{cl}(L)$ is proportional to the Euler characteristic of groups $H^{i,j}(D, M)$.

□

Given two graded A -modules M, N and a grading-preserving homomorphism $f : M \rightarrow N$, it induces a map of commutative cubes $V_D^M \rightarrow V_D^N$, which, in turn, induces a map of complexes $C_M(D) \rightarrow C_N(D)$ and a map of cohomology groups $H^i(D, M) \rightarrow H^i(D, N)$. So, in fact, each diagram D of an oriented long link defines functors H_D^i from the category $A\text{-mod}_0$ of graded A -modules to itself, $H_D^i(M) = H^i(D, M)$. If two diagrams D_1, D_2 are related by a Reidemeister move, constructions of Section 5 extend to functor isomorphism $H_{D_1}^i \xrightarrow{\cong} H_{D_2}^i$. Let us frame this observation into a proposition.

Proposition 41 *For an oriented $(1, 1)$ -tangle L and a diagram D of L isomorphism classes of functors*

$$H_D^i : A\text{-mod}_0 \rightarrow A\text{-mod}_0 \quad (208)$$

do not depend on the choice of D and are invariants of L .

Oriented long links with one component correspond one-to-one to oriented knots in \mathbb{R}^3 . Thus, Proposition 41 gives invariants of oriented knots in \mathbb{R}^3 . Moreover, if a diagram D represents an oriented knot and D' is the diagram obtained from D by reversing the orientation of the underlying curve, there is a natural in M isomorphism $H^i(D, M) = H^i(D', M)$. Consequently, for knots, isomorphism classes of functors H_D^i do not depend on the orientation, and H_D^i provide “functor-valued” invariants of non-oriented knots. Of course, these invariants depend on how the ambient 3-space is oriented.

Let D be the 3-crossing diagram of the left-hand trefoil (knot $T_{2,3}$ in the notations of Section 6.2). The functors H_D^i are written below

$$\begin{aligned} H_D^{-3}(M) &= \ker 2X(M)\{8\}, \\ H_D^{-2}(M) &= (M/(2XM))\{6\}, \\ H_D^0(M) &= M\{2\}, \\ H_D^i(M) &= 0 \text{ for all other values of } i, \end{aligned}$$

where $\ker 2X(M) = \{t \in M \mid 2Xt = 0\}$.

References

- [AM] S.Akbulut, J.McCarthy, Casson’s invariant for oriented homology spheres – an exposition, *Princeton mathematical notes 36*, Princeton University Press, 1990.
- [BLM] A.A.Beilinson, G.Lusztig and R.MacPherson, A geometric setting for the quantum deformation of GL_n , *Duke Math. Jour.*, v.61, is. 2, (1990), 655-677.
- [BFK] J.Bernstein, I.Frenkel and M.Khovanov, A categorification of the Temperley-Lieb algebra and Schur quotients of $U(\mathfrak{sl}_2)$ by projective and Zuckerman functors, to appear in *Selecta Mathematica*.
- [CS] J.S.Carter, M.Saito, Reidemeister moves for surface isotopies and their interpretation as moves to movies, *J. of Knot Theory and its Ramifications*, v.2, n.3, 251–284, (1993).
- [CF] L.Crane, I.B.Frenkel, Four-dimensional topological quantum field theory, Hopf categories, and the canonical bases, *J. Math. Phys.*, v.35, n.10, 5136–5154, (1994).
- [FK] I.B.Frenkel, M.Khovanov, Canonical bases in tensor products and graphical calculus for $U_q(\mathfrak{sl}_2)$, *Duke Math. Jour.* v.87, (1997), 409-480.
- [Fs] J.Fischer, 2-categories and 2-knots, *Duke Math. Jour.* 75, (1994), no.2, 493–526.
- [F] A.Floer, An instanton-invariant for 3-manifolds, *Comm. Math. Phys.* v.118, no.2, 215–240, (1988).
- [GrL] I.Grojnowski, G.Lusztig, On bases of irreducible representations of quantum GL_n , in *Kazhdan-Lusztig theory and related topics (Chicago, IL, 1989)*, 167-174, Contemp.Math., 139.
- [JVV] F.Jaeger, D.L.Vertigan and D.J.A.Welsh, On the computational complexity of the Jones and Tutte polynomials, *Math. Proc. Camb. Phil. Soc.*, v.108, 35–53, (1990).
- [Jo] V.F.R.Jones, A polynomial invariant for knots via von Neumann algebras, *Bull. Amer. Math. Soc.*, vol.12, n.1, 103–111, (1985).
- [Ka] L.H.Kauffman, State models and the Jones polynomial, *Topology*, v.26, n.3, 395–407, (1987).
- [K] M.Khovanov, Graphical calculus, canonical bases and Kazhdan-Lusztig theory, *PhD Thesis*, Yale University, (1997).

- [LT] W.B.R.Lickorish, M.B.Thistlethwaite, Some links with nontrivial polynomials and their crossing-numbers, *Comment. Math. Helv.* 63, no.4, 527–539, (1988).
- [L] G.Lusztig, Introduction to Quantum Groups, Birkhauser Boston, 1993.
- [M] H.Murakami, Quantum $SU(2)$ -invariants dominate Casson's $SU(2)$ -invariant, *Math. Proc. Cambridge Phil. Soc.*, v.115, no.2, 253–281, (1994).
- [MT] G.Meng, C.H.Taubes, $SW = \text{Milnor torsion}$, *Math. Res. Lett.*, v.3, 661–674, (1996).
- [T] M.B.Thistlethwaite, On the Kauffman polynomial of an adequate link, *Invent. Math.* 93, no.2, 285–296, (1988).

INSTITUTE FOR ADVANCED STUDY, PRINCETON
E-mail address: mikhailk@math.ias.edu