

LOWER BOUNDS ON VOLUMES OF HYPERBOLIC HAKEN 3-MANIFOLDS

IAN AGOL

1. INTRODUCTION

In this paper, we find lower bounds for the volumes of certain hyperbolic Haken 3-manifolds. The theory of Jorgensen and Thurston shows that the volumes of hyperbolic 3-manifolds are well-ordered, but no one has been able to find the smallest one. The best known result for closed manifolds is that the smallest closed hyperbolic 3-manifold has volume > 0.16668 , proven by Gabai, Meyerhoff, and Thurston [11]. Their proof involves extensive rigorous computations. The smallest known closed 3-manifold is the Weeks manifold W , $Vol(W) \approx 0.94270$ [26], which is the 2-fold branched cover over the knot 9_{49} [24].

One could also ask for the smallest hyperbolic manifolds with certain characteristics. The smallest non-compact, disoriented hyperbolic 3-manifold is the Gieseking manifold, which is double covered by the figure eight knot complement, proven by Colin Adams [1]. Its volume $= V_3 \approx 1.01494$, since it is obtained by pairwise gluing the faces of the regular ideal tetrahedron in \mathbb{H}^3 , which has this volume. A recent result of Cao and Meyerhoff [4] shows that the smallest oriented noncompact hyperbolic 3-manifolds are the figure-eight knot complement and its sister manifold, which have volume $2V_3 \approx 2.03$. Kojima and Miyamoto [16, 17] have found the smallest hyperbolic 3-manifolds with totally geodesic boundary, which include Thurston's tripos manifold [22]. Culler and Shalen have a series of papers deriving lower bounds for volumes of closed hyperbolic 3-manifolds M , where $\dim(H_1(M; \mathbb{Q})) = \beta_1(M) \geq 1$. They found $Vol(M) > .34$, where one excludes "fibroids" if $\beta_1(M) = 1$ [7, 8]. Culler, Shalen, and Hersonsky showed that if $\beta_1(M) \geq 3$, then $Vol(M) \geq .94689 > Vol(W)$, which shows that the smallest volume 3-manifold must have $\beta_1(M) \leq 2$ [6]. Joel Hass has shown that there is an upper bound to the genus of an acylindrical surface in terms of the volume of a manifold [13]. One consequence of our results is that if $\beta_1(M) = 2$ or $\beta_1(M) = 1$ and M is not fibred over S^1 , then $Vol(M) \geq \frac{4}{5}V_3$. If M contains an acylindrical surface S , then $Vol(M) \geq -2V_3\chi(S)$.

Section 2 gives the necessary definitions and the statement of the main theorem. Section 3 gives some examples. Sections 4-6 are devoted to the proof of the main theorem. Sections 7-9 give applications of the main theorem.

Acknowledgements: We thank Daryl Cooper, Mike Freedman, Darren Long, Pat Shanahan, and Bill Thurston for helpful conversations.

2. DEFINITIONS AND STATEMENT OF THE MAIN THEOREM

We will assume that all 3-manifolds are orientable, and usually will be homeomorphic to a compact manifold with some subsurface of the boundary removed. A properly embedded

incompressible surface S in M^3 is a two-sided surface for which the fundamental group injects (excluding S^2). A manifold is *irreducible* if every embedded S^2 bounds a ball. An irreducible manifold with an incompressible surface is called *Haken*. It is *hyperbolic* if it has a complete riemannian metric of constant sectional curvature -1 , or equivalently, its universal cover is isometric to hyperbolic space \mathbb{H}^3 . If the manifold has boundary, then it is hyperbolic with totally geodesic boundary if the metric is locally modelled on a close half-space in \mathbb{H}^3 bounded by a geodesic plane.

The Thurston norm of a connected surface S is $\max\{-\chi(S), 0\}$, and extends to disconnected surfaces by summing over the components. An oriented surface which represents a non-trivial homology class in $H_2(M; \mathbb{Q})$ is Thurston norm-minimizing if it is has minimal Thurston norm over all surfaces in the same homology class. The norm on the sublattice represented by embedded surfaces extends by linearity to all of $H_2(M; \mathbb{Q})$. Thurston showed that for a hyperbolic 3-manifold, this norm on homology is indeed a norm [23]. Also, if $\beta_2(M) \geq 2$, he showed that there is some homology class with a surface which is not a fiber over S^1 .

M is *atoroidal* if any π_1 -injective mapping of a torus into M is homotopic into ∂M . A *pared acylindrical manifold* is a pair (M, P) where

- M is a compact, irreducible, atoroidal 3-manifold,
- $P \subset \partial M$ is a union of incompressible annuli and tori, such that every map $(S^1 \times I, S^1 \times \partial I) \rightarrow (M, \partial M - P)$ that is π_1 -injective deforms as a map of pairs into P .

P is called the parabolic locus of the pared manifold (M, P) . Let $\partial_0 M = \partial M - P$. A theorem of Thurston shows that if (M, P) is pared acylindrical, and M is not a torus or a ball, then $M \setminus P$ has a hyperbolic metric with totally geodesic boundary $\partial_0 M$ [18].

An *I - bundle* pair is a pair $(I - bundle, \partial I - bundle)$ over a surface. Let M be an irreducible 3-manifold, and let $Q \subset \partial M$ be an incompressible surface. There is a sub-pair $(\Sigma, S) \subset (M, Q)$ called the *characteristic sub-pair* of (M, Q) [15, 18]. It is uniquely determined up to isotopy of pairs by the following conditions:

- Each component of (Σ, S) either is an $(I - bundle, \partial I - bundle)$ -pair or has a Seifert fibration structure in which S is a union of fibers in the boundary.
- The components of $\partial_1 \Sigma = \partial \Sigma \setminus \text{int } S$ are essential annuli and tori in (M, Q) . Each is either a component of $\partial M \setminus \text{int } Q$ or is not parallel into ∂M .
- No component of (Σ, S) is homotopic in (M, Q) into a distinct component.
- Any map of the torus or the annulus into (M, Q) , which is injective on the fundamental group and essential as a map of pairs, is homotopic as a map of pairs into (Σ, S) .

We will call the union of components consisting of *I - bundles* the *characteristic I-bundle*. If M is atoroidal, $P \subset \partial M$ consists of tori and annuli, and $(\Sigma, S) \subset (M, \partial_0 M)$ is the characteristic sub-pair, then $Guts(M, P) = (\overline{M \setminus \Sigma}, (\overline{M \setminus \Sigma}) \cap \Sigma)$ is a pared acylindrical manifold pair. If (M, P) is already pared acylindrical, then the characteristic sub-pair of $(M, \partial_0 M)$ is a product neighborhood of P , and $Guts(M, P)$ is homeomorphic to (M, P) . If $N = M \setminus P$, for some (M, P) , then we define $Guts(N) = Guts(M, P)$, *i.e.* the pared locus is implicit for such non-compact manifolds.

Theorem 2.1. *If M is a hyperbolic manifold containing an incompressible surface S , then $Vol(M) \geq -2V_3\chi(Guts(M \setminus \mathcal{N}(S)))$.*

In particular, if $M \setminus \mathcal{N}(S)$ is acylindrical, then $Vol(M) \geq -2V_3\chi(S)$.

We conjecture a sharper bound. If ∂N is acylindrical, let $Vol(N)$ be the volume of the components of N which have a hyperbolic metric with totally geodesic boundary.

Conjecture 2.2. If M is a hyperbolic manifold containing an incompressible surface S , then $Vol(M) \geq Vol(Guts(M \setminus \mathcal{N}(S)))$.

Let $V_{oct} \approx 3.66$ denote the volume of a regular ideal octahedron in \mathbb{H}^3 . Miyamoto showed that if M is hyperbolic with totally geodesic boundary, then $Vol(M) \geq -V_{oct}\chi(M)$, with equality holding only for manifolds made up of regular ideal octahedra, glued together in the pattern of an ideal triangulation [17]. Then conjecture 2.2 and Miyamoto’s result would imply that we could improve the constant in theorem 2.1 from $2V_3$ to V_{oct} .

3. EXAMPLES

Example 3.1. The manifold obtained by $(\frac{14}{3}, \frac{3}{2})$ filling on the Whitehead link is a Haken manifold of volume 2.2077. That this is Haken was shown by Nathan Dunfield (personal communication). He also found that +10 filling on the knot 5_2 is Haken and has volume 2.3627. These are the smallest volume closed Haken 3-manifolds that I know of. Conjecture 2.2 would imply that these manifolds have no incompressible surfaces S with $\chi(Guts(M \setminus \mathcal{N}(S))) < 0$.

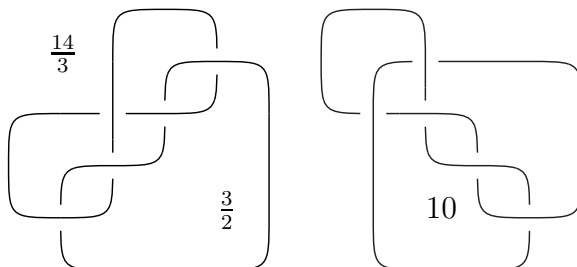

FIGURE 1. Dunfield’s small volume hyperbolic Haken 3-manifolds

Example 3.2. A manifold containing incompressible surfaces of unbounded genus can have bounded volume. For example, if $\beta_1(M) \geq 2$, then any primitive \mathbb{Z} -homology class is represented by a surface of minimal Thurston norm [23]. Since the image of $H_2(M; \mathbb{Z})$ in $H_2(M; \mathbb{R})$ is a lattice, there are primitive elements of unbounded norm, and therefore corresponding surfaces of unbounded genus.

Example 3.3. In section 8 we show that if a hyperbolic link complement contains an incompressible punctured sphere with meridian boundary components, then the volume is bounded below by $4V_3$. The smallest volume example that we know of (along with its mutant) is given in figure 2. There is a unique ideal triangulation of B^3 with one tetrahedron. The one-skeleton is a tangle in B^3 . Viewing a regular ideal octahedron as a truncated tetrahedron, we can glue it together according to the pattern of the triangulation to obtain a geometric structure on the tangle complement with boundary a geodesic 4-punctured sphere. The double gives the link in figure 2. Conjecture 2.2 would imply

that it and its mutant are the minimal volume hyperbolic links containing a meridional incompressible planar surface.

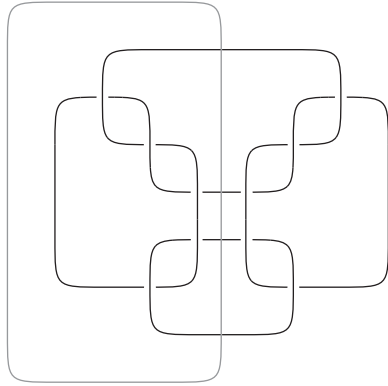

FIGURE 2. A link of volume 7.32 with a Conway sphere

Example 3.4. We can find lower bounds for volumes of certain 2-bridge links. A 2-bridge link L is obtained by taking the boundary of a plumbing of n twisted annuli and moebius strips (see figure 10). If the number of twists in each strip is ≥ 3 , then $Vol(S^3 \setminus L) \geq 2V_3(n - 1)$. A more general bound will be given in section 7.

Example 3.5. If M contains a surface S which is Thurston norm-minimizing and geometrically finite, then $Vol(M) \geq \frac{4}{5}V_3$. This will be proven in section 9. This occurs when $\beta_2(M) \geq 2$, or $\beta_1(M) = 1$ and M does not fiber over S^1 . If conjecture 2.2 is true, then $Vol(M) \geq \frac{2}{5}V_{oct} > Vol(W)$, which would imply that this type of 3-manifold could not be smallest volume.

4. GENERALIZED GROMOV NORMS

Here, we discuss the needed properties of generalized Gromov norms. Gromov introduced a norm as a topological invariant of homology classes. In particular, ones gets an invariant of the fundamental class of a manifold [12]. For hyperbolic manifolds, he proved that the volume is proportional to the norm of the fundamental class. We need a generalization of this to cell cycles. Cell cycles are to simplicial cycles as cell complexes are to simplicial complexes. Similar to the Gromov norm, one can take the norm on cycles represented by particular polyhedral cells with simplicial faces. Then for hyperbolic 3-manifolds, the volume will also be proportional to the norm of the fundamental class, where the proportionality constant is just the volume of the largest volume geodesic representative of the polyhedron in \mathbb{H}^3 .

For us, a cell will be a piecewise linear ball P whose boundary is a cell complex ∂P . Cells are given orientations in your favorite fashion, *e.g.* by orienting the simplices of a triangulation or by orienting the frame bundle. For an oriented cell P , we'll let \bar{P} be the same cell with the opposite orientation, and if $\sigma : P \rightarrow M$ is a map, then $\bar{\sigma} : \bar{P} \rightarrow M$ is

the same map on the polyhedron with opposite orientation. Let \mathcal{P} be a collection of cells, such that the faces of any cell in \mathcal{P} are also in \mathcal{P} . Define the chain complex

$$C_*(M; \mathcal{P}, \mathbb{R}) = \left\{ \sum_{\sigma: P \rightarrow M} a_\sigma \sigma : a_\sigma \in \mathbb{R}, P \in \mathcal{P} \right\} / \{ \sigma = -\bar{\sigma} \}.$$

Each $n - 1$ -cell in the cell complex ∂P inherits an orientation from P . We define $\partial(\sigma) = \sum_{K \in \partial P} \sigma|_K$, and extend ∂ to $C_*(M; \mathcal{P}, \mathbb{R})$ linearly. Then one can check that $(C_*(M; \mathcal{P}, \mathbb{R}), \partial)$ is a chain complex. The homology of this complex might be different from singular homology.

For example, we may take the cell complex \mathcal{O} of the octahedron. More generally, we can take any convex polyhedron P in \mathbb{H}^3 with triangular faces (the dihedral angles between some faces may be π). Then a theorem of Thurston says that this polyhedron has a geometric realization in \mathbb{H}^3 as an ideal polyhedron of maximal volume, when one can place horospheres centered at each vertex which are tangent along each edge of the polyhedron (like a bunch of frog eggs). Let $V(P)$ be this maximal volume, and let \mathcal{P} be the corresponding cell complex of P . We can now take the Gromov norm with respect to \mathcal{P} . For cycles in $Z_*(M; \mathcal{P}, \mathbb{R})$, we define the norm to be $\| \sum_{\sigma: P \rightarrow M} a_\sigma \sigma \| = \sum_{\sigma: P \rightarrow M} |a_\sigma|$, where $P \in \mathcal{P}, a_\sigma \in \mathbb{R}$. Since \mathcal{P} only has cells up to dimension 3, $H_3(M; \mathcal{P}, \mathbb{R}) = Z_3(M; \mathcal{P}, \mathbb{R})$. But we have a map $\psi : H_3(M; \mathcal{P}, \mathbb{R}) \rightarrow H_3(M; \mathbb{R})$ (singular homology), given by choosing some subdivision of the polyhedron P into oriented simplices (the map ψ should average over all twelve parametrizations of a simplex, so that we indeed get a singular cycle). For a cycle $z \in H_3(M; \mathcal{P}, \mathbb{R})$, we will say z is a fundamental cycle if $[\psi(z)] = [M]$. If z is transverse to a point in M , then the degree of z at that point will be 1. Now, we define $\| [M] \|_P = \inf \{ \| z \| : z \in Z_3(M; \mathcal{P}, \mathbb{R}), [\psi(z)] = [M] \}$. $\| [M, \partial M] \|_P$ is defined in a similar manner.

Lemma 4.1. *For int M^3 a finite volume hyperbolic manifold, $Vol(\text{int } M) = V(P) \| [M, \partial M] \|_P$.*

Proof. This is proven in the same manner as in [2, 12]. We review the key elements. One takes a sequence of compact polyhedra P_i converging to the ideal maximal P , and smears P_i uniformly about M to get a measure chain on M , where the copies of P_i with opposite orientation to M have negative sign. This measure chain is a cycle, since any face F of P_i will be matched with \bar{F} as a face of the polyhedron obtained by reflecting P_i through the geodesic plane containing F . One can approximate this measure cycle by choosing a Dirichlet domain and a basepoint. Then send each vertex of a polyhedron in a measure cycle to the nearest basepoint vertex. Each polyhedron then is weighted by the measure of the set of polyhedra sent to it under this map. One checks that for large enough i we still have a fundamental \mathcal{P} cycle of the same norm. Then this chain has norm $Vol(M)/Vol(P_i)$, and taking the limit as $i \rightarrow \infty$ gives the desired result.

The non-compact case works similarly to Theorem 6.5.4 in Thurston's notes [22]. \square

Suppose that $\text{int } M$ is finite volume hyperbolic. Let M' be a copy of M with the opposite orientation, and let $DM = M \cup_{\partial M = \partial M'} M'$ be the double of M along ∂M . Take a relative \mathbb{P} -cycle z such that $[\psi(z)] = [M, \partial M]$. Let z' be the corresponding cycle for M' . Since M' has reversed orientation from M , $\partial z'$ has opposite orientation from ∂z . So $\partial(z + z') = 0$, thus $z + z'$ is a fundamental cycle for DM . Thus $\| [DM] \|_P \leq 2 \| [M, \partial M] \|_P$.

5. NORMALIZATION OF CYCLES

Let S be incompressible in M , P be a polyhedron. Take a \mathcal{P} -cycle $\mu = \sum_i a_i \mu_i \in H_3(M; \mathcal{P}, \mathbb{R})$. A *normal* embedded disk in P is one which meets each edge of P at most once. The cycle μ is *normal with respect to S* if each $\mu_i : P \rightarrow M$ is transverse to S , and $\mu_i^{-1}(S)$ consists of normal disks in P .

Lemma 5.1. *We can homotope μ to be a normal cycle with respect to S .*

Proof. First, make μ transverse to S . Consider the universal cover $\tilde{M} \cong \mathbb{R}^3$. Then $\tilde{S} \subset \tilde{M}$ is a disjoint union of properly embedded planes. μ has preimage a locally finite cycle $\tilde{\mu}$ in \tilde{M} which is equivariant under the $\pi_1 M$ action. For each pair of vertices in $\tilde{\mu}$, choose an edge connecting these points which meets \tilde{S} in as few points as possible, such that the choice is equivariant. Construct a new cycle $\nu = \sum_i a_i \nu_i$ inductively. Map the vertices of each ν_i to the corresponding vertices of μ_i . Then extend ν_i to $P^{(1)}$ by the choices of efficient edges.

For a given lift $\tilde{\nu}_i$ of ν_i , and a component \tilde{S}_0 of \tilde{S} , $\tilde{\nu}_i^{-1}(\tilde{S}_0)$ meets a cutset of edges in $P^{(1)}$ in at most one point per edge. We can extend these to normal curves in ∂P , and then to normal disks in P (figure 3). To see this, look at a face Δ of P . If one edge of $\partial\Delta$ meets $\tilde{\nu}_i^{-1}(\tilde{S}_0)$, then exactly one of the other two edges of $\partial\Delta$ meets $\tilde{\nu}_i^{-1}(\tilde{S}_0)$. So we may connect the two points of $\partial\Delta \cap \tilde{\nu}_i^{-1}(\tilde{S}_0)$ by a normal arc in Δ . We may always choose these arcs disjoint, for different components of \tilde{S} . If not, then there would be components \tilde{S}_0 and \tilde{S}_1 such that $\tilde{\nu}_i^{-1}(\tilde{S}_0) \cap \partial\Delta$ and $\tilde{\nu}_i^{-1}(\tilde{S}_1) \cap \partial\Delta$ are linked in $\partial\Delta$. But \tilde{S}_0 divides $\nu_i(\partial\Delta)$ into two pieces, which lie on different sides of \tilde{S}_0 . So only once piece could intersect \tilde{S}_1 , which means the points are not linked. Now, extend $\tilde{\nu}_i$ to these curves, and then to

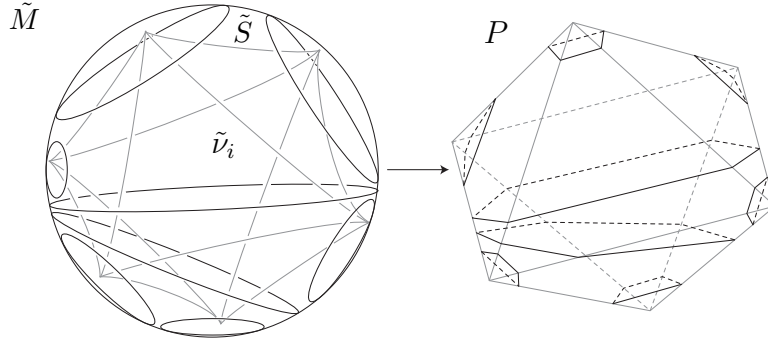

FIGURE 3. The surface S determines canonical normal disks

the disks equivariantly so that the normal disks map to \tilde{S} . This can be done since \tilde{S} is just a union of planes, and the action of $\pi_1(M)$ is free. We may now extend to $P^{(2)}$ so that the complement of the normal curves misses \tilde{S} , and then we can fill in the balls in P complementary to the normal disks equivariantly, and missing \tilde{S} , since the complementary pieces of \tilde{S} are contractible. This chain $\tilde{\nu}$ is equivariantly homotopic to $\tilde{\mu}$, so the chain ν is the desired normalized chain. \square

Remark: This proof should also work if we take a tight lamination \mathcal{L} in M , in which case we can make the edges meet each plane in \tilde{M} at most once, and the rest of the argument is the same.

6. LOWER BOUND ON VOLUME

In this section, we prove our main theorem 2.1. This will be a consequence of the following lemma, together with a well chosen sequence of polyhedra.

Lemma 6.1. *Let M be an orientable, finite volume hyperbolic manifold. Let P be a cell with F triangular faces, which has a realization as a convex ideal polyhedron in \mathbb{H}^3 . Let $S \subset M$ be an incompressible surface, and let $N = M \setminus \mathcal{N}(S)$. Then $\text{Vol}(M) \geq -2 \frac{\text{Vol}(P)}{F-2} \chi(\text{Guts}(N))$.*

Proof. First, let's outline the steps involved:

Step 1: Normalize the fundamental cycle.

Step 2: Cut the manifold and cycle along S .

Step 3: Lift the cut up cycle to coverings corresponding to $\text{Guts}(N)$.

Step 4: Put a hyperbolic metric on $\text{Guts}(N)$ and compactify the cusps to points.

Step 5: Straighten the cycle.

Step 6: Collapse to a new cycle.

Step 7: Show that each triangle contributes only once to $\partial \text{Guts}(N)$.

Step 8: Estimate the contribution of each cell in the original cycle to the boundary cycle.

Step 9: Find a lower bound in terms of $\chi(\text{Guts}(N))$.

Step 1: Since M has finite volume, M may have cusps. In this case, replace M and S by their doubles along the cusps, to get a closed manifold and surface. Denote $\text{Guts}(N) = (Q, R)$. Q has components Q_i and $R_i = Q_i \cap R$.

As an example of these definitions, consider the link shown in figure 2, which is the double of the tangle on one side of the Conway sphere. Double along the link to obtain M . S is the double of the Conway sphere. Cutting along S gives an atoroidal manifold which is the double of the tangle inside the sphere. Then N is two copies of the double of the tangle, the characteristic submanifold is a regular neighborhood of the tangle, and R is boundary of a neighborhood of the tangle. Q is four copies of the tangle complement.

Take a \mathcal{P} -cycle $\mu = \sum_{i=1}^n a_i \mu_i$, such that $[\psi(\mu)] = [M] \in H_3(M; \mathbb{R})$, and

$$\|M\|_P \leq \|\mu\|_P \leq \|M\|_P + \epsilon.$$

By the normal cycles lemma, we may assume μ is normal.

Step 2: For each singular cell $\mu_i : P \rightarrow M$, we can cut it along $\mu_i^{-1}(\mathcal{N}(S))$, to obtain cells $P_i^1, \dots, P_i^{p_i}$, where $\mu_i : P_i^j \rightarrow N$ (see Fig. 4).

Then we get a cell cycle

$$\nu = \sum_{i=1}^n \sum_{j=1}^{p_i} a_i \sigma_{i|P_i^j}$$

Since $[\mu] = [M]$, μ is locally degree one. So ν is also locally degree one. We choose a decomposition of each face of $\partial P_i^j \cap \nu_i^{-1}(\partial N)$ into triangles, without introducing any new vertices.

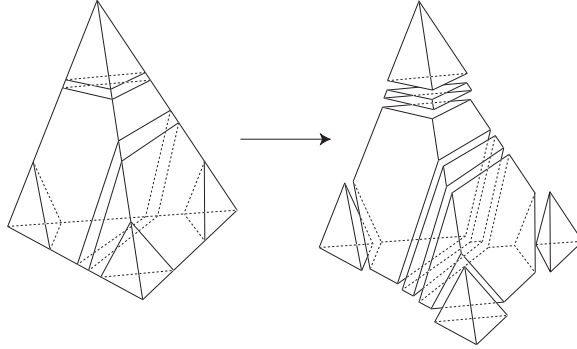

FIGURE 4. Cutting up the cycle

Step 3: Choose a component Q_i of Q . Then $\pi_1(Q_i)$ injects into $\pi_1(N)$. Take the cover \tilde{N}_i of N corresponding to $\pi_1(Q_i)$. Then there is a lift $Q_i \rightarrow \tilde{N}_i$, which is a homotopy equivalence since it is an isomorphism on fundamental group (we will call the image of the lift Q_i too). There are simply connected complementary pieces for each component of R_i . So there is a retraction $r : \tilde{N}_i \rightarrow Q_i$ crushing each component of $\tilde{N}_i \setminus Q_i$ to its corresponding component of R_i . The cell chain ν_i has preimage a locally finite chain $\tilde{\nu}_i$ in \tilde{N}_i . Since Q_i is compact, we can get a finite chain $\tilde{\nu}'_i$ by taking only the cells of $\tilde{\nu}_i$ which intersect the lift of Q_i . Then we project $\tilde{\nu}'_i$ to Q_i by the retraction r .

Step 4: By Thurston's geometrization theorem, $Q \setminus R$ has a geometric structure of finite volume with totally geodesic boundary. Crush each cusp of R to a point. This is equivalent to adding parabolic limit points to Q . We'll call these parabolic points \hat{R} , and the new manifold \hat{Q} with cycle $\hat{\nu}$.

Remark: The subsequent argument may be made without choosing a metric, but it makes some later choices canonical, and gives a better intuition for the argument, in our opinion.

Step 5: Now, we will straighten $\hat{\nu}$ inductively. This will be done in a certain order. First, we straighten interior edges. This will be done in a manner which keeps each end point of each edge on the boundary component on which it started (or keeps interior endpoints fixed). If the endpoint of an edge is mapped to a point $x \in \hat{R}$, then it will remain fixed at x , unless it was originally mapped to one of the two boundary components incident with x , in which case it can move around on that component. Each edge will be homotoped to a unique arc or cusp point in this manner: each pair of boundary components in \hat{Q}_i has a unique geodesic connecting them, or a unique tangent point in \hat{R} . By the normalization, each interior edge has end points on distinct boundary components, when lifted to the universal cover, so no arc will be homotopic into a component of $\partial\hat{Q}$.

Next, homotope the edges in the boundary to be straight, keeping the endpoints fixed. Do this in such a way that edges which homotope to the same geodesic have the same parametrization. Finally, homotope the triangles in each face in the boundary (chosen at the end of step 2) to be straight. We may choose these so that parametrizations of edges

are canonical, e.g. by projecting down from the Lorentzian model of $\partial\tilde{Q}$. Call the resulting cell cycle of $\partial\hat{Q}$ α .

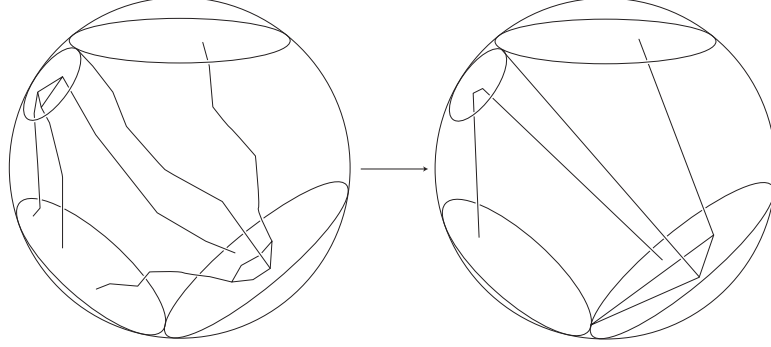

FIGURE 5. Straightening the cycle

We need to show that α is degree one on $\partial Q_i \cap \partial\tilde{N}_i$. The chain $\tilde{\nu}'_i$ is locally degree one on the interior of Q_i , since μ and ν are locally degree one. Then $\beta = \partial\tilde{\nu}'_i \cap \partial\tilde{N}_i$ is a locally degree 1 chain on $\partial Q_i \cap \partial\tilde{N}_i$. $\partial\beta$ has support in $\partial\tilde{N}_i \setminus \partial Q_i$. When we retract \tilde{N}_i to Q_i by the map r , then all the edges of $\partial\beta$ will lie inside R_i . All edges connecting points of $\partial\beta$ will lie in R_i , since we chose $\tilde{\nu}'_i$ to include every cell which intersects Q_i . So when we crush R to \hat{R} , and straighten, $\partial\beta$ will remain in \hat{R} , so β will remain degree one in $\partial\hat{Q}_i$.

Step 6: Many triangles in α will have collapsed to edges or points under this straightening process. The set of all collapsed triangles forms a degree 0 subcycle of α , so we may eliminate it and retain a degree 1 cycle in $\partial\hat{Q}$. We will call this new cycle α' .

Step 7: We need to show that each triangle of α' contributes at most once to ∂Q . That is, we took the preimage of the cycle ν in \tilde{N}_i to get $\tilde{\nu}_i$ in step 3. A particular triangle will have many preimages in $\tilde{\nu}_i$, for each i , and we need to show that at most one preimage contributes non-trivially to α' . To see this, first notice that the position of each triangle after straightening (step 5) is determined by the interior edges of the cycle ν (the original cut up cycle from step 1) to which it was attached. Take a particular triangle Δ in ∂N which has edges e_1, e_2, e_3 attached to it in the particular cell of ν in which it lies. Now, consider the lift of Δ to \tilde{N} , the universal cover of N . Suppose that Δ contributes twice to Q . Let \tilde{Q} be the preimage of Q in \tilde{N} . Then a lift of Δ to \tilde{N} is homotopic into two different components \tilde{Q}_1 and \tilde{Q}_2 of \tilde{Q} . There is some infinite strip or plane component \tilde{R}_0 of the preimage of R (the pared locus of Q) in \tilde{Q} which separates \tilde{Q}_1 and \tilde{Q}_2 . If \tilde{R}_0 is a plane, then Δ can contribute only to the \tilde{Q}_i which lies on the same side of \tilde{R}_0 as Δ does. So \tilde{R}_0 is an infinite strip, covering an annulus in R . \tilde{R}_0 will be incident with two components of $\partial\tilde{N}$, S_1 and S_2 . We may assume that the endpoints of e_1, e_2, e_3 all lie on distinct components of $\partial\tilde{N}$, otherwise Δ will always collapse. Let's say that \tilde{Q}_1 lies to the left of \tilde{R}_0 , and \tilde{Q}_2 lies to the right of \tilde{R}_0 . If Δ lies on a component of $\partial\tilde{N}$ to the left of \tilde{R}_0 , then it will be crushed to a cusp in Q_2 when we straighten. Symmetrically for the right, so Δ must lie on S_1 (or S_2) if it is to contribute to both \tilde{Q}_1 and \tilde{Q}_2 . We will assume Δ is on S_1 . There are some cases to consider now:

- e_1 ends on S_2 , e_2 and e_3 end on other components of $\partial\tilde{N}$ to the left of \tilde{R}_0 . In this case, all the edges will be homotopic to \hat{R} in \tilde{Q}_2 , so Δ will not contribute to \tilde{Q}_2 .
- e_1 ends on S_2 , e_2 ends on a boundary component on the left of \tilde{R}_0 and e_3 ends on a boundary component on the right of \tilde{R}_0 . In this case, e_1 and e_2 will be collapsed to \hat{R} in \tilde{Q}_2 , so Δ will not contribute to \tilde{Q}_2 (or to \tilde{Q}_1).
- e_1 and e_2 end on boundary components to the left of \tilde{R}_0 and e_3 ends on a boundary component on the right of \tilde{R}_0 . In this case, the ends of e_1 and e_2 will be sent to \hat{R} in \tilde{Q}_2 , and the edge of Δ connecting e_1 and e_2 will collapse in \tilde{Q}_2 , so Δ does not contribute (see figure 6).

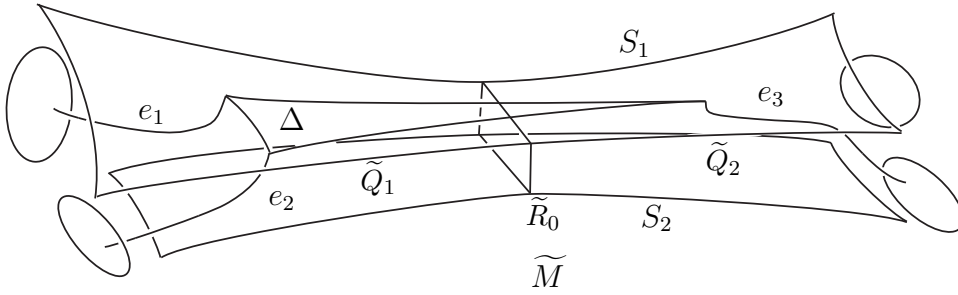

FIGURE 6. Assessing the contribution of Δ

- $e_1, e_2,$ and e_3 end on boundary components to the left of \tilde{R}_0 . In this case, all the ends will be mapped to \hat{R} in \tilde{Q}_2 , and Δ will not contribute to \tilde{Q}_2 .

So we see that each triangle can contribute in only one way to the cycle α' .

Step 8: Here is a way to compute the number of triangles from a polyhedron P_i which contribute to the collapsed cycle α' . P_i^j will have faces which came from P_i , called $\partial P_i^{j'}$, and new faces which came from ∂N , called $\partial P_i^{j''}$. Collapse each quadrilateral and triangle in $\partial P_i^{j'}$ to an edge by collapsing the edges adjacent to $\partial P_i^{j''}$ - this collapsing is compatible with the straightening of edges which we did in step 5 (see Figure 7). Now, $\partial P_i^{j'}$ will consist

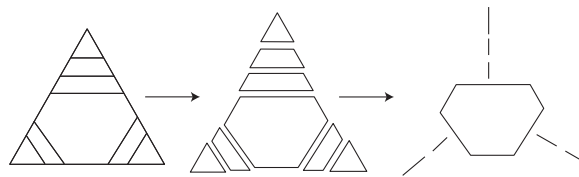

FIGURE 7. How to collapse the faces of P_i^j

of truncated triangle faces after the collapsing (some j may collapse to line segments, which we throw out). In step 2, each face of $\partial P_i^{j''}$ was divided up into triangles, and after collapsing $\partial P_i^{j'}$, some of the boundary of these triangles will collapse, so we get rid of them, since they will contribute to the collapsed cycle $\alpha - \alpha'$. Now, each triangle of $\partial P_i^{j''}$ which contributes to the cycle α' (from step 6) must come from one of these triangles left over.

So we need to estimate how many of these triangles there are. Collapse the faces of $\partial P_i^{j'}$ to points. We then get a set of triangulations of boundaries of balls, one for each j (except for the segments which we got rid of). Each new vertex corresponds to a cell which is divided up into triangles of the collapsed cycle α' constructed in step 6. If the vertex has degree d , then it contributes at most $d - 2$ triangles to α' . The union of triangulations has the same number of faces as the original triangulation of ∂P_i , but there are more components than the original. We may as well assume every vertex contributes, since this is the maximal possible case. Let there be v vertices, where vertex i has degree d_i , e edges, and c components to the triangulation. Then $\sum_i (d_i - 2) = 2e - 2v = 2F - 4c \leq 2F - 4$, by euler characteristic. So there are at most $2F - 4$ triangles contributing to α' from the polyhedron P .

Step 9: The cycle α' is locally degree one. In the metric on ∂Q , each triangle has area at most π . We have

$$Area(\partial Q)/\pi = -2\chi(\partial Q) = -4\chi(Q) \leq \|\alpha'\| \leq (2F - 4)\|\mu\| \leq (2F - 4)(\|M\|_P + \epsilon).$$

Letting ϵ go to zero, then

$$Vol(M) = \|M\|_P Vol(P) \geq \frac{-4\chi(Q)}{2F - 4} Vol(P) = \frac{-2\chi(Q)}{F - 2} Vol(P).$$

□

To finish the main theorem, we need to find a sequence of polyhedra P_n such that $\frac{Vol(P_n)}{F_n - 2}$ approaches V_3 . First note that this is the best one can do. An ideal polyhedron P with F triangle faces has $Vol(P) \leq V_3(F - 3)$, since we can triangulate P by coning off to a vertex, and we need at most $F - 3$ tetrahedra, each of volume $\leq V_3$. Sleator, Tarjan, and Thurston showed that one could find a sequence of polyhedra P_n such that $\frac{Vol(P_n)}{F_n - 2} \rightarrow V_3$ by taking polyhedra which have the combinatorics of a hexagonal subdivision of an icosahedron (this was pointed out to me by Thurston) [20]. The idea is that most of the triangles will look nearly equilateral when viewed from one ideal vertex, so that coning off will give a triangulation where most of the tetrahedra are nearly regular.

Another possible choice of polyhedra is obtained by a sequence of polyhedra which exhaust the tessellation of \mathbb{H}^3 by regular ideal tetrahedra. P_1 is a tetrahedron. P_n has all dihedral angles either π or $\frac{\pi}{3}$, so it will have triangular faces, but geometrically there will be larger faces consisting of coplanar triangles. P_{n+1} is obtained by adding a reflected copy of P_n to each geometric face of P_n (see figure 8). One can compute that in the limit the $Vol(P_n)/F_n \rightarrow V_3$. This is a more elementary construction, but it may be less intuitive.

7. TWO-BRIDGE LINKS

In this section, we prove the claim in example 3.4. First, we need a general lemma, which allows one to apply the main theorem.

A graph is n -connected, if removing n vertices from the graph, as well as their adjacent edges, keeps the graph connected.

Lemma 7.1. *Let H be a handlebody of genus > 1 , $P \subset \partial H$ a set of essential simple closed curves, and D a set of properly embedded disks in H which cut H up into a ball. Take D transverse to P with minimal intersection. Let $S = \partial(H \setminus \mathcal{N}(D))$ be the resulting sphere.*

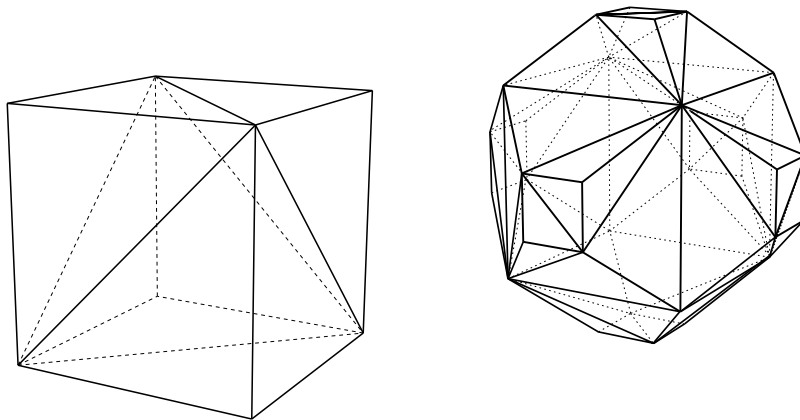
FIGURE 8. Projective model of P_1 , P_2 , and P_3

Take a graph G , with vertices coming from $\overline{\partial\mathcal{N}(D)} \cap S$ and edges the segments of $P \cap S$. If G is 2-connected, then $\chi(\text{Guts}(H, P)) = \chi(H)$.

Proof. Since H is a handlebody, it is atoroidal. So the only Seifert pieces in the characteristic sub-pair of (H, P) must be solid tori. Suppose the characteristic I -bundle of (H, P) has $\chi < 0$. Then there is a sub-bundle which is $T = t \times I$, where t is a pair of pants.

First, notice that the disks D must be ∂ -incompressible, that is there is no ∂ -compression with one boundary arc on D and the other boundary arc on $S \setminus G$. If not, then the ∂ -compression would represent a separating vertex of G . But the graph G is 1-connected, since it is 2-connected, and has at least 4 vertices, a contradiction. This is a diskbusting criterion of Whitehead.

Look at the intersection of D with the product pair of pants T . Make $T \cap D$ minimal. We need to show that $T \cap D$ consists of product rectangles. The intersection will have no closed curves, because $\partial t \times I$ is incompressible, and $D \cap (\partial t \times I)$ will consist of product lines, by the ∂ -incompressibility of D . Suppose that some component A of $T \cap D$ is not a product rectangle in T . Then there are two arcs of ∂A running over $t \times \{0\}$. Taking a path connecting these arcs on A , we see that this path is homotopic rel endpoints into $t \times \{0\}$, so D has a boundary compression by a well known argument, which we outline. Make the homotopy boundary compression transverse to D , with no fake branching. Then an innermost arc of intersection on the boundary compression gives a disk with interior disjoint from D . The loop theorem allows us to replace it with an embedded ∂ -compressing disk. So there is a ∂ -compression of D inside T . But since D is ∂ -incompressible in the complement of G , when we surger along the ∂ -compression, we get something isotopic to D , with smaller intersection with $\partial t \times I$, a contradiction. So D must be a product rectangle.

If we cut T along $T \cap D$, we must get a set of disks $\times I$, otherwise there would be a simple closed curve in the sphere which compresses $t \times \partial I$, a contradiction. Call one of these disks $d \times I$. $\partial d \times I$ intersects D in a collection of at least three rectangles. Each of these rectangles intersects two vertices of G and cuts the graph into two pieces. Since G is 2-connected, the part of G lying to one side of each rectangle must contain no vertices of

G . So we must see a picture like figure 9. Thus, $d \times I$ must meet every vertex in G . This

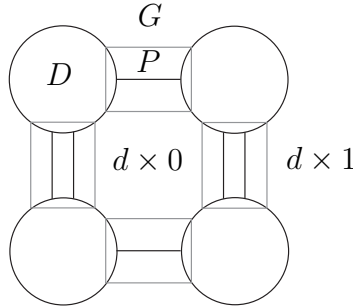

FIGURE 9. How a product region must look

picture is impossible, since it is not 2-connected. □

We need another observation, which is essentially due to Gabai in the context of sutured manifolds [9]. If in the context of the lemma, a disk hits the curve exactly twice, then this gives a pair of pants $\times I$. This means that if we have the graph G as in lemma 7.1, we can get rid of any degree 2 vertices, since they contribute to the characteristic submanifold. If what's left over is 2-connected, then we may apply lemma 7.1 to each component which is left over.

We can now apply the lemma to analyze volumes of 2-bridge links. We will follow the conventions of Hatcher and Thurston [14]. A 2-bridge link L is obtained by taking the boundary of a plumbing S of several bands B_i (twisted moebius strips and annuli), each having b_i half-twists, where $|b_i| \geq 2$, and the twists are right-handed if $b_i > 0$, and left-handed if $b_i < 0$.

To estimate the volume, consider the sequence of numbers of twists in each band $\{b_1, \dots, b_k\}$. Consider the number j of maximal subsequences $b_k, b_{k+1}, \dots, b_{k+l}$, where each $|b_i| \geq 3$, and let $m = |\{i : |b_i| \geq 3\}|$. Then $Vol(L) \geq 2V_3(m - j)$. Each sequence of bands counted by j contributes to the guts of the complement of the surface. Thicken the surface S up to get a Heegaard handlebody, with L on its boundary. Then choose the obvious set of disks D_i , one for each band B_i , getting a graph G as in the lemma, with two vertices for each disk of D , and edges coming from the pieces of L . First, let's see what the graph G looks like locally for each band.

Figure 10(a) shows what one of the bands looks like, with rectangular pieces on top and bottom where the plumbing occurs. Fattening up and adding the 2-handle corresponding to D_i , we get a sphere as in figure 10(b). The graph on the surface of the sphere looks like figure 10(c), where the rectangle has a picture looking like one of the cases in figure 10(d).

When we plumb several bands together, we get a graph which looks like figure 11

For each band B_i with $|b_i| = 2$, we can add another handle which crosses L twice, dividing the sphere into two spheres, and creating a graph G' . Since both D_i and the second handle cross L twice, we may eliminate them from the graph G' . Doing this for every band with $|b_i| = 2$ leaves over a bunch of handlebodies corresponding to maximal subsequences of $\{b_i\}$ with $|b_i| \geq 3$. Then we may apply the lemma 7.1 to these handlebodies, to obtain the claimed lower bound for the volume.

FIGURE 10. Constructing G 

FIGURE 11. The full graph

Let's see what this implies for 2-bridge links in general. Any 2-bridge link may be represented by a rational number $\frac{p}{q}$, with $0 < \frac{p}{q} < 1$. Then $\frac{p}{q}$ has a unique continued fraction expansion

$$(1) \quad \frac{p}{q} = \frac{1}{a_1 + \frac{1}{a_2 + \frac{1}{\dots + \frac{1}{a_k}}}}$$

where $a_i \geq 1$, $a_1 \geq 2$, $a_k \geq 2$.

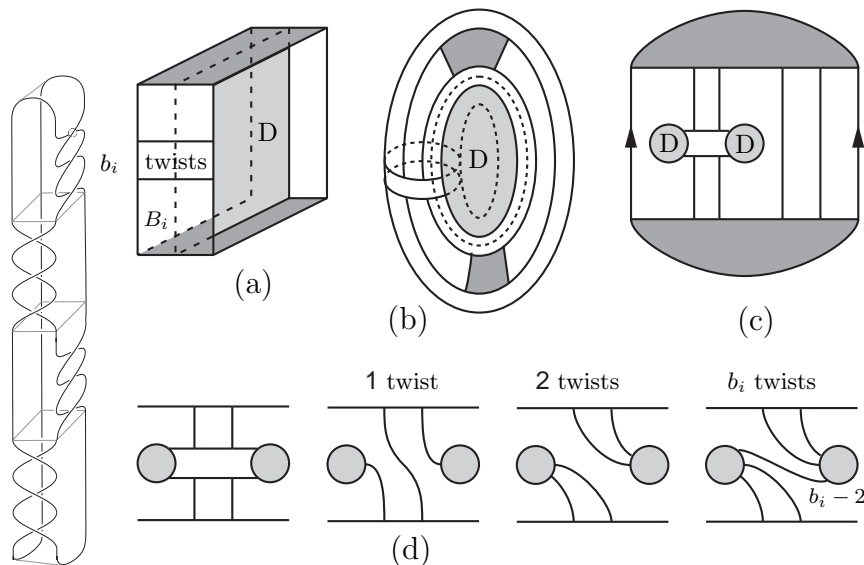
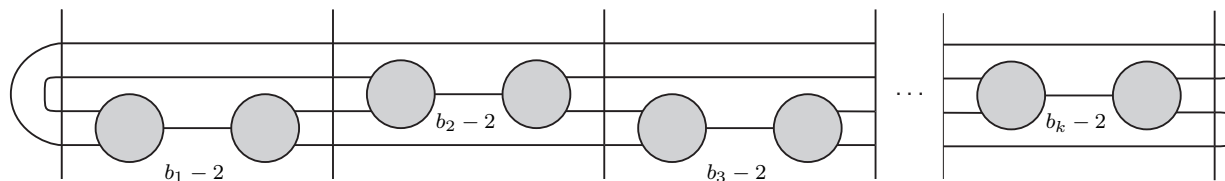
Corresponding to this expansion is a picture in the arc complex of the 4-punctured sphere, which looks like:

A locally minimal path gives a continued fraction expansion for $\frac{p}{q}$ which corresponds to a plumbing of bands with $|b_i| \geq 2$, where at the i -th vertex, the path turns left or right across $|b_i|$ triangles, left if $b_i > 0$, right if $b_i < 0$. This must be a path traversing only heavy edges in figure 12. One can check that there is always some path with a sequence of at least two B_i 's with $|b_i| \geq 3$, except in two classes of exceptional cases. The first case

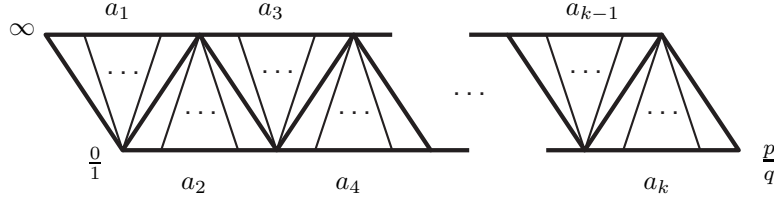

FIGURE 12. Continued fraction expansion

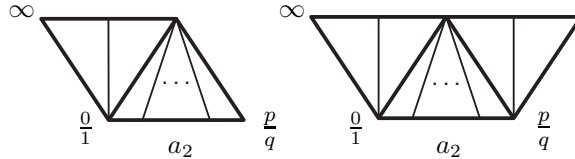

FIGURE 13. Cases where lower bound fails

corresponds to the twist knots, which are fillings on the Whitehead link and its mutant, so they have volume $< V_{oct}$. The second case corresponds to two-component links which are branch covers over twist knots in S^3 or 2-bridge knots in \mathbb{RP}^3 .

For every other 2-bridge link, we get that the volume $\geq 2V_3$. Of course, this is already implied by Cao and Meyerhoff's result [4], but if conjecture 2.2 is true, then we could improve this lower bound to V_{oct} . So conjecture 2.2 would imply that the only 2-bridge links with volume $\leq V_{oct}$ are twist knots.

8. MERIDIANAL PLANAR INCOMPRESSIBLE SURFACES

Let $k \subset M$ be a hyperbolic link, $M_k = M \setminus \mathcal{N}(k)$, and let $P \subset M_k$ be an incompressible planar surface with boundary components being meridians of k . P extends naturally to a 2-sphere \hat{P} in M , by capping off ∂P with meridian disks in $\mathcal{N}(k)$. If M is a \mathbb{Z}_2 -homology 3-sphere, then $M_{\hat{P}} = M \setminus \mathcal{N}(\hat{P})$ is two \mathbb{Z}_2 -homology 3-balls, and $k \cap M_{\hat{P}}$ is an atoroidal tangle in each component of $M_{\hat{P}}$. For example, a Conway sphere in a link complement is of this form.

Lemma 8.1. *Let B be a \mathbb{Z}_2 -homology ball, $T \subset B$ a tangle in B . Denote $B_T = B \setminus \mathcal{N}(T)$, and $R = \partial B_T \setminus \text{int } \partial B$. Assume that $\partial B \cap \partial B_T$ is incompressible in B_T and B_T is atoroidal. Then $\chi(Guts(B_T, R)) \leq -1$.*

Proof. Let $(G, \partial_0 G) = Guts(B_T, R)$. If $\chi(G) = 0$, then G is a union of $S^1 \times I \times I$. The I -bundle part of the characteristic sub-pair of $(B_T, \partial B_T \setminus \text{int } R)$ must have planar base surface, since ∂B is a 2-sphere. Also, it must be a product bundle, since otherwise there would be a properly embedded möbius band in B , contradicting that B is a \mathbb{Z}_2 -homology ball. The other components of the characteristic sub-pair are solid tori, such that the meridian meets ∂B at least 3 times. We will denote these pieces by $(C, \partial_0 C)$, where $\partial_0 C = \overline{\partial C} \setminus \overline{\partial B}$. Fill in the components of G to get a book of I -bundles. Notice that $\partial B_T \setminus R$ is a connected surface, since its complement in ∂B is a union of disks.

Take a path q in $\partial B_T \setminus \partial_0 B$ which connects points q_1 and q_2 on opposite sides of a product piece of $B_T \setminus C$, with the property that this path hits the annuli in $\partial C \cap \partial B$ a minimal number of times. This number must be ≥ 1 , since the piece is a product. Consider the first annular piece of $\partial C \cap \partial B$ which the path crosses. It will first cross the boundary of an annulus $A_1 \subset \partial_0 C$, then an annulus $A_2 \subset \partial_0 C$, and then proceeds back into the product part. The path must hit these components of ∂A_1 and ∂A_2 at most once, otherwise we could find a path hitting ∂C fewer times. Now, suppose the path crosses the other component of ∂A_2 at some point. Then we could find a subpath which connects opposite points of ∂A_2 and which intersects $\partial_0 C$ fewer times (see 14 (a)). So we may

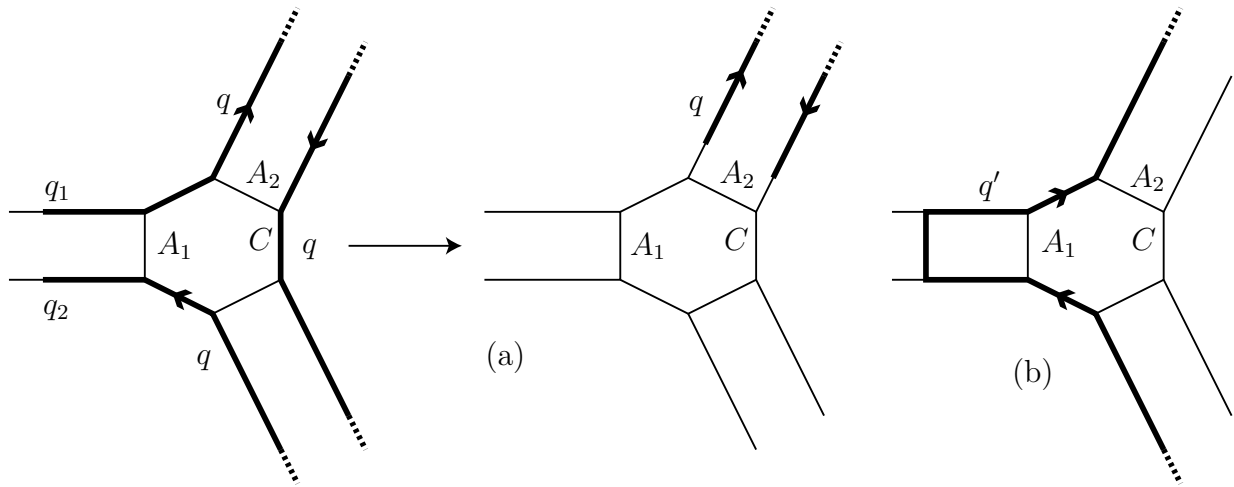

FIGURE 14. modifying the path

assume that q hits ∂A_2 at most once. Make a closed path q' by connecting q_1 and q_2 by a path in the product part (see 14 (b)). Then we have a closed path in B which hits the annulus A_2 once, contradicting that B is a \mathbb{Z}_2 -homology ball. Thus, $\chi(G) \leq -1$. \square

Corollary 8.2. *Let k be a link in M , a \mathbb{Z}_2 -homology 3-sphere with a meridional incompressible surface P . Then $\text{Vol}(M_k) \geq 4V_3$.*

Proof. By the lemma, $\chi(\text{Guts}(M_k \setminus \mathcal{N}(P), \partial M_k \setminus \mathcal{N}(P))) \leq -2$, so $\text{Vol}(M_k) \geq 4V_3$. \square

A theorem of Thompson shows that every knot in S^3 either has a meridional incompressible planar surface, or the knot is in bridge position whenever it is in thin position [21]. So this shows that many knots have thin position equal to bridge position, since their volumes are less than $4V_3$. There are 23 knots in the census [3] which have volume $\leq 4V_3$.

9. BETTI NUMBER 1 CASE

Consider a closed hyperbolic manifold M^3 with a non-separating incompressible surface S , which does not fiber over the circle. S represents a non-trivial class in $H_2(M; \mathbb{R})$. As noted before, a theorem of Thurston implies such a surface exists if $\beta_1(M) \geq 2$. We modify an argument of Cooper and Long [5] to get a lower bound for the volume of M . Let \tilde{M}_n

be the n -fold cyclic cover of M dual to S , and \tilde{M} be the infinite cyclic cover. Choose a base surface S_0 in \tilde{M} , let t be the generating covering translation in \tilde{M} . Let $S_i = t^i(S_0)$. In \tilde{M} , let M_j be the manifold between S_0 and S_j , and let $(\Sigma_j, K_j) \subset (M_j, \partial M_j)$ be the characteristic subpair, $\Phi_j \subset \Sigma_j$ be the characteristic I -bundle. M_j is atoroidal, so $\Sigma_j \setminus \Phi_j$ is a disjoint union of solid tori, which intersect ∂M_j in a collection of essential annuli. Φ_j has components Φ_j^0 whose boundary is entirely in S_0 , Φ_j^j whose boundary is in S_j , and Φ_j^p which is a product between S_0 and S_j (see figure 15(a)).

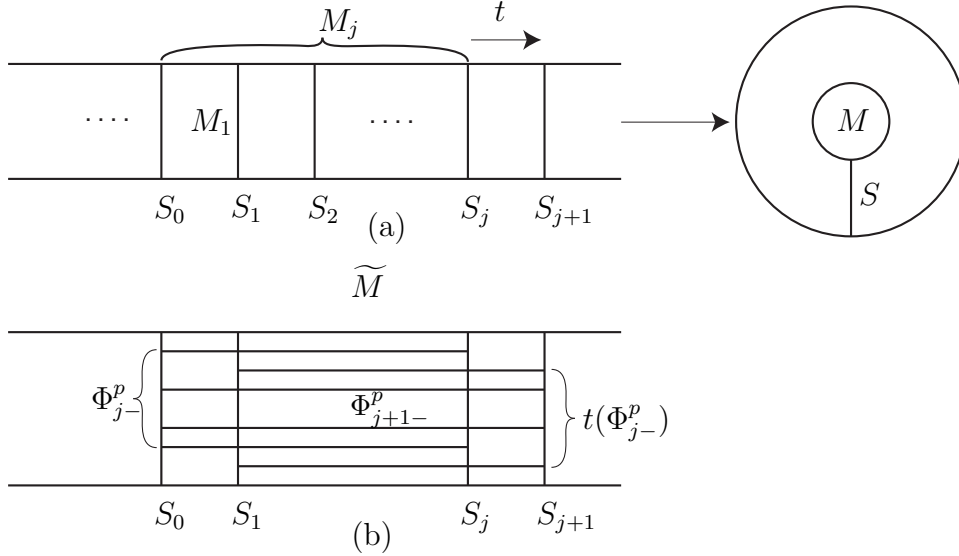

FIGURE 15. Schematic for the proof

Lemma 9.1. *If S is Thurston norm minimizing, then $\chi(\text{Guts}(M_{5g-5})) = \chi(S) = 2 - 2g$.*

Proof. Put a partial order on subsurfaces of S_0 , such that if F, G are subsurfaces of S_0 , then $F \leq G$ if and only if F is isotopic to a subsurface of G . Let Φ_{j-}^p be the union of components of Φ_j^p with $\chi < 0$. Let $\phi_j = \partial\Phi_{j-}^p \cap S_0$. For a collection of curves C in S_0 , let $[C]$ represent the set of homotopy classes of the curves.

Claim 9.2. $\chi(\Phi_j^0) = \chi(\Phi_j^j) = 0$.

Proof. By a result of Gabai, S_0 is Thurston-norm minimizing in \tilde{M}_j [10]. If $\chi(\Phi_j^0) < 0$, then $\partial\Phi_j^0 = F \cup J$, where $F = S_0 \cap \Phi_j^0$, and J is a union of annuli. Then $(S_0 \setminus F) \cup J$ is a surface homologous to S_0 with smaller Thurston norm, a contradiction. Similarly, $\chi(\Phi_j^j) = 0$. (Note: Gabai's result simplifies this argument, but is not mandatory.) \square

Claim 9.3. ϕ_j is a decreasing sequence, and for each j , either $[\partial\phi_j] \subsetneq [\partial\phi_{j+1}]$, or $\chi(\phi_j) > \chi(\phi_{j+1})$.

Proof. Φ_{j+1-}^p can be isotoped so that $S_j \cap \Phi_{j+1-}^p$ is incompressible, and divides each component of Φ_{j+1-}^p into product pieces (see Jaco, IX.1, [15]). The union of first pieces of each component is a product from S_0 to S_j . By the characteristic submanifold theory, this

product part is isotopic into Σ_j , so since each component has $\chi < 0$, it must be isotopic into Φ_{j-}^p (they couldn't be isotopic into a solid torus component of Σ_j) (fig. 15(b)). Thus $\phi_{j+1} \leq \phi_j$. By an isotopy, we may assume that $\phi_{j+1} \subset \text{int } \phi_j$.

Suppose that $\chi(\phi_{j+1}) = \chi(\phi_j)$. Then $\phi_j \setminus \text{int } \phi_{j+1}$ is a disjoint union of annuli. For each curve in $\partial\phi_j$, the other boundary curve in the annulus in $\phi_j \setminus \text{int } \phi_{j+1}$ must be a curve in $\partial\phi_{j+1}$, otherwise ϕ_j would have an annulus component, contradicting that each component has $\chi < 0$. So we have $[\partial\phi_j] \subset [\partial\phi_{j+1}]$.

Now, assume that $\chi(\phi_{j+1}) = \chi(\phi_j)$ and $[\partial\phi_j] = [\partial\phi_{j+1}]$. Then ϕ_{j+1} is isotopic to ϕ_j . We can isotope Φ_{j+1-}^p so that S_1 dissects Φ_{j+1-}^p into product pieces. Let P be the union of these pieces which have a boundary component on S_{j+1} . Then P is a product from S_1 to S_{j+1} . P can be isotoped into $t(\Phi_{j-}^p)$ (fig. 15(b)). So $F = t^{-1}(\partial P \cap S_1)$ will be a subsurface of ϕ_j . F is homeomorphic to ϕ_{j+1} . Then as with ϕ_{j+1} , F is isotopic to ϕ_j . Thus, $[\partial F] = [\partial\phi_j]$.

Since $[\partial\phi_j] = [\partial\phi_{j+1}]$, we may take each component of $\partial\phi_j$ to a parallel component of $\partial\phi_{j+1}$. Then $\overline{\Phi_{j+1-}^p \setminus P}$ gives a product from ϕ_{j+1} to $t(F)$. So we may map each component of $\partial\phi_{j+1}$ to a component of $\partial t(F)$ which cobounds an annulus with it, coming from the boundary of the product. Then this component of $\partial t(F)$ corresponds to a component of $\partial\phi_j$, since $\partial F = \partial\phi_j$. So we have a map from $[\partial\phi_j] \rightarrow [\partial\phi_j]$. Some iterate of this map has a fixed curve. The sequence of annuli connecting the iterates of this curve give a torus in M which is non-trivial, contradicting that M is hyperbolic. Thus we see that if $\chi(\phi_j) = \chi(\phi_{j+1})$, then $[\partial\phi_{j+1}] \subsetneq [\partial\phi_j]$, which is equivalent to the last part of the claim. \square

Claim 9.4. The sequence $\{\phi_j\}$ can have length at most $5g - 5$.

Proof. We can assume that we have nested sequence of surfaces ϕ_j in S_0 , such that for each j , either $[\partial\phi_j] \subsetneq [\partial\phi_{j+1}]$, $\chi(\phi_{j+1}) > \chi(\phi_j)$. Let $C = \cup_j [\partial\phi_j]$. Then $|C| \leq 3g - 3$. Each curve of C can be in $[\partial\phi_{j+1}] \setminus [\partial\phi_j]$ at most once, since once a curve of C disappears from $[\partial\phi_j]$, it never appears later in $[\partial\phi_k]$, $k > j$. Also, $\chi(\phi_j)$ can increase at most $2g - 2$ times. Thus, $\phi_{5g-5} = \emptyset$. \square

So $\chi(\text{Guts}(M_{5g-5})) = \chi(M_{5g-5} \setminus \Sigma_{5g-5}) = \chi(M_{5g-5} \setminus \Phi_{5g-5-}^p) = \chi(M_{5g-5}) = \chi(S)$. \square

Now, we have that $(5g - 5)\text{Vol}(M) = \text{Vol}(\tilde{M}_{5g-5}) \geq 2V_3(2g - 2)$. Thus, $\text{Vol}(M) \geq \frac{4}{5}V_3$. So we get a universal lower bound to volumes of these special types of manifolds.

We believe that this lower bound can be improved in general. In particular, if $g = 2$, then we can show that $\text{Vol}(M) \geq V_3$, since the covering argument can be improved from 5 to 4 by a case by case analysis.

10. CONCLUSION

There are many questions which have arisen during this paper. One is whether this argument can be extended to genuine laminations. This seems possible, at least if the lamination is tight. Other possible extensions would be to apply the technique to get lower bounds for two-bridge links to other classes of manifolds where the incompressible surfaces are well understood, *e.g.* torus bundles over S^1 and alternating links. It seems likely that arguments in section 9 are not sharp, so it would be interesting to improve on them. Of course, the main question is to try to prove conjecture 2.2, which would

give several sharp lower bounds, as explained. The technique in this paper probably can't be generalized to prove the conjecture, if it is true, although one might be able to show that one can replace $2V_3$ with V_{oct} in theorem 2.1 using suitable generalizations of this technique. The only evidence we have for conjecture 2.2 is from playing with SnapPea [26], where if you replace the link shown in figure 2 with different braids connecting up the tangles on either side of the sphere, the volume seems to go up. We can also show that $Vol(M) \geq \frac{V_3}{V_{oct}} Vol(Guts(M \setminus \mathcal{N}(S)))$. This follows using the technique of theorem 2.1, since the volume of a truncated tetrahedron is $\leq V_{oct}$.

REFERENCES

1. C. C. Adams. The noncompact hyperbolic 3-manifold of minimal volume. *Proceedings of the American Mathematical Society*, 100(4):601–606, 1987.
2. R. Benedetti and C. Petronio. *Lectures on hyperbolic geometry*. Springer-Verlag, Berlin, 1992.
3. P. J. Callahan, J. C. Dean, and J. R. Weeks. The simplest hyperbolic knots. preprint.
4. C. Cao and R. Meyerhoff. The orientable cusped hyperbolic 3-manifolds of minimal volume. preprint.
5. D. Cooper and D. D. Long. Virtually haken dehn-filling. preprint.
6. M. Culler, S. Hersonsky, and P. B. Shalen. The first Betti number of the smallest closed hyperbolic 3-manifold. *Topology*, 37(4):805–849, 1998.
7. M. Culler and P. B. Shalen. The volume of a hyperbolic 3-manifold with betti number 2. *Proceedings of the American Mathematical Society*, 120(4):1281–1288, 1994.
8. M. Culler and P. B. Shalen. Volumes of hyperbolic haken manifolds. i. *Inventiones Mathematicae*, 118(2):285–329, 1994.
9. D. Gabai. Detecting fibred links in S^3 . *Comment. Math. Helv.*, 61(4):519–555, 1986.
10. D. Gabai. Foliations and the topology of 3-manifolds. II. *J. Differential Geom.*, 26(3):461–478, 1987.
11. D. Gabai, R. Meyerhoff, and N. Thurston. Homotopy hyperbolic 3-manifolds are hyperbolic. MSRI preprint series.
12. M. Gromov. Volume and bounded cohomology. *Publications Mathematiques I.H.E.S.*, 56:213–307, 1982.
13. J. Hass. Acylindrical surfaces in 3-manifolds. *Michigan Mathematical Journal*, 42(2):357–365, 1995.
14. A. Hatcher and W. Thurston. Incompressible surfaces in 2-bridge knot complements. *Invent. Math.*, 79(2):225–246, 1985.
15. W. Jaco. *Lectures on three-manifold topology*. American Mathematical Society, Providence, R.I., 1980.
16. S. Kojima and Y. Miyamoto. The smallest hyperbolic 3-manifolds with totally geodesic boundary. *Journal of Differential Geometry*, 34:175–192, 1991.
17. Y. Miyamoto. Volumes of hyperbolic manifolds with geodesic boundary. *Topology*, 33(4):613–629, 1994.
18. J. W. Morgan. On thurston's uniformizations theorem for 3-dimensional manifolds. In *The Smith Conjecture*. Academic Press.
19. I. Rivin. On geometry of convex ideal polyhedra in hyperbolic 3-space. *Topology*, 32(1):87–92, 1993.
20. D. D. Sleator, R. E. Tarjan, and W. P. Thurston. Rotation distance, triangulations, and hyperbolic geometry. *J. Amer. Math. Soc.*, 1(3):647–681, 1988.
21. A. Thompson. Thin position and bridge number for knots in the 3-sphere. *Topology*, 36(2):505–507, 1997.
22. W. P. Thurston. The geometry and topology of 3-manifolds. Lecture notes from Princeton University, 1978–80.
23. W. P. Thurston. A norm for the homology of 3-manifolds. *Mem. Amer. Math. Soc.*, 59(339):i–vi and 99–130, 1986.
24. A. Vesnin. *On volumes of some hyperbolic 3-manifolds*. Seoul National University, Research Institute of Mathematics, Global Analysis Research Center, Seoul, 1996.
25. S. Wang, Y.-Q. Wu, and Q. Zhou. Pseudo-anosov maps and simple closed curves on surfaces.

26. J. Weeks. Snappea: A computer program for creating and studying hyperbolic 3-manifolds. available by anonymous ftp from geom.umn.edu/pub/software/snappea/.

DEPARTMENT OF MATHEMATICS, U. C. DAVIS, DAVIS, CA 95616

E-mail address: iagol@math.ucdavis.edu