

Generalized Enrichment for Categories and Multicategories

Tom Leinster

Department of Pure Mathematics, University of Cambridge

Email: leinster@dpmms.cam.ac.uk

Web: <http://www.dpmms.cam.ac.uk/~leinster>

28 January, 1999

Abstract

In this paper we answer the question: ‘what kind of a structure can a general multicategory be enriched in?’ (Here ‘general multicategory’ is used in the sense of [Lei1], [Bur] or [Her].) The answer is, in a sense to be made precise, that a multicategory of one type can be enriched in a multicategory of the type one level up. In particular, we will be able to speak of a T_n -multicategory enriched in a T_{n+1} -multicategory, where T_n is the monad expressing the pasting-together of n -opetopes, as constructed in [Lei2].

The answer for general multicategories reduces to something surprising in the case of ordinary categories: a category may be enriched in an ‘**fc**-multicategory’, a very general kind of 2-dimensional structure encompassing monoidal categories, plain multicategories, bicategories and double categories. It turns out that **fc**-multicategories also provide a natural setting for the bimodules construction. We also explore enrichment for some multicategories other than just categories. An extended application is given: the relaxed multicategories of Borchers and Soibelman are explained in terms of enrichment.

Contents

Introduction	2
1 Preliminaries	5
1.1 Multicategories	5
1.2 Free Multicategories	8
1.3 The Definition of Enriched Multicategory	9
1.4 Structured Categories	10
1.5 Opetopes	10
1.6 Some Two-Dimensional Structures	11
2 Enriched Categories	13
2.1 fc -Multicategories	13
2.2 Enriched Categories: Elementary Description	19
2.3 Enriched Categories: Examples	24
2.4 Enriched Functors: Elementary Description	29
2.5 Enriched Functors: Examples	32
2.6 Bimodules	35
3 Other Enriched Multicategories	41
3.1 fm -Multicategories	41
3.2 Enriched Plain Multicategories: Elementary Description	47
3.3 Enriched Plain Multicategories: Examples	52
3.4 The Hierarchies	52
4 Relaxed Multicategories	56
4.1 Basics	57
4.2 Relaxation via Enrichment	59
4.3 Relaxed Categories	61
4.4 Relaxed Monoidal Categories	64
4.5 Modifying the Codomain	69
A Free Multicategories	74
Bibliography	78

Introduction

At first, the idea of generalizing enrichment from categories to multicategories might seem rather bland—it’s easy to write down the definition of a plain multicategory enriched in abelian groups, for instance. But the situation is much more interesting than that, and the reason why lies in the question ‘what kind of structure do we enrich in?’

At the most simple level, it is clear enough that we can speak coherently not just about categories enriched in a monoidal category, but also about categories enriched in a (plain) multicategory: the essential point is that the composition morphisms

$$\mathbb{C}(B, C) \otimes \mathbb{C}(A, B) \longrightarrow \mathbb{C}(A, C)$$

only have a \otimes in the domain.

Next, what might a multicategory be enriched in? To answer this, we use the machinery of general multicategories developed in [Lei1] and [Lei2], which we assume in this paper. The basic idea there was that for a suitable monad T on a category \mathcal{E} , there is a species of multicategory (the ‘ T -multicategories’) in which the shape of the domain of an arrow is determined by what T is—e.g. if T is the free monoid monad then the domain of an arrow is a *sequence* of objects. In particular, for each n we constructed the set S_n of n -opetopes and the monad T_n on \mathbf{Set}/S_n , and in a T_n -multicategory the domain of an arrow is a pasting-together of labelled n -opetopes. A T_0 -multicategory is just a category, a T_1 -multicategory is an ordinary multicategory, and beyond that the T_n -multicategories are less familiar structures.

The answer to the question will turn out to be: an ordinary multicategory can be enriched in a T_2 -multicategory. So we can, for $n = 0$ and 1, speak of a T_n -multicategory enriched in a T_{n+1} -multicategory. In fact, this pattern persists for all n —so we end up with a hierarchy of types of multicategory, in which a multicategory of one type can be enriched in a multicategory of the next type.

The story doesn’t end there. In 1.3 we give a definition of enriched T -multicategory for general T . When T is taken to be the identity monad on \mathbf{Set} (recalling that a T -multicategory is then just a category) this definition gives a notion of a category enriched in an ‘**fc**-multicategory’. It turns out that ‘**fc**-multicategories’ are a very general kind of two-dimensional structure, encompassing not only ordinary multicategories but also bicategories and double categories; we will therefore be able to speak of categories enriched in any of

these structures. As an offshoot, **fc**-multicategories also appear to be the natural context in which to take (bi)modules, an operation usually performed just on bicategories.

The paper is laid out as follows. In Chapter 1 we mention the concepts we'll need from previous papers, and add in a few new pieces. One of them is the actual definition of enriched T -multicategory. This is not meant to be a self-evidently appropriate definition; the best justification I can give for it is to show what it means for various particular T 's. Even the most simple case is complex: this is the subject of Chapter 2, 'Enriched Categories', where we unwind the definition for $(\mathcal{E}, T) = (\mathbf{Set}, id)$.

Also included in Chapter 2 is the bimodules construction on **fc**-multicategories. This is partly because this chapter is where we first meet **fc**-multicategories, and partly because of the result that any category enriched in V yields a category enriched in $\mathbf{Bim}(V)$. The bimodules construction also produces an interesting structure, $\mathbf{Bim}(\mathbf{Span})$, with categories, functors and profunctors all incorporated.

In Chapter 3 we finally explore enrichment for some multicategories other than just categories. Enriched plain multicategories provide the first case, and we spend some time looking at them. In particular, we consider 'operads in a symmetric monoidal category', a notion used in topology, and see how they fit into our scheme. We also discuss the above-mentioned hierarchy of types of multicategory.

The final chapter, 'Relaxed Multicategories', stands slightly apart; it can be viewed as an extended application of the earlier theory. Also called pseudo-monoidal categories, relaxed multicategories have been used by various authors in the area of quantum algebra and quantum field theory ([BeDr], [Bor], [Soi]). We show that relaxed multicategories are just multicategories enriched in a certain T_2 -multicategory, which itself arises naturally from the general theory of multicategories. We then examine various related structures, including relaxed monoidal categories and 'relaxed categories'.

Throughout the paper we assume the existence of a free multicategory on any graph of the relevant kind. Conscience obliges me to include at least a sketch of a construction, but the details are so unimportant that it is relegated to an appendix.

A final note on size might be appropriate. We basically ignore the distinction between sets and classes, small and large, and so on: for instance, an ordinary multicategory officially has a *set* of objects and a *set* of arrows, but we will frequently talk about the multicategory of sets or abelian groups. In fact, the structures in which we enrich are almost always large. I have not attempted to provide any justification for this, and hope that the reader will not find the issue any more disturbing than is usual in category theory.

Acknowledgements

I am very grateful to Martin Hyland for the encouragement and advice he has given me in this project. I would also like to thank Craig Snyder for numerous

useful conversations on relaxed multicategories, and especially for his crucial example 4.3.1(ii) of a relaxed category. Richard Borchers too has given me the benefit of his wisdom on this topic, and I thank him for this.

This work was supported by a PhD grant from the EPSRC. The document was prepared in \LaTeX , using Paul Taylor's package for some of the diagrams. Craig Snyder and Tim Perkins have given me valuable technical assistance in creating the more complicated diagrams.

Chapter 1

Preliminaries

In this chapter we gather together the basic concepts on which the paper is built. Some of them are already written up in Chapters I and IV of [Lei2] (and some of them are also in [Lei1]): in that case we simply list the ideas. Others are new, and we go through them properly. Putting some of these basic concepts together gives us the definition of enriched multicategory (1.3) which, despite its brevity, will take most of the rest of the paper to unwind.

1.1 Multicategories

We recall the basic notions of multicategories from [Lei1] or [Lei2, I], or [Bur] or [Her], and make some notational changes from [Lei1] and [Lei2].

- We work with a cartesian monad T on a cartesian category \mathcal{E} , and just write ‘ (\mathcal{E}, T) is cartesian’. In [Lei1] and [Lei2], we wrote $(\mathcal{S}, *)$ rather than (\mathcal{E}, T) .
- Given cartesian (\mathcal{E}, T) , there’s a bicategory $\mathbf{Span}(\mathcal{E}, T)$ in which a 0-cell is an object of \mathcal{E} , a 1-cell $A \longrightarrow A'$ is a diagram $(TA \longleftarrow B \longrightarrow A')$ in \mathcal{E} , and 1-cell composition is defined by pullback. A 1-cell of the form $(TA \longleftarrow B \longrightarrow A)$ is called an (\mathcal{E}, T) -graph (on A), and (\mathcal{E}, T) -graphs form a category (\mathcal{E}, T) -**Graph**. Where possible we drop the \mathcal{E} , so we’ll speak of T -graphs and T -**Graph**.
- An (\mathcal{E}, T) -multicategory (or T -multicategory) is a monad in $\mathbf{Span}(\mathcal{E}, T)$; the category of (\mathcal{E}, T) -multicategories and maps (functors) between them is called (\mathcal{E}, T) -**Multicat** (or T -**Multicat**).
- A T -multicategory C is a diagram $(TC_0 \longleftarrow C_1 \longrightarrow C_0)$ in \mathcal{E} with arrows $C_1 \circ C_1 \xrightarrow{comp} C_1$ and $C_0 \xrightarrow{ids} C_1$ satisfying some axioms. We say that C is a multicategory on C_0 . A T -operad is a T -multicategory on 1.
- If $(\mathcal{E}, T) = (\mathbf{Set}, id)$ then T -**Multicat** = **Cat** and a T -operad is a monoid.

- Suppose $(\mathcal{E}, T) = (\mathbf{Set}, \text{free monoid})$. Then T -multicategories are called plain multicategories, and similarly operads; these are the original (non-symmetric) multicategories and operads. An arrow in a plain multicategory is represented by any one of the pictures

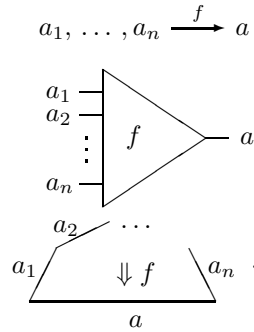

When $n = 0$, the first version looks like

$$\cdot \xrightarrow{f} a,$$

the second has no legs on the left-hand ('input') side, and the third is drawn as



We will also need to use transformations between functors between T -multicategories. Generalizing directly from categories:

Definition 1.1.1 Let (\mathcal{E}, T) be cartesian, let C and D be T -multicategories, and let $C \xrightarrow[F]{G} D$ be functors between them. A transformation $\alpha : F \rightarrow G$ is an arrow $\alpha : C_0 \rightarrow D_1$ such that

i.

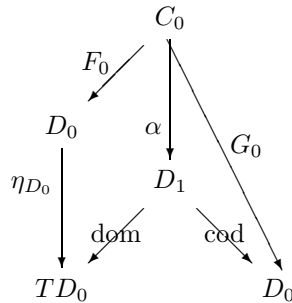

commutes

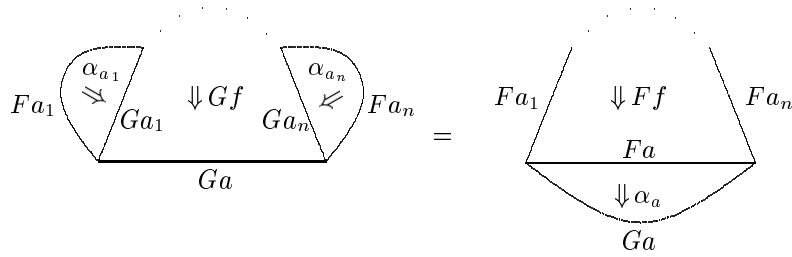

Figure 1a: Naturality of a transformation

ii. $D_1 \circ D_1 \xrightarrow{comp} D_1$ coequalizes the two maps $C_1 \rightrightarrows D_1 \circ D_1$ given by the two diagrams

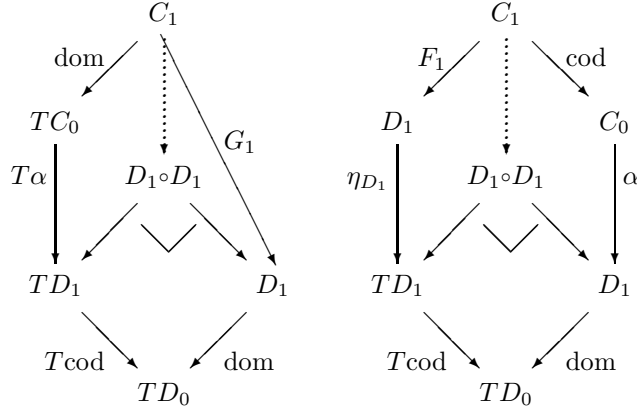

Figure 1a illustrates the second axiom in the case of plain multicategories; the first axiom merely states what the domain and codomain of α at an object of C are, so is also implicit in the figure. Later (2.6.1(v)) we will find a less arbitrary-looking definition of transformation.

Transformations can be composed in the usual ways, so that $T\text{-Multicat}$ becomes a 2-category.

Finally for this section, we describe two elementary ways of generating multicategories. These, together with the free multicategory construction, are what enable us to define enrichment.

Proposition 1.1.2 *Let (\mathcal{E}, T) be cartesian.*

i. *There is a functor*

$$I : \mathcal{E} \longrightarrow T\text{-Multicat}$$

which sends an object A of \mathcal{E} to a T -multicategory with graph

$$TA \xleftarrow{\text{pr}_1} TA \times A \xrightarrow{\text{pr}_2} A.$$

ii. There is a functor

$$M : \mathcal{E}^T \longrightarrow T\text{-Multicat}$$

which sends a T -algebra $(TA \xrightarrow{h} A)$ to a T -multicategory with graph

$$TA \xleftarrow{1} TA \xrightarrow{h} A.$$

Remark: Part (i) generalizes the familiar construction of the indiscrete category on a set. For plain multicategories, it sends a set A to the multicategory whose objects are the elements of A , and with one arrow $a_1, \dots, a_n \longrightarrow a$ for each $a_1, \dots, a_n, a \in A$. Part (ii) generalizes the construction of a strict monoidal category (hence a multicategory) from a monoid A , in which the objects of the monoidal category are the elements of A , the only arrows are identities, and the tensor is the multiplication of A .

Proof

- i. A T -multicategory on A is a monoid in the monoidal category of T -graphs on A (this being a one-object sub-bicategory of $\mathbf{Span}(\mathcal{E}, T)$). But $TA \xleftarrow{\text{pr}_1} TA \times A \xrightarrow{\text{pr}_2} A$ is the terminal T -graph on A , and a terminal object in a monoidal category is always a monoid in a unique way, so this graph has a unique multicategory structure. Extending this to morphisms is straightforward.
- ii. Again, there is a unique multicategory structure on the given graph: $TA \circ TA = T^2A$, and one is forced to put $\text{comp} = \mu_A$ and $\text{ids} = \eta_A$. The associativity and identity axioms for a multicategory then say exactly that $(TA \xrightarrow{h} A)$ is an algebra. Extending to morphisms is, again, straightforward. \square

1.2 Free Multicategories

Just as one can form the free category on a graph, one can form the free (\mathcal{E}, T) -multicategory on a (\mathcal{E}, T) -graph, as long as \mathcal{E} and T are suitably pleasant. In the appendix we give an exact definition of what it means for (\mathcal{E}, T) to be *suitable*, and prove the following result:

Theorem 1.2.1 *Let (\mathcal{E}, T) be suitable. Then the forgetful functor*

$$(\mathcal{E}, T)\text{-Multicat} \longrightarrow \mathcal{E}' = (\mathcal{E}, T)\text{-Graph}$$

has a left adjoint, the adjunction is monadic, and if T' is the resulting monad on \mathcal{E}' then (\mathcal{E}', T') is suitable.

When one takes the free category on an ordinary graph, the collection of objects (or vertices) is unchanged, and the corresponding fact for multicategories is encapsulated in a variant of the theorem. If S is an object of \mathcal{E} then we write $(\mathcal{E}, T)\text{-Multicat}_S$ for the subcategory of $(\mathcal{E}, T)\text{-Multicat}$ whose objects C have $C_0 = S$, and whose morphisms F have $F_0 = 1_S$; similarly, we write \mathcal{E}'_S for the category of (\mathcal{E}, T) -graphs on S .

Theorem 1.2.2 *Let (\mathcal{E}, T) be suitable and let $S \in \mathcal{E}$. Then the forgetful functor*

$$(\mathcal{E}, T)\text{-Multicat}_S \longrightarrow \mathcal{E}'_S$$

has a left adjoint, the adjunction is monadic, and if T'_S is the resulting monad on \mathcal{E}'_S then (\mathcal{E}'_S, T'_S) is suitable.

All the examples of (\mathcal{E}, T) in this paper will be suitable. This can be seen from these two theorems and the fact that (\mathbf{Set}, id) is suitable.

1.3 The Definition of Enriched Multicategory

Let T be a monad on a category \mathcal{E} . If (\mathcal{E}, T) is suitable then we obtain (\mathcal{E}', T') (as in 1.2) which is also suitable. Thus the notion of ‘ (\mathcal{E}', T') -multicategory’ makes sense. The goal of this section is to define, for any T' -multicategory V , the category of T -multicategories enriched in V .

Applying Proposition 1.1.2, we obtain a composite functor

$$\mathcal{E} \xrightarrow{I} (\mathcal{E}, T)\text{-Multicat} \simeq \mathcal{E}'^{T'} \xrightarrow{M} (\mathcal{E}', T')\text{-Multicat},$$

for any suitable (\mathcal{E}, T) .

Definition 1.3.1 *Let (\mathcal{E}, T) be suitable, let (\mathcal{E}', T') be as above, and let V be an (\mathcal{E}', T') -multicategory. Then a T -multicategory enriched in V consists of an object C_0 of \mathcal{E} together with a map $MI(C_0) \longrightarrow V$ in $(\mathcal{E}', T')\text{-Multicat}$.*

We usually denote the pair $(C_0, MI(C_0) \longrightarrow V)$ by the single letter C , and also call C a V -enriched T -multicategory.

Warning: Despite the terminology, there is apparently no ‘underlying’ T -multicategory of an enriched T -multicategory in general, as there is for categories enriched in a monoidal category.

Definition 1.3.2 *Let C and D be V -enriched (\mathcal{E}, T) -multicategories. Then a V -enriched functor from C to D consists of a map $f : C_0 \longrightarrow D_0$ in \mathcal{E} , together with a transformation*

$$\begin{array}{ccc} MI(C_0) & \xrightarrow{MI(f)} & MI(D_0) \\ & \searrow & \swarrow \\ & & V \end{array}$$

ϕ

We can compose enriched functors by pasting together the transformations, and thus we obtain a category $(\mathcal{E}, T)_V\text{-Multicat}$ of V -enriched (\mathcal{E}, T) -multicategories.

1.4 Structured Categories

In [Lei1, 4.3] and [Lei2, I.4] we defined (\mathcal{E}, T) -structured categories, which are to (\mathcal{E}, T) -multicategories as strict monoidal categories are to plain multicategories. We write (\mathcal{E}, T) -**Struc** for the category of (\mathcal{E}, T) -structured categories, and, as for multicategories, omit the ‘ \mathcal{E} ’ when we can. Any T -structured category has an underlying T -multicategory, and the forgetful functor U thus defined has a left adjoint:

$$T\text{-Struc} \begin{array}{c} \xrightarrow{U} \\ \dashv \\ \xleftarrow{F} \end{array} T\text{-Multicat.}$$

In the case of plain multicategories and strict monoidal categories, an object (respectively, arrow) in FC is a sequence of objects (respectively, arrows) in C .

In fact, a monoidal category does not have to be *strict* in order to have an underlying plain multicategory: any monoidal category will do. If D is the monoidal category then we define a plain multicategory C with the same objects as D and with

$$C(a_1, \dots, a_n; a) = D(a_1 \otimes \dots \otimes a_n, a).$$

In order for this to make sense, D must have n -fold tensor products for all n , not just $n = 0$ and $n = 2$. There are two attitudes we can take to this. One is to abandon the usual definition of monoidal category, and work instead with an ‘unbiased’ definition in which n -fold tensors are part of the structure (cf. [Lei2, p. 8]). The other is to use the traditional definition, but to derive n -fold tensors by, for instance, associating to the left. In both cases there is a canonical isomorphism between any two ways of tensoring a string of n objects, which means that we can define composition and identities in C , making it into a multicategory. In the second case there are many ways to choose n -fold tensors, but different choices give isomorphic C ’s.

Our final observation is that if D and D' are two monoidal categories, then a lax monoidal functor $D \longrightarrow D'$ is just the same as a map $U(D) \longrightarrow U(D')$ of their underlying multicategories. (When $D = 1$, this says that a map $1 \longrightarrow U(D')$ of multicategories is a monoid in D' .) Moreover, the definition of a lax monoidal functor from D to D' makes perfect sense when D' is any plain multicategory, just by replacing the tensor of D' by commas, and we still have the result that a multicategory map $U(D) \longrightarrow D'$ is the same as a lax monoidal functor from D to D' .

1.5 Opetopes

We will need to use the following concepts, as discussed on pages 63–72 of [Lei2]:

- The set S_n of n -opetopes and the monad T_n on \mathbf{Set}/S_n , defined recursively and satisfying the clauses on p. 53 below

- The geometric representation of opetopes and pasting diagrams
- T_n -structured categories and T_n -multicategories
- The T_n -structured category \mathbf{PD}_n of n -pasting diagrams, being the free T_n -structured category on the terminal T_n -multicategory
- $\mathbf{PD}_1 = \Delta$, the simplicial category; $\mathbf{PD}_2 = \mathbf{TR}$, so called because 2-pasting diagrams correspond one-to-one with trees
- The composite $\tau \circ (\tau_1, \dots, \tau_n)$ of trees, where $\tau \in \mathbf{TR}(n)$ is an n -leafed tree; the identity tree $\bullet \in \mathbf{TR}(1)$.

1.6 Some Two-Dimensional Structures

In this section we collect together various bicategories and double categories which we will need later. In a bicategory, $*$ will denote the horizontal composition of 2-cells. For the basics of double categories, see [KS] or even [Lei2, II.6].

- We have already met the bicategory $\mathbf{Span}(\mathcal{E}, T)$ in 1.1, for cartesian (\mathcal{E}, T) . We write $\mathbf{Span}(\mathcal{E})$ for $\mathbf{Span}(\mathcal{E}, id)$ and \mathbf{Span} for $\mathbf{Span}(\mathbf{Set})$.
- There is a 2-category \mathbf{Rel} of sets and relations, with:
 - 0-cells** sets
 - 1-cells** relations (i.e. a 1-cell $A \longrightarrow B$ is a subset of $A \times B$)
 - 2-cells** inclusions
 - 1-cell composition** usual composition of relations.
- Let \mathbf{Glue} be the sub-bicategory of \mathbf{Span} in which all 1-cells are of the form

$$\cdot \longleftarrow \cdot \longrightarrow \cdot$$

(i.e. both projections of the span are injective). This is also a sub-2-category of \mathbf{Rel} ; a 1-cell $X \longrightarrow Y$ in \mathbf{Glue} is a partial bijection from X to Y .

- Any topological space X has a *homotopy bicategory* associated to it. The objects are points of X , the 1-cells are paths in X , and the 2-cells are homotopy classes of path homotopies.
- Let W be a 2-category. Then we can construct from W two double categories, V and V' . In both cases, a 0-cell is a 0-cell of W ; a horizontal

1-cell is a 1-cell in W ; a vertical 1-cell is also a 1-cell in W ; and a 2-cell inside

$$\begin{array}{ccc} X & \xrightarrow{q} & X' \\ p \downarrow & & \downarrow p' \\ Y & \xrightarrow{r} & Y' \end{array}$$

is either a 2-cell $r \circ p \longrightarrow p' \circ q$ in W (in the case of V), or a 2-cell $p' \circ q \longrightarrow r \circ p$ in W (in the case of V'). In both cases, the composition is obvious.

- vi. There's a one-to-one correspondence between bicategories with precisely one 0-cell and monoidal categories. Given such a bicategory, \mathcal{B} , one defines a monoidal category whose objects are the 1-cells of \mathcal{B} and whose morphisms are the 2-cells, and with $b \otimes b' = b \circ b'$ and $\beta \otimes \beta' = \beta * \beta'$, where b, b' are 1-cells of \mathcal{B} and β, β' are 2-cells.

We could equally well have chosen the opposite orientation, so that $b \otimes b' = b' \circ b$ and $\beta \otimes \beta' = \beta' * \beta$. However, we try to stick to our choice, in Chapters 2 and 3 at least. The consequence is that ' \otimes and \circ go in the same direction': for example, this accounts for the apparently odd reversal of R and R' in 2.1.1(ii) (page 16).

- vii. A strict monoidal category with one object consists of a set V with two separate monoid structures which share a unit and commute with each other. This implies that the two monoid structures are equal and commutative: hence a one-object strict monoidal category is just a commutative monoid.

If we work through this argument for (weak) monoidal categories, we find that a one-object monoidal category is precisely a commutative monoid equipped with a distinguished invertible element. The way this comes about is that V has *a priori* three distinguished invertible elements: the associativity isomorphism a , and the left and right unit isomorphisms l and r . But the axioms force $l = r$ and $a = 1$, so we are just left with V and the invertible $r \in V$, satisfying no further axioms.

Chapter 2

Enriched Categories

The most basic example of enriched multicategories comes when we take $(\mathcal{E}, T) = (\mathbf{Set}, id)$. Since a (\mathbf{Set}, id) -multicategory is just a (small) category, an enriched (\mathbf{Set}, id) -multicategory will be called an *enriched category*. We will see later that this encompasses the traditional definition of a category enriched in a monoidal category.

If $(\mathcal{E}, T) = (\mathbf{Set}, id)$ then the structure V in which we are enriching is a $(\mathbf{Graph}, \mathbf{fc})$ -multicategory, where \mathbf{Graph} is the category of functors from $(\bullet \rightrightarrows \bullet)$ to \mathbf{Set} and \mathbf{fc} is the free category monad on \mathbf{Graph} . The first task, then, is to see what an \mathbf{fc} -multicategory is.

2.1 \mathbf{fc} -Multicategories

The graph structure of an \mathbf{fc} -multicategory V looks like

$$\begin{array}{ccc} & Y = (Y_1 \rightrightarrows Y_0) & \\ & \swarrow \quad \searrow & \\ \mathbf{fc}(X) = (X_1^* \rightrightarrows X_0) & & X = (X_1 \rightrightarrows X_0), \end{array}$$

where X and Y are graphs, the X_i and Y_j are sets, X_1^* is the set of paths in X , the horizontal arrows are set maps, and the diagonal arrows are graph maps. Think of elements of X_0 as 0-cells, elements of X_1 as horizontal 1-cells, elements

of Y_0 as vertical 1-cells, and elements of Y_1 as 2-cells, as in the picture

$$\begin{array}{ccccc}
 x_0 & \xrightarrow{\xi_1} & x_1 & \xrightarrow{\xi_2} & \cdots & \xrightarrow{\xi_n} & x_n \\
 \downarrow y & & & & \Downarrow \eta & & \downarrow y' \\
 x & \xrightarrow{\xi} & & & & & x'
 \end{array} \quad (2A)$$

($n \geq 0$, $x_i, x, x' \in X_0$, $\xi_i, \xi \in X_1$, $y, y' \in Y_0$, $\eta \in Y_1$). The multicategory structure on $\mathbf{fc}(X) \longleftarrow Y \longrightarrow X$ makes $X_0 \longleftarrow Y_0 \longrightarrow X_0$ into a category (that is, we can compose vertical 1-cells) and gives a composition

$$\begin{array}{ccccccc}
 \bullet & \xrightarrow{\xi_1^1} & \cdots & \xrightarrow{\xi_1^{k_1}} & \bullet & \xrightarrow{\xi_2^1} & \cdots & \xrightarrow{\xi_2^{k_2}} & \bullet & \cdots & \bullet & \xrightarrow{\xi_n^1} & \cdots & \xrightarrow{\xi_n^{k_n}} & \bullet \\
 \downarrow y_0 & & \Downarrow \eta_1 & & \downarrow & \Downarrow \eta_2 & & \downarrow & \cdots & \downarrow & \Downarrow \eta_n & & \downarrow & & \downarrow y_n \\
 \bullet & \xrightarrow{\xi_1} & \bullet & \xrightarrow{\xi_2} & \bullet & \xrightarrow{\xi_n} & \bullet & & \bullet & & \bullet & & \bullet & & \bullet \\
 \downarrow y & & & & \Downarrow \eta & & & & & & & & & & \downarrow y' \\
 \bullet & \xrightarrow{\xi} & \bullet & & \bullet & & \bullet & & \bullet & & \bullet & & \bullet & & \bullet
 \end{array} \quad (2B)$$

\mapsto

$$\begin{array}{ccc}
 \bullet & \xrightarrow{\xi_1^1} & \cdots & \xrightarrow{\xi_n^{k_n}} & \bullet \\
 \downarrow y \circ y_0 & & \Downarrow \eta^\circ(\eta_1, \eta_2, \dots, \eta_n) & & \downarrow y' \circ y_n \\
 \bullet & \xrightarrow{\xi} & \bullet & & \bullet
 \end{array}$$

($n \geq 0, k_i \geq 0$, with \bullet 's representing elements of X_0) and identities

$$x \xrightarrow{\xi} x' \quad \mapsto \quad \begin{array}{ccc}
 x & \xrightarrow{\xi} & x' \\
 1_x \downarrow & \Downarrow 1_\xi & \downarrow 1_{x'} \\
 x & \xrightarrow{\xi} & x'
 \end{array}$$

The composition and identities obey associativity and identity laws.

The pictures in the nullary case are worth a short comment. When $n = 0$, the 2-cell of diagram (2A) is drawn as

$$\begin{array}{ccc}
 x_0 & \xlongequal{\quad} & x_0 \\
 \downarrow y & & \downarrow y' \\
 x & \xrightarrow{\xi} & x'
 \end{array}$$

	not ‘representable’	‘representable’	‘uniformly representable’
no vertical degeneracy	fc -multicategory	weak double category	double category
vertically discrete	vertically discrete fc -multicategory	bicategory	2-category
vertically trivial	plain multicategory	monoidal category	strict monoidal category

Table 2.1: Some of the possible degeneracies of an **fc**-multicategory. The entries are explained on pages 15–18.

and the diagram (2B) of pasted-together 2-cells is drawn as

$$\begin{array}{c}
 w_0 \equiv w_0 \\
 y_0 \downarrow = \downarrow y_0 \\
 x_0 \equiv x_0 \\
 y \downarrow \Downarrow \eta \downarrow y' \\
 x \xrightarrow{\xi} x'.
 \end{array}$$

The composite of this last diagram will be written as $\eta \circ y_0$.

As such, **fc**-multicategories are not familiar, but various degenerate cases are. These are set out below, and summarized in Table 2.1.

Examples 2.1.1

- i. Any double category (see 1.6) has an underlying **fc**-multicategory, defined by saying that a 2-cell

$$\begin{array}{ccccc}
 x_0 & \xrightarrow{\xi_1} & x_1 & \xrightarrow{\xi_2} & \dots & \xrightarrow{\xi_n} & x_n \\
 y \downarrow & & & & \Downarrow \eta & & \downarrow y' \\
 x & \xrightarrow{\xi} & & & & & x'
 \end{array}$$

in the **fc**-multicategory is just a 2-cell

$$\begin{array}{ccc}
 x_0 & \xrightarrow{\xi_n \circ \dots \circ \xi_1} & x_n \\
 y \downarrow & & \downarrow y' \\
 x & \xrightarrow{\xi} & x'
 \end{array}$$

in the double category.

- ii. In fact, (i) works even when the double category is ‘horizontally weak’. A typical example of such a structure has rings (not necessarily commutative) as its 0-cells, bimodules as its horizontal 1-cells, ring homomorphisms as its vertical 1-cells, and ‘homomorphisms of bimodules with respect to the vertical changes of base’ as 2-cells. In other words, a 2-cell looks like

$$\begin{array}{ccc}
 & M & \\
 R & \xrightarrow{\quad + \quad} & R' \\
 \downarrow f & \Downarrow \phi & \downarrow f' \\
 S & \xrightarrow{\quad + \quad} & S' \\
 & N &
 \end{array}$$

where R, R', S, S' are rings, M is an (R', R) -bimodule (i.e. simultaneously a left R' -module and a right R -module) and N similarly, f and f' are ring homomorphisms, and $\phi : M \longrightarrow N$ is an abelian group homomorphism such that

$$\phi(r'.m.r) = f'(r').\phi(m).f(r).$$

(The crossed arrow is used here to indicate a bimodule.) Composition of horizontal 1-cells is tensor, composition of vertical 1-cells is the usual composition of ring homomorphisms, and composition of 2-cells is defined in an evident way. The essential point is that although the 0-cells and vertical 1-cells form a category, the same cannot be said of the horizontal structure: tensor only obeys the associative and unit laws up to coherent isomorphism. We do not bother to write down the full definition of a weak double category, since it is just an easy extension of the definition of a bicategory.

(In order to have a 1-cell ‘ $\xi_n \circ \dots \circ \xi_1$ ’, as in the second diagram of (i), we must either define weak double category in an unbiased manner, or else choose a particular n -fold composition. This is exactly the same issue as was discussed on page 10 for monoidal categories and plain multicategories.)

Another example has small categories as 0-cells, profunctors as horizontal 1-cells, functors as vertical 1-cells, and ‘morphisms of profunctors with respect to the vertical functors’ as 2-cells. We will explore both these examples further, and give proper definitions, in section 2.6.

- iii. Suppose that all vertical 1-cells are the identity, i.e. $Y_0 = X_0$ and

$$(X_0 \longleftarrow Y_0 \longrightarrow X_0) = (X_0 \xleftarrow{1} X_0 \xrightarrow{1} X_0),$$

so that the whole graph looks like

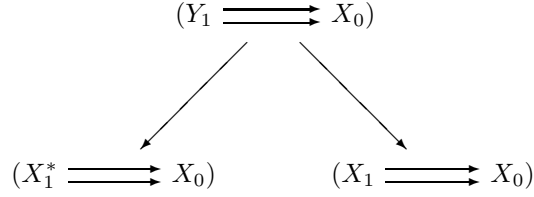

or in another format,

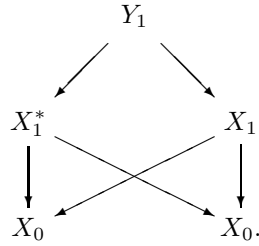

Then we call the **fc**-multicategory *vertically discrete* (since the category of 0-cells and vertical 1-cells is discrete). It consists of some objects x, x', \dots , some 1-cells ξ, ξ', \dots , and some 2-cells looking like

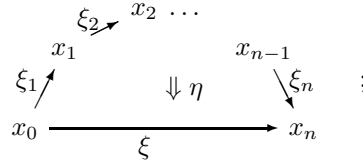

there is a composition

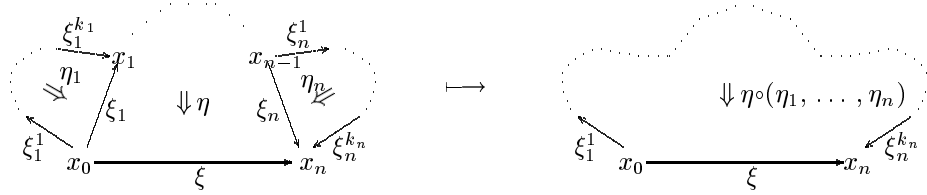

and an identity function

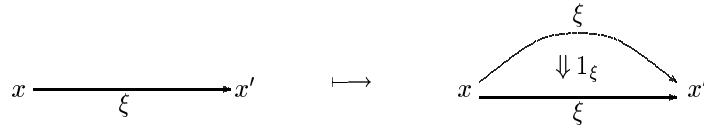

which obey the inevitable associativity and identity laws.

- iv. Any bicategory gives rise to a vertically discrete **fc**-multicategory, in the same way that any weak double category gives rise to an **fc**-multicategory (and with similar observations on n -fold composites).

- v. Suppose we are back in the situation of (iii), with the extra condition that there's only one object. Thus $X_0 = Y_0 = 1$, and the graph looks like

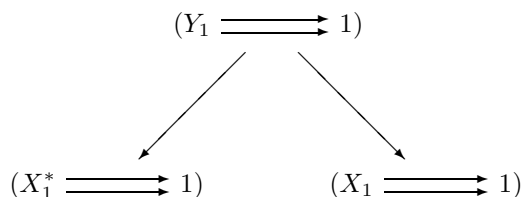

or

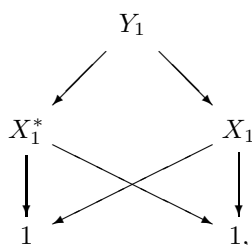

where X_1^* is the free monoid on X_1 . The **fc**-multicategory then consists of some 'horizontal 1-cells' ξ, ξ', \dots and some '2-cells' η, η', \dots , looking like

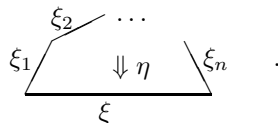

In other words, it's just a plain multicategory, where the ξ 's are now objects and the η 's are arrows. So a plain multicategory is a special kind of **fc**-multicategory.

- vi. Specializing the previous example further, we finally see that a monoidal category is a rather special kind of **fc**-multicategory, since any (strict or weak) monoidal category has an underlying plain multicategory (see 1.4). So it will make sense in our language to speak of a category enriched in a monoidal category. Alternatively, a monoidal category is a one-object bicategory, and any bicategory is an **fc**-multicategory, so a monoidal category becomes an **fc**-multicategory in this way too. (It makes no difference, up to isomorphism, whether we obtain an **fc**-multicategory from a given monoidal category by going via plain multicategories or bicategories.)
- vii. A one-object monoidal category is a commutative monoid with a distinguished invertible element (see page 12). We will therefore be able to speak of a category enriched in such a structure. This is, of course, encompassed in the traditional definition of enriched category.

2.2 Enriched Categories: Elementary Description

Having seen what a general **fc**-multicategory is, we can now describe what $MI(A)$ is, for a set A . Firstly, $I(A) = (A \longleftarrow A \times A \longrightarrow A)$ and

$$\mathbf{fc}(I(A)) = (A \xleftarrow{\text{first}} \coprod_{n \geq 1} A^n \xrightarrow{\text{last}} A).$$

So, the graph of $MI(A)$ is

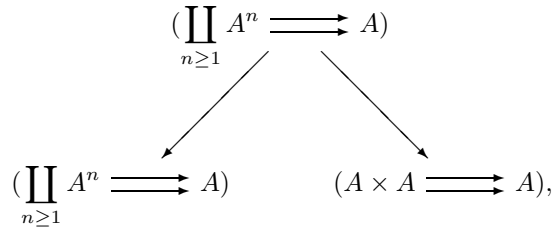

or

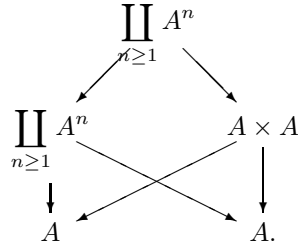

The 0-cells of $MI(A)$ are the elements of A ; the only vertical 1-cells are identities (so it is vertically discrete); there is one horizontal 1-cell $a \longrightarrow b$ for each $a, b \in A$; and for each a_0, \dots, a_n ($n \geq 0$) there is a unique 2-cell

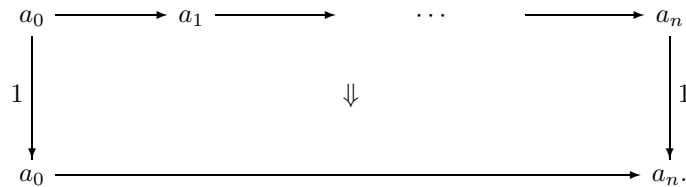

The composition and identities are uniquely determined.

We can now give an elementary description of a category enriched in an **fc**-multicategory V . It consists of a set C_0 ('of objects') together with a map $MI(C_0) \longrightarrow V$ of **fc**-multicategories: that is, for each $a \in C_0$ a 0-cell $C[a]$ of V , for each $a, b \in C_0$ a horizontal 1-cell

$$C[a, b] : C[a] \longrightarrow C[b]$$

in V , and for each sequence a_0, \dots, a_n ($n \geq 0$) in A a 2-cell

$$\begin{array}{ccccccc}
 C[a_0] & \xrightarrow{C[a_0, a_1]} & C[a_1] & \xrightarrow{C[a_1, a_2]} & \dots & \xrightarrow{C[a_{n-1}, a_n]} & C[a_n] \\
 \downarrow 1 & & & \Downarrow \kappa_{a_0, \dots, a_n} & & & \downarrow 1 \\
 C[a_0] & \xrightarrow{\hspace{10em}} & C[a_n] & & & & C[a_n]
 \end{array}$$

in V such that

$$\begin{array}{c}
 \begin{array}{ccccccc}
 \bullet & \xrightarrow{\dots} & \bullet & \xrightarrow{\dots} & \bullet & \dots & \bullet \\
 \downarrow & \Downarrow \kappa & \downarrow & \Downarrow \kappa & \downarrow & \dots & \downarrow \\
 \bullet & \xrightarrow{\dots} & \bullet & \xrightarrow{\dots} & \bullet & \dots & \bullet \\
 \downarrow & & & \Downarrow \kappa & & & \downarrow \\
 \bullet & \xrightarrow{\hspace{10em}} & \bullet & & & & \bullet
 \end{array} \\
 = \\
 \begin{array}{ccc}
 \bullet & \xrightarrow{\dots} & \bullet \\
 \downarrow & \Downarrow \kappa & \downarrow \\
 \bullet & \xrightarrow{\hspace{10em}} & \bullet
 \end{array}
 \end{array}$$

and

$$\begin{array}{ccc}
 C[a_0] \xrightarrow{C[a_0, a_1]} C[a_1] & & C[a_0] \xrightarrow{C[a_0, a_1]} C[a_1] \\
 \downarrow 1 \quad \Downarrow 1 \quad \downarrow 1 & = & \downarrow 1 \quad \Downarrow \kappa_{a_0, a_1} \quad \downarrow 1 \\
 C[a_0] \xrightarrow{C[a_0, a_1]} C[a_1] & & C[a_0] \xrightarrow{C[a_0, a_1]} C[a_1]
 \end{array}$$

An easy induction shows that it is equivalent to specify just the binary and nullary composites in C . Thus a category enriched in V consists of:

- a set C_0
- for each $a \in C_0$, a 0-cell $C[a]$ of V
- for each $a, b \in C_0$, a horizontal 1-cell $C[a] \xrightarrow{C[a, b]} C[b]$ in V
- for each $a, b, c \in C_0$, a 2-cell

$$\begin{array}{ccccc}
 C[a] & \xrightarrow{C[a, b]} & C[b] & \xrightarrow{C[b, c]} & C[c] \\
 \downarrow 1 & & & \Downarrow \kappa_{a, b, c} & \downarrow 1 \\
 C[a] & \xrightarrow{\hspace{10em}} & C[c] & & C[c]
 \end{array}$$

- for each $a \in C_0$, a 2-cell

$$\begin{array}{ccc}
 C[a] & \xlongequal{\quad} & C[a] \\
 \downarrow 1 & \Downarrow \kappa_a & \downarrow 1 \\
 C[a] & \xrightarrow{C[a, a]} & C[a]
 \end{array}$$

obeying the usual associativity and identity laws (as for a monad).

When we ask what a category enriched in an **fc**-multicategory V is, we do not have to consider any of the vertical 1-cells of V apart from the identities, since $MI(C_0)$ is vertically discrete for any set C_0 . Thus if \bar{V} is the underlying vertically discrete **fc**-multicategory of V —that is, V with all non-identity vertical 1-cells discarded—then a category enriched in V is the same thing as a category enriched in \bar{V} . The vertical 1-cells in V will, however, play a significant role when we move on to discuss *maps* between V -enriched categories.

Before giving specific examples of enriched categories, we state what the definition of a V -enriched category reduces to when V is degenerate in some way such as those listed above. By the foregoing comments, we may assume immediately that V is vertically discrete.

Examples 2.2.1

i. Let V be a bicategory. Then a category enriched in V consists of:

- a set C_0
- for each $a \in C_0$, an object $C[a]$ of V
- for each $a, b \in C_0$, a 1-cell $C[a] \xrightarrow{C[a, b]} C[b]$ in V
- for each $a, b, c \in C_0$, a 2-cell

$$\begin{array}{ccc}
 & C[b, c] \circ C[a, b] & \\
 & \curvearrowright & \\
 C[a] & \downarrow & C[c] \\
 & \curvearrowleft & \\
 & C[a, c] &
 \end{array}$$

- for each $a \in C_0$, a 2-cell

$$\begin{array}{ccc}
 & 1 & \\
 & \curvearrowright & \\
 C[a] & \downarrow & C[a] \\
 & \curvearrowleft & \\
 & C[a, a] &
 \end{array}$$

such that these 2-cells satisfy associativity and identity axioms.

This notion of a category enriched in a bicategory is just the same as that of Walters et al (see [BCSW], [CKW], [Wal]). It is also the same as Bénabou's notion of a polyad. (A *polyad* in a bicategory V consists of a set C_0 and a lax functor $\mathcal{I}(C_0) \longrightarrow V$, where $\mathcal{I}(C_0)$ is the 2-category whose object-set is C_0 and each of whose hom-categories is $\mathbf{1}$. See [Bén] for details.) Polyads were so called because a one-object polyad is a monad (in the bicategory V); we can also see directly from our definition that a category enriched in V is just a monad in V when $C_0 = \mathbf{1}$.

- ii. When V is a monoidal category, our definition of a category enriched in V coincides with the traditional one. This can be seen by regarding V as a bicategory with one object and using the data and axioms in (i).
- iii. Degenerating in a different direction, let V be a plain multicategory. Then a V -enriched category consists of

- a set C_0
- for each $a, b, c \in C_0$, an arrow

$$C[a, b], C[b, c] \xrightarrow{\kappa_{a,b,c}} C[a, c]$$

in V

- for each $a \in C_0$, an arrow

$$\cdot \xrightarrow{\kappa_a} C[a, a]$$

in V (where \cdot denotes the empty sequence)

such that the associativity and identity axioms hold:

$$\begin{aligned} \kappa_{acd} \circ (\kappa_{abc}, 1) &= \kappa_{abd} \circ (1, \kappa_{bcd}) \\ \kappa_{aab} \circ (\kappa_a, 1) &= 1 = \kappa_{abb} \circ (1, \kappa_b) \end{aligned}$$

for all $a, b, c, d \in C_0$ (Figure 2a).

Of course, enrichment in a monoidal category is a special case of this.

- iv. A plain operad V is a one-object plain multicategory, so we can speak of a category enriched in V . Such consists of

- a set A
- for each $a, b, c \in A$, an element $[a, b, c]$ of $V(2)$
- for each $a \in A$, an element $[a]$ of $V(0)$

satisfying the equations

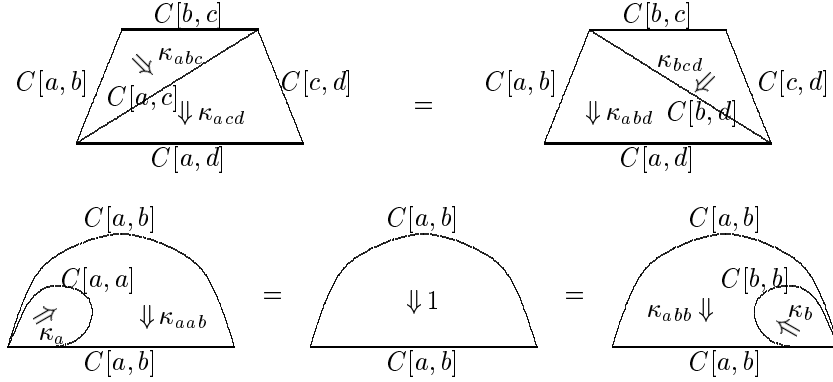

Figure 2a: Associativity and identity axioms for a category enriched in a plain multicategory

$$\begin{aligned}
 [a, c, d] \circ ([a, b, c], 1) &= [a, b, d] \circ (1, [b, c, d]) \\
 [a, a, b] \circ ([a], 1) &= 1 = [a, b, b] \circ (1, [b])
 \end{aligned}$$

for all $a, b, c, d \in A$.

- v. As observed on page 12, a one-object monoidal category is a commutative monoid V with a distinguished invertible element r . Either by treating this as a special case of a monoidal category, or by looking at its underlying operad, we can see that a category enriched in (V, r) consists of a set A and functions

$$\begin{aligned}
 [-, -, -] : A \times A \times A &\longrightarrow V \\
 [-] : A &\longrightarrow V
 \end{aligned}$$

satisfying the equations

$$\begin{aligned}
 [a, c, d] + [a, b, c] &= [a, b, d] + [b, c, d] \\
 [a, a, b] + [a] &= r = [a, b, b] + [b]
 \end{aligned}$$

for all $a, b, c, d \in A$.

- vi. Any category can be regarded as a locally discrete 2-category, so in this sense we can speak of a category enriched in a category. That is: fix a category W , and let V be the 2-category whose 0- and 1-cells form the category W , and all of whose 2-cells are identities. Then a category enriched in V works out to be a set C_0 together with a functor $I(C_0) \longrightarrow W$, where $I(C_0)$ is the indiscrete category on C_0 .
- vii. Similarly, any category W can be regarded as a locally indiscrete 2-category V —thus the 0- and 1-cells of V form the category W , and there is precisely one 2-cell between any two parallel 1-cells. A category enriched in V is a set C_0 together with a graph map $I(C_0) \longrightarrow W$.

2.3 Enriched Categories: Examples

We now proceed to some specific examples of categories enriched in **fc**-multicategories. Along the way, we define some **fc**-multicategories which for now will be vertically discrete, but later will be redefined with more interesting vertical structure. As observed before, the vertical structure is immaterial when we are just considering enriched categories (rather than functors), so this redefinition will do no harm.

Examples 2.3.1

- i. Write $\mathbf{Bim}(\mathbf{Ab})$ for the weak double category of rings and bimodules, described in Example 2.1.1(ii). Any category C enriched in the monoidal category $(\mathbf{Ab}, \otimes, \mathbb{Z})$ gives rise to a category C' enriched in $\mathbf{Bim}(\mathbf{Ab})$. This really just amounts to the observations that if a is an object of C then the abelian group $C[a, a]$ is in fact a ring, and that if a and b are objects of C then the abelian group $C[a, b]$ is both a left $C[b, b]$ -module and a right $C[a, a]$ -module. Thus we take C'_0 to be the set of objects of C , define $C'[a]$ to be $C[a, a]$ with ring structure given by composition, and define $C'[a, b]$ to be $C[a, b]$ with bimodule structure given by composition.
- ii. The additive structure played no essential role in the previous example. So, write $\mathbf{Bim}(\mathbf{Set})$ for the weak double category whose 0-cells are monoids, whose horizontal 1-cells are sets with commuting left and right actions by the monoids on either side, whose vertical 1-cells are monoid homomorphisms, and the rest of whose structure is also defined analogously to that of $\mathbf{Bim}(\mathbf{Ab})$. (A rigorous version of this will be given in section 2.6.) Then *any* category naturally gives rise to a category enriched in $\mathbf{Bim}(\mathbf{Set})$, since any category is naturally enriched in the monoidal category $(\mathbf{Set}, \times, 1)$. Explicitly, if C is a (small) category then let C'_0 be the set of objects of C , let $C'[a]$ be $C(a, a)$ with monoid structure given by composition, and let $C'[a, b]$ be $C(a, b)$ with the obvious actions by $C'[a]$ and $C'[b]$.
- iii. As a variation on the previous example, let C be any category, and again define a category C' enriched in $\mathbf{Bim}(\mathbf{Set})$. This time, let $C'[a]$ be the automorphism group $\mathbf{Aut}(a)$ of a in C , rather than the set of all endomorphisms of a . Everything else is left the same.
- iv. Let \mathbf{Span} be the bicategory of spans (in \mathbf{Set} ; see 1.6(i)). A category enriched in \mathbf{Span} consists of
 - a set C_0
 - for each $a \in C_0$, a set $C[a]$
 - for each $a, b \in C_0$, a span

$$C[a] \longleftarrow C[a, b] \longrightarrow C[b]$$

- for each $a, b, c \in C_0$, a function

$$\text{comp} : C[a, b] \times_{C[b]} C[b, c] \longrightarrow C[a, c]$$

- for each $a \in C_0$, a function

$$\text{ids} : C[a] \longrightarrow C[a, a]$$

such that these functions satisfy domain, codomain, associativity and identity axioms. In other words, it is a category D , a set I , and a function $D_0 \longrightarrow I$, where D_0 is the set of objects of D . Here we have taken $I = C_0$, $D_0 = \coprod_{a \in C_0} C[a]$, $D_1 = \coprod_{a, b \in C_0} C[a, b]$, projection as the function $D_0 \longrightarrow I$, and the obvious category structure on D .

- v. For some actual categories enriched in **Span**, we could take D to be the category of real manifolds and continuous functions, $I = \mathbb{N}$, and $D_0 \longrightarrow I$ to be the function assigning dimension. Similarly, we could take D to be the category of finite-dimensional vector spaces over a fixed field, and again $I = \mathbb{N}$ and the dimension function. Or we could take a skeleton of this: let D be the category whose objects are the natural numbers, and with

$$D(m, n) = M_{n, m} = \{n \times m \text{ matrices}\}$$

and $D_0 \longrightarrow I$ the identity function on \mathbb{N} . More abstractly, we could take D to be any small category, I to be either the set of objects of D or the set of isomorphism classes of objects of D , and the natural function $D_0 \longrightarrow I$ in each case.

- vi. Let **Prof** be the weak double category mentioned at the end of Example 2.1.1(ii), whose underlying bicategory is the ‘bicategory of profunctors’. A category enriched in **Prof** consists of

- a set C_0
- for each $a \in C_0$, a category $C[a]$
- for each $a, b \in C_0$, a profunctor $C[a, b] : C[a] \dashrightarrow C[b]$
- for each $a, b, c \in C_0$, a morphism

$$C[b, c] \otimes C[a, b] \longrightarrow C[a, c]$$

of profunctors

- for each $a \in C_0$, a morphism

$$C[a] \longrightarrow C[a, a]$$

of profunctors, where on the left-hand side, $C[a]$ denotes the identity profunctor on $C[a]$;

these morphisms of profunctors are to satisfy associativity and identity laws. For instance:

- $C_0 = \mathbb{N}$, $C[n]$ is the category of n -dimensional vector spaces over a fixed field, and the functor

$$C[m, n] : C[m]^{\text{op}} \times C[n] \longrightarrow \mathbf{Set}$$

sends a pair (U, W) to the set of linear maps $U \longrightarrow W$.

- $C_0 = \mathbb{N}$ and $C[n]$ is the multiplicative monoid $M_{n,n}$ of $n \times n$ matrices with coefficients in a fixed field, viewed as a category. A functor

$$C[m]^{\text{op}} \times C[n] \longrightarrow \mathbf{Set}$$

is a set with compatible left action by $M_{n,n}$ and right action by $M_{m,m}$; we thus take the profunctor $C[m, n]$ to be the set $M_{n,m}$ with actions by matrix multiplication.

- In the previous example, we could change $C[n]$ from $M_{n,n}$ to the general linear group GL_n (or any other submonoid of $M_{n,n}$), and leave the rest of the definition the same.

The first two of these examples arise in a mechanical way from the examples of categories enriched in \mathbf{Span} ((v) above). We will see later (2.6) that $\mathbf{Prof} = \mathbf{Bim}(\mathbf{Span})$ in an appropriate sense, and that a category enriched in V gives rise to a category enriched in $\mathbf{Bim}(V)$. So far, V has just been a bicategory, but the \mathbf{Bim} construction works for any \mathbf{fc} -multicategory V : indeed, this appears to be its natural setting.

- vii. Let V be the bicategory $\mathbf{Span}(\mathcal{E}, T)$, where T is a cartesian monad on a cartesian category \mathcal{E} . A category enriched in $\mathbf{Span}(\mathcal{E}, T)$ consists of

- a set C_0
- for each $a \in C_0$, an object $C[a]$ of \mathcal{E}
- for each $a, b \in C_0$, a span

$$TC[a] \longleftarrow C[a, b] \longrightarrow C[b]$$

- for each $a, b, c \in C_0$, a morphism

$$comp : C[b, c] \circ C[a, b] \longrightarrow C[a, c]$$

in \mathcal{E}

- for each $a \in C_0$, a morphism

$$ids : C[a] \longrightarrow C[a, a]$$

in \mathcal{E} ,

such that $comp$ and ids are graph maps and satisfy associativity and identity axioms.

- viii. Let V be the bicategory **Span**(**Set**, free monoid). We describe a V -enriched category associated to any monoid.

Fix a monoid M . Denote by $\mathbf{Sub}(M)$ the set of all submonoids of M . Let D be the category whose objects are pairs (N, X) with $N \in \mathbf{Sub}(M)$ and X a left N -set, and in which an arrow $(N, X) \longrightarrow (N', X')$ consists of the inclusion $N \subseteq N'$ and a morphism $X \longrightarrow X'$ of N -sets. Note that if $(N, X_1), \dots, (N, X_k)$ are all objects of D then we obtain an object $(N, X_1 \times \dots \times X_k)$ of D : for $X_1 \times \dots \times X_k$ is naturally a left $(N \times \dots \times N)$ -set, and therefore becomes an N -set via the diagonal map $N \longrightarrow N \times \dots \times N$. In other words, we put

$$n.(x_1, \dots, x_k) = (n.x_1, \dots, n.x_k).$$

We have now described enough structure to make a V -enriched category. For let $C_0 = \mathbf{Sub}(M)$ and let $C[N]$ be the collection of left N -sets (or a small subcollection, if one prefers); to define the span

$$C[N]^* \longleftarrow C[N, N'] \longrightarrow C[N'],$$

put

$$C[N, N']((X_1, \dots, X_k), X') = D((N, X_1 \times \dots \times X_k), (N', X')).$$

Here $*$ indicates free monoid, and $X_1 \times \dots \times X_k$ is an N -set as defined above. To describe $C[N, N']$ in another way: if $N \not\subseteq N'$ then $C[N, N'] = \emptyset$, and if $N \subseteq N'$ then an element of $C[N, N']$ consists of a sequence X_1, \dots, X_k of N -sets ($k \geq 0$), an N' -set X' , and a function $X_1 \times \dots \times X_k \xrightarrow{f} X'$ such that

$$f(n.x_1, \dots, n.x_k) = n.f(x_1, \dots, x_k).$$

Composition and identities work in an evident way.

- ix. A category enriched in **Rel** (see 1.6(ii)) consists of a set I , a preordered set D , and a map $\pi : D \longrightarrow I$ of sets, by just the same reasoning as we used for enrichment in **Span** (part (iv)).
- x. A category enriched in **Glue** (see 1.6(iii)) consists of I, D and π as in (ix), with the property that for any $a \in D$ and $j \in I$, the sets

$$\begin{aligned} &\{b \in D \mid b \leq a \text{ and } \pi(b) = j\}, \\ &\{b \in D \mid b \geq a \text{ and } \pi(b) = j\} \end{aligned}$$

each have at most one element.

- xi. A set with an indexed family of subsets gives a category enriched in **Glue**. For let $(C_i)_{i \in I}$ be a family of subsets of a set S . Put $C_0 = I$, $C[i] = C_i$, $C[i, j] = C_i \cap C_j$, and take

$$C[i] \longleftarrow C[i, j] \longrightarrow C[j]$$

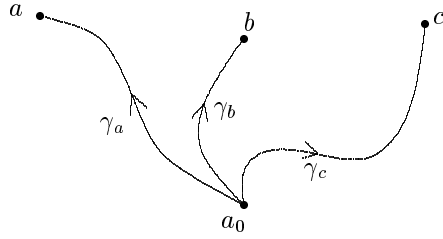

Figure 2b: Paths in A

to be the obvious inclusions. Then

$$C[j, k] \circ C[i, j] = C_i \cap C_j \cap C_k \subseteq C_i \cap C_k = C[i, k]$$

and

$$C[i] = C_i = C_i \cap C_i = C[i, i]$$

so composition and identities can be defined (in a unique way), and the axioms are satisfied. Or to put it in the way worked out in (x), the preordered set D is the set $\coprod_{i \in I} C_i$ whose preorder is the equivalence relation induced by the function $\coprod_{i \in I} C_i \longrightarrow S$, and $\coprod_{i \in I} C_i \longrightarrow I$ is projection.

- xii. A more complicated version of the previous example: take a family $(C_i)_{i \in I}$ of subsets of a set S as before, but this time suppose I has a preorder on it. Put $C[i] = C_i$, and

$$C[i, j] = \begin{cases} C_i \cap C_j & \text{if } i \leq j \\ \emptyset & \text{otherwise.} \end{cases}$$

The axioms are still satisfied. For the alternative formulation, the preordered set D is $\coprod_{i \in I} C_i$, with $(i, a) \leq (i', a')$ if and only if $i \leq i'$ in I and $a = a'$ as elements of S . Thus the previous example corresponded to I having the indiscrete preorder.

- xiii. This example is in a different vein. Let A be a nonempty path-connected space, so that we can choose a basepoint a_0 and a path γ_a from a_0 to each point a , and let V be the homotopy bicategory of A (see 1.6(iv)). Then we obtain a category C enriched in V :

- $C_0 = A$
- $C[a] = a$ for $a \in A$
- $C[a, b] = \gamma_b \circ \gamma_a^*$, a path from a to b , where γ_a^* is γ_a run backwards
- the composition 2-cell for (a, b, c) is a homotopy from $\gamma_c \circ \gamma_b^* \circ \gamma_b \circ \gamma_a^*$ to $\gamma_c \circ \gamma_a^*$, taken up to homotopy, and this comes from the obvious homotopy from $\gamma_b^* \circ \gamma_b$ to the constant path at a_0 (Figure 2b).

- the identity 2-cell $1_{C[a]} \longrightarrow C[a, a]$ is the obvious homotopy from the constant path at a to $\gamma_a \circ \gamma_a^*$ (taken up to homotopy).

It is straightforward to check the associativity and identity axioms.

- xiv. Finally, we give three related examples of a category enriched in a commutative monoid (see 2.2.1(v)). For simplicity, we stick to the case $r = 0$.

For the first example, let **Line** be the category of 1-dimensional real vector spaces (or a small full subcategory, if one prefers). For every pair (l, l') of objects of **Line**, choose an isomorphism $\alpha_{ll'} : l \longrightarrow l'$. Let A be the collection of objects of **Line**. Then for each $l, l', l'' \in A$, there is a unique real number $[l, l', l'']$ such that $\alpha_{l'l''} \circ \alpha_{ll'} = [l, l', l''] \cdot \alpha_{ll'}$, and for each $l \in A$ there is a unique real number $[l]$ such that $[l] \cdot \alpha_{ll} = I$. If we take V to be the commutative monoid of real numbers under multiplication then the axioms are satisfied.

For the second example, let A be any set, let V be any commutative monoid, and let $\gamma : A \times A \longrightarrow V$ be any function such that $\gamma(a, b)$ is invertible for all $a, b \in A$. If we put

$$\begin{aligned} [a, b, c] &= \gamma(a, b) + \gamma(b, c) - \gamma(a, c) \\ [a] &= -\gamma(a, a) \end{aligned}$$

then the axioms are satisfied and we obtain a category enriched in V .

For the third example, let A be any subset of the plane. For each $a, b \in A$ choose a smooth path γ_{ab} from a to b . Let $[a, b, c]$ be the area bounded by the loop formed by γ_{ab} , γ_{bc} , and γ_{ac}^* (i.e. γ_{ac} run backwards). (Here, ‘area’ might be positive or negative: we choose an orientation on the plane so that, say, the area bounded by an anticlockwise loop is positive.) Let $[a] = -(\text{area bounded by } \gamma_{aa})$. Then we obtain a category enriched in the abelian group of real numbers under addition. The axioms assert obvious facts about area.

We have now seen what enriched categories look like in elementary terms, and looked at some examples. Next, we turn to the morphisms of enriched categories: enriched functors.

2.4 Enriched Functors: Elementary Description

Let V be an **fc**-multicategory, and let C and D be categories enriched in V . Recall from Definition 1.3.2 that a V -enriched functor from C to D consists of a function $F_0 : C_0 \longrightarrow D_0$ together with a transformation

$$\begin{array}{ccc} MI(C_0) & \xrightarrow{MI(F_0)} & MI(D_0) \\ & \searrow & \swarrow \\ & & V \end{array}$$

F

of **fc**-multicategories. Explicitly, this means that an enriched functor $C \longrightarrow D$ consists of:

- a function $F_0 : C_0 \longrightarrow D_0$

- for each $a \in C_0$, a vertical 1-cell
$$\begin{array}{c} C[a] \\ \downarrow F_a \\ D[F_0a] \end{array}$$
 in V

- for each $a, b \in C_0$, a 2-cell

$$\begin{array}{ccc} C[a] & \xrightarrow{C[a, b]} & C[b] \\ F_a \downarrow & \Downarrow F_{ab} & \downarrow F_b \\ D[F_0a] & \xrightarrow{D[F_0a, F_0b]} & D[F_0b] \end{array}$$

in V ,

such that

$$\begin{array}{ccccc} C[a] & \xrightarrow{C[a, b]} & C[b] & \xrightarrow{C[b, c]} & C[c] \\ F_a \downarrow & \Downarrow F_{ab} & F_b \downarrow & \Downarrow F_{bc} & \downarrow F_c \\ D[F_0a] & \xrightarrow{D[F_0a, F_0b]} & D[F_0b] & \xrightarrow{D[F_0b, F_0c]} & D[F_0c] \\ 1 \downarrow & & \Downarrow \kappa_{F_0a, F_0b, F_0c}^D & & \downarrow 1 \\ D[F_0a] & \xrightarrow{D[F_0a, F_0c]} & & & D[F_0c] \end{array}$$

$$= \begin{array}{ccccc} C[a] & \xrightarrow{C[a, b]} & C[b] & \xrightarrow{C[b, c]} & C[c] \\ 1 \downarrow & & \Downarrow \kappa_{abc}^C & & \downarrow 1 \\ C[a] & \xrightarrow{C[a, c]} & & & C[c] \\ F_a \downarrow & \Downarrow F_{ac} & & & \downarrow F_c \\ D[F_0a] & \xrightarrow{D[F_0a, F_0c]} & & & D[F_0c] \end{array}$$

and

$$\begin{array}{ccc}
\begin{array}{ccc}
C[a] & \xlongequal{\quad} & C[a] \\
F_a \downarrow & = & \downarrow F_a \\
D[F_0a] & \xlongequal{\quad} & D[F_0a] \\
1 \downarrow & \Downarrow \kappa_{F_0a}^D & \downarrow 1 \\
D[F_0a] & \xrightarrow{D[F_0a, F_0a]} & D[F_0a]
\end{array} & = &
\begin{array}{ccc}
C[a] & \xlongequal{\quad} & C[a] \\
1 \downarrow & \Downarrow \kappa_a^C & \downarrow 1 \\
C[a] & \xrightarrow{C[a, a]} & C[a] \\
F_a \downarrow & \Downarrow F_{aa} & \downarrow F_a \\
D[F_0a] & \xrightarrow{D[F_0a, F_0a]} & D[F_0a],
\end{array}
\end{array}$$

where κ^C indicates composition or identities in C , and κ^D in D .

Let us now look at what this means in some degenerate cases.

Examples 2.4.1

- i. Let V be a bicategory and let C and D be V -enriched categories. A V -enriched functor $F : C \longrightarrow D$ consists of a function $F_0 : C_0 \longrightarrow D_0$, satisfying $C[a] = D[F_0a]$ for all $a \in C_0$ (since V is vertically discrete as an **fc**-multicategory), with a 2-cell

$$\begin{array}{ccc}
& C[a, b] & \\
& \curvearrowright & \\
C[a] = D[F_0a] & \xrightarrow{F_{ab}} & C[b] = D[F_0b] \\
& \curvearrowleft & \\
& D[F_0a, F_0b] &
\end{array}$$

for each $a, b \in C_0$. These 2-cells are to be compatible with composition and identities in C and D .

The requirement that $C[a] = D[F_0a]$ seems rather unnatural, and is too stringent in some practical cases. This is one of the reasons why we add in some vertical 1-cells to some of the bicategories we have been considering: see 2.5 below.

- ii. Let V be a monoidal category. Using (i), we see that a functor $C \longrightarrow D$ of V -enriched categories consists of a function $F_0 : C_0 \longrightarrow D_0$ and for each $a, b \in C_0$ a morphism $F_{ab} : C[a, b] \longrightarrow D[F_0a, F_0b]$ in V , such that

$$\begin{array}{ccc}
C[b, c] \otimes C[a, b] & \xrightarrow{F_{bc} \otimes F_{ab}} & D[F_0b, F_0c] \otimes D[F_0a, F_0b] \\
\kappa^C \downarrow & & \downarrow \kappa^D \\
C[a, c] & \xrightarrow{F_{ac}} & D[F_0a, F_0c]
\end{array}$$

and

$$\begin{array}{ccc}
 I & \xrightarrow{1} & I \\
 \kappa^C \downarrow & & \downarrow \kappa^D \\
 C[a, a] & \xrightarrow{F_{aa}} & D[F_0a, F_0a]
 \end{array}$$

commute. This is the traditional definition of a V -enriched functor.

- iii. When V is a plain multicategory, the description of a V -enriched functor is just as when V is a monoidal category, making the obvious translation.
- iv. Let V be an operad, and let A and A' be categories enriched in V . Then an enriched functor $A \longrightarrow A'$ consists of a function $f : A \longrightarrow A'$ and for each $a, b \in A$ an element f_{ab} of $V(1)$, satisfying the equations

$$\begin{aligned}
 [fa, fb, fc]' \circ (f_{ab}, f_{bc}) &= f_{ac} \circ [a, b, c] \\
 [fa]' &= f_{aa} \circ [a].
 \end{aligned}$$

- v. Let V be a commutative monoid with a specified invertible element r . Then a map $A \longrightarrow A'$ of categories enriched in (V, r) consists of functions $f : A \longrightarrow A'$ and $f_{..} : A \times A \longrightarrow V$, satisfying the equations

$$\begin{aligned}
 [fa, fb, fc]' + f_{ab} + f_{bc} &= [a, b, c] + f_{ac} \\
 [fa]' &= [a] + f_{aa}.
 \end{aligned}$$

2.5 Enriched Functors: Examples

We now give some more specific examples of enriched functors.

Examples 2.5.1

- i. Let C and C' be categories enriched in a bicategory V with $C_0 = C'_0 = 1$, so that C and C' are just monads in V . Write them as (X, t, η, μ) and (X', t', η', μ') respectively. Then a V -enriched functor $C \longrightarrow C'$ is a ‘strict map of monads’: that is, it’s the requirement that $X = X'$, together

with a 2-cell $X \begin{array}{c} \xrightarrow{t} \\ \downarrow \phi \\ \xrightarrow{t'} \end{array} X$ such that $\mu' \circ (\phi * \phi) = \phi \circ \mu$ and $\eta' = \phi \circ \eta$.

- ii. Given a 2-category W we get a vertically discrete **fc**-multicategory, just as we have done for bicategories throughout. But we also get two more

fc-multicategories, which are not in general vertically discrete, from the two double categories V and V' of 1.6(v).

Note that all three of the **fc**-multicategories we have constructed from the 2-category W are the same when we ignore the nonidentity vertical 1-cells, so a category enriched in V or in V' is just the same as in Example 2.2.1(i). Let C and D be two categories enriched in W . A V -enriched functor $C \longrightarrow D$ is a function $F_0 : C_0 \longrightarrow D_0$, plus for each $a \in C_0$ a 1-cell $F_a : C[a] \longrightarrow D[F_0a]$ in W , plus for each $a, b \in C_0$ a 2-cell

$$\begin{array}{ccc}
 C[a] & \xrightarrow{C[a,b]} & C[b] \\
 \downarrow F_a & \nearrow \phi_{ab} & \downarrow F_b \\
 D[F_0a] & \xrightarrow{D[F_0a, F_0b]} & D[F_0b]
 \end{array}$$

in W , satisfying axioms stating compatibility with composition and identities. In particular, suppose $C_0 = D_0 = 1$, so that C and D are monads in W . Then a V -enriched functor $C \longrightarrow D$ is a monad functor (see [St]), and a V' -enriched functor $C \longrightarrow D$ is a monad opfunctor.

- iii. Previously, **Span** had denoted a bicategory; we now redefine **Span** to be a certain weak double category. Since the underlying bicategory of this new **Span** is the old **Span**, the previous explanation of categories enriched in **Span** remains valid.

The weak double category **Span** is defined as follows. A 0-cell is a set, a horizontal 1-cell is a span $A \longleftarrow X \longrightarrow B$, a vertical 1-cell is a function $A \longrightarrow A'$ between sets, and a 2-cell is a function h making the diagram

$$\begin{array}{ccccc}
 & & X & & \\
 & \swarrow & \downarrow & \searrow & \\
 A & & & & B \\
 \downarrow & & \downarrow h & & \downarrow \\
 A' & & X' & & B' \\
 \downarrow & \swarrow & \searrow & \downarrow & \\
 & & & &
 \end{array}$$

commute. Horizontal composition of 1-cells is by pullback (as in the old **Span**), vertical composition of 1-cells is ordinary composition of functions, and 2-cell composition works in the natural way. From now on, **Span** will denote this weak double category or the underlying **fc**-multicategory (which is what we really care about).

We saw in 2.3.1(iv) that a category enriched in **Span** consisted of a set I , for each $i \in I$ a set $D[i]$, for each $i, j \in I$ a span

$$D[i] \longleftarrow D[i, j] \longrightarrow D[j],$$

and functions for composition and identities. Put another way, it consists of a category D , a set I , and a function $D_0 \longrightarrow I$. If $(D', I', D'_0 \longrightarrow I')$ is another category enriched in **Span**, then a **Span**-enriched functor between them consists of:

- a function $f : I \longrightarrow I'$

- for each $i \in I$, a function $D[i] \xrightarrow{F_i} D'[f(i)]$

- for each $i, j \in I$ a function F_{ij} making

$$\begin{array}{ccccc}
 & & D[i, j] & & \\
 & \swarrow & \downarrow F_{ij} & \searrow & \\
 D[i] & & & & D[j] \\
 \downarrow F_i & & D'[f(i), f(j)] & & \downarrow F_j \\
 D'[f(i)] & & & & D'[f(j)]
 \end{array}$$

commute,

all compatible with the composition and identity functions. In other words, a **Span**-enriched functor from $(D, I, D_0 \longrightarrow I)$ to $(D', I', D'_0 \longrightarrow I')$ consists of a function $I \xrightarrow{f} I'$ and a functor $D \xrightarrow{F} D'$ such that

$$\begin{array}{ccc}
 D_0 & \xrightarrow{F_0} & D'_0 \\
 \downarrow & & \downarrow \\
 I & \xrightarrow{f} & I'
 \end{array}$$

commutes. Thus the category of **Span**-enriched categories is the comma category $(\text{ob} \downarrow \mathbf{Set})$, where $\text{ob} : \mathbf{Cat} \longrightarrow \mathbf{Set}$ is the objects functor.

iv. Similarly, **Rel** becomes a (strict) double category. There is at most one

2-cell with any given boundary; a 2-cell looks like

$$\begin{array}{ccc}
 X & \xrightarrow{R} & X' \\
 f \downarrow & & \downarrow f' \\
 Y & \xrightarrow{S} & Y'
 \end{array}$$

where X, X', Y, Y' are sets, $R \subseteq X \times X'$ and $S \subseteq Y \times Y'$, and f and f' are functions, all satisfying the condition that if $(x, x') \in R$ then $(f(x), f'(x')) \in S$. Arguing as for **Span**, the category of **Rel**-enriched categories is the comma category $(U \downarrow \mathbf{Set})$, where $U : \mathbf{Preorders} \longrightarrow \mathbf{Set}$ is the forgetful functor.

- v. Since **Glue** is a sub-2-category of **Rel**, it also becomes a double category. Suppose $(C_i)_{i \in I}$ is an indexed family of subsets of a set S , and similarly $(C'_j)_{j \in I'}$ in S' . Suppose also that $f : I \longrightarrow I'$ and $\phi : S \longrightarrow S'$ are functions such that $\phi C_i \subseteq C'_{f(i)}$. Then we get an enriched functor between the **Glue**-enriched categories corresponding to these families (see 2.3.1(xi)), given by the commuting square

$$\begin{array}{ccc}
 \coprod_i C_i & \longrightarrow & \coprod_j C'_j \\
 \downarrow & & \downarrow \\
 I & \xrightarrow{f} & I'
 \end{array}$$

in which the function along the top row sends $a \in C_i$ to $\phi(a) \in C'_{f(i)}$.

2.6 Bimodules

The bimodules construction has traditionally taken place in the context of bicategories: given a bicategory \mathcal{B} , there is another bicategory $\mathbf{Bim}(\mathcal{B})$ whose 0-cells are monads in \mathcal{B} and whose 1-cells are bimodules in \mathcal{B} ([CKW], [Kos]). However, in order to do this one needs to assume some special properties of \mathcal{B} , e.g. that \mathcal{B} locally has reflexive coequalizers and that these are preserved by composition with any 1-cell. In this section we describe a bimodules construction for **fc**-multicategories which extends the construction for bicategories and has the advantage that it has no such technical restrictions on it. Having done this, we look at the way in which a category enriched in an **fc**-multicategory V gives rise to a category enriched in $\mathbf{Bim}(V)$.

Let V be an **fc**-multicategory. The **fc**-multicategory $\mathbf{Bim}(V)$ is defined as follows:

0-cells A 0-cell of $\mathbf{Bim}(V)$ is a *monad* in V . That is, it is a 0-cell x of V together with a horizontal 1-cell $x \xrightarrow{t} x$ and 2-cells

$$\begin{array}{ccc}
 x & \xrightarrow{t} & x & \xrightarrow{t} & x \\
 \downarrow 1 & & \Downarrow \mu & & \downarrow 1 \\
 x & \xrightarrow{t} & & & x
 \end{array}
 \qquad
 \begin{array}{ccc}
 x & \xlongequal{\quad} & x \\
 \downarrow 1 & & \Downarrow \eta & & \downarrow 1 \\
 x & \xrightarrow{t} & & & x
 \end{array}$$

satisfying the usual monad axioms, $\mu \circ (\mu, 1_t) = \mu \circ (1_t, \mu)$ and $\mu \circ (\eta, 1_t) = 1 = \mu \circ (1_t, \eta)$.

Horizontal 1-cells A horizontal 1-cell $(x, t, \eta, \mu) \dashrightarrow (x', t', \eta', \mu')$ consists of a horizontal 1-cell $x \xrightarrow{f} x'$ in V together with 2-cells

$$\begin{array}{ccc}
 x & \xrightarrow{t} & x & \xrightarrow{f} & x' \\
 \downarrow 1 & & \Downarrow \theta & & \downarrow 1 \\
 x & \xrightarrow{f} & & & x'
 \end{array}
 \qquad
 \begin{array}{ccc}
 x & \xrightarrow{f} & x' & \xrightarrow{t'} & x' \\
 \downarrow 1 & & \Downarrow \theta' & & \downarrow 1 \\
 x & \xrightarrow{f} & & & x'
 \end{array}$$

satisfying the usual algebra axioms $\theta \circ (\eta, 1_f) = 1$, $\theta \circ (\mu, 1_f) = \theta \circ (1_t, \theta)$, and dually for θ' , and the ‘commuting actions’ axiom $\theta' \circ (\theta, 1_{t'}) = \theta \circ (1_t, \theta')$.

Vertical 1-cells A vertical 1-cell $(x, t, \eta, \mu) \downarrow$ in $\mathbf{Bim}(V)$ is a vertical 1-cell $\downarrow p$ in V together with a 2-cell

$$\begin{array}{ccc}
 x & \xrightarrow{t} & x \\
 \downarrow p & & \Downarrow \omega & & \downarrow p \\
 \hat{x} & \xrightarrow{\hat{t}} & \hat{x}
 \end{array}$$

such that $\omega \circ \mu = \hat{\mu} \circ (\omega, \omega)$ and $\omega \circ \eta = \hat{\eta} \circ p$. (The notation on the right-hand side of the second equation is explained on page 15.)

2-cells A 2-cell

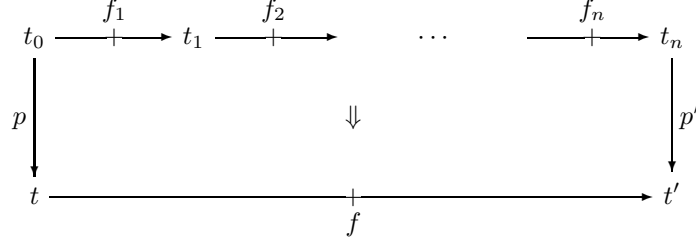

in $\mathbf{Bim}(V)$, where t stands for (x, t, η, μ) , f for (f, θ, θ') , p for (p, ω) , and so on, consists of a 2-cell

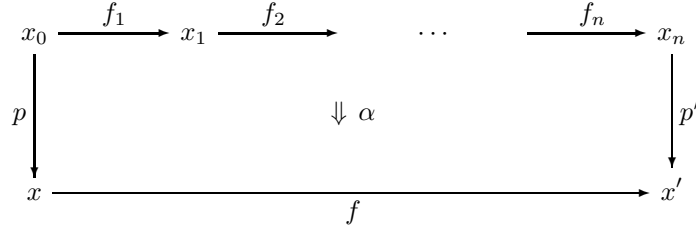

in V , satisfying the ‘external equivariance’ axioms

$$\begin{aligned}
 \alpha \circ (\theta_1, 1_{f_2}, \dots, 1_{f_n}) &= \theta \circ (\omega, \alpha) \\
 \alpha \circ (1_{f_1}, \dots, 1_{f_{n-1}}, \theta'_n) &= \theta' \circ (\alpha, \omega')
 \end{aligned}$$

and the ‘internal equivariance’ axioms

$$\alpha \circ (1_{f_1}, \dots, 1_{f_{i-2}}, \theta'_{i-1}, 1_{f_i}, 1_{f_{i+1}}, \dots, 1_{f_n}) = \alpha \circ (1_{f_1}, \dots, 1_{f_{i-2}}, 1_{f_{i-1}}, \theta_i, 1_{f_{i+1}}, \dots, 1_{f_n})$$

for $2 \leq i \leq n$.

Composition and identities For both 2-cells and vertical 1-cells in $\mathbf{Bim}(V)$, composition is defined directly from the composition in V , and identities similarly.

Examples 2.6.1

- i. Let \mathcal{B} be a bicategory with the ‘special properties’ mentioned in the first paragraph of this section. Let V be the **fc**-multicategory coming from \mathcal{B} . Then a 0-cell of $\mathbf{Bim}(V)$ is a monad in \mathcal{B} , a horizontal 1-cell $t \longrightarrow t'$ is a (t', t) -bimodule, and a 2-cell of the form

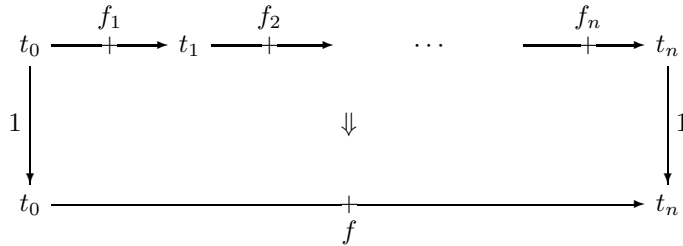

is a map

$$f_n \otimes_{t_{n-1}} \cdots \otimes_{t_1} f_1 \longrightarrow f$$

of (t_n, t_0) -bimodules, i.e. a 2-cell in the ‘traditional’ bicategory $\mathbf{Bim}(\mathcal{B})$. Thus the **fc**-multicategory coming from $\mathbf{Bim}(\mathcal{B})$ is the vertically discrete part of $\mathbf{Bim}(V)$.

- ii. Suppose V comes from the monoidal category (\mathbf{Set}, \times) . Then a 0-cell of $\mathbf{Bim}(V)$ is a monoid, a horizontal 1-cell $M \xrightarrow{X} M'$ is a set X with commuting left action by M' and right action by M , a vertical 1-cell $\begin{array}{c} M \\ \downarrow \\ N \end{array}$ is a monoid homomorphism, and a 2-cell

$$\begin{array}{ccccccc} M_0 & \xrightarrow{X_1} & M_1 & \xrightarrow{X_2} & \cdots & \xrightarrow{X_n} & M_n \\ \downarrow p & & & \Downarrow & & & \downarrow p' \\ M & \xrightarrow{X} & & & & & M' \end{array}$$

is a function $\phi : X_n \times \cdots \times X_1 \longrightarrow X$ such that

$$\begin{aligned} \phi(x_n, \dots, x_2, x_1 m_0) &= \phi(x_n, \dots, x_1) p(m_0) \\ \phi(\dots, x_i, m_{i-1} x_{i-1}, \dots) &= \phi(\dots, x_i m_{i-1}, x_{i-1}, \dots) \quad (2 \leq i \leq n) \\ \phi(m_n x_n, x_{n-1}, \dots, x_1) &= p'(m_n) \phi(x_n, \dots, x_1). \end{aligned}$$

So $\mathbf{Bim}(V)$ is the weak double category $\mathbf{Bim}(\mathbf{Set})$ of 2.3.1(ii).

- iii. Similarly, by taking V to be the monoidal category (\mathbf{Ab}, \otimes) , we get the weak double category $\mathbf{Bim}(\mathbf{Ab})$ of 2.1.1(ii), made up of rings, bimodules, ring homomorphisms, and bimodule maps under changes of base.
- iv. Moving on from monoidal categories, let \mathbf{Span} be the weak double category of 2.5.1(iii), made up of sets, spans, functions, and maps of spans. Then $\mathbf{Bim}(\mathbf{Span})$ is an **fc**-multicategory with:

0-cells Categories

Horizontal 1-cells Profunctors

Vertical 1-cells Functors

2-cells A 2-cell

$$\begin{array}{ccccccc}
 C_0 & \xrightarrow{X_1} & C_1 & \xrightarrow{X_2} & \cdots & \xrightarrow{X_n} & C_n \\
 \downarrow F & & & & \Downarrow & & \downarrow F' \\
 C & \xrightarrow{X} & & & & & C'
 \end{array} \quad (2C)$$

(where the C 's are categories, the X 's profunctors, and the F 's functors) is a natural transformation

$$\begin{array}{ccc}
 C_0^{\text{op}} \times C_n & \xrightarrow{F^{\text{op}} \times F'} & C^{\text{op}} \times C' \\
 \searrow & \nearrow & \swarrow \\
 X_n \otimes \cdots \otimes X_1 & & X
 \end{array}$$

Set.

In other words, it is a family of functions

$$X_1(c_0, c_1) \times X_2(c_1, c_2) \times \cdots \times X_n(c_{n-1}, c_n) \longrightarrow X(Fc_0, F'c_n)$$

natural in $c_i \in C_i$.

- v. In Example 2.5.1(iii) we changed the term **Span** from meaning a certain bicategory to meaning a certain **fc**-multicategory. This process goes through without change for **Span**(\mathcal{E}, T), so **Span**(\mathcal{E}, T) will now denote an **fc**-multicategory, for any cartesian (\mathcal{E}, T). (It won't usually be a weak double category, though, unless \mathcal{E} and T have convenient properties.) Then **Bim**(**Span**(\mathcal{E}, T)) has:

0-cells T -multicategories

Horizontal 1-cell $C \longrightarrow C'$: span ($TC_0 \longleftarrow X \longrightarrow C'_0$), together with maps ('actions') $X \circ C_1 \longrightarrow X$ and $C'_1 \circ X \longrightarrow X$ satisfying some axioms. We might call such an X a *profunctor* $C \dashrightarrow C'$.

Vertical 1-cell $C \longrightarrow D$: functor $C \longrightarrow D$ of T -multicategories

2-cells A 2-cell as at (2C) is an arrow $X_n \circ \cdots \circ X_1 \longrightarrow X$ in \mathcal{E} (where the domain of this arrow is the 1-cell composite in **Span**(\mathcal{E}, T)), satisfying compatibility axioms for the actions by C_i, C , and C' .

In the case of **Span**, i.e. (\mathcal{E}, T) = (**Set**, id), a 2-cell

$$\begin{array}{ccc}
 C & \xrightarrow{1} & C \\
 \downarrow F & & \downarrow G \\
 D & \xrightarrow{1} & D
 \end{array}$$

is just a natural transformation $F \longrightarrow G$ (by a Yoneda argument). The same is in fact true for (\mathcal{E}, T) -multicategories: in 1.1.1 we defined a transformation $F \longrightarrow G$ as an arrow $C_0 \xrightarrow{\alpha} D_1$ with certain properties, but now we have an alternative description of it as an arrow $C_1 \xrightarrow{\tilde{\alpha}} D_1$ with certain properties. In the case $(\mathcal{E}, T) = (\mathbf{Set}, id)$, $\tilde{\alpha}$ sends an arrow f in C to the diagonal of the naturality square for α at f .

To finish this section, we briefly discuss ‘change of base’ and the fact that from a category enriched in V there arises a category enriched in $\mathbf{Bim}(V)$. If $W \xrightarrow{G} W'$ is a functor between (\mathcal{E}', T') -multicategories then any W -enriched multicategory becomes a W' -enriched multicategory just by composition with G : thus there’s a functor

$$G_* : (\mathcal{E}, T)_W\text{-Multicat} \longrightarrow (\mathcal{E}, T)_{W'}\text{-Multicat}.$$

In particular, consider for any **fc**-multicategory V the forgetful functor $U : \mathbf{Bim}(V) \longrightarrow V$. This gives the functor

$$U_* : \mathbf{Cat}_{\mathbf{Bim}(V)} \longrightarrow \mathbf{Cat}_V,$$

where \mathbf{Cat}_W is the category of W -enriched categories. Then U_* has a right adjoint Z ; this is not of the form J_* for any J , but is the functor $\mathbf{Cat}_V \longrightarrow \mathbf{Cat}_{\mathbf{Bim}(V)}$ of which we saw examples in 2.3.1(i), (ii), (vi). On this occasion we omit the general definition of Z , since it is indicated adequately by these examples and there is only one sensible way of constructing a functor $\mathbf{Cat}_V \longrightarrow \mathbf{Cat}_{\mathbf{Bim}(V)}$ for general V .

Chapter 3

Other Enriched Multicategories

We have defined (\mathcal{E}, T) -multicategories enriched in an (\mathcal{E}', T') -multicategory, but so far only looked at the case $(\mathcal{E}, T) = (\mathbf{Set}, id)$. In this chapter we look at some other cases. It should not come as a surprise after Chapter 2 that (\mathcal{E}', T') -multicategories are rather complicated structures for some of the usual examples of \mathcal{E} and T ; in the bulk of this chapter we therefore take T to be the next most simple case, the free monoid monad on $\mathcal{E} = \mathbf{Set}$. This does, however, give a good idea of what T_n -multicategories enriched in a T_{n+1} -multicategory look like for all n , and we discuss this (and the ‘full hierarchy’) in the final section.

A plain multicategory is a $(\mathbf{Set}, \text{free monoid})$ -multicategory (see 1.1). We may therefore speak of a plain multicategory enriched in a $(*\mathbf{-Graph}, \mathbf{fm})$ -multicategory, where $*$ is the free monoid monad on \mathbf{Set} , $*\mathbf{-Graph}$ is the category of $*$ -graphs (1.1), and \mathbf{fm} is the free multicategory monad on $*\mathbf{-Graph}$. In order to understand enriched plain multicategories, our first task is therefore to see what an \mathbf{fm} -multicategory is.

3.1 \mathbf{fm} -Multicategories

A $*$ -graph X consists of a set X_0 of objects x , together with a set X_1 of arrows ξ with specified domain and codomain, pictured as

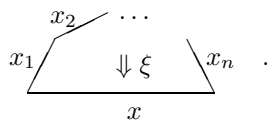

In the graph $\mathbf{fm}(X)$, the set of objects is just X_0 again, but an arrow is a formal gluing of arrows in X , such as

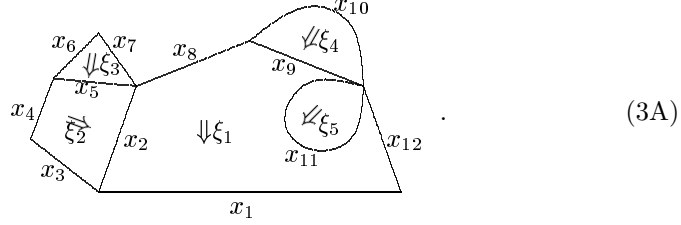

We can define $\mathbf{fm}(X) = (X_0^* \xleftarrow{\text{dom}} X_1' \xrightarrow{\text{cod}} X_0)$ inductively by:

- if $x \in X_0$ then $1_x \in X_1'$; $\text{dom}(1_x) = (x)$ and $\text{cod}(1_x) = x$
- if $\xi \in X_1$ and $\theta_1, \dots, \theta_n \in X_1'$ with $\text{dom}(\xi) = (\text{cod}(\theta_1), \dots, \text{cod}(\theta_n))$, then $\xi\langle\theta_1, \dots, \theta_n\rangle \in X_1'$; domain and codomain are given by

$$\begin{aligned} \text{dom}(\xi\langle\theta_1, \dots, \theta_n\rangle) &= \mu_{X_0}(\text{dom}(\theta_1), \dots, \text{dom}(\theta_n)), \\ \text{cod}(\xi\langle\theta_1, \dots, \theta_n\rangle) &= \text{cod}(\xi). \end{aligned}$$

Here 1_x and $\xi\langle\theta_1, \dots, \theta_n\rangle$ are formal expressions; the definition is just a special case of the free multicategory construction described in the Appendix. Informally, it is clear how the functor \mathbf{fm} acts on morphisms, and what its monad structure is, so we omit the details here.

An \mathbf{fm} -graph looks like

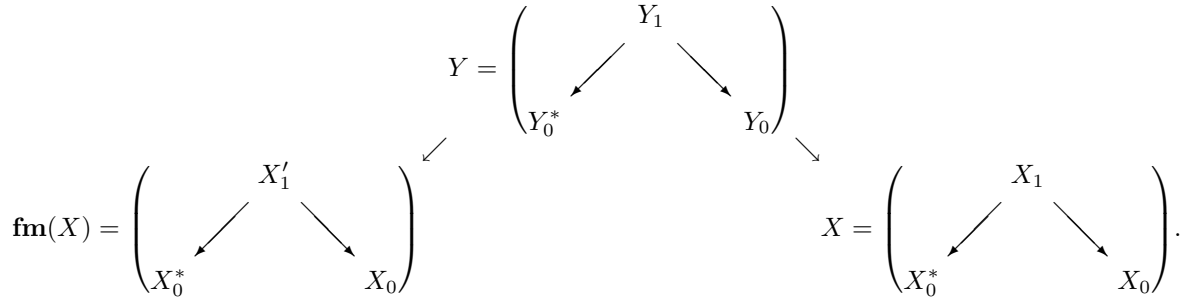

Interpret the whole graph as a 3-dimensional structure this time: $x \in X_0$ is a 1-cell, $\xi \in X_1$ is a horizontal 2-cell, $y \in Y_0$ is a vertical 2-cell, and $\eta \in Y_1$ is a

3-cell, as in the picture

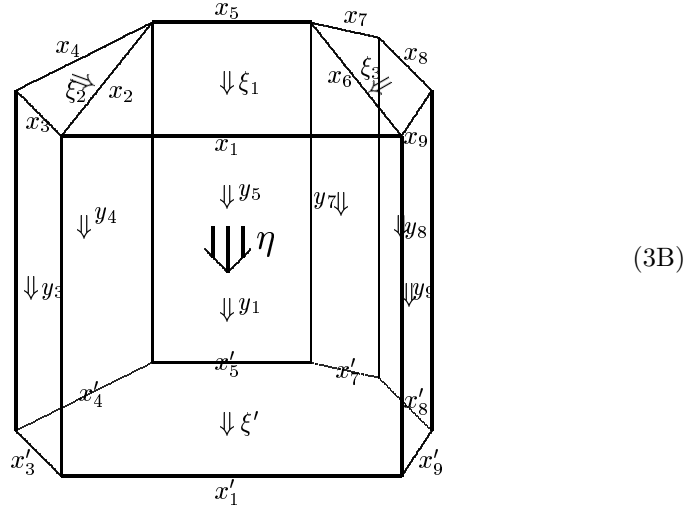

or, drawn another way,

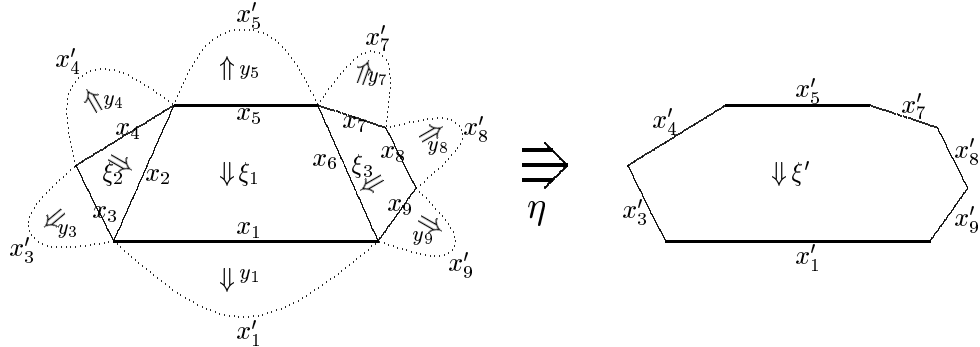

An **fm**-multicategory is an **fm**-graph together with identities and composition. This firstly means that $X_0 \longleftarrow Y_0 \longrightarrow X_0$ has the structure of a category, i.e. that the 1-cells and vertical 2-cells are respectively the objects and arrows of a category. More significantly, it means that 3-cells can be composed vertically. The identities can be portrayed as

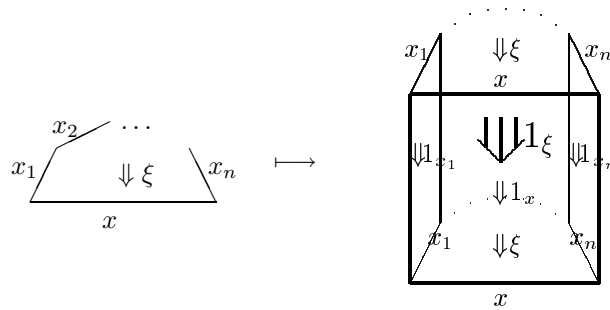

and composition looks like

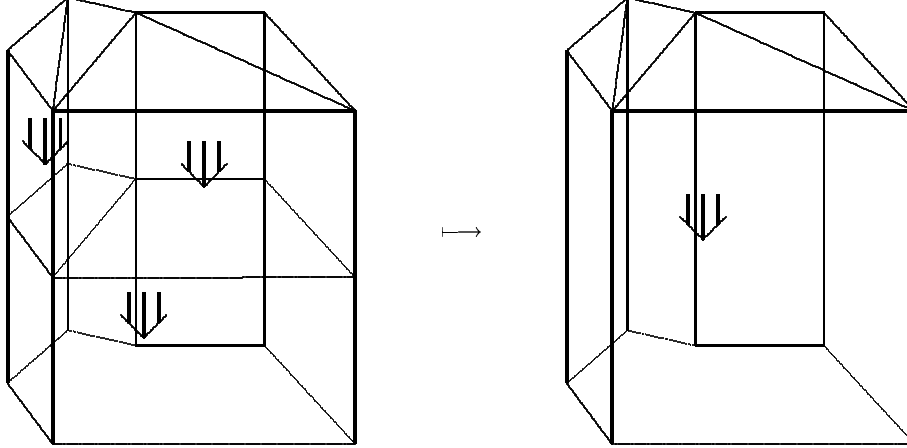

We describe a few degenerate cases, as we did for **fc**-multicategories.

Examples 3.1.1

- i. There are **fm**-multicategories in which diagrams of horizontal 2-cells are ‘representable’, in a sense which we do not make precise but which is analogous to the sense in which a string $x_0 \xrightarrow{\xi_1} \dots \xrightarrow{\xi_n} x_n$ of horizontal 1-cells in a weak double category is ‘represented’ by $\xi_n \circ \dots \circ \xi_1$. For instance, there is an **fm**-multicategory where a 1-cell is a ring, a horizontal 2-cell

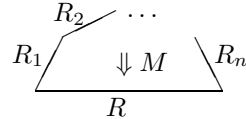

is an abelian group M with commuting left action by R and right actions by R_1, \dots, R_n (which we shall call an $(R; R_1, \dots, R_n)$ -module), a vertical 2-cell from R to R' is a ring homomorphism, and a 3-cell inside

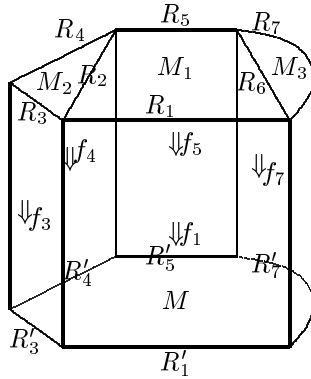

is a multilinear map $\phi : M_1, M_2, M_3 \longrightarrow M'$ of abelian groups, satisfying ‘internal compatibility’ axioms

$$\begin{aligned}\phi(m_1 r_2, m_2, m_3) &= \phi(m_1, r_2 m_2, m_3) \\ \phi(m_1 r_6, m_2, m_3) &= \phi(m_1, m_2, r_6 m_3)\end{aligned}$$

and ‘external compatibility’ axioms

$$\begin{aligned}\phi(r_1 m_1, m_2, m_3) &= f_1(r_1) \cdot \phi(m_1, m_2, m_3) \\ \phi(m_1, m_2 r_3, m_3) &= \phi(m_1, m_2, m_3) \cdot f_3(r_3) \\ \phi(m_1, m_2 r_4, m_3) &= \phi(m_1, m_2, m_3) \cdot f_4(r_4) \\ \phi(m_1 r_5, m_2, m_3) &= \phi(m_1, m_2, m_3) \cdot f_5(r_5) \\ \phi(m_1, m_2, m_3 r_7) &= \phi(m_1, m_2, m_3) \cdot f_7(r_7).\end{aligned}$$

There is an $(R_1; R_3, R_4, R_5, R_7)$ -module M with the property that 3-cells ϕ as illustrated correspond naturally to maps $M \longrightarrow M'$, where ‘maps’ means module maps with respect to the change of base $(f_1; f_3, f_4, f_5, f_7)$. This M is simply the quotient of the abelian group tensor $M_1 \otimes M_2 \otimes M_3$ by the relations

$$\begin{aligned}m_1 r_2 \otimes m_2 \otimes m_3 &\sim m_1 \otimes r_2 m_2 \otimes m_3 \\ m_1 r_6 \otimes m_2 \otimes m_3 &\sim m_1 \otimes m_2 \otimes r_6 m_3\end{aligned}$$

(corresponding to the internal compatibility axioms above). The existence of such an M is what was meant by ‘representability’.

- ii. Suppose $(X_0 \longleftarrow Y_0 \longrightarrow X_0) = (X_0 \xleftarrow{1} X_0 \xrightarrow{1} X_0)$, so that all vertical 2-cells are identities. Then the 3-cells are shaped like 3-opetopes (for which terminology, see 1.5): by collapsing the vertical 2-cells (say of (3B)), one obtains a 3-dimensional figure with one flat face on the bottom and several (necessarily curved) faces on the top. The graph of the **fm**-multicategory can now be drawn as

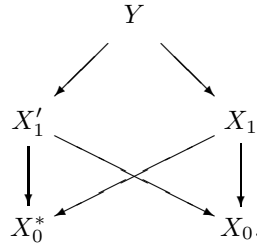

We call such an **fm**-multicategory *vertically discrete*. An example of such a structure is a tricategory with just one 0-cell, also known as a monoidal bicategory.

Whether or not an **fm**-multicategory is vertically discrete, we will use the convention that identity vertical 2-cells will not be drawn at all, as in diagram (3E).

- iii. Suppose that the underlying vertical category is the terminal category, i.e. that $X_0 = Y_0 = 1$. Then the **fm**-multicategory consists of some objects ξ (previously called horizontal 2-cells) of shape

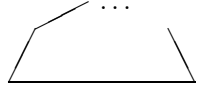

(n upper edges) (3C)

for each n , plus some arrows (previously called 3-cells) η , where the domain is a diagram of objects pasted together, and the codomain is a single object with the same shape as the boundary of the domain, as in

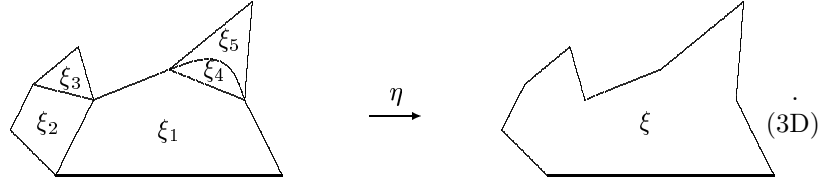

(3D)

These arrows can be composed, and the composition obeys associative and identity laws. In other words, it is a T_2 -multicategory (see [Lei2, p. 66]).

- iv. Any symmetric monoidal category (W, \otimes) gives rise to a T_2 -multicategory V in which the pastings of objects are representable. Explicitly, let V be the T_2 -multicategory in which an object of shape (3C) is an object of W (for any n), and in which an arrow η as in (3D) is a morphism

$$\xi_1 \otimes \xi_2 \otimes \xi_3 \otimes \xi_4 \otimes \xi_5 \longrightarrow \xi$$

in W . Composition and identities are defined in the natural way; since the ordering of the ξ_i 's in the domain of (3D) has no special properties, we will need to use the symmetry isomorphisms in W when we are defining composites. Choosing different orderings only changes V up to isomorphism.

3.2 Enriched Plain Multicategories: Elementary Description

We have now seen what an **fm**-multicategory is. The next question: if A is a set, what is $MI(A)$? Firstly, $I(A)$ has graph $A^* \longleftarrow A^* \times A \longrightarrow A$. Then, $\mathbf{fm}(I(A)) = (A^* \longleftarrow B \longrightarrow A)$, where an element of B is a diagram like

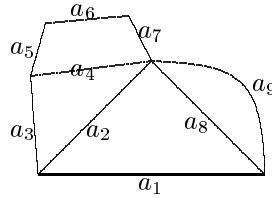

($x_i \in A$; cf. diagram (3A)). There's a natural map $B \longrightarrow A^* \times A$ specifying domain in the first coordinate and codomain in the second, and $M(I(A))$ has graph

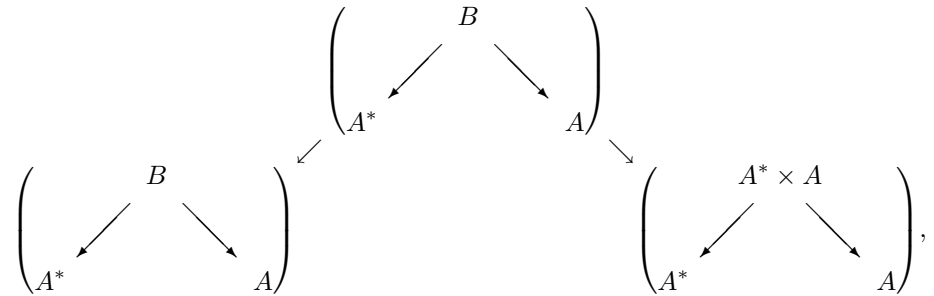

which can also be written

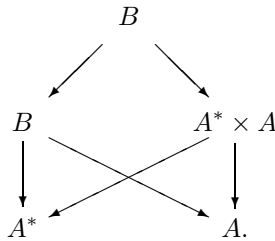

Thus a horizontal 1-cell is an element of A ; there's precisely one horizontal 2-cell

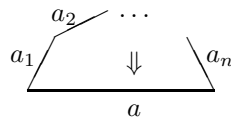

for each $a_1, \dots, a_n, a \in A$; the only vertical 2-cells are identities (i.e. $MI(A)$ is vertically discrete); and there's precisely one 3-cell

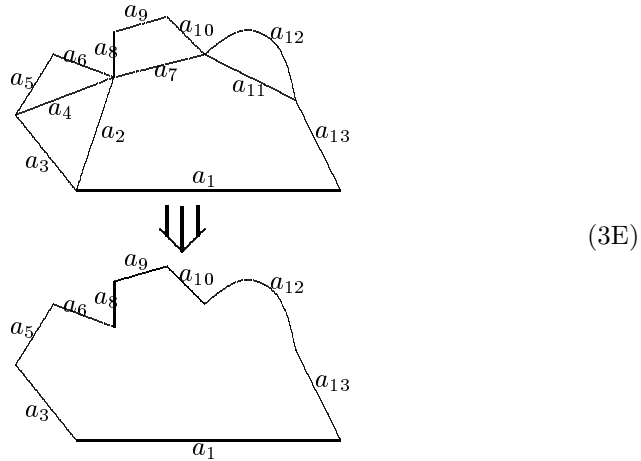

(and similarly for any other pasting diagram of objects in the domain), using the diagrammatic convention of 3.1.1(ii). There is only one possible way that composition and identities can be defined.

Finally, we can say what a plain multicategory enriched in a $(*\text{-Graph, fm})$ -multicategory V is: namely,

- a set C_0
- for each $a \in C_0$, a 1-cell $C[a]$ of V
- for each $a_1, \dots, a_n, a \in C_0$, a horizontal 2-cell

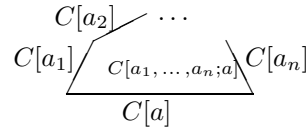

of V

- for each diagram like

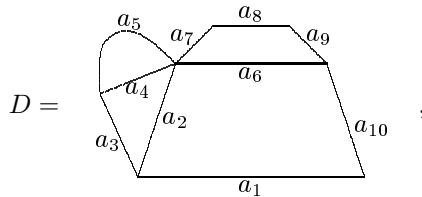

a 3-cell like

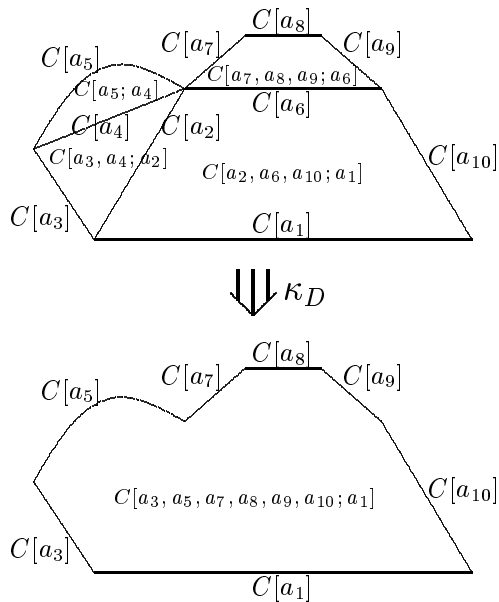

such that the κ_D 's are closed under composition and identities, in a way similar to that for enriched categories (page 20).

We have become vague when discussing diagrams 'like D ', not wanting to get too involved in the details of the explicit definition of **fm**. By induction we could prove that the definition of V -enriched plain multicategory is equivalent to the following 'biased' version (cf. page 20): a plain multicategory enriched in V consists of

- a set C_0
- for each $a \in C_0$, a 1-cell $C[a]$ of V
- for each $a_1, \dots, a_n, a \in C_0$, a horizontal 2-cell

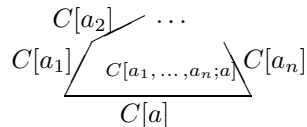

of V

- for each $a, a_1, \dots, a_n, a_1^1, \dots, a_1^{k_1}, \dots, a_n^1, \dots, a_n^{k_n} \in C_0$, a 3-cell

(3F)

in V

- for each $a \in C_0$, a 3-cell

in V

satisfying associativity and identity axioms.

Before moving on to specific examples, we take a brief look at how the definition of enriched plain multicategory reads when V is in some way degenerate. As for enriched categories, we might as well assume that V is vertically discrete.

- i. Suppose that V is vertically trivial, i.e. a T_2 -multicategory (3.1.1(iii)). Then a plain multicategory C enriched in V consists of

- a set C_0

- for each $a_1, \dots, a_n, a \in C_0$, an object

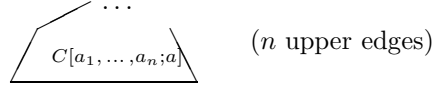

of V

- for each $a, a_1, \dots, a_n, a_1^1, \dots, a_1^{k_1}, \dots, a_n^1, \dots, a_n^{k_n} \in C_0$, an arrow

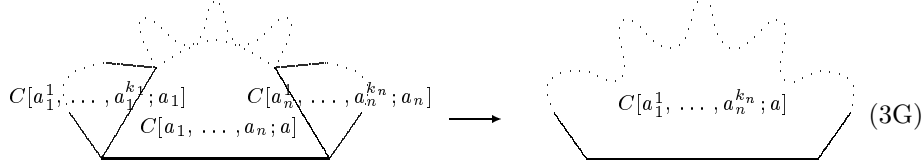

in V

- for each $a \in C_0$, an arrow

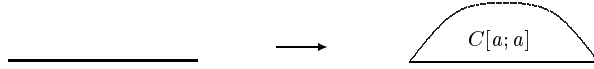

in V ,

satisfying the inevitable associativity and identity axioms.

- ii. Suppose V comes from a symmetric monoidal category W (3.1.1(iv)). Then a plain multicategory C enriched in V consists of

- a set C_0
- for each $a_1, \dots, a_n, a \in C_0$, an object $C[a_1, \dots, a_n; a]$ of W
- for each a, a_i, a_i^j , a ‘composition’ arrow

$$C[a_1, \dots, a_n; a] \otimes C[a_1^1, \dots, a_1^{k_1}; a_1] \otimes \cdots \otimes C[a_n^1, \dots, a_n^{k_n}; a_n] \longrightarrow C[a_1^1, \dots, a_n^{k_n}; a]$$

in W

- for each a , an ‘identity’ arrow $I \longrightarrow C[a; a]$

satisfying associativity and identity.

A plain multicategory enriched in the symmetric monoidal category (\mathbf{Set}, \times) is therefore just the same thing as a plain multicategory.

- iii. Topologists are used to considering plain operads enriched in a symmetric monoidal category W (e.g. $(\mathbf{Spaces}, \times)$): that is, the case of (ii) where $C_0 = 1$. (They call them just ‘(non-symmetric) operads in W ’.) Such a structure consists of a sequence $(C(n))_{n \in \mathbb{N}}$ of objects of W , together with morphisms

$$\begin{aligned} C(n) \otimes C(k_1) \otimes \cdots \otimes C(k_n) &\longrightarrow C(k_1 + \cdots + k_n) \\ I &\longrightarrow C(1) \end{aligned}$$

satisfying the usual axioms.

3.3 Enriched Plain Multicategories: Examples

We finish the material on enriched plain multicategories with three examples. In Chapter 4 we will meet another important example: relaxed multicategories are plain multicategories enriched in the T_2 -multicategory $[\mathbf{TR}^{\text{op}}, \mathbf{Set}]$.

Examples 3.3.1

- i. We will be particularly interested in plain operads enriched in the symmetric monoidal category (\mathbf{Cat}, \times) . These are exactly the same things as $(\mathbf{Cat}, *)$ -operads, where $*$ is the free strict monoidal category monad given by $A^* = \coprod_{n \in \mathbb{N}} A^n$. They are also the same as T_2 -structured categories. Both of these equivalences are established in [Lei2, IV.2].
- ii. Modules over a fixed commutative ring R form a plain multicategory C enriched in the symmetric monoidal category \mathbf{Ab} of abelian groups: the objects are R -modules, and $C[X_1, \dots, X_n; X]$ is the abelian group of R -module homomorphisms $X_1 \otimes \dots \otimes X_n \longrightarrow X$.
- iii. Let V be the \mathbf{fm} -multicategory of 3.1.1(i), and take any plain multicategory C enriched in the symmetric monoidal category \mathbf{Ab} . Then there arises a plain multicategory C' enriched in V . (This is analogous to the situation one level down, as described in 2.3.1(i), but we do not attempt a general result.) So, $C'_0 = C_0$; $C'[a]$ is the 1-cell, i.e. ring, $C[a, a]$; and $C'[a_1, \dots, a_n, a]$ is the abelian group $C[a_1, \dots, a_n, a]$ acted on by $C[a, a]$ on the left and $C[a_i, a_i]$ on the right, both actions being by composition in C .

3.4 The Hierarchies

The process $(\mathcal{E}, T) \mapsto (\mathcal{E}', T')$ can be applied indefinitely. In particular, if we start with (\mathbf{Set}, id) then we obtain a hierarchy (\mathcal{E}_n, P_n) of monads on categories:

- $(\mathcal{E}_0, P_0) = (\mathbf{Set}, id)$
- $(\mathcal{E}_{n+1}, P_{n+1}) = (P_n\text{-}\mathbf{Graph}, \text{free } P_n\text{-multicategory})$.

(The persistence property of suitability, stated in Theorem 1.2.1, makes this possible.) We can therefore discuss P_n -multicategories enriched in P_{n+1} -multicategories, for all n .

As might be expected from the complexity of the structures in Chapter 2, which was just the case $n = 0$, this rapidly becomes difficult in at least visual terms. For instance, take $n = 1$. Then $P_1 = \mathbf{fc}$, so we are interested in \mathbf{fc} -multicategories enriched in a P_2 -multicategory V . The graph of a P_2 -multicategory looks like

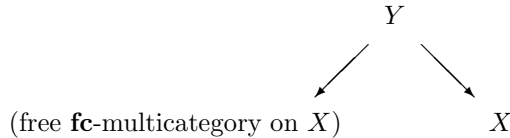

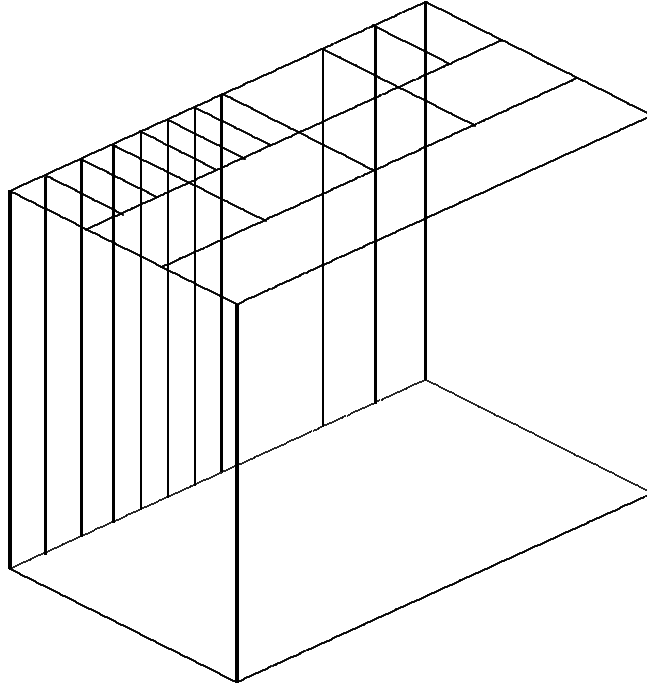

Figure 3a: The shape of a 3-cell in a P_2 -graph

where X and Y are **fc**-graphs (i.e. objects of \mathcal{E}_2): thus a P_2 -graph is defined by $2^3 = 8$ sets and various functions between them. We picture a P_2 -graph as some kind of 3-dimensional cubical structure; a 3-cell (without labels) is drawn in Figure 3a.

More tractable than the full hierarchy (\mathcal{E}_n, P_n) is the restricted hierarchy $(\mathbf{Set}/S_n, T_n)$, which was constructed so that

- $(\mathbf{Set}/S_0, T_0) = (\mathbf{Set}, id)$
- $(\mathbf{Set}/S_{n+1}, T_{n+1}) = (T_n\text{-graphs on } 1, \text{free } T_n\text{-operad})$

(see 1.5). Since $(T_n\text{-graphs on } 1)$ is a subcategory of $T_n\text{-Graph}$ and $(\text{free } T_n\text{-operad})$ is the restriction of $(\text{free } T_n\text{-multicategory})$ to this subcategory, we can talk about T_n -multicategories enriched in T_{n+1} -multicategories, for any n . Put another way, a T_{n+1} -multicategory is a special kind of T' -multicategory, where $(\mathcal{E}, T) = (\mathbf{Set}/S_n, T_n)$; this is the special case we considered in 2.2.1(iii) (categories enriched in plain multicategories) and 3.1.1(iii) (plain multicategories enriched in T_2 -multicategories).

We finish this chapter with some remarks on symmetric monoidal categories. In Chapter 1 we observed that any monoidal category yields a plain multicategory (canonically, up to isomorphism), and in 3.1.1(iv) we also saw that any symmetric monoidal category yields a T_2 -multicategory. In fact, the method

of 3.1.1(iv) suggests that a symmetric monoidal category should yield a T_n -multicategory for all n . This is indeed the case:

Proposition 3.4.1 *Let $n \in \mathbb{N}$ and let W be a symmetric monoidal category. Then there is an associated T_n -multicategory V , defined canonically up to isomorphism.*

Sketch proof By induction on n , using the explicit free multicategory construction in the Appendix, we show that for each n there is a (canonical) natural transformation

$$\begin{array}{ccc} \mathbf{Set}/S_n & \xrightarrow{T_n} & \mathbf{Set}/S_n \\ U \downarrow & \swarrow \theta & \downarrow U \\ \mathbf{Set} & \xrightarrow{M} & \mathbf{Set}, \end{array}$$

where U is the forgetful functor and M is the free commutative monoid functor. This pair (U, θ) is, in fact, a monad opfunctor $(\mathbf{Set}/S_n, T_n) \longrightarrow (\mathbf{Set}, M)$. Intuitively, what θ does is to send a diagram like

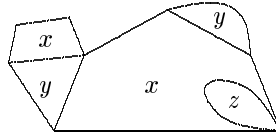

($n = 2$) to the set-with-multiplicities $\{x, x, y, y, z\}$.

We now follow the strategy of 3.1.1(iv). The objects-object of V is to be $\left(\begin{array}{c} W_0 \times S_n \\ \downarrow \\ S_n \end{array} \right)$: so for any $s \in S_n$, an object of V over s is just an object of W .

By choosing a function $M(W_0) \longrightarrow W_0$ which takes a set-with-multiplicities of objects and tensors them in some order, we obtain via θ a ‘tensor’ map

$$T_n \left(\begin{array}{c} W_0 \times S_n \\ \downarrow \\ S_n \end{array} \right) \longrightarrow \left(\begin{array}{c} W_0 \times S_n \\ \downarrow \\ S_n \end{array} \right).$$

Performing a similar operation for arrows, we get a T_n -multicategory V , which can be thought of as some kind of ‘weak T_n -structured category’. Different choices of the tensor function $M(W_0) \longrightarrow W_0$ only affect V up to isomorphism.

□



An explanation of this result can be given in terms of the ‘periodic table’ ([BaDo2], [Sim]), which displays for each $0 \leq k \leq n$ what kind of a structure

an n -category is when it only has one 0-cell, one 1-cell, \dots , one k -cell. The table suggests that for any $n \geq 1$, a symmetric monoidal category gives rise to an n -category with only one d -cell for $d \leq n - 2$. (When $n = 1$, of course, we don't even need 'monoidal', and when $n = 2$ we don't need 'symmetric'.) But according to the opetopic definition of n -category given in [BaDo1] or [HMP], an n -category with such a degeneracy is a T_{n-1} -multicategory with certain universality properties. Putting these together, a symmetric monoidal category gives rise to a T_{n-1} -multicategory for any $n \geq 1$, that is, to a T_n -multicategory for any $n \in \mathbb{N}$.

Chapter 4

Relaxed Multicategories

Relaxed multicategories can be thought of, according to [Bor], as multicategories in which the morphisms might have some sort of singularity. In a genuine multicategory, two morphisms $V, W \xrightarrow{f} X$ and $X, Y \xrightarrow{g} Z$ have a composite $V, W, Y \longrightarrow Z$. But imagine now that the objects of the multicategory are spaces of some kind and that an arrow $X_1, \dots, X_n \longrightarrow X$ is a function $X_1 \times \dots \times X_n \longrightarrow X$ which might have singularities of an ‘allowable’ kind. Then there’s a composite $g \circ (f \times 1) : V \times W \times Y \longrightarrow Z$ of f and g , but it might have a singularity of a more severe kind—compare the fact that the composite of two meromorphic functions need not be meromorphic. So $g \circ (f \times 1)$ lies in the set of

functions $V \times W \times Y \longrightarrow Z$ ‘with singularity of type ’; this is a larger set than that of functions $V \times W \times Y \longrightarrow Z$ with singularities of the allowable kind, which we call ‘singularities of type ’, (see Figure 4a). In general, for each n -leafed tree τ and sequence of objects X_1, \dots, X_n, X there’s a set $\text{Hom}_\tau(X_1, \dots, X_n; X)$ of functions with singularity type τ , and if $\tau' \longrightarrow \tau$ is a map of trees then there’s a map

$$\text{Hom}_\tau(X_1, \dots, X_n; X) \longrightarrow \text{Hom}_{\tau'}(X_1, \dots, X_n; X)$$

—in the present case, an inclusion, corresponding to the tree map

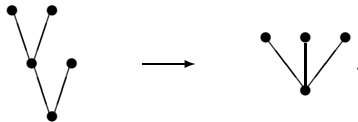

The whole structure is called a relaxed multicategory (Definition 4.1.1).

The first occurrence of this definition, or something close, was apparently in Beilinson and Drinfeld’s [BeDr]. This is cited in Soibelman’s [Soi], where

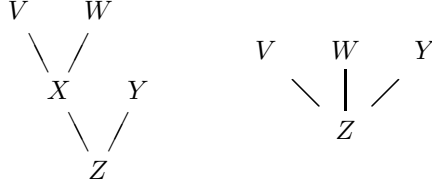

Figure 4a: Composing singular functions

the notion seems to have been adapted somewhat. Both papers use the term ‘pseudo-monoidal category’; Borchers, working independently, called them relaxed multicategories. The definition of the category of trees is different in each of [Bor], [Soi] (where the definition traces back to [KM1] and [KM2]) and the present work. My understanding is that the definition in [Bor] is *ad hoc* enough that it could be replaced by the one used here, but I do not know whether this is also the case for [Soi].

In 4.1 we define relaxed multicategories and give some examples. Section 4.2 shows that a relaxed multicategory is just a plain multicategory enriched in the T_2 -multicategory $[\mathbf{TR}^{\text{op}}, \mathbf{Set}]$, by which means we define relaxed T_n -multicategories for all n (which are relaxed multicategories when $n = 1$). We pay particular attention to ‘relaxed categories’, the case $n = 0$ (section 4.3). Sections 4.4 and 4.5 present dual ways in which relaxed multicategories can arise, which we will call ‘modifying the domain’ and ‘modifying the codomain’ respectively.

4.1 Basics

Definition 4.1.1 A relaxed multicategory C consists of:

- a set C_0 of objects
- for each $\tau \in \mathbf{TR}(n)$ and $a_1, \dots, a_n, a \in C_0$, a set $C_\tau(a_1, \dots, a_n; a)$
- for each map $\tau' \xrightarrow{\phi} \tau$ in $\mathbf{TR}(n)$, a function

$$\begin{array}{ccc} C_\tau(a_1, \dots, a_n; a) & \longrightarrow & C_{\tau'}(a_1, \dots, a_n; a) \\ f & \longmapsto & f \cdot \phi \end{array}$$

- for each $\tau \in \mathbf{TR}(n)$, $\tau_1 \in \mathbf{TR}(k_1)$, \dots , $\tau_n \in \mathbf{TR}(k_n)$, a ‘composition’ function

$$\begin{array}{ccc} C_{\tau_1}(a_1^1, \dots, a_1^{k_1}; a_1) \times \dots \times C_{\tau_n}(a_n^1, \dots, a_n^{k_n}; a_n) \times C_\tau(a_1, \dots, a_n; a) & \longrightarrow & C_{\tau \circ (\tau_1, \dots, \tau_n)}(a_1^1, \dots, a_n^{k_n}; a), \\ (f_1, \dots, f_n, f) & \longmapsto & f \circ (f_1, \dots, f_n) \end{array}$$

- for each $a \in C_0$, an ‘identity’ element 1_a of $C_\bullet(a; a)$,

subject to the following axioms:

- $f \cdot (\phi \circ \phi') = (f \cdot \phi) \cdot \phi'$ and $f \cdot 1 = f$, for any f, ϕ' and ϕ for which these make sense
- composition is associative, and the ‘identity’ elements are two-sided identities for composition (i.e. $f \circ (1, \dots, 1) = f = 1 \circ f$)
- compatibility:

$$(f \circ (f_1, \dots, f_n)) \cdot (\phi \circ (\phi_1, \dots, \phi_n)) = (f \cdot \phi) \circ (f_1 \cdot \phi_1, \dots, f_n \cdot \phi_n)$$

for any $f \in C_\tau(a_1, \dots, a_n; a)$, $f_i \in C_{\tau_i}(a_i^1, \dots, a_i^{k_i}; a_i)$, $\tau' \xrightarrow{\phi} \tau$ in $\mathbf{TR}(n)$, and $\tau'_i \xrightarrow{\phi_i} \tau_i$ in $\mathbf{TR}(k_i)$ ($1 \leq i \leq n$).

Examples 4.1.2

- If E is any monoidal category, then putting $C_0 = E_0$ and

$$C_\tau(a_1, \dots, a_n; a) = E(a_1 \otimes \dots \otimes a_n, a)$$

for all $\tau \in \mathbf{TR}(n)$ makes C into a relaxed multicategory.

- Let $\tau \in \mathbf{TR}(n)$, and number the n leaves of τ as $1, \dots, n$, working from left to right. Let $h_i(\tau)$ be the height of the i th leaf: that is, the length of the path from the leaf down to the root. Let M be a monoid. Then there is a relaxed multicategory whose objects are sets, and with

$$\mathrm{Hom}_\tau(X_1, \dots, X_n; X) = \prod_{1 \leq i \leq n} \mathbf{Set}(M^{h_i(\tau)} \times X_i, X).$$

To see what the maps between homsets induced by maps of trees are, let $\tau' \longrightarrow \tau$ be a map in $\mathbf{TR}(n)$ and let $1 \leq i \leq n$. Then there is an induced map $M^{h_i(\tau')} \longrightarrow M^{h_i(\tau)}$, as can be seen informally by thinking of a tree map as contracting internal edges and expanding nodes (see [Lei2, IV.3]), and will be shown in 4.4.4(ii). This in turn induces the map of homsets, and composition and identities are defined in a natural way. (Examples (ii)–(iv) are explained further in 4.4.4(ii)–(iv).)

- Let $v(\tau)$ denote the number of *internal vertices* of a tree τ : that is, those vertices which are not leaves. Any map $\tau' \longrightarrow \tau$ induces a map from the set of internal vertices of τ' to the set of internal vertices of τ , as may again be seen informally, and again will be gone into in more detail later (4.4.4(iii)). We also have the identity

$$v(\tau \circ (\tau_1, \dots, \tau_n)) = v(\tau) + v(\tau_1) + \dots + v(\tau_n).$$

These facts together mean that there is a relaxed multicategory whose objects are sets, and with

$$\mathrm{Hom}_\tau(X_1, \dots, X_n; X) = X^{v(\tau)} \times \prod_{1 \leq i \leq n} \mathbf{Set}(X_i, X).$$

- iv. If R is a commutative ring and A an R -algebra, then there is a relaxed multicategory whose objects are R -modules, and with

$$\mathrm{Hom}_\tau(X_1, \dots, X_n; X) = \mathrm{Hom}_R(X_1 \otimes \dots \otimes X_n \otimes A^{\otimes v(\tau)}, X).$$

- v. The motivating example of a relaxed multicategory in [Bor] is as follows. A *vertex group* over a commutative ring R consists, roughly, of a Hopf algebra H over R and a two-sided H -module K which also has the structure of an algebra over $H^* = \mathrm{Hom}_R(H, R)$. Borchers defines a relaxed multicategory $\mathbf{Rep}(G)$ of representations of any vertex group $G = (H, K)$, and then defines a *G -vertex algebra* to be a commutative monoid in $\mathbf{Rep}(G)$ (in a suitable sense). For a certain choice of G , the standard kind of vertex algebra is the same as a G -vertex algebra (see [Sny]).

In 4.5 we will look more closely at how the relaxed multicategory of (v) arises, and see that the general method is ‘dual’ to the general method in examples (ii)–(iv).

4.2 Relaxation via Enrichment

In this section we show that relaxed multicategories are a completely natural idea (‘no artificial ingredients’) from the point of view of general multicategory theory. Specifically, we first show that relaxed multicategories are just plain multicategories enriched in the T_2 -multicategory $[\mathbf{TR}^{\mathrm{op}}, \mathbf{Set}]$, and then we observe that $[\mathbf{TR}^{\mathrm{op}}, \mathbf{Set}]$ is ‘completely natural’. This enables us to give a definition of relaxed T_n -multicategory for any $n \in \mathbb{N}$, the familiar case being $n = 1$.

Our first task is to define $[\mathbf{TR}^{\mathrm{op}}, \mathbf{Set}]$. We have already seen (3.1.1(iv)) that any symmetric monoidal category, and in particular (\mathbf{Set}, \times) , is naturally a T_2 -multicategory. We have also met the T_2 -structured category \mathbf{TR} , and by swapping dom and cod we obtain an opposite T_2 -structured category, $\mathbf{TR}^{\mathrm{op}}$. (Thus the category $\mathbf{TR}^{\mathrm{op}}(n)$ is the opposite of the category $\mathbf{TR}(n)$.) Then $[\mathbf{TR}^{\mathrm{op}}, \mathbf{Set}]$ is the exponential in $T_2\text{-Multicat}$, the existence of which is guaranteed by:

Theorem 4.2.1 *Let S be a set and T a cartesian monad on \mathbf{Set}/S . Then any T -structured category (or rather, its underlying T -multicategory) is exponentiable in $T\text{-Multicat}$.*

Proof Largely omitted. Any $(\mathbf{Set}/S, T)$ -multicategory B has an underlying category object $|B|$ in \mathbf{Set}/S , so for each $s \in S$ there is a category $|B|(s)$. If

A is a T -structured category, the objects over $s \in S$ of the exponential $[A, B]$ are the functors $|A|(s) \longrightarrow |B|(s)$. We can then construct the arrows and the composition; for the latter, we need A to be a structured category rather than just a multicategory. Further hints are given at the beginning of 4.3. \square

Remark: We will only use the exponential $[A, B]$ when A is small, even though B might be large. This adds a measure of safety to our otherwise cavalier attitude to size.

Specifically, we need to know what the $(\mathbf{Set}/\mathbb{N}, T_2)$ -multicategory $[\mathbf{TR}^{\text{op}}, \mathbf{Set}]$ looks like. Following the description of T_2 -multicategories in [Lei2, p. 66]:

- an object over n is a functor $\mathbf{TR}(n)^{\text{op}} \longrightarrow \mathbf{Set}$
- an arrow

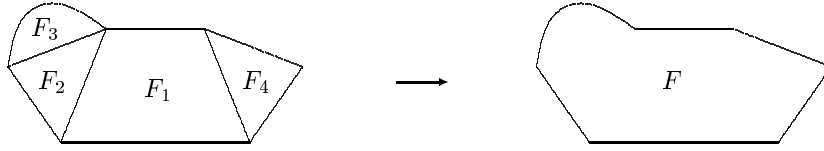

(for instance) is a family of functions

$$F_1\tau_1 \times F_2\tau_2 \times F_3\tau_3 \times F_4\tau_4 \longrightarrow F(\tau_1 \circ (\tau_2 \circ (1, \tau_3)), 1, \tau_4),$$

one for each $\tau_1 \in \mathbf{TR}(3), \tau_2 \in \mathbf{TR}(2), \tau_3 \in \mathbf{TR}(1), \tau_4 \in \mathbf{TR}(2)$, which is natural in the τ_i 's

- composition and identities are as of functions, i.e. come from the $(\mathbf{Set}/\mathbb{N}, T_2)$ -multicategory \mathbf{Set} .

We can now demonstrate that a plain multicategory enriched in $[\mathbf{TR}^{\text{op}}, \mathbf{Set}]$ is the same thing as a relaxed multicategory. For the former consists of

- a set C_0
- for each $a_1, \dots, a_n, a \in C_0$, a functor

$$C_{-}[a_1, \dots, a_n; a] : \begin{array}{ccc} \mathbf{TR}(n)^{\text{op}} & \longrightarrow & \mathbf{Set}, \\ \tau & \longmapsto & C_{\tau}[a_1, \dots, a_n; a] \end{array}$$

- for each $a, a_1, \dots, a_n, a_1^1, \dots, a_n^{k_n} \in C_0$, a family of functions

$$C_{\tau_1}[a_1^1, \dots, a_1^{k_1}; a_1] \times \dots \times C_{\tau_n}[a_n^1, \dots, a_n^{k_n}; a_n] \times C_{\tau}[a_1, \dots, a_n; a] \longrightarrow C_{\tau \circ (\tau_1, \dots, \tau_n)}[a_1^1, \dots, a_n^{k_n}; a],$$

one for each $\tau \in \mathbf{TR}(n), \tau_1 \in \mathbf{TR}(k_1), \dots, \tau_n \in \mathbf{TR}(k_n)$, which is natural in the τ_i 's and τ

- for each $a \in C_0$, a function $1 \longrightarrow C_{\bullet}[a; a]$, i.e. an element of $C_{\bullet}[a; a]$,

such that associativity and identity axioms hold. This is exactly what a relaxed multicategory is.

Three generalizations of the notion of T_1 -multicategories enriched in $[\mathbf{TR}^{\text{op}}, \mathbf{Set}]$ now present themselves.

Firstly, \mathbf{Set} could be changed to any other symmetric monoidal category. By changing (\mathbf{Set}, \times) to (\mathbf{Ab}, \otimes) we obtain what Borchers calls a relaxed *multilinear* category: thus the homsets $C_\tau[a_1, \dots, a_n; a]$ are not just sets but abelian groups.

Secondly, \mathbf{TR} could be changed to any other T_2 -structured category \mathcal{T} . Then we obtain what Soibelman calls a ‘ \mathcal{T} -pseudo monoidal category’ in [Soi].

Thirdly, we have been discussing enriched T_1 -multicategories, but there is nothing special here about the number 1: it could be replaced by any n , as follows.

Recall that \mathbf{TR} is not just any old T_2 -structured category, but in fact the free such on the terminal T_2 -multicategory: in the terminology of 1.5, $\mathbf{TR} = \mathbf{PD}_2$. So a relaxed multicategory is a T_1 -multicategory enriched in the T_2 -multicategory $[\mathbf{PD}_2^{\text{op}}, \mathbf{Set}]$. Recall too that a symmetric monoidal category gives not just a T_2 -multicategory, but a T_n -multicategory for any n (Proposition 3.4.1). We may therefore generalize:

Definition 4.2.2 *Let $n \in \mathbb{N}$. A relaxed T_n -multicategory is a T_n -multicategory enriched in the T_{n+1} -multicategory $[\mathbf{PD}_{n+1}^{\text{op}}, \mathbf{Set}]$.*

Thus a relaxed T_1 -multicategory is a relaxed multicategory. By thinking in terms of pasting diagrams rather than trees, the basic idea for $n \geq 2$ becomes apparent. The case $n = 0$ is also illuminating, and this is the subject of the next section.

4.3 Relaxed Categories

Since a T_0 -multicategory is a category, relaxed T_0 -multicategories will be called, perhaps rather disturbingly, *relaxed categories*. These are categories enriched in the plain multicategory $[\Delta^{\text{op}}, \mathbf{Set}]$, so we first of all need to know what $[\Delta^{\text{op}}, \mathbf{Set}]$ is; but in order to do *this* we make a short digression on Theorem 4.2.1.

Let A be any strict monoidal category and B any plain multicategory. Theorem 4.2.1 guarantees that the exponential $[A, B]$ of multicategories exists. One might think that an object of $[A, B]$ would be a multicategory map $A \longrightarrow B$, but this is not the case. For multicategory maps $A \longrightarrow B$ correspond to multicategory maps $1 \longrightarrow [A, B]$, and a map from 1 (the terminal multicategory) to a multicategory C is a ‘monoid’ in C , in other words, an object c of C together with arrows $c, c \longrightarrow c$ and $\cdot \longrightarrow c$ satisfying the usual axioms. (When C is a monoidal category, this is just Bénabou’s observation that a lax functor $1 \longrightarrow C$ is a monoid in C : [Bén, 5.4.2].) So $[A, B]$ has the property that a *monoid* in it is a multicategory map $A \longrightarrow B$.

However, if we define I to be the multicategory with one object and just one arrow (the identity), then a map $I \longrightarrow C$ of multicategories is the same

as an object of C . Thus the objects of $[A, B]$ are the multicategory maps $I \times A \longrightarrow B$: equivalently, they are the functors $|A| \longrightarrow |B|$, where $|\cdot|$ indicates the underlying category of a plain multicategory obtained by ignoring all non-unary arrows.

An object of the multicategory $[\Delta^{\text{op}}, \mathbf{Set}]$ is, therefore, a functor $\Delta^{\text{op}} \longrightarrow \mathbf{Set}$. We can also compute that an arrow $F_1, \dots, F_n \xrightarrow{\phi} F$ is a family of functions

$$F_1 k_1 \times \dots \times F_n k_n \xrightarrow{\phi_{k_1, \dots, k_n}} F(k_1 + \dots + k_n)$$

$(k_1, \dots, k_n \in \mathbb{N})$ which are natural in the k_i 's: that is, if $k'_i \xrightarrow{p_i} k_i$ is an arrow in Δ for each i , then

$$\begin{array}{ccc} F_1 k_1 \times \dots \times F_n k_n & \xrightarrow{\phi_{k_1, \dots, k_n}} & F(k_1 + \dots + k_n) \\ \downarrow F_1 p_1 \times \dots \times F_n p_n & & \downarrow F(p_1 + \dots + p_n) \\ F_1 k'_1 \times \dots \times F_n k'_n & \xrightarrow{\phi_{k'_1, \dots, k'_n}} & F(k'_1 + \dots + k'_n) \end{array}$$

commutes. Composition and identities are got by composing the functions ϕ_{k_1, \dots, k_n} .

(In fact, $[\Delta^{\text{op}}, \mathbf{Set}]$ is not just a multicategory but a monoidal category, although we don't need to know this. The monoidal structure is the Day tensor product. Note in particular that it is not the cartesian product, so relaxed categories are not the same as the simplicially enriched categories sometimes considered in homotopy theory.)

A relaxed category C consists, therefore, of

- i. a set C_0
- ii. for each $a, b \in C_0$ and $n \in \mathbb{N}$, a set $C_n[a, b]$
- iii. for each map $n' \longrightarrow n$ in Δ , a function $C_n[a, b] \longrightarrow C_{n'}[a, b]$
- iv. for each a, b, c, m, n , a 'composition' function

$$C_m[a, b] \times C_n[b, c] \longrightarrow C_{m+n}[a, c]$$

- v. for each a , an 'identity' element of $C_0[a, a]$

such that the assignment in (iii) is functorial, the composition and identities obey associativity and identity laws, and the following compatibility rule holds: if $m' \longrightarrow m$ and $n' \longrightarrow n$ in Δ then

$$\begin{array}{ccc} C_m[a, b] \times C_n[b, c] & \longrightarrow & C_{m+n}[a, c] \\ \downarrow & & \downarrow \\ C_{m'}[a, b] \times C_{n'}[b, c] & \longrightarrow & C_{m'+n'}[a, c] \end{array}$$

commutes.

A relaxed category can be thought of, roughly, as an ordinary category in which each map has a degree (a natural number) and composing maps adds the degrees.

Examples 4.3.1

- i. Any category D gives two different relaxed categories, C and C' . Both have the same object-set as D , and then

$$\begin{aligned} C_n[a, b] &= D(a, b) \text{ for all } n, \\ C'_n[a, b] &= \begin{cases} D(a, b) & \text{if } n = 0 \\ \emptyset & \text{otherwise.} \end{cases} \end{aligned}$$

- ii. (This example is due to Craig Snýdal.) Let \mathcal{C}_0 be a/the collection of abelian groups, and define a relaxed category \mathcal{C} by

$$C_n[A, B] = \mathbf{Ab}(A, B[x_1, \dots, x_n]),$$

where $B[x_1, \dots, x_n]$ is the abelian group of polynomials in n commuting variables with coefficients in B . A map $n' \longrightarrow n$ in Δ induces a map $B[x_1, \dots, x_n] \longrightarrow B[y_1, \dots, y_{n'}]$ of abelian groups, and so induces the required map of the enriched homsets. (The exact formula for this can be recovered from (iv) below.) For composition, suppose $f \in \mathbf{Ab}(A, B[x_1, \dots, x_n])$ and $g \in \mathbf{Ab}(B, C[y_1, \dots, y_m])$: then the composite $g \circ f$ in \mathcal{C} is the composite

$$A \xrightarrow{f} B[x_1, \dots, x_n] \xrightarrow{g[x_1, \dots, x_n]} C[y_1, \dots, y_m][x_1, \dots, x_n] \cong C[z_1, \dots, z_{m+n}]$$

in \mathbf{Ab} .

- iii. Dually, there is a relaxed category \mathcal{C}' whose objects are again abelian groups, and with

$$C'_n[A, B] = \mathbf{Ab}(A[[x_1, \dots, x_n]], B)$$

where $A[[x_1, \dots, x_n]]$ is the abelian group of formal power series.

- iv. Let D be a category with a comonad G on it: then there's an associated relaxed category \mathcal{C} with $C_0 = D_0$,

$$C_n[a, b] = D(a, G^n b),$$

composition defined by G being a functor, and the maps $C_n[a, b] \longrightarrow C_{n'}[a, b]$ defined by G being a comonad. Example (ii) is exactly this, with G the comonad $B \mapsto B[x]$ on \mathbf{Ab} . This *is* a comonad: for \mathbb{N} , like any other set, is a comonoid in (\mathbf{Set}, \times) , so the copower functor $\mathbb{N} \times - : \mathbf{Ab} \longrightarrow \mathbf{Ab}$ has the structure of a comonad, and $\mathbb{N} \times B = B[x]$.

- v. Dually, if D is a category with a monad T on it, then there arises a relaxed category C' with $C'_0 = D_0$ and

$$C'_n[a, b] = D(T^n a, b).$$

Example (iii) exhibits this when T is the monad $A \mapsto A[[x]] = A^{\mathbb{N}}$ on \mathbf{Ab} .

4.4 Relaxed Monoidal Categories

A relaxed multicategory is like a multicategory, except that composition behaves less uniformly than usual (in the sense of the introduction to this chapter). Similarly, a relaxed monoidal category will be like a monoidal category except that the tensor (written \square) behaves less uniformly than usual. As the name suggests, any relaxed monoidal category has an underlying relaxed multicategory: just as we got a multicategory C from a monoidal category D by putting

$$C(a_1, \dots, a_n; a) = D(a_1 \otimes \dots \otimes a_n, a),$$

we will similarly get a relaxed multicategory C from a relaxed monoidal category D by putting

$$C_\tau(a_1, \dots, a_n; a) = D(\square_\tau(a_1, \dots, a_n), a).$$

A relaxed monoidal category is a category D together with n -fold tensor functors $\square_n : D^n \longrightarrow D$ for each n , but these are *not* required to patch together isomorphically: instead, we just have maps like

$$\begin{aligned} [[a_1 \square a_2] \square a_3] &\longrightarrow [a_1 \square a_2 \square a_3], \\ [a_1 \square [a_2 \square a_3 \square []]] &\longrightarrow [[a_1] \square [a_2 \square a_3]], \end{aligned} \quad (4A)$$

where

$$\begin{aligned} \square_n(a_1, \dots, a_n) &\text{ is written as } [a_1 \square \dots \square a_n] \quad (n \geq 2), \\ \square_1(a) &\text{ is written as } [a], \\ \square_0 &\text{ is written as } []. \end{aligned}$$

The maps in (4A) come from maps of trees whose leaves are notionally labelled by the a_i 's: e.g. in the first case,

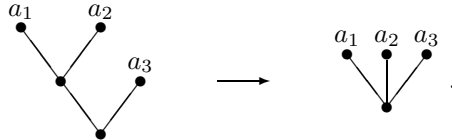

However, relaxed monoidal categories can be defined without mention of trees:

Definition 4.4.1 Let $((\)^*, \eta, \mu)$ be the free strict monoidal category monad on **Cat**. A relaxed monoidal category consists of a category D together with a functor $\square : D^* \longrightarrow D$ and natural transformations

$$\begin{array}{ccc} D^{**} & \xrightarrow{\mu_D} & D^* \\ \square^* \downarrow & \nearrow \gamma & \downarrow \square \\ D^* & \xrightarrow{\square} & D \end{array} \quad \begin{array}{ccc} D & \xrightarrow{\eta_D} & D^* \\ \searrow 1 & \nearrow \iota & \downarrow \square \\ & & D \end{array}$$

satisfying axioms looking like associativity and identity: that is,

$$\begin{array}{ccc} \square \circ \square^* \circ \square^{**} & \xrightarrow{\gamma * 1} & \square \circ \mu_D \circ \square^{**} = \square \circ \square^* \circ \mu_{D^*} \\ \downarrow 1 * \gamma^* & & \downarrow \gamma * 1 \\ \square \circ \square^* \circ \mu_D^* & \xrightarrow{\gamma * 1} & \square \circ \mu_D \circ \mu_D^* = \square \circ \mu_D \circ \mu_{D^*} \end{array}$$

$$\begin{array}{ccc} 1_{D \circ \square} \xrightarrow{\iota * 1} \square \circ \eta_D \circ \square = \square \circ \square^* \circ \eta_{D^*} & \square \circ \square^* \circ \eta_D^* \xleftarrow{1 * \iota^*} \square \circ 1_D^* \\ \searrow 1 & \downarrow \gamma * 1 & \downarrow \gamma * 1 \\ & \square \circ \mu_D \circ \eta_{D^*} & \square \circ \mu_D \circ \eta_D^* \end{array}$$

all commute.

So γ assigns maps

$$[[a_1^1 \square \dots \square a_1^{k_1}] \square \dots \square [a_n^1 \square \dots \square a_n^{k_n}]] \longrightarrow [a_1^1 \square \dots \square a_n^{k_n}]$$

($n, k_i \in \mathbb{N}$), and ι assigns maps $a \longrightarrow [a]$.

Examples 4.4.2

- i. A relaxed monoidal category in which γ and ι are isomorphisms is just a monoidal category (of the unbiased kind—see 1.4).
- ii. Here is a general recipe for constructing relaxed monoidal categories. Let (D, \otimes) be a genuine monoidal category, and (T, η, μ) a monad on D in which T has the structure of a lax monoidal functor. Write $\otimes(a_1, \dots, a_n)$ as $\langle a_1 \otimes \dots \otimes a_n \rangle$. Now define

$$[a_1 \square \dots \square a_n] = T \langle a_1 \otimes \dots \otimes a_n \rangle,$$

ι_a as

$$a \xrightarrow{\eta_a} Ta \xrightarrow{\sim} T\langle a \rangle = [a],$$

and γ by

$$\begin{aligned} & [[a_1^1 \square \cdots \square a_1^{k_1}] \square \cdots \square [a_n^1 \square \cdots \square a_n^{k_n}]] \\ &= T\langle T\langle a_1^1 \otimes \cdots \otimes a_1^{k_1} \rangle \otimes \cdots \otimes T\langle a_n^1 \otimes \cdots \otimes a_n^{k_n} \rangle \rangle \\ &\longrightarrow T^2\langle \langle a_1^1 \otimes \cdots \otimes a_1^{k_1} \rangle \otimes \cdots \otimes \langle a_n^1 \otimes \cdots \otimes a_n^{k_n} \rangle \rangle \\ &\xrightarrow{\sim} T^2\langle a_1^1 \otimes \cdots \otimes a_n^{k_n} \rangle \\ &\longrightarrow T\langle a_1^1 \otimes \cdots \otimes a_n^{k_n} \rangle \\ &= [a_1^1 \square \cdots \square a_n^{k_n}], \end{aligned}$$

where the first map comes from T being lax monoidal, the second comes from a coherence isomorphism in D , and the third is a component of μ .

- iii. Let D be a category with finite coproducts: then $(D, +)$ is a monoidal category, and any endofunctor on D naturally has the structure of a lax monoidal functor. So by (ii), any monad (T, η, μ) on D gives a relaxed monoidal category with $[a_1 \square \cdots \square a_n] = T(a_1 + \cdots + a_n)$.
- iv. In (ii), take the monoidal category $(\mathbf{Set}, +)$, a monoid M , and the monad $T = M \times \text{---}$. Then T actually preserves $+$ up to coherent isomorphism (i.e. is a strong monoidal functor), so

$$[X_1 \square \cdots \square X_n] = M \times (X_1 + \cdots + X_n) \cong (M \times X_1) + \cdots + (M \times X_n).$$

- v. Suppose (D, \otimes) is a *symmetric* monoidal category, M is a monoid in (D, \otimes) , and $T = M \otimes \text{---}$. The monoid M corresponds to a lax monoidal functor $1 \xrightarrow{M} D$, and T is then the composite

$$D \xrightarrow{\sim} 1 \times D \xrightarrow{\bar{M} \times 1} D \times D \xrightarrow{\otimes} D.$$

But (D, \otimes) being symmetric means that \otimes is a monoidal functor, so T has the structure of a lax monoidal functor. So we get a relaxed monoidal category (D, \square) with

$$[a_1 \square \cdots \square a_n] = M \otimes a_1 \otimes \cdots \otimes a_n.$$

- vi. As a concrete instance of the last example, take $(D, \otimes) = (\mathbf{Set}, +)$ and $M = 1$ to get a relaxed multicategory whose objects are sets and with

$$[X_1 \square \cdots \square X_n] = X_1 + \cdots + X_n + 1.$$

We now give an alternative definition of relaxed monoidal category, more suitable for generalizing to other dimensions. If (D, \square) is a relaxed monoidal category then for each $\tau \in \mathbf{TR}(n)$ there is a functor $\square_\tau : D^n \longrightarrow D$, defined inductively by

- $\square_{\bullet} = 1_D$
- $\square_{\langle \tau_1, \dots, \tau_n \rangle} = \square_n \circ (\square_{\tau_1} \times \dots \times \square_{\tau_n})$.

(We are using the inductive definition of trees given in [Lei2, p. 13, 70].) Moreover, if $\tau' \longrightarrow \tau$ is a map of trees then we get a natural transformation $\square_{\tau'} \longrightarrow \square_{\tau}$, by similar inductive means. So we have found a functor

$$\square_{_} : \mathbf{TR}(n) \longrightarrow [D^n, D]$$

for each n . These fit together nicely: if $\mathbf{End}(D)$ is the obvious $(\mathbf{Cat}, *)$ -operad with

$$(\mathbf{End}(D))(n) = [D^n, D],$$

then we have a map

$$\square_{_} : \mathbf{TR} \longrightarrow \mathbf{End}(D)$$

of $(\mathbf{Cat}, *)$ -operads (= \mathbf{Cat} -enriched operads: see 3.3.1(i)). Conversely, the functors \square_n can be recovered from $\square_{_}$ by taking τ to be the n -leafed tree



the tree maps

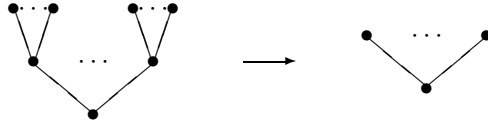

and

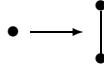

respectively. Hence:

Proposition 4.4.3 *A relaxed monoidal category is a category D together with a map $\mathbf{TR} \longrightarrow \mathbf{End}(D)$ of $(\mathbf{Cat}, *)$ -operads. \square*

The data we have just assembled is enough to show that every relaxed monoidal category yields a relaxed multicategory. For if $\square_{_} : \mathbf{TR} \longrightarrow \mathbf{End}(D)$ is a relaxed monoidal category, then there is a relaxed multicategory C defined by

- $C_0 = D_0$
- $C_{\tau}(a_1, \dots, a_n; a) = D(\square_{\tau}(a_1, \dots, a_n), a)$
- if $\tau' \longrightarrow \tau$ is a map of trees then

$$C_{\tau}(a_1, \dots, a_n; a) \longrightarrow C_{\tau'}(a_1, \dots, a_n; a)$$

is induced by $\square_{\tau'} \longrightarrow \square_{\tau}$

- if $f : \square_\tau(a_1, \dots, a_n) \longrightarrow a$ and $f_i : \square_{\tau_i}(a_i^1, \dots, a_i^{k_i}) \longrightarrow a_i$ are maps in D (with $\tau \in \mathbf{TR}(n)$, $\tau_i \in \mathbf{TR}(k_i)$, $1 \leq i \leq n$), then their composite in C is the composite

$$\begin{array}{ccc}
\square_{\tau \circ (\tau_1, \dots, \tau_n)}(a_1^1, \dots, a_n^{k_n}) & & \\
\downarrow \xrightarrow{1} & \square_\tau(\square_{\tau_1}(a_1^1, \dots, a_1^{k_1}), \dots, \square_{\tau_n}(a_n^1, \dots, a_n^{k_n})) & \\
\downarrow \xrightarrow{\square_\tau(f_1, \dots, f_n)} & \square_\tau(a_1, \dots, a_n) & \\
\downarrow \xrightarrow{f} & a &
\end{array}$$

in D .

- if $a \in C_0$ then the identity on a is $\square_\bullet(a) \xrightarrow{1} a$.

We call C the *underlying* relaxed multicategory of D .

In fact, all but one of our examples 4.1.2 of relaxed multicategories come from relaxed monoidal categories (and the exception is handled in section 4.5):

Examples 4.4.4

- If we take the relaxed multicategory C arising trivially from a monoidal category E (see 4.1.2(i)), and the relaxed monoidal category D arising trivially from E (see 4.4.2(i)), then C is the relaxed multicategory underlying D .
- The relaxed multicategory of 4.1.2(ii) underlies the relaxed monoidal category D of 4.4.2(iv). For by a simple induction on τ ,

$$\square_\tau(X_1, \dots, X_n) = T^{h_1(\tau)}X_1 + \dots + T^{h_n(\tau)}X_n$$

(just on the grounds that $T = (M \times -)$ preserves the monoidal structure $+$), giving the formula of 4.1.2(ii).

- Similarly, 4.1.2(iii) comes from 4.4.2(vi). In the relaxed monoidal category we have

$$\square_\tau(X_1, \dots, X_n) = X_1 + \dots + X_n + v(\tau),$$

so in the underlying relaxed multicategory,

$$\begin{aligned}
\mathrm{Hom}_\tau(X_1, \dots, X_n; X) &= \mathbf{Set}(X_1 + \dots + X_n + v(\tau), X) \\
&= X^{v(\tau)} \times \prod_{1 \leq i \leq n} \mathbf{Set}(X_i, X).
\end{aligned}$$

- With just the same reasoning as in (iii), Example 4.1.2(iv) comes from 4.4.2(v).

We have seen how a relaxed multicategory arises from a category C together with a map $\mathbf{TR} \longrightarrow \mathbf{End}(C)$ of $(\mathbf{Cat}, *)$ -operads. We now give an analogue

one level down, for relaxed categories; this seems as if it should generalize quite easily to relaxed T_n -multicategories for all n , but we do not attempt this here.

So: $(\mathbf{Set}/S_1, T_1)$ is $(\mathbf{Set}, \text{free monoid})$, and by taking internal categories we obtain the category \mathbf{Cat} and the free strict monoidal category monad $*$ on it. One level down, $(\mathbf{Set}/S_0, T_0)$ is (\mathbf{Set}, id) , and taking internal categories gives the category \mathbf{Cat} with the identity monad on it. The analogue of $\mathbf{TR} = \mathbf{PD}_2$ is $\Delta = \mathbf{PD}_1$, and so the analogue of a relaxed monoidal category is a category D together with a map $\Delta \longrightarrow \mathbf{End}(D)$ of (\mathbf{Cat}, id) -operads. Now (\mathbf{Cat}, id) -operads are just strict monoidal categories, and $\mathbf{End}(D)$ is being used to denote the familiar monoidal category $[D, D]$, so what we have is just a category D with a monad on it. Our argument by analogy therefore suggests: given a category D with a monad T on it, we should obtain a relaxed category C by putting $C_0 = D_0$ and

$$C_n[a, b] = D(T^n a, b).$$

And indeed, this is precisely Example 4.3.1(v).

4.5 Modifying the Codomain

In the previous section we defined relaxed multicategories and relaxed categories C by, respectively,

$$\begin{aligned} C_\tau(a_1, \dots, a_n; a) &= D(\square_\tau(a_1, \dots, a_n), a), \\ C_n[a', a] &= D(T^n a', a), \end{aligned}$$

where D is a category and \square_τ and T^n are functions with suitable properties. Thus we obtain relaxed structures by modifying the domain. This section is the dual: relaxed structures will be obtained by modifying the codomain. More specifically, given a plain multicategory D we define a relaxed multicategory C by $C_0 = D_0$ and

$$C_\tau(a_1, \dots, a_n; a) = D(a_1, \dots, a_n; Q_\tau a), \quad (4B)$$

where Q_τ is some suitable family of functions. Similarly, given a category D we define a relaxed category C by $C_0 = D_0$ and

$$C_n[a', a] = D(a', Q_n a). \quad (4C)$$

The question is, then: what must Q_τ be?

Let us take relaxed categories first. In order for $C_\tau[a', a]$ to be a simplicial set for fixed a' and a , $Q_\tau a$ must be a functor $\Delta^{\text{op}} \longrightarrow D$. The only sensible way of defining composites will be if we have a map $Q_{n'} Q_n a \longrightarrow Q_{n'+n} a$ for each n' , n and a : for then, if $f \in D(a', Q_n a)$ and $f' \in D(a'', Q_{n'} a')$, the composite $f' \circ f$ in C can be defined as the composite

$$a'' \xrightarrow{f'} Q_{n'} a' \xrightarrow{Q_{n'} f} Q_{n'} Q_n a \longrightarrow Q_{n'+n} a$$

in D . Here we have used the expression $Q_{n'}f$, so $Q_{n'}$ should be a functor $D \longrightarrow D$; thus Q_- is a functor $\Delta^{\text{op}} \longrightarrow [D, D]$. To get identities, we will also need a map $a \longrightarrow Q_0a$ for each a .

We have now argued that a functor $Q : \Delta^{\text{op}} \longrightarrow [D, D]$, together with maps $Q_{n'}Q_n a \longrightarrow Q_{n'+n}a$ and $a \longrightarrow Q_0a$ satisfying some axioms, will give us a relaxed category via (4C). These axioms assert precisely that Q is a lax monoidal functor, which is the same as a map of plain multicategories (see 1.4). Hence:

Theorem 4.5.1 *Let D be a category and $Q_- : \Delta^{\text{op}} \longrightarrow [D, D]$ a map of plain multicategories. Then there is a relaxed category C with $C_0 = D_0$ and $C_n[a', a] = D(a', Q_n a)$. \square*

Examples 4.5.2

- i. If Q_- is constant with value 1_D then the resulting relaxed category is the C of 4.3.1(i).
- ii. Comonads on a category D correspond to *strict* monoidal functors $\Delta^{\text{op}} \longrightarrow [D, D]$, so for any comonad G on D there is a relaxed category C with $C_n[a', a] = D(a', G^n a)$. This is Example 4.3.1(iv).
- iii. Let R be a commutative ring and L a coalgebra over R , i.e. a comonoid in the monoidal category $(R\text{-Mod}, \otimes_R)$ of left R -modules. Then R -modules can be made to form a relaxed category as follows.

Firstly, there is a lax monoidal functor

$$\overline{\otimes}_{\mathbb{Z}} : R\text{-Mod} \longrightarrow [R\text{-Mod}, R\text{-Mod}]$$

which is the transpose of the functor

$$\otimes_{\mathbb{Z}} : R\text{-Mod} \times R\text{-Mod} \longrightarrow R\text{-Mod}.$$

(Note that we are using $\otimes_{\mathbb{Z}}$ rather than \otimes_R , so $\overline{\otimes}_{\mathbb{Z}}$ is genuinely only a *lax* monoidal functor.) Secondly, the coalgebra L ‘is’ the monoidal functor $L^{\otimes_R(-)} : \Delta^{\text{op}} \longrightarrow R\text{-Mod}$, sending n to $L^{\otimes_R n}$. Hence there is a lax monoidal functor

$$\overline{\otimes}_{\mathbb{Z}} \circ L^{\otimes_R(-)} : \Delta^{\text{op}} \longrightarrow [R\text{-Mod}, R\text{-Mod}],$$

giving a relaxed category C whose objects are the R -modules. Explicitly, a map $X' \longrightarrow X$ in C of degree n is a homomorphism $X' \longrightarrow X \otimes_{\mathbb{Z}} L^{\otimes_R n}$ of left R -modules.

Moving up a level, we will demonstrate:

Theorem 4.5.3 *Let D be a plain multicategory and $Q_- : \mathbf{TR}^{\text{op}} \longrightarrow [D, D]$ a map of T_2 -multicategories. Then there is a relaxed multicategory C with $C_0 = D_0$ and*

$$C_{\tau}(a_1, \dots, a_n; a) = C(a_1, \dots, a_n; Q_{\tau} a).$$

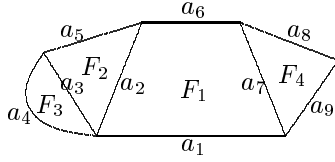

Figure 4b: Mental picture for placing of variables a_i

where a_1, \dots, a_9 are objects of D (Figure 4b). So given some arrows in D as above the line, we get an arrow as below the line; this assignment is to be compatible with composition with arrows in $|D|$, in a sense suggested by the compatibility axioms of 3.1.1(i).

We can now sketch a proof of Theorem 4.5.3. Take a plain multicategory D and a map $Q_- : \mathbf{TR}^{\text{op}} \rightarrow [D, D]$. Put $C_0 = D_0$. Fix $a_1, \dots, a_n, a \in C_0$. For any $\tau \in \mathbf{TR}(n)$ we have a functor $Q_\tau : |D| \rightarrow |D|$, and we define

$$C_\tau(a_1, \dots, a_n; a) = D(a_1, \dots, a_n; Q_\tau a).$$

A map $\tau' \rightarrow \tau$ of trees induces a morphism $\widehat{Q}_\tau \rightarrow \widehat{Q}_{\tau'}$ of profunctors, or equivalently a natural transformation $Q_\tau \rightarrow Q_{\tau'}$. Thus we obtain a function

$$C_\tau(a_1, \dots, a_n; a) \rightarrow C_{\tau'}(a_1, \dots, a_n; a),$$

as required.

This has covered all the structure of C for fixed objects a_1, \dots, a_n, a ; next we turn to composition. Suppose we have trees $\tau \in \mathbf{TR}(n)$, $\tau_1 \in \mathbf{TR}(k_1), \dots, \tau_n \in \mathbf{TR}(k_n)$. The canonical map

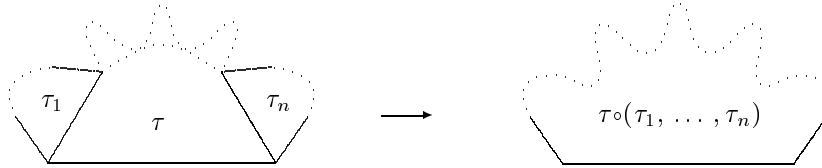

in the T_2 -multicategory \mathbf{TR}^{op} is sent by Q_- to a map

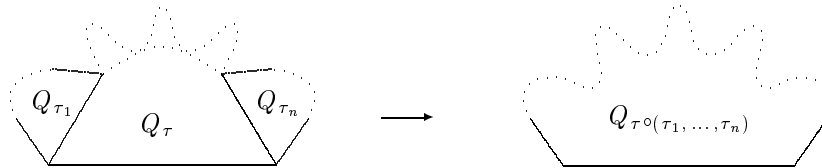

in $[D, D]$. This map is a family of functions

$$D(a_1, \dots, a_n; Q_\tau a) \times D(a_1^1, \dots, a_1^{k_1}; Q_{\tau_1} a_1) \times \dots \times D(a_n^1, \dots, a_n^{k_n}; Q_{\tau_n} a_n) \\ \longrightarrow D(a_1^1, \dots, a_n^{k_n}; Q_{\tau \circ (\tau_1, \dots, \tau_n)} a),$$

one for each $a, a_1, \dots, a_n, a_1^1, \dots, a_n^{k_n}$, and so provides composition in C . Identities go through similarly. We then just have to check the axioms, and this is straightforward.

Theorem 4.5.3 was developed with representations of vertex groups in mind (Example 4.1.2(v)). Since the Hopf algebra H is in particular a (not necessarily commutative) ring, there is a plain multicategory $H\text{-Mod}$ in which the objects are H -modules and the arrows are multilinear maps. From $G = (H, K)$, a new H -module $Fun_\tau(G^n, A)$ is constructed for each H -module A and tree $\tau \in \mathbf{TR}(n)$. There is then a relaxed multicategory whose objects are H -modules, and with

$$\text{Hom}_\tau(A_1, \dots, A_n; A) = H\text{-Mod}(A_1, \dots, A_n; Fun_\tau(G^n, A)).$$

(This relaxed multicategory is not quite $\mathbf{Rep}(G)$, as there are some further subtleties involving G -invariance; it contains $\mathbf{Rep}(G)$ as a substructure.) Whether or not Fun really does determine a multicategory map

$$\mathbf{TR}^{\text{op}} \longrightarrow [H\text{-Mod}, H\text{-Mod}]$$

has probably yet to be verified.

Appendix A

Free Multicategories

In this appendix we define ‘suitability’ and sketch proofs of Theorems 1.2.1 and 1.2.2. First, we need some terminology.

Let \mathcal{E} be a category with pullbacks, \mathbb{I} a small category, $D : \mathbb{I} \longrightarrow \mathcal{E}$ a functor for which a colimit exists, and $(D(I) \longrightarrow Z)_{I \in \mathbb{I}}$ a colimit cone. We say that the colimit is *stable under pullback* if for any map $Z' \longrightarrow Z$ in \mathcal{E} , the cone $(D'(I) \longrightarrow Z')_{I \in \mathbb{I}}$ is a colimit cone; here D' and the new cone are obtained by pullback, so that

$$\begin{array}{ccc} D' & \longrightarrow & D \\ \downarrow & & \downarrow \\ Z' & \longrightarrow & Z \end{array}$$

is a pullback square in the functor category $[\mathbb{I}, \mathcal{E}]$.

The morphisms k_I in a colimit cone $(D(I) \xrightarrow{k_I} Z)_{I \in \mathbb{I}}$ will be called the *coprojections* of the colimit, and in particular we say that the colimit of D ‘has monic coprojections’ to mean that each k_I is monic.

A category will be said to have *disjoint finite coproducts* if it has finite coproducts, these coproducts have monic coprojections, and for any pair A, B of objects, the square

$$\begin{array}{ccc} 0 & \longrightarrow & B \\ \downarrow & & \downarrow \\ A & \longrightarrow & A + B \end{array}$$

is a pullback.

Let ω be the natural numbers with their usual ordering. A *nested sequence* in a category \mathcal{E} is a functor $\omega \longrightarrow \mathcal{E}$ in which the image of every morphism of ω is monic. In other words, it is a diagram

$$A_0 \rightrightarrows A_1 \rightrightarrows \cdots$$

in \mathcal{E} , where as usual \rightrightarrows indicates a monic. Note that a functor which preserves pullbacks also preserves monics, so it makes sense for such a functor

to ‘preserve colimits of nested sequences’. Similarly, it makes sense to say that colimits of nested sequences commute with pullbacks (by an easy calculation), where ‘commute’ is used in the same sense as when we say that filtered colimits commute with finite limits in **Set**.

Recall (from [Lei1] or [Lei2, Chapter I]) that a category is called *cartesian* if it has all finite limits; a monad (T, η, μ) is called *cartesian* if T preserves pullbacks and the squares expressing the naturality of η and of μ are all pullbacks; the phrase ‘ (\mathcal{E}, T) is cartesian’ is used to mean that T is a cartesian monad on a cartesian category \mathcal{E} . (Here, as elsewhere, we abuse language by calling a monad by the name of its functor part.)

Finally, we can give the definition of suitability. A category \mathcal{E} is *suitable* if it satisfies

C1 \mathcal{E} is cartesian

C2 \mathcal{E} has disjoint finite coproducts which are stable under pullback

C3 \mathcal{E} has colimits of nested sequences; these commute with pullbacks and have monic coprojections.

A monad (T, η, μ) is *suitable* if it satisfies

M1 (T, η, μ) is cartesian

M2 T preserves colimits of nested sequences.

We say that (\mathcal{E}, T) is *suitable* when (T, η, μ) is a suitable monad on a suitable category \mathcal{E} .

We now sketch a proof of the main theorem, 1.2.1, on the formation of free multicategories, which for convenience is re-stated here.

Theorem 1.2.1 *Let (\mathcal{E}, T) be suitable. Then the forgetful functor*

$$(\mathcal{E}, T)\text{-Multicat} \xrightarrow{U} \mathcal{E}' = (\mathcal{E}, T)\text{-Graph}$$

has a left adjoint, the adjunction is monadic, and if T' is the resulting monad on \mathcal{E}' then (\mathcal{E}', T') is suitable.

Sketch proof We proceed in four steps:

- i. construct a functor $F : \mathcal{E}' \longrightarrow (\mathcal{E}, T)\text{-Multicat}$
- ii. construct an adjunction between F and U
- iii. check that (\mathcal{E}', T') is suitable
- iv. check that the adjunction is monadic.

Each step goes roughly as follows:

i. *Construct a functor $F : \mathcal{E}' \longrightarrow (\mathcal{E}, T)\text{-Multicat}$*

Let X be a T -graph. Define for each n a graph $TX_0 \xleftarrow{d_n} A_n \xrightarrow{c_n} X_0$, by

- $A_0 = X_0$, $d_0 = \eta_{X_0}$ and $c_0 = 1$
- $A_{n+1} = X_0 + X_1 \circ A_n$, where $X_1 \circ A_n$ is the 1-cell composite in $(\mathcal{E}, T)\text{-Span}$, with the obvious choices of d_{n+1} and c_{n+1} .

Define for each n a map $A_n \xrightarrow{i_n} A_{n+1}$, by

- $i_0 : X_0 \longrightarrow X_0 + X_1 \circ X_0$ is first coprojection
- $i_{n+1} = 1_{X_0} + (1_{X_1} * i_n)$.

Then the i_n 's are monic, and by taking A to be the colimit of

$$A_0 \xrightarrow{i_0} A_1 \xrightarrow{i_1} \dots$$

we obtain a graph $TX_0 \longleftarrow A \longrightarrow X_0$. This graph naturally has the structure of a multicategory: the identities map $X_0 \longrightarrow A$ is just the colimit coprojection $A_0 \xrightarrow{i_0} A$, and composition comes from maps $A_m \circ A_n \longrightarrow A_{m+n}$ which piece together to give a map $A \circ A \longrightarrow A$. The latter construction needs many of the axioms for suitability.

We have now described what effect F is to have on objects, and extension to morphisms is straightforward.

(Incidentally, the colimit of the nested sequence of A_n 's appears, in light disguise, as the recursive description of the free plain multicategory monad **fm** in 3.1: A_n is the set of formal expressions which can be obtained from the first clause and up to n applications of the second clause.)

ii. *Construct an adjunction between F and U*

We do this by constructing unit and counit transformations and verifying the triangle identities. Both transformations are the identity on the object of objects, so we only need to define them on the object of arrows. For the unit η' , if $X \in \mathcal{E}'$ then $\eta'_X : X_1 \longrightarrow A$ is the composite

$$X_1 \xrightarrow{\sim} X_1 \circ X_0 \xrightarrow{\text{copr}_2} X_0 + X_1 \circ X_0 = A_1 \xrightarrow{i_1} A.$$

For the counit ε' , let $C \in (\mathcal{E}, T)\text{-Multicat}$. Write A and A_n for the objects used in the construction of the free multicategory on $U(C)$, as if $X = U(C)$ in part (i). Define for each n a map $\varepsilon'_{C,n} : A_n \longrightarrow C_1$ by

- $\varepsilon'_{C,0} = (A_0 \xrightarrow{=} C_0 \xrightarrow{ids} C_1)$
- $\varepsilon'_{C,n+1} = (C_0 + C_1 \circ A_n \xrightarrow{1+1*\varepsilon'_{C,n}} C_0 + C_1 \circ C_1 \xrightarrow{\begin{pmatrix} ids \\ comp \end{pmatrix}} C_1),$

and there is a unique $\varepsilon'_C : A \longrightarrow C_1$ such that $\varepsilon'_{C,n} = (A_n \twoheadrightarrow A \xrightarrow{\varepsilon'_C} C_1)$ for all n .

iii. *Check that (\mathcal{E}', T') is suitable*
This is quite routine.

iv. *Check that the adjunction is monadic*

We apply the Monadicity Theorem by checking that U creates coequalizers for U -absolute coequalizer pairs. This can be done quite separately from the rest of the proof, and again is quite routine. \square

Theorem 1.2.2, the fixed-object version of the theorem, is proved in much the same way. Indeed, if one has already proved 1.2.1 then much of 1.2.2 is an easy consequence. The most substantial difference between the two cases is that the inclusion functor $\mathcal{E}'_S \longrightarrow \mathcal{E}'$ does not preserve coproducts (although it does preserve pullbacks and colimits of nested sequences).

Finally, we need to see that (\mathbf{Set}, id) is suitable. The only part of this which is not quite standard is **C3**, and this is an easy calculation. (The fact that pullbacks commute with colimits of nested sequences is also a special case of the fact that finite limits commute with filtered colimits in **Set**.) More generally, axioms **C** hold for any presheaf category (since they hold for **Set**), and axioms **M** for any finitary cartesian monad.

Bibliography

- **Preprint numbers such as `math.CT/12345` or `q-alg/67890` refer to the xxx preprint server, which can be found at <http://xxx.lanl.gov> (or one of its mirror sites, such as <http://xxx.soton.ac.uk>). For direct access to a paper, go to <http://xxx.lanl.gov/abs/math.CT/12345> etc.**
- [BaDo1] J. Baez, J. Dolan, Higher-dimensional algebra III: n -categories and the algebra of opetopes (1998). *Adv. Math.* 135, pp. 145–206. Also available via <http://math.ucr.edu/home/baez>.
- [BaDo2] J. Baez, J. Dolan, Categorification (1998). Preprint [math.QA/9802029](http://arxiv.org/abs/math.QA/9802029).
- [BeDr] Alexander Beilinson, Vladimir Drinfeld, Chiral algebras. Preprint.
- [Bén] Jean Bénabou, Introduction to bicategories (1967). In: *Reports of the Midwest Category Seminar*, ed. Bénabou et al, Springer LNM 47.
- [BCSW] Renato Betti, Aurelio Carboni, Ross Street, Robert Walters, Variation through enrichment (1983). *Journal of Pure and Applied Algebra* 29, pp. 109–127.
- [Bor] R. Borchers, Vertex algebras (1997). Preprint [q-alg/9706008](http://arxiv.org/abs/q-alg/9706008).
- [Bur] A. Burroni, T -catégories (1971). *Cahiers Top. Geom. Diff.*, Vol. XII, No. 3, pp. 215–321. In French.
- [CKW] Aurelio Carboni, Stefano Kasangian, Robert Walters, An axiomatics for bicategories of modules (1987). *Journal of Pure and Applied Algebra* 45, pp. 127–141.
- [Her] C. Hermida, Higher-dimensional multicategories (1997). Lecture slides, available via <http://www.math.mcgill.ca/~hermida>.
- [HMP] C. Hermida, M. Makkai, J. Power, On weak higher dimensional categories (1997). Available via <http://triples.math.mcgill.ca>.

- [KS] G. M. Kelly, R. Street, Review of the elements of 2-categories (1974). In: *Category Seminar*, Springer LNM 420, pp. 75–103.
- [KM1] M. Kontsevich, Yu. Manin, Gromov-Witten classes, quantum cohomology and enumerative geometry (1994). *Commun. Math. Phys.*, 164:3, pp. 525–562. Preprint `hep-th/9402147`.
- [KM2] M. Kontsevich, Yu. Manin, Quantum cohomology of a product (1995). Preprint `q-alg/9502009`.
- [Kos] Jürgen Koslowski, Monads and interpolads in bicategories (1997). *Theory and Applications of Categories*, Vol. 3, No. 8, pp. 182–212.
- [Lei1] Tom Leinster, General operads and multicategories (1997). Preprint `math.CT/9810053`.
- [Lei2] Tom Leinster, Structures in higher-dimensional category theory (1998). Available via <http://www.dpmms.cam.ac.uk/~leinster>.
- [Sim] Carlos Simpson, On the Breen-Baez-Dolan stabilization hypothesis for Tamsamani’s weak n -categories (1998). Preprint `math.CT/9810058`.
- [Sny] Craig T. Snyder, Equivalence of Borchers G -vertex algebras and axiomatic vertex algebras (1999). To appear.
- [Soi] Y. Soibelman, Meromorphic tensor categories (1997). Preprint `q-alg/9709030`.
- [St] Ross Street, The formal theory of monads (1972). *Journal of Pure and Applied Algebra* 2, pp. 149–168.
- [Wal] R. F. C. Walters, Sheaves and Cauchy-complete categories (1981). *Cahiers Top. Geom. Diff.*, Vol. XXII, No. 3.