

# Braided homology of quantum groups

Tom Hadfield<sup>1</sup>, Ulrich Krähmer<sup>2</sup>

July 2, 2018

<sup>1</sup> Thomas.Daniel.Hadfield@gmail.com

Supported by EU Transfer of Knowledge contract MKTD-CT-2004-509794  
and by an EPSRC Postdoctoral Fellowship

<sup>2</sup> University of Glasgow, Department of Mathematics

University Gardens, G12 8QW Glasgow, UK, ukraehmer@maths.gla.ac.uk  
Supported by an EU Marie Curie and an EPSRC Postdoctoral Fellowship.

MSC (2000): 58B32, 16W30, 19D55

Keywords: Hochschild homology, cyclic homology, braided homology, quantum groups

## Abstract

We study braided Hochschild and cyclic homology of ribbon algebras in braided monoidal categories, as introduced by Baez and by Akrami and Majid. We compute this invariant for several examples coming from quantum groups and braided groups.

## 1 Introduction

Braided Hochschild homology  $HH_*^\Psi(A)$  was first defined by Baez [2] for an algebra  $A$  in a braided monoidal category  $\mathcal{C}$ . Baez defined  $HH_*^\Psi(A)$  by an explicit chain complex, and showed that  $HH_*^\Psi(A) = \text{Tor}_*^{A \hat{\otimes} A^{\text{op}}}(A, A)$ , where  $A \hat{\otimes} A^{\text{op}}$  is the braided enveloping algebra of  $A$ . However, his constructions relied on the assumption that  $A$  is weakly  $\Psi$ -commutative, meaning that  $\mu \circ \Psi^2 = \mu$ , where  $\mu$  is the multiplication morphism of  $A$ . This was overcome by Akrami and Majid [1], who replaced weakly  $\Psi$ -commutative algebras by ribbon algebras, namely algebras  $A$  in  $\mathcal{C}$  possessing an invertible morphism  $\sigma \in \text{Mor}_{\mathcal{C}}(A, A)$  that satisfies  $\sigma \circ \mu = \mu \circ (\sigma \otimes \sigma) \circ \Psi^2$ . They showed that there is a corresponding cyclic theory (in the sense of Connes [7]), which they called braided cyclic homology  $HC_*^{\Psi, \sigma}(A)$ . If  $\mathcal{C}$  is the category of  $\mathbb{C}$ -vector spaces with braiding given by the flip  $v \otimes w \mapsto w \otimes v$ , then an algebra in  $\mathcal{C}$  is simply an associative  $\mathbb{C}$ -algebra, ribbon automorphisms are precisely algebra automorphisms, and the Akrami-Majid cyclic object reduces to the cyclic object defining twisted cyclic homology as studied by Kustermans, Murphy and Tuset [22].

In this paper we first show that the ribbon automorphism  $\sigma$  is also the missing ingredient required to make Baez's realisation of braided Hochschild homology as a derived functor work in full generality. We prove a braided analogue of a result of Feng and Tsygan [12], namely for Hopf algebras, Hochschild homology can be realised as a derived functor in the category of modules over the algebra itself. We apply this machinery to concrete examples of algebras and Hopf algebras in braided monoidal categories: the braided line, braided plane and braided quantum  $SL(2)$ .

From the viewpoint of braided monoidal categories, braided Hochschild and cyclic homology are the natural abstractions of the original definitions of Hochschild and of Connes, and therefore natural objects to study. The computations carried out in this paper also show that braided Hochschild homology is (similarly to twisted Hochschild homology [4, 14, 15, 16, 22, 27]) often

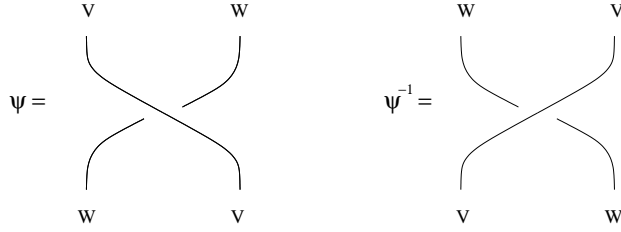

Figure 1: The braiding  $\Psi : V \otimes W \rightarrow W \otimes V$  and its inverse.

less degenerate than classical Hochschild homology, for example in the sense that it overcomes the so-called dimension drop observed for quantisations of Poisson varieties [12]. To show whether the standard applications of cyclic homology in noncommutative geometry admit generalisations to the braided setting seems a promising direction for future research. Another interesting question is the relevance of these invariants for the study of conformal field theories that can be described in terms of ribbon algebras, see e.g. [26].

A summary of this paper is as follows. Throughout we work over  $\mathbb{C}$  as ground field. In Section 2 we recall the definitions of a ribbon algebra and a Hopf algebra in a braided monoidal category  $\mathcal{C}$ , with particular reference to the motivating example  $\mathcal{C} = \mathcal{C}(H)$ , the category of comodules of a coquasitriangular Hopf algebra  $H$ . In Section 3 we define braided Hochschild homology  $H_*^{\Psi, \sigma}(A, M)$  for a ribbon algebra  $(A, \sigma)$  and an  $A$ -bimodule  $M$  in  $\mathcal{C}$  as the homology of a specific complex. We show that for  $\mathcal{C} = \mathcal{C}(H)$  this can be realised as a derived functor over an appropriate braided enveloping algebra  $A^e$  (Theorem 3.7), thus generalising Baez's result to the case  $\sigma \neq \text{id}$ . We discuss the precise relation to the Akrami-Majid cyclic object associated to  $(A, \sigma)$ .

In Section 4 we prove a braided analogue of a result of Feng and Tsygan [12], namely that for a Hopf algebra  $A$  in  $\mathcal{C}(H)$  there is an isomorphism of vector spaces  $H_n^{\Psi, \sigma}(A, M) \simeq \text{Tor}_n^A(R(M), \mathbb{C})$ , for a suitable right  $A$ -module  $R(M)$  associated to any  $A$ -bimodule  $M$  (Theorem 4.2). In Section 5 we apply this machinery to the braided line and braided plane.

In the final Section we consider braided Hopf algebras associated to coquasitriangular Hopf algebras via the process known as transmutation. For quantum  $SL(2)$ , we obtain a no dimension drop type result (along the lines of [4, 15, 16]) for the associated braided Hopf algebra  $B$ , namely that  $H_n^{\Psi, \sigma}(B, B) = 0$  for  $n > 3$ , and  $H_3^{\Psi, \sigma}(B, B) \cong \mathbb{C}$ .

## 2 Braided monoidal categories

### 2.1 Ribbon algebras and Hopf algebras in braided monoidal categories

Recall [24] that a monoidal category is a category  $\mathcal{C}$  together with a functor  $\otimes : \mathcal{C} \times \mathcal{C} \rightarrow \mathcal{C}$ , an object  $\mathbf{1} \in \text{Ob}(\mathcal{C})$  and isomorphisms of functors  $\Phi : (\cdot \otimes \cdot) \otimes \cdot \cong \cdot \otimes (\cdot \otimes \cdot)$  (the associator),  $\ell : \cdot \otimes \mathbf{1} \rightarrow \text{id}$  and  $r : \mathbf{1} \otimes \cdot \rightarrow \text{id}$ , assumed to satisfy certain consistency relations, which abstract the properties of the tensor product, say of vector spaces, over a field. A monoidal category is Ab-monoidal if for any  $V, W \in \text{Ob}(\mathcal{C})$ , the set  $\text{Hom}(V, W)$  is an additive abelian group such that composition and tensor product of morphisms are bilinear.

Given a monoidal category  $\mathcal{C}$ , we define a new functor  $\otimes^{\text{op}} : \mathcal{C} \times \mathcal{C} \rightarrow \mathcal{C}$  by  $\otimes^{\text{op}}(V, W) = W \otimes V$ . A braided monoidal category is a monoidal category  $\mathcal{C}$  equipped with a braiding, an isomorphism of functors  $\Psi : \otimes \rightarrow \otimes^{\text{op}}$ , obeying the so-called hexagon relation. As in [1, 2], we shall use standard graphical notation to depict morphisms in  $\mathcal{C}$ . For example the braiding  $\Psi : V \otimes W \rightarrow W \otimes V$  and its inverse are shown in Figure 1. Note that  $\mathcal{C}$  equipped with  $\Psi^{-1}$  is also a braided monoidal category. The choice of  $\Psi$  rather than  $\Psi^{-1}$  is simply a matter of convention.

An algebra (or monoid) in  $\mathcal{C}$  is an object  $A$  of  $\mathcal{C}$  with morphisms  $\mu : A \otimes A \rightarrow A$  (multiplication)

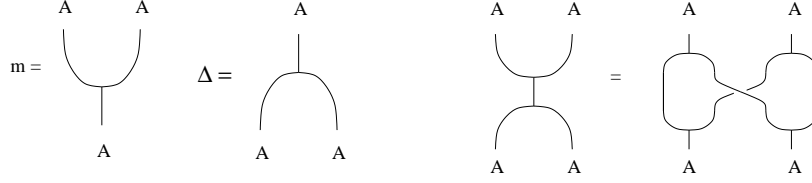

Figure 2: Multiplication, comultiplication and the bialgebra condition

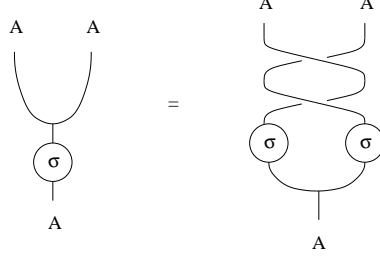

Figure 3: The ribbon property  $\sigma \circ \mu = \mu \circ (\sigma \otimes \sigma) \circ \Psi^2$ .

and  $\eta : \mathbf{1} \rightarrow A$ , such that  $\mu \circ (\mu \otimes \text{id}) = \mu \circ (\text{id} \otimes \mu)$  and  $\mu \circ (\eta \otimes \text{id}) = \text{id} = \mu \circ (\text{id} \otimes \eta)$ . Here and in the sequel we suppress  $\Phi, \ell, r$ . Dually, a coalgebra (or comonoid) in  $\mathcal{C}$  is an object  $A$  of  $\mathcal{C}$  with morphisms  $\Delta : A \rightarrow A \otimes A$  (comultiplication) and  $\varepsilon : A \rightarrow \mathbf{1}$  (counit) satisfying  $(\Delta \otimes \text{id}) \circ \Delta = (\text{id} \otimes \Delta) \circ \Delta$  and  $(\varepsilon \otimes \text{id}) \circ \Delta = \text{id} = (\text{id} \otimes \varepsilon) \circ \Delta$ . Given an algebra  $A$  in  $\mathcal{C}$ , we define the opposite algebra  $A^{\text{op}}$  to be the object  $A$  equipped with multiplication  $\mu^{\text{op}} = \mu \circ \Psi$ . Similarly we define the coopposite coalgebra  $A^{\text{cop}}$ .

Given algebras  $A$  and  $B$  in  $\mathcal{C}$ , the braided tensor product algebra  $A \hat{\otimes} B$  is defined to be the object  $A \otimes B$  with multiplication

$$\mu_{A \hat{\otimes} B} = (\mu_A \otimes \mu_B) \circ (\text{id} \otimes \Psi \otimes \text{id}) : (A \otimes B) \otimes (A \otimes B) \rightarrow A \otimes B$$

A bialgebra  $A$  in  $\mathcal{C}$  is an algebra and coalgebra for which  $\Delta : A \rightarrow A \hat{\otimes} A$  and  $\varepsilon : A \rightarrow \mathbf{1}$  are algebra morphisms (Figure 2), i.e.  $\Delta \circ \mu = (\mu \otimes \mu) \circ (\text{id} \otimes \Psi \otimes \text{id}) \circ (\Delta \otimes \Delta)$ , and  $\varepsilon \circ \mu = \varepsilon \otimes \varepsilon$ . Further, a Hopf algebra (or braided group) in  $\mathcal{C}$  is a bialgebra  $A$  together with a morphism  $S : A \rightarrow A$  (antipode), satisfying  $\mu \circ (S \otimes \text{id}) \circ \Delta = \eta \circ \varepsilon = \mu \circ (\text{id} \otimes S) \circ \Delta$ . It follows that  $S$  is a braided antihomomorphism, i.e.  $S \circ \mu = \mu \circ \Psi \circ (S \otimes S)$ .

Finally we need the notion of a ribbon algebra in a braided monoidal category, which is the basic data needed for Akrami and Majid's construction of braided cyclic (co)homology.

**Definition 2.1** (Figure 3) *A ribbon algebra in  $\mathcal{C}$  is an algebra  $(A, \mu, \eta)$  together with an invertible morphism  $\sigma : A \rightarrow A$  (the ribbon automorphism) such that*

$$\mu \circ (\sigma \otimes \sigma) \circ \Psi^2 = \sigma \circ \mu : A \otimes A \rightarrow A, \quad \sigma \circ \eta = \eta \tag{1}$$

and  $(\sigma \otimes \text{id}) \circ \Psi = \Psi \circ (\text{id} \otimes \sigma)$ ,  $(\text{id} \otimes \sigma) \circ \Psi = \Psi \circ (\sigma \otimes \text{id})$  on  $M \otimes A$ ,  $A \otimes M$  respectively, for all  $M \in \text{Ob}(\mathcal{C})$ .

Note that if  $(A, \sigma)$  is a ribbon algebra in  $(\mathcal{C}, \Psi)$ , then  $(A, \sigma^{-1})$  is a ribbon algebra in  $(\mathcal{C}, \Psi^{-1})$ .

**Example 2.2** *If we take  $\mathcal{C} = \mathbb{C}\text{-Vec}$  to be the category of complex vector spaces, then an algebra  $A$  in  $\mathcal{C}$  is simply an ordinary algebra over  $\mathbb{C}$ . If we take the braiding  $\Psi$  to be the flip  $v \otimes w \mapsto w \otimes v$ , then (1) becomes  $\sigma(ab) = \sigma(a)\sigma(b)$ , i.e.  $\sigma$  is an ordinary algebra automorphism of  $A$ .*

## 2.2 Coquasitriangular Hopf algebras and braided monoidal categories

We now recall the concepts of coquasitriangular and of coribbon Hopf algebras. We refer to [19, 20, 24] for more definitions and proofs. The most important example for us is  $H = \mathbb{C}_q[G]$  (defined in Example 2.8), the standard quantised coordinate ring of a complex simple Lie group  $G$ , for  $q \in \mathbb{C} \setminus \{0\}$  not a root of unity.

**Definition 2.3** *Let  $H$  be a bialgebra in  $\mathcal{C} = \mathbb{C}\text{-Vec}$ . Then  $H$  is called coquasitriangular (cobraided) if there exist bilinear forms  $\mathbf{r}, \bar{\mathbf{r}}$  on  $H$  such that for all  $f, g, h \in H$*

$$\begin{aligned} \mathbf{r}(f_{(1)}, g_{(1)})\bar{\mathbf{r}}(f_{(2)}, g_{(2)}) &= \bar{\mathbf{r}}(f_{(1)}, g_{(1)})\mathbf{r}(f_{(2)}, g_{(2)}) = \varepsilon(f)\varepsilon(g), \\ gf &= \mathbf{r}(f_{(1)}, g_{(1)})f_{(2)}g_{(2)}\bar{\mathbf{r}}(f_{(3)}, g_{(3)}), \\ \mathbf{r}(fg, h) &= \mathbf{r}(f, h_{(1)})\mathbf{r}(g, h_{(2)}), \quad \mathbf{r}(f, gh) = \mathbf{r}(f_{(1)}, h)\mathbf{r}(f_{(2)}, g). \end{aligned}$$

We call  $\mathbf{r}$  a universal  $r$ -form on  $H$ .

Here we use Sweedler's notation  $\Delta(f) = f_{(1)} \otimes f_{(2)}$  (summation suppressed) for the coproduct. As a consequence  $\mathbf{r}$  satisfies  $\mathbf{r}(1, f) = \mathbf{r}(f, 1) = \varepsilon(f)$ , and the quantum Yang-Baxter equation  $\mathbf{r}_{12}\mathbf{r}_{13}\mathbf{r}_{23} = \mathbf{r}_{23}\mathbf{r}_{13}\mathbf{r}_{12}$ . Here, and in the sequel, we use the convolution product of multilinear maps from a coalgebra to an algebra, and lower indices refer to the components in tensor products where these are applied. Thus explicitly the quantum Yang-Baxter relation reads

$$\mathbf{r}(f_{(1)}, g_{(1)})\mathbf{r}(f_{(2)}, h_{(1)})\mathbf{r}(g_{(2)}, h_{(2)}) = \mathbf{r}(g_{(1)}, h_{(1)})\mathbf{r}(f_{(1)}, h_{(2)})\mathbf{r}(f_{(2)}, g_{(2)}) \quad \forall f, g, h \in H$$

The bilinear form  $\bar{\mathbf{r}}_{21}(f, g) = \bar{\mathbf{r}}(g, f)$  is also a universal  $r$ -form. If  $H$  is a Hopf algebra with antipode  $S$ , then  $\bar{\mathbf{r}}(f, g) = \mathbf{r}(S(f), g)$ ,  $\mathbf{r}(f, g) = \mathbf{r}(S(f), S(g))$ .

Note that coquasitriangularity is the notion dual to the more commonly used concept of quasitriangularity, which refers to the existence of an element  $R \in H \otimes H$  (the ‘‘universal R-matrix’’) with certain properties. While in our case the multiplication and opposite multiplication are linked via  $\mathbf{r}$ , a universal R-matrix links the coproduct and the coopposite one. The disadvantage of quasitriangularity is that it often can only be applied rigorously when working either with finite-dimensional Hopf algebras or with topological ones and suitable completions of tensor products. Working with the dual notion of coquasitriangularity offers a way out in many examples. An alternative elegant and purely algebraic option is to pass to multiplier Hopf algebras, see for example the recent work [25] by Neshveyev and Tuset and the references therein.

For a bialgebra  $H$ , let  $\mathcal{C}(H)$  denote the category of right  $H$ -comodules, and  $\mathcal{C}_f(H)$  the category of finite-dimensional right  $H$ -comodules. The algebra structure of  $H$  corresponds to a monoidal structure on  $\mathcal{C}(H)$ ,  $\mathcal{C}_f(H)$  with tensor product that of underlying  $\mathbb{C}$ -vector spaces, and coaction

$$V \otimes W \rightarrow V \otimes W \otimes H, \quad v \otimes w \mapsto v_{(0)} \otimes w_{(0)} \otimes v_{(1)}w_{(1)}$$

The unit object is  $\mathbb{C}$  with trivial coaction  $\mathbb{C} \ni 1 \mapsto 1 \otimes 1 \in \mathbb{C} \otimes H$ . A coquasitriangular structure on  $H$  turns  $\mathcal{C}(H)$ ,  $\mathcal{C}_f(H)$  into braided monoidal categories with braiding

$$\Psi : V \otimes W \rightarrow W \otimes V, \quad v \otimes w \mapsto w_{(0)} \otimes v_{(0)} \mathbf{r}(v_{(1)}, w_{(1)}) \quad (2)$$

Then  $\Psi^2(v \otimes w) = v_{(0)} \otimes w_{(0)} \mathbf{q}(v_{(1)}, w_{(1)})$ , where  $\mathbf{q} = \mathbf{r}_{21}\mathbf{r}$ . Replacing  $\mathbf{r}$  by  $\bar{\mathbf{r}}_{21}$  corresponds to replacing  $\Psi$  by  $\Psi^{-1}$ .

**Definition 2.4** *A coquasitriangular Hopf algebra  $(H, \mathbf{r})$  is called coribbon if there exists an invertible central element  $\mathbf{s} \in H^\circ$  (the dual Hopf algebra) satisfying*

$$\mathbf{s}(fg) = \mathbf{s}(f_{(1)})\mathbf{s}(g_{(1)})\mathbf{q}(f_{(2)}, g_{(2)}), \quad \mathbf{s}(1) = 1, \quad \mathbf{s}(S(f)) = \mathbf{s}(f) \quad \forall f, g \in H$$

Note that  $\mathbf{r}(a, \cdot), \mathbf{r}(\cdot, a) \in H^\circ$ . Thus  $\mathbf{sq}(a, \cdot) = \mathbf{q}(a, \cdot)\mathbf{s}$ , and  $\mathbf{sq}(\cdot, a) = \mathbf{q}(\cdot, a)\mathbf{s}$ , for all  $a \in H$ . For coribbon Hopf algebras,  $\mathcal{C}_f(H)$  becomes a ribbon category [19] with ribbon structure

$$\sigma : V \rightarrow V, \quad v \mapsto v_{(0)} \mathbf{s}(v_{(1)}), \quad v \in \mathcal{C}_f(H)$$

Since  $\mathbf{s}$  is cocentral, this is a morphism in  $\mathcal{C}_f(H)$ . It is also well-defined for objects of  $\mathcal{C}(H)$ , and turns algebras in  $\mathcal{C}(H)$  into ribbon algebras in the sense of Definition 2.1. However  $\mathcal{C}(H)$  is in general not a ribbon category, due to the lack of duals. For a full discussion see [1].

**Example 2.5** *The trivial Hopf algebra  $H = \mathbb{C}$  is coquasitriangular, via  $\mathbf{r}(1, 1) = 1$ , and coribbon via  $\mathbf{s}(1) = 1$ . Hence  $\mathcal{C}(H)$  is the braided monoidal category of Example 2.2, however the only ribbon automorphism arising from  $\mathbf{s}$  is  $\sigma = \text{id}$ .*

**Example 2.6** *Any coribbon Hopf algebra  $(H, \mathbf{r})$  becomes a ribbon algebra in  $\mathcal{C}(H)$  with coaction  $\Delta$ . Then (1) is a direct translation of the defining property of  $\sigma$ . We call the resulting braiding*

$$\Psi(f \otimes g) = g_{(1)} \otimes f_{(1)} \mathbf{r}(f_{(2)}, g_{(2)}) \quad (3)$$

the canonical braiding on  $(H, \mathbf{r})$ .

**Example 2.7** *Any Hopf algebra  $H$  is a right  $H^{\text{cop}} \otimes H$ -comodule algebra, via the coaction  $f \mapsto f_{(2)} \otimes f_{(1)} \otimes f_{(3)}$ . If  $H$  is coquasitriangular, then  $H^{\text{cop}} \otimes H$  is also coquasitriangular, with universal  $r$ -form  $(f \otimes g, h \otimes k) \mapsto \bar{\mathbf{r}}(f, h) \mathbf{r}(g, k)$ . The resulting braiding on  $H$  is*

$$\Psi(f \otimes g) = \bar{\mathbf{r}}(f_{(1)}, g_{(1)}) g_{(2)} \otimes f_{(2)} \mathbf{r}(f_{(3)}, g_{(3)}) \quad (4)$$

By the definition of coquasitriangularity, we have  $\mu \circ \Psi = \mu$ . So  $H$  is  $\Psi$ -commutative, in the terminology of [2]. In particular  $\sigma = \text{id}$  is a ribbon automorphism.

**Example 2.8** *Let  $G$  be a complex simple Lie group, with Lie algebra  $\mathfrak{g}$ . Let  $q \in \mathbb{C} \setminus \{0\}$  be not a root of unity, and  $H = \mathbb{C}_q[G]$  and  $U_q(\mathfrak{g})$  be the standard quantised coordinate ring and enveloping algebra of  $G$  and  $\mathfrak{g}$  respectively. Then  $\mathcal{C}_{(f)}(H)$  consists of (finite) direct sums of the so-called type I representations of  $U_q(\mathfrak{g})$  that are obtained by deformation of finite-dimensional representations of  $G$ . Both are braided monoidal categories. The corresponding universal  $r$ -form on  $\mathbb{C}_q[G]$  can be given explicitly in terms of the so-called Rosso form, see e.g. [18]. For the classical matrix Lie groups  $G$  the ribbon functionals on  $\mathbb{C}_q[G]$  were classified by Hayashi [17].*

**Example 2.9** *Specialising Example 2.8, the coordinate algebra  $H = \mathbb{C}_q[SL(2)]$  of quantum  $SL(2)$  can be presented in terms of generators  $a, b, c, d$  with relations*

$$ab = qba, \quad ac = qca, \quad bd = qdb, \quad cd = qdc, \quad bc = cb, \quad ad - qbc = 1, \quad da - q^{-1}bc = 1 \quad (5)$$

The Hopf algebra structure on  $H$  is given by

$$\begin{aligned} \Delta \begin{bmatrix} a & b \\ c & d \end{bmatrix} &= \begin{bmatrix} a & b \\ c & d \end{bmatrix} \otimes \begin{bmatrix} a & b \\ c & d \end{bmatrix} \\ S \begin{bmatrix} a & b \\ c & d \end{bmatrix} &= \begin{bmatrix} d & -q^{-1}b \\ -qc & a \end{bmatrix}, \quad \varepsilon \begin{bmatrix} a & b \\ c & d \end{bmatrix} = \begin{bmatrix} 1 & 0 \\ 0 & 1 \end{bmatrix} \end{aligned} \quad (6)$$

There are two useful vector space bases of  $H$ : One is of Poincaré-Birkhoff-Witt type and is given by the monomials  $\{e_{i,j,k} := a^i b^j c^k, \quad i \in \mathbb{Z}, \quad j, k \in \mathbb{N}\}$ , where  $a^i := d^{-i}$  for  $i < 0$ , and by convention  $x^0 = 1$ , for  $x \in H, x \neq 0$ . The second relies on the fact that  $H$  is isomorphic as coalgebra to  $\mathbb{C}[SL(2)]$  and hence cosemisimple (any comodule is the direct sum of its irreducible subcomodules). Therefore, it admits a Peter-Weyl type basis consisting of the matrix

coefficients  $C_{rs}^{(m)}$ ,  $m \in \mathbb{N}$ ,  $r, s = 0, \dots, m$ , of the irreducible corepresentations of  $H$ . In particular,  $\begin{bmatrix} C_{00}^{(1)} & C_{01}^{(1)} \\ C_{10}^{(1)} & C_{11}^{(1)} \end{bmatrix} = \begin{bmatrix} a & b \\ c & d \end{bmatrix}$ . The universal  $r$ -form  $\mathbf{r}$  of Example 2.8 is given on generators by

$$\begin{bmatrix} \mathbf{r}(a, a) & \mathbf{r}(a, b) & \mathbf{r}(a, c) & \mathbf{r}(a, d) \\ \mathbf{r}(b, a) & \mathbf{r}(b, b) & \mathbf{r}(b, c) & \mathbf{r}(b, d) \\ \mathbf{r}(c, a) & \mathbf{r}(c, b) & \mathbf{r}(c, c) & \mathbf{r}(c, d) \\ \mathbf{r}(d, a) & \mathbf{r}(d, b) & \mathbf{r}(d, c) & \mathbf{r}(d, d) \end{bmatrix} = q^{-1/2} \begin{bmatrix} q & 0 & 0 & 1 \\ 0 & 0 & 0 & 0 \\ 0 & q - q^{-1} & 0 & 0 \\ 1 & 0 & 0 & q \end{bmatrix} \quad (7)$$

We refer to [20] for more details and proofs.

### 2.3 Gauge transformations and cochain twists

There is a natural notion of equivalence of braided monoidal categories, provided by functors implementing an equivalence of categories that transforms the braided monoidal structures into each other. We recall this explicitly for the case  $\mathcal{C} = \mathcal{C}(H)$ , for  $H$  a coquasitriangular Hopf algebra. We refer to [1, 3, 19] for the precise definition in abstract braided monoidal categories.

Let  $H$  be a Hopf algebra, and  $\mathbf{f}$  a convolution invertible bilinear form on  $H$ , with inverse  $\bar{\mathbf{f}}$ . The multiplication of  $H$  can be twisted by  $\mathbf{f}$  as follows:

$$a \cdot_{\mathbf{f}} b = \mathbf{f}(a_{(1)}, b_{(1)}) a_{(2)} b_{(2)} \bar{\mathbf{f}}(a_{(3)}, b_{(3)})$$

In general the result is a nonassociative algebra  $H^{\mathbf{f}}$  (a so-called quasi-Hopf algebra) since

$$(a \cdot_{\mathbf{f}} b) \cdot_{\mathbf{f}} c = \partial \mathbf{f}(a_{(1)}, b_{(1)}, c_{(1)}) a_{(2)} \cdot_{\mathbf{f}} (b_{(2)} \cdot_{\mathbf{f}} c_{(2)}) \bar{\partial} \bar{\mathbf{f}}(a_{(3)}, b_{(3)}, c_{(3)}),$$

where  $\partial \mathbf{f}(a, b, c) = \mathbf{f}(a_{(1)}, b_{(1)}) \mathbf{f}(a_{(2)} b_{(2)}, c_{(1)}) \bar{\mathbf{f}}(a_{(3)}, b_{(3)} c_{(2)}) \bar{\mathbf{f}}(b_{(4)}, c_{(3)})$ . If  $\partial \mathbf{f} = \varepsilon \otimes \varepsilon \otimes \varepsilon$ , then  $\mathbf{f}$  is said to be a 2-cocycle [10, 11, 24] and  $H^{\mathbf{f}}$  is associative. We say that  $\mathbf{f}$  is a 2-coboundary if  $\mathbf{f}(x, y) = \varphi(x_{(1)}) \varphi(y_{(1)}) \bar{\varphi}(x_{(2)} y_{(2)})$  for some linear map  $\varphi : H \rightarrow k$ . A 2-coboundary is automatically a 2-cocycle, but not conversely. For  $H^{\mathbf{f}}$  to be associative it is sufficient that  $\partial \mathbf{f}$  is cocentral, meaning

$$\partial \mathbf{f}(a_{(1)}, b_{(1)}, c_{(1)}) (a_{(2)} \otimes b_{(2)} \otimes c_{(2)}) = (a_{(1)} \otimes b_{(1)} \otimes c_{(1)}) \partial \mathbf{f}(a_{(2)}, b_{(2)}, c_{(2)})$$

and not necessarily a 2-cocycle. Since  $H = H^{\mathbf{f}}$  as coalgebras,  $\mathcal{C}(H)$  and  $\mathcal{C}(H^{\mathbf{f}})$  coincide. The two algebra products correspond to different monoidal structures on this category. Both are given by tensor product of vector spaces, but the twist is encoded in the isomorphism of vector spaces

$$F : V \otimes W \rightarrow V \otimes W, \quad v \otimes w \mapsto v_{(0)} \otimes w_{(0)} \bar{\mathbf{f}}(v_{(1)}, w_{(1)})$$

which transforms  $V \otimes W$  as an object of  $\mathcal{C}(H)$  into an object of  $\mathcal{C}(H^{\mathbf{f}})$ . Following [11] we refer to  $F$  as a gauge transformation. This transforms an  $H$ -comodule algebra  $A \in \mathcal{C}(H)$  to an  $H^{\mathbf{f}}$ -comodule algebra  $A^{\mathbf{f}} \in \mathcal{C}(H^{\mathbf{f}})$ .  $A$  and  $A^{\mathbf{f}}$  coincide as vector spaces, but the multiplication in  $A^{\mathbf{f}}$  is given in terms of the multiplication in  $A$  by  $\mu^{\mathbf{f}} = \mu \circ F$ . For this to be associative  $\mathbf{f}$  must be a 2-cocycle. Further, the  $r$ -form  $\mathbf{r}$  on  $H$  transforms to  $\mathbf{f}_{21} \mathbf{r} \bar{\mathbf{f}}$ , which is an  $r$ -form on  $H^{\mathbf{f}}$  provided  $\mathbf{f}$  is a 2-cocycle. For general  $\mathbf{f}$  the formulae have to be modified by incorporating  $\partial \mathbf{f}$ , the Drinfeld associator. Twisting Hopf algebras and comodule algebras by coboundaries yields isomorphic structures:

**Lemma 2.10** *If  $\mathbf{f} = \partial \varphi$ , then  $H \cong H^{\mathbf{f}}$  as Hopf algebras, and  $A \cong A^{\mathbf{f}}$  as  $H$ -comodule algebras.*

*Proof.* The isomorphisms are given by  $h \mapsto \bar{\varphi}(h_{(1)}) h_{(2)} \varphi(h_{(3)})$ ,  $a \mapsto a_{(0)} \varphi(a_{(1)})$  □

Finally we note that ribbon functionals and automorphisms are preserved under gauge transformations.

**Example 2.11** Let  $(H, \mathbf{r})$  be a coquasitriangular Hopf algebra, and  $\mathbf{q} = \mathbf{r}_{21}\mathbf{r}$  as in Section 2.2. Then an invertible central element  $\mathbf{s} \in H^\circ$  is a ribbon functional if and only if  $\mathbf{q} = \partial\bar{\mathbf{s}}$ . In particular  $\mathbf{q}$  is then a 2-cocycle.

Taking this into account, we get:

**Proposition 2.12** Let  $(H, \mathbf{r})$  be a coquasitriangular Hopf algebra such that  $\mathbf{r} = \partial\varphi$ . Suppose further that  $\varphi^2$  is cocentral (i.e. in the centre of the dual Hopf algebra). Then  $\bar{\varphi}^2$  is a ribbon functional.

*Proof.* Indeed, if  $\mathbf{r} = \partial\varphi$ , then  $\mathbf{q} = \partial\varphi^2$ :

$$\begin{aligned} \mathbf{q}(a, b) &= \mathbf{r}(b_{(1)}, a_{(1)})\mathbf{r}(a_{(2)}, b_{(2)}) = \varphi(b_{(1)})\varphi(a_{(1)})\bar{\varphi}(b_{(2)}a_{(2)})\mathbf{r}(a_{(3)}, b_{(3)}) \\ &= \varphi(b_{(1)})\varphi(a_{(1)})\mathbf{r}(a_{(2)}, b_{(2)})\bar{\varphi}(a_{(3)}b_{(3)})\bar{\mathbf{r}}(a_{(4)}, b_{(4)})\mathbf{r}(a_{(5)}, b_{(5)}) \\ &= \varphi(a_{(1)})\varphi(a_{(2)})\varphi(b_{(1)})\varphi(b_{(2)})\bar{\varphi}(a_{(3)}b_{(3)})\bar{\varphi}(a_{(4)}b_{(4)}) = \partial\varphi^2(a, b). \end{aligned}$$

□

**Example 2.13** The universal  $r$ -form of  $\mathbb{C}_q[G]$  is a 2-coboundary. This is essentially shown in [21] Corollary 4.1.7, where the authors work with formal deformation quantisations.

Concretely, one can prove directly that for  $\mathbb{C}_q[SL(2)]$  the (convolution invertible) linear functional  $\varphi$  defined by

$$\varphi(a^{i+1}b^j c^k) = 0 = \varphi(d^{i+1}b^j c^k), \quad \varphi(b^j c^k) = q^{(j+k)(1-j-k)/4} \beta^j \gamma^k, \quad i, j, k \geq 0, \quad \beta\gamma = -q^{-3/2} \quad (8)$$

satisfies  $\mathbf{r} = \partial\varphi$ , for the  $r$ -form  $\mathbf{r}$  defined by (7). For  $\beta = q^{-1/4}, \gamma = -q^{-5/4}$  one obtains  $\varphi$  for which  $\varphi^2$  is cocentral, i.e., is the inverse of the ribbon functional. In terms of the Peter-Weyl basis, this  $\varphi$  is given by

$$\varphi(C_{rs}^{(m)}) = \begin{cases} (-1)^r q^{-r-\frac{1}{4}m^2} & r+s=m \\ 0 & \text{otherwise} \end{cases},$$

see [6] p.262. The inverse of the ribbon functional is thus given by

$$\varphi^2(C_{rs}^{(m)}) = (-1)^m q^{-\frac{1}{2}m^2 - m} \delta_{rs} \quad (9)$$

Note that this is cocentral. The functional  $\varphi$  gives rise to the extension of the quantised universal enveloping algebra dual to  $\mathbb{C}_q[SL(2)]$  known as the quantum Weyl group. Usually, the fact that the coboundary of  $\varphi$  is  $\mathbf{r}$  is considered the other way round, the aim being to use the  $r$ -form to compute the coproduct of  $\varphi$  as in Proposition 8.2.3 in [6]. But as we see here, the inverse point of view is relevant as well.

**Example 2.14** [9] Let  $G$  be a finite group and  $\omega : G \times G \times G \rightarrow U(1)$  be a 3-cocycle (where  $G$  acts trivially on  $U(1)$ ). Define

$$\theta_g(x, y) := \frac{\omega(g, x, y)\omega(x, y, y^{-1}x^{-1}gxy)}{\omega(x, x^{-1}gx, y)}, \quad \gamma_x(g, h) := \frac{\omega(g, h, x)\omega(x, x^{-1}gx, x^{-1}hx)}{\omega(g, x, x^{-1}hx)}, \quad g, h, x, y \in G.$$

Then the tensor product  $A \otimes A^\circ$  of the commutative algebra  $A = \mathbb{C}[G]$  of functions on  $G$  with the group algebra  $A^\circ = \mathbb{C}G$  can be turned into a generalised Drinfeld double with product

$$(\delta_g \otimes x)(\delta_h \otimes y) := \delta_g(xhx^{-1})\delta_g \otimes xy\theta_g(x, y)$$

and coproduct

$$\Delta(\delta_g \otimes x) := \sum_{h, k \in G, hk=g} \delta_h \otimes x \otimes \delta_k \otimes x\gamma_x(h, k),$$

where  $x, y$  are identified with the corresponding basis elements of  $\mathbb{C}G$ , and  $\delta_g : G \rightarrow \mathbb{C}$  is the Dirac function. This gives a quasi Hopf algebra  $D^\omega(G)$  (the product is associative, but  $\Delta$  is only quasi coassociative in general). Let  $H := (D^\omega(G))^\circ$  be the dual. Then,  $H$  depends up to a 2-cochain twist only on the cohomology class  $[\omega] \in H^3(G, U(1))$ , see [9], and it is always coquasitriangular. The comodule category describes certain rational conformal field theories that arose in the work of Dijkgraaf and Witten, and this link to mathematical physics is another main motivation for the current interest in ribbon categories, see e.g. [26].

## 3 Braided Hochschild and cyclic homology

### 3.1 Braided Hochschild homology

Let  $(A, \sigma)$  be a ribbon algebra in a braided monoidal Ab-category  $\mathcal{C}$ , which we assume possesses kernels and cokernels. This is in particular true for  $\mathcal{C} = \mathcal{C}(H)$ , with  $H$  coquasitriangular. There are obvious notions of left and right  $A$ -module and  $A$ -bimodule in  $\mathcal{C}$ . For example, by an  $A$ -bimodule, we mean an object  $M$  of  $\mathcal{C}$ , together with morphisms (left and right actions)  $\triangleright : A \otimes M \rightarrow M$ ,  $\triangleleft : M \otimes A \rightarrow M$  such that  $\triangleright(\mu \otimes \text{id}) = \triangleright(\text{id} \otimes \triangleright)$ ,  $\triangleleft(\text{id} \otimes \mu) = \triangleleft(\triangleleft \otimes \text{id})$ ,  $\triangleright(\text{id} \otimes \triangleleft) = \triangleleft(\triangleright \otimes \text{id})$ , and

$$\begin{aligned}\Psi(\text{id} \otimes \triangleright) &= (\triangleright \otimes \text{id})(\text{id} \otimes \Psi)(\Psi \otimes \text{id}) && \text{on } A \otimes A \otimes M \\ \Psi(\text{id} \otimes \triangleleft) &= (\triangleleft \otimes \text{id})(\text{id} \otimes \Psi)(\Psi \otimes \text{id}) && \text{on } A \otimes M \otimes A\end{aligned}$$

and similarly replacing  $\Psi$  by  $\Psi^{-1}$ . From this point for convenience we drop the notation “ $\circ$ ” for composition of morphisms. Given such  $M$ , define  $C_0 = C_0(A, M) = M$ ,  $C_n = C_n(A, M) = M \otimes A^{\otimes n}$  for  $n \geq 1$ . In a diagram representing a morphism with source  $A^{\otimes m} \otimes M \otimes A^{\otimes n}$ , we number the strands  $0, 1, \dots, m+n$  (with  $M$  appearing as the strand labelled  $m$ , and represented graphically in bold). We write

$$\begin{aligned}\triangleright_{m-1, m} &= \text{id}^{\otimes(m-1)} \otimes \triangleright \otimes \text{id}^{\otimes n} : A^{\otimes m} \otimes M \otimes A^{\otimes n} \rightarrow A^{\otimes(m-1)} \otimes M \otimes A^{\otimes n}, \\ \triangleleft_{m, m+1} &= \text{id}^{\otimes m} \otimes \triangleleft \otimes \text{id}^{\otimes n} : A^{\otimes m} \otimes M \otimes A^{\otimes n} \rightarrow A^{\otimes m} \otimes M \otimes A^{\otimes(n-1)} \\ \mu_{j, j+1} &= \text{id}^{\otimes j} \otimes \mu \otimes \text{id}^{\otimes(m+n-j-1)}, \quad j \neq m-1, m\end{aligned}$$

For each  $n \geq 1$ , define maps  $d_j : C_n \rightarrow C_{n-1}$ ,  $0 \leq j \leq n$  by

$$d_0 = \triangleleft_{0,1}, \quad d_j = \mu_{j, j+1} \quad 1 \leq j \leq n-1, \quad d_n = \triangleright_{0,1}(\sigma \otimes \text{id}^{\otimes n})\Psi_{[0, n-1], n} \quad (10)$$

where we define, for  $m \leq n < p$ ,

$$\begin{aligned}\Psi_{[m, n], n+1} &= \Psi_{m, m+1}\Psi_{m+1, m+2} \cdots \Psi_{n, n+1}, \\ \Psi_{m, [m+1, n+1]} &= \Psi_{n, n+1}\Psi_{n+1, n+2} \cdots \Psi_{m, m+1} \\ \Psi_{[m, n], [n+1, p]} &= \Psi_{[m+p-n-1, p-1], p} \cdots \Psi_{[m+1, n+1], n+2}\Psi_{[m, n], n+1} \\ \Psi_{[m, n], [n+1, p]}^{-1} &= (\Psi_{[m, n], [n+1, p]})^{-1}\end{aligned}$$

The maps  $d_j$  are shown in Figures 4 and 5. Together with maps  $s_i : C_n \rightarrow C_{n+1}$ ,  $0 \leq i \leq n$  defined by  $s_i = \text{id}^{\otimes(i+1)} \otimes \eta \otimes \text{id}^{\otimes(n-i)}$ , this gives a simplicial object  $\{C_*(A, M)\}$ . Thus  $b_n : C_n \rightarrow C_{n-1}$  defined by  $b_n = \sum_{j=0}^n (-1)^j d_j$ , gives a chain complex  $\{C_n, b_n\}_{n \geq 0}$ .

**Definition 3.1** *Braided Hochschild homology  $H_*^{\Psi, \sigma}(A, M)$  of  $A$  with coefficients in  $M$  is the homology of the complex  $\{C_n = M \otimes A^{\otimes n}, b_n\}_{n \geq 0}$ .*

**Example 3.2** *In the situation of Example 2.2, a bimodule  $M$  over  $A$  is a bimodule in the usual sense, and  $H_n^{\Psi, \sigma}(A, M)$  reduces to  $H_n(A, {}_\sigma M)$ , Hochschild homology of  $A$  with coefficients in the  $A$ -bimodule  ${}_\sigma M$ , which is  $M$  as  $\mathbb{C}$ -module with bimodule structure  $x \triangleright a \triangleleft y = \sigma(x) \cdot a \cdot y$ , where  $\cdot$  is the original bimodule structure on  $M$ .*



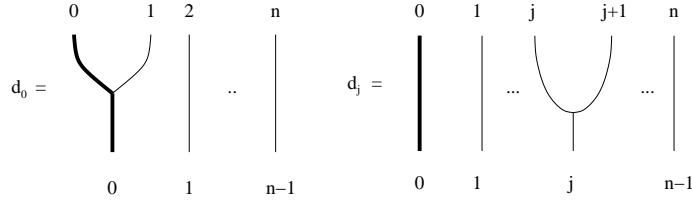

Figure 4: The maps  $d_0$  and  $d_j$ ,  $1 \leq j \leq n - 1$

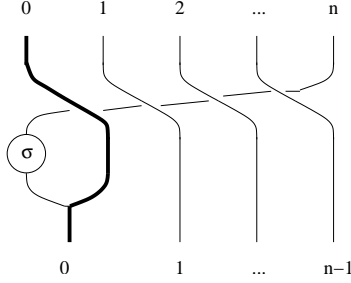

Figure 5: The map  $d_n$

We now extend the derived functor interpretation of  $H_*^{\Psi, \sigma}(A, M)$  from [2] to this setting.

**Definition 3.3** *The braided enveloping algebra  $A^e$  is the object  $A \otimes A$  equipped with the multiplication morphism (Figure 6)*

$$\mu_{A^e} = (\mu \otimes \mu) \Psi_{2,3}^{-1} \Psi_{1,2}^{-1} : A^{\otimes 4} \rightarrow A^{\otimes 2} \quad (11)$$

That is,  $A^e$  is  $A \hat{\otimes} A^{\text{op}}$  taken in  $(\mathcal{C}, \Psi^{-1})$  rather than  $(\mathcal{C}, \Psi)$ . We use this convention in order to be compatible with [1]. Baez works with the opposite convention, taking  $A \hat{\otimes} A^{\text{op}}$  in  $(\mathcal{C}, \Psi)$ , resulting in a graphical calculus where braidings are replaced by inverse braidings.

**Definition 3.4** *For any  $A$ -bimodule  $M$ , we define morphisms (Figure 7)*

$$\blacktriangleright = \triangleright \triangleleft_{1,2} \Psi_{1,2}^{-1} : A^e \otimes M \rightarrow M, \quad \blacktriangleleft = \triangleleft (\sigma \otimes \text{id}) \Psi_{0,1} : M \otimes A^e \rightarrow M$$

It is straightforward to check that:

**Lemma 3.5**  *$\blacktriangleright$  is a left action, and  $\blacktriangleleft$  is a right action of  $A^e$  on  $M$ , i.e.*

$$\blacktriangleright (\text{id}_{A^e} \otimes \blacktriangleright) = \blacktriangleright (\mu_{A^e} \otimes \text{id}_M), \quad \blacktriangleleft (\blacktriangleleft \otimes \text{id}_{A^e}) = \blacktriangleleft (\text{id}_M \otimes \mu_{A^e})$$

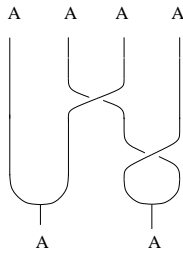

Figure 6: The multiplication of the braided enveloping algebra  $A^e$ .

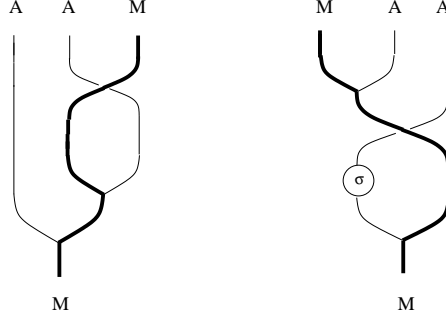

Figure 7: The left and right actions of  $A^e$  on  $M$

*Proof.* We check that

$$\begin{aligned}
\blacktriangleleft (\blacktriangleleft \otimes \text{id}_{A^e}) &= \triangleright (\sigma \otimes \text{id}) \Psi \triangleleft_{0,1} \triangleright_{0,1} (\sigma \otimes \text{id}^{\otimes 3}) \Psi_{0,1} \triangleleft_{0,1} \\
&= \triangleright (\sigma \otimes \text{id}) \Psi \triangleright_{0,1} (\sigma \otimes \text{id}^{\otimes 2}) \Psi_{0,1} \triangleleft_{0,1} \mu_{1,2} \Psi_{2,3}^{-1} \\
&= \triangleright \Psi \mu_{1,2} (\text{id} \otimes \sigma \otimes \sigma) \Psi_{1,2} \triangleleft_{0,1} \mu_{1,2} \Psi_{2,3}^{-1} \\
&= \triangleright (\sigma \otimes \text{id}) \Psi \mu_{1,2} \Psi_{1,2}^{-1} \triangleleft_{0,1} \mu_{1,2} \Psi_{2,3}^{-1} = \blacktriangleleft (\text{id}_M \otimes \mu_{A^e})
\end{aligned}$$

where we used the ribbon property in the form  $\mu \Psi (\sigma \otimes \sigma) = \sigma \mu \Psi^{-1}$ .  $\square$

So if  $A$  is a ribbon algebra, we can make any  $A$ -bimodule  $M$  into both a left and a right  $A^e$ -module. Baez performed these constructions under the assumption that  $A$  is weakly  $\Psi$ -commutative, meaning  $\mu \Psi^2 = \mu$ . The ribbon automorphism  $\sigma$  is the missing ingredient needed to make Baez's constructions work in full generality (the weakly  $\Psi$ -commutative case corresponds to  $\sigma = \text{id}$ ). Conversely, it is easy to check that:

**Lemma 3.6** *If  $M$  is a left  $A^e$ -module via  $\blacktriangleright$ , then  $M$  is an  $A$ -bimodule via*

$$\triangleright := \blacktriangleright (\text{id}_A \otimes \eta \otimes \text{id}_M) : A \otimes M \rightarrow M, \quad \triangleleft := \blacktriangleright (\eta \otimes \text{id}_{A \otimes M}) (\sigma \otimes \text{id}_M) \Psi : M \otimes A \rightarrow M$$

*If  $M$  is a right  $A^e$ -module via  $\blacktriangleleft$ , then  $M$  is an  $A$ -bimodule via*

$$\triangleright := \blacktriangleleft (\text{id}_M \otimes \eta \otimes \text{id}_A) (\text{id}_M \otimes \sigma^{-1}) \Psi^{-1} : A \otimes M \rightarrow M, \quad \triangleleft := \blacktriangleleft (\text{id}_{M \otimes A} \otimes \eta) : M \otimes A \rightarrow M$$

As for any simplicial object,  $\{C_*(A, A)\}$  gives rise to a resolution of  $A$  in  $\mathcal{C}$ , called the bar resolution, when considered with the differential  $b'_{n+1} : A^{\otimes(n+1)} \rightarrow A^{\otimes n}$  defined by  $b'_{n+1} = \sum_{i=0}^{n-1} (-1)^i \mu_{i,i+1}$  (again, in  $A^{\otimes(n+1)}$  we number the strands  $0, 1, \dots, n$ , and  $\mu_{i,i+1} = \text{id}^{\otimes i} \otimes \mu \otimes \text{id}^{\otimes(n-i-1)}$ ). In general, projectivity (in  $\mathcal{C}$ ) of this resolution is a subtle question. However, if we take  $\mathcal{C} = \mathcal{C}(H)$  for a coquasitriangular Hopf algebra  $H$  (over  $\mathbb{C}$ ) as in Section 2.2, then we have a forgetful functor  $\mathcal{C} \rightarrow \mathbb{C}\text{-Vec}$ , and we can consider  $A^e$  simply as a  $\mathbb{C}$ -algebra. Since  $\mathbb{C}$  is a field  $A^e$  is projective as a  $\mathbb{C}$ -module, and the bar resolution will then be a projective resolution in the category of modules over the  $\mathbb{C}$ -algebra  $A^e$  (in the usual sense of ring theory). Tensoring the bar resolution over  $A^e$  on the left by  $M$  (with right  $A^e$ -module structure given by  $\blacktriangleleft$ ) gives, up to isomorphism of complexes of  $\mathbb{C}$ -vector spaces, the complex defining braided Hochschild homology. Hence we have:

**Theorem 3.7** *For  $\mathcal{C} = \mathcal{C}(H)$ , with  $H$  a coquasitriangular Hopf algebra, there is an isomorphism of  $\mathbb{C}$ -vector spaces  $H_*^{\Psi, \sigma}(A, M) \cong \text{Tor}_*^{A^e}(M, A)$ .*

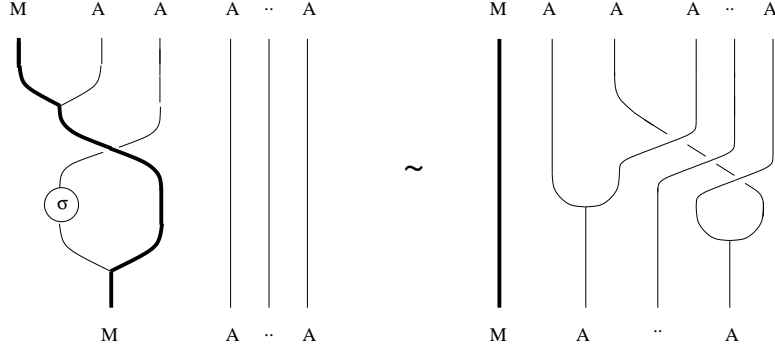

Figure 8: The equivalence relation  $\sim$  for which  $M \otimes_{A^e} A^{\otimes n} = M \otimes A^{\otimes(n+2)} / \sim$

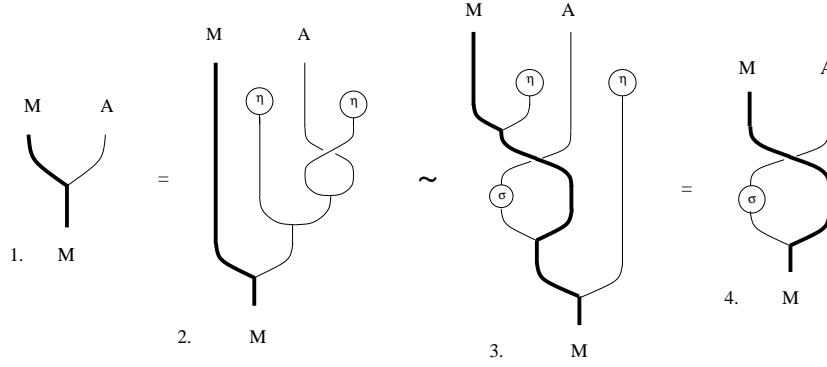

Figure 9: Graphical proof of Theorem 3.7 in degree zero.

We give a graphical illustration. Figure 8 shows the relation  $\sim$  for which  $M \otimes_{A^e} A^{\otimes n} \cong M \otimes A^{\otimes(n+2)} / \sim$ . Figure 9 shows that  $\text{Tor}_0^{A^e}(M, A) = M \otimes_{A^e} A \cong M / \{\triangleleft \sim \triangleright (\sigma \otimes \text{id}) \Psi\}$ , illustrating Theorem 3.7 in degree zero.

### 3.2 Braided cyclic homology

Suppose now that  $M = A$ , and for each  $n \geq 0$  define, as in Figure 10,

$$t_n = (\sigma \otimes \text{id}^{\otimes n}) \Psi_{[0, n-1], n} : A^{\otimes(n+1)} \rightarrow A^{\otimes(n+1)}$$

This makes  $\{C_*(A, A)\}$  into a paracyclic object (see [13] for this notion). Passing to the coinvariants of  $T_n := t_n^{n+1}$ , that is considering the cokernels  $C_n^{\Psi, \sigma} := \text{coker}(\text{id} - T_n)$  we obtain the cyclic object of Akrami and Majid [1].

**Definition 3.8** *Braided cyclic homology  $HC_*^{\Psi, \sigma}(A)$  is defined to be the cyclic homology of this cyclic object.*

**Example 3.9** *In the setting of Example 3.2,  $HH_*^{\Psi, \sigma}(A)$  and  $HC_*^{\Psi, \sigma}(A)$  reduce to Kustermans-Murphy-Tuset twisted Hochschild and cyclic homology  $HH_*^\sigma(A)$ ,  $HC_*^\sigma(A)$  [22].*

Note that the simplicial homology of this cyclic object, which we will denote by  $HH_*^{\Psi, \sigma}(A)$ , is in general different from  $H_*^{\Psi, \sigma}(A, A)$  as defined in the previous section. The short exact sequence of complexes

$$0 \rightarrow C_*^1 \rightarrow C_* \rightarrow C_*^{\Psi, \sigma} \rightarrow 0, \quad C_*^1 := \ker \text{coker}(\text{id} - T) \quad (12)$$

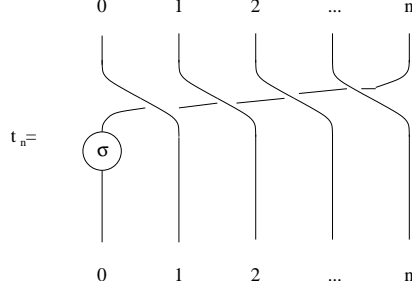

Figure 10: The cyclic operator  $t_n$

yields a long exact sequence

$$\dots \rightarrow H_n(C_*^1) \rightarrow H_n(C_*) \rightarrow H_n(C_*^{\Psi, \sigma}) = HH_n^{\Psi, \sigma}(A) \rightarrow H_{n-1}(C_*^1) \rightarrow \dots$$

but in general  $C_*^1$  is not exact, as we see from the following simple example.

**Example 3.10** *Let  $A$  be the 3-dimensional unital  $\mathbb{C}$ -algebra generated by  $x, y$  with relations  $x^2 = 0 = y^2 = xy = yx$ . Let  $\Psi$  be the flip, and  $\sigma$  the automorphism defined by  $\sigma(x) = x, \sigma(y) = x + y$ . Then  $[1 \otimes x] \in H_1(C_*^1)$  is nontrivial.*

However, in good cases the morphism  $H_*^{\Psi, \sigma}(A, A) \rightarrow HH_*^{\Psi, \sigma}(A)$  is an isomorphism:

**Proposition 3.11** *If  $C_n \cong C_n^0 \oplus C_n^1$  for all  $n$ , for  $C_n^0 = \ker(\text{id} - T_n)$  and  $C_n^1 = \ker \text{coker}(\text{id} - T_n)$ , then  $HH_*^{\Psi, \sigma}(A) \cong H_*^{\Psi, \sigma}(A, A)$ .*

See Proposition 2.1 of [15] for a proof.

It was shown in [1] Theorem 9 that ribbon algebras  $A, A^{\mathbf{f}}$  obtained from one another by gauge transformation (as discussed in Section 2.3) possess isomorphic cyclic (and in fact paracyclic) objects. Thus braided cyclic and Hochschild homology are invariant under gauge transformations.

**Example 3.12** *The standard quantised coordinate ring  $\mathbb{C}_q[G]$  of a complex simple Lie group  $G$  (Example 2.8) is obtained by twisting the classical coordinate ring  $\mathbb{C}[G]$  by the Drinfeld twist  $\mathbf{f}$ . This is not a 2-cocycle, but  $\partial \mathbf{f}$  is cocentral. Hence although  $\mathbb{C}_q[G]$  is associative, twisting  $\mathbb{C}[G]$ -comodule algebras produces in general nonassociative algebras [1, 3].*

Theorem 9 of [1] thus allows us to express braided Hochschild homology of  $\mathbb{C}_q[G]$  as braided Hochschild homology of  $\mathbb{C}[G]$ . Indeed, for any quasi-Hopf algebra  $H$ , and any 2-cochain  $\mathbf{f}$ , we have  $(H^{\text{cop}})^{\bar{\mathbf{f}}} \cong (H^{\mathbf{f}})^{\text{cop}}$ . Hence  $(H^{\text{cop}} \otimes H)^{\bar{\mathbf{f}} \otimes \mathbf{f}} \cong (H^{\mathbf{f}})^{\text{cop}} \otimes H^{\mathbf{f}}$ . Twisting the  $H^{\text{cop}} \otimes H$ -comodule algebra  $A := H$  by  $\bar{\mathbf{f}} \otimes \mathbf{f}$  gives

$$a \bullet b = a_{(2)} b_{(2)} \bar{\mathbf{f}}(a_{(1)}, b_{(1)}) \bar{\mathbf{f}}(a_{(3)}, b_{(3)}) = \mathbf{f}(a_{(1)}, b_{(1)}) a_{(2)} b_{(2)} \bar{\mathbf{f}}(a_{(3)}, b_{(3)})$$

i.e. as an algebra,  $A^{\bar{\mathbf{f}} \otimes \mathbf{f}}$  is isomorphic to the twisted quasi-Hopf algebra  $H^{\mathbf{f}}$ . Apply this with  $H = \mathbb{C}_q[G]$ ,  $\mathbf{r}$  the standard universal  $r$ -form, and  $\mathbf{f}$  the inverse of the Drinfeld twist. This gives the braiding  $\Psi$  as in (4) on  $\mathbb{C}_q[G]$  considered by Baez. Then  $H^{\mathbf{f}} \cong \mathbb{C}[G]$ , but the braiding obtained from  $\Psi$  is **not** the flip. In particular, it does not immediately follow from [1], Theorem 9 that braided Hochschild homology of  $\mathbb{C}_q[G]$  can be identified with standard Hochschild homology of  $\mathbb{C}[G]$ .

## 4 Braided Hochschild homology of Hopf algebras in braided categories

In this Section we extend a result of Feng and Tsygan [12], giving a simpler description of braided Hochschild homology as a derived functor in the case when  $A$  is a Hopf algebra. Throughout we

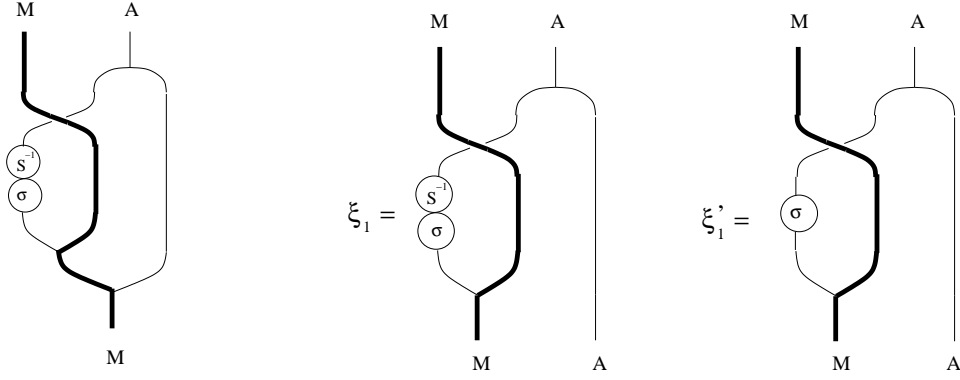

Figure 11: The right  $A$ -module structure of  $R(M)$ , and the maps  $\xi_1, \xi'_1$

keep the assumptions and notations of the previous Section, in particular  $(A, \sigma)$  will always denote a ribbon algebra in a braided monoidal category  $\mathcal{C}$ .

**Lemma 4.1** *Assume that  $A$  is a Hopf algebra in  $\mathcal{C}$  with invertible antipode and let  $M \in \text{Ob}(\mathcal{C})$  be an  $A$ -bimodule. Then the map*

$$\blacktriangleleft = \triangleleft_{\triangleright_{0,1}} [\sigma S^{-1} \otimes \text{id}^{\otimes 2}] \Psi_{0,1}(\text{id} \otimes \Delta) \quad (13)$$

*gives a right action of  $A$  on  $M$  (Figure 11). We write  $R(M)$  for the corresponding right  $A$ -module.*

*Proof.* Writing  $\Delta_m$  for  $\text{id}^{\otimes m} \otimes \Delta \otimes \text{id}^{\otimes n}$  ( $m \geq 0$ ), we check that

$$\begin{aligned} \blacktriangleleft (\blacktriangleleft \otimes \text{id}) &= \triangleleft_{\triangleright_{0,1}} (\sigma S^{-1} \otimes \text{id}^{\otimes 2}) \Psi_{0,1} \Delta_1 \triangleleft_{\triangleright_{0,1}} (\sigma S^{-1} \otimes \text{id}^{\otimes 3}) \Psi_{0,1} \Delta_1 \\ &= \triangleleft_{\triangleright_{0,1}} (\sigma S^{-1} \otimes \text{id}^{\otimes 2}) \Psi_{0,1} \Psi_{1,2} \triangleright_{0,1} (\sigma S^{-1} \otimes \text{id}^{\otimes 4}) \Psi_{0,1} \Delta_1 \Delta_2 \\ &= \triangleleft_{\triangleright_{0,1}} [\mu \Psi (\sigma S^{-1} \otimes \sigma S^{-1}) \otimes \text{id}^{\otimes 2}] \Psi_{0,[1,2]} \mu_{3,4} \Psi_{2,3} \Delta_1 \Delta_2 \\ &= \triangleleft_{\triangleright_{0,1}} (\sigma S^{-1} \otimes \text{id}^{\otimes 2}) \mu_{0,1} \Psi_{0,[1,2]} \mu_{3,4} \Psi_{2,3} \Delta_1 \Delta_2 \\ &= \triangleleft_{\triangleright_{0,1}} (\sigma S^{-1} \otimes \text{id}^{\otimes 2}) \Psi_{0,1} \mu_{1,2} \mu_{3,4} \Psi_{2,3} \Delta_1 \Delta_2 \\ &= \triangleleft_{\triangleright_{0,1}} (\sigma S^{-1} \otimes \text{id}^{\otimes 2}) \Psi_{0,1} (\text{id} \otimes \Delta) (\text{id} \otimes \mu) = \blacktriangleleft (\text{id} \otimes \mu) \end{aligned}$$

where we used the identity  $\mu \Psi (\sigma S^{-1} \otimes \sigma S^{-1}) = \sigma S^{-1} \mu$ .  $\square$

Working with the coopposite Hopf algebra yields the straightforward generalisation of the action considered in [12]. However the above variant is more convenient for graphical calculations.

As in Theorem 3.7, we now restrict to  $\mathcal{C} = \mathcal{C}(H)$ , for  $H$  a coquasitriangular Hopf algebra. We note that for  $A$  a Hopf algebra in  $\mathcal{C}$ , then  $\mathbf{1}_{\mathcal{C}(H)} = \mathbb{C}$  is a left  $A$ -module via the counit  $\varepsilon$ . We now have the following generalisation of [12], Corollary 2.5:

**Theorem 4.2** *Let  $A$  be a Hopf algebra in  $\mathcal{C}(H)$  with ribbon automorphism  $\sigma$  and invertible antipode, and  $M$  an  $A$ -bimodule. Then there is a natural isomorphism of vector spaces*

$$H_n^{\Psi, \sigma}(A, M) \simeq \text{Tor}_n^A(R(M), \mathbb{C})$$

where  $R(M)$  is the right  $A$ -module of Lemma 4.1.

*Proof.* Define maps  $\xi_n, \xi'_n : M \otimes A^{\otimes n} \rightarrow M \otimes A^{\otimes n}$ ,  $n = 1, 2, \dots$  by

$$\begin{aligned} \xi_1 &= \triangleright_{0,1} [\sigma S^{-1} \otimes \text{id}^{\otimes 2}] \Psi_{0,1}(\text{id} \otimes \Delta) \\ \xi_{n+1} &= \Psi_{[1,n],n+1}^{-1} (\xi_1 \otimes \text{id}^{\otimes n}) \Psi_{[1,n],n+1} (\xi_n \otimes \text{id}) \\ \xi'_1 &= \triangleright_{0,1} [\sigma \otimes \text{id}^{\otimes 2}] \Psi_{0,1}(\text{id} \otimes \Delta) \\ \xi'_{n+1} &= (\xi'_n \otimes \text{id}) \Psi_{[1,n],n+1}^{-1} (\xi'_1 \otimes \text{id}^{\otimes n}) \Psi_{[1,n],n+1} \end{aligned} \quad (14)$$

$\xi_1$  and  $\xi'_1$  are shown in Figure 11. We have:

**Lemma 4.3**  $\xi_n \circ \xi'_n = \text{id} = \xi'_n \circ \xi_n$

*Proof.* We prove this by induction. First of all

$$\begin{aligned}\xi'_1 \circ \xi_1 &= \triangleright_{0,1} \mu_{0,1} (\sigma \otimes \sigma S^{-1} \otimes \text{id}^{\otimes 2}) \Psi_{1,2} \Psi_{0,1} \Psi_{1,2} \Delta_2 \Delta_1 \\ &= \triangleright_{0,1} (\sigma \otimes \text{id}^{\otimes 2}) \Psi_{0,1} \mu_{1,2} \Psi_{1,2}^{-2} (\text{id}^{\otimes 2} \otimes S^{-1} \otimes \text{id}) \Psi_{1,2} \Delta_2 \Delta_1 \\ &= \triangleright_{0,1} (\sigma \otimes \text{id}^{\otimes 2}) \Psi_{0,1} [\text{id} \otimes (\mu \circ \Psi^{-1} (S^{-1} \otimes \text{id}) \Delta) \otimes \text{id}] \Delta_1 \\ &= \triangleright_{0,1} \Psi_{0,1} (\text{id} \otimes \eta \circ \varepsilon \otimes \text{id}) \Delta_1 = \text{id}_{M \otimes A}\end{aligned}$$

where we used the identity  $\mu \circ \Psi^{-1} (S^{-1} \otimes \text{id}) \Delta = \eta \circ \varepsilon$ . Suppose that  $\xi'_n \circ \xi_n = \text{id}$ . From (14),

$$\xi'_{n+1} \circ \xi_{n+1} = (\xi'_n \otimes \text{id}) \Psi_{[1,n],n+1}^{-1} (\xi'_1 \circ \xi_1 \otimes \text{id}^{\otimes n}) \Psi_{[1,n],n+1} (\xi_n \otimes \text{id}) = \xi'_n \circ \xi_n \otimes \text{id} = \text{id}$$

The proof that  $\xi_n \circ \xi'_n = \text{id}$  is completely analogous.  $\square$

Recall (10) the maps  $d_j : M \otimes A^{\otimes(n+1)} \rightarrow M \otimes A^{\otimes n}$ ,  $0 \leq j \leq n+1$ . We also define  $\tilde{d}_0, \tilde{d}_{n+1} : M \otimes A^{\otimes(n+1)} \rightarrow M \otimes A^{\otimes n}$  by  $\tilde{d}_0 = \blacktriangleleft \otimes \text{id}^{\otimes n}$ ,  $\tilde{d}_{n+1} = \text{id}^{\otimes(n+1)} \otimes \varepsilon$ .

**Lemma 4.4**  $\xi'_n \circ d_0 \circ \xi_{n+1} = \tilde{d}_0 = \blacktriangleleft \otimes \text{id}^{\otimes n}$ , for all  $n \geq 0$ .

*Proof.* First,  $d_0 \circ \xi_1 = \blacktriangleleft \triangleright_{0,1} [\sigma S^{-1} \otimes \text{id}^{\otimes 2}] \Psi_{0,1} (\text{id} \otimes \Delta) = \blacktriangleleft$ , by definition of  $\blacktriangleleft$  (13). Next,

$$\begin{aligned}\xi'_1 \circ d_0 \circ \xi_2 &= \xi'_1 \blacktriangleleft_{0,1} \Psi_{1,2}^{-1} (\xi_1 \otimes \text{id}) \Psi_{1,2} (\xi_1 \otimes \text{id}) \\ &= \triangleright_{0,1} (\sigma \otimes \text{id}^{\otimes 2}) \Psi_{0,1} \Delta_1 \blacktriangleleft_{0,1} \Psi_{1,2}^{-1} \triangleright_{0,1} (\sigma S^{-1} \otimes \text{id}^{\otimes 3}) \Psi_{0,1} \Delta_1 \Psi_{1,2} \triangleright_{0,1} (\sigma S^{-1} \otimes \text{id}^{\otimes 3}) \Psi_{0,1} \Delta_1 \\ &= \blacktriangleleft_{0,1} \Psi_{1,2}^{-1} \triangleright_{0,1} (\sigma \otimes \text{id}^{\otimes 3}) \Psi_{0,1} \Delta_1 \triangleright_{0,1} (\sigma S^{-1} \otimes \text{id}^{\otimes 3}) \Psi_{0,1} \Delta_1 \triangleright_{0,1} (\sigma S^{-1} \otimes \text{id}^{\otimes 3}) \Psi_{0,1} \Psi_{2,3} \Delta_1 \\ &= \blacktriangleleft_{0,1} \Psi_{1,2}^{-1} \triangleright_{0,1} (\sigma S^{-1} \otimes \text{id}^{\otimes 3}) \Psi_{0,1} \Psi_{2,3} \Delta_1 = \blacktriangleleft_{0,1} \triangleright_{0,1} (\sigma S^{-1} \otimes \text{id}^{\otimes 3}) \Psi_{0,1} \Delta_1 = \blacktriangleleft \otimes \text{id}\end{aligned}$$

By induction, if  $\xi'_n \circ d_0 \circ \xi_{n+1} = \blacktriangleleft \otimes \text{id}^{\otimes n}$ , then

$$\begin{aligned}\xi'_{n+1} \circ d_0 \circ \xi_{n+2} &= (\xi'_n \otimes \text{id}) \Psi_{[1,n],n+1}^{-1} (\xi'_1 \otimes \text{id}^{\otimes n}) \Psi_{[1,n],n+1} \blacktriangleleft_{0,1} \Psi_{[1,n],n+1}^{-1} (\xi_1 \otimes \text{id}^{\otimes n}) \Psi_{[1,n+1],n+2} (\xi_{n+1} \otimes \text{id}) \\ &= (\xi'_n \otimes \text{id}) \Psi_{[1,n],n+1}^{-1} (\xi'_1 \otimes \text{id}^{\otimes n}) \Psi_{[1,n],n+1} \blacktriangleleft_{0,1} \Psi_{[1,n+1],n+2}^{-1} \triangleright_{0,1} (\sigma S^{-1} \otimes \text{id}^{\otimes n+2}) \Psi_{0,1} \\ &\quad \Delta_1 \Psi_{[1,n+1],n+2} (\xi_{n+1} \otimes \text{id}) \\ &= (\xi'_n \otimes \text{id}) \Psi_{[1,n],n+1}^{-1} (\xi'_1 \otimes \text{id}^{\otimes n}) (\xi_1 \otimes \text{id}^{\otimes n}) \Psi_{[1,n],n+1} \blacktriangleleft_{0,1} (\xi_{n+1} \otimes \text{id}) \\ &= (\xi'_n \otimes \text{id}) \blacktriangleleft_{0,1} (\xi_{n+1} \otimes \text{id}) = \blacktriangleleft \otimes \text{id}^{\otimes n+1}\end{aligned}$$

$\square$

**Lemma 4.5**  $\xi'_n \circ d_1 \circ \xi_{n+1} = d_1$  for all  $n \geq 1$ .

*Proof.* First of all,

$$\begin{aligned}
\xi'_1 \circ d_1 \circ \xi_2 &= \triangleright_{0,1}(\sigma \otimes \text{id}^{\otimes 2})(\text{id} \otimes \Delta \circ \mu)\Psi_{1,2}^{-1} \triangleright_{0,1}(\sigma S^{-1} \otimes \text{id}^{\otimes 3})\Psi_{0,1}\Delta_1\Psi_{1,2}(\xi_1 \otimes \text{id}) \\
&= \triangleright_{0,1}(\sigma \otimes \text{id}^{\otimes 2})\Psi_{0,1}\mu_{1,2}\mu_{3,4}\Psi_{2,3}\Delta_1\Delta_2\Psi_{1,2}^{-1} \triangleright_{0,1}(\sigma S^{-1} \otimes \text{id}^{\otimes 3})\Psi_{0,1}\Delta_1\Psi_{1,2}(\xi_1 \otimes \text{id}) \\
&= \triangleright_{0,1}\Psi_{0,1}\mu_{1,2}(\text{id} \otimes \sigma \otimes \sigma S^{-1} \otimes \text{id})\Psi_{1,2}\mu_{1,2}\mu_{3,4}\Psi_{3,4}\Delta_2\Delta_3\Psi_{1,2}\Delta_2(\xi_1 \otimes \text{id}) \\
&= \triangleright_{0,1}(\sigma \otimes \text{id}^{\otimes 2})\Psi_{0,1}\mu_{1,2}\Psi_{1,2}^{-1}(\text{id} \otimes S^{-1} \otimes \text{id}^{\otimes 2})\mu_{2,3}\mu_{4,5}\Psi_{3,4}\Delta_2\Delta_3\Psi_{1,2}\Delta_2(\xi_1 \otimes \text{id}) \\
&= \triangleright_{0,1}(\sigma \otimes \text{id}^{\otimes 2})\Psi_{0,1}\mu_{1,2}\Psi_{2,3}\mu_{1,2}\mu_{3,4}\Psi_{2,3}(\text{id}^{\otimes 5} \otimes S^{-1})\Delta_1\Delta_2\Psi_{2,3}^{-1}\Delta_2(\xi_1 \otimes \text{id}) \\
&= \triangleright_{0,1}(\sigma \otimes \text{id}^{\otimes 2})\Psi_{0,1}\mu_{1,2}\mu_{2,3}\Psi_{3,4}\mu_{3,4}\Psi_{2,3}(\text{id}^{\otimes 5} \otimes S^{-1})\Delta_1\Delta_2\Psi_{2,3}^{-1}\Delta_2(\xi_1 \otimes \text{id}) \\
&= \triangleright_{0,1}(\sigma \otimes \text{id}^{\otimes 2})\Psi_{0,1}\mu_{1,2}\mu_{2,3}\Psi_{3,4}\mu_{3,4}\Psi_{2,3}\Psi_{4,5}^{-1}\Psi_{3,4}^{-1}(\text{id}^{\otimes 3} \otimes S^{-1} \otimes \text{id}^{\otimes 2})\Delta_1\Delta_2\Delta_2(\xi_1 \otimes \text{id}) \\
&= \triangleright_{0,1}(\sigma \otimes \text{id}^{\otimes 2})\Psi_{0,1}\mu_{1,2}\mu_{3,4}\Psi_{2,3}\Delta_1(\text{id}^{\otimes 2} \otimes [\mu\Psi^{-1}(S^{-1} \otimes \text{id})\Delta] \otimes \text{id})\Delta_2(\xi_1 \otimes \text{id}) \\
&= \triangleright_{0,1}(\sigma \otimes \text{id}^{\otimes 2})\Psi_{0,1}\mu_{1,2}\mu_{3,4}\Psi_{2,3}\Delta_1(\text{id}^{\otimes 2} \otimes \eta \circ \varepsilon \otimes \text{id})\Delta_2(\xi_1 \otimes \text{id}) \\
&= \mu_{1,2} \triangleright_{0,1}(\sigma \otimes \text{id}^{\otimes 3})\Psi_{0,1}\Delta_1(\xi_1 \otimes \text{id}) = \mu_{1,2}(\xi'_1 \otimes \text{id})(\xi_1 \otimes \text{id}) = \mu_{1,2} = d_1
\end{aligned}$$

Now suppose that  $\xi'_n \circ d_1 \circ \xi_{n+1} = d_1$ . Then

$$\begin{aligned}
\xi'_{n+1} \circ d_1 \circ \xi_{n+2} &= (\xi'_n \otimes \text{id})\Psi_{[1,n],n+1}^{-1}(\xi'_1 \otimes \text{id}^{\otimes n})\Psi_{[1,n],n+1}d_1\Psi_{[1,n+1],n+2}^{-1}(\xi_1 \otimes \text{id}^{\otimes n+1}) \\
&\quad \Psi_{[1,n+1],n+2}(\xi_{n+1} \otimes \text{id}) \\
&= (\xi'_n \otimes \text{id})\Psi_{[1,n],n+1}^{-1}(\xi'_1 \otimes \text{id}^{\otimes n})(\xi_1 \otimes \text{id}^{\otimes n})\mu_{2,3}\Psi_{[1,n+1],n+2}(\xi_{n+1} \otimes \text{id}) \\
&= (\xi'_n \otimes \text{id})\Psi_{[1,n],n+1}^{-1}\mu_{2,3}\Psi_{[1,n+1],n+2}(\xi_{n+1} \otimes \text{id}) \\
&= (\xi'_n \otimes \text{id})\mu_{1,2}(\xi_{n+1} \otimes \text{id}) = (\xi'_n \circ d_1 \circ \xi_{n+1}) \otimes \text{id} = d_1
\end{aligned}$$

□

**Lemma 4.6**  $\xi'_n \circ d_{n+1} \circ \xi_{n+1} = (\text{id}^{\otimes n+1} \otimes \varepsilon) = \tilde{d}_{n+1}$  for all  $n \geq 1$ .

*Proof.* We have

$$\begin{aligned}
d_1 \circ \xi_1 &= \triangleright_{0,1}(\sigma \otimes \text{id})\Psi_{0,1} \triangleright_{0,1}(\sigma S^{-1} \otimes \text{id}^{\otimes 2})\Psi_{0,1}\Delta_1 \\
&= \triangleright_{0,1}(\sigma \otimes \text{id})\Psi_{0,1}\mu_{1,2}\Psi_{1,2}(\text{id} \otimes S^{-1} \otimes \text{id})\Delta_1 = \text{id} \otimes \varepsilon \\
\Rightarrow \xi'_n \circ d_{n+1} \circ \xi_{n+1} &= \xi'_n \triangleright_{0,1}(\sigma \otimes \text{id}^{\otimes n+1})\Psi_{[0,n],n+1}\Psi_{[1,n],n+1}^{-1}(\xi_1 \otimes \text{id}^{\otimes n})\Psi_{[1,n],n+1}(\xi_n \otimes \text{id}) \\
&= \xi'_n(d_1 \circ \xi_1 \otimes \text{id}^{\otimes n})\Psi_{[1,n],n+1}(\xi_n \otimes \text{id}) \\
&= \xi'_n(\text{id} \otimes \varepsilon \otimes \text{id}^{\otimes n})\Psi_{[1,n],n+1}(\xi_n \otimes \text{id}) = \text{id}^{\otimes n+1} \otimes \varepsilon
\end{aligned}$$

for all  $n \geq 1$ .

□

Finally it is straightforward to check that:

**Lemma 4.7**  $\xi'_n \circ d_i \circ \xi_{n+1} = d_i$  for  $1 \leq i \leq n$ .

Therefore  $\xi_n, \xi'_n$  define isomorphisms of complexes between the braided Hochschild complex and the complex  $\{M \otimes A^{\otimes n}, \tilde{b}_n\}$ , where  $\tilde{b}_{n+1} = \tilde{d}_0 + \sum_{j=1}^n (-1)^j d_j + \tilde{d}_{n+1} : M \otimes A^{\otimes(n+1)} \rightarrow M \otimes A^{\otimes n}$ . That the homology of the latter complex is  $\text{Tor}_*^A(R(M), \mathbb{C})$  follows from [5] Cor. IX.4.4, applied with  $K, \Lambda, A, B$  being  $\mathbb{C}, A, \mathbb{C}, R(M)$  respectively. □

Figure 12 shows a graphical proof in degree zero.

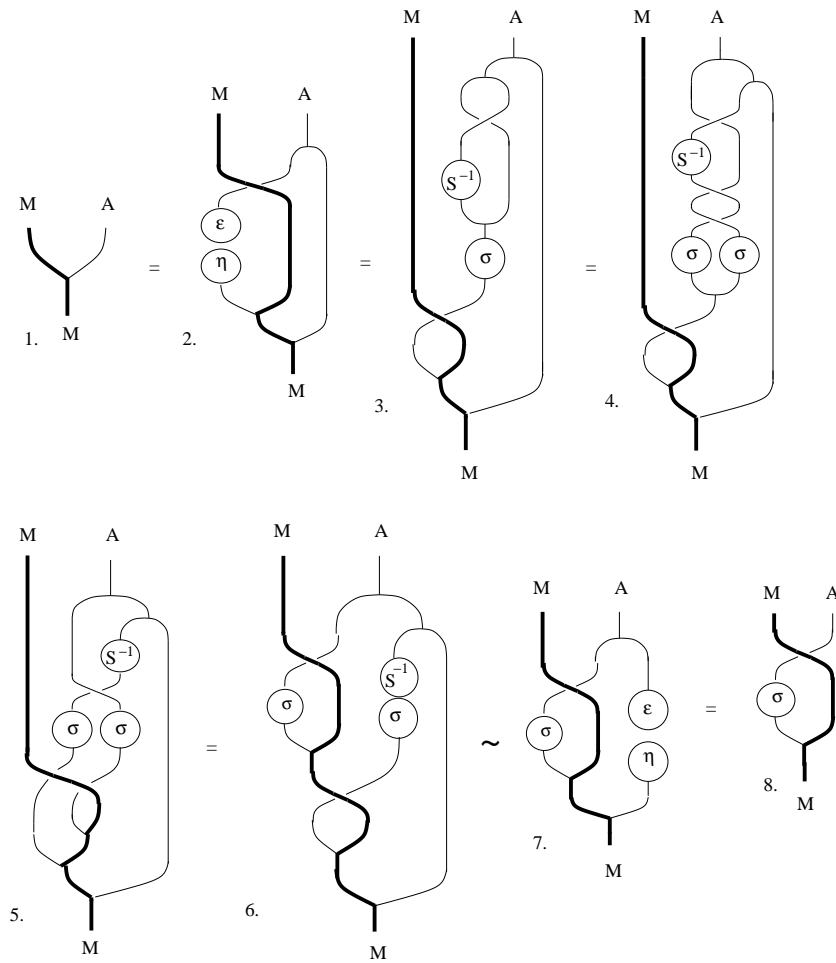

Figure 12: Graphical proof of Theorem 4.2 in degree zero.



## 5 The braided line and the braided plane

In this section we consider the braided line and braided plane. We observe that braided Hochschild homology is less degenerate than ordinary Hochschild homology of the classical counterparts. Throughout this section  $q \in \mathbb{C}$  will denote a nonzero parameter which is not a root of unity.

### 5.1 The braided line

Let  $H$  be the commutative Hopf algebra  $\mathbb{C}\mathbb{Z} = \mathbb{C}[t, t^{-1}]$ , with coproduct  $\Delta(t) = t \otimes t$ . Then  $H$  is coquasitriangular, via  $\mathbf{r}(t^m, t^n) = q^{mn}$  for all  $m, n \in \mathbb{Z}$ . Let  $\mathbb{C}[x]$  be the unital  $\mathbb{C}$ -algebra in a single indeterminate  $x$ . Then  $\mathbb{C}[x]$  is a right  $H$ -comodule algebra, via  $x^m \mapsto x^m \otimes t^m$ , for all  $m \geq 1$ . The braiding (2) is  $\Psi(x^m \otimes x^n) = q^{mn}x^n \otimes x^m$ . The braided line  $A$  is the braided Hopf algebra given by  $\mathbb{C}[x]$  with

$$\Delta(1) = 1 \otimes 1, \quad \Delta(x) = x \otimes 1 + 1 \otimes x, \quad \varepsilon(x) = 0, \quad S(x) = -x$$

It follows from the ribbon relation  $\mu \circ (\sigma \otimes \sigma) \circ \Psi^2 = \sigma \circ \mu$  that any ribbon automorphism satisfies  $\sigma(1) = 1$ ,  $\sigma(x^n) = q^{n(n-1)}\sigma(x)^n$  for all  $n \geq 1$ . Taking  $\sigma(x) = \sum_{n \geq 0} \lambda_n x^n$ , compatibility with the braiding forces  $\lambda_n = 0$  for  $n \neq 1$ , so  $\sigma(x) = \lambda x$ ,  $\sigma(x^n) = (\lambda q^{n-1})^n x^n$  for all  $n \geq 1$ . Since we need  $\sigma$  to be invertible,  $\lambda \neq 0$ .

Every elementary tensor  $x^{m_0} \otimes \dots \otimes x^{m_n}$  is an eigenvector of  $T_n$ , hence Proposition 3.11 applies and  $HH_n^{\Psi, \sigma}(A) \cong H_n^{\Psi, \sigma}(A, A)$  for all  $n$ .

**Proposition 5.1** *We have  $HH_n^{\Psi, \sigma}(A) = 0$  for all  $n \geq 2$ , for all  $q, \lambda$ .*

1. For  $\lambda \notin q^{-\mathbb{N}}$ , then  $HH_0^{\Psi, \sigma}(A) = \mathbb{C}[1]$ ,  $HH_1^{\Psi, \sigma}(A) = 0$ .
2. For  $\lambda = q^{-N}$ , some  $N \in \mathbb{N}$ , then  $HH_0^{\Psi, \sigma}(A) = \mathbb{C}[1] \oplus \mathbb{C}[x^{N+1}]$ ,  $HH_1^{\Psi, \sigma}(A) = \mathbb{C}[x^N \otimes x]$ .

*Proof.* We use Theorem 4.2. Consider the resolution of  $\mathbb{C}$  by free left  $A$ -modules:  $0 \rightarrow A \rightarrow^\varphi A \rightarrow^\varepsilon \mathbb{C} \rightarrow 0$ , where  $\varphi(x^n) = x^{n+1}$ . Tensoring on the left by  $R(A) \otimes_A -$ , where  $R(A)$  has underlying space  $A$  and right action

$$x^n \blacktriangleleft x = x^{n+1} + q^n \sigma(S^{-1}(x))x^n = (1 - \lambda q^n)x^{n+1}$$

gives  $HH_*^{\Psi, \sigma}(A)$  as the homology of  $0 \rightarrow R(A) \otimes_A A \rightarrow^\phi R(A) \otimes_A A$ . Here

$$\phi(x^n \otimes 1) = x^n \otimes x = x^n \blacktriangleleft x \otimes 1 = (1 - \lambda q^n)x^{n+1} \otimes 1$$

It follows that if  $\lambda \notin q^{-\mathbb{N}}$ , then  $HH_0^{\Psi, \sigma}(A) = \mathbb{C}[1]$ ,  $HH_1^{\Psi, \sigma}(A) = 0$ , whereas if  $\lambda = q^{-N}$ , then  $\ker(\phi)$  is one-dimensional, and  $\text{coker}(\phi)$  is two-dimensional, with generators as above.  $\square$

Using standard spectral sequence arguments [15] we calculate the braided cyclic homology. We note that for the map  $B_0 : HH_0^{\Psi, \sigma}(A) \rightarrow HH_1^{\Psi, \sigma}(A)$  we have  $B_0[x^{n+1}] = (n+1)[x^n \otimes x]$ .

**Corollary 5.2** *For  $q$  not a root of unity, we have  $HC_{2n+1}^{\Psi, \sigma}(A) = 0$ ,*

$$HC_{2n+2}^{\Psi, \sigma}(A) = \mathbb{C}[1], \text{ for } n \geq 0, \text{ and } HC_0^{\Psi, \sigma}(A) = \begin{cases} \mathbb{C}[1] & : \lambda \notin q^{-\mathbb{N}} \\ \mathbb{C}[1] \oplus \mathbb{C}[x^{N+1}] & : \lambda = q^{-N} \end{cases}$$

**Remark 5.3** *In the classical case  $\lambda = 1 = q$ ,  $HH_n(A) = 0$  for  $n \geq 2$ , and  $HH_1(A)$ ,  $HH_0(A)$  are both infinite dimensional, spanned by  $\{[x^n \otimes x]\}_{n \geq 0}$ ,  $\{[x^n]\}_{n \geq 0}$ . Hence  $HC_0(A)$  is infinite dimensional,  $HC_{2n+1}(A) = 0$  and  $HC_{2n+2}(A) = \mathbb{C}[1]$ , for  $n \geq 0$ .*

## 5.2 The braided plane

In this section,  $A$  denotes Manin's quantum plane, that is, the unital algebra (over  $\mathbb{C}$ ) generated by indeterminates  $x, y$  satisfying  $yx = qxy$ . This is a right  $H = \mathbb{C}_q[SL(2)]$ -comodule algebra via

$$[y, x] \mapsto [y, x] \otimes \begin{bmatrix} a & b \\ c & d \end{bmatrix} = [y \otimes a + x \otimes c, y \otimes b + x \otimes d]$$

One can identify  $A$  with the subalgebra of  $H$  generated by  $a, b$ . Under this identification,  $y$  becomes  $a$ ,  $x$  becomes  $b$ , and the coaction becomes  $\Delta$  (so  $A$  is an "embeddable quantum space" of  $H$ ). Obviously, the monomials  $x^m y^n$  form a vector space basis of  $A$ . Under the embedding into  $H$  these monomials become proportional to the Peter-Weyl basis elements  $C_{0m}^{(m+n)}$ . The precise factor is given e.g. in [20], but it is irrelevant for us.

The braiding (2) induced from the coquasitriangular structure of  $H$  is determined by:

$$\begin{aligned} \Psi(x \otimes x) &= q^{1/2} x \otimes x, & \Psi(x \otimes y) &= q^{-1/2} y \otimes x \\ \Psi(y \otimes x) &= q^{-1/2} [x \otimes y + (q - q^{-1}) y \otimes x], & \Psi(y \otimes y) &= q^{1/2} y \otimes y \\ \Rightarrow \Psi(x^m y^n \otimes x) &= q^{(m-n)/2} x \otimes x^m y^n + q^{(n-m-2)/2} f(n) y \otimes x^{m+1} y^{n-1}, \\ \Psi(x^m y^n \otimes y) &= q^{(n-m)/2} y \otimes x^m y^n, & \Psi(x \otimes x^m y^n) &= q^{(m-n)/2} x^m y^n \otimes x, \\ \Psi(y \otimes x^m y^n) &= q^{(n-m)/2} x^m y^n \otimes y + q^{(m-n-2)/2} f(m) x^{m-1} y^{n+1} \otimes x \end{aligned}$$

where  $f(n) = q^n - q^{-n}$ . There is a braided Hopf algebra structure on  $A$  given by [24]:

$$\Delta(x) = x \otimes 1 + 1 \otimes x, \quad \Delta(y) = y \otimes 1 + 1 \otimes y, \quad \varepsilon(x) = 0 = \varepsilon(y), \quad S(x) = -x, \quad S(y) = -y$$

**Proposition 5.4** *The ribbon automorphisms of  $A$  are parametrised by  $\lambda \neq 0$  and given by*

$$\sigma(x^m y^n) = \lambda^{m+n} q^{(m+n)(m+n-1)/2} x^m y^n.$$

*Proof.* Applying the ribbon relation to  $\sigma(yx - qxy)$  gives  $\sigma(y)\sigma(x) = q\sigma(x)\sigma(y)$ . Furthermore, one easily shows by induction on  $m+n$  that  $\sigma(x^m y^n)$  is a linear combination of monomials in  $\sigma(x), \sigma(y)$  (using the above formulae for the braiding). That is,  $\sigma(y), \sigma(x)$  generate  $A$  as an algebra. It follows that  $\sigma(x) = \lambda x, \sigma(y) = \rho y$ , for some  $\lambda, \rho \in \mathbb{C}$ . Compatibility with the braiding forces  $\lambda = \rho$ . Using the defining property, one easily checks that  $\sigma$  extends to  $x^m$  and  $y^n$  by the formula given. To derive the formula in general one can proceed as follows: Twist the  $H$ -comodule algebra  $A$  by the 2-cocycle  $\mathbf{q} = \mathbf{r}_{21}\mathbf{r}$ , that is, consider the new product  $f \bullet g := f_{(0)}g_{(0)}\mathbf{q}(f_{(1)}, g_{(1)})$ . The defining property of the ribbon automorphism is  $\sigma(f \bullet g) = \sigma(f)\sigma(g)$ , and in particular  $\sigma(x^m \bullet y^n) = \lambda^{m+n} q^{m(m-1)/2+n(n-1)/2} x^m y^n$ . But since  $\mathbf{q} = \partial\varphi^2$  with  $\varphi^2$  given in (9), we have also an isomorphism  $f \mapsto \eta(f) := f_{(0)}\varphi^2(f_{(1)})$  between the two products, and using the explicit formula for  $\varphi^2$  and the fact that  $x^m y^n$  is proportional to  $C_{0m}^{(m+n)}$ , we obtain

$$\begin{aligned} \eta(x^m) \bullet \eta(y^n) &= \eta(x^m y^n) \\ \Leftrightarrow (-1)^m q^{-(m^2/2+m)} x^m \bullet (-1)^n q^{-(n^2/2+n)} y^n &= (-1)^{m+n} q^{-((m+n)^2/2+m+n)} x^m y^n \\ \Leftrightarrow x^m \bullet y^n &= q^{-mn} x^m y^n. \end{aligned}$$

The claim follows. □

In other words, the ribbon automorphisms arise as  $\sigma(f) = f_{(0)}\mathbf{s}_\lambda(f_{(1)})$ , where  $\mathbf{s}_\lambda(C_{rs}^m) = \lambda^m q^{m(m-1)/2} \delta_{rs}$ . It is now easily shown by induction that  $T_n$  is in fact the ribbon automorphism of  $A^{\otimes n+1}$ , that is, is given by  $T_n(f \otimes g \otimes \cdots \otimes h) = f_{(0)} \otimes g_{(0)} \otimes \cdots \otimes h_{(0)} \mathbf{s}_\lambda(f_{(1)}g_{(1)} \cdots h_{(1)})$ . In particular,  $T_n$  acts by scalar multiplication on the irreducible subcomodules of  $A^{\otimes n+1}$ . Hence  $T_n$  is diagonalisable, and by Proposition 3.11 we have:

**Lemma 5.5**  $HH_*^{\Psi,\sigma}(A) = H_*^{\Psi,\sigma}(A, A)$ .

**Proposition 5.6** 1. If  $\lambda \notin q^{-\mathbb{N}/2}$ , then  $HH_0^{\Psi,\sigma}(A) = \mathbb{C}[1]$ ,  $HH_1^{\Psi,\sigma}(A) = 0 = HH_2^{\Psi,\sigma}(A)$ .  
 2. If  $\lambda = q^{-N/2}$ , some  $N \in \mathbb{N}$ , then  $HH_0^{\Psi,\sigma}(A) \cong \mathbb{C}^{N+3}$ ,  $HH_1^{\Psi,\sigma}(A) \cong \mathbb{C}^{2N+2}$ ,  $HH_2^{\Psi,\sigma}(A) \cong \mathbb{C}^{N+1}$

*Proof.* We compute  $H_*^{\Psi,\sigma}(A, A)$  via an explicit resolution, then by Lemma 5.5 we identify this with  $HH_*^{\Psi,\sigma}(A)$ . Let  $M_2, M_1$  be the free left  $A$ -modules with bases  $\{[x \wedge y]\}$ ,  $\{[x], [y]\}$  respectively, and let  $M_0 = A$ . Define left  $A$ -module maps  $f_i : M_i \rightarrow M_{i-1}$ ,  $i = 2, 1$  by

$$f_2[x \wedge y] = y[x] - qx[y], \quad f_1[x] = x, \quad f_1[y] = y$$

Then the sequence  $0 \rightarrow M_2 \xrightarrow{f_2} M_1 \xrightarrow{f_1} M_0 \xrightarrow{\varepsilon} \mathbb{C}$  is a free resolution of  $\mathbb{C}$  ( $A$  is a Koszul algebra, and this is the Koszul resolution of the trivial  $A$ -module  $\mathbb{C}$ ). We tensor on the left by  $R(A)$ , the right  $A$ -module with underlying space  $A$  and right action

$$x^m y^n \blacktriangleleft x = q^n(1 - \lambda q^{(m+n)/2})x^{m+1}y^n, \quad x^m y^n \blacktriangleleft y = (1 - \lambda q^{(m+n)/2})x^m y^{n+1} \quad (15)$$

So  $HH_*^{\Psi,\sigma}(A)$  is the homology of the complex  $0 \rightarrow A \xrightarrow{g_2} A \oplus A \xrightarrow{g_1} A \rightarrow 0$  where

$$g_2(a) = (a \blacktriangleleft y, -qa \blacktriangleleft x), \quad g_1(a, b) = a \blacktriangleleft x + b \blacktriangleleft y$$

Using (15), then for  $\lambda \notin q^{-\mathbb{N}/2}$  we have  $\ker(g_2) = 0$ ,  $\text{im}(g_2) = \ker(g_1)$ , and  $A/\text{im}(g_1) = \mathbb{C}[1]$ . For  $\lambda = q^{-N/2}$  ( $N \in \mathbb{N}$ ), then  $\ker(g_2) = \text{span}\{x^m y^n \mid m+n = N\} \cong \mathbb{C}^{N+1}$ ,  $\ker(g_1)/\text{im}(g_2) = \text{span}\{(x^m y^n, 0), (0, x^m y^n) \mid m+n = N\} \cong \mathbb{C}^{2N+2}$ , and  $A/\text{im}(g_1) = k[1] \oplus \text{span}\{x^m y^n \mid m+n = N+1\} \cong \mathbb{C}^{N+3}$ . We can identify the generators of  $HH_1^{\Psi,\sigma}(A)$  with the 1-cycles  $x^m y^n \otimes x$ ,  $x^m y^n \otimes y$ , for  $m+n = N$ .  $\square$

**Theorem 5.7** 1. For  $\lambda \notin q^{-\mathbb{N}/2}$ , then  $HC_{2n}^{\Psi,\sigma}(A) \cong \mathbb{C}$ , generated by  $[1]$ , and  $HC_{2n+1}^{\Psi,\sigma}(A) = 0$ .  
 2. For  $\lambda = q^{-N/2}$ ,  $HC_0^{\Psi,\sigma}(A) \cong \mathbb{C}^{N+3}$ ,  $HC_1^{\Psi,\sigma}(A) \cong \mathbb{C}^N$ ,  $HC_{2n+2}^{\Psi,\sigma}(A) \cong \mathbb{C}^2$ ,  $HC_{2n+3}^{\Psi,\sigma}(A) = 0$ , for all  $n \geq 0$ .

*Proof.* We calculate  $HC_*^{\Psi,\sigma}(A)$  as total homology of the mixed  $(B, b)$ -bicomplex associated to the cyclic object of Section 3.2, as in [15]. For  $\lambda \notin q^{-\mathbb{N}/2}$ , the spectral sequence stabilises at the first page. For  $\lambda = q^{-N/2}$  we need to calculate with the maps  $B_i : HH_i^{\Psi,\sigma}(A) \rightarrow HH_{i+1}^{\Psi,\sigma}(A)$ ,  $i = 0, 1$ :

$$B_0[a] = [1 \otimes a], \quad B_1[a \otimes b] = [1 \otimes ((\text{id} - t_1)(a \otimes b))]$$

In the same way as in [15], Lemma 2.2, we have

$$B_0[x^{N+1}] = (N+1)[x^N \otimes x], \quad B_0[x^m y^n] = n[x^m y^{n-1} \otimes y] + mq^{-n}[x^{m-1} y^n \otimes x], \quad m+n = N+1$$

Since  $b_2(1 \otimes 1 \otimes 1) = 1 \otimes 1 = B_0(1)$ , we have  $\ker(B_0) = \mathbb{C}[1]$ ,  $\text{im}(B_0) \cong \mathbb{C}^{N+2}$ , hence  $HC_1^{\Psi,\sigma}(A) \cong \mathbb{C}^N$ , with generators the (equivalence classes of the) elements  $x^j y^{N-j} \otimes x$ , equivalently  $x^{j+1} y^{N-j-1} \otimes y$ , for  $j = 0, 1, \dots, N-1$ . Finally we show that  $\text{im}(B_1) \cong \mathbb{C}^N$ . We have

$$B_1(x^m y^n \otimes x) = 1 \otimes x^m y^n \otimes x - q^{-n}(1 \otimes x \otimes x^m y^n) - q^{-m-1}f(n)(1 \otimes y \otimes x^{m+1} y^{n-1}) \quad (16)$$

Consider the linear functional  $\tau_{s,t} : A \rightarrow \mathbb{C}$  defined by  $\tau_{s,t}(x^i y^j) = \delta_{s,i} \delta_{t,j}$ . Then for  $s+t = N+1$ ,  $\tau_{s,t}$  is a nontrivial braided cyclic 0-cocycle on  $A$ . In particular  $\tau_{s,t} \circ b_1 = 0$ , where  $b_1 : A^{\otimes 2} \rightarrow A$  is defined by  $b_1 = \mu - \mu \circ (\sigma \otimes \text{id}) \circ \Psi$ . Let  $\partial_1, \partial_2 : A \rightarrow A$  be the derivations defined by

$$\partial_1(x) = x, \quad \partial_1(y) = 0, \quad \partial_2(x) = 0, \quad \partial_2(y) = y$$

and extended by  $\partial_i(ab) = \partial_i(a)b + a\partial_i(b)$ . Then

$$\phi_{s,t} : A^{\otimes 3} \rightarrow \mathbb{C}, \quad \phi_{s,t}(a \otimes b \otimes c) = \tau_{s,t}(a [\partial_1(b) \partial_2(c) - \partial_2(b) \partial_1(c)])$$

is a braided Hochschild 2-cocycle, meaning  $\phi_{s,t} \circ b_3 = 0$ . Using (16),

$$\phi_{m+1,n}(B_1(x^m y^n \otimes x)) = ((m-n+1)q^n - (m+n+1)q^{-n})\tau_{m+1,n}(x^{m+1}y^n)$$

which is nonzero for  $n \neq 0$ . Hence  $B_1(x^m y^n \otimes x)$  represent distinct nontrivial elements of  $HH_2^{\Psi,\sigma}(A)$ , for  $n = 1, 2, \dots, N$ . Since  $HH_1^{\Psi,\sigma}(A)/\text{im}(B_0) \cong \mathbb{C}^N$ , it follows that  $\text{im}(B_1) \cong \mathbb{C}^N$ . Hence  $HH_2^{\Psi,\sigma}(A)/\text{im}(B_1) \cong \mathbb{C}$ , and  $\ker(B_1) = \text{im}(B_0)$ . The spectral sequence stabilises at the second page, and we have:

$$\begin{aligned} HC_0^{\Psi,\sigma}(A) &= HH_0^{\Psi,\sigma}(A) \cong \mathbb{C}^{N+3}, & HC_1^{\Psi,\sigma}(A) &= HH_1^{\Psi,\sigma}(A)/\text{im}(B_0) \cong \mathbb{C}^N, \\ HC_{2n+2}^{\Psi,\sigma}(A) &= \ker(B_0) \oplus HH_2^{\Psi,\sigma}(A)/\text{im}(B_1) \cong \mathbb{C}^2, & HC_{2n+3}^{\Psi,\sigma}(A) &= \ker(B_1)/\text{im}(B_0) = 0, \end{aligned}$$

for all  $n \geq 0$ . □

## 6 Braided $SL(2)$

### 6.1 Braided Hopf algebras associated to coquasitriangular Hopf algebras

Let  $(H, \mathbf{r})$  be a coquasitriangular Hopf algebra. Let  $A \in \text{Ob}(\mathcal{C}(H))$  be  $H$  equipped with the right adjoint coaction  $\text{Ad}_R(a) = a_{(2)} \otimes S(a_{(1)})a_{(3)}$ . In general  $A$  is not a right  $H$ -comodule algebra. Now define  $B = B(H)$  to be the algebra with underlying vector space  $H$  and (associative) product

$$a * b = a_{(2)}b_{(3)} \mathbf{r}(a_{(1)}, b_{(2)})\mathbf{r}(a_{(3)}, Sb_{(1)}) = a_{(2)}b_{(2)} \mathbf{r}(S(a_{(1)})a_{(3)}, Sb_{(1)}) \quad (17)$$

Then  $B$  is via  $\text{Ad}_R$  a right  $H$ -comodule algebra and in fact a Hopf algebra in  $\mathcal{C}(H)$  with coproduct and antipode given by

$$\Delta(a) = a_{(1)} \otimes a_{(2)}, \quad \underline{S}(a) = S(a_{(2)})\mathbf{r}(S^2(a_{(3)})S(a_{(1)}), a_{(4)}) \quad (18)$$

(see [24] and [20] Section 10.3.2). We call  $B$  the braided Hopf algebra associated to  $H$ , alternatively the transmutation of  $H$ . The coaction  $\text{Ad}_R$  gives a braiding

$$\Psi_B : B \otimes B \rightarrow B \otimes B, \quad \Psi_B(a \otimes b) = b_{(2)} \otimes a_{(2)} \mathbf{r}(S(a_{(1)})a_{(3)}, S(b_{(1)})b_{(3)}) \quad (19)$$

### 6.2 Braided homology of quantum $SL(2)$

Our aim in this Section is to apply this to  $A = \mathbb{C}_q[SL(2)]$  as defined in (5,6). The universal  $\mathbf{r}$ -form was explicitly recalled in (7). The resulting canonical braiding (3) is defined on generators by:

$$\begin{aligned} \Psi(a \otimes a) &= q^{1/2}a \otimes a, & \Psi(a \otimes b) &= q^{-1/2}b \otimes a + q^{-1/2}(q - q^{-1})a \otimes b \\ \Psi(a \otimes c) &= q^{1/2}c \otimes a, & \Psi(a \otimes d) &= q^{-1/2}d \otimes a + q^{-1/2}(q - q^{-1})c \otimes b \\ \Psi(b \otimes a) &= q^{-1/2}a \otimes b, & \Psi(b \otimes b) &= q^{1/2}b \otimes b \\ \Psi(b \otimes c) &= q^{-1/2}c \otimes b, & \Psi(b \otimes d) &= q^{1/2}d \otimes b \\ \Psi(c \otimes a) &= q^{1/2}a \otimes c, & \Psi(c \otimes b) &= q^{-1/2}b \otimes c + q^{-1/2}(q - q^{-1})a \otimes d \\ \Psi(c \otimes c) &= q^{1/2}c \otimes c, & \Psi(c \otimes d) &= q^{-1/2}d \otimes c + q^{-1/2}(q - q^{-1})c \otimes d \\ \Psi(d \otimes a) &= q^{-1/2}a \otimes d, & \Psi(d \otimes b) &= q^{1/2}b \otimes d \\ \Psi(d \otimes c) &= q^{-1/2}c \otimes d, & \Psi(d \otimes d) &= q^{1/2}d \otimes d \end{aligned} \quad (20)$$

As a special case of [17], it is straightforward to show that:

**Proposition 6.1** *For this braiding there are precisely two ribbon automorphisms  $\sigma_{\pm}$ , defined on generators by  $\sigma_{\pm}(x) = \pm q^{3/2}x$  for  $x = a, b, c, d$ , and extended by  $\sigma_{\pm}(xy) = \mu(\sigma_{\pm} \otimes \sigma_{\pm})\Psi^2(x \otimes y)$ .*

Since in the classical limit  $q = 1$  we would like  $\sigma = \text{id}$ , we will restrict attention to  $\sigma_+$ . The corresponding  $\mathbf{s} \in A^\circ$  is defined by  $\mathbf{s}(a) = q^{3/2} = \mathbf{s}(d)$ ,  $\mathbf{s}(b) = 0 = \mathbf{s}(c)$  (see [19], p366). Then:

**Proposition 6.2** *For the braiding (20) and  $\sigma = \sigma_+$ ,  $HH_0^{\Psi, \sigma}(A) = 0$ .*

*Proof.* We calculate  $H_0^{\Psi, \sigma}(A, A)$  directly from the definition. Since  $A$  is unital this coincides with  $HH_0^{\Psi, \sigma}(A)$ . By induction we obtain the formulae

$$\begin{aligned}\Psi(a^i b^j c^k \otimes c) &= q^{(i-j+k)/2} c \otimes a^i b^j c^k, & \Psi(a^i b^j c^k \otimes a) &= q^{(i-j+k)/2} a \otimes a^i b^j c^k, \\ \Psi(d^i b^j c^k \otimes c) &= q^{(-i-j+k)/2} c \otimes d^i b^j c^k.\end{aligned}$$

Hence

$$\begin{aligned}b_{\Psi, \sigma}(a^i b^j c^k \otimes a) &= q^{-j-k} (1 - q^{(3+i+j+3k)/2}) a^{i+1} b^j c^k, \\ b_{\Psi, \sigma}(b^j c^k \otimes c) &= (1 - q^{(3-j+k)/2}) b^j c^{k+1}, \\ b_{\Psi, \sigma}(d b^j c^k \otimes a) &= q^{-j-k-1} [(1 - q^{(j+3k+5)/2}) + q^{-1} (1 - q^{(j+3k+9)/2})] b^j c^k \\ b_{\Psi, \sigma}(b \otimes b) &= q^{1/2} b^2, \quad b_{\Psi, \sigma}[d \otimes a - q^{-1} (1 + q + q^2) b \otimes c] = 1.\end{aligned}$$

Using these in order, first  $[a^{i+1} b^j c^k] = 0$  for all  $i, j, k \geq 0$ . Second,  $[b^j c^{k+1}] = 0$  unless  $j = k + 3$ . Next, for all  $j, k$ ,  $[b^j c^k] = \lambda_{jk} [b^{j+1} c^{k+1}]$  for some nonzero  $\lambda_{jk}$ , hence each  $[b^{k+3} c^{k+1}]$  is proportional to  $[b^2]$ , which is zero. Finally  $[1] = 0$ , so we have  $[a^i b^j c^k] = 0$  for all  $i, j, k \geq 0$ . In the same way,

$$\begin{aligned}b_{\Psi, \sigma}(d^i b^j c^k \otimes c) &= (1 - q^{(3+i-j+k)/2}) d^i b^j c^{k+1}, \\ b_{\Psi, \sigma}(d^{i+1} b^j c^k \otimes a) &= q^{-j-k} d^{i+1} [(1 - q^{(2-i+j+3k)/2}) + q^{-1} (1 - q^{(3i+j+3k+6)/2})] b^j c^k, \\ b_{\Psi, \sigma}(d^{i+1} b^j \otimes b) &= (1 - q^{(3i+j+6)/2}) d^{i+1} b^{j+1}, \quad b_{\Psi, \sigma}(d^i \otimes d) = (1 - q^{(i+3)/2}) d^{i+1}.\end{aligned}$$

Hence  $[d^i b^j c^{k+1}] = 0$  unless  $j = i + k + 3$ . In this case,  $[d^{i+1} b^j c^{k+1}]$  is proportional to  $[d^{i+1} b^{i+3}]$ , which is zero. Finally  $[d^{i+1} b^{j+1}] = 0$  for all  $i, j$ .  $\square$

We now pass to the braided Hopf algebra  $B = B(A)$ . We define new generators

$$u = d, \quad x = qb, \quad y = qc, \quad z = \frac{qa - qd}{q + q^{-1}}$$

Using (17, 18, 19) we have the braided Hopf algebra structure (we drop the “\*” notation for the product)

$$\begin{aligned}ux &= q^2 xu, \quad uy = q^{-2} yu, \quad xy = u^2 + (1 + q^{-2})uz - 1, \quad zu = uz, \\ yx &= u^2 + (1 + q^2)uz - 1, \quad zx = xz + (1 - q^2)xu, \quad zy = yz + (1 - q^{-2})yu \\ \Delta(u) &= u \otimes u + q^{-2} y \otimes x, \quad \Delta(x) = x \otimes u + u \otimes x + (1 + q^{-2})z \otimes x \\ \Delta(y) &= y \otimes u + u \otimes y + (1 + q^{-2})y \otimes z \\ \Delta(z) &= z \otimes u + u \otimes z + (1 + q^{-2})z \otimes z + (1 + q^{-2})^{-1}[x \otimes y - y \otimes x] \\ \underline{S}(u) &= u + (1 + q^2)z, \quad \underline{S}(x) = -q^2 x, \quad \underline{S}(y) = -q^2 y, \quad \underline{S}(z) = -q^2 z \\ \varepsilon(u) &= 1, \quad \varepsilon(x) = \varepsilon(y) = \varepsilon(z) = 0\end{aligned} \tag{21}$$

Further, we note that  $t := u + z = \frac{qa + q^{-1}d}{q + q^{-1}}$  is a central element.  $B$  is  $\mathbb{Z}$ -graded with  $x, y$  having degree 1, -1, and  $u, z$  having degree zero. Using this and the commutation relations gives that

$$e_{ijk} := \begin{cases} x^i u^j z^k & : i \geq 0 \\ y^i u^j z^k & : i \leq 0 \end{cases} \quad j, k \in \mathbb{N}$$

is a vector space basis of  $B$ . The braiding (19), which for convenience we denote by  $\Psi$  rather than  $\Psi_B$ , is given by:

$$\begin{aligned}
\Psi(x \otimes x) &= q^2 x \otimes x, & \Psi(x \otimes y) &= q^{-2} y \otimes x, & \Psi(x \otimes z) &= z \otimes x, & \Psi(x \otimes u) &= u \otimes x \\
\Psi(y \otimes x) &= q^{-2} x \otimes y + (1 - q^{-2})f(2) y \otimes x - (1 + q^{-2})f(2) z \otimes z \\
\Psi(y \otimes y) &= q^2 y \otimes y, & \Psi(y \otimes z) &= z \otimes y + f(2)y \otimes z, & \Psi(y \otimes u) &= u \otimes y - f(2)y \otimes z \\
\Psi(z \otimes x) &= x \otimes z + f(2)z \otimes x, & \Psi(z \otimes y) &= y \otimes z \\
\Psi(z \otimes z) &= z \otimes z + (q^{-2} - 1)y \otimes x, & \Psi(z \otimes u) &= u \otimes z + (1 - q^{-2})y \otimes x \\
\Psi(u \otimes x) &= x \otimes u - f(2)z \otimes x, & \Psi(u \otimes y) &= y \otimes u, & \Psi(u \otimes z) &= z \otimes u + (1 - q^{-2})y \otimes x, \\
\Psi(u \otimes u) &= u \otimes u + (q^{-2} - 1)y \otimes x
\end{aligned} \tag{22}$$

where  $f(n) = q^n - q^{-n}$ . It follows that  $(\text{id} \otimes \underline{S})\Psi = \Psi(\underline{S} \otimes \text{id})$ ,  $(\underline{S} \otimes \text{id})\Psi = \Psi(\text{id} \otimes \underline{S})$ .

**Lemma 6.3** *There are precisely two ribbon automorphisms  $\sigma_{\pm}$  of  $B$ , given by*

$$\sigma_{\pm}(u) = \pm[u + (1 - q^4)z], \quad \sigma_{\pm}(x) = \pm q^4 x, \quad \sigma_{\pm}(y) = \pm q^4 y, \quad \sigma_{\pm}(z) = \pm q^4 z \tag{23}$$

(this implies  $\sigma_{\pm}(t) = \pm t$ ) equivalently by

$$\sigma_{\pm}(a) = \pm[q^2 a + (1 - q^2)d], \quad \sigma_{\pm}(b) = \pm q^4 b, \quad \sigma_{\pm}(c) = \pm q^4 c, \quad \sigma_{\pm}(d) = \pm[(q^2 - q^4)a + \frac{(q^6 + 1)}{q^2 + 1}d]$$

*Proof.* Demanding compatibility of  $\sigma$  with the defining relations, for example

$$0 = \sigma(xy - yx + (q^2 - q^{-2})uz) = \mu(\sigma \otimes \sigma)[x \otimes y - y \otimes x + (q^2 - q^{-2})z \otimes u]$$

gives  $\sigma(x) = \lambda_1 x$ ,  $\sigma(y) = \lambda_2 y$ ,  $\sigma(z) = \varepsilon q^4 z$ ,  $\sigma(u) = \varepsilon[u + (1 - q^4)z]$ , where  $\varepsilon = \pm 1$  and  $\lambda_1 \lambda_2 = q^8$ . Compatibility with the braiding forces  $\lambda_1 = \lambda_2 = \varepsilon q^4$ , hence the result.  $\square$

It is natural to require that the ribbon automorphism becomes the identity in the classical limit  $q = 1$ , which imposes  $\varepsilon = 1$ . Hence we work with the ribbon automorphism  $\sigma = \sigma_+$ . The ground field  $\mathbb{C}$  becomes a left  $B$ -module through the character  $\varepsilon$ . It is easy to check that:

**Lemma 6.4** *The following is a resolution of  $\mathbb{C}$  by free left  $B$ -modules:*

$$0 \longrightarrow B \xrightarrow{\varphi_3} B^3 \xrightarrow{\varphi_2} B^3 \xrightarrow{\varphi_1} B \xrightarrow{\varphi_0} \mathbb{C} \longrightarrow 0. \tag{24}$$

where  $\varphi_0(a) = \varepsilon(a)$ ,  $\varphi_1(a, b, c) = ax + by + c(u - 1)$ ,  $\varphi_3(a) = a(y, -q^2 x, u - 1)$  and

$$\varphi_2(a, b, c) = (a, b, c) \begin{pmatrix} q^{-2}u & 0 & -x \\ 0 & q^2 u - 1 & -y \\ -y & q^2 x & (1 - q^2)(u + 1) \end{pmatrix}$$

Given the resolution, we can compute braided Hochschild homology, giving a ‘‘no dimension drop’’ result along the lines of [4, 14, 15, 16]:

**Theorem 6.5** *For the braiding (22) and  $\sigma = \sigma_+$  (23),  $H_3^{\Psi, \sigma}(B, B) \cong \mathbb{C}$ .*

*Proof.* Tensoring (24) on the left by  $R(B) \otimes_B -$  gives

$$H_3^{\Psi, \sigma}(B, B) = \ker\{\text{id} \otimes \varphi_3 : R(B) \otimes_B B \rightarrow R(B) \otimes_B B^3\} = \ker\{\tilde{\varphi} : B \rightarrow B^3\}$$

where  $\tilde{\varphi}(a) = (a \triangleleft y, -q^2 a \triangleleft x, a \triangleleft (u-1))$ . To compute the right action  $\triangleleft$  (13) of  $x, y, u$  on PBW monomials  $a = x^i u^j z^k, y^i u^j z^k$ , we need to compute the braidings  $\Psi(a \otimes t)$  for  $t = x, y, u$ . Lengthy but straightforward calculations give the formulae:

$$\begin{aligned}\Psi(x^i u^j z^k \otimes y) &= q^{-2i} y \otimes x^i u^j z^k, & \Psi(y^i u^j z^k \otimes y) &= q^{2i} y \otimes y^i u^j z^k, \\ \Psi(x^i u^j z^k \otimes u) &= u \otimes x^i u^j z^k + q^{-2i} y \otimes x^i [q^{-2} x u^{j-1} z^k - u^{j-1} z^k x] \\ \Psi(y^i u^j z^k \otimes u) &= u \otimes y^i u^j z^k + (1 - q^{2i}) y \otimes y^{i-1} u^j z^k [(1 + q^{-2})z + (q^{-2} - q^{-2i})u] \\ &\quad + q^{2i} y \otimes y^i u^{-1} [x u^j z^k - u^j z^k x]\end{aligned}$$

where  $u^{-1}[x u^j z^k - u^j z^k x]$  is notational shorthand for

$$q^{-2} x u^{j-1} z^k - u^{j-1} z^k x = q^{-2} x u^{j-1} [z^k - q^{2j} (z + (1 - q^2)u)^k]$$

which is well-defined even for  $j = 0$ , being in this case equal to  $-q^{-2} \sum_{l=1}^k \binom{k}{l} (1 - q^2)^{k-l} x z^l u^{k-l-1}$ , with the empty sum ( $k = 0$ ) being taken to be zero. Furthermore,

$$\sigma_{\underline{S}^{-1}}(u) = u + (1 + q^2)z, \quad \sigma_{\underline{S}^{-1}}(x) = -q^2 x, \quad \sigma_{\underline{S}^{-1}}(y) = -q^2 y, \quad \sigma_{\underline{S}^{-1}}(z) = -q^2 z$$

It follows that the actions of  $u$  and  $y$  on PBW monomials are:

$$\begin{aligned}x^i u^j z^k \triangleleft u &= q^{-2i} x^i u^j z^k, & y^i u^j z^k \triangleleft u &= q^{2i} y^i u^j z^k \\ y^i u^j z^k \triangleleft y &= (q^2 - q^{2i})(1 - q^{-4i}) y^i u^{j+1} z^k y + q^{2i} y^i u^{-1} [u^j z^k y - y u^j z^k]\end{aligned}$$

Therefore  $a \triangleleft (u-1) = 0$  if and only if  $a = \sum \alpha_{j,k} u^j z^k$ , for some  $\alpha_{j,k} \in \mathbb{C}$ . Now,

$$u^j z^k \triangleleft y = u^{j-1} z^k y - q^2 y u^{j-1} z^k = q^2 y u^{j-1} [q^{-2j} (z + (1 - q^{-2})u)^k - z^k]$$

Hence  $(\sum \alpha_{j,k} u^j z^k) \triangleleft y = 0$  if and only if  $\alpha_{j,k} = 0$  for  $(j, k) \neq (0, 0)$ . So  $a \triangleleft (u-1) = 0 = a \triangleleft y$  if and only if  $a = \lambda 1$ . Finally it is easy to check that  $1 \triangleleft x = 0$ . Hence  $\ker(\tilde{\varphi}) = \mathbb{C}[1]$ .  $\square$

## 7 Acknowledgements

We both thank Shahn Majid for very useful discussions, and the Isaac Newton Institute, Cambridge for hosting us during the time this work was completed. We also thank the referee for their careful reading of the paper and many useful comments and suggestions. T.H. thanks the EPSRC for their support via a Postdoctoral Fellowship, Katedra Metod Matematycznych Fizyki, Uniwersytet Warszawski for its support via EU Transfer of Knowledge contract MKTD-CT-2004-509794, and Instytut Matematyczny, Polska Akademia Nauk for their hospitality. He also thanks the School of Mathematical Sciences, Queen Mary, University of London for their support. U.K. thanks the EU for support via Marie Curie EIF 515-144 and the EPSRC for support via EP/E/043267/1.

## References

- [1] Akrami, S. E., Majid, S.: Braided cyclic cocycles and non-associative geometry. *J. Math. Phys.* **45**, no. 10, 3883-3911 (2004).
- [2] Baez, J.: Hochschild homology in a braided tensor category. *Trans. AMS*, **344**, no. 2, 885-906 (1994).
- [3] Beggs, E., Majid, S.: Semiclassical differential structures. *Pacific J. Math.* **224**, no. 1, 1-44 (2006).

- [4] Brown, K. A., Zhang, J. J.: Dualising complexes and twisted Hochschild (co)homology for noetherian Hopf algebras. To appear in *J. Algebra*, arXiv:math.RA/0603732 (2006).
- [5] Cartan, H., Eilenberg, S.: *Homological algebra*, Princeton University Press, Princeton, N. J. (1956).
- [6] Chari, S., Pressley, A.: *A guide to quantum groups*, Cambridge University Press, 1996
- [7] Connes, A.: Cohomologie cyclique et foncteurs  $\text{Ext}^n$ . *C. R. Acad. Sci. Paris Sér. I*, **296**, no. 23, 953-958 (1983)
- [8] Connes, A.: Noncommutative differential geometry. *Inst. Hautes Études Sci. Publ. Math.* **62**, 257-360 (1985).
- [9] Dijkgraaf, R., Pasquier, V., Roche, P.: Quasi Hopf algebras, group cohomology, and orbifold models. *Nuclear Phys. B* **18B**, 60-72 (1990).
- [10] Doi, Y., Takeuchi, T.: Multiplication alteration by two-cocycles. *Comm. Algebra* **22**, no. 14, 5715-32. (1994).
- [11] Drinfeld, V. G.: On almost cocommutative Hopf algebras. (Russian) *Algebra i Analiz* **1**, no. 2, 30-46 (1989); translation in *Leningrad Math. J.* **1**, no. 2, 321-342 (1990).
- [12] Feng, P., Tsygan, B.: Hochschild and cyclic homology of quantum groups. *Comm. Math. Phys.* **140**, no. 3, 481-521 (1991).
- [13] Getzler, E., Jones, J.D.S.: The cyclic homology of crossed product algebras, *J. Reine Angew. Math.* **445**, 161-174 (1993).
- [14] Hadfield, T.: Twisted cyclic homology of all Podleś quantum spheres. *J. Geom. Phys.*, **57**, no. 2, 339-351 (2007).
- [15] Hadfield, T., Krähmer, U.: Twisted homology of quantum  $\text{SL}(2)$ . *K-theory*, **34**, no. 4, 327-360 (2005).
- [16] Hadfield, T., Krähmer, U.: On the Hochschild homology of quantum  $\text{SL}(N)$ . *C. R. Acad. Sci. Paris, Ser. I* **343**, 9-13 (2006).
- [17] Hayashi, T.: Coribbon Hopf (Face) algebras generated by lattice models. *J. Algebra* **233**, 614-641 (2000).
- [18] Hodges, T. J.: Double quantum groups and Iwasawa decomposition, *J. Algebra* **192**, no. 1, 303-325 (1997).
- [19] Kassel, C.: *Quantum groups*, Springer-Verlag 1995.
- [20] Klimyk, A., Schmüdgen, K.: *Quantum groups and their representations*. Springer 1997.
- [21] Korogodski, L., Soibelman, Y. S.: *Algebras of functions on quantum groups : part I. Mathematical Surveys and Monographs* **56**, Amer. Math. Soc., Providence, RI (1998).
- [22] Kustermans, J., Murphy, G. J., Tuset, L.: Differential calculi over quantum groups and twisted cyclic cocycles. *J. Geom. Phys.* **44**, no. 4, 570-594 (2003).
- [23] Loday, J. L.: *Cyclic homology. Grundlehren der mathematischen Wissenschaften* **301**, Springer-Verlag 1998.
- [24] Majid, S.: *Foundations of Quantum Group Theory*. Cambridge University Press 2000.
- [25] Neshveyev, S., Tuset, L.: Notes on the Kazhdan-Lusztig theorem on equivalence of the Drinfeld category and the category of  $U_q(\mathfrak{g})$ -modules, arXiv:0711.4302



- [26] Runkel, I., Fjelstad, J., Fuchs, J., Schweigert, C.: Topological and conformal field theory as Frobenius algebras, *Contemp. Math.*, **431**, 225-248 (2007).
- [27] Sitarz, A.: Twisted Hochschild homology of quantum hyperplanes. *K-theory*, **35**, no. 1-2, 187-198 (2005).