

Alexandrov's theorem, weighted Delaunay triangulations, and mixed volumes

Alexander I. Bobenko* Ivan Izvestiev*

February 2, 2008

Abstract

We present a constructive proof of Alexandrov's theorem regarding the existence of a convex polytope with a given metric on the boundary. The polytope is obtained as a result of a certain deformation in the class of generalized convex polytopes with the given boundary. We study the space of generalized convex polytopes and discover a relation with the weighted Delaunay triangulations of polyhedral surfaces. The existence of the deformation follows from the non-degeneracy of the Hessian of the total scalar curvature of a positively curved generalized convex polytope. The latter is shown to be equal to the Hessian of the volume of the dual generalized polyhedron. We prove the non-degeneracy by generalizing the Alexandrov-Fenchel inequality. Our construction of a convex polytope from a given metric is implemented in a computer program.

1 Introduction

In 1942 A.D.Alexandrov [2] proved the following remarkable theorem:

Theorem 1 *Let M be a sphere with a convex Euclidean polyhedral metric. Then there exists a convex polytope $P \subset \mathbb{R}^3$ such that the boundary of P is isometric to M . Besides, P is unique up to a rigid motion.*

Here is the corresponding definition.

Definition 1.1 *A Euclidean polyhedral metric on a surface M is a metric structure such that any point $x \in M$ possesses an open neighborhood U with*

*Institut für Mathematik, Technische Universität Berlin, Str. des 17. Juni 136, 10623 Berlin, Germany; bobenko@math.tu-berlin.de, izvestiev@math.tu-berlin.de

Research for this article was supported by the DFG Research Unit 565 "Polyhedral Surfaces".

one of the two following properties. Either U is isometric to a subset of \mathbb{R}^2 , or there is an isometry between U and an open subset of a cone with angle $\alpha \neq 2\pi$ such that x is mapped to the apex. In the first case x is called a regular point, in the second case it is called a singular point of M . The set of singular points is denoted by Σ .

If for any $x \in \Sigma$ the angle at x is less than 2π , then the Euclidean polyhedral metric is said to be convex.

For brevity we usually write convex polyhedral metric omitting the word Euclidean.

The polytope P in Theorem 1 may be a plane convex polygon. In this case the boundary of P consists of two copies of this polygon identified along the boundary.

The metric on the boundary of a convex polytope is an example of a convex polyhedral metric on the sphere. The only singular points are the vertices of the polytope, because any point in the interior of an edge possesses a Euclidean neighborhood. The intrinsic metric of the boundary of a polytope does not distinguish the edges.

In practice, one specifies a polyhedral metric on the sphere by taking a collection of polygons, identifying them along some pairs of edges. Alexandrov calls this representation a development, in analogy with developments of polytopes. By Theorem 1, from any development with cone angles less than 2π a convex polytope can be built. However, the edges of this polytope can differ from the edges of the development. To see this, one can take a ready-made polytope and cut it into plane pieces by geodesics different from the edges of the polytope. For a given development it is a hard problem to determine the edges of the corresponding polytope.

If a development and the true edges of the polytope are known, then the problem of constructing the polytope is still non-trivial, and is studied in [10] using polynomial invariants.

The uniqueness part of Theorem 1 can be proved by a modification of Cauchy's proof of global rigidity of convex polytopes. The original existence proof by Alexandrov [2], [3] is more involved and non-constructive. Alexandrov in [3, pp. 320–321] discusses a possibility for a constructive proof.

Alexandrov's theorem is closely related to the following problem posed by Hermann Weyl in [26]: *Prove that any Riemannian metric of positive Gaussian curvature on the sphere can be realized as the metric of the boundary of a unique convex body in \mathbb{R}^3 .* Alexandrov in [2] applied Theorem 1 to solve Weyl's problem for the metric of class C^2 through approximation by convex polyhedral metrics. The usual approach to Weyl's problem through a PDE was realized by Nirenberg [17].

An interesting remark regarding Weyl's problem was made by Blaschke and Herglotz in [5]. Consider all possible extensions of the given Riemannian metric on the sphere to a Riemannian metric inside the ball. On the space

of such extensions take the total scalar curvature functional, also known as the Einstein-Hilbert action. It turns out that its critical points correspond to Euclidean metrics in the interior of the ball. It is not clear how to use this observation to solve Weyl's problem since the functional is not convex.

Since Alexandrov's theorem is a discrete version of Weyl's problem, one can try to discretize the Blaschke-Herglotz approach. The discrete analog of the Einstein-Hilbert action is known as the Regge action. If simplices of a triangulated closed 3-manifold are equipped with Euclidean structures, then the Regge action [19] is defined as

$$\sum_e \ell_e \kappa_e. \tag{1}$$

Here the sum ranges over all edges of the triangulation, ℓ_e is the length of the edge e , and κ_e is the angle deficit, also called curvature.

This way to discretize the total scalar curvature was also known to Volkov, a student of Alexandrov. In [24] (translated and reprinted as [3, Section 12.1]), he applies it to study the dependence of the extrinsic metric of a convex polytope on the intrinsic metric on its boundary. Volkov in his PhD of 1955 also gives a new proof of Alexandrov's theorem. It proceeds by extending the metric to a polyhedral metric in the ball in a special way and minimizing the sum of edge lengths over all such extensions. The discrete total scalar curvature functional is not used in the proof. Volkov's proof can be found in [25]. See also Zalgaller's remark in [3, pp. 504–505].

In this paper we investigate the total scalar curvature functional (1) and give a new proof of Alexandrov's theorem based on the properties of this functional.

Let us sketch our proof.

A *generalized polytope* is a simplicial complex glued from pyramids over triangles of some geodesic triangulation T of M . Vertices $i \in \mathcal{V}(T)$ of T are singularities of M ; edges $ij \in \mathcal{E}(T)$ are geodesic arcs. A generalized polytope can be described by a couple (T, r) , where $r = (r_i)_{i \in \Sigma}$ are lengths of the side edges of the pyramids. A *generalized convex polytope* is a generalized polytope with all of the dihedral angles θ_{ij} at the boundary edges less or equal to π . In Section 2 we show that for any r there is at most one generalized convex polytope and describe the space of all generalized convex polytopes with boundary M .

In Section 3 we study the total scalar curvature of generalized convex polytopes:

$$H(P) = \sum_{i \in \mathcal{V}(T)} r_i \kappa_i + \sum_{ij \in \mathcal{E}(T)} \ell_{ij} (\pi - \theta_{ij}),$$

where κ_i is the curvature at the i -th radial edge, and ℓ_{ij} is the length of the boundary edge joining the vertices i and j . The main result of Section 3 is

the non-degeneracy of the Hessian of H if

$$0 < \kappa_i < \delta_i \quad \text{for every } i. \quad (2)$$

Here δ_i is the angle deficit at the i -th singularity of the metric of M .

Section 4 contains the proof of Alexandrov's theorem. The idea is to start with a certain generalized convex polytope over M and deform it into a convex polytope. As the starting point we take the generalized polytope (T_D, r) , where T_D is the Delaunay triangulation of M , and $r_i = R$ for every i , with a sufficiently large R . We show that this generalized polytope is convex and satisfies condition (2). In order to show that any small deformation of the curvatures κ_i can be achieved by a deformation of radii r_i it suffices to prove the non-degeneracy of the Jacobian $\left(\frac{\partial \kappa_i}{\partial r_j}\right)$. Here the functional H comes into play since

$$\frac{\partial \kappa_i}{\partial r_j} = \frac{\partial^2 H}{\partial r_i \partial r_j}.$$

We deform κ_i by the rule

$$\kappa_i(t) = t \cdot \kappa_i, \quad (3)$$

where t goes from 1 to 0. In particular, condition (2) remains valid during the deformation. We show that when r is changed according to (3), the generalized convex polytope does not degenerate. In the limit at $t \rightarrow 0$ we get a convex polytope with boundary M .

A new proof of Alexandrov's theorem is not the only result of this paper. Coming across *weighted Delaunay triangulations* and *mixed volumes* while studying the total scalar curvature functional was a big surprise for us. In Section 2 we give a new geometric interpretation of weighted Delaunay triangulations through generalized convex polytopes. Also, for a given polyhedral surface with marked points, we explicitly describe the space of weights of weighted Delaunay triangulations. Further, we show that a weighted Delaunay triangulation with given weights can be obtained via a flip algorithm.

In Section 3 for any generalized convex polytope P we define its dual generalized convex polyhedron P^* . We find a surprising relation between the total scalar curvature of P and the volume of P^* :

$$\frac{\partial^2 H}{\partial r_i \partial r_j}(P) = \frac{\partial^2 \text{vol}}{\partial h_i \partial h_j}(P^*). \quad (4)$$

Here the h_i 's are the altitudes of P^* , see Subsection 3.2. We prove that the Hessian of $\text{vol}(P^*)$ is non-degenerate if the curvatures satisfy (2). The proof uses the theory of mixed volumes: we generalize the classical approach [23] to the Alexandrov-Fenchel inequalities. Note that mixed volumes here play a role similar to that in the variational proof of Minkowski's theorem, see [3, Section 7.2].

The proof of Alexandrov’s theorem presented in this paper provides a numerical algorithm that constructs a convex polytope from a given development. This algorithm was implemented by Stefan Sechelmann, the program is available at <http://www.math.tu-berlin.de/geometrie/ps/>. Examples of surfaces constructed with the help of this program are shown in Figure 1. Two convex polygons A and B of the same perimeter identified isometrically along the boundary produce a convex polyhedral metric on the sphere. In the limit, A and B can be any two convex plane figures. The resulting convex body in \mathbb{R}^3 is the convex hull of a space curve that splits its boundary into two regions with Euclidean metric. This construction was communicated to us by Johannes Wallner.

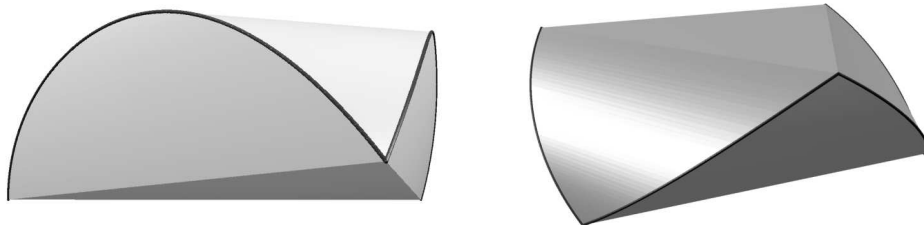

Figure 1: Convex surfaces glued from two Euclidean pieces identified along the boundary. *Left:* Disc and equilateral triangle. *Right:* Two Reuleaux triangles (triangles of constant width); the vertices of one are identified with the midpoints of the sides of the other.

There exist numerous generalizations of Alexandrov’s theorem: to surfaces of arbitrary genus, to hyperbolic and spherical polyhedral metrics, to singularities of negative curvature (see [11] and references therein). Perhaps our approach can be generalized to these cases.

Note that in our proof we use a special deformation of the metric implicitly described by the evolution (3) of the curvature. It would be interesting to find a smooth analog of the flow (3) and clarify whether it can be applied to Weyl’s problem.

2 Generalized convex polytopes and weighted Delaunay triangulations

In this section we introduce the notion of a generalized convex polytope. A generalized convex polytope is a ball equipped with a Euclidean polyhedral metric that has a convex boundary and a unique interior vertex. For a fixed Euclidean polyhedral metric M on the sphere, we consider the space $\mathcal{P}(M)$ of all generalized convex polytopes with boundary M . Our goal here is to introduce coordinates on $\mathcal{P}(M)$ and to describe its boundary. We also discover a connection between generalized convex polytopes and weighted Delaunay

triangulations of a sphere with a Euclidean polyhedral metric. This leads to an explicit description of the space of weighted Delaunay triangulations.

2.1 Geodesic triangulations

Let M be a closed surface with a Euclidean polyhedral metric with a non-empty singular set Σ . A *geodesic triangulation* T of M is a decomposition of M into Euclidean triangles by geodesics with endpoints in Σ . By $\mathcal{V}(T)$, $\mathcal{E}(T)$, $\mathcal{F}(T)$ we denote the sets of vertices, edges, and faces of T , respectively. By definition, $\mathcal{V}(T) = \Sigma$. Note that in $\mathcal{E}(T)$ there may be multiple edges as well as loops. Triangles of $\mathcal{F}(T)$ may have self-identifications on the boundary.

Singularities of M are denoted by letters i, j, k, \dots . An edge of T with endpoints i and j is denoted ij , a triangle with vertices i, j, k is denoted ijk . Note that different edges or triangles can have the same name and letters in a name may repeat.

It is not hard to show that for any M there is a geodesic triangulation T . In the case when M is a sphere with all singularities of positive curvature, this is proved in [3, Section 4.1, Lemma 2]. Below, examples of geodesic triangulations are given.

Take two copies of a euclidean triangle and identify them along the boundary. The space obtained is a geodesically triangulated sphere with a Euclidean polyhedral metric. There are other geodesic triangulations of the same surface. Namely, remove from the triangulation a side of the triangle that forms acute angles with two other sides and draw instead a geodesic loop based at the opposite vertex (the loop is formed by two copies of the corresponding altitude of the triangle).

Let M be the boundary of a cube. Take two opposite faces and subdivide each of them by a diagonal. The remaining four faces form a cylinder, both ends of which contain four points from Σ . There are infinitely many geodesic triangulations of the cylinder with vertices in Σ .

2.2 Generalized convex polytopes

Let T be a geodesic triangulation of M . Let $r = (r_1, \dots, r_n)$ be a collection of positive numbers, called radii, subject to the condition that for every triangle $ijk \in \mathcal{F}(T)$ there exists a pyramid with base ijk and lengths r_i, r_j, r_k of side edges. The generalized polytope defined by the couple (T, r) is a polyhedral complex glued from these pyramids following the gluing rules in the triangulation. As a consequence, the apices of all pyramids are glued to one point which we call the apex of the generalized polytope and denote by a .

In a generalized polytope consider the interior edge that joins the apex to the vertex i . Denote by ω_i the sum of the dihedral angles of pyramids at this

edge. If for some i we have $\omega_i \neq 2\pi$, then the generalized polytope cannot be embedded into \mathbb{R}^3 and has to be considered as an abstract polyhedral complex. The quantity

$$\kappa_i = 2\pi - \omega_i$$

is called the *curvature* at the corresponding edge. Further, for every boundary edge $ij \in \mathcal{E}(T)$ of the generalized polytope denote by θ_{ij} the sum of the dihedral angles of pyramids at this edge.

Definition 2.1 *A generalized polytope with boundary M is an equivalence class of couples (T, r) as above, where two couples are equivalent if and only if there is an isometry between the resulting polyhedra which is identical on the boundary and maps the apex to the apex. A generalized convex polytope is a generalized polytope such that $\theta_{ij} \leq \pi$ for any edge $ij \in \mathcal{E}(T)$ in some (and hence in any) associated triangulation T .*

For brevity, we sometimes use the word polytope when talking about generalized convex polytopes. Here are two important examples.

It is not hard to show that a generalized convex polytope with $\kappa_i = 0$ for all i embeds into \mathbb{R}^3 and thus produces a classical convex polytope. Conversely, take a convex polytope in \mathbb{R}^3 , triangulate its non-triangular faces without adding new vertices, and choose a point in its interior. The triangulation of the boundary and the distances from the chosen point to the vertices provide us with a couple (T, r) . Another couple (T', r) representing the same generalized convex polytope can be obtained by choosing other triangulations of non-triangular faces. In contrast, a different choice of an interior point as the apex leads to a different generalized polytope.

For any triangulation T take an $R > 0$ and put $r_i = R$ for every $i \in \mathcal{V}(T)$. If R is large enough, then over every triangle ijk there exists an isosceles pyramid with all side edges of length R . Thus (T, r) defines a generalized polytope. It is convex if and only if T is a Delaunay triangulation of M , see Definition 2.3 or [6]. This is a special case of Theorem 2 or can be shown directly by a geometric argument similar to the proof of Lemma 2.1.

In our proof of Alexandrov's theorem we take a polytope from the second example and deform it by changing the radii and keeping the boundary M fixed to a polytope from the first example. The explanation why this is possible is rather involved and is based on the analysis of some unexpected connections to the theory of mixed volumes.

2.3 A generalized convex polytope is determined by its radii

We start our study of the space

$$\mathcal{P}(M) := \{\text{generalized convex polytopes with boundary } M\}. \quad (5)$$

We have

$$\mathcal{P}(M) = \bigcup_T \mathcal{P}^T(M),$$

where $\mathcal{P}^T(M)$ consists of those generalized convex polytopes that have a representative of the form (T, r) for the given T . The map $(T, r) \mapsto r$ defines an embedding of $\mathcal{P}^T(M)$ into \mathbb{R}^n , where $n = |\Sigma|$. In this subsection we show that this map is injective on $\mathcal{P}(M)$ that is, for a given assignment of radii there is at most one generalized convex polytope.

Proposition 1 *Suppose that $P, P' \in \mathcal{P}(M)$ are two generalized convex polytopes represented by the couples (T, r) and (T', r') , respectively. Then $r = r'$ implies $P = P'$.*

We introduce some technical notions that are used in the proof of this proposition.

Let us call a *Q-function* any function of the form

$$x \mapsto \|x - a\|^2 + b$$

on a subset of a Euclidean space \mathbb{R}^m . Here $a \in \mathbb{R}^m$ and $b \in \mathbb{R}$. A *PQ-function* on M is a continuous function which is a *Q-function* on each triangle of some geodesic triangulation. To define a *Q-function* on a triangle of T one develops this triangle onto the plane. By Pythagoras theorem, the restriction of a *Q-function* to a Euclidean subspace is a *Q-function* on this subspace. Similarly, the restriction of a *PQ-function* on M to a geodesic arc is a *PQ-function* of the arc length. We call a *PQ-function* *Q-concave* iff on each geodesic arc it becomes concave after subtracting the squared arc length. The difference of any two *Q-functions* is a linear function, so after subtracting the squared arc length we always obtain a piecewise linear function on a geodesic.

A *PQ-function* can be spelled out as piecewise quadratic function, and *Q-concave* as quasiconcave.

Definition 2.2 *Let T be a geodesic triangulation of M , and let r be an assignment of positive numbers to the vertices of T . Define the function*

$$q_{T,r} : M \rightarrow \mathbb{R}$$

as the PQ-function that takes value r_i^2 at the i -th singularity of M , and that is a Q-function on every triangle of T .

Lemma 2.1 *A couple (T, r) represents a generalized convex polytope if and only if $q_{T,r}$ is a positive Q-concave PQ-function.*

Proof. Let (T, r) represent a generalized convex polytope. It is immediate that the function $q_{T,r}$ is the squared distance from the apex. Therefore it is a positive PQ -function. To show that it is Q -concave, it suffices to consider a short geodesic arc crossing an edge $ij \in \mathcal{E}(T)$. Take the adjacent triangles ijk and ijl and develop them onto the plane. We get a quadrilateral $ikjl$. Choose a point $a \in \mathbb{R}^3$ such that $\|a - i\| = r_i$, $\|a - j\| = r_j$, and $\|a - k\| = r_k$. We claim that $\|a - l\| \geq r_l$. To see this, compare the pyramid over $ikjl$ with the union of two corresponding pyramids in the polytope, and use the fact that r_l is a monotone increasing function of θ_{ij} , for constant r_i, r_j, r_k . Consider the function $q_{T,r}(x) - \|x - a\|^2$ on the quadrilateral. It is a piecewise linear function that is identically 0 on the triangle ijk and non-positive at l . Therefore it is concave, which implies Q -concavity of $q_{T,r}$ on any short geodesic arc across ij . The left to right implication is proved. Note that any of the vertices i, j, k, l may coincide, and even triangles ijk and ijl may be two copies of the same triangle.

Now let (T, r) be any couple such that $q_{T,r}$ is positive and Q -concave. Put $r_i = \sqrt{q_{T,r}(i)}$ for every i . Let us show that for every triangle $ijk \in \mathcal{F}(T)$ there exists a pyramid over it with side edge lengths r_i, r_j, r_k . Develop the triangle ijk and extend the function $q_{T,r}$ from it to a Q -function ext_{ijk} on the whole plane. The desired pyramid exists if and only if ext_{ijk} is positive everywhere on \mathbb{R}^2 : the minimum value of the function is the square of the pyramids altitude, the point of minimum is the projection of the apex. So assume that there is a point $y \in \mathbb{R}^2$ such that $\text{ext}_{ijk}(y) \leq 0$. Join y with some point x inside the triangle ijk by a straight segment. Now take the corresponding geodesic arc on M , which is possible for x and y in general position. Inside the triangle ijk we have $q_{T,r} = \text{ext}_{ijk}$. It follows from the Q -concavity of $q_{T,r}$ that $q_{T,r}(y) \leq 0$. This contradiction shows that there is a generalized polytope corresponding to the couple (T, r) . The proof that it is convex literally follows the argument from the first part of the proof. \square

Proof of Proposition 1. Let us show that a generalized convex polytope is determined by the function $q_{T,r}$:

$$(T, r) \sim (T', r') \Leftrightarrow q_{T,r} = q_{T',r'}. \quad (6)$$

The implication from the left to the right is obvious. To prove the inverse implication, consider a common geodesic subdivision T'' of T and T' , where T'' is allowed to have vertices outside Σ . This yields decompositions of the both generalized polytopes (T, r) and (T', r') into smaller pyramids. The equality $q_{T,r} = q_{T',r'}$ implies that the pyramids over same triangle of T'' in both decompositions are equal.

Now it suffices to show that if for some r there are two triangulations T and T' such that both functions $q_{T,r}$ and $q_{T',r}$ are Q -concave, then $q_{T,r} = q_{T',r}$.

Take any point $x \in M$. Let $ijk \in \mathcal{F}(T)$ be a triangle that contains x . Since $q_{T,r}$ is a Q -function on ijk , the function $q_{T',r} - q_{T,r}$ is piecewise linear and concave on ijk . Since it vanishes at the vertices, it is non-negative everywhere in ijk . Thus we have $q_{T',r}(x) \geq q_{T,r}(x)$ for any $x \in M$. Similarly, $q_{T,r}(x) \geq q_{T',r}(x)$. Therefore the functions are equal. \square

2.4 The space of generalized convex polytopes

By Proposition 1, radii can be considered as coordinates on the space $\mathcal{P}(M)$ which thus becomes a subset of \mathbb{R}^n . It is more convenient to take squares of radii as coordinates; so in the future we identify $\mathcal{P}(M)$ with its image under the embedding

$$\begin{aligned} \mathcal{P}(M) &\rightarrow \mathbb{R}^n, \\ (T, r) &\mapsto (r_1^2, \dots, r_n^2). \end{aligned} \tag{7}$$

In this subsection we derive a system of inequalities which describes $\mathcal{P}(M)$.

By Lemma 2.1, we have

$$\mathcal{P}(M) = \{\text{positive } Q\text{-concave } PQ\text{-functions on } M\}.$$

First, we look at a larger space:

$$\mathcal{D}(M) = \{Q\text{-concave } PQ\text{-functions on } M\}.$$

For any map $q : \Sigma \rightarrow \mathbb{R}$ and any geodesic triangulation T of M denote by

$$\widetilde{q}_T : M \rightarrow \mathbb{R}$$

the PQ -extension of q with respect to T . Note that \widetilde{q}_T relates to q as $q_{T,r}$ relates to r^2 . The space $\mathcal{D}(M)$ can be identified with those $q = (q_i)_{i \in \Sigma}$ for which there exists T such that \widetilde{q}_T is Q -concave. By q_i we denote the value $q(i)$.

A Euclidean quadrilateral $ikjl$ in M is a region bounded by simple geodesic arcs ik, kj, jl, li and without singularities in the interior. Any two of the boundary arcs can coincide but cannot intersect. A Euclidean quadrilateral can be developed onto the plane, after resolving possible self-identifications on the boundary. A Euclidean triangle iji arises when there is a closed geodesic based at i that encloses a unique singularity j .

Define the function ext_{ikl} on the quadrilateral $ikjl$ as the Q -function that takes values q_i, q_k, q_l at the respective vertices.

Now we describe the *flip algorithm*. Let ij be an edge in a geodesic triangulation T . If ij is adjacent to two different triangles ijk and ijl , then we have a Euclidean quadrilateral $ikjl$. If $ikjl$ is strictly convex, then we can transform the triangulation T by replacing the diagonal ij through the diagonal kl in $ikjl$. This transformation is called a *flip*. The flip algorithm

in a general setting works as follows. Assume that we have a rule to say for any edge $ij \in \mathcal{E}(T)$ whether ij is “bad” or “good”. The goal is to find a triangulation where all edges are good. Start with an arbitrary triangulation. If there is a bad edge that forms a diagonal of a strictly convex quadrilateral, then flip it. Look for a bad edge in the new triangulation, flip it if possible and so on. If any bad edge can be flipped and flipping bad edges cannot continue infinitely, then the flip algorithm yields a triangulation with only good edges.

Proposition 2 *The set $\mathcal{D}(M)$ is a convex polyhedron which is the solution set of a system of linear inequalities of the form:*

$$q_j \geq \text{ext}_{ikl}(j), \quad (8)$$

$$q_j \geq q_i - \ell_{ij}^2. \quad (9)$$

There is one equation of the form (8) for each Euclidean quadrilateral $ikjl$ with the angle at j greater or equal π , and one equation of the form (9) for each Euclidean triangle iji . By ℓ_{ij} we denote the length of the edge ij .

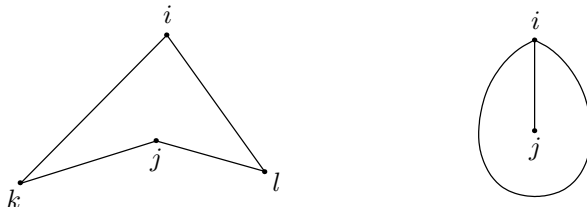

Figure 2: Every non-strongly convex quadrilateral $ikjl$ gives rise to an inequality (8), every triangle iji gives rise to an inequality (9).

Proof. Let us show that the right hand side of (8) is a linear function of q_i, q_k, q_l . Develop $ikjl$ onto the plane. When we vary q_i , the function ext_{ikl} changes by a linear function which vanishes along the line kl . Thus $\text{ext}_{ikl}(j)$ depends linearly on q_i , as well as on q_k and q_l . Moreover, the inequality (8) has the form

$$q_i \geq \lambda q_j + \mu q_k + \nu q_l + c,$$

where $\lambda + \mu + \nu = 1$, $\lambda, \mu, \nu \geq 0$ are barycentric coordinates of j with respect to i, k , and l .

Let us show that conditions (8) and (9) are fulfilled for any assignment $q = (q_i)_{i \in \Sigma}$ that possesses a Q -concave extension \tilde{q} . For (8), consider the function $\tilde{q} - \text{ext}_{ikl}$ on the quadrilateral $ikjl$. It is concave and vanishes at i, k , and l . Hence it is non-negative on the triangle ikl , in particular $q_j - \text{ext}_{ikl}(j) \geq 0$. For (9), consider the function $f(x) = q(x) - \|x - j\|^2$

on the triangle iji . It is geodesically concave and takes values q_j at j and $q_i - \ell_{ij}^2$ at i . Hence $f(x) \geq q_i - \ell_{ij}^2$ for any x on the edge ii . Due to concavity, f is also greater or equal to $q_i - \ell_{ij}^2$ at any regular point of the triangle iji . By continuity, $f(j) \geq q_i - \ell_{ij}^2$.

Now we prove sufficiency of the conditions (8) and (9). Let T be any geodesic triangulation. Call an edge of T *good*, if the function \widetilde{q}_T is Q -concave across this edge, otherwise call an edge *bad*. Our aim is to find a triangulation T with only good edges. Let us show that any bad edge can be flipped. Indeed, if ij is adjacent to only one triangle, then the inequality (9) implies that ij is good. If it is adjacent to two triangles that form a concave or non-strictly convex quadrilateral, then the inequality (8) implies that ij is good. Thus any bad edge is a diagonal of a strictly convex quadrilateral and therefore can be flipped.

Let us show that the flip algorithm terminates. Note that when a bad edge is flipped, the function \widetilde{q}_T increases pointwise. If there are only finitely many geodesic triangulations of M , this suffices. If not, we use the fact that for any C there are only finitely many triangulations of M with all geodesics of length less than C . Thus it suffices to show that no long edges can appear when performing the algorithm. Let T' be a triangulation with an edge ij . Function $\widetilde{q}_{T'}$ restricted to ij has the form $x^2 + ax + b$ and takes values q_i and q_j at the endpoints. There exists a constant C such that if the length of ij is greater than C , the minimum value of $\widetilde{q}_{T'}$ on ij is smaller than $\min_{x \in M} \widetilde{q}_T(x)$. This means that no edge of length greater than C can appear between the vertices i and j if we start the flip algorithm from the triangulation T . \square

Let $\mathcal{D}^T(M)$ be the set of those functions $q \in \mathcal{D}(M)$ which are PQ with respect to the triangulation T . Then we have a decomposition

$$\mathcal{D}(M) = \cup_T \mathcal{D}^T(M). \quad (10)$$

Proposition 3 *For any surface M with a polyhedral metric the polyhedron $\mathcal{D}(M)$ of Q -concave PQ -functions on M has the following properties.*

1. *The origin $0 \in \mathbb{R}^n$ is an interior point of $\mathcal{D}(M)$.*
2. *Put $\mathcal{D}_0(M) = \{q \in \mathcal{D}(M) \mid \sum_i q_i = 0\}$. Then the polyhedron $\mathcal{D}(M)$ is the direct sum*

$$\mathcal{D}(M) = \mathcal{D}_0(M) \oplus L, \quad (11)$$

where L is the one-dimensional subspace of \mathbb{R}^n spanned by the vector $(1, 1, \dots, 1)$. Every $\mathcal{D}^T(M)$ is decomposed in the same way: if $\mathcal{D}_0^T(M) = \{q \in \mathcal{D}^T(M) \mid \sum_i q_i = 0\}$, then $\mathcal{D}^T(M) = \mathcal{D}_0^T(M) \oplus L$.

3. *Every $\mathcal{D}^T(M)$ is a convex polyhedron.*

4. The decomposition (10) is locally finite.

5. For $q \in \mathcal{D}(M)$, let $\tilde{q} : M \rightarrow \mathbb{R}$ denote the Q -concave PQ -extension of q . Then \tilde{q} depends continuously on q in the L^∞ -metric.

Proof. If we put $q_i = 0$ for every i , then all of the inequalities (8) and (9) are fulfilled and are strict. This implies property 1.

Fix a triangulation T . If q is a PQ -function with respect to T , then it is Q -concave across an edge ij if and only if

$$q_l \leq \text{ext}_{ijk}(l), \quad (12)$$

where ijk and ijl are triangles of T . The inequality (12) remains valid if we change all of the q_i 's by the same amount. Thus $D^T(M)$, and also the whole $D(M)$, is invariant under translations along L . This proves property 2.

The set $D^T(M)$ is a convex polyhedron because it is the set of solutions of a linear system (12). This shows 3.

Property 4. means that any bounded subset U in \mathbb{R}^n has a non-empty intersection with only finitely many of the $D^T(M)$'s. For this, it suffices to show that the edge lengths in all of the triangulations T such that $D^T(M) \cap U \neq \emptyset$ are uniformly bounded from above. Fix any triangulation T_0 . For any $q \in U$ consider the functions \tilde{q}_{T_0} and \tilde{q}_T , where T is such that \tilde{q}_T is Q -concave. We have $\tilde{q}_{T_0} \leq \tilde{q}_T$. Since U is bounded, functions \tilde{q}_{T_0} are uniformly bounded from below. Take any edge in T . The values of q at the endpoints of the edge are less or equal $\max_{q \in U, i \in \Sigma} q_i$. This, together with the uniform lower bound on q , implies that the edge cannot be too long.

In every $D^T(M)$, \tilde{q} depends continuously on q . The continuity of $q \mapsto \tilde{q}$ on the whole $\mathcal{D}(M)$ follows from property 4. \square

Proposition 4 *The space $\mathcal{P}(M)$ of convex generalized polytopes with boundary M has the following properties.*

1. The point (C, C, \dots, C) is an interior point of $\mathcal{P}(M)$ for a sufficiently large C .
2. If $q \in \mathcal{P}(M)$ is an interior point of $\mathcal{D}(M)$, then q is an interior point of $\mathcal{P}(M)$ as well.
3. $\mathcal{P}^T(M) = \mathcal{D}^T(M) \cap \{q_i > 0 \forall i \in \mathcal{V}(T)\} \cap \{CM_{ijk} > 0 \forall ijk \in \mathcal{F}(T)\}$, where

$$CM_{ijk} = \begin{vmatrix} 0 & 1 & 1 & 1 & 1 \\ 1 & 0 & q_i & q_j & q_k \\ 1 & q_i & 0 & \ell_{ij}^2 & \ell_{ik}^2 \\ 1 & q_j & \ell_{ij}^2 & 0 & \ell_{jk}^2 \\ 1 & q_k & \ell_{ik}^2 & \ell_{jk}^2 & 0 \end{vmatrix}$$

is the Cayley-Menger determinant.

Proof. Recall that

$$\mathcal{P}(M) = \{q \in \mathcal{D}(M) \mid \tilde{q} > 0\}.$$

By Proposition 3, the point $(q_i = C)$ belongs to $\mathcal{D}(M)$ for any C . Since adding a constant to all of q_i results in adding a constant function to \tilde{q} , for a large C the PQ -extension of $(q_i = C)$ is everywhere positive. That is, $(q_i = C) \in \mathcal{P}(M)$.

By property 5. of Proposition 3, the function \tilde{q} depends continuously on q . Therefore the condition $\tilde{q} > 0$ is an open condition on q . This implies property 2. Also it completes the proof of property 1, since $q_i = C$ is an interior point of $\mathcal{D}(M)$.

Positivity of the Cayley-Menger determinant CM_{ijk} is equivalent to the existence of a pyramid over the triangle ijk with side edges of lengths $\sqrt{q_i}, \sqrt{q_j}, \sqrt{q_k}$. This implies property 3. \square

Note that q is a boundary point of $\mathcal{D}(M)$ if and only if one of the inequalities (8) and (9) becomes an equality. Geometrically this means that a generalized convex polytope P is on the boundary of $\mathcal{P}(M)$ if and only if P has a non-strongly convex face or an isolated vertex. Here by faces of P we mean connected regions in M after erasing flat edges of P .

2.5 Weighted Delaunay triangulations

Here we explain how generalized convex polytopes are related to weighted Delaunay triangulations of polyhedral surfaces.

Definition 2.3 *Let M be a polyhedral surface with singular set Σ . Let $V \supset \Sigma$ be a finite non-empty subset that has at least one point in every boundary component of M . For a function $q : V \rightarrow \mathbb{R}$ and a geodesic triangulation T with $\mathcal{V}(T) = V$ denote by \tilde{q}_T the PQ -extension of q to M with respect to T . A couple (T, q) is called a weighted Delaunay triangulation of (M, V) with weights q if \tilde{q}_T is Q -concave.*

A Delaunay triangulation is a weighted Delaunay triangulation with all weights equal.

Definition 2.4 *A weighted Delaunay tessellation (\overline{T}, q) is obtained from a weighted Delaunay triangulation (T, q) by removing from T all inessential edges. An edge $ij \in \mathcal{E}(T)$ is called inessential if the corresponding function \tilde{q}_T is a Q -function in the neighborhood of any interior point of ij .*

Originally weighted Delaunay triangulations were defined for $V \subset \mathbb{R}^2$, and M the convex hull of V , see [4], [9], [13]. It can be shown that in this case Definition 2.3 is equivalent to the classical one. Weighted Delaunay triangulations of polyhedral surfaces appear in [14], [21]. However, Definition 2.3 seems to be new.

Theorem 2 *If M is the sphere and $V = \Sigma$, then weighted Delaunay tessellations of (M, V) with positive associated functions \widetilde{q}_T are in one-to-one correspondence with generalized convex polytopes with boundary M .*

Proof. This is essentially a reformulation of Lemma 2.1. By (6), generalized convex polytopes with boundary M are in one-to-one correspondence with positive Q -concave PQ -functions on M . To any such function f there canonically corresponds a tessellation of M into regions where f is quadratic. Since the function f is Q -concave, the tessellation together with values of f at Σ as weights is a weighted Delaunay tessellation. \square

Note that a weighted Delaunay triangulation subsumes an assignment of weights to the vertices. If T is a triangulation for which there exist weights q such that (T, q) is a weighted Delaunay triangulation, then T is sometimes called regular or coherent triangulation.

Definition 2.5 *Let M and V be as in Definition 2.3. Define the space of admissible weights $\mathcal{D}(M, V)$ as the set of maps $q : V \rightarrow \mathbb{R}$ such that there exists a weighted Delaunay triangulation of M with weights q .*

Theorem 3 1. *For any (M, V) the space of admissible weights $\mathcal{D}(M, V)$ is a convex polyhedron in \mathbb{R}^V defined by inequalities (8) and (9).*

2. *For any weight $q \in \mathcal{D}(M, V)$ the weighted Delaunay tessellation with weights q is unique.*

3. *A weighted Delaunay triangulation can be found via the flip algorithm starting from any triangulation of (M, V) .*

4. *Properties from Proposition 3 hold.*

Proof. Statement 1. generalizes Proposition 2. In Proposition 2 we assumed that M is a closed surface and $V = \Sigma$. But it is easy to see that the proof works equally well without these assumptions. Statement 3. is contained in the proof of Proposition 2.

Statement 2. is essentially Proposition 1.

Finally, for statement 4. nothing changes in the proof of Proposition 3. \square

The weighted Delaunay tessellation with all weights equal is called the *Delaunay tessellation*. Theorem 3 implies that for any (M, V) the Delaunay tessellation is unique and a Delaunay triangulation can be obtained via the flip algorithm.

Delaunay triangulations of polyhedral surfaces were used as a technical tool in the study of moduli spaces of Euclidean polyhedral metrics on surfaces, [7], [20]. Recently they were applied to define the discrete Laplace-Beltrami operator on polyhedral surfaces [6].

3 Total scalar curvature and volume of the dual

In Section 2 we have shown that the radii $(r_i)_{i \in \Sigma}$ can serve as coordinates on the space $\mathcal{P}(M)$ of generalized convex polytopes with boundary M . Hence the curvatures $(\kappa_i)_{i \in \Sigma}$ become functions of the radii. In our proof of Alexandrov's theorem we will deform the radii so that at the end of the deformation all of the curvatures vanish. The goal of this Section is to prove non-degeneracy of the Jacobian $\left(\frac{\partial \kappa_i}{\partial r_j}\right)$ under certain restrictions on the polytope, Corollary 2. By the inverse function theorem, this allows to realize any infinitesimal deformation of curvatures by an infinitesimal deformation of radii.

3.1 Total scalar curvature of a generalized polytope

Definition 3.1 *Let $P = (T, r)$ be a convex generalized polytope. The total scalar curvature of P is*

$$H(P) = \sum_{i \in \mathcal{V}(T)} r_i \kappa_i + \sum_{ij \in \mathcal{E}(T)} \ell_{ij} (\pi - \theta_{ij}),$$

where $\kappa_i = 2\pi - \omega_i$ with ω_i the sum of the dihedral angles of pyramids at the i -th radial edge, ℓ_{ij} is the length of the edge $ij \in \mathcal{E}(T)$, and θ_{ij} is the dihedral angle of the polytope P at the edge ij .

If triangulation T is not unique, the value $H(P)$ does not depend on it, because $\pi - \theta_{ij} = 0$ for a flat edge ij .

Proposition 5 *For a fixed Euclidean polyhedral metric M , function H is of class C^2 on $\mathcal{P}(M)$. Its partial derivatives are:*

$$\frac{\partial H}{\partial r_i} = \kappa_i, \tag{13}$$

$$\frac{\partial \kappa_i}{\partial r_j} = \frac{\cot \alpha_{ij} + \cot \alpha_{ji}}{\ell_{ij} \sin \rho_{ij} \sin \rho_{ji}}, \tag{14}$$

$$\frac{\partial \kappa_i}{\partial r_i} = - \sum_{j \neq i} \cos \varphi_{ij} \frac{\partial \kappa_i}{\partial r_j}. \tag{15}$$

Here α_{ij} and α_{ji} are the dihedral angles of the pyramids at the edge ij , thus $\alpha_{ij} + \alpha_{ji} = \theta_{ij}$; ρ_{ij} is the angle at the vertex i in the triangle aij ; φ_{ij} is the angle at a in the same triangle. If ij is not an edge of T , then $\frac{\partial \kappa_i}{\partial r_j} = 0$.

Proof. Let P be strongly convex, that is let $\theta_{ij} < \pi$ for all $ij \in T$. In this case all polytopes in some neighborhood of P have the same triangulation T on the boundary.

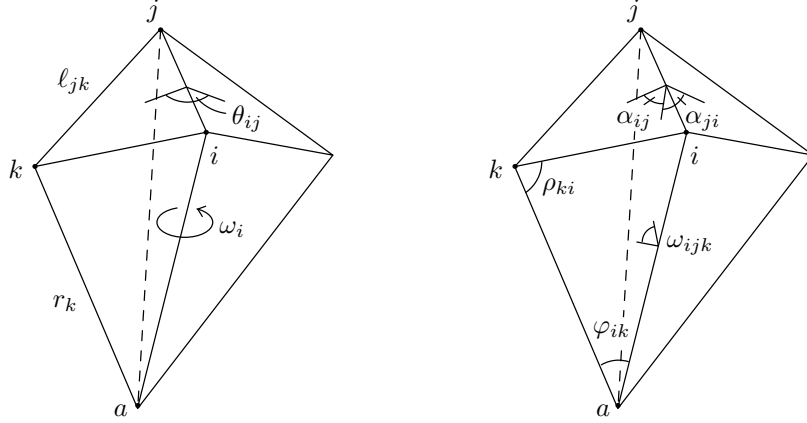

Figure 3: Angles and lengths in a generalized convex polytope.

For $ijk \in \mathcal{F}(T)$ consider the corresponding pyramid. Denote by ω_{ijk} its dihedral angle at the edge ai . By Schläfli formula [15],

$$r_i d\omega_{ijk} + r_j d\omega_{jik} + r_k d\omega_{kij} + \ell_{ij} d\alpha_{ij} + \ell_{jk} d\alpha_{jk} + \ell_{ki} d\alpha_{ki} = 0.$$

Summing this up over all $ijk \in \mathcal{F}(T)$ yields

$$\sum_{i \in \mathcal{V}(T)} r_i d\omega_i + \sum_{ij \in \mathcal{E}(T)} \ell_{ij} d\theta_{ij} = 0$$

which implies formula (13).

For $i \in \mathcal{V}(T)$ denote

$$\text{lk } i = \{j \in \mathcal{V}(T) \mid ij \in \mathcal{E}(T)\}. \quad (16)$$

The angle ω_i and its parts ω_{ijk} can be viewed as functions of the angles $(\rho_{ij})_{j \in \text{lk } i}$. By Leibniz rule we have

$$\begin{aligned} \frac{\partial \omega_{ijk}}{\partial r_j} &= \frac{\partial \omega_{ijk}}{\partial \rho_{ij}} \frac{\partial \rho_{ij}}{\partial r_j}, \\ \frac{\partial \omega_{ijk}}{\partial r_i} &= \frac{\partial \omega_{ijk}}{\partial \rho_{ij}} \frac{\partial \rho_{ij}}{\partial r_i} + \frac{\partial \omega_{ijk}}{\partial \rho_{ik}} \frac{\partial \rho_{ik}}{\partial r_i}. \end{aligned}$$

All partial derivatives on the right hand side are derivatives of the angles with respect to the side lengths in spherical and Euclidean triangles. Substituting the formulas of Lemma 5.1, we get the formulas (14) and (15).

Let P be not strongly convex. Recall that $\mathcal{P}^T(M)$ denotes the subset of $\mathcal{P}(M)$ formed by the polytopes with an associated triangulation T . By Property 3. from Proposition 3, $\mathcal{P}^T(M)$ are separated by affine hyperplanes in coordinates $(q_i) = (r_i^2)$. By the argument for a strongly convex P , there are directional derivatives of H at P in all directions. Since κ_i is well-defined and continuous on $\mathcal{P}(M)$, it follows that function H is of class C^1 .

The same argument applies to functions κ_i . The right hand sides of formulas (14) and (15) are well-defined and continuous because all of the summands that correspond to flat edges vanish. \square

In fact, the formulas of Proposition 5 are valid only when the triangulation T contains neither loops nor multiple edges. Otherwise the formulation is somewhat cumbersome and looks as follows. For an oriented edge $e \in \mathcal{E}(T)$ denote by $a(e), b(e) \in \mathcal{V}(T)$ its initial, respectively terminal, vertex. Then we have

$$d\kappa_i = \sum_{a(e)=i} \frac{\cot \alpha_e + \cot \alpha_{-e}}{\sin \rho_e} d\rho_e,$$

$$\frac{\partial \rho_e}{\partial r_j} = \begin{cases} \frac{1}{\ell_e \sin \rho_e} & \text{for } a(e) \neq j = b(e) \\ -\frac{\cos \varphi_e}{\ell_e \sin \rho_{-e}} & \text{for } a(e) = j \neq b(e) \\ \frac{\ell_e}{2r_i^2 \sin \rho_e} & \text{for } a(e) = j = b(e). \end{cases} \quad (17)$$

3.2 Generalized polyhedra

Convex polytope and convex polyhedron are two basic notions of the classical theory of polytopes. The former is defined as the convex hull of a finite number of points, and the latter as the intersection of a finite number of half-spaces. If we take a sphere with the center inside a convex polytope P , then the corresponding polar dual P^* is a bounded convex polyhedron, and vice versa. On the other hand, there is a fundamental theorem saying that the class of bounded convex polyhedra coincides with the class of convex polytopes. For more information see [27].

Here we dualize the notion of generalized convex polytope from Section 2 by introducing generalized convex polyhedra. Informally speaking, a generalized convex polytope has curvatures concentrated along the segments joining the apex to the vertices. A generalized convex polyhedron has curvatures concentrated along the altitudes drawn from the apex to the faces. A common extension of these two notions is a polyhedral complex that has curvatures both along the radial edges and along the altitudes. This class of complexes is self-dual; however, we have no need of such generalization.

Generalized convex polyhedra are introduced in Definitions 3.2 and 3.3. In order to motivate the abstract constructions let us look closer at the classical convex polyhedra.

Let us start by recalling the notion of the normal fan. Let Q be a bounded 3-dimensional convex polyhedron. To a face Q_i of Q associate the ray in \mathbb{R}^3 based at the origin and spanned by the outer normal to Q_i . If two faces Q_i and Q_j have an edge in common, then denote this edge by Q_{ij} and associate to it the positive span of the rays associated with Q_i and Q_j . The flat angles thus obtained subdivide \mathbb{R}^3 into 3-dimensional cones which are the normal cones at the vertices of Q . The resulting complex of cones

is called the *normal fan* of Q . If exactly three edges meet at every vertex of Q , then all vertex cones are trihedral angles, and the normal fan is called *simplicial*. Every normal fan can be subdivided to become simplicial, which corresponds to formally introducing in Q additional edges of zero length. The spherical section of a simplicial fan is a geodesic triangulation of \mathbb{S}^2 . Clearly, it completely determines the fan.

Definition 3.2 A *generalized simplicial fan* is a couple (T, φ) , where T is a triangulation of the sphere, and

$$\varphi : \mathcal{E}(T) \rightarrow (0, \pi)$$

is a map such that for each triangle $ijk \in \mathcal{F}(T)$ there exists a spherical triangle with side lengths $\varphi_{ij}, \varphi_{jk}, \varphi_{ik}$.

A simplex $OABC$ in \mathbb{R}^3 is called an *orthoscheme*, if the vectors OA, AB, BC are pairwise orthogonal. Let $Q \subset \mathbb{R}^3$ be a convex polyhedron. Draw perpendiculars from a point $O \in \mathbb{R}^3$ to the planes of the faces of Q . Let A_i be the foot of the perpendicular to the face Q_i . In the plane of Q_i draw perpendiculars $A_i A_{ij}$ to the edges Q_{ij} . By A_{ijk} denote the vertex of Q common to the faces Q_i, Q_j and Q_k . The collection of orthoschemes $OA_i A_{ij} A_{ijk}$ is called the *orthoscheme decomposition* of Q . Combinatorially the orthoscheme decomposition is the barycentric decomposition of Q . Note although that the foots of perpendiculars can lie outside the faces or edges, which makes the geometric picture complicated. Let h_i, h_{ij}, h_{ijk} be the signed lengths of the segments $OA_i, A_i A_{ij}, A_{ij} A_{ijk}$, respectively. The length h_i is negative if the point O and the polytope Q are on the opposite sides of the face Q_i ; similarly for h_{ij} and h_{ijk} . We call the numbers h_i, h_{ij}, h_{ijk} the *parameters of the orthoscheme* $OA_i A_{ij} A_{ijk}$.

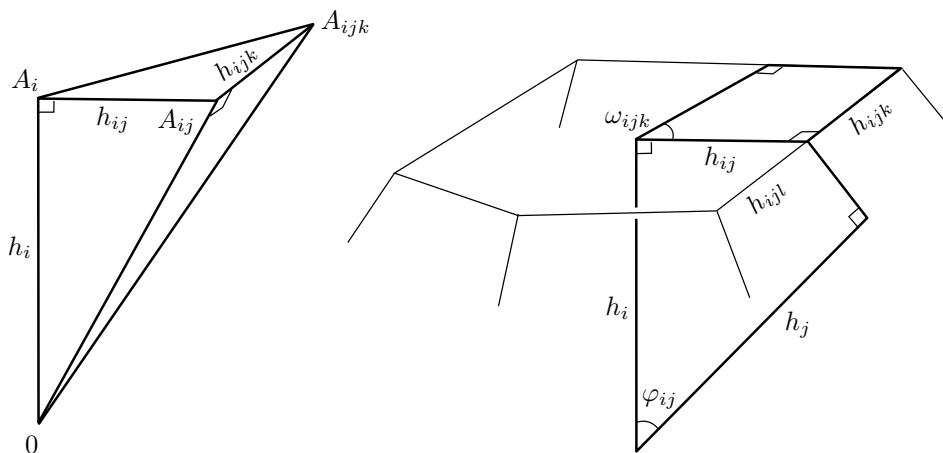

Figure 4: The orthoscheme decomposition of a convex polyhedron.

Clearly, the normal fan and the altitudes h_i completely determine the polyhedron Q . In particular, the parameters h_{ij} and h_{ijk} can be expressed through (h_i) and the angles of the fan. One can compute

$$h_{ij} = \frac{h_j - h_i \cos \varphi_{ij}}{\sin \varphi_{ij}}, \quad (18)$$

where φ_{ij} is the angle between the outer normals to faces Q_i and Q_j . Similarly,

$$h_{ijk} = \frac{h_{ik} - h_{ij} \cos \omega_{ijk}}{\sin \omega_{ijk}}, \quad (19)$$

where ω_{ijk} is the exterior angle of the face Q_i at the vertex A_{ijk} or, equivalently, the angle at the vertex i of the triangle ijk in the spherical section of the normal fan. The length ℓ_{ij}^* of the edge Q_{ij} can be expressed as

$$\ell_{ij}^* = h_{ijk} + h_{ijl}, \quad (20)$$

where Q_k and Q_l are the faces that bound the edge Q_{ij} . Therefore the sum $h_{ijk} + h_{ijl}$ has to be non-negative, although some of the parameters h_{ijk} are allowed to be negative. Note also that

$$h_{ijk} = h_{jik} \quad (21)$$

which is not obvious from (19), but is clear from the geometric meaning of h_{ijk} .

A generalized convex polyhedron is defined as a generalized simplicial fan together with the set of altitudes h_i . More intuitively, it is a complex of signed orthoschemes with parameters computed by formulas (18) and (19). Moreover, we require the edge lengths (20) to be non-negative.

Definition 3.3 *Let (T, φ) be a generalized simplicial fan, and h be a map $\mathcal{V}(T) \rightarrow \mathbb{R}$. A triple $Q = (T, \varphi, h)$ is called a generalized convex polyhedron, if $\ell_{ij}^* \geq 0$ for every edge $ij \in \mathcal{E}(T)$, where ℓ_{ij}^* is defined by (18), (19), and (20). Here ω_{ijk} is the angle at the vertex i in the spherical triangle ijk of the fan (T, φ) .*

For every $i \in \mathcal{V}(T)$ define the area of the i -th face of Q by

$$F_i = \frac{1}{2} \sum_j h_{ij} \ell_{ij}^*. \quad (22)$$

The volume of the polyhedron Q is defined by

$$\text{vol} = \frac{1}{3} \sum_i h_i F_i. \quad (23)$$

Note that the right hand side of the formula (23) is nothing else than the sum of the signed volumes of the orthoschemes.

The space $\mathcal{Q}(T, \varphi)$ of all generalized convex polyhedra with a given normal fan (T, φ) is a convex polyhedron in $\mathbb{R}^{\mathcal{V}(T)}$ with coordinates (h_i) . The interior of $\mathcal{Q}(T, \varphi)$ corresponds to generalized polyhedra with all edges ℓ_{ij}^* of positive length. Function vol is a homogeneous polynomial of degree 3 in (h_i) , hence differentiable.

Proposition 6 *The volume of $Q \in \mathcal{Q}(T, \varphi)$ is a smooth function of h with the following partial derivatives:*

$$\frac{\partial \text{vol}}{\partial h_i} = F_i, \quad (24)$$

$$\frac{\partial F_i}{\partial h_j} = \frac{\ell_{ij}^*}{\sin \varphi_{ij}}, \quad (25)$$

$$\frac{\partial F_i}{\partial h_i} = - \sum_{j \neq i} \cos \varphi_{ij} \frac{\partial F_i}{\partial h_j}. \quad (26)$$

We need the following lemma.

Lemma 3.1 *Face area F_i as a function of variables h_{ij} has the following partial derivatives:*

$$\frac{\partial F_i}{\partial h_{ij}} = \ell_{ij}^*. \quad (27)$$

Proof. It is not hard to see that

$$\frac{\partial F_i}{\partial h_{ij}} = \frac{1}{2} \left(\frac{\partial}{\partial h_{ij}} (h_{ij} h_{ijk} + h_{ik} h_{ikj}) + \frac{\partial}{\partial h_{ij}} (h_{ij} h_{ijl} + h_{ik} h_{ilk}) \right).$$

Now the Lemma follows from

$$\begin{aligned} \frac{\partial}{\partial h_{ij}} (h_{ij} h_{ijk} + h_{ik} h_{ikj}) &= h_{ijk} + h_{ij} \frac{\partial h_{ijk}}{\partial h_{ij}} + h_{ik} \frac{\partial h_{ikj}}{\partial h_{ij}} \\ &= h_{ijk} - h_{ij} \cot \omega_{ijk} + \frac{h_{ik}}{\sin \omega_{ikj}} \\ &= h_{ijk} + \frac{h_{ik} - h_{ij} \cos \omega_{ijk}}{\sin \omega_{ijk}} \\ &= 2h_{ijk}. \end{aligned}$$

□

Proof of Proposition 6. Equalities (25) and (26) follow from

$$\frac{\partial F_i}{\partial h_j} = \frac{\partial F_i}{\partial h_{ij}} \frac{\partial h_{ij}}{\partial h_j},$$

respectively from

$$\frac{\partial F_i}{\partial h_i} = \sum_j \frac{\partial F_i}{\partial h_{ij}} \frac{\partial h_{ij}}{\partial h_i}.$$

To prove (24), differentiate (23) by Leibniz rule and use formulas (25) and (26). \square

As a byproduct we obtain the following analogue of the Schläfli formula:

Corollary 1

$$\sum_i h_i dF_i = 2 \, d\text{vol}.$$

Note that for classical convex polyhedra formulas (24) – (27) have a clear geometric interpretation.

The triangulation T may have loops and multiple edges. Formulas (25) and (26) can be generalized to this case similarly to (17).

3.3 Duality

The formulas of Propositions 5 and 6 are closely connected.

Definition 3.4 *Let $P = (T, r)$ be a generalized convex polytope. Its spherical section centered at the apex produces a generalized simplicial fan (T, φ) , where φ_{ij} is the angle of the triangle a_{ij} at the vertex a . The triple $P^* = (T, \varphi, h)$ with $h_i = \frac{1}{r_i}$ is called the generalized convex polyhedron dual to P .*

We justify this definition by showing that $\ell_{ij}^* \geq 0$ for any $ij \in \mathcal{E}(T)$.

Lemma 3.2 *If $OABC$ is an orthoscheme, then $OC^*B^*A^*$ is also an orthoscheme. Here X^* is the point on the ray OX such that $OX^* \cdot OX = 1$.*

Proof. $OABC$ is an orthoscheme if and only if OAB, OAC , and OBC are two-dimensional orthoschemes, that is right triangles. Since triangles OXY and OY^*X^* are similar, OC^*B^*, OC^*A^* , and OB^*A^* are also orthoschemes. This implies that $OC^*B^*A^*$ is an orthoscheme. \square

Call $OC^*B^*A^*$ the orthoscheme dual to $OABC$.

Lemma 3.3 *Decompose each of the constituting pyramids of P into 6 orthoschemes. Then the duals to these orthoschemes are exactly those that form the orthoscheme decomposition of P^* . The following formulas hold:*

$$h_{ij} = \frac{\cot \rho_{ij}}{r_i}, \tag{28}$$

$$h_{ijk} = \frac{\cot \alpha_{ij}}{r_i \sin \rho_{ij}}. \tag{29}$$

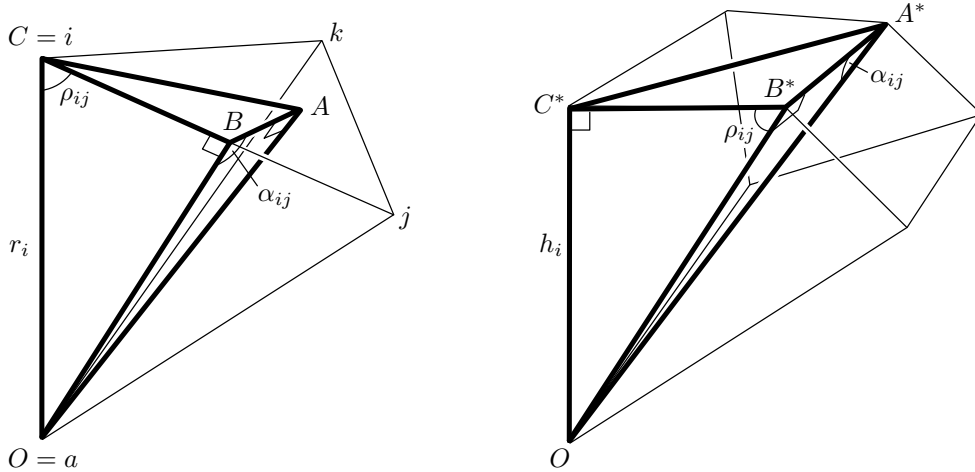

Figure 5: Building blocks of a generalized convex polytope and of its dual polyhedron.

Proof. For a pyramid ijk , the six dual orthoschemes can be identified along common edges and faces. Together they form an object that has combinatorics of the cube, see Figure 5. The three faces of the cube which do not contain the apex are orthogonal to the side edges of the pyramid and have the distances h_i, h_j, h_k from the apex. But exactly this construction was invoked in Definition 3.3. Therefore each of the dual orthoschemes has parameters h_i, h_{ij}, h_{ijk} with indices appropriately permuted.

In the pyramid ijk let A be the foot of the perpendicular to the base, B be the foot of the perpendicular from A to ij , and C be the vertex i . In the dual orthoscheme $C^*B^*A^*$ we have $A^*B^* = h_{ijk}$ and $B^*C^* = h_{ij}$. To prove the formulas (28) and (29), note that $\angle OA^*B^* = \angle OBA = \alpha_{ij}$ and $\angle OB^*C^* = \angle OCB = \rho_{ij}$. \square

Substitution of (29) into (20) yields

$$\ell_{ij}^* = \frac{\cot \alpha_{ij} + \cot \alpha_{ji}}{r_i \sin \rho_{ij}}, \quad (30)$$

which is non-negative because $\alpha_{ij} + \alpha_{ji} = \theta_{ij} \leq \pi$. This shows that P^* is indeed a generalized convex polyhedron and justifies Definition 3.4.

Remark. An orthoscheme can degenerate so that some of the points O, A, B, C coincide. A formal approach that includes this possibility is to define an orthoscheme as an orthonormal basis and a triple of real parameters. Then degenerations correspond to vanishing of some of the parameters. If the first parameter vanishes, then so do the others, and the dual orthoscheme is infinitely large. This does not happen, when we dualize the orthoschemes in Lemma 3.3, because the first parameter there is the altitude of a constituting pyramid and does not vanish ($O \neq A$).

Theorem 4 *The Hessian of the total scalar curvature at P is equal to the Hessian of the volume at P^* :*

$$\frac{\partial^2 H}{\partial r_i \partial r_j}(P) = \frac{\partial^2 \text{vol}}{\partial h_i \partial h_j}(P^*) \quad \text{for all } i, j.$$

Equivalently, the Jacobian of the curvatures of P with respect to the radii equals the Jacobian of the face areas of P^ with respect to the altitudes:*

$$\frac{\partial \kappa_i}{\partial r_j}(P) = \frac{\partial F_i}{\partial h_j}(P^*) \quad \text{for all } i, j. \quad (31)$$

Proof. Substitute (30) into (25) and (26). After applying the sine theorem to triangle aij , the right hand sides of (25) and (26) become identical with those of (14) and (15). \square

Remarks. A generalized simplicial cone (T, φ) determines a spherical polyhedral metric S on the sphere. Similarly to Section 2, one can consider the set $\mathcal{Q}(S)$ of all generalized convex polyhedra with the spherical section S . Then a collection of altitudes h_i defines the triangulation T uniquely, up to the edges with zero dual edge length: $\ell_{ij}^* = 0$. Coordinates (h_i) make $\mathcal{Q}(S)$ to a polyhedron in \mathbb{R}^n . The chamber $\mathcal{Q}^T(S)$ that corresponds to a triangulation T is also a polyhedron and was denoted by $\mathcal{Q}(T, \varphi)$ in Subsection 3.2. The polytope P in Theorem 4 has a fixed boundary M and depends only on r ; similarly, the polyhedron P^* has a fixed spherical section S and depends on h . Note that the duality map $P \mapsto P^*$ maps the polytopes with the same boundary to polyhedra with different spherical sections.

The function vol is of class C^2 on $\mathcal{Q}(S)$, because the formulas of Proposition 6 agree at the common boundary points of chambers $\mathcal{Q}^{T_1}(S)$ and $\mathcal{Q}^{T_2}(S)$.

In the classical situation we have the space of polyhedra with given outer normals v_i to the faces. Minkowski theorem [16] says that the condition $\sum F_i v_i = 0$ is necessary and sufficient for the existence of a polyhedron with the given face normals and face areas F_i . The classical proof of Minkowski theorem [23, Section 7.1] is based on the properties of the Hessian of the volume. Because our proof of Alexandrov's theorem uses non-degeneracy of the Hessian of the total scalar curvature, Theorem 4 provides a connection between the Minkowski and Alexandrov's theorems.

3.4 Mixed volumes of generalized convex polyhedra

Theorem 4 shows that in order to prove the non-degeneracy of $\left(\frac{\partial \kappa_i}{\partial r_j}\right)$, it suffices to prove the non-degeneracy of $\left(\frac{\partial^2 \text{vol}}{\partial h_i \partial h_j}\right)$. For classical convex polyhedra the signature of this Hessian is known. This information is expressed

as Alexandrov-Fenchel inequalities [1], and more explicitly in the lemmas used to prove them, see [23, Section 6.3, Propositions 3 and 4].

Any generalized convex polyhedron has curvatures κ_i , defined as the curvatures of its spherical section.

Theorem 5 *Let Q be a generalized convex polyhedron such that*

$$\kappa_i > 0, h_i > 0, F_i > 0 \quad \text{for all } i,$$

where κ_i is the curvature, h_i is the altitude, and F_i is the area of the i -th face. Then the Hessian of the volume of Q is non-degenerate:

$$\det \left(\frac{\partial^2 \text{vol}}{\partial h_i \partial h_j} \right) \neq 0.$$

We will prove this theorem using the notion of mixed volumes.

Let us introduce some notation. For any $x \in \mathbb{R}^{\mathcal{V}(T)}$ we denote by x_{ij} and x_{ijk} linear functions of x obtained by substituting x for h in formulas (18) and (19), respectively. In a similar way we define functions $\ell_{ij}^*(x)$, $F_i(x)$, and $\text{vol}(x)$. Besides, introduce a function \overline{F}_i on $\mathbb{R}^{\text{lk } i}$ as follows. The point with coordinates $(x_{ij})_{j \in \text{lk } i}$ in $\mathbb{R}^{\text{lk } i}$ is sent to $\frac{1}{2} \sum_j x_{ij} \ell_{ij}^*$, where ℓ_{ij}^* is again computed via (20). In other words,

$$F_i = \overline{F}_i \circ \pi_i,$$

where $\pi_i : \mathbb{R}^{\mathcal{V}(T)} \rightarrow \mathbb{R}^{\text{lk } i}$ maps (x_i) to (x_{ij}) .

It is immediate that all of F_i and \overline{F}_i are quadratic forms and vol is a cubic form.

Definition 3.5 *The mixed areas $F_i(\cdot, \cdot)$ and $\overline{F}_i(\cdot, \cdot)$ are the symmetric bilinear forms associated to the quadratic forms F_i and \overline{F}_i . The mixed volume $\text{vol}(\cdot, \cdot, \cdot)$ is the symmetric trilinear form associated to the cubic form vol .*

Proposition 7 *The mixed areas and the mixed volume can be computed by the formulas*

$$F_i(x, y) = \frac{1}{2} \sum_j x_{ij} \ell_{ij}^*(y), \quad (32)$$

$$\text{vol}(x, y, z) = \frac{1}{3} \sum_i x_i F_i(y, z). \quad (33)$$

Proof. It suffices to prove (32) for the bilinear form \overline{F}_i . For any symmetric bilinear form B we have:

$$B(x, y) = \frac{1}{2} \sum_i x_i \frac{\partial B(y, y)}{\partial y_i}.$$

Thus (32) follows from Lemma 3.1.

A similar argument shows that

$$\text{vol}(x, y, y) = \frac{1}{3} \sum_i x_i F_i(y, y).$$

Using $2 \text{vol}(x, y, z) = \text{vol}(x, y + z, y + z) - \text{vol}(x, y, y) - \text{vol}(x, z, z)$ we get (33). \square

Lemma 3.4 *If $\kappa_i > 0$, then the form \overline{F}_i is non-degenerate and has exactly one positive eigenvalue, which is simple.*

Proof. First let us prove the non-degeneracy. Assume that for a vector $y \in \mathbb{R}^{\text{lk } i}$ we have $\overline{F}_i(x, y) = 0$ for any x . Then from (32) we have $\ell_{ij}^*(y) = 0$ for every j . We need to show that this implies $y = 0$.

Let us go back to the geometric origins. We have a generalized polygon with the angles ω_{ijk} between the normals to consecutive sides. Numbers y_{ij} are altitudes to the sides. We can develop the boundary of the polygon onto the plane so that it becomes a polygonal line. The rotation by the angle $\omega_i = \sum_{jk} \omega_{ijk}$ sends the starting point of the line to its endpoint. The equalities $\ell_{ij}^*(y) = 0$ mean that all of the segments of the line have zero length. Thus the line degenerates to a point invariant under rotation. Because $\omega_i = 2\pi - \kappa_i < 2\pi$, this point can be only the origin. Thus $y_{ij} = 0$ for every j .

To determine the signature, deform the collection of angles $(\omega_{ijk})_{jk}$ continuously so that they become all equal. If their sum remains less than 2π during the process of deformation, then the form \overline{F}_i remains non-degenerate and it suffices to compute its signature at the final point. This can be done explicitly by extracting the coefficients from (19) and by computing the eigenvalues.

Note that in the classical situation $\omega_i = 2\pi$, and the polygon can degenerate to any point. This means that the form \overline{F}_i has a 2-dimensional nullspace. The form \overline{F}_i is non-degenerate if and only if ω_i is not an integer multiple of 2π . The dimension of the positive subspace is $2k - 1$, for $\omega_i \in (2(k - 1)\pi, 2k\pi)$. \square

Proof of Theorem 5. We have

$$\text{vol}(h + x) = \text{vol}(h) + 3\text{vol}(h, h, x) + 3\text{vol}(h, x, x) + \text{vol}(x).$$

We have to show that under assumption $\kappa_i > 0$ for all i , the quadratic form $\text{vol}(h, \cdot, \cdot)$ is non-degenerate for any h that satisfies $h_i > 0, F_i(h) > 0$ for all i .

Assume the converse. Then there exists a non-zero vector x such that $\text{vol}(h, x, y) = 0$ for any y . Since $\text{vol}(h, x, y) = \text{vol}(y, h, x) = \frac{1}{3} \sum_i y_i F_i(h, x)$,

this implies $F_i(h, x) = 0$ for every i . Thus x is orthogonal to h with respect to the form F_i . Because $F_i(h, h) > 0$ by assumption, Lemma 3.4 implies that $F_i(x, x) \leq 0$. Besides, if $F_i(x, x) = 0$, then $x_{ij} = 0$ for every $j \in \text{lk } i$.

Consider the mixed volume $\text{vol}(h, x, x)$. On one hand we have

$$\text{vol}(h, x, x) = \frac{1}{3} \sum_i x_i F_i(h, x) = 0.$$

On the other hand

$$\text{vol}(h, x, x) = \frac{1}{3} \sum_i h_i F_i(x, x) \leq 0,$$

because $h_i > 0$ for every i . Hence $F_i(x, x) = 0$ for every i , and $x_{ij} = 0$ for every edge ij . Note that for every $i \in \mathcal{V}(T)$ we have $\text{lk } i \neq \emptyset$, otherwise $F_i(h) = 0$. By formula (18), $x_{ij} = 0 = x_{ji}$ together with $\varphi_{ij} \in (0, \pi)$ implies $x_i = 0$. This contradicts the assumption $x \neq 0$. \square

Let $Q = P^*$ be the dual to a generalized convex polytope P . Then $h_i = \frac{1}{r_i} > 0$ for every i . Also, P and P^* have identical spherical sections, thus their curvatures are equal. However, there are examples of positively curved polytopes P where $F_i(P^*) < 0$ for some i . The following Proposition describes a class of polytopes such that their duals satisfy the assumptions of Theorem 5.

Proposition 8 *Let P be a generalized convex polytope with boundary M and suppose that*

$$0 < \kappa_i < \delta_i \quad \text{for all } i,$$

where δ_i is the angular defect of the i -th singularity on M . Then we have

$$F_i > 0 \quad \text{for all } i$$

in the dual polyhedron P^ .*

Proof. The i -th face P_i^* of P^* is a generalized convex polyhedron of dimension 2. It is defined by the angles $(\omega_{ijk})_{jk}$ between the normals to the sides and the altitudes $(h_{ij})_j$ of the sides. Formulas (19), (20), (22) allow to compute the side lengths and the area of P_i^* . Alternatively, one constructs 2-dimensional orthoschemes, that is right triangles with legs h_{ij}, h_{ijk} , and glues them along common sides.

To the Euclidean generalized polyhedron P_i^* there is its spherical counterpart SP_i^* . Take a sphere of radius $\frac{1}{r_i}$ and place a constituting orthoscheme of P_i^* in the plane tangent to the north pole so that the base point of the orthoscheme is at the north pole. Project the orthoscheme to the northern hemisphere using the sphere center as the center of projection. The

image is a spherical right triangle which we also call an orthoscheme, see Figure 6. The polyhedron SP_i^* is defined as the complex of thus constructed spherical orthoschemes. Because of (28), the first parameter of the spherical orthoscheme equals $\frac{\pi}{2} - \rho_{ij}$. Therefore SP_i^* is defined by the angles ω_{ijk} between the normals to the sides and the altitudes $\frac{\pi}{2} - \rho_{ij}$.

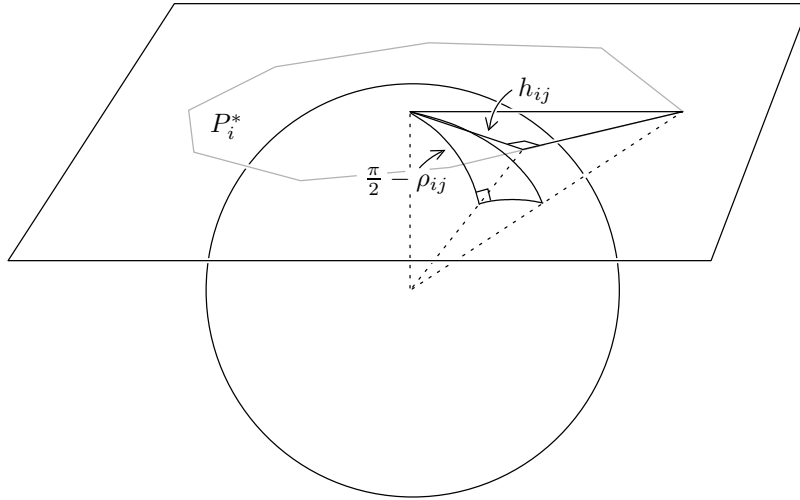

Figure 6: To the definition of SP_i^* .

We claim that

$$\text{area}(SP_i^*) = \delta_i - \kappa_i. \quad (34)$$

By Lemma 3.5 this together with the assumption $\delta_i > \kappa_i$ implies $F_i > 0$.

Let SP_i be the spherical section of P at the vertex i . It consists of the spherical triangles with two sides of length ρ_{ij}, ρ_{ik} and angle ω_{ijk} between them. Denote by γ_{ijk} the length of the third side of this triangle. The spherical generalized 2-polytop SP_i has SP_i^* as its spherical dual, see Figure 7. Consider the pair of orthoschemes (ij, ijk) and (ik, ikj) in SP_i^* . Together they form a quadrilateral with two right opposite angles. The angle of this quadrilateral at the center of the polyhedron equals ω_{ijk} , whereas the fourth angle is $\pi - \gamma_{ijk}$. Therefore the area of the quadrilateral is $\omega_{ijk} - \gamma_{ijk}$. This remains true when some parameters of the orthoschemes are negative, if one considers signed angles and signed areas. As a result, we have

$$\text{area}(SP_i^*) = \sum_{jk} (\omega_{ijk} - \gamma_{ijk}) = \omega_i - \text{per}(SP_i).$$

Since $\kappa_i = 2\pi - \omega_i$ and $\delta_i = 2\pi - \text{per}(SP_i)$, this implies the equality (34). \square

For a 2-dimensional generalized convex polyhedron Q define its *spherical image* SQ exactly as we defined SP_i^* in the proof of Proposition 8, but taking a unit sphere instead, see Figure 6.

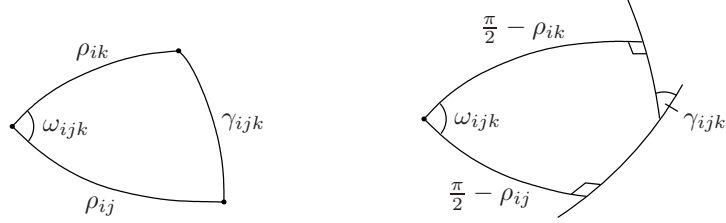

Figure 7: The spherical generalized polygons SP_i and SP_i^* .

Lemma 3.5 *Let C be a positively curved generalized convex polyhedron of dimension 2, and let SC be its spherical image. Suppose that $\text{area}(SC) > 0$. Then also $\text{area}(C) > 0$.*

Proof. If all of the altitudes of C are negative, then so are the altitudes of SC , which leads to $\text{area}(SC) < 0$.

Let h_i be a positive altitude of C . We have $h_{ij} + h_{ik} = \ell_i^* \geq 0$, where ℓ_i^* is the length of the i -th side of C , and h_{ij}, h_{ik} are the signed lengths of the segments into which the side is divided by the foot of the altitude. Without loss of generality $h_{ij} \geq 0$. Cut C along the segment joining the vertex ij to the apex. Develop the result onto the plane. The two sides of the cut become sides of an isosceles triangle Δ , and the boundary of C develops to a convex polygonal line joining the two base vertices of Δ . It can be shown that, when extended by the base of Δ , the line remains convex. Let D be the convex polygon bounded by it. If $\kappa \geq \pi$, then Δ and D lie on different sides from their common edge, and one easily sees that all of the altitudes of C are positive. This automatically implies $\text{area}(C) > 0$. If $\kappa < \pi$, then we have

$$\text{area}(C) = \text{area}(D) - \text{area}(\Delta),$$

and, if J denotes the Jacobian of the projection to the sphere,

$$\text{area}(SC) = \int_D J d\text{area} - \int_\Delta J d\text{area}.$$

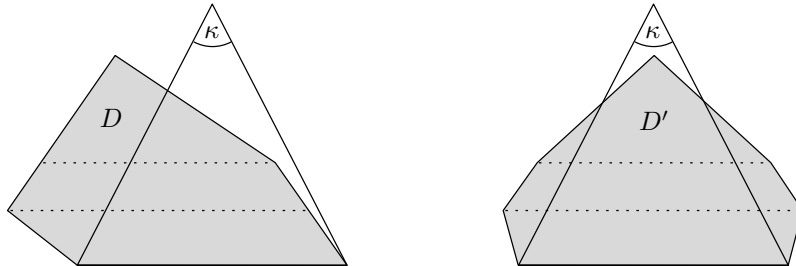

Figure 8: Triangle Δ , polygon D and its Steiner symmetral D' .

To show that $\text{area}(SC) > 0$ implies $\text{area}(C) > 0$, replace D by its Steiner symmetral D' with respect to the line perpendicular to the base of Δ . This means that D gets decomposed into segments parallel to the base and every segment gets translated so that its midpoint lies on the altitude of Δ . The polygon D' is symmetric with respect to the altitude of Δ and has the same area as D . On the other hand, it is not hard to see that $\int_{D'} Jd\text{area} \geq \int_D Jd\text{area}$. This implies

$$\int_{D'} Jd\text{area} > \int_{\Delta} Jd\text{area}.$$

It is easy to see that for any $x \in D' \setminus \Delta$ and for any $y \in \Delta \setminus D'$ we have $J(x) \leq J(y)$. It follows that $\text{area}(D') > \text{area}(\Delta)$ and thus $\text{area}(C) > 0$. \square

Corollary 2 *Let P be a generalized convex polytope with radii (r_i) and curvatures (κ_i) . Suppose that*

$$0 < \kappa_i < \delta_i \quad \text{for all } i,$$

where δ_i is the angular defect of the i th singularity on the boundary of P . Then the matrix $\left(\frac{\partial \kappa_i}{\partial r_j}\right)$ is non-degenerate.

Proof. This follows from Proposition 8, Theorem 5, and from the fact that the Jacobian of the map $r \mapsto \kappa$ equals the Hessian of H , see (13). \square

Now we study the matrix $\left(\frac{\partial \kappa_i}{\partial r_j}\right)$ at $\kappa_i = 0$ for all i , that is in the case when the generalized convex polytope is a usual convex polytope. As a corollary we get a proof of the infinitesimal rigidity of polytopes.

Proposition 9 *Let P be a generalized convex polytope with all curvatures zero. Then the Jacobian $\left(\frac{\partial \kappa_i}{\partial r_j}\right)$ has corank 3. A vector $dr = (dr_i)$ lies in the kernel of $\left(\frac{\partial \kappa_i}{\partial r_j}\right)$ if and only if there exists $x \in \mathbb{R}^3$ such that*

$$dr_i = \left\langle \frac{p_i - a}{\|p_i - a\|}, x \right\rangle \quad \text{for all } i. \quad (35)$$

Here p_i are the vertices of P , and a is the apex, for some realization of P as a convex polytope in \mathbb{R}^3 .

Proof. Use the equality (31). Here P^* is the convex polytope in \mathbb{R}^3 polar to P . It is known that the matrix $\left(\frac{\partial F_i}{\partial h_j}\right)$ has corank 3, see [23, Section 6.3, Proposition 3]. Hence the Jacobian $\left(\frac{\partial \kappa_i}{\partial r_j}\right)$ has also corank 3.

Now let us find vectors in the kernel. Let $x \in \mathbb{R}^3$ be any vector. Consider the family $\{P_x(t) \mid t \in (-\varepsilon, \varepsilon)\}$ of generalized polytopes with zero curvatures,

where $P_x(t) \subset \mathbb{R}^3$ has vertices p_i and the apex $a - tx$. From $r_i = \|p_i - a\|$ it is easy to get

$$\left. \frac{dr_i}{dt} \right|_{t=0} = \left\langle \frac{p_i - a}{\|p_i - a\|}, x \right\rangle.$$

Therefore any infinitesimal deformation given by (35) results in $d\kappa_i = 0$ for all i . \square

Corollary 3 *Convex polytopes are infinitesimally rigid.*

Proof. Let $P \subset \mathbb{R}^3$ be a convex polytope with vertices (p_i) . Triangulate its non-triangular faces by diagonals. Let (dp_i) be infinitesimal motions of the vertices that result in a zero first order variation of the edge lengths. Take any point a in the interior of P and cut P into pyramids with the apex a . The deformation changes the dihedral angles of the pyramids, but the total angles ω_i around the radial edges remain equal to 2π . This means that the vector $(dr_i = d\|p_i - a\|)$ belongs to the kernel of the Jacobian $\left(\frac{\partial\omega_i}{\partial r_j}\right)$. Recall that $\kappa_i = 2\pi - \omega_i$. By Proposition 9 we have (35). It follows that (dp_i) is the restriction of the differential of a rigid motion of P . \square

The infinitesimal rigidity of convex polytopes is a classical result due to Dehn [8]. Recently different new proofs were suggested by Filliman [12], Schlenker [22] and Pak [18].

The proof of Filliman [12] is very similar to ours and is formulated in the language of stresses on frameworks.

Schlenker in [22] studies infinitesimal isometric deformations of spherical and Euclidean polygons and the corresponding first-order variations of their angles. He introduces a quadratic form on the space of infinitesimal deformations and proves a remarkable positivity property for it.

4 Proof of Alexandrov's theorem

In this section we prove the existence part of Theorem 1. The uniqueness can be proved by extending the classical Cauchy's argument, see [3, Section 3.3]. In order to establish existence, we construct a family $\{P(t)\}_{t \in [0,1]}$ of generalized convex polytopes with the boundary M such that the curvatures of $P(0)$ vanish. Then $P(0)$ is a desired convex polytope.

Theorem 6 *For any convex Euclidean polyhedral metric M on the sphere there exists a family $\{P(t) = (T(t), r(t)) \mid t \in (0, 1]\}$ of generalized convex polytopes with boundary M such that*

1. $T(1)$ is the Delaunay triangulation of M , and $r_i(1) = R$ for all i and a sufficiently large R ;

2. the curvatures $\kappa_i(t)$ of the polytope $P(t)$ are proportional to t :

$$\kappa_i(t) = t \cdot \kappa_i(1) \quad \text{for all } i. \quad (36)$$

3. $r(t)$ is of class C^1 on $(0, 1]$;

4. there exists the limit $r(0) = \lim_{t \rightarrow 0} r(t)$;

5. there exists a convex polytope $P \subset \mathbb{R}^3$ with boundary isometric to M and vertices p_i such that $r_i(0) = \|p_i - a\|$, where $a \in P$ is the unique point that satisfies the condition

$$\sum_i \kappa_i(1) \frac{p_i - a}{\|p_i - a\|} = 0. \quad (37)$$

Theorem 6 provides the following recipe for construction of a polytope with the boundary M . The path $P(t)_{t \in (0,1]}$ in the space $\mathcal{P}(M)$ is the preimage of the path $\kappa(t)_{t \in [0,1]}$ given by (36). Since a generalized convex polytope is uniquely determined by its radii, we have a system of differential equations:

$$\frac{dr}{dt} = \left(\frac{\partial \kappa_i}{\partial r_j} \right)^{-1} \kappa(1). \quad (38)$$

Theorem 6 states that the system has a solution on $(0, 1]$ with the initial condition $r(1) = (R, \dots, R)$ for R sufficiently large. Besides, $r(t)$ converges at $t = 0$. At this point there are two possibilities: either the pyramids with edge lengths $r_i(0)$ over some triangulation $T(0)$ form a convex polytope, or all of the pyramids degenerate and their bases form a doubly-covered polygon. When solving the system (38) numerically one should not forget that the formulas (14), (15) for the partial derivatives $\frac{\partial \kappa_i}{\partial r_j}$ depend on the combinatorics of the triangulation $T(t)$. During the deformation of the generalized convex polytope $P(t)$ the triangulation $T(t)$ may change. In a generic case there are flips that happen at different moments.

4.1 Proof of Theorem 6

The proof uses the description of the space $\mathcal{P}(M)$ of generalized convex polytopes and the non-degeneracy of the Hessian of functional H . Especially we refer to Proposition 4 and Corollary 2. Several lemmas needed to deal with degenerating generalized polytopes are postponed to Section 5.

In Section 2 we used an embedding of $\mathcal{P}(M)$ into \mathbb{R}^n via squares of the radii. Here we consider radii as coordinates on $\mathcal{P}(M)$. Thus a generalized convex polytope is identified with a point $r = (r_1, \dots, r_n) \in \mathbb{R}^n$. The map

$$\begin{aligned} \mathcal{P}(M) &\rightarrow \mathbb{R}^n, \\ r &\mapsto \kappa, \end{aligned} \quad (39)$$

is of class C^1 in the interior of $\mathcal{P}(M)$ by Proposition 5. We have to show that the path $\kappa : (0, 1] \rightarrow \mathbb{R}^n$ given by (36) can be lifted through the map (39) to a path $r : (0, 1] \rightarrow \mathcal{P}(M)$. The question of convergence of r at $t \rightarrow 0$ will be treated later.

Lemma 4.1 *For R large enough, there is a lift of the path (36) on an interval $(t_0, 1]$ for some t_0 .*

Proof. By property 1. from Proposition 4, there is a generalized convex polytope $P(1)$ with large equal radii. Moreover, $P(1)$ lies in the interior of the space $\mathcal{P}(M)$. The corresponding triangulation $T(1)$ of M is the weighted Delaunay triangulation with equal weights, that is the Delaunay triangulation.

The spherical section of $P(1)$ at the vertex i is a convex star polygon, see Figure 11. We have $\rho_j < \frac{\pi}{2}$ for every j , because ρ_j is an angle at the base of an isosceles triangle. Therefore by Lemma 5.2 we have $\kappa_i(1) < \delta_i$. Besides, as R tends to infinity, every ρ_j tends to $\frac{\pi}{2}$. This implies that $\kappa_i(1)$ is close to δ_i for R sufficiently large; in particular $\kappa_i(1) > 0$. Thus we have

$$0 < \kappa_i(1) < \delta_i \quad \text{for all } i. \quad (40)$$

By Corollary 2, this implies that the Jacobian of (39) at $r(1)$ is non-degenerate. The Lemma follows from the inverse function theorem. \square

Lemma 4.2 *If $r : (t_0, 1] \rightarrow \mathcal{P}(M)$ and $r' : (t'_0, 1] \rightarrow \mathcal{P}(M)$ are two lifts of the path (36), then they coincide on $(t_0, 1] \cap (t'_0, 1]$.*

The maximum interval where the lift exists is open in $(0, 1]$.

Proof. Assume the converse to the first statement of the lemma. Let

$$t_1 = \inf\{t \mid r(t) = r'(t)\}.$$

Then we have $r(t_1) = r'(t_1)$. By (36) and (40), we have

$$0 < \kappa_i(t_1) < \delta_i \quad \text{for all } i.$$

Let us show that $r(t_1)$ is an interior point of $\mathcal{P}(M)$. If $r(t_1)$ is a boundary point of $\mathcal{P}(M)$, then by Proposition 4, $r(t_1)$ is also a boundary point of $\mathcal{D}(M)$. This means that one of the inequalities (8) or (9) becomes an equality after the substitution of $r^2(t_1)$ for q . If we have equality in (8), then the spherical section at the vertex j contains a boundary geodesic arc of length at least π . This contradicts Lemma 5.3. If an equality in (9) is achieved, then in the pyramid over the triangle iji the vertex j is the foot of the altitude. This implies $\kappa_j(t_1) = \delta_j$ that contradicts to (40).

By Corollary 2 and inverse function theorem, the lift is unique in a neighborhood of t_1 . This implies the first statement of the lemma.

The same argument shows that a lift on any closed interval $[t_1, 1] \subset (0, 1]$ can be extended to a neighborhood of t_1 . This implies the second statement of the lemma. \square

Let $(t_0, 1] \subset (0, 1]$ be the maximum interval where the lift of (36) exists. We have to prove $t_0 = 0$.

Lemma 4.3 *Let $(t_0, 1] \subset (0, 1]$ be the maximum interval where the lift $r : (t_0, 1] \rightarrow \mathcal{P}(M)$ exists, and let $t_0 > 0$. Assume that there is a sequence (t_n) in $(t_0, 1]$ such that t_n converges to t_0 and $r(t_n)$ converges to a point r in $\mathcal{P}(M)$. Then the path $r : (t_0, 1] \rightarrow \mathcal{P}(M)$ can be extended to t_0 in a C^1 way by putting $r(t_0) = r$.*

Proof. Let κ_i be the curvatures at the point $r = \lim_{n \rightarrow \infty} r(t_n)$. Since $\kappa_i(t_n) = t_n \cdot \kappa_i(1)$ and due to the continuity of the map (39), we have $\kappa_i = t_0 \cdot \kappa_i(1)$. Therefore $0 < \kappa_i < \delta_i$. As in the proof of Lemma 4.2, this implies that r is an interior point of $\mathcal{P}(M)$. Besides, by Corollary 2, the Jacobian of the map (39) at r is non-degenerate. Thus (39) maps a neighborhood U of r diffeomorphically to a neighborhood V of κ . For n large enough, $r(t_n)$ lies in U . Since the path $\kappa(t)$ is regular at $t = t_0$, the path $r(t)$ extends smoothly to a neighborhood of t_0 . \square

In order to show $t_0 = 0$ it suffices to find a sequence (t_n) as in Lemma 4.3. It is not hard to satisfy the condition that $r(t_n)$ converges: one needs only boundedness of r on $(t_0, 1]$ which is proved in Lemma 4.4 below. A major problem is to show that the limit lies in $\mathcal{P}(M)$, Lemmas 4.5–4.8.

Definition 4.1 *The spherical section of a generalized convex polytope P is a sphere with a spherical polyhedral metric that is obtained by gluing together the sections of constituting pyramids of P with the center at the apex.*

Clearly, the curvatures of the spherical section equal the curvatures of the polytope. The area of the spherical section can be computed as

$$\text{area}(S) = 4\pi - \sum_i \kappa_i. \quad (41)$$

For a generalized convex polytope $P(t)$ denote its spherical section by $S(t)$. Instead of $P(t_n)$ and $S(t_n)$ we write briefly P_n and S_n .

Lemma 4.4 *Let $r : (t_0, 1] \rightarrow \mathcal{P}(M)$ be a lift of the path (36) through the map (39) for some $t_0 \geq 0$. Then r is bounded on $(t_0, 1]$.*

Proof. Assume that $r_i(t) > C$ for some $t \in (t_0, 1]$, some i , and some large C . Then the triangle inequality in the metric space $P(t)$ implies that $\text{dist}(0, x) > C - \text{diam}(M)$ for any $x \in M$, where 0 stands for the apex of $P(t)$. We claim that

$$\text{area}(S(t)) < \frac{\text{area}(M)}{(C - \text{diam}(M))^2}. \quad (42)$$

For C large enough this contradicts to

$$\text{area}(S(t)) = 4\pi - \sum_i \kappa_i(t) > 4\pi - \sum_i \kappa_i(1) = \text{area}(S(1)).$$

In order to prove (42), consider a constituting pyramid of $P(t)$. Denote by α its solid angle at the apex, and by A the area of its base. By our assumption, the distance from the apex to any point of the base is larger than $C - \text{diam}(M)$. It follows that the Jacobian of the central projection of the base to the unit sphere centered at the apex is less than $(C - \text{diam}(M))^{-2}$. Thus we have $\alpha < A(C - \text{diam}(M))^{-2}$. This implies the inequality (42), and the lemma is proved. \square

It follows that there is a sequence (t_n) such that $r(t_n)$ converges to some point $r \in \mathbb{R}^n$. Let \tilde{q}_n be the Q -concave PQ -function on M that takes value r_i^2 at the singularity i , for all i . Recall that \tilde{q}_n is the squared distance from the apex of the polytope P_n to its boundary M , and that the space $\mathcal{P}(M)$ is identified with the space of positive Q -concave PQ -functions on M , see Lemma 2.1. By property 5. from Proposition 3, \tilde{q}_n depends continuously on $r(t_n)$ in the L^∞ -metric. Since the space $\mathcal{D}(M)$ of all Q -concave PQ -functions is closed, this implies that the sequence (\tilde{q}_n) converges uniformly to a Q -concave PQ -function \tilde{q} . Function \tilde{q} takes value r_i at the singularity i , for all i , and is non-negative. If \tilde{q} is positive, then the point r lies in $\mathcal{P}(M)$, and we are done. Otherwise there is a point $x \in M$ such that $\tilde{q}(x) = 0$. Geometrically this means that in the polytopes P_n the apex tends to the point $x \in M = \partial P_n$. Since the decomposition $\mathcal{P}(M) = \cup_T \mathcal{P}^T(M)$ is locally finite by Proposition 4, we can assume, replacing (t_n) by its subsequence when needed, that all of the polytopes P_n have the same triangulation $T(t_n) = T$. Now there are three possibilities: x lies in the interior of a face of T , or x lies in the interior of an edge of T , or x is a singularity i of M .

Lemma 4.5 *The point x cannot be an interior point of a face of T .*

Proof. Assume the converse. Let $\Delta \in \mathcal{F}(T)$ be the triangle that contains x in the interior, and denote by $S\Delta_n$ the corresponding spherical triangle in S_n . As $n \rightarrow \infty$, the spherical triangle $S\Delta_n$ tends to a hemisphere, and its angles tend to π . There are no self-identifications on the boundary of $S\Delta_n$, because $\kappa_i(t_n) \rightarrow \kappa_i(t_0) > 0$. Therefore the complement $S\Delta'_n$ to $S\Delta_n$ in S_n is a singular spherical triangle in the sense of Definition 5.1. If i is a vertex of Δ , then the angle of $S\Delta'_n$ at i tends to $\pi - \kappa_i(t_0)$. The side lengths of $S\Delta'_n$ also have limits as $n \rightarrow \infty$, these are the angles under which the sides of the triangle Δ are seen from the point x . On the other hand, the perimeter of $S\Delta'_n$ equals the perimeter of $S\Delta_n$ that tends to 2π . Therefore, for sufficiently large n we get a contradiction to Lemma 5.4. \square

Lemma 4.6 *The point x cannot be an interior point of an edge of T .*

Proof. Assume that x is an interior point of an edge $ij \in \mathcal{E}(T)$. Let $\Delta^1, \Delta^2 \in \mathcal{F}(T)$ be the triangles incident to ij , and let $S\Delta_n^1, S\Delta_n^2$ be their spherical images in the spherical section of the polytope P_n . Consider the spherical quadrilateral $S\Diamond_n = S\Delta_n^1 \cap S\Delta_n^2$. As n goes to ∞ , the length of the diagonal ij in $S\Diamond_n$ tends to π . At the same time, the side lengths of $S\Diamond_n$ have limits different from 0 and π . The angles of $S\Diamond_n$ opposite to the diagonal ij tend to π , whereas the angles α_n and β_n at the vertices i and j may have no limits. However, the convexity of P_n implies that

$$\liminf \alpha_n \geq \pi \quad \text{and} \quad \liminf \beta_n \geq \pi.$$

It follows that there are no self-identifications on the boundary of $S\Diamond_n$, thus its complement $S\Diamond'_n$ is a singular spherical quadrilateral. The perimeter of $S\Diamond'_n$ tends to 2π , whereas its side lengths have limits different from 0 and π . Also, due to

$$\lim_{n \rightarrow \infty} \kappa_k(t_n) = t_0 \cdot \kappa_k(1) > 0 \quad \text{for all } k,$$

the angles of $S\Diamond'_n$ have upper limits less than π . This contradicts Lemma 5.4. \square

The most delicate case is when x is a singularity of M . To deal with it we need the hard Lemma 5.5.

Lemma 4.7 *Function \tilde{q} cannot vanish at more than one vertex of T .*

Proof. Assume $\tilde{q}(i) = 0$, that is $r_i = 0$. Consider the star sti of the vertex i in the triangulation T and its spherical image $S(sti)_n$ in S_n , see Figure 9. Here all of the angles and lengths depend on n . Denote by

$$\eta_j(n) = \omega_{jki}(n) + \omega_{jli}(n)$$

the angle at the vertex j in $S(sti)_n$. We have

$$\text{area}(S(sti)_n) = 2\pi - \kappa_i(t_n) - \sum_{j \in \text{lk } i} (\pi - \eta_j(n)).$$

By convexity of P_n ,

$$\liminf_{n \rightarrow \infty} \eta_j(n) \geq \pi. \tag{43}$$

Therefore we have

$$\liminf_{n \rightarrow \infty} \text{area}(S(sti)_n) \geq 2\pi - t_0 \cdot \kappa_i(1).$$

On the other hand, by (41)

$$\lim_{n \rightarrow \infty} \text{area}(S_n) = 4\pi - t_0 \cdot \sum_i \kappa_i(1).$$

Thus by the first part of Lemma 5.5 we have

$$\liminf_{n \rightarrow \infty} \text{area}(S(sti)_n) > \frac{1}{2} \lim_{n \rightarrow \infty} \text{area}(S_n). \quad (44)$$

Now, if there is another singularity m such that $r_m \rightarrow 0$, then the stars of i and m have disjoint interiors. On the other hand, by (44) both $S(sti)_n$ and $S(stm)_n$ make at least a half of S_n , for n large enough. This contradiction proves the lemma. \square

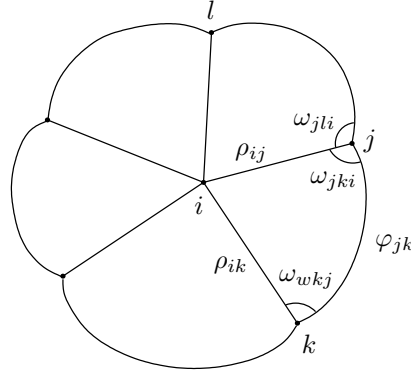

Figure 9: The spherical image of the star of vertex i as r_i tends to 0.

Lemma 4.8 *Function \tilde{q} cannot vanish at a vertex of T .*

Proof. It is easy to see that

$$\lim_{n \rightarrow \infty} \varphi_{jk}(n) = \gamma_{ijk}, \quad (45)$$

where γ_{ijk} is the angle at the vertex i in the Euclidean triangle $ijk \in \mathcal{F}(T)$. Consider the angles $\omega_{kji}(n), \omega_{jki}(n), \omega_{jli}(n)$ and so on, and call them the *base angles* of the star. The base angles can behave badly. By choosing a subsequence if needed, we can assume that there exist limits

$$\lim_{n \rightarrow \infty} \omega_{jki}(n) = \omega_{jki} \in [0, \pi] \quad \text{etc.}$$

Case 1. The star of i does not degenerate, that is the limits of all of the base angles are in $(0, \pi)$. In this case the sequence of spherical sections (S_n) converge to a spherical polyhedral metric that satisfies all of the assumptions of Lemma 5.5. Here the distinguished singularity 0 is the vertex i , and the

star polygon C is the limit of the stars $S(sti)_n$. Angles of C are greater or equal π because of the convexity of the polytope P_n . Note that the curvatures of the resulting polyhedral metric equal $t_0 \cdot \kappa_i(1)$ for all $i \in \mathcal{V}(T)$. Thus by (56) we have

$$\kappa_i(1) \geq \left(1 - \frac{\text{per}(C)}{2\pi}\right) \sum_{j \neq i} \kappa_j(1). \quad (46)$$

Because of (45) and (40) we have

$$\text{per}(C) = 2\pi - \delta_i < 2\pi - \kappa_i(1).$$

Therefore (46) implies

$$\sum_{j \neq i} \kappa_j(1) < 2\pi. \quad (47)$$

On the other hand, we have

$$\sum_{j \neq i} \delta_j > 2\pi,$$

since $\sum_{j \in \Sigma} \delta_j = 4\pi$ and $\delta_i < 2\pi$. But, if the number R was chosen sufficiently large, then $\kappa_j(1)$ are close to δ_j (see the proof of Lemma 4.1) and also satisfy $\sum_{j \neq i} \kappa_j(1) > 2\pi$. This contradicts the equality (47), and Case 1. is excluded.

Let us show that if some of the base angles tends to 0 or π , then we can assume without loss of generality

$$\omega_{kji} = \pi, \quad \omega_{jki} > 0. \quad (48)$$

Let one of the base angles tend to π , say $\omega_{kji} = \pi$. If (48) fails, then $\omega_{jki} = 0$. Then (43) implies $\omega_{jli} = \pi$. If $\omega_{lji} > 0$, then after relabeling we have (48). So again $\omega_{lji} = 0$. Proceeding in this manner we show that all of the base angles tend to 0 or π depending on their orientation. But this implies

$$\rho_{ik}(n) < \rho_{ij}(n) < \rho_{il}(n) < \cdots < \rho_{ik}(n),$$

for a sufficiently large n . We obtain a similar chain of inequalities if we assume that one of the base angles tends to 0, and 48 fails for any edge $ij \in \text{lk } i$. This contradiction shows that we may assume (48).

Case 2. We have $\omega_{kji} = \pi, \omega_{jki} \in (0, \pi)$. This implies

$$\lim_{n \rightarrow \infty} \rho_{ij}(n) = \pi, \quad \lim_{n \rightarrow \infty} \omega_{lji} = \pi.$$

To the spherical quadrilateral $ikjl$ the same argument as in the proof of Lemma 4.6 can be applied and leads to a contradiction.

Case 3. We have $\omega_{kji} = \omega_{jki} = \pi$. We may assume that the limits

$$\lim_{n \rightarrow \infty} \rho_{ij}(n) = \rho_{ij}, \quad \lim_{n \rightarrow \infty} \rho_{ik}(n) = \rho_{ik}$$

exist. If both are less than π , then we apply the argument from Lemma 4.5 to the spherical triangle ijk . If $\rho_{ij} = \pi$, then both ρ_{ik} and ρ_{il} are less than π . Then we consider the spherical quadrilateral $ikjl$ and apply to it the argument of Lemma 4.6. \square

We proved that $t_0 = 0$ for the maximum lift $r : (t_0, 1] \rightarrow \mathcal{P}(M)$. Thus the existence of a family of generalized convex polytopes $\{P(t) \mid t \in (0, 1]\}$ that satisfies the properties 1.–3. from Theorem 6 is established. It remains to show that $P(t)$ converges to a convex polytope P with a marked point a as described in the property 5.

Lemma 4.9 *Let (t_n) be a sequence in $(0, 1]$ with $\lim_{n \rightarrow \infty} t_n = 0$ such that there exist the limits*

$$r_i(0) = \lim_{n \rightarrow \infty} r_i(t_n) \quad \text{for all } i. \quad (49)$$

Then there exists a convex polytope $P \subset \mathbb{R}^3$ with boundary isometric to M and a point $a \in P$ such that $r_i(0) = \|p_i - a\|$, where p_i are the vertices of P .

Proof. The lemma is obvious if $r(0) \in \mathcal{P}(M)$. Then $r(0)$ defines a generalized polytope $P(0)$ with curvatures

$$\kappa_i(0) = \lim_{n \rightarrow \infty} \kappa_i(t_n) = 0.$$

Therefore $P(0)$ is isometric to a convex polytope $P \subset \mathbb{R}^3$ with a marked interior point a .

In the general case the following argument works. We may assume that all triangulations $T(t_n)$ are equal to some triangulation T . For every edge $ij \in \mathcal{E}(T)$ consider the dihedral angle $\theta_{ij}(t)$ of the polytope $P(t)$ at ij . Angles $\theta_{ij}(t)$ vary in $(0, \pi]$, so after choosing a subsequence, if needed, we have the limits

$$\lim_{n \rightarrow \infty} \theta_{ij}(t_n) = \theta_{ij} \in [0, \pi].$$

Now pick up a face $F \in \mathcal{F}(T)$ and place it in \mathbb{R}^3 . The radii $r_i(0)$ for $i \in F$ determine the position of the point a , up to the choice of an orientation. The dihedral angles at the edges of F determine the positions of the faces adjacent to F . Besides, the condition $r_i(0) = \|p_i - a\|$ is satisfied for the new vertices. The new faces determine the positions of their neighbors, and so on. The faces fit nicely and bound a convex polytope, if they fit around every vertex. Consider the sequence of spherical sections S_n^i at the vertex i in the generalized polytopes $P(t_n)$. This is a sequence of singular star polygons

with the angles $\theta_{ij}(t_n)$, curvature $\kappa_i(t_n)$ and fixed edge lengths. It is not hard to prove that S_n^i converges to a convex spherical polygon with angles θ_{ij} , possibly degenerated to a doubly-covered spherical arc. This means that the faces around the vertex i can be put together. \square

Note that we just proved the existence part of Alexandrov's theorem. However, properties 4. and 5. are still to be proved.

Due to Lemma 4.4, the radii $r_i(t)$ are bounded on $(0, 1]$. Therefore there is a sequence $t_n \rightarrow 0$ such that the limits (49) exist. By Lemma 4.9, this gives a convex polytope P and a point $a \in P$. By the uniqueness part of Alexandrov's theorem, the polytope P does not depend on the choice of a sequence (t_n) . It remains to prove that the point a is also independent of this choice. We will show that the point a satisfies the condition (37) and that the condition (37) defines the point uniquely. This will imply the properties 4. and 5. and thus will complete the proof of Theorem 6.

Let S_n be the spherical section of the generalized polytope $P(t_n)$, see Definition 4.1.

Lemma 4.10 *Suppose that S_n converges to a spherical section S with the vertices v_i . Then the following equality holds:*

$$\sum_i \kappa_i(1)v_i = 0. \quad (50)$$

Some explanations are necessary. The spherical section S_n inherits from the generalized polytope $P(t_n)$ the triangulation $T(t_n)$. We say that the sequence of spherical sections S_n converges, if $T(t_n) = T$ for almost all n , and for every triangle $\Delta \in \mathcal{F}(T)$ the angles and the side lengths of its spherical image $S\Delta_n$ converge. If (t_n) is as in Lemma 4.9, and the point a is in the interior of P , then the sequence S_n converges to the spherical section S of the polytope P viewed as a generalized polytope with the apex a . If a is an interior point of a face of P , then S_n converges to a spherical section S that contains one degenerate triangle with all angles equal to π . If a is an interior point of an edge, then S_n does not necessarily converge, but can be replaced by a converging subsequence. The limit section S contains two degenerate triangles. In each of these cases the vertices of the section S are the unit vectors directed from a to p_i :

$$v_i = \frac{p_i - a}{\|p_i - a\|}.$$

Finally, suppose $a = p_i$. Then S_n contains a converging subsequence. Its limit S may contain degenerate triangles in the star of i . However, S has all curvatures zero and defines a unit vector v_i , "the direction from a to p_i ".

Proof of Lemma 4.10. In the spherical section S_n mark one of the singularities by 1 and join it by geodesic arcs to all of the other singularities.

The geodesics will not pass through singularities since they have positive curvature. Mark the other singularities by $2, \dots, m$ in the clockwise order around 1. Cut S_n along the geodesic arcs and develop the result onto the unit sphere \mathbb{S}^2 . Denote by $v_i(n)$ the images of the singularities $i, 2 \leq i \leq m$, and by $v_1(n)$ the image of 1 that lies between m and 2. See Fig. 10, where we omitted the index n . Clearly, by suitable rotations of \mathbb{S}^2 we can achieve $\lim_{n \rightarrow \infty} v_i(n) = v_i$.

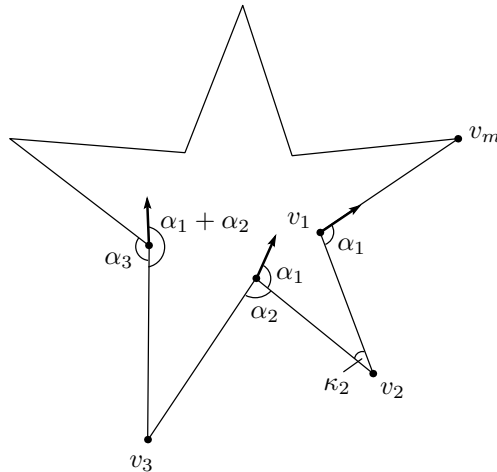

Figure 10: Spherical section S_n developed onto the unit sphere. The development is the exterior of the star.

Let $R_i \in SO(3)$ be the rotation around the vector $v_i(n)$ by the angle $\kappa_i(t_n)$. We claim that

$$R_m \circ \dots \circ R_2 \circ R_1 = \text{id}. \quad (51)$$

Indeed, from Fig. 10 it is clear that $R_m \circ \dots \circ R_2(v_1(n)) = v_1(n)$. On the same figure the trajectory of a tangent vector at the point $v_1(n)$ is shown. The vector gets rotated by the angle $\alpha_1(n) + \dots + \alpha_{m-1}(n) = \omega_1(n) = 2\pi - \kappa_1(n)$. The equality (51) follows.

Since $\kappa_i(t_n) = t_n \cdot \kappa_i(1)$, we have for any vector $x \in \mathbb{R}^3$

$$R_i(x) = x + t_n \cdot \kappa_i(1)[v_i(n), x] + o(t_n),$$

where $[\cdot, \cdot]$ denotes the cross product. Then (51) implies

$$\begin{aligned} x = R_m \circ \dots \circ R_2 \circ R_1(x) &= x + \sum_{i=1}^m t_n \cdot \kappa_i(1)[v_i(n), x] + o(t_n) \\ &= x + t_n \cdot \left[\sum_{i=1}^m \kappa_i(1)v_i(n), x \right] + o(t_n). \end{aligned}$$

It follows

$$\sum_{i=1}^m \kappa_i(1)v_i(n) = o(1),$$

and since $v_i(n) \rightarrow v_i$, we have (50). \square

Remark. When a is an interior point of the polytope P , Lemma 4.10 can be proved using Proposition 9 and the fact that the matrix $(\frac{\partial \kappa_i}{\partial r_j})$ is symmetric.

Lemma 4.11 *Let $P \subset \mathbb{R}^3$ be a convex polytope with the vertices p_1, \dots, p_m . Let δ_i be the angular defect at the vertex p_i . Then there exists a unique point $a = a(P)$ in the interior of P (in the relative interior, if P is 2-dimensional) such that*

$$\sum_{i=1}^m \delta_i \frac{p_i - a}{\|p_i - a\|} = 0. \quad (52)$$

Proof. Consider the function $f : P \rightarrow \mathbb{R}$,

$$f(x) = \sum_{i=1}^m \delta_i \cdot \|p_i - x\|.$$

It is differentiable everywhere except the vertices of P , and

$$\text{grad} f(x) = - \sum_{i=1}^m \delta_i \frac{p_i - x}{\|p_i - x\|}.$$

Thus we are looking for the critical points of the function f . Let a be the point of the global minimum of f :

$$f(a) = \min_{x \in P} f(x).$$

Let us show that a is a (relative) interior point of P . Indeed, if a is a boundary point of P and not a vertex, then the vector $-\text{grad} f$ at a is directed inside P (which should be understood appropriately if P is 2-dimensional). Thus a cannot be even a local minimum. Assume now $a = p_i$. Then it is easy to see that

$$\delta_i \geq \left| \sum_{j \neq i} \delta_j \frac{p_j - p_i}{\|p_j - p_i\|} \right|.$$

But this contradicts Lemma 5.6. The existence of a point a that satisfies (52) is proved. The uniqueness follows from the concavity of the function f . \square

If the numbers $\kappa_i(1)$ are sufficiently close to δ_i , then Lemma 5.6 and hence Lemma 4.11 hold also with δ_i replaced by $\kappa_i(1)$. Due to Lemma 4.10 this implies that for any sequence (t_n) such that $P(t_n)$ converges to a convex polytope P , the apex of $P(t_n)$ converges to the point $a \in P$ characterized by (37). Theorem 6 is proved.

5 Lemmas from spherical geometry

Lemmas of this section deal with spherical cone structures on the disk or on the sphere. We consider only spherical cone structures with positive curvatures at singularities.

Lemma 5.1 *The angles α, β, γ of a spherical triangle as functions of side lengths a, b, c have the following partial derivatives:*

$$\frac{\partial \alpha}{\partial a} = \frac{1}{\sin b \sin \gamma}, \quad (53)$$

$$\frac{\partial \alpha}{\partial b} = -\frac{\cot \gamma}{\sin b}. \quad (54)$$

The angles α, β, γ of a Euclidean triangle as functions of side lengths a, b, c have the following partial derivatives:

$$\frac{\partial \alpha}{\partial a} = \frac{1}{b \sin \gamma},$$

$$\frac{\partial \alpha}{\partial b} = -\frac{\cot \gamma}{b}.$$

Proof. Direct calculation using spherical and Euclidean cosine and sine theorems. \square

As a technical tool we will use *merging of singularities*. Consider two cone points A and B with curvatures α and β on a surface with spherical cone structure. Suppose that there is a geodesic arc joining A and B . Such an arc always exists, if all cone points have positive curvature, and the boundary of the surface is convex. Cut the surface along this arc and paste in a singular digon that is formed by two copies of a triangle ABC with angles $\frac{\alpha}{2}$ and $\frac{\beta}{2}$ at vertices A and B , identified along the sides AC and BC . The points A and B become regular, instead there appears a new cone point C . Note that the curvature of C is less than $\alpha + \beta$.

Definition 5.1 *A singular spherical polygon is a 2-disk equipped with a spherical polyhedral metric with piecewise geodesic boundary. It is called convex, if the angles at the boundary vertices don't exceed π . A convex star polygon is a convex singular spherical polygon with a unique singularity.*

The area of a singular spherical polygon can easily be computed:

$$\text{area} = 2\pi - \sum_i \kappa_i - \sum_j (\pi - \theta_j), \quad (55)$$

where κ_i 's are the curvatures of singularities, and θ_j are the angles of the polygon, $\pi - \theta$ thus being the outer angles.

A convex star polygon can be cut into a collection of spherical triangles by a set of geodesic arcs joining the singularity to the boundary. Or, other way round, a convex singular spherical polygon can be specified as a result of gluing spherical triangles around a common vertex. On Fig. 11 we introduce notation for arc lengths and angles of a star polygon defined by a gluing procedure. We allow $\alpha_j + \beta_j = \pi$ for some j , also we allow a polygon be glued from a single triangle, two sides of the triangle identified. Denote

$$\kappa = 2\pi - \sum_j \omega_{j-1,j}$$

the curvature of the singularity, and

$$\delta = 2\pi - \sum_j \lambda_{j-1,j} = 2\pi - \text{per},$$

where per stands for perimeter.

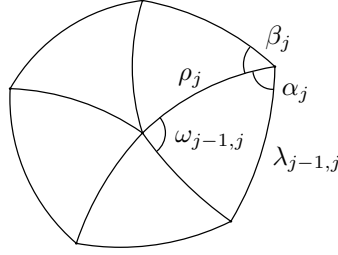

Figure 11: Angles and lengths in a convex star polygon.

Lemma 5.2 *If in a convex star polygon $\rho_j < \frac{\pi}{2}$ holds for all j , then $\kappa < \delta$.*

Proof. Consider the angles as functions of arc lengths. By formula (54),

$$\frac{\partial \kappa}{\partial \rho_j} = \frac{\cot \alpha_j + \cot \beta_j}{\sin \rho_j} \geq 0.$$

It is not hard to show that by increasing ρ_j 's and leaving boundary edges constant we can deform any polygon with $\rho_j < \frac{\pi}{2}$ into a polygon with $\rho_j = \frac{\pi}{2}$ for all j . If $\rho_j = \frac{\pi}{2}$ for all j , then $\kappa = \delta$. Hence the statement of the Lemma. \square

Lemma 5.3 *If in a convex star polygon P holds $0 < \kappa < \delta$, then its boundary cannot contain a geodesic arc of length π or more.*

Proof. Let us assume the converse. Choose on the boundary of P two points A and B that divide the boundary in two curves L and L' such that L is geodesic and has length $|L| = \pi$. Cut P in two spherical polygons C and

C' by geodesic arcs OA and OB , where O is the singularity of P and C contains L in its boundary. Clearly, the polygon C is a spherical lune. Thus it has angle π at the vertex O . Denote by γ the angle of the polygon C' at the vertex O . We have $\gamma = \pi - \kappa < \pi$. Thus C' is convex and contains a geodesic arc AB . Consider the triangle ABO contained in C' , and denote its side lengths a, b , and c .

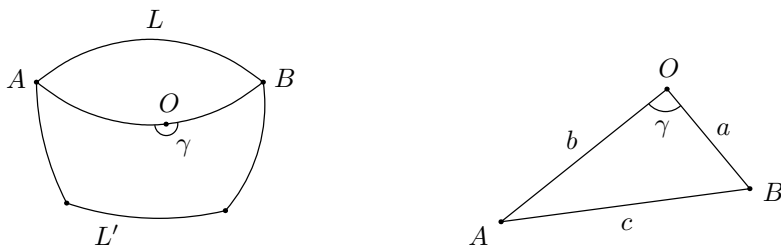

Figure 12: To the proof of Lemma 5.3.

We have

$$\begin{aligned}\kappa &= \pi - \gamma, \\ \delta &= \pi - |L'| \leq \pi - c.\end{aligned}$$

Also $a + b = \pi$. By the spherical cosine theorem,

$$\begin{aligned}\cos c &= \cos a \cos b + \sin a \sin b \cos \gamma \\ &= -\cos^2 a + \sin^2 a \cos \gamma.\end{aligned}$$

It follows

$$1 + \cos c = \sin^2 a(1 + \cos \gamma) < 1 + \cos \gamma.$$

Thus $c > \gamma$ and $\kappa > \delta$ which is a contradiction. \square

Lemma 5.4 *For any $0 < c_1 < c_2 < \pi$ and $\gamma > 0$ there exists an $\varepsilon > 0$ such that the following holds. Any convex singular spherical polygon with all side lengths between c_1 and c_2 and all outer angles greater than γ has perimeter less than $2\pi - \varepsilon$.*

In other words, a polygon with outer angles not too small and sides neither too large nor too small cannot have perimeter too close to 2π . Note that the lemma is false if the polygon is allowed to have singularities of negative curvature.

Proof. First consider the case when the polygon is non-singular. Let a be the length of one of its sides. Then the polygon is contained in the spherical triangle with one side of length a and both adjacent angles $\pi - \gamma$; hence its perimeter is less than that of this triangle. For a between c_1 and c_2 the

perimeters of corresponding triangles are uniformly bounded from above by $2\pi - \varepsilon$ for some $\varepsilon > 0$. Thus in the non-singular case assumptions of the Lemma can be weakened: inequalities for one side and two adjacent angles already suffice.

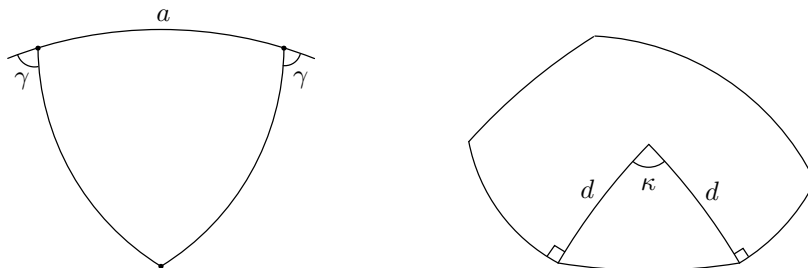

Figure 13: To the proof of Lemma 5.4.

If the polygon is singular, merge all of its singularities consecutively. Let κ be the curvature of the resulting star polygon P . The merging changes neither the sides nor the angles of the polygon, so it suffices to prove the Lemma for the polygon P . If P has only one or two sides, then its perimeter is less than $2c_2$. Otherwise draw the shortest arc joining the singularity to the boundary of the polygon P ; let d be its length. We claim that $d < \frac{\pi}{2}$. Indeed, embed P into the sphere with two singularities of curvature κ . This sphere is obtained from the usual sphere by removing a lune of angle κ and identifying the boundary semicircles. If $d \geq \frac{\pi}{2}$, then the κ -sphere can be covered by two copies of P . Hence the area of P has to be at least $2\pi - \kappa$. But it is smaller than this by formula (55). Thus $d < \frac{\pi}{2}$. Cut along the shortest arc and glue to the sides of the cut an isosceles triangle with the angle κ at the vertex. Due to $d < \frac{\pi}{2}$ the angles at its base are less than $\frac{\pi}{2}$. Thus the resulting non-singular polygon is convex. Besides, at least one of its sides together with the adjacent angles satisfy assumptions of the Lemma. By the previous paragraph, the perimeter of the resulting polygon is less than $2\pi - \varepsilon$. Then so is the perimeter of the initial singular polygon. \square

Lemma 5.5 *Let a spherical polyhedral metric on the sphere be given, with all of the singularities of positive curvature. Let one of the singularities be labeled by 0. Then*

$$\kappa_0 \leq \sum_{i \neq 0} \kappa_i.$$

Suppose additionally that the singularity 0 is the center of a star polygon C with vertices at some of the other singularities and all angles at least π . Let

$\text{per}(C)$ denote the perimeter of C . Then the following inequality holds:

$$\kappa_0 \geq \left(1 - \frac{\text{per}(C)}{2\pi}\right) \sum_{i \neq 0} \kappa_i. \quad (56)$$

Proof. To prove the first inequality, merge consecutively all the singularities except of 0. The result is the sphere with two singularities of curvature κ_0 . Since merging decreases the total curvature, the result follows.

The proof of the second part of the Lemma is much more involved. Denote by D the convex singular polygon that is the complement to the star polygon C . We make D non-singular, increasing at the same time the right hand side of (56). This is done by a sequence of operations inverse to merging of singularities. Choose a vertex of D , denote it by 1 and join it to a singularity i in the interior of D by the shortest arc a_i . Extend the arc a_i beyond i by a geodesic b_i such that the two angles between a_i and b_i are equal. The arc b_i ends either at some other singularity j or on the boundary of D . If the latter is the case and if D contains two spherical triangles with the sides a_i and b_i , then say that we have good luck. In this case we cut both triangles out and glue their remaining sides together, see Figure 14. This splitting of the singularity i increases the right hand side of (56), because it does not change the perimeter and increases the sum $\sum_{i \neq 0} \kappa_i$. On the other hand it decreases the number of singularities inside D , so that we can proceed inductively. In the case of bad luck draw the arcs a_j and b_j for all singularities j from the vertex 1. Then the arc b_i crosses some a_j or b_j . The former is not possible because then a_j is not the shortest. If b_i ends at the singularity j without crossing any b_k before this, then we cut out a pair of equal triangles with vertices i, j and 1, thus decreasing the number of singularities. Finally, if b_i crosses the interior b_j at the point B_{ij} , we can assume without loss of generality that neither of the arcs iB_{ij} and jB_{ij} is crossed by some b_k . Then we can cut out two pairs of equal triangles with the common vertex B_{ij} and again reduce the number of singularities.

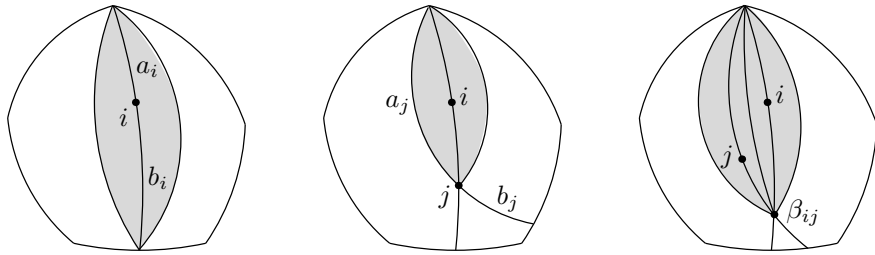

Figure 14: Splitting the singularities inside the singular polygon D .

Now the Lemma is reduced to the case of non-singular D . Embed the star polygon C into the sphere with two singularities of curvature κ_0 and denote by D' its complement. Denote by θ_i and θ'_i the respective angles of

D and D' . We have $\theta'_i - \theta_i = \kappa_i > 0$, whereas the respective sides of D and D' are equal, see Figure 15. Therefore the inequality (56) can be viewed as a comparison inequality between a usual spherical polygon D and a star polygon D' , both D and D' convex.

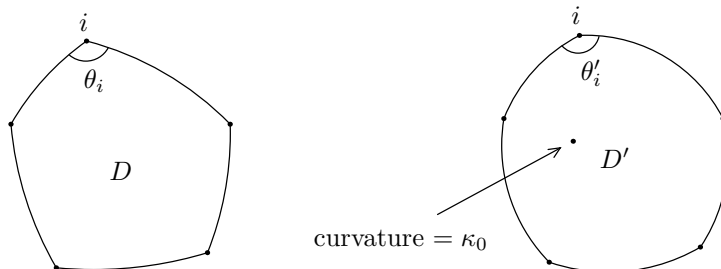

Figure 15: A convex polygon D and a convex singular polygon D' ; $\theta'_i - \theta_i = \kappa_i$.

Note that the star polygon D' is completely determined by the polygon D and angle differences κ_i . To see this, cut D' along a geodesic joining the central singularity with any vertex and develop the result on the sphere. On the other hand, a procedure similar to the merging of singularities allows us to obtain D' from D as follows. Cut D along a diagonal ij and glue in a digon with the angles κ_i and κ_j . The result is a star polygon with the angles θ'_i and θ'_j at the vertices i and j , respectively. Then glue in a digon between a boundary vertex k and the central singularity so that the singularity disappears and the angle at k becomes θ'_k . This yields a new convex star polygon, and so on.

If $\theta_i = \theta'_i$ for some i , then the above transformation of D into D' does not involve the vertex i at all. If D and D' have more than two sides, this implies that the polygon D' contains a non-singular triangle Δ'_i spanned by the sides incident to the vertex i . The triangle Δ'_i is congruent to the corresponding triangle Δ_i in D . If we cut both triangles off, then we get a new couple of polygons with the same κ_0 and $\sum_{i \neq 0} \kappa_i$ but with a smaller perimeter. Thus the inequality (56) for the new couple implies (56) for the old.

The rest of the proof goes by induction on the number of sides: we carefully deform D until θ_i becomes equal to θ'_i for some i , and cut off the triangles Δ and Δ' as in the previous paragraph. The induction base is two sides: D is a doubly covered segment, D' is a symmetric star digon. Let us deal with the induction step first. Suppose that D has three or more sides, and $\theta'_i > \theta_i$ for all i . Choose a vertex i and denote by a and b the lengths of the adjacent sides. Denote by c the length of the diagonal in D (or side, if D is the triangle) that forms a triangle together with these two sides. Without loss of generality, $a \leq b$. Consider the following deformation of D . All of the vertices except of i stay fixed, and i moves so that the sum $a + b$ remains

constant and a decreases. Define the corresponding deformation of D' as follows. Develop D' onto the sphere by cutting it along a radius that ends at a vertex other than i . The deformation leaves all of the vertices of the development fixed, except of i that moves so that $a + b$ remains constant and a decreases, as in D . Denote by c' the length of the diagonal that corresponds to the diagonal c in D . See Figure 16.

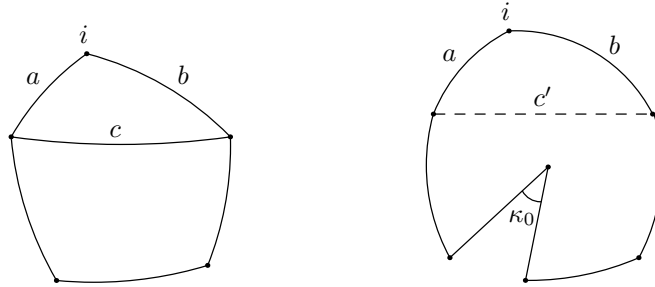

Figure 16: Polygon D and singular polygon D' cut along a radius.

Clearly, the deformation of D' does not change κ_0 . By construction, the perimeter of D and D' is also constant. As we will show, the deformation increases the sum $\sum \kappa_i$. This implies that during the deformation the left hand side of (56) remains constant, whereas the right hand side increases. The deformation stops in one of the following cases.

We get $\theta_j = \theta'_j$ for some j . Then we cut off the triangles Δ and Δ' at the vertex j and use the induction assumption.

We get $\theta'_j = \pi$ for some j . In this case we start the deformation that affects the vertex j . It does not change the angles of D' , so it has to end for a different reason.

The polygon D is a triangle and it degenerates so that $b = a + c$. In this case D' degenerates to a symmetric digon. This is the induction base.

The side b hits the image of the singularity in the development of D' . This is impossible, because if the singularity is close to the boundary of D' but far from its vertices, then κ_0 is small. This follows from the transformation of D into D' by gluing in digons as described before.

In order to show that $\sum \kappa_i$ increases during the deformation of D and D' , consider the triangle with side lengths a, b, c and the triangle with side lengths a, b, c' . It is not hard to see that

$$d \sum \kappa_i = \text{darea}' - \text{darea},$$

where area and area' are the areas of the first and of the second triangle, respectively. If α, β, γ are the angles of the first triangle, then we have

$$\text{darea} = \frac{\partial \text{area}}{\partial b} - \frac{\partial \text{area}}{\partial a} = \left(\frac{\partial}{\partial b} - \frac{\partial}{\partial a} \right) (\alpha + \beta + \gamma).$$

Since $c' > c$, for $darea' > darea$ it suffices to show $\frac{\partial}{\partial c}darea > 0$. With the help of Lemma 5.1 one can compute

$$\frac{\partial^2 \text{area}}{\partial b \partial c} = \frac{\sin \alpha - \sin(\beta + \gamma)}{\sin^2 \alpha \sin \beta \sin \gamma \sin b \sin c}.$$

The denominator is invariant under permutations of a, b , and c . Thus we have

$$\begin{aligned} d \sum \kappa_i &= \frac{\sin \alpha - \sin \beta + \sin(\alpha + \gamma) - \sin(\beta + \gamma)}{\sin^2 \alpha \sin \beta \sin \gamma \sin b \sin c} \\ &= \frac{2 \sin \frac{\alpha - \beta}{2} \cos \frac{\alpha + \beta + \gamma}{2} \cos \frac{\gamma}{2}}{\sin^2 \alpha \sin \beta \sin \gamma \sin b \sin c}. \end{aligned}$$

This is easily seen to be positive.

Now let us prove the induction base. The digon D' is glued from two equal triangles. If we use the standard notation for the sides and angles of a triangle, the inequality (56) becomes

$$\pi - \gamma > \left(1 - \frac{c}{\pi}\right) (\alpha + \beta), \quad (57)$$

where $\alpha, \beta \leq \frac{\pi}{2}$ since D' is convex. Let us show that for c and $\alpha + \beta$ constant, the left hand side of (57) attains its minimum at $\alpha = \beta$. Assume $\alpha < \beta$. Then $a < b$. It follows that the simultaneous increase of α and decrease of β by the same amounts result in an increase of the area of the triangle. Hence the left hand side of (57) decreases. For $\alpha = \beta$, we have to show

$$\frac{\pi - \gamma}{\pi - c} > \frac{2\alpha}{\pi}, \quad (58)$$

for an isosceles triangle based on c . We have $\cos \frac{\gamma}{2} = \sin \alpha \cos \frac{c}{2}$. For α constant, the left hand side of (58) can be shown to be a monotonically increasing function of c . As $c \rightarrow 0$, it tends to $\frac{2\alpha}{\pi}$, which proves the Lemma. \square

Lemma 5.6 *Let $P \subset \mathbb{R}^3$ be a convex polytope with vertices (p_i) and angle defects (δ_i) . Then for any i*

$$\left| \sum_{j \neq i} \delta_j \frac{p_j - p_i}{\|p_j - p_i\|} \right| > \delta_i.$$

Proof. Let $C \subset \mathbb{S}^2$ be the spherical section of the polytope P at the vertex i . For any $j \neq i$ we have

$$v_j = \frac{p_j - p_i}{\|p_j - p_i\|} \in C.$$

The perimeter of C equals $2\pi - \delta_i$. By Lemma 5.7, there exists a point $c \in C$ such that

$$\text{dist}(v_j, c) \leq \frac{\pi}{2} - \frac{\delta_i}{4} \quad \text{for all } j.$$

Thus we have

$$\left\langle \sum_{j \neq i} \delta_j v_j, c \right\rangle = \sum_{j \neq i} \delta_j \langle v_j, c \rangle \geq \sum_{j \neq i} \delta_j \cdot \sin \frac{\delta_i}{4} = (4\pi - \delta_i) \sin \frac{\delta_i}{4} > \delta_i,$$

where the last inequality follows easily from $\sin x > \frac{2x}{\pi}$ for $0 < x < \frac{\pi}{2}$. \square

Lemma 5.7 *Let C be a convex spherical polygon of perimeter per . Then C is contained in a circle of radius $\frac{\text{per}}{4}$. That is, there exists a point $c \in \mathbb{S}^2$ such that*

$$\text{dist}(x, c) \leq \frac{\text{per}}{4} \quad \text{for all } x \in C$$

in the intrinsic metric of the sphere.

Proof. Let O be the circle of the smallest radius r that contains C . Then there are three vertices v_1, v_2 and v_3 of C such that v_1, v_2, v_3 lie on O , and the center of O lies in the triangle Δ with the vertices v_1, v_2, v_3 . Since $\text{per}(\Delta) \leq \text{per}$, it suffices to prove

$$r \leq \frac{\text{per}(\Delta)}{4}. \tag{59}$$

The triangle Δ is defined by the radius r and the angles $\alpha, \beta, \gamma \in (0, \pi)$ between the radii drawn from the center of O to the vertices. By computing the derivatives $\frac{\partial \text{per}(\Delta)}{\partial \alpha} - \frac{\partial \text{per}(\Delta)}{\partial \beta}$ one sees that the minimum of $\text{per}(\Delta)$ is achieved when Δ degenerates to an arc. In this case we have an equality in (59). The lemma is proved. \square

References

- [1] A. D. Alexandrov. On the theory of mixed volumes II. *Mat. Sbornik*, 44:1205–1238, 1937.
- [2] A. D. Alexandrov. Existence of a convex polyhedron and of a convex surface with a given metric. *Mat. Sbornik, N. Ser.*, 11(53):15–65, 1942. (Russian. English summary).
- [3] A. D. Alexandrov. *Convex polyhedra*. Springer Monographs in Mathematics. Springer-Verlag, Berlin, 2005. Translated from the 1950 Russian edition by N. S. Dairbekov, S. S. Kutateladze and A. B. Sossinsky, With comments and bibliography by V. A. Zalgaller and appendices by L. A. Shor and Yu. A. Volkov.

- [4] F. Aurenhammer and R. Klein. Voronoi diagrams. In *Handbook of computational geometry*, pages 201–290. North-Holland, Amsterdam, 2000.
- [5] W. Blaschke and G. Herglotz. Über die Verwirklichung einer geschlossenen Fläche mit vorgeschriebenem Bogenelement im Euklidischen Raum. *Sitzungsber. Bayer. Akad. Wiss., Math.-Naturwiss. Abt.*, No.2:229–230, 1937.
- [6] A. Bobenko and B. Springborn. A discrete Laplace-Beltrami operator for simplicial surfaces. <http://arxiv.org/math.DG/0503219>.
- [7] B. H. Bowditch. Singular Euclidean structures on surfaces. *J. London Math. Soc. (2)*, 44(3):553–565, 1991.
- [8] M. Dehn. Über die Starrheit konvexer Polyeder. *Math. Ann.*, 77:466–473, 1916.
- [9] H. Edelsbrunner. *Geometry and topology for mesh generation*, volume 7 of *Cambridge Monographs on Applied and Computational Mathematics*. Cambridge University Press, Cambridge, 2001.
- [10] M. Fedorchuk and I. Pak. Rigidity and polynomial invariants of convex polytopes. *Duke Math. J.*, 129(2):371–404, 2005.
- [11] F. Fillastre. Polyhedral realization of hyperbolic metrics with conical singularities on compact surfaces. <http://arxiv.org/math.DG/0605403>, to appear in *Annales de l'institut Fourier*.
- [12] P. Filliman. Rigidity and the Alexandrov-Fenchel inequality. *Monatsh. Math.*, 113(1):1–22, 1992.
- [13] S. Fortune. Voronoi diagrams and Delaunay triangulations. In *Handbook of discrete and computational geometry*, CRC Press Ser. Discrete Math. Appl., pages 377–388. CRC, Boca Raton, FL, 1997.
- [14] D. Glickenstein. Geometric triangulations and discrete Laplacians on manifolds. <http://arxiv.org/math.MG/0508188>.
- [15] J. Milnor. The Schläfli differential equality. In *Collected papers*, volume 1, pages x+295. Publish or Perish Inc., Houston, TX, 1994.
- [16] H. Minkowski. Allgemeine Lehrsätze über die konvexen Polyeder. *Nachr. Ges. Wiss. Göttingen*, pages 198–219, 1897.
- [17] L. Nirenberg. The Weyl and Minkowski problems in differential geometry in the large. *Comm. Pure Appl. Math.*, 6:337–394, 1953.

- [18] I. Pak. Rigidity and polynomial invariants of convex polytopes. *Sib. Math. J.*, 47(5):859–864, 2006.
- [19] T. Regge. General relativity without coordinates. *Nuovo Cimento*, 19:558–571, 1961.
- [20] I. Rivin. Euclidean structures on simplicial surfaces and hyperbolic volume. *Ann. of Math. (2)*, 139(3):553–580, 1994.
- [21] J.-M. Schlenker. Circle patterns on singular surfaces. <http://arxiv.org/math.DG/0601531>.
- [22] J.-M. Schlenker. Small deformations of polygons and polyhedra. <http://arxiv.org/math.DG/0410058>, to appear in *Trans. AMS*.
- [23] R. Schneider. *Convex bodies: the Brunn-Minkowski theory*, volume 44 of *Encyclopedia of Mathematics and Its Applications*. Cambridge University Press, Cambridge, 1993.
- [24] Y. A. Volkov. An estimate for the deformation of a convex surface in dependence on the variation of its intrinsic metric. *Ukrain. Geometr. Sb.*, 5–6:44–69, 1968.
- [25] Y. A. Volkov and E. G. Podgornova. Existence of a convex polyhedron with prescribed development. *Taškent. Gos. Ped. Inst. Učen. Zap.*, 85:3–54, 83, 1971. (Russian).
- [26] H. Weyl. Über die Bestimmung einer geschlossenen konvexen Fläche durch ihr Linienelement. *Zürich. Naturf. Ges.*, 61:40–72, 1916.
- [27] G. Ziegler. *Lectures on polytopes*, volume 152 of *Graduate Texts in Mathematics*. Springer-Verlag, Berlin, 1995.