

The Topology of Open Manifolds with Nonnegative Ricci Curvature

Zhongmin Shen and Christina Sormani

Abstract: We survey all results concerning the topology of open manifolds with $Ricci \geq 0$ that have no additional conditions other than restrictions to the dimension, volume growth or diameter growth of the manifold. We will also present relevant examples and list open problems.

1 Introduction

Throughout this survey article, M^n is a complete noncompact n dimensional manifold with $Ricci \geq 0$ where $n \geq 3$. Note that Cohn-Vossen proved M^2 is either diffeomorphic to \mathbb{R}^2 or flat [Cv]. DeTurck proved that locally one can prescribe Ricci curvature, so all obstructions to the existence of such a metric are topological [Dt]. Lohkamp has demonstrated that there are no topological obstructions for manifolds with negative Ricci curvature [Lok].

In Section 2 we provide background on geodesics, Ricci curvature and the Cheeger-Gromoll Splitting Theorem. We then describe warped products and the examples of Nabonnand, Wei and Wilking. This leads into the Loops to Infinity theorem of the second author. Section 2 closes with a complete classification of the codimension one homology, $H_{n-1}(M, Z)$, and a small restriction to $H_{n-2}(M, Z)$ derived by the two authors in 2000.

In Section 3 we present the Bishop-Gromov Volume Comparison Theorem and introduce Milnor's Conjecture that the $\pi_1(M)$ is finitely generated. We describe results of Milnor, Gromov and Wilking in this direction. Partial solutions of the Milnor Conjecture requiring additional hypothesis on volume or diameter by Li, Anderson and the second author are presented in detail as well as the Perelman Contractibility Theorem. We also mention the Cheeger-Colding Diffeomorphism Theorem.

Section 4 begins with thorough descriptions of examples of M^n with infinite topological type by Sha-Yang, Anderson-Kronheimer-LeBrun, and Menguy. We also review Wraith's surgery techniques and Perelman's building blocks. We close Section 4 with a description of results of Nash, Berard-Bergery, Otsu, Anderson, and Belegradek-Wei exploring which vector bundles admit metrics with $Ricci > 0$ and $Ricci \geq 0$.

In Section 5 we present Schoen-Yau's proof that three manifolds with $Ricci > 0$ are diffeomorphic to \mathbb{R}^3 . The classification of the topology of M^3 with only $Ricci \geq 0$ is an open problem. We describe partial results by Schoen-Yau, Shi, Zhu, Meeks-Simon-Yau, Anonov-Burago-Zalgaller, Anderson-Rodriguez and Zhu. Zhu in fact has shown M^3 is contractible as long as the volume grows like r^3 . However, Milnor's Conjecture remains open even in dimension three! Section 5 closes with a description of a potential Milnor Counter Example: the dyadic solenoid complement.

Section 6 describes further open problems. It includes a list of the qualitative properties of M^n for those wishing to search for new examples. We close the paper with thanks to the many geometers and topologists who assisted us.

There are many beautiful results on the topology of open manifolds with nonnegative Ricci curvature which have additional conditions on either the Busemann function, injectivity radius, conjugacy radius or some other geometric constraint. However, we were unable to include these results here. We have also had to leave out the related theory of compact manifolds including many relevant examples. To keep the bibliography shorter than five pages we only refer to the primary articles we are surveying and not the important papers cited within those articles. We hope that this survey will prove useful to everyone interested in entering this area rich in open problems.

2 Geodesics and $H_{n-1}(M, Z)$

In this section we provide some intuitive understanding of geodesics. Throughout, geodesics will be parametrized by arclength. We begin without the assumption of Ricci curvature.

A **ray** is a geodesic $\gamma : [0, \infty) \rightarrow M$ such that

$$d(\gamma(t), \gamma(s)) = |s - t| \quad \forall s, t \in [0, \infty)$$

Recall that a geodesic fails to minimize after its first cut or conjugate point,

so as soon as there is more than one path between a pair of points on a geodesic it is no longer a ray. On a paraboloid, $z = x^2 + y^2$, any geodesic running radially outward from the basepoint $(0, 0, 0)$ is a ray. In fact *every complete noncompact Riemannian manifold contains a ray*.

A **line** is a geodesic $\gamma : (-\infty, \infty) \mapsto M^n$, such that:

$$d(\gamma(t), \gamma(s)) = |t - s| \forall t, s \in (-\infty, \infty).$$

Paraboloids have no lines while cylinders have a collection of parallel lines in their so-called “split” direction.

We say a manifold had k **ends** if for every sufficiently large compact set, K , $M \setminus K$ has k unbounded components. So a paraboloid has one end, a cylinder has two ends and a Riemann surface with three punctures or cusps has three ends. *A complete manifold with two or more ends contains a line*.

Ricci curvature, on the other hand, is a locally defined concept: Let $p \in M^n$, $v \in TM_p$ with $|v| = 1$, **Ricci curvature** is defined

$$Ric_p(v, v) = \sum_{i=1}^{n-1} \langle R(e_i, v)v, e_i \rangle \quad (2.1)$$

where $v, e_1, e_2, \dots, e_{n-1}$ are orthonormal and R is the sectional curvature tensor. We say M has *Ricci* ≥ 0 if

$$Ric_p(v, v) \geq 0 \forall p \in M \forall v \in TM_p \quad (2.2)$$

and it has *Ricci* > 0 if \geq is replaced by $>$ in (2.2).

Intuitively, the sectional curvature measures how much geodesics bend together. Thus if $\langle R(v, w)w, v \rangle \geq 0$ then the geodesics $C_v(t) = exp_p(tv)$ and $C_w(t) = exp_p(tw)$ starting at p in the directions v and w respectively, tend to bend towards each other or diverge at most linearly. On the other hand if only $Ricci_p(v, v) \geq 0$ then by (2.1) a pair of geodesics may bend apart as long as other geodesics bend together. See Figure 1.

Cheeger-Gromoll Splitting Theorem (1971): *If M^n contains a line, then M^n splits isometrically:*

$$M^n = (-\infty, \infty) \times N^{n-k}$$

with the metric, $g_M = dr^2 + g_N$. [ChGl]

This theorem can be intuitively understood as saying all geodesics must remain parallel to the line because if some were to bend away then others

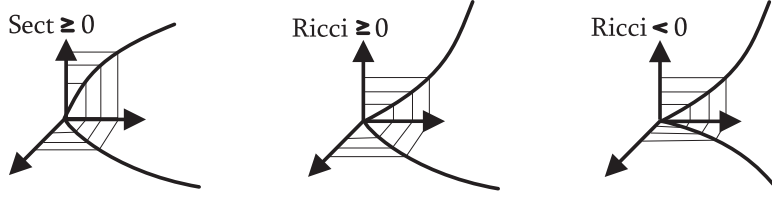

Figure 1: The bending of geodesics under curvature bounds.

would have to bend inward causing a cut point. The actual proof of this theorem uses an argument involving subharmonic and superharmonic functions (c.f. [EscHe]).

Note that Cheeger-Gromoll's Splitting theorem implies that M^n has at most two ends and M^n with Ricci > 0 has only one end.

A **warped product** $M = [0, \infty) \times_f S^1$ is a manifold with the metric

$$g_M = dr^2 + f^2(r)d\theta^2.$$

It is a smooth manifold with one end if $f(r) > 0$ for $r > 0$, $f(0) = 0$, $f'(0) = 1$, and $f''(0) = 0$.

If $f(r) = r$ this is Euclidean space. If $f(r) = \sin(r)$ this is a sphere and it closes up at $r = \pi$. In fact, $[0, \infty) \times_f S^k$ is a manifold with positive sectional curvature if $f''(r) < 0$. Curves of the form $\gamma(t) = (t, \theta_0)$ are geodesics in this warped product. One can see that these geodesics are bending together when $f''(r) > 0$. In order to construct more interesting examples with positive Ricci curvature that have some negative sectional curvature, one needs to warp the manifold with more than one function.

A **doubly warped product** $[0, \infty) \times_h S^2 \times_f S^1$ has the metric

$$dr^2 + h^2(r)g_{S^2} + f^2(r)d\theta^2. \quad (2.3)$$

Its radial Ricci curvature is

$$\text{Ric}\left(\frac{\partial}{\partial r}, \frac{\partial}{\partial r}\right) = -\frac{f''(r)}{f(r)} - 2\frac{h''(r)}{h(r)}. \quad (2.4)$$

Notice now how some curves now may bend apart (say with $f''(r) > 0$ as long as others bend together (with $h''(r) < 0$).

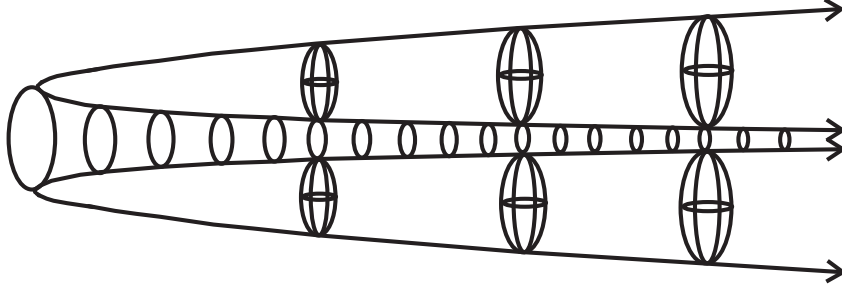

Figure 2: Nabonnand's Example

Example of Nabonnand (1980): *There is a doubly warped product*

$$M^4 = [0, \infty) \times_h S^2 \times_f S^1 \quad (2.5)$$

with Ricci > 0, $h(0) = 0$, $h'(0) = 1$, and $h''(0) = 0$ but $f(0) > 0$. In particular M^4 is diffeomorphic to $\mathbb{R}^3 \times S^1$ and has fundamental group $\pi_1(M^4) = \mathbb{Z}$. See Figure 2. [Nab]

Note that in Nabonnand's example the loop at $r = 0$ is not contractible. However, it is homotopic to shorter and shorter loops diverging to infinity.

Examples of Wei (1988): *For any discrete nilpotent group, G , there is an M^n with fundamental group, $\pi_1(M^n) = G$:*

$$M = [0, \infty) \times_h S^k \times_f N$$

with $h(0) = 0$ but $f(0) \neq 0$, positive Ricci curvature, and fundamental group $\pi_1(N) = G$. The universal cover, \tilde{N} , of N , is a complete noncompact nilpotent Lie group. Note $\pi_1(M) = \pi_1(N)$. [Wei]

Examples of Wilking (2000): *For any finitely generated almost nilpotent group, H , one can construct M^n with $\pi_1(M^n) = H$. This construction is done using \tilde{N} from Wei's construction, taking its k fold isometric product and crossing with $SU(2)$ before dividing by H and taking a similar warped product. [Wlk]*

Note that noncontractible loops in all these examples slide to infinity. This led the second author to define the following concept in [Sor4].

A manifold has the **loops to infinity** property if given any noncontractible closed curve, C , and given any compact set K , then there exists a curve, C_K contained in $M \setminus K$ which is freely homotopic to C . See Figures 3, 4, 5 and 6.

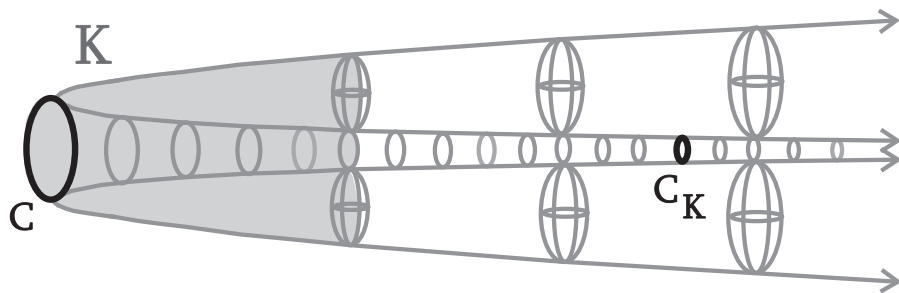

Figure 3: Nabonnand's example has the loops to infinity property as can be seen taking the shaded compact set K .

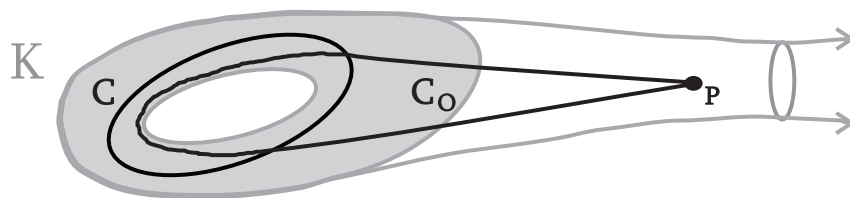

Figure 4: A complete punctured torus however, does not have the loops to infinity property because loops get caught on the finite hole.

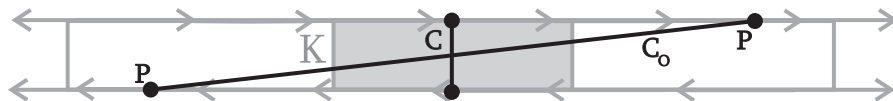

Figure 5: An infinite Moebius strip, defined as \mathbb{E}^2 with points (x, y) identified with $(-x, y + 1)$, also fails to have the loops to infinity property.

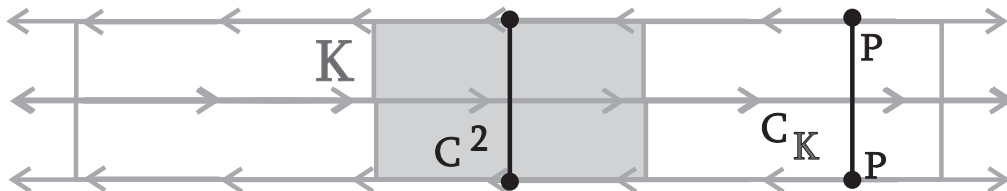

Figure 6: However the infinite Moebius strip's double cover, the cylinder, satisfies the loops to infinity property.

Sormani Loops to Infinity Theorem: *Either M^n satisfies the loops to infinity property or M^n has a double cover which splits isometrically.* [Sor4]

Clearly M^n with $Ricci > 0$ must then have the loops to infinity property. Two examples of M^n with split double covers are the infinite Moebius strip depicted in Figure 5 and the oriented normal bundle over $\mathbb{R}P^2$.

Proof Outline: If there is a curve C and a compact set K such that any loop freely homotopic to C passes through K , then one takes a ray $h(t)$ and $t_i \rightarrow \infty$ and the shortest loop C_i freely homotopic to C based at $h(t_i)$ must pass through K . The lifts of C_i to \tilde{C}_i in the universal cover, \tilde{M} can be shown to be minimal geodesics with length, $L(\tilde{C}_i) \rightarrow \infty$. Transforming them by g_i to a common compact lift of K , one sees that a subsequence of the $g_i \tilde{C}_i$ converge to a line. The Splitting Theorem then implies that \tilde{M} splits. It takes further work to split a double cover isometrically [Sor4].

Open Problem: The Fundamental Group at Infinity *in the sense of [GeoMih] might contain $\pi_1(M)$. The definition of the fundamental group at infinity requires a proper homotopy yet in [Sor4] the homotopy running from C to C_K as K grows was not controlled.*

It is a consequence of the Loops to Infinity property that if D is a compact domain in M^n with one simply connected boundary, then D is simply connected. Earlier restrictions on the fundamental group of such $D \subset M^n$ were found by **Schoen-Yau** in [SchYau2] using *harmonic maps*.

Using the relative homology of arbitrary compact domains in M^n arising from the loops to infinity property and techniques from algebraic topology the authors proved the following:

Shen-Sormani (2000): *Either M^n is a flat normal bundle over a compact totally geodesic submanifold, or M^n has a trivial codimension one homology, $H_{n-1}(M^n, Z)$, and $H_{n-2}(M, Z)$ is torsion free.* [ShnSor]

This complete classification of $H_{n-1}(M, Z)$ extends **S.T. Yau's** 1976 proof using harmonic forms that M^n with $Ricci > 0$ have trivial $H_{n-1}(M, R)$ [Yau2]. The first author had results in this direction using Morse Theory in [Shn] and **Itokawa-Kobayashi** had partially classified $H_{n-1}(M, Z)$ using minimizing currents [ItKo].

The control on $H_{n-2}(M, Z)$ is much weaker than the control on the codimension one homology. In fact, examples have been constructed where $H_{n-2}(M, Z)$ is infinite dimensional. See Section 4.

3 Volume and the Fundamental Group

In this section we describe the properties of the fundamental group of our open manifold, M^n , with nonnegative Ricci curvature. We focus on Milnor's unsolved conjecture:

Milnor Conjecture 1968 *The fundamental group, $\pi_1(M^n)$, is finitely generated. That is, there are only finitely many one dimensional holes.* [Mil] Here we will survey partial results and obstructions towards finding a possible counter example.

The most useful tool for studying the fundamental group of M^n is its universal cover, \tilde{M}^n , which is also open and has $Ricci \geq 0$. Recall the fundamental group acts on the universal cover by isometries called “deck transforms” and that $M^n = \tilde{M}^n/\pi_1(M)$. If $i_0 > 0$ is the injectivity radius of M then

$$d_{\tilde{M}}(gp, hp) \geq 2i_0 \quad \forall g, h \in \pi_1(M), \text{ and } \forall p \in \tilde{M}. \quad (3.1)$$

The size and/or growth of the fundamental group can thus be studied by counting disjoint balls of radius i_0 in the universal cover.

For this reason, the Bishop-Gromov Volume Comparison Theorem plays a crucial role in the study of $\pi_1(M^n)$ applied to both M^n and \tilde{M}^n .

Bishop-Gromov Volume Comparison Theorem

If M^n has $Ricci \geq 0$, $p \in M^n$ and $0 < r < R$ then

$$\frac{Vol(B_p(r))}{Vol(B_p(R))} \geq \frac{\omega_n r^n}{\omega_n R^n} \quad (3.2)$$

where $\sigma_n = Vol(B_0(1) \subset \mathbb{E}^n)$.

This theorem was proven by **Gromov (1981)** [Gr2] using an estimate of **Bishop (1963)** [Bi]. One can intuitively think of volumes as capturing the fact that while some geodesics may bend apart as they emanate from p others must compensate by bending together, thus the region they sweep out bends inward causing inner balls to have larger volumes than expected compared to outer balls. As a consequence M^n has at most Euclidean volume growth:

$$\limsup_{r \rightarrow \infty} \frac{Vol(B_p(r))}{r^n} \leq \omega_n < \infty. \quad (3.3)$$

In fact $Vol_p(R) \leq \omega_n R^n$ for all $R > 0$.

Milnor noticed that if one lists a finite collection of generators

$$\{g_1, g_2, \dots, g_k\} \subset \pi_1(M) \text{ and let } H = \langle g_1, \dots, g_k \rangle \quad (3.4)$$

then H cannot be too large or grow too quickly. If it did too many disjoint balls $B_{gp}(i_0)$ would fit in \tilde{M} . Particularly, **Milnor** proved that

$$N(k) = \text{the number of words of length } k \text{ in } H \quad (3.5)$$

grows at most polynomially in k of order $n = \dim(M^n)$ [Mil]. See Figure 7.

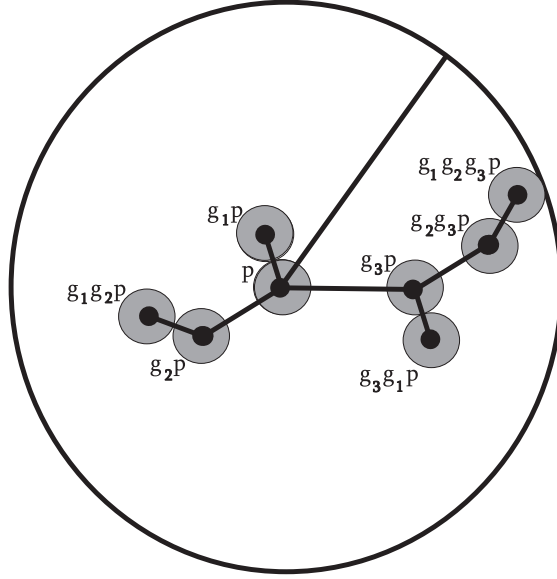

Figure 7: Milnor's Estimate for $N(3)$ with $H = \langle g_1, g_2, g_3 \rangle$

Each ball in Figure 7 has the same volume, due to the isometries, and each is disjoint from the other by (3.1). They all fit in a large ball of radius

$$R = km \text{ where } m = \max_{g=g_1, g_2, g_3} d_{\tilde{M}}(p, gp). \quad (3.6)$$

because

$$d_{\tilde{M}}(g_1g_2p, p) \leq d_{\tilde{M}}(g_1g_2p, g_2p) + d_{\tilde{M}}(g_2p, p) \leq 2m. \quad (3.7)$$

Here m is finite because there is a finite list of generators. To estimate $N(k)$, one sums over all words, h , of length $\leq k$:

$$N(k) \text{Vol}(B_p(i_0/2)) = \sum_h \text{Vol}(B_{hp}(i_0/2)) \leq \omega_n R^n \leq \omega_n (k \cdot m)^n. \quad (3.8)$$

In Figure 7, H is abelian to make it easier to draw. In general, M^n need not have an abelian fundamental group.

Gromov (1981) proved that any finitely generated group of polynomial growth is almost nilpotent [Gr1]. Combined with Wilking's example described in Section 4, this would completely classify the fundamental groups of M^n if Milnor's Conjecture holds.

We now turn to partial solutions of the Milnor Conjecture. The most general is Wilking's result proven using algebraic methods based on the qualities of $\pi_1(M)$ described above.

Wilking's Milnor Conjecture Reduction: *If there exists a counter example to the Milnor Conjecture then it has a covering space with an abelian fundamental group which is also infinitely generated.* [Wlk]

All the other partial solutions involve additional conditions on volume or diameter growth.

Maximal Volume Growth

Recall that the Bishop-Gromov Volume Comparison Theorem implies

$$\limsup_{r \rightarrow \infty} \frac{\text{Vol}(B_p(r))}{r^n} \leq \omega_n < \infty.$$

Peter Li's Euclidean Volume Growth Theorem: *If M^n has Euclidean volume growth:*

$$\liminf_{r \rightarrow \infty} \frac{\text{Vol}(B_p(r))}{r^n} > 0 \tag{3.9}$$

then the fundamental group is finite. [Li]

The proof uses the heat kernel on the universal cover, \tilde{M} . It is interesting to note that in dimension 3, $H_1(M^3, Z)$ is torsion free by [ShnSor], thus the only three dimensional manifold with Euclidean volume growth has $H_1(M, Z) = 0$. In fact Zhu proved M^3 satisfying 3.9 is contractible [Zhu1].

Anderson's Volume Growth Theorem: *If M^n has $b_1(M) \geq k$ and*

$$\limsup_{r \rightarrow \infty} \frac{\text{Vol}(B_p(r))}{r^{n-k}} > 0$$

then $\pi_1(M)$ is finitely generated. [And1]

This implies Li's result when $k = 0$ and is proven using a clever volume comparison argument relating large balls in M to their lifts in \tilde{M} restricted to fundamental domains. Anderson also obtains estimates on

$b_1(M) = \dim(H_1(M, Z))$ assuming additional sectional curvature bounds [And1].

Perelman Contractibility Theorem: M^n is contractible if it almost maximal volume growth:

$$\liminf_{r \rightarrow \infty} \frac{\text{Vol}(B_p(r))}{r^n} > \omega'_n$$

where ω'_n is sufficiently close to $\omega_n = \text{vol}(B_0(1) \subset \mathbb{E}^n)$. [Per1]

In Section 4, we present Menguy's four dimensional example demonstrating ω'_n must be close to ω_n for this result to hold. Zhu proved that three dimensional M^3 satisfying only (3.9) are contractible [Zhu1].

Note that for a presumably larger constant, ω'_n , also depending only on dimension, **Cheeger-Colding** have proven that M^n is diffeomorphic to \mathbb{R}^n . Their proof uses almost rigidity techniques and so one cannot estimate the actual value of their constant [ChCo] Thm A.1.12. We cannot describe their proof in the space allowed here but do describe Perelman's:

Proof Outline: Perelman proves that $f : S^k \rightarrow M$ can be continuously extended to $f : D^{k+1} \rightarrow M$ using induction on k . His key estimate depending on volume is proven using Bishop-Gromov's proof of the volume comparison theorem. It says that for any $c_2 > c_1 > 0$ and $\epsilon > 0$ there exists $\delta > 0$ such that if

$$\text{Vol}(B_p(c_2R)) > (1 - \delta)(c_2R)^n \tag{3.10}$$

then for every $a \in B_p(c_1R)$ there exists $b \in M \setminus B_p(c_1R)$ such that the geodesic from p to b passes through $B_a(\epsilon R)$. If this were not true there would be too many cut points and the volume of the larger ball would not be almost maximal contradicting (3.10). This allows Perelman to proceed with a filling in procedure for each subsequent cell k . See [Per1] for illustrations and details. By analyzing the process carefully one can estimate the value of ω'_n .

The key intuition here is that homology causes cut points and cut points use up space.

Minimal Volume Growth

S-T Yau [Yau1] used results on harmonic functions to prove M^n has at least linear volume growth:

$$\liminf_{r \rightarrow \infty} \frac{\text{Vol}(B_p(r))}{r} = C_{M^n} > 0.$$

This can be reproven by applying the Bishop-Gromov volume comparison to balls around points along a ray.

The second author proved that if M^n has at most linear volume growth

$$\limsup_{r \rightarrow \infty} \frac{\text{Vol}(B_p(r))}{r} < \infty$$

then it has sublinear diameter growth

$$\limsup_{r \rightarrow \infty} \frac{\text{diam}(\partial B_p(r))}{r} = 0,$$

using Cheeger-Colding almost rigidity techniques. This diameter is extrinsic so $\text{diam}(\partial B_p(r)) \leq 2r$. [Sor1][Sor2]

Sormani Small Linear Diameter Growth Theorem: *If M^n has small linear diameter growth:*

$$\limsup \text{diam}(\partial B_p(r))/r < S_n$$

then M^n has a finitely generated fundamental group. [Sor3]

Corollary: *The Milnor Conjecture is proven for manifolds, M^n , with minimal volume growth.*

The constant S_n was given explicitly in [Sor3] and then was improved in 2003 by S Xu, Z Wang and F Yang [XuWaYa]. Recently, W. Wylie observed that $\pi_1(M^n)$ is finitely presented when M^n has small linear diameter growth [Wy].

Proof Outline: Since M^n is complete, one can construct special *halfway generators*, $g_i \in \pi_1(M^n, p)$, with loops $c_i : [0, L_i] \rightarrow M$ such that

$$d(c_i(0), c_i(L_i/2)) = L_i/2. \tag{3.11}$$

Using $\text{Ricci} \geq 0$ Sormani proves the halfway generators' loops, c_i , satisfy a *Uniform Cut* property on a ball $B_i = B_{c_i(L_i/2)}(S_n L_i)$: *all geodesics from p entering B are cut.*

This contradicts the existence of a ray in a complete noncompact manifold when the diameter growth is too small.

The *Uniform Cut* property on the ball

$$B = B_{c_i(L_i/2)}(S_n L_i)$$

is proven by applying the Abresch-Gromoll Excess Theorem to the lift of the c_i to \tilde{M} . See [Sor3] for details.

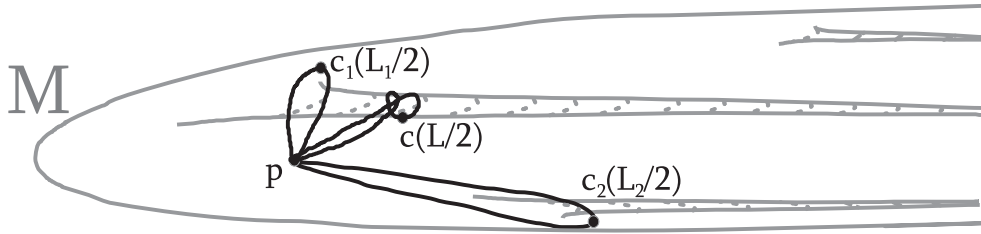

Figure 8: Halfway generators: c_i satisfy (3.11), c does not.

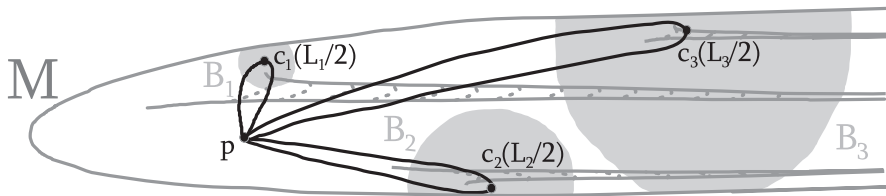

Figure 9: All geodesics from p entering B_i are cut. Thus there is no room for a ray to pass through B_3 .

In the next section we will see that we cannot hope to get contractibility for manifolds with minimal volume growth as Menguy has constructed an example with bounded diameter growth and infinite topological type.

Intuitively the space used up by cut points resulting from 1 dimensional holes [Sor3] is significantly larger than the space used up by cut points resulting from higher dimensional holes [Per1].

4 Examples

In this section we describe a host of important examples of open manifolds with nonnegative Ricci curvature supplementing those of Nabonnand, Wei and Wilking described in Section 2. The first manifold with positive Ricci curvature and infinite topological type was constructed by Sha and Yang. It was seven dimensional with infinite dimensional $H_4(M, Z)$. [ShaYng1] This result was then generalized in 1991 as follows:

Sha-Yang Examples: *For all integers $p \geq 2$ and $q \geq 1$ there exists M^{p+q} with nonnegative Ricci curvature which is created from $S^{p-1} \times R^{q+1}$ by*

cutting off infinitely many $S^{p-1} \times D_i^{q+1}$ and gluing in $S^p \times S_i^q$.

In particular, there exists a 4 dimensional manifold M^4 with infinite second Betti number and $\text{Ricci} > 0$. [ShaYng2]

Sha and Yang focus on the compact case in this paper only briefly sketching the construction of the open manifold we depict in Figure 10. More detail on the open manifold is available in [ShnWei] where M^4 is shown to have $\text{diam}(\partial B_p(r)) \leq Cr^{3/4}$ and $\text{vol}(B_p(r)) \leq r^{5/2}$.

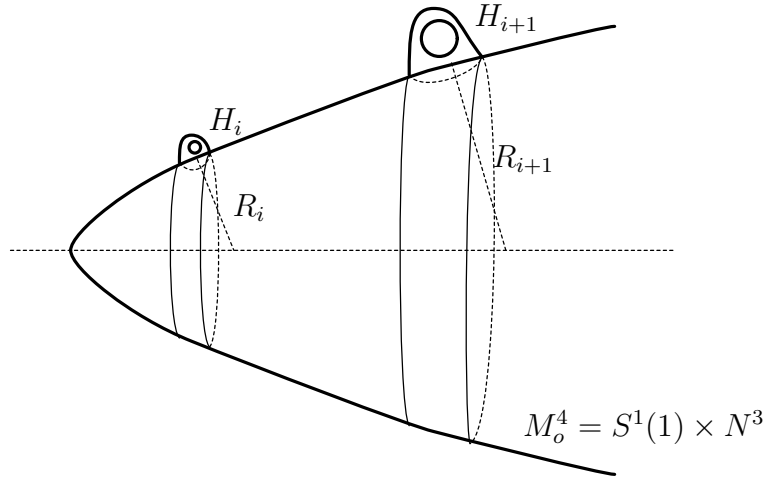

Figure 10: The 4D Sha-Yang Example with $p = 2$ and $q = 2$

Construction: The construction when the dimension $n = 4$ begins with $M_o^4 = S^1(1) \times N^3$ with the isometric product metric, where $N^3 \approx R^3$. When one stays away from the tip of M_o^4 , the size of $S^1(1)$ is relatively small, compared to the cross-sections of N^3 . Thus in the Figure 10 for M_o^4 , we make M_o^4 look like N^3 . Note M_o^4 has $\text{Sect} \geq 0$.

N^3 is a surface of revolution in R^4 which looks something like a paraboloid but has a sequence of annular regions, A_i , with constant sectional curvature $1/R_i^2$ and width $2r_i = 2\alpha_i R_i$. This can be achieved by taking a hemisphere in S^3 and slicing it into infinitely many annuli of width $2\alpha_i$ such that $\sum_{i=1}^{\infty} 2\alpha_i < \pi/2$, then spreading these annuli apart from each other and rescaling each up by some radius R_i to create an open manifold N^3 .

To create the interesting topology, Sha-Yang edit M_o^4 . From each A_i which is isometric to an annular region in S^3 crossed with S^1 , they remove a

metric ball $B_i^3 := B_i(p_i, r_i)$ from N^3 . This creates a manifold

$$\hat{M}^4 := S^1(1) \times (N^3 \setminus \coprod_{i=1}^{\infty} B_i^3) \quad (4.1)$$

with infinitely many boundaries. Each boundary is an isometric product of an $S^1 \times \partial B_i^3 \subset S^1 \times_{R_i} S^3$ where R_i is just the constant radius.

Topologically, they can glue a handle $H := D^2(1) \times S^2(1)$ to \hat{M}^4 along these boundaries. The resulting manifold is a manifold M^4 with $H_2(M^4, Z)$ infinitely generated:

$$M^4 := S^1(1) \times (N^3 \setminus \coprod_{i=1}^{\infty} B_i^3) \cup \coprod_{Id} \coprod_{i=1}^{\infty} H_i$$

where each H_i is diffeomorphic to H . See Figure 10.

In order to understand why M^4 has positive Ricci curvature, we now describe the doubly warped product on the handles

$$H_i = (0, r_i) \times_{h_i} S^1(1) \times_{f_i} S^2(1). \quad (4.2)$$

To obtain the handle topology we desire while closing smoothly at $r = 0$ we set $h_i(0) = 0$, $f_i'(0) = 0$ and $f_i(0) = h_i'(0) = 1$. To smoothly attach this into $\partial \hat{M} \cap A_i$ we need to attach the S^1 direction straight (so $h_i(r_i) = 1$, $h_i'(r_i) = 0$) and the other directions curved like a sphere of radius R_i (so $f_i(r) = R_i \sin(r/R_i)$ for r nearby r_i). Sha-Yang then carefully choose f and g satisfying (2.4) and the other equations guaranteeing positive Ricci curvature. [ShaYng2]

In Sha-Yang's surgery, a removed part, $S^{p-1} \times D^{q+1}$, can be viewed as a trivialization of the normal bundle of S^{p-1} in $M^{p+q} := S^{p-1} \times N^{q+1}$ with the metric product metric, where N^{q+1} can be a round sphere or a surface of revolution. David **Wraith** studies the surgery problem on a manifold M^{p+q} with positive Ricci curvature and surgeries of codimension three. His technique is similar to Sha-Yang's. Wraith needs the same local form for the metric on the ambient manifold M^{p+q} in order to complete the Ricci positive surgery. The essential difference is that he handles the surgery with a non-standard trivialization which is not determined by the metric. To do so, he assumes that $p \geq q + 1 \geq 3$ in order to use a smooth map $T : S^{p-1} \rightarrow SO(q + 1)$ to make a twisting for

$$\tilde{T} : (x, r, y) \in S^{p-1} \times D^{q-1} \rightarrow (x, r, T(x)y) \in S^p \times D^{q+1} \quad (4.3)$$

when gluing in $D^p \times S^q$. Apart from the restriction on dimensions, Wraith's technique can be used in all situations where Sha-Yang's technique can be used. It can also be applied to exotic spheres. Of interest here is that he can construct complete open manifolds with positive Ricci curvature and infinite topological type with are similar to the Sha-Yang examples but not diffeomorphic to them. [Wra]

Anderson-Kronheimer-LeBrun Examples (1989): M^4 which are Ricci flat and Kahler with infinite dimensional $H_2(M, \mathbb{Z})$ based on physics of Gibbons-Hawking.[AndKrLb]

Construction: Anderson-Kronheimer-Lebrun's example is constructed from the Gibbons-Hawking Ansatz by using infinitely many, sparsely distributed centers. It requires some more expertise than the other examples to understand.

Take a sequence of points $p_j = (j^2, 0, 0)$ in R^3 . There is a unique principal S^1 -bundle $\pi_o : M_o \rightarrow R_o^3 := R^3 \setminus \{p_j\}$ such that the Chern class is -1 when restricted to a sphere $S^2(p_j, r_j) \subset R^3$ for small $r_j < \min_{k \neq j} \|p_j - p_k\|$. An important fact is that $\pi_o^{-1}(B(p_j, r_j))$ is diffeomorphic to $\hat{B}_j^4 := B_j^4 \setminus \{0\}$, where B_j^4 is a copy of a ball in R^4 , such that the action of $S^1 \subset \mathbb{C}$ on $\hat{B}_j^4 \subset R^4 \approx \mathbb{C}^2$ is given by scalar multiplication.

Then define

$$M^4 := M_o \bigcup_{Id} \prod_{j=1}^{\infty} B_j^4.$$

This M^4 is a smooth manifold with $H_2(M, \mathbb{Z}) = \oplus_{j=1}^{\infty} \mathbb{Z}$. π_o can be extended to a map $\pi : M^4 \rightarrow R^3$ such that $\pi^{-1}(p_j)$ is a point. Recall that $\pi^{-1}(q)$ is S^1 when $q \notin \{p_j\}$. To illustrate M^4 , we view R^3 as a plane in Figure 11.

We now describe the construction of the metric g_0 depicted in Figure 11. The Chern class of $\pi_o : M_o \rightarrow R_o^3$ is represented by the closed 2-form $\frac{1}{2\pi} * df$. Let $\omega \in \Omega^1(M_o)$ be a connection 1-form for $\pi_o : M_o \rightarrow R_o^3$ such that

$$\pi_o^>(*df) = d\omega.$$

ω is unique up to a gauge transformation since R_o^3 is simply connected. The canonical metric on M_o^4 is defined by

$$g_o := \omega \otimes \omega + \pi_o^* ds_3^2,$$

where ds_3^2 denote the Euclidean metric on R^3 . It is singular at the points $\pi^{-1}(p_j)$.

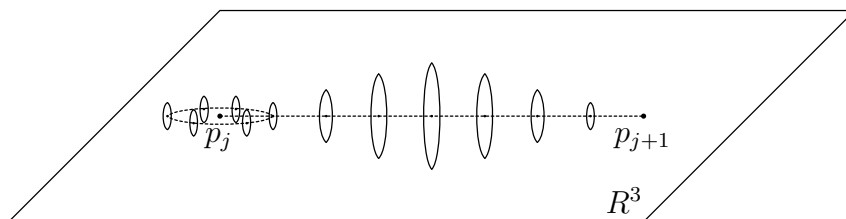

Figure 11: Anderson-Kronheimer-LeBrun Example

Next, Anderson-Kronheimer-LeBrun warp the metric g_o as follows,

$$g := f^{-1}\omega \otimes \omega + f\pi_o^*ds_3^2,$$

where $f : R_o^3 \rightarrow R$ is defined by

$$f(x) := \frac{1}{2} \sum_{j=1}^{\infty} \frac{1}{\|x - p_j\|}.$$

Anderson-Kronheimer and LeBrun then verify that

$$\Delta f = d * df = 0.$$

This fact is true only in three dimensions! Thus the metric g continues smoothly across the isolated points $\pi^{-1}(p_j)$, so g is a complete Ricci-flat metric. [AndKrLb]

Menguy's Euclidean Volume Growth Examples (2000): M^4 with $Ricci > 0$, volume growth like r^4 , and infinite second homology. [Mng1]

The homology is created by cutting and pasting in special convex manifolds with boundary constructed by Perelman for a compact example in 1997. We begin by describing Perelman's construction [Per2].

Perelman's Building Blocks have a core and a neck. The core introduces the topology. It views S^3 as an S^1 bundle over S^2 , and warps the S^1 down to 0, while keeping the base S^2 positive, so that the core has a noncontractible two sphere and a round convex boundary = S^3 . Perelman justifies the smooth closing up of the S^1 direction, by relating the warping direction to the distance function from $CP^1 = S^2$ in CP^2 giving a kind of cylindrical coordinates expression for the tubular neighborhood of the CP^1 . The boundary of this tubular neighborhood is an S^1 bundle over S^2 which

is diffeomorphic to the standard S^3 . It is convex and all the geodesics are curving together as they approach the boundary so it is difficult to glue a small copy of it into a manifold with nonnegative Ricci curvature: all the geodesics would be forced apart. See Figure 12

In fact Colding's stability theorem [Co] states that it is impossible to glue in tiny pieces of topology into a manifold with nonnegative Ricci curvature. Thus Perelman creates a neck which bends some geodesics outward and others continue inward, so that he can glue the building block into the singular edge of manifold. The geodesics which bend together fold over the edge and those that bend apart turn outward along the edge and the whole manifold is then smoothed into a smooth manifold with $Ricci > 0$.

The neck is a doubly warped $S^3 \times [0, 1]$. $S^3 \times \{0\}$ is a small round sphere that fits the core. Then $S^3 \times \{r\}$ grows towards a convex boundary at $r = 1$. $S^3 \times \{1\}$ has a metric that looks like a lemon. It is a rotationally symmetric S^3 with the distance between the poles = πR and a waist = $2\pi r$ where $r^{3-1} < R^3 < 1$, so the sectional curvature is > 1 and the normal curvatures are all > 1 .

The core and the neck together form Perelman's building blocks which he glued into a compact manifold close to a singular manifold formed by taking a double spherical suspension over a round two sphere. When holes are cut out of the singular edge they look like singular lemons, so that when the singular manifold is smoothed slightly along the singular edge, the holes can be made to precisely fit the lemon shaped boundary of the building block. To glue a tiny copy of the building block, the edge must be sharper, reflecting Colding's Stability Theorem [Co].

Menguy's Construction: Since Menguy's example is open, he needs to insure that it is asymptotically singular at infinity in order to successfully complete the editing process. In fact Menguy starts with a metric cone, M_0 , over a spherical suspension of a small ball,

$$dr^2 + (cr)^3(ds^2 + \sin^2(s)R_0^2d\sigma^2) \text{ where } c < 1 \text{ and } R_0 < 1 \quad (4.4)$$

which has volume growth like Cr^4 and two singular rays emanating from the pole at $r = 0$. He smooths along these rays so that they have sharper and sharper corners as $r \rightarrow \infty$. Menguy is able to cut out a sequence of smaller and smaller lemons and glue in the Perelman building blocks so that his manifold has infinite second Betti number and volume growth Cr^4 . See Figure 12. Menguy also claims one could similarly construct M^{2n} with all

even Betti numbers infinite although this construction is only briefly outlined. [Mng1]

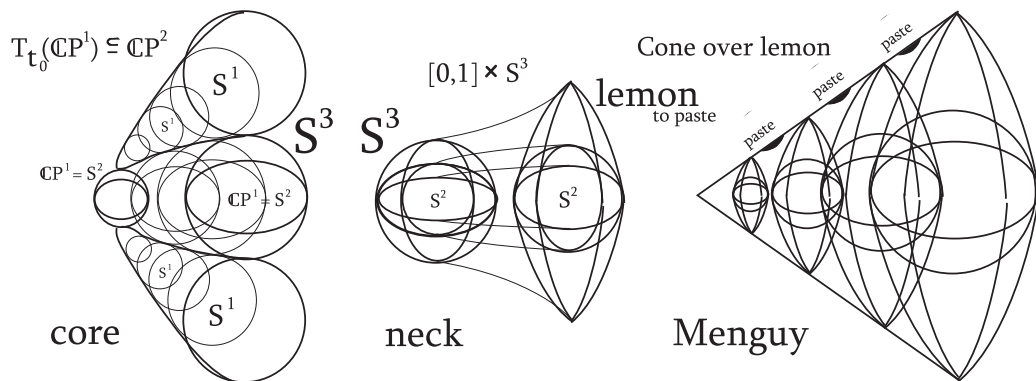

Figure 12: Gluing the core to the neck, then repeatedly into Menguy's M_0 .

Menguy's Bounded Diameter Example (2000): *On the other extreme Menguy constructs an M^4 with bounded diameter growth. This is achieved using the same Perelman building blocks edited into a manifold which is shaped somewhat like a sword:*

$$dr^2 + f(r)^2(ds^2 + \cos^2(s)R_0d\sigma^2), \quad (4.5)$$

where $f(r)$ is bounded above. [Mng2]

Vector Bundles

According to Cheeger-Gromoll's soul theorem, every complete open manifold of $K \geq 0$ is diffeomorphic to a vector bundle over a closed manifold with $K \geq 0$ [ChG11]. Thus it is a natural problem whether or not a vector bundle over a closed manifold with $K \geq 0$ admits a complete metric with $K \geq 0$. Although the topology of complete open manifolds with $Ric \geq 0$ is much more complicated, one can also study an analogue of the problem for vector bundles over a closed manifold with $Ric \geq 0$.

The first notable result in this direction is due to **Nash** and **Berard-Bergery** ([Nsh], [Ber]). They prove that every vector bundle of rank ≥ 2 over a compact manifold with $Ric > 0$ admits a complete metric with $Ric > 0$. Note that rank one vector bundles have lines so they cannot admit a metric with $Ric > 0$ by the Cheeger-Gromoll splitting theorem. In fact

Berard-Bergery proves that if M^n has $Ricci \geq 0$ then there is a metric on $\mathbb{R}^p \times M^n$ with $Ricci > 0$ for all $p \geq 3$ [Ber]. **Otsu** constructed manifolds with $Ricci \geq 0$ and Euclidean volume growth diffeomorphic to $\mathbb{R}^{n-k} \times S^k$ and $\mathbb{R}^{n-k} \times \mathbb{R}P^2$ where $k \geq 2$ [Ot]. According to **Anderson** [And1], no R^2 -bundle over a torus admits a complete metric with $Ric > 0$.

In 2002, **Belegradek-Wei** constructed metrics of positive Ricci curvature on vector bundles over nilmanifolds. For any complex line bundle, L , over a nilmanifold, there is a sufficiently large k such that the the Whitney sums of k copies of L admit metrics of positive Ricci curvature. In particular if B has $Ricci \geq 0$ and $\dim T \geq 4$, then for any sufficiently large k , there are infinitely many rank k vector bundles over $B \times T$ with topologically distinct total spaces which admit metrics of $Ricci > 0$ but are not homeomorphic to manifolds of $sec \geq 0$ by work of Belegradek-Kapovitch [BelWei1][BelKap].

In 2004, **Belegradek-Wei** construct further examples as follows. Let B be a closed manifold with $Ric \geq 0$. If $E(\xi)$ is the total space of a vector bundle ξ over B , then $E(\xi) \times \mathbb{R}^p$ admits a complete Riemannian metric with $Ric > 0$ for all large p . In fact, B need not have $Ricci \geq 0$ as long as B is the total space of a smooth fiber bundle $F \rightarrow B \rightarrow S$, where F, S are closed manifolds with $Ric \geq 0$ and the structure of the bundle lies in the isometry group of F . It can be shown that such a manifold B admits a metric of almost nonnegative Ricci curvature, but has no metric of $Ricci \geq 0$ yet $E(\chi) \times \mathbb{R}^p$ will still admit a metric with positive Ricci curvature. The minimum value of p depends on B and its bundle structure. The constructions are warped products $\mathbb{R}^+ \times_f E(\chi) \times_h S^{p-1}$ where $f(0) = 1$ and $h(0) = 0$. For further details and many explicit examples see [BelWei2].

For additional information about open manifolds with sectional curvature $K \geq 0$ see Greene's survey [Gre].

5 Three Manifolds

In this section we review the properties of complete noncompact 3 manifolds, M^3 , with nonnegative Ricci curvature. The most substantial contribution to this topic is in Schoen-Yau's 1982 paper:

Three Manifold Theorem of Schoen-Yau (1982) *If M^3 has $Ricci > 0$ then M^3 is diffeomorphic to \mathbb{R}^3 .*[SchYau1]

Open Problem on Three Manifolds with $Ricci \geq 0$: *Classify the topology of M^3 and prove the Milnor Conjecture in dimension three.*

Schoen and Yau never had the opportunity to investigate this nontrivial problem further after their original paper on manifolds with positive Ricci curvature. Recently Schoen has suggested that *Ricci flow* might be used to prove that these manifolds are either diffeomorphic to manifolds with split covering spaces or manifolds with positive Ricci curvature in which case their theory should apply. However when **Shi** tried using Ricci flow he needed an additional upper bound on sectional curvature to ensure the uniqueness of the flow [Shi]. Perhaps more recent methods on Ricci flow would prove effective.

Here we will describe what is known about this open problem in some detail and provide some relevant information from three manifold topology. We begin by reviewing Schoen-Yau's paper.

Proof Outline: Schoen-Yau begin with a proof that M^3 with only $Ricci \geq 0$ has $\pi_2(M) = 0$ unless M is isometrically covered by a product of a real line with a compact surface S^2 which involves the Cheeger-Colding splitting theorem. To study the fundamental group, they then assume $\pi_2(M) = 0$, that M is orientable and the fundamental group is \mathbb{Z} generated by an element represented by a curve σ . They use Poincare Duality to create a sequence of compact orientable surfaces, Σ_i , which intersect σ , such that $\partial\Sigma_i \subset \partial M_i$ and $\bigcup M_i = M$. They, in fact, choose these Σ_i to be minimal in their homotopy class, thus allowing them to use minimal surface methods to prove that a subsequence of the Σ_i converge to a complete *noncompact stable minimal surface* Σ . Fischer-Colbrie and Schoen had proven earlier that such a Σ must be totally geodesic and $Ricci(N, N) = 0$ where N is any normal to Σ .

Adding the assumption that $Ricci > 0$, Schoen-Yau conclude that M^3 is contractible since such Σ cannot exist. They then proceed to prove M^3 is simply connected at infinity as well, again using a minimal surface contradiction argument involving positive Ricci curvature. Finally they prove M^3 is irreducible using a complicated technical argument that Kleiner notes would be greatly simplified if one assumes that Poincare Conjecture has been proven. Applying a result of Stallings they complete the proof of their theorem.

Assuming only $Ricci \geq 0$, one would have to carefully examine the possibilities that arise from the existence of such a minimal surface Σ . **Meeks-Simon-Yau** [MSY] have done partial work in this direction showing a compact three manifold with mean convex boundary that has $Ricci \geq 0$ is a solid handlebody. Note **Ananov-Burago-Zalgaller** [AnBuZg] obtained the same result by studying the Morse theory of the distance function to the boundary rather than Σ . **Anderson-Rodriguez** [AndRod] added the ad-

ditional assumption that sectional curvature is bounded above and proved that the existence of Σ implies $M^3 = \Sigma \times \mathbb{R}^+$ when Σ and M are oriented. This agrees with Shi's results using Ricci flow [Shi].

In 1994 **S-H Zhu** carefully went through Schoen-Yau's proof and showed that in fact M^3 with $Ricci \geq 0$ that has $Ricci > 0$ at one point is diffeomorphic to \mathbb{R}^3 . So the open case in three dimensions was reduced to studying M^3 with a global vector field, V , such that $Ricci(V, V) \geq 0$. [Zhu2].

Earlier **S-H Zhu** had proven that if M^3 has only $Ricci \geq 0$ and

$$\lim_{r \rightarrow \infty} Vol(B_p(r))/r^3 > 0 \tag{5.1}$$

then M^3 is contractible [Zhu1]. He first shows $\pi_1(M^3) = 0$ because if $M^3 = S^2 \times \mathbb{R}$ then its volume growth is linear. He then proves $\pi_1(M^3)$ is torsion free, which is true in general, but contradicts Anderson and Li's assertion that it is finite unless $\pi_1(M^3) = 0$ as well. Zhu's Theorem is not true in dimensions four as demonstrated by Menguy and Otsu's examples [Mng1] [Ot].

Without any volume assumptions, we know from Shen-Sormani that $H_2(M^3, \mathbb{Z})$ is classified and that $H_1(M, \mathbb{Z})$ is torsion free. In fact $\pi_1(M)$ is completely understood as long as it is finitely generated. From Wilking's reduction of the Milnor Conjecture, we then need only understand the topology of a three manifold, N^3 , $\pi_1(M^3)$ infinitely generated and abelian.

Topologists **Evans** and **Moser** proved that if the fundamental group of a three manifold is not finitely generated, then it is a subgroup of the additive group of rational numbers [EvMo]. So we need only worry about fundamental groups like the dyadic rationals:

$$\left\{ \frac{p}{2^j} : p \in \mathbb{Z}, j \in \{0, 1, 2, 3, \dots\} \right\}. \tag{5.2}$$

It is important to note that there is a well-known topological construction of an open three manifold, N^3 , whose fundamental group is the rationals. It is based on the following example studied thoroughly by **Steenrod** in [Str] who credits **Vietoris** with the idea. A similar construction by **Whitehead** was used to construct a contractible three manifold which isn't diffeomorphic to \mathbb{R}^3 [Wth].

The Dyadic Solenoid Complement is an open topological manifold, N^3 , such that $\pi_1(N^3) = \{k/2^j : k \in \mathbb{Z}, j \in \mathbb{N}\}$. Often this example is described as S^3 with the dyadic solenoid knot removed where the knot is a

Cantor set bundle over an S^1 , but the following construction using embedded tori gives a more geometric illustration.

Construction: We begin with a solid torus, $N_0 = S^1 \times D^2$, with a curve $C_0 : S^1 \rightarrow S^1 \times D^2$ with winding number 2. Removing a small neighborhood around the image of C_0 , we get the building block of our space

$$N_i = (S^1 \times D^2) \setminus T_\epsilon(C_0(S^1)). \quad (5.3)$$

This block has two boundary components, ∂N_i^- and

$$\partial N_i^+ = \partial T_\epsilon(C_0(S^1)) \quad (5.4)$$

both of which are homeomorphic to T^2 . We build N^3 by gluing all the N_i together so that ∂N_0 is glued to ∂N_1^- , and each ∂N_i^+ is glued to ∂N_{i+1}^- . This is depicted somewhat inside-out in Figure 13, where we see each block N_i is stretched out, wound around twice and embedded into the previous block N_{i-1} .

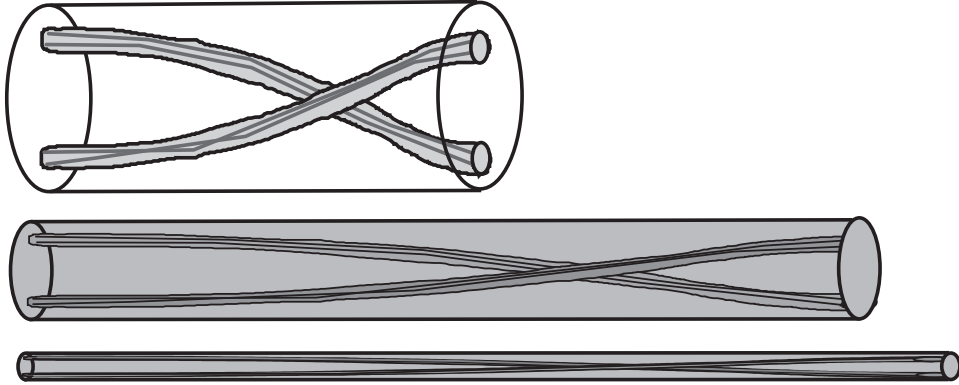

Figure 13: Constructing the Dyadic Solenoid Complement

Note that the closure $K_j = Cl(\bigcup_{i=1}^j N_i)$ is compact and that K_j exhaust N^3 . Any curve $C : S^1 \rightarrow N^3$ is sitting in some K_j . Wrapping twice around C , one gets a curve homotopic to a simple curve in $N_{j+1} \subset K_{j+1}$. In fact the halfway generators will have the form:

$$g_1^2 = g_0, \quad g_2^2 = g_1, \quad g_3^2 = g_2, \quad g_4^2 = g_3, \dots \quad (5.5)$$

if we choose a point $p \in N_0$ and make each subsequent N_i significantly larger than the previous one. The fundamental group of the dyadic solenoid is thus the dyadic rationals with addition as the operation.

By taking the winding numbers of successive tori to run through every natural number instead of just the number 2, one obtains a space N^3 such that $\pi_1(N^3)$ is the rationals.

Open Problem on the Dyadic Solenoid Complement: *By Schoen-Yau, we know N^3 does not admit a metric with positive Ricci curvature but it is an open question as to whether it admits a metric with $\text{Ricci} \geq 0$.* Note that one must check it satisfies all the topological restrictions on three manifolds with $\text{Ricci} \geq 0$.

6 Open Problems:

We have attempted to state all known topological results and examples concerning complete noncompact M^n with $\text{Ricci} \geq 0$ or $\text{Ricci} > 0$ that have either no additional conditions or only restrictions on:

- * dimension
- * diameter growth
- * volume growth

There are a number of beautiful theorems with additional conditions like bounds on conjugacy radius, bounds on sectional curvature, quadratically decaying positive lower bounds on Ricci curvature, and properness to name a few. However, without additional conditions, everything else is open.

For those wishing to investigate restrictions to the topology of **open four manifolds** with $\text{Ricci} \geq 0$ work by Noronha [Nor] and Sha-Yang [ShaYng3] on compact four manifolds with $\text{Ricci} \geq 0$ might be helpful. Keep in mind the many examples given in this paper as well as the fact that $H_3(M^4, Z) = 0$ and $H_2(M^4, Z)$ is torsion free except for M^4 with split double covers.

For those wishing to investigate restrictions of the topology of manifolds with additional volume constraints, one approach would be to assume M^n has at most **quadratic volume growth** and try to use Cheng-Yau's result that such an M^n is parabolic to restrict the topology [ChgYau].

For those wishing to construct examples with interesting topology remember **the key qualitative properties of M^n are:**

- * have a cover with an abelian fundamental group [Wlk]
- * satisfy the loops to infinity property [Sor4]

* have volume growth which is not maximal [Li] nor minimal [Sor3]

* have large linear diameter growth [Sor3]

It is possible that the dyadic solenoid complement, N^3 satisfies all these conditions.

The Warped Dyadic Solenoid, $N^3 \times \mathbb{R}^k$, is a more likely Milnor counter example than N^3 itself, as we have seen how one can construct metrics with $Ricci > 0$ on vector bundles. Proving $N^3 \times \mathbb{R}^k$ does not admit a metric with $Ricci \geq 0$ would be of some interest and might be done using harmonic map techniques developed by Schoen-Yau in [SchYau2]. Constructing a metric with $Ricci \geq 0$ on $N^3 \times \mathbb{R}^k$ would be an astoundingly important result! It would lead to many new questions such as:

* What is the smallest diameter growth of a Milnor counter example?

* What is the largest volume growth of a Milnor counter example?

* What is the smallest volume growth of a Milnor counter example?

* What is the smallest dimension of a Milnor counter example?

Even without the existence of a Milnor counter example, one may well ask these questions of M^n with a prescribed almost nilpotent fundamental group.

We hope that this survey article will provide new intuition and insight allowing the readers to find open problems of their own. Until the topology of M^n is completely understood, there is much work to be done.

7 Acknowledgments:

We thank Guofang Wei and John Lott for clarifying some of the literature, William Minicozzi for suggesting the quadratic volume growth problem, Shing-Tung Yau for first mentioning to the second author that $\pi_1(M^n)$ might be the rationals and Mikhail Khovanov for describing the construction of the dyadic solenoid complement using embedded tori. We would also like to thank John Hempel, Bruce Kleiner, Rob Schneiderman, John Smillie and Rick Schoen for discussions and emails related to the section on three manifolds. The second author would like to thank Courant Institute for its hospitality.

References

- [And1] M. T. Anderson. *On the topology of complete manifolds of nonnegative Ricci curvature*. *Topology* 29 (1990), no. 1, 41–55.
- [AndRod] M. T. Anderson and L. Rodriguez, *Minimal surfaces and 3-manifolds of nonnegative Ricci curvature*. *Math. Ann.* 284 (1989), no. 3, 461–475.
- [AndKrLb] M. T. Anderson, P. Kronheimer, and C. LeBrun, *Complete Ricci-flat Kahler manifolds of infinite topological type*, *Comm. Math. Phys.* 125 (1989) 637-642.
- [AnBuZg] N. G. Ananov, Yu D. Burago, and V. A. Zalgaller, *Three-dimensional manifolds with boundary of nonnegative Ricci curvature*. (Russian) *Mat. Sb. (N.S.)* 128(170) (1985), no. 2, 169–193, 287. (English) *Math USSR-Sb. Vol 56 1987 no 1* 163-186.
- [BelKap] Igor Belegradek and Vitali Kapovitch, *Topological obstructions to nonnegative curvature*. *Math. Ann.* 320 (2001), no. 1, 167–190.
- [BelWei1] Igor Belegradek and Guofang Wei *Metrics of positive Ricci curvature on vector bundles over nilmanifolds*. *Geom. Funct. Anal.* 12 (2002), no. 1, 56–72.
- [BelWei2] Igor Belegradek and Guofang Wei *Metrics of positive Ricci curvature on bundles*. *Int. Math. Res. Not.* 2004, no. 57, 3079–3096.
- [Ber] L. Berard-Bergery, *Quelques exemples de varietes riemanniennes completes non-compactes a courbure de Ricci positive*, *C.R. Acad. Sc. Paris*, **302**(1986), 159-161.
- [Bi] R. Bishop. *A Relation Between Volume, Mean Curvature and Diameter*. *Amer. Math. Soc. Not.* 10 (1963), 364.
- [ChCo] J. Cheeger and T. Colding. *On the structure of spaces with Ricci curvature bounded below. I*. *J. Differential Geom.* 46 (1997), no. 3, 406–480
- [ChGl1] J. Cheeger and D. Gromoll, *On the structure of complete manifolds of nonnegative curvature*. *Annals of Math.* (2) 96 (1972), 413–443

- [ChGl] J. Cheeger and D. Gromoll, *The splitting theorem for manifolds of nonnegative Ricci curvature*. J. Differential Geometry 6 (1971/72), 119–128.
- [ChgYau] S. Y. Cheng and S. T. Yau, *Differential equations on Riemannian Manifolds and their Geometri Applications*, Comm. Pure Appl. Math. 28 (1975) 333–354.
- [Cv] S. Cohn-Vossen, *Totalkrümmung und geodätische Linien auf einfach zusammenhängenden offenen vollständigen Flächenstücken*, Recueil Mathématique de Moscou 43 (1936) 139–163.
- [Co] T. Colding, *Ricci curvature and volume convergence*. Ann. of Math. (2) 145 (1997), no. 3, 477–501.
- [Dt] D. M. DeTurck, *Existence of metrics with prescribed Ricci curvature: local theory*. Invent. Math. 65 (1981/82), no. 1, 179–207.
- [EscHe] J. Eschenburg and E. Heintze, *An elementary proof of the Cheeger Gromoll splitting theorem*. Ann. Global Anal. Geom. 2 (1984), no. 2, 141–151.
- [EvMo] B. Evans and L. Moser, *Soluble fundamental groups of compact 3 manifolds*, Trans. Amer. Math. Soc, 168 (1972), 189–220.
- [GeoMih] R. Geoghegan and M. Mihalik, *The fundamental group at infinity*. Topology 35 (1996), no. 3, 655–669.
- [Gre] R.E. Greene, *A genealogy of noncompact manifolds of nonnegative curvature: history and logic*. Comparison geometry (Berkeley, CA, 1993–94), 99–134, Math. Sci. Res. Inst. Publ., 30, Cambridge Univ. Press, Cambridge, 1997.
- [GIMey] D. Gromoll and W.T. Meyer. *Examples of complete manifolds with positive Ricci curvature*. J. Differential Geom. 21 (1985), no. 2, 195–211.
- [Gr1] M. Gromov *Groups of polynomial growth and expanding maps*. Inst. Hautes Etudes Sci. Publ. Math. No. 53 (1981), 53–73.
- [Gr2] M. Gromov. *Metric structures for Riemannian and non-Riemannian spaces*, PM 152, Birkhauser, 1999.

- [ItKo] Y. Itokawa and R. Kobayashi, *Minimizing Currents in Open Manifolds and the $n-1$ Homology of Nonnegatively Ricci Curved Manifolds*, Amer. J. Math. 121 (1999), no. 6, 1253–1278.
- [Li] P. Li, *Large time behavior of the heat equation on complete manifolds with nonnegative Ricci curvature*. Ann. of Math. (2) 124 (1986), no. 1, 1–21.
- [Lok] J. Lohkamp, *Negative bending of open manifolds*. J. Differential Geom. 40 (1994), no. 3, 461–474.
- [MSY] William Meeks III, Leon Simon, and Shing-Tung Yau, *Embedded minimal surfaces, exotic spheres, and manifolds with positive Ricci curvature*. Ann. of Math. (2) 116 (1982), no. 3, 621–659.
- [Mng1] X. Menguy. *Noncollapsing Examples with Positive Ricci Curvature and Infinite Topological Type*. Geom. Funct. Anal. 10 (2000), no. 3, 600–627.
- [Mng2] X. Menguy . *Examples with Bounded Diameter Growth and Infinite Topological Type* Duke Math. J. 102 (2000), no. 3, 403–412.
- [Mil] J. Milnor, *A note on curvature and fundamental group*. J. Differential Geometry 2 1968 1–7.
- [Nab] P. Nabonnand, *Sur les variétés riemanniennes complètes ‘ courbure de Ricci positive*. (French) C. R. Acad. Sci. Paris Sér. A-B 291 (1980), no. 10, A591–A593.
- [Nsh] J. C. Nash, *Positive Ricci curvature on fiber bundles*, J. Differential Geometry 14 (1979) 241–254.
- [Nor] M. H. Noronha, *Some results on the topology of four-manifolds with nonnegative curvature*. Illinois J. Math. 40 (1996), no. 3, 390–401.
- [Ot] Y. Otsu, *On manifolds of positive Ricci curvature and large diameter*. Mathematische Zeitschrift 206, 255–264 (1991).
- [Per1] G. Perelman, *Manifolds of positive Ricci curvature with almost maximal volume*, JAMS, 7(1994), 299–305.

- [Per2] G. Perelman, *Construction of Manifolds of Positive Ricci Curvature with Big Volume and Large Betti Numbers*. Comparison geometry (Berkeley, CA, 1993–94), 157–163, Math. Sci. Res. Inst. Publ., 30, Cambridge Univ. Press, Cambridge, 1997.
- [SchYau1] R. Schoen and S-T Yau, *Complete three-dimensional manifolds with positive Ricci curvature and scalar curvature*. Seminar on Differential Geometry, pp. 209–228, Ann. of Math. Stud., 102, Princeton Univ. Press, Princeton, N.J., 1982.
- [SchYau2] R. Schoen and S-T Yau, Harmonic maps and the topology of stable hypersurfaces and manifolds with non-negative Ricci curvature. Comment. Math. Helv. 51 (1976), no. 3, 333–341.
- [SchYau3] R. Schoen and S-T Yau, Lectures on differential geometry. International Press, Cambridge, MA, 1994.
- [ShaYng1] J-P Sha and D-G Yang, *Examples of manifolds of positive Ricci curvature*. J. Differential Geom. 29 (1989), no. 1, 95–103.
- [ShaYng2] J-P Sha and D-G Yang, *Positive Ricci curvature on the connected sums of $S^n \times S^m$* . J. Differential Geom. 33 (1991), no. 1, 127–137.
- [ShaYng3] J-P Sha and D-G Yang, *Positive Ricci curvature on compact simply connected 4-manifolds*. Differential geometry: Riemannian geometry (Los Angeles, CA, 1990), 529–538, Proc. Sympos. Pure Math., 54, Part 3, Amer. Math. Soc., Providence, RI, 1993.
- [Shn] Z. Shen, *On complete manifolds of nonnegative k -Ricci curvature*. Trans. Amer. Math. Soc. 338 (1993), no. 1, 289–310.
- [ShnSor] Z. Shen and C. Sormani, *The Codimension One Homology of a Complete Manifold with Nonnegative Ricci Curvature* American Journal of Mathematics 123 (2001), no. 3, 515–524.
- [ShnWei] Z. Shen and G. Wei, *Volume growth and finite topological type*, Proc. of Symposia in Pure Math., 54 vol. 3 (1993), 539–549.
- [Shi] W. X. Shi. *Complete noncompact three-manifolds with nonnegative Curvature*. J. Diff. Geom. 29(1989), 353–360.

- [Sor1] C. Sormani, *Busemann Functions on Manifolds with Lower Ricci Curvature Bounds and Minimal Volume Growth*. Journal of Differential Geometry vol 48 (1998), 557-585 .
- [Sor2] C. Sormani, *The Rigidity and Almost Rigidity of Manifolds with Minimal Volume Growth*, Communications in Analysis and Geometry, Vol 8, No. 1, 159-212, January 2000.
- [Sor3] C. Sormani, *Nonnegative Ricci Curvature, Small Linear Diameter Growth, and Finite Generation of Fundamental Groups*, Journal of Differential Geometry 54 (2000), no. 3, 547–559.
- [Sor4] C. Sormani, *On Loops Representing Elements of the Fundamental Group of a Complete Manifold with Nonnegative Ricci Curvature*, Indiana Journal of Mathematics, 50 (2001) no. 4, 1867-1883.
- [Str] N. E. Steenrod, *Regular cycles of compact metric spaces*. Lectures in Topology, pp. 43–55. University of Michigan Press, Ann Arbor, Mich., 1941.
- [Wei] G. Wei, *Examples of complete manifolds of positive Ricci curvature with nilpotent isometry groups*. Bull. Amer. Math. Soc. (N.S.) 19 (1988), no. 1, 311–313.
- [Wth] Whitehead. *A certain open manifold whose group is unity* Quart J Math (2) 6 1953 268-279.
- [Wlk] B. Wilking. *On Fundamental Groups of Manifolds of Nonnegative Curvature*. preprint 1998. Differential Geom. Appl. 13 (2000), no. 2, 129–165.
- [Wra] David Wraith, *Surgery on Ricci positive manifolds*. J. Reine Angew. Math. 501 (1998), 99–113.
- [Wy] W. Wylie *Noncompact Manifolds with Nonnegative Ricci Curvature*, Journal of Geometric Analysis, volume 16, issue 3, September 2006 p. 535-550.
- [XuWaYa] Senlin Xu, Zuoqin Wang, and Fangyun Yang, *On the fundamental group of open manifolds with nonnegative Ricci curvature*. Chinese Ann. Math. Ser. B 24 (2003), no. 4, 469–474.

- [Yau1] S. T. Yau, *Harmonic functions on complete Riemannian manifolds*. Comm. Pure Appl. Math. 28 (1975), 201–228.
- [Yau2] S. T. Yau, *Some function-theoretic properties of complete Riemannian manifold and their applications to geometry*, Indiana Univ. Math. J. **25**(1976), 659-670.
- [Zhu1] S. Zhu, *A finiteness theorem for Ricci curvature in dimension three*, J. Diff. Geom., (1993), 711-727.
- [Zhu2] S. Zhu, *On open three manifolds of quasi-positive Ricci curvature*. Proc. Amer. Math. Soc. 120 (1994), no. 2, 569–572.