

AUTHOR: Iain Moffatt DEGREE: Ph.D.

TITLE: Integration and Conjugacy in Knot Theory

DATE OF DEPOSIT:

I agree that this thesis shall be available in accordance with the regulations governing the University of Warwick theses.

I agree that the summary of this thesis may be submitted for publication.

I agree that the thesis may be photocopied (single copies for study purposes only).

Theses with no restriction on photocopying will also be made available to the British Library for microfilming. The British Library may supply copies to individuals or libraries, subject to a statement from them that the copy is supplied for non-publishing purposes. All copies supplied by the British Library will carry the following statement:

“Attention is drawn to the fact that the copyright of this thesis rests with its author. This copy of the thesis has been supplied on the condition that anyone who consults it is understood to recognise that its copyright rests with its author and that no quotation from the thesis and no information derived from it may be published without the author’s written consent.”

AUTHOR’S SIGNATURE:

USER’S DECLARATION

1. I undertake not to quote or make use of any information from this thesis without making acknowledgement to the author.
2. I further undertake to allow no-one else to use this thesis while it is in my care.

DATE	SIGNATURE	ADDRESS
.....
.....
.....
.....
.....

arXiv:math/0511432v1 [math.GT] 17 Nov 2005

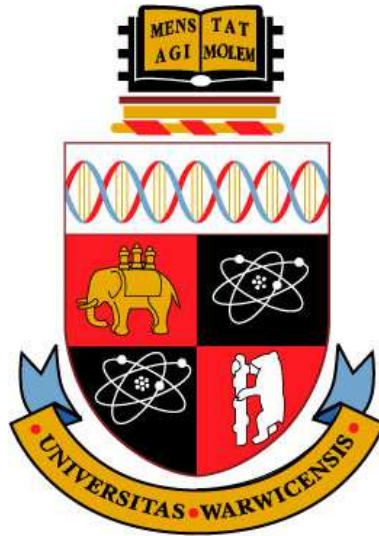

Integration and Conjugacy in Knot Theory

by

Iain Moffatt

Thesis

Submitted to the University of Warwick

for the degree of

Doctor of Philosophy

Mathematics Institute

November 2004

THE UNIVERSITY OF
WARWICK

Contents

List of Figures	v
Acknowledgements	vi
Declarations	vii
Abstract	viii
Chapter 1 The μ-invariants and the Århus Integral	1
1.1 Introduction	1
1.2 Tangles and String-links	1
1.3 Milnor's μ -invariants	3
1.4 The Algebras	5
1.5 The Århus Integral	8
1.6 The Århus Integral and the μ -invariants	10
1.7 The First Non-vanishing μ -invariant	15
Chapter 2 A Diagrammatic formula for the Free Energy	17
2.1 Introduction	17
2.2 Statement of Results	17
2.3 The Proofs	19
Chapter 3 On the Word and Conjugacy Problems for Link Groups	24
3.1 Introduction	24
3.2 Definitions	26
3.3 Small Cancellation Theory and the Word Problem	28
3.4 A solution to the Word Problem by Normal Surfaces	31
3.5 Loops and the Dehn Presentation	34
3.6 Hierarchies and the Dehn Presentation	35
3.7 A Comparison of the Algorithms for the Word Problem	36
3.8 The Role of Non-Positive Curvature	39

3.9	A Small Cancellation Solution for the Conjugacy problem	41
3.10	The Algorithm in Action	43
3.11	Normal Surfaces and the Conjugacy Problem	45
3.12	Process X and the Petronio Cell Decomposition	49
3.13	Planarity of the Conjugacy Algorithm	51
3.14	A New Proof that Alternating Links are Non-Trivial	53

List of Figures

1.1	A string-link and its deformation closure.	2
1.2	The STU, AS and IHX relations.	5
1.3	An example of multiplication.	6
1.4	An example of the map $\chi_{\{b\}}$	6
1.5	An example of the map D_S	7
1.6	An example of the isomorphism $\mathcal{C}_3^t(\{a, b\}, z) \rightarrow \text{Lie}_3(2)$	8
1.7	An example of $j_z : \mathcal{C}_3^t(\{a, b\}) \rightarrow \text{Lie}_3(2)$	8
1.8	An example of the pairing $\langle D_1, D_2 \rangle_S$	9
1.9	Two tangles which differ by a pure braid.	12
1.10	The pure braid $\sigma_{0,i} \otimes 1_M$	14
2.1	Examples of definition 2.1.	18
3.1	A crossing ball.	26
3.2	Regions of a link.	26
3.3	Relators for the presentation.	27
3.4	A chain.	29
3.5	Type 1 and 2 moves.	32
3.6	A hierarchy for the figure 8 knot.	32
3.7	A type 2 deformation.	36
3.8	Realizing a type 2 deformation.	36
3.9	A projection of a type 2 deformation.	37
3.10	The moves on the Petronio cell decomposition.	50
3.11	A diagram used in the proof of planarity.	52
3.12	Another diagram used in the proof of planarity.	53
3.13	The argument of lemma 3.7.	54

Acknowledgements

First and foremost I would like to thank my supervisor Stavros Garoufalidis for his support, guidance and suggestions. Most of this thesis was written while a visitor at Georgia Institute of Technology between November 2003 and May 2004 and I would like to thank the math department for its hospitality, EPSRC for providing the bulk of the financial support and Colin Rourke for being my Warwick contact. Finally I would like thank Daan Krammer, whose suggestions greatly improved chapter 2, Werner Nickel for some GAP code and Daniel Groves, Derek Holt, Chuck Miller and Alvaro Pelayo for sharing some of their mathematical knowledge with me.

Declarations

Except where otherwise stated, this thesis is my own work. I confirm that this thesis has not been submitted for a degree at any other university. Some of the results presented here have been submitted for publication.

Abstract

This thesis consists of three self-contained chapters. The first two concern quantum invariants of links and three manifolds and the third contains results on the word problem for link groups.

In chapter 1 we relate the tree part of the Århus integral to the μ -invariants of string-links in homology balls thus generalizing results of Habegger and Masbaum.

There is a folklore result in physics saying that the Feynman integration of an exponential is itself an exponential. In chapter 2 we state and prove an exact formulation of this statement in the language which is used in the theory of finite type invariants.

The final chapter is concerned with properties of link groups. In particular we study the relationship between known solutions from small cancellation theory and normal surface theory for the word and conjugacy problems of the groups of (prime) alternating links. We show that two of the algorithms in the literature for solving the word problem, each using one of the two approaches, are the same. Then, by considering small cancellation methods, we give a normal surface solution to the conjugacy problem of these link groups and characterize the conjugacy classes. Finally as an application of the small cancellation properties of link groups we give a new proof that alternating links are non-trivial.

Chapter 1

The μ -invariants and the Århus Integral

In this chapter we relate the tree part of the Århus integral to the μ -invariants of string-links in homology balls.

1.1 Introduction

Milnor's $\bar{\mu}$ -invariants of Links and their well defined cousins, the μ -invariants of string-links are classical and well-studied invariants. These invariants have been brought into the realm of finite-type invariants by Bar-Natan in [6], Lin in [34] and Habegger and Masbaum in [24]. Here we are particularly interested in Habegger and Masbaum's formula which expresses the μ -invariants in terms of the tree part of the Kontsevich integral.

The literature on the $\bar{\mu}$ -invariants is mostly concerned with links in S^3 . The generalization to $\bar{\mu}$ -invariants of links in integral homology spheres and μ -invariants of string-links in homology balls exists mostly as folklore. We discuss the μ -invariants of string-links in homology balls and generalize Habegger and Masbaum's results by relating the μ -invariants to the Århus integral, which is a generalization of the Kontsevich integral to links in rational homology spheres, defined in [7, 8, 9]. We do this by representing string-links in homology spheres by string-links in $D^2 \times I$ with some distinguished surgery components.

The reader may find some familiarity with the basic properties of the Kontsevich integral useful.

1.2 Tangles and String-links

Let B^M be a connected, compact orientable 3-manifold equipped with a fixed identification φ of the boundary with $\partial(D^2 \times I)$. A *tangle* of n components $T \subset B^M$ is a smooth compact 1-manifold X , of n components, together with a smooth embedding $T : (X, \partial(X)) \rightarrow$

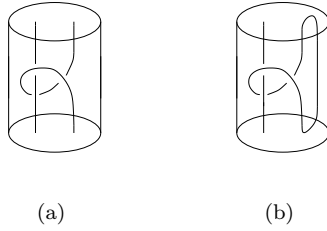

Figure 1.1: A string-link and its deformation closure.

$(B^M, \partial(B^M))$, transverse to the boundary. As is standard, we abuse notation and confuse a tangle, its embedding and its isotopy class.

By a *framing* on a component i of a tangle we mean that we equip i with a non-vanishing vector field such that the restriction to the boundary is the restriction of a fixed unit vector field normal to the x -axis of D^2 under the identification.

A *coloured* tangle is a tangle equipped with a bijection from the components onto a set of cardinality n , where n is the number of components of the tangle.

Since B^M can be obtained by surgery on a framed link $L \subset D^2 \times I$, we may represent a tangle $T \subset B^M$ by a tangle $T' \subset D^2 \times I$ some of whose components are distinguished framed copies of S^1 , on which we do the surgery. We say that T' *represents* T . We will call these distinguished components the *surgery components* and the other components the *linking components*. If the tangle T is coloured then this partitions the colouring set into sets corresponding to the surgery components and the linking components. In this chapter we denote these sets X_M and X_L respectively.

We now turn our attention to defining string-links in a homology ball B^M . These are the type of tangles we will be concerned with.

Fix a collection of points $p_1 < p_2 < p_3 < \dots$ on the x -axis of D^2 . These induce sets of points on $\partial(D^2 \times I)$ which we call the *standard points*. By a *string-link of n components* $\sigma \subset B^M$ we mean a tangle $\sigma : \cup_{i=1}^n I_i \rightarrow B^M$ such that under the identification of the boundary with $\partial(D^2 \times I)$ we have $\sigma|_{I_i}(j) = p_i \times j$, for $j = 0, 1$, where p_i is the i -th standard point and I is the closed unit interval. Note that a string-link has no closed components.

The two sets of *standard points* of a string link are the subsets of standard points on $D^2 \times \{j\}$, $j = 0, 1$ which are the boundary points of a string-link component.

Given a string-link $\sigma \subset D^2 \times I$, we can change a given set A of (interval) components of σ into S^1 components by constructing non-intersecting paths on $\partial(D^2 \times I)$ between the two endpoints of each interval component, and pushing these paths and the endpoints of the components of A slightly into the interior of $D^2 \times I$. This gives a tangle which we call the *deformation closure* of σ with respect to A . An example is given in Figure 1.1, where the deformation closure is with respect to the right hand component.

We can *represent* any string-link $\sigma' \subset B^M$ by a string-link $\sigma \subset D^2 \times I$ with a specified

set of framed surgery components, where σ' is obtained by carrying out surgery on the deformation closure of the surgery components of σ .

A *parenthesization* of a set of standard points is a bracketing of that set (for example $((p_1p_2)(p_3(p_4p_5)))$). We call the parenthesization $((((p_1p_2)p_3)\cdots)p_n)$ the *canonical parenthesization*. A *parenthesization* of a string-link is a parenthesization of its two sets of standard points.

Note that a parenthesization on a string-link in $D^2 \times I$ induces one on any string-link in B^M it represents.

Definition 1.1. A *manifold string-link* is a canonically parenthesized, coloured, framed string-link in $D^2 \times I$ with a set of linking components X_L and surgery components X_M .

We say that a manifold string-link is *regular* if the linking matrix of its surgery components is invertible (so surgery yields a string-link in a rational homology ball).

We will now define some actions on the set of string-links which we will make use of later. As these are well known and somewhat fiddly to define, we gloss over the technical details and rely upon the reader's intuition.

If two string-links σ_1 and σ_2 in $D^2 \times I$ have the same number of components then we may form a product $\sigma_1 \cdot \sigma_2$ in the usual way by “putting σ_2 on top of σ_1 ”. If the string links are parenthesized or coloured we require that the parenthesization or colourings match on the two disks identified under the composition.

We also define $\sigma_1 \otimes \sigma_2$ to be the string link obtained by “placing σ_2 to the right of σ_1 ”.

Let $T \subset B^M$ be an X -coloured tangle and let $A \subset X$. Define $\varepsilon_A(T)$ to be the tangle obtained from T by deleting all of the components with colours in A . Further let B be a set disjoint from X and let $S \subset X \times B$ such that any element of X or B appears in at most one pair $(x, b) \in S$. We define $D_S(T)$ to be the coloured tangle obtained from T by, for each $(x, b) \in S$, doubling the x -coloured component and colouring the double with b . When dealing with string-links we may have to isotope them so that the endpoints lie on the appropriate standard points.

1.3 Milnor's μ -invariants

Recall that given a ring R , a *R -homology sphere* is a 3-manifold M such that $H_q(M; R) = H_q(S^3; R)$, for all integers q . Similarly a *R -homology ball* is a 3-manifold B^M with boundary $\partial(B^M) = S^2$ such that $H_q(B^M; R) = H_q(B^3; R)$, for all q , where B^3 is the 3-ball. If $R = \mathbb{Z}$ we do not specify the ring and just write *homology sphere* or *homology ball*.

Let σ be a l -component string-link in a homology ball B^Σ with a fixed identification of $\partial(B^\Sigma)$ with $\partial(D^2 \times I)$ (ie. B^Σ is a homology cylinder over D^2) and let $N(P)$ be a regular

neighbourhood of the set of standard points and $N(\sigma)$ a regular neighbourhood of the string-link. Then there are two inclusion maps $i_j : D^2 - N(P) \hookrightarrow B^\Sigma - N(\sigma)$ for $j = 0, 1$, where the map i_j sends $D^2 - N(P)$ to the image of $D^2 \times \{j\} - N(P)$ under the identification of $\partial(B^\Sigma)$ with $\partial(D^2 \times I)$. We use the i_j to induce certain isomorphisms as follows.

Let G be any group. The *lower central series*, G_q is defined inductively by $G = G_1$ and $G_{q+1} = [G, G_q]$.

Stallings' Theorem ([45]). *Let $h : A \rightarrow B$ be a homomorphism of groups, inducing an isomorphism $H_1(A) \cong H_1(B)$ and an epimorphism from $H_2(A)$ onto $H_2(B)$. Then, for finite q , h induces an isomorphism $A/A_{q+1} \cong B/B_{q+1}$.*

A Mayer-Vietoris calculation and a standard application of Stallings' theorem gives the following result.

Proposition 1.1. *$(i_j)_*$, $j = 0, 1$, induces isomorphisms*

$$\frac{\pi_1((D^2 \times \{j\}) - N(P))}{\pi_1((D^2 \times \{j\}) - N(P))_{q+1}} \cong \frac{\pi_1(B^\Sigma - N(\sigma))}{\pi_1(B^\Sigma - N(\sigma))_{q+1}}.$$

Let $F(l)$ be the free group on generators x_1, \dots, x_l . We will also denote the image of x_i in the quotient group $F(l)/F(l)_{q+1}$ by x_i and the induced maps on the lower central series coming from proposition 1.1 by $(i_j)_*$, $j = 0, 1$. Since we can identify $\pi_1((D^2 \times \{j\}) - N(P))$ with $F(l)$, we have isomorphisms

$$\frac{F(l)}{F(l)_{q+1}} \xrightarrow{(i_0)_*} \frac{\pi_1(B^\Sigma - \sigma)}{\pi_1(B^\Sigma - \sigma)_{q+1}} \xleftarrow{(i_1)_*} \frac{F(l)}{F(l)_{q+1}},$$

and the composition $(i_1)_*^{-1}(i_0)_*$ gives a map $SL(l) \rightarrow \text{Aut}(F(l)/F(l)_{q+1})$, where $SL(l)$ is the set of string-links of l components in a given homology ball B^Σ . It is not difficult to see that we in fact get a map

$$\text{Art}_q : SL(l) \rightarrow \text{Aut}_0(F(l)/F(l)_{q+1}),$$

where $\text{Aut}_0(F(l)/F(l)_{q+1})$ is the subgroup of $\text{Aut}(F(l)/F(l)_{q+1})$ consisting of all automorphisms which map x_i to a conjugate of itself and leaves the product $x_1 x_2 \cdots x_l$ of the generators fixed. We call the map Art_q the q -th *Artin representation*.

The i -th *longitude* $\lambda_i \in F(l)/F(l)_{q+1}$ of a string-link σ is defined in the following way. Take a double of the i -th component of the string-link. This determines an element in the fundamental group of the complement, under $(i_1)_*^{-1}$ this gives an element in $F(l)/F(l)_{q+1}$ which we call the longitude. We have

$$\text{Art}_q(\sigma)(x_i) = \lambda_i x_i \lambda_i^{-1},$$

where $\lambda_i \in F(l)/F(l)_{q+1}$ is the i -th longitude of σ .

Note that our longitudes are determined by the (black-board) framing and are not necessarily null-homologous. It is easy to modify the content of this chapter should we insist that the longitudes are null-homologous, or we could just use the zero framing.

Figure 1.2: The STU, AS and IHX relations.

Definition 1.2. We say that a string-link σ has *Milnor filtration* n , if all its longitudes are trivial in $\frac{F(l)}{F(l)_n}$.

Let $\mathcal{P}(l)$ be the ring of formal power series in non-commuting variables X_1, \dots, X_l . The *Magnus expansion* is the homomorphism

$$\mu : F(l) \rightarrow \mathcal{P}(l)$$

defined on the generators of the free group by $\mu(x_i) = 1 + X_i$.

Definition 1.3. The μ -invariants of a string-link σ in an integral homology ball are the coefficients of the monomials in the X_i of the Magnus expansion of the i -th longitude $\lambda_i \in \frac{F(l)}{F(l)_{q+1}}$. Explicitly, the μ -invariant of length $n + 1$ of λ_i is

$$\mu_{j_1, j_2, \dots, j_n; i} = \text{Coeff}(X_{j_1} X_{j_2} \cdots X_{j_n}, \mu(\lambda_i))$$

where $n \leq q$ and $\lambda_i \in \frac{F(l)}{F(l)_{q+1}}$.

It is well known that the longitudes λ_i of σ are trivial in $\frac{F(l)}{F(l)_n}$, that is λ_i is of Milnor filtration n , if and only if all μ -invariants of length $\leq n$ vanish.

1.4 The Algebras

The algebras we need are amalgamations of the usual algebras \mathcal{A} and \mathcal{B} from the theory of finite-type invariants (see [5, 6]).

Definition 1.4. Let X, Y be finite disjoint sets. Then $\mathcal{A}(\uparrow_X, Y)$ is the space of formal \mathbb{Q} -linear combinations of uni-trivalent graphs whose trivalent vertices are oriented and whose univalent vertices are either coloured by elements of a set Y or lie on the oriented coloured 1-manifold $(\cup_{x \in X} I_x)$, which is called the *skeleton*, modulo the STU, IHX and AS relations shown in figure 1.2.

Note that we allow trivalent graphs and the possibility that $Y = \emptyset$.

We denote the subspace of $\mathcal{A}(\uparrow_X, Y)$ such that every connected component has a univalent vertex and all univalent vertices lie on the skeleton by $\mathcal{A}(\uparrow_X)$ and the subspace $\mathcal{A}(\emptyset, Y)$ by $\mathcal{B}(Y)$.

$$D_{\{(a,b),(c,d)\}} \left(\begin{array}{c} \uparrow \quad \text{c} \quad \uparrow \\ | \quad \circ \quad | \\ \text{---} \quad \text{---} \quad \text{---} \\ | \quad \text{a} \quad | \\ \uparrow \end{array} \right) = \begin{array}{c} \uparrow \uparrow \quad \text{c} \quad \uparrow \\ | \quad \circ \quad | \\ \text{---} \quad \text{---} \quad \text{---} \\ | \quad \text{a b} \quad | \\ \uparrow \end{array} + \begin{array}{c} \uparrow \uparrow \quad \text{d} \quad \uparrow \\ | \quad \circ \quad | \\ \text{---} \quad \text{---} \quad \text{---} \\ | \quad \text{a b} \quad | \\ \uparrow \end{array} + \begin{array}{c} \uparrow \uparrow \quad \text{c} \quad \uparrow \\ | \quad \circ \quad | \\ \text{---} \quad \text{---} \quad \text{---} \\ | \quad \text{a b} \quad | \\ \uparrow \end{array} + \begin{array}{c} \uparrow \uparrow \quad \text{d} \quad \uparrow \\ | \quad \circ \quad | \\ \text{---} \quad \text{---} \quad \text{---} \\ | \quad \text{a b} \quad | \\ \uparrow \end{array}$$

Figure 1.5: An example of the map D_S .

linear extension of the operation which to each element $(a, b) \in S$ either, if a is a label of a skeleton component, gives the sum of all ways of lifting the vertices lying on the a -coloured component over the component and its b -coloured double and, if a is the colour of a univalent vertex, is the sum of all ways of substituting the colour a by b (see figure 1.5 for an example).

We will be interested in two particular quotients of $\mathcal{A}(\uparrow_X, Y)$ which were defined in [6] and [24] for the algebra \mathcal{A} .

Define $\mathcal{A}^t(\uparrow_X, Y)$ to be the quotient of $\mathcal{A}(\uparrow_X, Y)$ by the ideal generated by all relations which set non-simply connected uni-trivalent graphs equal to zero. The connected elements are called *trees*. We will denote the connected part (ie. the primitives) of $\mathcal{B}^t(Y)$ by $\mathcal{C}^t(Y)$.

Also define $\mathcal{A}^h(\uparrow_X, Y)$ to be the quotient of $\mathcal{A}^t(\uparrow_X, Y)$ by the ideal generated by all relations which set connected uni-trivalent graphs with more than one univalent vertex either lying on the same skeleton component or being labeled by the same colour, equal to zero. We call this quotient the *homotopy quotient*.

It follows from [6] that $\mathcal{A}^h(\uparrow_X, Y)$ is a quotient of $\mathcal{A}^t(\uparrow_X, Y)$ and χ descends to isomorphism on these algebras.

There is a well known map (see eg. [19, 24]) which relates trees to Lie algebras. Let $\text{Lie}(l) = \bigoplus_{n \geq 1} \text{Lie}_n(l)$, be the free \mathbb{Q} Lie algebra on l generators X_1, \dots, X_l . Also let $\mathcal{C}^t(Y, a)$ be the subspace of $\mathcal{C}^t(Y \cup \{a\})$ consisting of connected elements in which every uni-trivalent graph has exactly one univalent vertex coloured by some $a \notin Y$.

Fix a bijection between the colouring set Y and the generators X_1, \dots, X_l of the free Lie algebra, where $|Y| = l$. Then given some element $D \in \mathcal{C}_n^t(Y, a)$ label the edges ending in a Y -coloured univalent vertex with the corresponding generator of the Lie algebra. Now assign an element of the Lie algebra to each unlabelled edge according to the rule that whenever an unlabelled edge meets two edges labelled by X and X' in $\text{Lie}(l)$ (in the direction of the orientation) assign the commutator $[X, X']$ to that edge. This labels the edge coloured by a and we take this to be our element of $\text{Lie}_n(l)$. See figure 1.6 for an example. It is not hard to see that this gives an isomorphism from $\mathcal{C}_n^t(Y, a)$ to $\text{Lie}_n(l)$.

Finally, we define a map $j_y : \mathcal{C}_n^t(Y) \rightarrow \text{Lie}_n(l)$ for $y \in Y$ by summing over all of the ways replacing exactly one of the y -coloured vertices by some $a \notin Y$ and then using the above map to get an element in $\text{Lie}_n(l)$. An example is given in figure 1.7.

Before continuing we briefly review some relevant of the Kontsevich integral.

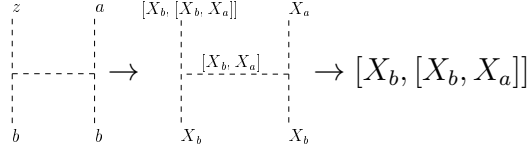

Figure 1.6: An example of the isomorphism $\mathcal{C}_3^t(\{a, b\}, z) \rightarrow \text{Lie}_3(2)$.

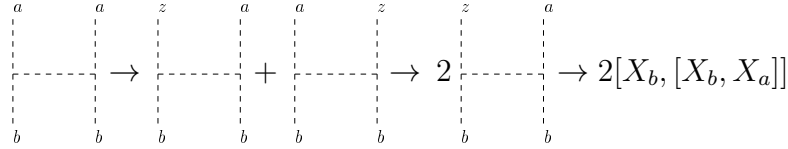

Figure 1.7: An example of $j_z : \mathcal{C}_3^t(\{a, b\}) \rightarrow \text{Lie}_3(2)$.

- For our purposes the Kontsevich integral Z is an $\mathcal{A}(\uparrow_X)$ valued universal finite-type invariant of X -coloured framed parenthesized tangles and the degree n part Z_n of Z is a degree n finite-type invariant.
- Let $\pi^h : \mathcal{A}(\uparrow_X) \rightarrow \mathcal{A}^h(\uparrow_X)$ be projection. Then by [6], $\pi^h \circ Z$ is a well defined invariant of (X -coloured framed parenthesized) string-links up to link-homotopy, where *link-homotopy* is an equivalence relation which allows ambient isotopy and each component of the tangle to pass through itself.
- Let T and T' be tangles then $Z(D_S(T)) = D_S(Z(T))$, $Z(\varepsilon_A(T)) = \varepsilon_A(Z(T))$ and $Z(T \cdot T') = Z(T) \cdot Z(T')$.
- $Z(T) \in \mathcal{A}(\uparrow_X)$ is group-like and so can be written as $\exp(C)$ where $C \in \mathcal{C}(X)$ is connected.

1.5 The Århus Integral

The Århus integral, Z^M , was introduced by Bar-Natan, Garoufalidis, Rozansky and Thurston in the series of papers [7, 8, 9] as a universal finite type invariant of rational homology 3-spheres. In this series it was remarked that it extends to an invariant of links in rational homology spheres. In this section we define Århus integral. The reader is referred to the Århus trilogy for a thorough exposition of the invariant.

The *pre-normalized Århus integral* of regular manifold string-links Z_0^M is defined by the following composition:

$$Z_0^M : RMSL \xrightarrow{\tilde{Z}} \mathcal{A}(\uparrow_{X_L \cup X_M}) \xrightarrow{\sigma_{X_M}} \mathcal{A}(\uparrow_{X_L}, X_M) \xrightarrow{\int_{X_M}^{FG}} \mathcal{A}(\uparrow_{X_L}, \emptyset)$$

where:

Figure 1.8: An example of the pairing $\langle D_1, D_2 \rangle_S$.

- $RMSL$ is the set of regular manifolds string-links with linking components coloured by X_L and surgery components coloured by X_M .
- $\check{Z} \stackrel{def}{=} \nu^{\otimes |X_L \cup X_M|} \cdot D_{\{-\} \times X_L \cup X_M}(\nu) \cdot Z$, is the Kontsevich integral as normalized in [33].
- $\int_{X_M}^{FG}$ is *formal Gaussian integration* with respect to the variables X_M . It is described below.

Definition 1.5. The *Århus integral* of a regular manifold string-link, σ_{LM} is given by

$$Z^M(\sigma_{LM}) = Z_0^M(U_+)^{-\sigma_+} \cdot Z_0^M(U_-)^{-\sigma_-} \cdot Z_0^M(\sigma_{LM})$$

where σ_{\pm} is the number of \pm ve eigenvalues of the linking matrix of $\varepsilon_{X_L}(\sigma_{LM})$ and U_{\pm} is the unknot with framing ± 1 .

We will now go on to define formal Gaussian integration. Let $D_1, D_2 \in \mathcal{A}(\uparrow_X, Y)$, define

$$\langle D_1, D_2 \rangle_Y = \left(\begin{array}{l} \text{sum of all ways of gluing all legs labeled} \\ y \text{ on } D_1 \text{ with all of the legs labeled } y \text{ on} \\ D_2, \text{ for all the colours } y \in Y. \end{array} \right),$$

where this sum is non-zero only if the number of y -coloured legs of D_1 equals the number of y -coloured legs of D_2 , for all $y \in Y$.

It is a well known and easily seen fact that for an X -coloured tangle T , the Kontsevich integral \check{Z} may be written in the form

$$\sigma(\check{Z}(T)) = \exp_{\cup} \left(\sum_{x, y \in X} \frac{1}{2} l_{xy} x \frown y \right) + (\text{other stuff}),$$

where (l_{xy}) is the linking matrix of T . Recall that the degree 1 elements (which look like \frown) are called *struts*.

Therefore, given a regular manifold string-link σ_{LM} , with linking components X_L and surgery components X_M , we can write

$$\sigma_{X_M} \check{Z}(\sigma_{LM}) = \exp_{\cup} \left(\sum_{x, y \in X_M} \frac{1}{2} l_{xy} x \frown y \right) \cdot P \stackrel{def}{=} \exp_{\cup}(Q/2) \cdot P,$$

where now (l_{xy}) is the linking matrix of $\varepsilon_{X_L}(\sigma_{LM})$. Since σ_{LM} is regular, (l_{xy}) is invertible and so we can define:

$$Q^{-1} = \sum_{x, y \in X_M} l^{xy} x \frown y$$

where (l^{xy}) is the inverse matrix of (l_{xy}) .

Writing $\sigma_{X_M} \check{Z}(\sigma_{LM}) \stackrel{def}{=} \exp_{\cup}(Q/2) \cdot P$, we define *formal Gaussian integration* as:

$$\int_{X_M}^{FG} \exp_{\cup}(Q/2) \cdot P = \langle \exp_{\cup}(-Q^{-1}/2), P \rangle_{X_M}.$$

It is known ([8]) that Z_0^M is invariant under isotopy and a handle slide of any component around a surgery component, and Z^M is invariant under stabilization on the surgery components and so Z^M is an invariant of string-links in a rational homology ball. Summarizing this we have:

Proposition 1.2. *The Århus integral Z^M is an invariant of framed parenthesized string-links in rational homology balls.*

At this point we fix some notation. Let $\pi^t : \mathcal{A}(\uparrow_X, Y) \rightarrow \mathcal{A}^t(\uparrow_X, Y)$ be projection. Then $Z^{M;t} \stackrel{def}{=} \pi^t \circ Z^M$, $\langle -, - \rangle_Y^t \stackrel{def}{=} \pi^t \circ \langle -, - \rangle_Y$ and so on. We use similar notation for the projection $\pi^h : \mathcal{A}(\uparrow_X, Y) \rightarrow \mathcal{A}^h(\uparrow_X, Y)$

1.6 The Århus Integral and the μ -invariants

Let σ_{LM} be a manifold string-link with the canonical parenthesization such that the determinant of the linking matrix of the surgery components is ± 1 (so σ_{LM} represents a string-link in an integral homology ball). Further, for convenience, we set $X_L = \{1, \dots, l\}$, $X_M = \{l+1, \dots, l+m\}$ and assume that the components of the manifold string-link have numerically increasing colours from left to right. We call such a manifold string-link *nice*.

At times we will need to add an extra linking component to the manifold string-link. We will add this component to the left of the others and colour it with 0. We denote the new colouring set $X_L \cup \{0\}$ by $X_L + 1$.

The extra 0-coloured component is going to correspond to a longitude of the string-link and as such is only considered up to link homotopy. Consequently, rather than working with the algebra $\mathcal{A}^t(\uparrow_{X_L+1}, \emptyset)$, we add an additional homotopy relation on the colour 0, and we call the resulting algebra $\mathcal{A}^{h,t}(\uparrow_{X_L+1}, \emptyset)$.

Given a set of colours X , let 1_X , be the trivial tangle of $|X|$ components coloured by X . When X contains only one element, x say, we will just write 1_x .

In this section we consider the longitudes as elements $\lambda_i = \varprojlim \lambda_i^{(n)}$ of the nilpotent completion $\widehat{F(l)} = \varprojlim F(l)/F(l)_{n+1}$, where $\lambda_i^{(n)} \in F(l)/F(l)_{n+1}$.

The reader is referred to [24] for the motivation behind the formula in the following lemma.

Proposition 1.3. *Let σ_{LM} be a nice manifold string-link and let λ_i , $1 \leq i \leq l$, be its i -th longitude regarded as a pure braid. Then*

$$Z^{M;h,t}(\lambda_i \otimes 1_{X_M}) = \pi^{h,t}(Z^M(1_0 \otimes \sigma_{LM})^{-1}(D_i Z^M(\sigma_{LM}))^{b_i}) \quad (1.1)$$

where $b_i = Z^M(\beta_i)$ and β_i is the braid coloured by $\{0, \dots, l+m\}$ inducing the permutation $(i-1 \ i-2 \ \dots \ 1 \ 0)$, a^b denotes the conjugation bab^{-1} , $D_i = D_{\{(i,0)\}}$ and $\pi^{h,t}$ is projection onto $\mathcal{A}^{h,t}(\uparrow_{X_{L+1}}, \emptyset)$.

Remark 1.1. In formula 1.1 we are assuming that σ_{LM} , $\lambda_i \otimes 1_{X_M}$ and $1_0 \otimes \sigma_{LM}$ have the canonical parenthesization and β_i has the canonical parenthesization on the bottom and the ‘ i -th double of the canonical parenthesization’ on the top.

Remark 1.2. Since $Z_0^{M;h,t} = Z^{M;h,t}$ we need only consider the pre-normalized Århus integral. Also note that $\check{Z}^t = Z^t$.

We need a few technical lemmas to prove the proposition.

Lemma 1.1. *Let σ_{LM} be a manifold string-link, $i \in X_L$ and $D_i = D_{\{(i,0)\}}$. Then*

$$Z^M(D_i(\sigma_{LM})) = D_i(Z^M(\sigma_{LM})).$$

Proof.

$$\begin{aligned} Z_0^M D_i(\sigma_{LM}) &= \int_{X_M}^{FG} \sigma_{X_M} \check{Z}(D_i(\sigma_{LM})) \\ &= \int_{X_M}^{FG} D_i(\sigma_{X_M}(\check{Z}(\sigma_{LM}))) \\ &= D_i \left(\int_{X_M}^{FG} \sigma_{X_M} \check{Z}(\sigma_{LM}) \right) \\ &= D_i(Z_0^M \sigma_{LM}) \end{aligned}$$

where the second equality is a standard property of the Kontsevich integral. The third follows since $i \in X_L$ and the formal Gaussian integration is with respect to the variables X_M .

The result follows since D_i respects multiplication. □

Lemma 1.2. *Let $P \in \mathcal{A}(\uparrow_X, Y)$ be of degree n and contain no struts both of whose univalent vertices are coloured by elements of Y , and let $Q \in \mathcal{A}(\uparrow_X, Y)$ consist entirely of struts coloured by Y . Then if $\langle Q, P \rangle_Y^t$ is non-zero, it is of degree at least $n - [\frac{n}{2}]$, where $[a]$ is the integer part of a .*

Proof. Assume that $\langle Q, P \rangle_Y^t$ is non-zero. We need to find the minimum possible degree of $\langle Q, P \rangle_Y^t$, where P and Q vary over all suitable elements of $\mathcal{A}(\uparrow_X, Y)$.

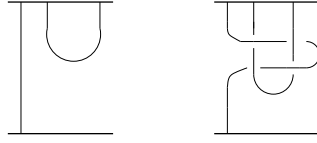

Figure 1.9: Two tangles which differ by a pure braid.

Suppose we are given elements P and Q so that the degree of $\langle Q, P \rangle_Y^t$ is minimal. We can assume that P is simply connected. If there are any trivalent vertices in P then we remove them by identifying two of the edges incident to the trivalent vertex giving a single edge and adding a X -coloured univalent vertex at the end of the third edge (note we use the hypothesis that P is a tree). As this does not change the degree of P or $\langle Q, P \rangle_Y^t$, we see we can assume that P consists entirely of struts.

Given such a P and remembering that the struts in P have at most one Y -coloured vertex, it is easy to see that the maximum number of Y -coloured struts which may be glued in is $\lfloor \frac{n}{2} \rfloor$, giving the result. \square

Note that if P and Q are as in the above lemma and if $\langle Q, P \rangle_Y$ is non-zero then it is of degree at least $n - \lfloor \frac{3n}{4} \rfloor$.

Definition 1.6. We say that two tangles T and T' differ by a pure braid $p \in PB_{n+1}$ if T' can be obtained from T by replacing a copy of $D^2 \times I$ which intersects T in a trivial string-link with the pure braid p (see figure 1.9).

We need the following result of Stanford.

Theorem 1.1 (Stanford [46]). *Let T and T' be two tangle which differ by a pure braid $p \in PB_{n+1}$. Then for any finite type invariant, v , of degree less than $n + 1$ we have $v(T) = v(T')$.*

Lemma 1.3. *Suppose Y is the disjoint union of compact 1-manifolds Y_0, Y_L, Y_M where Y_M consists entirely of copies of S^1 . Further suppose that $T_i, i = 1, 2$, are two tangles which agree on $Y_L \cup Y_M$ and on each component of Y_0 the maps differ by an element in the lower central series $\pi_1(M - T_i|_{Y_L})_{n+1}$, where M is the manifold obtained by surgery on $T_i|_{Y_M}$. Then the images of $Z_0^M(T_i)$ in $\mathcal{A}_{n - \lfloor \frac{n}{2} \rfloor - 1}^{h,t}(\uparrow_{Y_0 \cup Y_L}, \emptyset)$, where the homotopy filtration is on the Y_0 components, agree.*

Proof. First note that $\pi_1(D^2 \times I - T_i|_{Y_L \cup Y_M})$ is generated by the meridians of $T_i|_{Y_L \cup Y_M}$. This means that there exists a ball which intersects $T_i|_{Y_L \cup Y_M}$ in a trivial string-link such that the map of the fundamental groups induced by the inclusion of the trivial string-link into $T_i|_{Y_L \cup Y_M}$ is surjective.

Now since $\pi_1(M - T_i|_{Y_L})$ is also generated by the meridians of $T_i|_{Y_L \cup Y_M}$ and T_1 and T_2 differ by elements in $\pi_1(M - T_i|_{Y_L})_{n+1}$, we see that T_2 can be obtained from T_1 by

handle sliding around the Y_M components, modifying the Y_0 components by homotopy and modifying T_1 (inside the ball described above) by pure braids in $F(|Y_L \cup Y_M|)_{n+1} \subset F(|Y_L \cup Y_M|) \subset \text{PB}(|Y_L \cup Y_M| + 1)$.

Stanford's theorem tells us that the modification by the pure braids does not affect finite-type invariants of degree less than $n + 1$ and since the homotopy relations are applied to the Y_0 components so tangles differing under these two moves have the same image under $\check{Z}_{\leq n}^{h,t}$. Finally, formal Gaussian integration takes care of the handle slides and the result then follows by lemma 1.2. \square

Proof of proposition 1.3. Let $\lambda_i^{(n)}$ be a representative of the longitude λ_i in $F(l)/F(l)_{n+1}$ which we regard as a pure braid of $l + 1$ components. Now the two tangles $(1_0 \otimes \sigma_{LM})(\lambda_i^{(n)} \otimes 1_M)$ and $\beta_i D_i(\sigma_{LM}) \beta_i^{-1}$ both represent the union of the manifold string-link, σ_{LM} , and the longitude and therefore, by Stallings' theorem, satisfy the conditions of lemma 1.3. Then

$$Z_{<n-\lfloor \frac{n}{2} \rfloor}^{M;h,t}((\lambda_i^{(n)} \otimes 1_M) \cdot (1_0 \otimes \sigma_{LM})) = Z_{<n-\lfloor \frac{n}{2} \rfloor}^{M;h,t}(\beta_i \cdot D_i(\sigma_{LM}) \cdot \beta_i^{-1}).$$

Since $\lambda_i^{(n)} \in F(l)/F(l)_{n+1}$ it only shares crossings with the linking components of σ_{LM} , therefore

$$Z_{<n-\lfloor \frac{n}{2} \rfloor}^{M;h,t}((\lambda_i^{(n)} \otimes 1_M) \cdot (1_0 \otimes \sigma_{LM})) = Z_{<n-\lfloor \frac{n}{2} \rfloor}^{M;h,t}(\lambda_i^{(n)} \otimes 1_M) Z_{<n-\lfloor \frac{n}{2} \rfloor}^{M;h,t}(1_0 \otimes \sigma_{LM}).$$

Similarly,

$$Z_{<n-\lfloor \frac{n}{2} \rfloor}^{M;h,t}(\beta_i \cdot D_i(\sigma_{LM}) \cdot \beta_i^{-1}) = Z_{<n-\lfloor \frac{n}{2} \rfloor}^{M;h,t}(\beta_i) Z_{<n-\lfloor \frac{n}{2} \rfloor}^{M;h,t}(D_i(\sigma_{LM})) Z_{<n-\lfloor \frac{n}{2} \rfloor}^{M;h,t}(\beta_i^{-1}).$$

Finally solving for $Z_{<n-\lfloor \frac{n}{2} \rfloor}^{M;h,t}((\lambda_i^{(n)} \otimes 1_M))$, and letting n tend to infinity gives the result. \square

Having found a formula for the Århus integral of the longitudes we turn our attention to finding a formula for the Magnus expansion of the longitudes.

Definition 1.7. An *expansion* is a homomorphism $J : F(l) \rightarrow \mathcal{P}(l)$ such that $J(x_i) = 1 + X_i + (\text{higher order terms})$, where $F(l)$ is the free group on the generators x_1, \dots, x_l and $\mathcal{P}(l)$ is the ring of formal power series in non-commuting variables X_1, \dots, X_l .

Clearly the Magnus expansion is an expansion in this sense. We show that the left hand side of formula 1.1 can be regarded as an expansion and then we apply the following result of Lin to write the Magnus expansion of the longitudes in terms of the Århus integral.

Lemma 1.4 (Lin [34]). *Let J be any expansion and μ be the Magnus expansion. Then there exist a unique unipotent automorphism $\Psi : \mathcal{P}(l) \rightarrow \mathcal{P}(l)$ such that $\mu = \Psi \circ J$.*

Recall that a map Ψ is said to be *unipotent* if for all $a \in \mathcal{P}(l)$ of degree n , $\Psi(a) = a + O(n + 1)$.

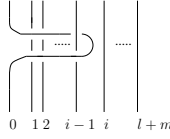

Figure 1.10: The pure braid $\sigma_{0,i} \otimes 1_M$.

$\mathcal{A}^{h,t}(\uparrow_{X_L+1})$ is a graded co-commutative Hopf algebra whose space of primitives is isomorphic to $\mathcal{C}^{h,t}(X_L + 1)$, the space of connected elements of $\mathcal{B}^{h,t}(X_L + 1)$. Let $X_i \in \mathcal{A}^{h,t}(\uparrow_{X_L+1})$ denote the element of degree 1 which has a single chord between the skeleton components coloured by 0 and i .

Then X_1, \dots, X_l generate a free non-commutative power series ring $\mathcal{P}(l) = \mathcal{P}(X_1, \dots, X_l) \subset \mathcal{A}^{h,t}(\uparrow_{X_L+1})$, (as the primitives of $\mathcal{A}^{h,t}(\uparrow_{X_L+1})$ are isomorphic to $\mathcal{C}^{h,t}(X_L + 1)$ and this is naturally decomposed as $\mathcal{C}^t(X_L, 0) \oplus \mathcal{C}^t(X_L) = \text{Lie}(l) \oplus \mathcal{C}^t(X_L)$ and the first summand corresponds to $\mathcal{P}(X_L)$ by the isomorphism described in section 1.4).

Let $SL(X_M)$ denote the monoid of string-links in $D^2 \times I$ which are coloured by X_M and $PB(l+1)$ be the pure braid group on $l+1$ generators. There is map $\iota : F(l) \rightarrow PB(l+1) \otimes SL(X_M)$ defined by the formula $x_i \mapsto \sigma_{0,i} \otimes 1_M$ where $\sigma_{0,i}$ is the generator of the pure braid group which wraps the 0-th strand once around the i -th as in figure 1.10. The composition of this with $Z^{M;h,t}$ gives a map $J : F(l) \rightarrow \mathcal{A}^{h,t}(\uparrow_{X_L+1}, \emptyset)$.

Lemma 1.5. *The map $J : F(l) \rightarrow \mathcal{A}^{h,t}(\uparrow_{X_L+1}, \emptyset)$ defined above is an expansion.*

Proof. Let $x_i \otimes 1_M$ denote the generators of $F(l) \otimes id \subset PB(l+1) \otimes SL(X_M)$. Then

$$Z^{M;h,t}(x_i) = i \circ \tilde{Z}^{h,t}(p_1(x_i)) = \exp(Y_i)$$

where $Y_i = X_i + O(2) \in \mathcal{A}^{h,t}(\uparrow_{X_L+1 \cup X_M})$, $i : \mathcal{A}^{h,t}(\uparrow_{X_L+1}) \rightarrow \mathcal{A}^{h,t}(\uparrow_{X_L+1 \cup X_M})$ is inclusion and $p_1 : PB(l+1) \otimes SL(X_M) \rightarrow PB(l+1)$ is projection onto the first component.

To prove the lemma we have to show that the image of J lies in $\mathcal{P}(l)$. But this follows since every diagram in $Z^{M;h,t}(x)$, where $x \in F(l) \otimes id$, must have a vertex lying on the skeleton component coloured 0 since the removal of the 0-coloured component trivializes the braid. Thus $Y_i \in \mathcal{C}^t(X_L, 0) = \text{Lie}(l)$. \square

Now applying Lemma 1.4 to Proposition 1.3 gives:

Theorem 1.2. *Let σ_{LM} be a nice manifold string-link. Then*

$$\mu(\lambda_i) = \Psi \circ \pi^{h,t}(Z^M(1_0 \otimes \sigma_{LM})^{-1}(D_i Z^M(\sigma_{LM}))^{b_i})$$

where $b_i = Z^M(\beta_i)$ and β_i is the braid coloured by $\{0, \dots, l+m\}$ inducing the permutation $(i-1 \ i-2 \ \dots \ 1 \ 0)$, a^b denotes the conjugation bab^{-1} , $D_i = D_{\{(i,0)\}}$, $\pi^{h,t}$ is projection onto $\mathcal{A}^{h,t}(\uparrow_{X_L+1}, \emptyset)$ and Ψ is a unipotent automorphism.

Remark 1.3. Habegger and Masbaum’s theorem in [24] relating the μ -invariants of string-links in $D^2 \times I$ to the Kontsevich integral (which is obviously contained in theorem 1.2) holds in the algebra $\mathcal{A}^{h(0)}(\uparrow_{X_{L+1}})$, which we define to be $\mathcal{A}(\uparrow_{X_{L+1}})$ with the homotopy relation applied to the colour 0, so there are no tree relations on the X_L -coloured components (this is true since [24]’s lemma 12.5 only requires the homotopy relation and in their lemma 12.6, the homotopy relation ensures that the appropriate elements are trees). However it is interesting to note that attempts by the author to remove the “ t ” in this section failed as the normalized Kontsevich integral \check{Z} does not respect multiplication, necessitating the descent into $\mathcal{A}^{h,t}(\uparrow_{X_{L+1}}, \emptyset)$.

1.7 The First Non-vanishing μ -invariant

In this section we give a generalization of the Habegger-Masbaum formula by expressing the first non-vanishing Milnor invariants in terms of the first non-vanishing term of the tree part of the Århus integral. This result also appeared in [22] with a different proof.

Recall that $\text{Lie}(l)$ is the free \mathbb{Q} Lie algebra on l generators X_1, \dots, X_l . There is a canonical graded isomorphism of $\bigoplus_{n \geq 1} (F(l)_n / F(l)_{n+1}) \otimes \mathbb{Q}$ with $\text{Lie}(l) = \bigoplus_{n \geq 1} \text{Lie}_n(l)$ (see [36]). Now if σ has Milnor filtration n , we can consider the longitudes λ_i as elements in $F(l)_n / F(l)_{n+1}$ and we denote the corresponding element in $\text{Lie}_n(l)$ by $\mu_i^{(n)}$. We call the $\mu_i^{(n)}$ the *Milnor invariants of degree n* .

Theorem 1.3. *Let σ_{LM} be a nice manifold string-link representing a string-link σ . Then*

- (i) $Z^{M;h,t}(\sigma_{LM}) = 1 + O(n)$ if and only if σ is of Milnor filtration n ,
- (ii) the first non-vanishing Milnor invariants of the string-link σ determine and are determined by the first non-vanishing term of $Z^{M;t}(\sigma_{LM}) - 1$ through the Habegger-Masbaum formula:

$$\mu_i^{(n)}(\sigma_{LM}) = j_i(\xi)$$

where $Z^{M;t}(\sigma_{LM}) = 1 + \xi + O(n+1)$ and $j_i : \mathcal{C}_n^t(X_L) \rightarrow \text{Lie}_n(X_L)$ is the map described in section 1.4.

Proof. (i) First suppose that $Z^{M;t}(\sigma_{LM}) = 1 + O(n)$, then $\pi^{h,t}(D_i(Z^M(\sigma_{LM}))) = 1 + O(n)$ giving $\pi^{h,t}((D_i(Z^M(\sigma_{LM})))^{b_i}) = 1 + O(n)$ (since the lower degree terms of the conjugating b_i ’s cancel).

Also we have $\pi^{h,t}(Z^M(1_0 \otimes \sigma_{LM})^{-1}) = 1 + O(n)$.

Since multiplication can not reduce the degree and Ψ is unipotent we have

$$\mu(\lambda_i) = \Psi \circ \pi^{h,t}(Z^M(1_0 \otimes \sigma_{LM})^{-1}(D_i(Z^M(\sigma_{LM})))^{b_i}) = 1 + O(n),$$

and the result follows since all μ -invariants of length $\leq n$ vanish if and only if λ_i is trivial in $\pi(B^\Sigma - \sigma) / \pi(B^\Sigma - \sigma)_n$, where σ is a tangle represented by σ_{LM} .

Conversely, suppose that λ_i is trivial in $\pi(B^\Sigma - \sigma)/\pi(B^\Sigma - \sigma)_n$. Then

$$\text{Coeff}(x_{l_1} x_{l_2} \cdots x_{l_{n-r-1}}, \mu(\lambda_i)) = 0, \quad \text{for } 0 \leq r \leq n-1,$$

and so

$$\mu(\lambda_i) = \Psi \circ \pi^{h,t}(Z^M(1_0 \otimes \sigma_{LM})^{-1}(D_i(Z^M(\sigma_{LM})))^{b_i}) = 1 + O(n).$$

As Ψ is unipotent it follows that

$$\pi^{h,t}(Z^M(1_0 \otimes \sigma_{LM})^{-1}(D_i(Z^M(\sigma_{LM})))^{b_i}) = 1 + O(n).$$

Thus $D_i(Z^{M;h,t}(\sigma_{LM})) = 1 + O(n)$ and so $Z^{M;t}(\sigma_{LM}) = 1 + O(n)$.

(ii) Suppose that the first non-vanishing μ -invariant is of degree n . Then by the above $Z^{M;h,t}(\sigma_{LM}) = 1 + \xi + O(n+1)$, where ξ is of degree n . By proposition 1.2, lemma 1.1 and the unipotency of Ψ we have

$$\mu(\lambda_i) = Z_{\leq n}^{M;h,t}(1_0 \otimes \sigma_{LM})^{-1} \cdot Z_{\leq n}^{M;h,t}(\beta_i) \cdot Z_{\leq n}^{M;h,t}(D_i(\sigma_{LM})) \cdot Z_{\leq n}^{M;h,t}(\beta_i)^{-1} + O(n+1).$$

Since $Z^M(\beta_i)$ can be written as the exponential of a sum of connected elements, this can be written as

$$\begin{aligned} &= (1 - 1_0 \otimes \xi)(1 + \zeta)(1 + \pi^{h,t}D_i(\xi))(1 - \zeta) + O(n+1) \\ &= 1 + \pi^{h,t}D_i(\xi) + O(n+1) \end{aligned}$$

where $\zeta = Z_n^{M;h,t}(\beta_i)$ and ξ is as in the statement of the theorem.

Looking at the degree n part of this formula we see that the terms of $D_i(\xi)$ which do not have a vertex on the 0-coloured skeleton component cancel with the terms of $1_0 \otimes \xi$, and any terms of $D_i(\xi)$ with more than one vertex on the 0-coloured skeleton component are killed off by the projection $\pi^{h,t}$. So what remains is an element of $\mathcal{C}_n^t(X_L, 0) = \text{Lie}_n(l)$ and it is easy to see that this is exactly the element $j_i(\xi)$.

Finally, the determined by part follows since j_i is injective (see [24]). \square

The struts of the Kontsevich integral of a link in S^3 determine and are determined by its linking numbers. Theorem 1.3 gives the analogous result for links in homology spheres.

Corollary 1.1. *The coefficients of the struts of the Aarhus integral of a link in a homology sphere determine and are determined by the linking numbers.*

Chapter 2

A Diagrammatic formula for the Free Energy

We state and prove a folklore result concerning the diagrammatic integration of exponentials.

2.1 Introduction

As we have already seen in chapter 1, the notions of diagrammatic or Feynman integration and diagrammatic differential operators play an important role in quantum topology, for example they are used to defining finite-type 3-manifold invariants from the Kontsevich integral ([7, 8, 9]) and certain vectorspace isomorphisms in the wheeling theorem ([10]).

In physics there is a folklore principle which says that the diagrammatic integration of the exponential of something connected is itself an exponential. We give an exact formulation of this statement. The resulting formula is a useful combinatorial identity which can be used to simplify calculations. In particular there are applications to the LMO invariant of 3-manifolds.

Although motivated by the theory of finite-type invariants, we find it convenient to work in a slightly more general setting in this chapter.

The version of the proof of theorem 2.1 presented here was suggested by Daan Kramer which greatly improved an earlier proof by the author.

Remark 2.1. We note that the author is currently collaborating with D.M.Jackson and A. Morales to give a more classical combinatorial exposition of the diagrammatic integration discussed here and in chapter 1.

2.2 Statement of Results

Let $\mathcal{D}(Y)$ be the algebra of formal power series of uni-trivalent graphs with coefficients in \mathbb{Q} , whose uni-valent vertices are coloured by some set Y and trivalent vertices are oriented and

$$\left\langle \frac{1}{2} \text{---} \circ \text{---} + \text{---} \circ \text{---} \begin{array}{c} \text{---} \text{---} \\ \text{---} \text{---} \end{array} \right\rangle = \frac{1}{2} \text{---} \text{---} \text{---} \text{---} + \text{---} \text{---} \text{---} + 2 \text{---} \text{---} \text{---} \text{---} + \text{---} \text{---} \text{---} \text{---}$$

$$\left\langle \frac{1}{2} \text{---} \circ \text{---} + \text{---} \circ \text{---} \begin{array}{c} \text{---} \text{---} \\ \text{---} \text{---} \end{array} \right\rangle_c = \text{---} \text{---} + 2 \text{---} \text{---} \text{---}$$

Figure 2.1: Examples of definition 2.1.

where commutative multiplication is given by disjoint union. Note that we allow the empty graph \emptyset . We also allow $Y = \emptyset$, in which case the formal power series in $\mathcal{D}(\emptyset)$ contain only trivalent graphs.

Recall, an element of $\mathcal{D}(Y)$ is called connected if all of its summands consist of connected graphs.

We say that $D \in \mathcal{D}(Y)$ is *Y-substantial* if it contains no struts (graphs which look like \frown). We will denote the subalgebra of *Y-substantial* elements of $\mathcal{D}(Y)$ by $\mathcal{D}_s(Y)$.

Definition 2.1. Let $D \in \mathcal{D}_s(Y)$ be *Y-substantial*. $\langle D \rangle$ is defined to be the linear operation given by

$$\langle D \rangle = \left(\begin{array}{l} \text{sum of all ways of identifying pairwise} \\ \text{all of the } y \text{ coloured uni-valent vertices} \\ \text{of } D \text{ for all } y \in Y \end{array} \right).$$

This sum is declared to be zero if D has an odd number of y -coloured vertices for any $y \in Y$. Further, define $\langle D \rangle_c$ to be the connected part of $\langle D \rangle$. See figure 2.1 for examples of these definitions.

Remark 2.2. If we work with the algebra $\mathcal{B}(Y)$ from the theory of finite-type invariants (see section 1.4 or [5]), restrict ourselves to those elements with exactly $2m$ legs of each colour and project the result of $\langle - \rangle$ onto the quotient of $\mathcal{B}(Y)$ by the ideal generated by the relations O_m and P_{m+1} defined in [32], then the above definition is *negative dimensional integration*, $\int^{(m)}$, defined in [9] to give a construction of the LMO invariant - a universal perturbative invariant of rational homology spheres.

The relationship stated in the following theorem was conjectured independently by the author and Stavros Garoufalidis. The proof of the theorem is given in section 2.3.

Theorem 2.1. *Let $C \in \mathcal{D}_s(Y)$ be *Y-substantial* and contain only connected graphs. Then*

$$\langle \exp(C) \rangle = \exp \left(\sum_{j=1}^{\infty} \frac{1}{j!} \langle C^j \rangle_c \right). \quad (2.1)$$

Of course $\langle - \rangle$ is not the only type of diagrammatic integration in the literature and so it is natural to ask which of them satisfy equations analogous to equation 2.1.

There is a well known bilinear pairing $\langle -, - \rangle : \mathcal{D}(Y) \otimes \mathcal{D}(Y) \rightarrow \mathcal{D}(\emptyset)$, where $\langle D_1, D_2 \rangle$ is defined to be the sum of all ways of gluing all of the y -coloured vertices of D_1 to all of the

y -coloured vertices of D_2 for every $y \in Y$, where this sum is zero if the number of y -coloured vertices of D_1 and D_2 do not match. See also section 1.5. We also define $\langle -, - \rangle_c$ to be the connected part of $\langle -, - \rangle$.

For motivation we give two important examples of uses of this definition. The first example is $\langle D \rangle = \langle \exp(\sum_{y \in Y} \frac{1}{2} (y \frown y)), D \rangle$ which relates our present discussion to our earlier discussion and to the LMO invariant.

Our second important example is essentially the gluing from formal Gaussian integration (defined in section 1.5) which is of the form

$$\left\langle \exp \left(\sum_{1 \leq i \leq j \leq n} a_{i,j} y_i \frown y_j \right), D \right\rangle,$$

where D is Y -substantial.

The following generalizes theorem 2.1. Again we delay the proof until section 2.3.

Theorem 2.2. *Let $Y = \{y_1, \dots, y_n\}$, $C \in \mathcal{D}_s(Y)$ be Y -substantial and connected and $a_{i,j} \in \mathbb{Q}$. Then the following identity holds*

$$\begin{aligned} & \left\langle \exp \left(\sum_{1 \leq i \leq j \leq n} a_{i,j} y_i \frown y_j \right), \exp(C) \right\rangle \\ &= \exp \left(\sum_{p=1}^{\infty} \frac{1}{p!} \left\langle \exp \left(\sum_{1 \leq i \leq j \leq n} a_{i,j} y_i \frown y_j \right), C^p \right\rangle_c \right). \end{aligned} \quad (2.2)$$

So far we have only discussed the free algebra $\mathcal{D}(Y)$. However as we are usually interested in a quotient of $\mathcal{D}(Y)$ by some ideal we observe the following corollary, which relates the theorems presented here to the theory of finite type invariants.

Corollary 2.1. *Let $\mathcal{B}(Y)$ be the algebra of formal power series of uni-trivalent graphs with oriented trivalent vertices and univalent vertices coloured by Y , modulo the **IHX** and **AS** relations (see figure 1.2 for their definitions). Let $C \in \mathcal{B}(Y)$ contain only connected graphs and be Y -substantial. Then equation 2.2 holds in this quotient algebra.*

2.3 The Proofs

For motivation, consider the calculation of some value $\langle C \rangle$. One approach is to sum over all of the ways of breaking the computation down into the construction of connected components, for example

$$\begin{aligned} \langle -\circ^2 -\circ-\circ \rangle &= \langle -\circ^2 -\circ-\circ \rangle_c + \langle -\circ^2 \rangle_c \langle -\circ-\circ \rangle_c + 2 \langle -\circ -\circ-\circ \rangle_c \langle -\circ \rangle_c \\ &\quad + \langle -\circ \rangle_c \langle -\circ \rangle_c \langle -\circ-\circ \rangle_c. \end{aligned}$$

Splitting the calculation like this is the idea behind the proof of theorem 2.1.

More precisely the idea of the proof is to rewrite $\langle \exp(C) \rangle$ in terms of $\langle - \rangle_c$ as indicated above, and after some rearranging of the indexing, the result drops out. The first problem encountered is how to enumerate this sum. We taken care of this first.

Lemma 2.1. *Let C_i be a connected element of $\mathcal{D}_s(Y)$ for each $i \in I$, where I is an index. Then*

$$\left\langle \prod_{i \in I} C_i^{h(i)} \right\rangle = \sum_{m=1}^{\infty} \sum_{\substack{\{g_j: I \rightarrow \mathbb{N}_0\} \\ \sum_j g_j = h, \\ g_j \neq 0, \\ 1 \leq j \leq m}} \frac{1}{m!} \prod_{i \in I} \frac{h(i)!}{\prod_{j=1}^m g_j(i)!} \left\langle \prod_{i \in I} C_i^{g_j(i)} \right\rangle_c,$$

where $h : I \rightarrow \mathbb{N}_0$ is a map such that only finitely many of the $h(i)$ are non-zero.

We introduce some notation for the proof. Let $C = \prod_{i \in I} C_i^{g(i)}$ be an element of $\mathcal{D}(Y)$ such that each C_i is connected. By a *pattern of order m* of C we mean a way of partitioning C into $\prod_{j=1}^m \langle \prod_{i \in I} C_i^{h(i,j)} \rangle_c$, where $\sum_{j=1}^m h(i,j) = g(i)$ for each i . Note there is no ordering of the C_i or the $\langle - \rangle_c$. For example, with C as in the above example, $\langle -\circ-\circ-\circ \rangle_c \langle -\circ \rangle_c$ and $\langle -\circ \rangle_c \langle -\circ \rangle_c \langle -\circ-\circ \rangle_c$ are patterns of order 2 and 3 respectively.

We now prove the lemma.

Proof. Clearly

$$\sum_{\substack{\{g_j: I \rightarrow \mathbb{N}_0\} \\ \sum_j g_j = h, \\ g_j \neq 0, \\ 1 \leq j \leq m}} \left\langle \prod_{i \in I} C_i^{g_j(i)} \right\rangle_c \tag{2.3}$$

enumerates all patterns of order m . It remains to add coefficients to count the correct number of occurrences of each pattern to equation 2.3 which, after summing over all values of m , will give the equation in the lemma.

As each pattern in equation 2.3 occurs with a multiplicity of $m!$ (as the sum orders the product of $\langle - \rangle_c$ in the pattern) we need to divide each summand by $m!$ to give exactly one occurrence of each pattern. The lemma then follows upon noting that there are

$$\prod_{i \in I} \binom{h(i)}{g_1(i), \dots, g_m(i)} = \prod_{i \in I} \frac{h(i)!}{\prod_{j=1}^m g_j(i)!}$$

ways of making the pattern $\left\langle \prod_{i \in I} C_i^{g_j(i)} \right\rangle_c$ from $\prod_{i \in I} C_i^{h(i)}$. □

Proof of theorem 2.1. We begin by writing C as $\sum_{i \in I} C_i$, where each C_i is a connected element of $\mathcal{D}_s(Y)$ and I is an indexing set. This gives

$$\langle \exp(C) \rangle = \left\langle \prod_{i \in I} \exp(C_i) \right\rangle = \left\langle \prod_{i \in I} \sum_{n=1}^{\infty} \frac{C_i^n}{n!} \right\rangle.$$

This can be written as a sum over functions in the following way:

$$\left\langle \sum_{h:I \rightarrow \mathbb{N}_0} \prod_{i \in I} \frac{C_i^{h(i)}}{h(i)!} \right\rangle = \sum_{h:I \rightarrow \mathbb{N}_0} \left\langle \prod_{i \in I} \frac{C_i^{h(i)}}{h(i)!} \right\rangle.$$

Now, using lemma 2.1, we can split the calculation of $\langle - \rangle$ into a sum of products of $\langle - \rangle_c$, giving

$$1 + \sum_{h:I \rightarrow \mathbb{N}_0} \sum_{m=1}^{\infty} \frac{1}{m!} \sum_{\substack{\{g_j:I \rightarrow \mathbb{N}_0\} \\ \sum_j g_j = h, \\ g_j \neq 0, \\ 1 \leq j \leq m}} \left(\prod_{i \in I} \frac{1}{h(i)! \prod_{j=1}^m g_j(i)!} \right) \prod_{j=1}^m \left\langle \prod_{i \in I} C_i^{g_j(i)} \right\rangle_c.$$

We may incorporate the sum over the functions h into the sum over the g_j to write this as

$$1 + \sum_{m=1}^{\infty} \frac{1}{m!} \sum_{\substack{\{g_j:I \rightarrow \mathbb{N}_0\} \\ g_j \neq 0, \\ 1 \leq j \leq m}} \prod_{j=1}^m \left\langle \prod_{i \in I} \frac{C_i^{g_j(i)}}{g_j(i)!} \right\rangle_c,$$

which with a little thought, can be seen to be equal to

$$1 + \sum_{m=1}^{\infty} \frac{1}{m!} \prod_{j=1}^m \left(\sum_{\substack{g_j:I \rightarrow \mathbb{N}_0, \\ g_j \neq 0}} \left\langle \prod_{i \in I} \frac{C_i^{g_j(i)}}{g_j(i)!} \right\rangle_c \right),$$

where the sum is now over g_j for a fixed j . Clearly this may be written as

$$\begin{aligned} & \sum_{m=0}^{\infty} \frac{1}{m!} \left(\sum_{\substack{g:I \rightarrow \mathbb{N}_0, \\ g \neq 0}} \left\langle \prod_{i \in I} \frac{C_i^{g(i)}}{g(i)!} \right\rangle_c \right)^m \\ & = \exp \left(\sum_{\substack{g:I \rightarrow \mathbb{N}_0, \\ g \neq 0}} \left\langle \prod_{i \in I} \frac{C_i^{g(i)}}{g(i)!} \right\rangle_c \right) \end{aligned}$$

It remains to show that

$$\sum_{\substack{g:I \rightarrow \mathbb{N}_0, \\ g \neq 0}} \left\langle \prod_{i \in I} \frac{C_i^{g(i)}}{g(i)!} \right\rangle_c = \sum_{j=1}^{\infty} \frac{1}{j!} \left\langle C^j \right\rangle_c$$

but this follows as one may write the right hand side as

$$\sum_{j=1}^{\infty} \frac{1}{j!} \sum_{\substack{g:I \rightarrow \mathbb{N}_0, \\ \sum_{i \in I} g(i) = j}} \frac{j!}{\prod_{i \in I} g(i)!} \left\langle \prod_{i \in I} C_i^{g(i)} \right\rangle_c,$$

which is obviously equal to the left hand side. □

Since the proof of theorem 2.2 is similar to that of theorem 2.1 we only sketch it. The only real difference is that in a calculation of $\langle S, C \rangle$ in terms of $\langle -, - \rangle_c$, we look at all the splittings of both S and C , for example

$$\begin{aligned} \langle \curvearrowright^3, -\circ^2 -\circ-\circ \rangle &= \langle \curvearrowright^3, -\circ^2 -\circ-\circ \rangle_c + \langle \curvearrowright^2, -\circ^2 \rangle_c \langle \curvearrowright, -\circ-\circ \rangle_c \\ &\quad + \langle \curvearrowright, -\circ^2 \rangle_c \langle \curvearrowright^2, -\circ-\circ \rangle_c + \cdots + \langle \curvearrowright, -\circ \rangle_c \langle \curvearrowright, -\circ \rangle_c \langle \curvearrowright, -\circ-\circ \rangle_c. \end{aligned}$$

In fact the proof presented below is essentially a double application (to the struts and to C) of the proof of theorem 2.1.

Sketch of the proof of theorem 2.2. As before we write C as $\sum_{i \in I} C_i$ where each C_i is a connected element of $\mathcal{D}_s(Y)$ and I is an indexing set. Also write the strut part as $\sum_{k \in K} S_k$, for some index K . Then

$$\left\langle \exp\left(\sum_{k \in K} S_k\right), \exp(C) \right\rangle = \left\langle \prod_{k \in K} \sum_{m=1}^{\infty} \frac{S_k^m}{m!}, \prod_{i \in I} \sum_{n=1}^{\infty} \frac{C_i^n}{n!} \right\rangle.$$

As before this can be written as a sum over functions:

$$\sum_{h: I \rightarrow \mathbb{N}_0} \sum_{\alpha: K \rightarrow \mathbb{N}_0} \left\langle \prod_{k \in K} \frac{S_k^{\alpha(k)}}{\alpha(k)!}, \prod_{i \in I} \frac{C_i^{h(i)}}{h(i)!} \right\rangle.$$

By using an argument similar to that of the proof of lemma 2.1, we write this as

$$\begin{aligned} &1 + \sum_{h: I \rightarrow \mathbb{N}_0} \sum_{m=1}^{\infty} \frac{1}{m!} \sum_{\substack{\{g_j: I \rightarrow \mathbb{N}_0\} \\ \sum_j g_j = h, \\ g_j \neq 0, \\ 1 \leq j \leq m}} \left(\prod_{i \in I} \frac{1}{h(i)!} \frac{h(i)!}{\prod_{j=1}^m g_j(i)!} \right) \\ &\quad \sum_{\alpha: I \rightarrow \mathbb{N}_0} \sum_{n=1}^{\infty} \frac{1}{n!} \sum_{\substack{\{f_l: K \rightarrow \mathbb{N}_0\} \\ \sum_l f_l = \alpha, \\ f_l \neq 0, \\ 1 \leq l \leq n}} \left(\prod_{k \in K} \frac{1}{\alpha(k)!} \frac{\alpha(k)!}{\prod_{l=1}^n f_l(k)!} \right) \\ &\quad \prod_{j=1}^m \prod_{l=1}^n \left\langle \prod_{k \in K} S_k^{f_l(k)}, \prod_{i \in I} C_i^{g_j(i)} \right\rangle_c \\ &= 1 + \sum_{h: I \rightarrow \mathbb{N}_0} \sum_{m=1}^{\infty} \frac{1}{m!} \sum_{\substack{\{g_j: I \rightarrow \mathbb{N}_0\} \\ \sum_j g_j = h, \\ g_j \neq 0, \\ 1 \leq j \leq m}} \left(\prod_{i \in I} \frac{1}{h(i)!} \frac{h(i)!}{\prod_{j=1}^m g_j(i)!} \right) \\ &\quad \prod_{j=1}^m \left\langle \exp\left(\sum_{k \in K} S_k\right), \prod_{i \in I} C_i^{g_j(i)} \right\rangle_c \end{aligned}$$

$$= \exp \left(\sum_{p=1}^{\infty} \frac{1}{p!} \left\langle \exp \left(\sum_{k \in K} S_k \right), C^p \right\rangle_c \right),$$

using similar indexing arguments to those above. □

Remark 2.3. An earlier proof of theorem 2.2 gave a partial converse to the theorem, however as it has been superseded by results to appear in [25], we do not include it.

Chapter 3

On the Word and Conjugacy Problems for Link Groups

In this chapter we study the relationship between known solutions from small cancellation theory and normal surface theory for the word and conjugacy problems of the groups of (prime) alternating links. We show that two of the algorithms in the literature for solving the word problem, each using one of the two approaches, are the same. Then, by considering small cancellation methods, we give a normal surface solution to the conjugacy problem of these link groups and characterize the conjugacy classes. Finally, by using the small cancellation properties of link groups we provide a new proof that alternating links are non-trivial.

3.1 Introduction

The word problem for the fundamental group of a link complement was first solved by Waldhausen in [47], who found an algorithm for deciding whether a loop in a sufficiently large irreducible 3-manifold is contractible. Waldhausen's algorithm is difficult to apply. It relies on Haken's theory of normal surfaces to find a particular set of surfaces in the 3-manifold. Dugopolski, in [16], showed that for the complement of an alternating link, such a set of surfaces is readily available and he simplified Waldhausen's solution of the word problem for such links. These algorithms are geometric.

On the other hand, using combinatorial group theory, Weinbaum, in [48], proved that the groups of prime alternating knots satisfy the $C''(4) - T(4)$ small cancellation conditions, and applied results of Lyndon, to solve the word problem, and Schupp, to solve the conjugacy problem. This was extended to all alternating knots by Appel and Schupp in [2] (see also [35]) by showing these groups satisfy the $C''(4) - T(4)$ for minimal sequences conditions. In fact these methods apply to a larger set of (not necessarily alternating) links.

At around the same time Appel, [1], used the Wirtinger presentation and small cancel-

lation techniques to solve the conjugacy problem for all alternating and some non-alternating knots.

An improvement for solving the word problem for $C''(4) - T(4)$ groups and hence the groups of prime alternating links, to a quadratic time algorithm, appears implicitly in later work by Appel and Schupp ([3]), and explicitly in several other places ([20, 26, 28, 29]). We consider this algorithm.

Other approaches have also been successful. Epstein and Thurston in [17] showed that all link groups are automatic (Gersten and Short also showed that the groups of alternating knots are automatic using different methods in [21]) and hence have a solvable word problem. In fact the conjugacy problem for link groups is solvable in full generality since the link complement is a CAT(0) space.

Returning to small cancellation methods, Johnsgard gave a polynomial time algorithm for solving the conjugacy problem for prime alternating link groups in [27].

In this chapter we show that the Dugopolski's solution of the word problem, which uses the theory of normal surfaces, and the algorithm which comes from the characterization of geodesics in $C''(4) - T(4)$ small cancellation groups, are the same for prime alternating links.

More specifically, we see that, expressed in terms of $C''(4) - T(4)$ groups, the two algorithms differ only in the way that they search for subwords to freely reduce and carry out chain collapses (a particular type of substitution), also Dugopolski's algorithm will cyclically permute the word, while the other algorithm does not. These differences are inconsequential. In terms of the language of Dugopolski, the algorithm from group theory carries out type 1 reductions and type 2 deformations with respect to both the white and black checker-board hierarchy, while keeping one point of the loop fixed, while Dugopolski's carries out the moves with respect to one hierarchy only and does not fix a point.

We go on to use the correspondences developed in proving this to give a normal surfaces algorithm for solving the conjugacy problem for prime alternating links. This is important since normal surface theory has not been particularly successful in solving the conjugacy problem, although Evans ([18]) used the theory to solve the conjugacy problem for loops in the boundary of a compact sufficiently large 3-manifold. This also provides a geometric characterization of the conjugacy classes of a given loop in the link complement. We also give a characterization of the classes of contractible loops using these moves.

A secondary purpose of this chapter is to provide a readable account of the methods and algorithms used herein. We discuss in detail the processes needed to apply Dugopolski's algorithm, which was not discussed in his paper and we also give a short proof of the planarity of Johnsgard's conjugacy algorithm in the difficult case (which is needed to prove that it is polynomial time).

Finally we use the small cancellation properties of link groups to give a new proof of the non-triviality of alternating links.

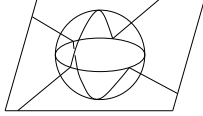

Figure 3.1: A crossing ball.

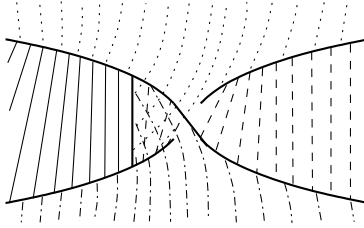

Figure 3.2: Regions of a link.

Remark 3.1. Although we will mostly talk about prime links, one should remember that the word and conjugacy problem for the free product of two groups reduces to that of its factors, so we obtain solutions for the split unions of the links. Also note that the free product of $C''(4) - T(4)$ groups is again $C''(4) - T(4)$ and so the small cancellation results also hold for split unions.

3.2 Definitions

Let $L \subset \mathbb{R}^3 \cup \infty = S^3$ be a link. Without loss of generality we may assume that L lies on $\mathbb{R}^2 \cup \infty$ except in a neighborhood of a crossing where the arcs lie on the boundary of a 3-ball, which we call a *crossing ball*, forming semicircular over and under crossing arcs which intersect the north and south poles. This is indicated in figure 3.1. For convenience we will always assume that our links are of this form.

There is a *canonical projection* associated with every such link, given by vertical projection onto $\mathbb{R}^2 \cup \infty$ inside the crossing balls. Similarly we can associate a link to every projection by adding crossing balls at each crossing.

Since we can move canonically between a link and a projection, we will abuse notation and say that a link has some property when its canonical projection does.

We can use the regions of the canonical projection to induce a set of surfaces in the link complement. These are the 2-cells which coincide with the regions of the projection outside of the crossing balls and a strip with a $\pi/2$ twist inside the crossing balls whose boundary is identified with the arc given by the intersection of the crossing ball and the region of the projection the region, the two arcs from the equator to the poles and the north-south axis of the crossing balls, shown locally in figure 3.2. We call these 2-cells the *regions* of the link.

The *Dehn presentation* of $\pi_1(S^3 - L)$ is defined as follows: Take a regular projection of L onto $\mathbb{R}^2 \cup \infty$ and label the regions x_0, x_1, \dots, x_n (note that this induces a labeling of

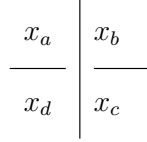

Figure 3.3: Relators for the presentation.

the regions of the link). These will be the names of our generators. By convention we label the region containing infinity x_0 , and call this the *outer region*. To each crossing we assign a relator $x_a x_b^{-1} x_c x_d^{-1}$ according to figure 3.2 and add one extra relator x_0 . The presentation obtained after we kill off the generator x_0 using Titze transformations is called the *Dehn presentation* of L .

A geometric interpretation of this presentation of the fundamental group follows by choosing a base point above $\mathbb{R}^2 \cup \infty$ and to each region x_i of the link, assign a loop which descends from the base point through the region x_i and returns through x_0 .

We say that a set of relators is *symmetrized* if it is cyclically reduced and closed with respect to inverses and cyclic permutations. A symmetrized presentation can be obtained from any presentation by adjoining the cyclic permutations of the set of relators and their inverses. Clearly this does not change the group.

We denote the unknot by \mathcal{O} . The *augmented link* of L is the link corresponding to the projection of $L \cup \mathcal{O}$ such that the projection of L shares no edges with the outer region (so the projection of L is “inside” the projection of \mathcal{O}).

By convention we label the region which is bounded by the unknot component and contains the projection of L (so not the outer region) x_0 .

Now define the *augmented Dehn presentation* of L to be the symmetrized Dehn presentation of the augmented link.

The augmented Dehn presentation is obtained from the construction of the Dehn presentation by failing to add the relator x_0 and then symmetrizing. It is the free product of the Dehn presentation of L and the infinite cyclic group. Therefore, solving the conjugacy (and word) problem for the augmented link group solves it for the link group.

The inclusion $i : S^3 - L \hookrightarrow S^3 - (L \cup \mathcal{O})$, induces the homomorphism $i_* : x_i \mapsto x_i x_0^{-1}$ from the Dehn presentation to the augmented Dehn presentation. We will call a word which lies in the image of the Dehn presentation under this induced homomorphism an *included word* in the augmented Dehn presentation.

If a presentation has all relators of equal length and we can assign a parity to each generator and its inverse $x_i^{\pm 1}$ such that the letters of each relator alternate in parity, we say that the presentation has *parity*.

Recall that the *checker-board colouring* of a link projection is the assignment of the colour black or white to each of the regions in such a way that at each crossing, adjacent regions have a different colour. By convention we assume that the outer region is coloured

white. It is not hard to see that the checker-board colouring induces a parity on the presentation.

3.3 Small Cancellation Theory and the Word Problem

We begin by reviewing some basic constructions from group theory. One can associate a *standard 2-complex* K to a group presentation $G = \langle X|R \rangle$ in the usual way: K consists of one 0-cell, one labelled 1-cell for each generator and one 2-cell for each relator, where the 2-cell D_r representing the relator $r \in R$ is attached to the 1-skeleton, $K^{(1)}$, by a continuous map which identifies ∂D_r with a loop representing r in the 1-skeleton.

A word $w \in F(X)$ represents the identity in G if and only if there is a connected simply connected planar 2-complex D and a map $\phi : (D, \partial D) \rightarrow (K, K^{(1)})$ such that the 0-cells are mapped to 0-cells, open i -cells are mapped to open i -cells, for $i = 1, 2$ and ∂D is mapped to the loop representing w . We call such a 2-complex, labelled in the natural way, a *singular disc diagram* (or *Dehn diagram* or *Van Kampen diagram*). If D contains no cut vertices (those whose removal disconnects D) then we call D a *disc diagram*.

We say a singular disc diagram is *reduced* if there are no 2-cells R_1 and R_2 with a common edge e such that reading the labels on their boundaries from edge e clockwise on R_1 and anticlockwise on R_2 give the same word. It is easy to see how to remove two such 2-cells without changing the boundary word. We assume that all singular disc diagrams are reduced.

A *piecewise Euclidean (PE) complex* is a combinatorial 2-complex where each 2-cell is equipped with the metric of a convex polygon in the Euclidean plane in such a way that all the metrics agree on edges common to the boundaries of more than one 2-cell.

Unless otherwise stated, in this chapter we give all of the 2-complexes a PE structure by regarding the 2-cells as regular polygons of side 1 where the number of sides of the polygon is determined by the length of the word labelling the boundary. Note that since we never consider presentations with relators of length 2 we can do this.

Let $G = \langle X|R \rangle$ be a group presentation. We call a non-empty word r a *piece with respect to R* if there exist distinct words $s, t \in R$ such that $s = ru$ and $t = rv$ and R is symmetrized. Furthermore, we say that a symmetrized presentation is $C''(4) - T(4)$ if it satisfies the following two small cancellation conditions:

Condition $C''(4)$. *All relators have length four and no defining relator is a product of fewer than four pieces.*

Condition $T(4)$. *Let r_1, r_2 and r_3 be any three defining relators such that no two of the words are inverses to each other, then one of r_1r_2 , r_2r_3 or r_3r_1 is freely reduced without cancellation.*

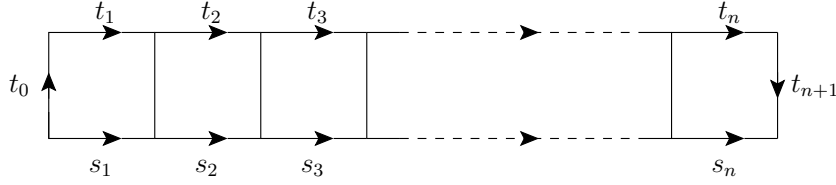

Figure 3.4: A chain.

In this chapter we are mostly concerned with $C'''(4) - T(4)$ small cancellation groups and so we usually consider *square complexes*, that is PE 2-complexes where the 2-cells are regarded as solid Euclidean squares.

We call a (PE) disc diagram whose boundary is labelled by a relator of length 4 a *relator square*. We observe that rotating a relator square by $\pi/2$ gives a cyclic permutation of the relator and flipping the square corresponds to taking the inverse of the relator. Also note that if we are tiling with relator squares and we have a right angle with labelled edge traversals then, by $C'''(4)$, at most one relator square exists which can fill this angle.

We call a two letter subword of a relator a *pair*. The $C'''(4)$ condition says that a pair determines a relator square uniquely up to cyclic permutation and $T(4)$ says that if ab and $b^{-1}c$ are pairs then ac is not. It follows that in a $C'''(4) - T(4)$ group a given pair uniquely determines a second pair from the corresponding relator and these pairs are equal in the group. We call the process of replacing one pair with the other pair it determines *exchanging a pair*.

A *chain* is a reduced $n \times 1$ disk having the form shown in figure 3.4, where $n \geq 1$. We call the word $t_0 t_1 t_2 \cdots t_{n+1}$ a *chain word* and the word $s_1 s_2 \cdots s_n$ the *inner link path*. We collectively refer to the inner link path and the edge labelled $t_1 t_2 \cdots t_n$ as the *sides of the chain*. If an inner link path of a chain is of the form $a t_1 t_2 \cdots t_n a^{-1}$ we say that it is a *conjugacy chain*. We call the process of replacing a chain word with its inner link path a *chain collapse*.

let D be a PE disc diagram and v be a 0-cell on ∂D . Define the *turning angle* to be $\tau(v) = \pi - \sigma_v$, where σ_v is the sum of the corner angles of all of the 2-cells incident to v .

The following is a consequence of Lyndon's curvature theorem.

Theorem 3.1 ([20]). *Let $G = \langle X | R \rangle$ be a $C'''(4) - T(4)$ group and D be a disc diagram. Then on ∂D there are at least 4 more vertices with positive turning angle than there are vertices with negative turning angle. Therefore there are at least four chains on the boundary of D with disjoint interiors.*

This immediately gives an algorithm for solving the word problem for a word w in a $C'''(4) - T(4)$ group:

Algorithm 3.1. Freely reduce w . If w is empty then $w =_G 1$. If w is non-empty then scan the word from the beginning for a pair. If no pairs exist then $w \neq_G 1$, otherwise scan for

the next pair. If this pair forms a chain word then perform the chain collapse and repeat all of the above. If this pair does not form a chain word then search for the next pair and check whether this pair and the preceding pair forms a chain word. If so perform the chain collapse and go to the beginning of the algorithm. Continue like this until all pairs have been checked. If w is still non-empty then $w \neq_G 1$.

If we consider $C''(4) - T(4)$ presentations with parity then there two types of chains: those with a white inner link path, which we call *white chains* and those with black inner link path which we call *black chains*. The algorithm above performs chain collapses on both colours of chain. For comparison with the normal surfaces algorithm later, it is useful to know that the above algorithm works if we only carry out chain collapses on chains of a single colour. The following proposition tells us we can do this.

Proposition 3.1. *Let $G = \langle X|R \rangle$ be a $C''(4) - T(4)$ presentation with parity and D be a disc diagram. Then on ∂D there exist both white chains and black chains.*

Proof. To each 0-cell v on the boundary ∂D assign the number $3 - d(v)$, where $d(v)$ is the number of 1-cells incident to v . We call this number the *weight*. Note that positive (resp. zero, resp. negative) turning angles correspond to 0-cells of weight 1 (resp. 0, resp. < 1). By reading off the non-zero weights, with respect to some choice of starting point, we get a sequence of numbers, which we call the *sequence of weights*. We prove the result by considering the structure of this sequence and its relationship to the chains on the boundary.

First observe that the occurrence of a subsequence 1, 1, 1 in the sequence of weights corresponds to a sequence of three positive turning angles. The middle turning angle must then be the corner of two chains of different colours.

Now suppose that such a sequence does not occur. Then we may assume that the sequence of weights is of the form $1, 1, \sigma_1, 1, 1, \sigma_2, \dots, 1, 1, \sigma_n$ where each σ_i is a subsequence of weights which either consist of one negative weight or the first and last terms are negative and any positive term is bounded on each side by a negative term. Note that these conditions imply that the sum of the weights in each σ_i is at most -1 .

Now if there exists a subsequence σ_i such that the sum of its weights is odd then it is not hard to see that the two subsequences 1, 1 bounding σ_i correspond to chains of different colours and we are done.

It remains to show that it is impossible for the sum of the weights of every σ_i to be even. Suppose this was the case. Then a version of Lyndon's curvature formula (see [35]) gives

$$4 \leq \sum_{v \in \partial D} (3 - d(v)) = \sum_{v \in \partial D} w(v) = 2n + \sum_{i=1}^n w(\sigma_i),$$

where $w(v)$ is the weight of vertex v and $w(\sigma_i)$ is the sum of the terms of σ_i . But if each $w(\sigma_i) \leq -2$, this is impossible, giving the required contradiction. \square

Given an arbitrary finite group presentation, the set of lengths of all words representing an element of the group has a minimum. Any word which attains this minimum is called a *geodesic*. Geodesics in a $C''(4) - T(4)$ presentation are characterized by the absence of chain words:

Geodesic Characterization Theorem ([3, 20, 26, 28, 29]). *A word in a $C''(4) - T(4)$ presentation is geodesic if and only if it is freely reduced and contains no chain subwords.*

Hence algorithm 3.1 finds a geodesic representative of a given word. We will make use of this later.

We say that a link projection is *reduced* (or *untwisted*) if at every crossing in the projection, four distinct regions meet. If in addition two distinct regions have at most one edge in common we say that the projection is *elementary*. We note that every prime alternating knot has an alternating elementary projection ([35, 44]) and if an alternating projection is elementary then its corresponding link is prime ([37]).

Theorem 3.2 ([48]). *If a link has an alternating elementary projection (and is therefore prime and alternating), then the augmented Dehn Presentation satisfies the $C''(4) - T(4)$ small cancellation conditions and thus the word and conjugacy problems for its fundamental group are solvable.*

3.4 A solution to the Word Problem by Normal Surfaces

We will now outline Dugopolski's algorithm for deciding whether a loop in the complement of an alternating link is contractible. Clearly this solves the word problem for the fundamental groups of alternating links. The reader is referred to [16] for the justification of the algorithm.

Let M be a 3-manifold and F be a surface in M . Suppose that q is a loop in M and q^* is an arc of q such that $q^* \cap F = \partial q^*$. If there exists a deformation of q^* into F which keeps the endpoints fixed, then we may deform q so that it intersects F at two fewer points (see figure 3.5(a)). We call such a deformation *type 1 reduction* of q with respect to F .

We call the inverse move (which increases the number of intersections with respect to F by two) a *type 1 augmentation* of q with respect to F .

Now suppose that q^* is an arc of q such $q^* \cap \partial M = \partial q^*$, F is a surface in M such that $\partial q^* \cap F = \emptyset$ and q_1^* is a sub-arc of q^* such that $q_1^* \cap F$ consists of one point of ∂q_1^* and $q_1^* \cap \partial q^*$ is the other point of ∂q_1^* . If q_1^* deforms to an arc lying in $F \cup \partial M$ intersecting ∂F once, then q^* deforms to an arc lying partly in ∂M , where the part not in ∂M intersects F one less time than q does (see figure 3.5(b)). We call this a *type 2 deformation* of q^* .

We will associate a set of surfaces F_1, \dots, F_n to the complement of an alternating link L . Let $D \subset \mathbb{R}^2 \cup \infty \subset S^3$ be an alternating projection of L . The checker-board colouring induces a colouring on the regions of the link (recall our convention of colouring the outer

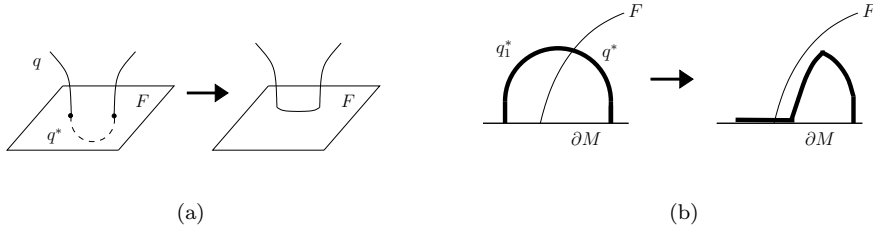

Figure 3.5: Type 1 and 2 moves.

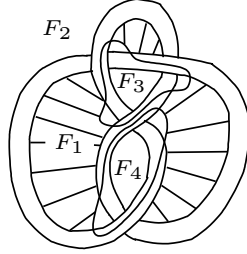

Figure 3.6: A hierarchy for the figure 8 knot.

region white). Form a black (resp. white) surface in the usual way by identifying all the black (resp. white) regions along their intersection at the polar axes. This gives surfaces whose boundary is L (in the case of a knot, these are spanning surfaces). Choose one of the surfaces, black say, call it H . Let $F_1 = H - N(L)$, where $N(L)$ is a small regular neighborhood of L . Let $N(F_1)$ be a small regular neighborhood of F_1 and define the surfaces F_2, \dots, F_n to be what remains of the white surfaces in $S^3 - (N(L) \cup N(F_1))$ (see figure 3.6). We call the set of surfaces F_1, \dots, F_n the *black checker-board hierarchy* of D . If we construct F_1 from the white surface, we call the resulting set of surfaces the *white checker-board hierarchy*. Unless otherwise stated, we will use the black checker-board hierarchy and will refer to it simply as the checker-board hierarchy.

Remark 3.2. The hierarchy we use has one more surface (from the outer region) than the one used by Dugopolski (although the extra surface is used implicitly at some points in his paper). This extra surface does not effect the validity of the algorithm.

Notice that we can split $S^3 - N(L)$ into 3-balls by removing small regular neighborhoods of all the F_i . In particular if we have some arc q in $S^3 - L$ then the only obstructions to being able to perform a type 1 reduction or a type 2 deformation with respect to some F_i comes from the intersections of q with the boundary of the 3-balls. This is discussed in more detail in section 3.12, but for the time being we will just note that this gives a process to check whether we can perform a type 1 reduction or a type 2 deformation with respect to any of the F_i . Retaining the notation of [16], we give this the mysterious title *process X* with respect to F_i .

Dugopolski's paper solves the word problem for the fundamental groups of certain 3-manifolds in which there exist a finite set of surfaces which satisfy certain technical conditions. He provides an algorithm which decides whether a type 1 reduction with respect to one of these surfaces is possible for a given arc. He then goes on to prove that if a loop contracts then the number of times that it intersects with the set of surfaces can be reduced to zero by type 1 reductions. He shows that the checker-board hierarchy is such a set of surfaces in the complement of alternating links and provides an algorithm for deciding whether a loop in the complement is contractible or not. The algorithms follow.

In what follows let L be an alternating link and F_1, \dots, F_n be the corresponding checker-board hierarchy. Also let l be a loop in $S^3 - N(L)$ and l_j be an arc of l such that $l_j \cap N(F_1) = \partial l_j$.

The following algorithm determines whether it is possible to perform a type 1 reduction on l_j with respect to F_1 .

Algorithm 3.2 ([16]). If $l_j \cap \cup_{i=2}^n F_i = \emptyset$ then use process X to check if a type 1 reduction with respect to F_1 is possible. If $l_j \cap \cup_{i=2}^n F_i \neq \emptyset$, then for every subarc of l_j with endpoints on the same disc, check for and perform type 1 reductions with respect to that surface. Repeat this until no more such reductions can be made. If now $l_j \cap \cup_{i=2}^n F_i = \emptyset$ then use process X to check if a type 1 reduction with respect to F_1 is possible. If $l_j \cap \cup_{i=2}^n F_i \neq \emptyset$, then split l_j into arcs l_{j_1}, \dots, l_{j_s} by $\cup_{i=2}^n F_i$. Use process X to check l_{j_1} for a type 2 deformation. If one is possible deform l_j so that it lies partly in $\partial N(F_1)$ and the part which is not in $\partial N(F_1)$ is an arc with endpoints in $\partial N(F_1)$, intersecting $\cup_{i=2}^n F_i$ one fewer times. Now if $l_j \cap \cup_{i=2}^n F_i = \emptyset$ then use process X to check if a type 1 reduction with respect to F_1 is possible and if $l_j \cap \cup_{i=2}^n F_i \neq \emptyset$, then repeat this step for the new arc $l_{j_2} l_{j_3} \dots l_{j_s}$ until no further type 2 reductions may be performed. If now $l_j \cap \cup_{i=2}^n F_i = \emptyset$ then use process X to check if a type 1 reduction with respect to F_1 is possible. If $l_j \cap \cup_{i=2}^n F_i \neq \emptyset$ then a type 1 reduction with respect to F_1 is not possible.

This algorithm decides whether a type 1 reduction is possible, however to implement the algorithm we also need to know what the loop will look like after we have carried out the type 1 reductions and the type 2 deformations. It is clear how to draw an arc after a type 1 reduction. Performing a type 2 deformation pushes part of the loop into the regular neighborhood. Keeping in mind that the aim of a type 2 deformation is to kill off an intersection with a particular surface, it is not hard to see that we should push the arc through the other side of $N(F_1)$. Note that since we will only carry out such moves when we find a type 1 reduction, the following algorithm will still be finite time. We will examine these moves for the checker-board hierarchies in more detail in section 3.6.

The following algorithm determines whether a loop $l \subset S^3 - N(L)$ is contractible and hence solves the word problem:

Algorithm 3.3 ([16]). If $l \cap F_1 = \emptyset$ then use process X to check for type 1 reductions with respect to F_2, \dots, F_n and carry them out (since $l \cap F_1 = \emptyset$ there are no possible type 2 deformations). If now $l_j \cap \cup_{i=2}^n F_i = \emptyset$ then l is contractible, otherwise it is not.

If $l \cap F_1 \neq \emptyset$ then use F_1 to split l into arcs l_1, \dots, l_m . Use algorithm 3.2 to check for and carry out all type 1 reductions with respect to F_1 for each arc $l_i, i = 1, \dots, m$. If now $l \cap F_1 \neq \emptyset$ then l is not contractible.

Otherwise split l into arcs l_1, \dots, l_s by the intersections with F_2, \dots, F_n and use process X to check for, and then carry out, all type 1 reductions. If now $l \cap \cup_{i=1}^n F_i = \emptyset$ then l is contractible, otherwise it is not.

3.5 Loops and the Dehn Presentation

We will now look at the relationship between the (augmented) Dehn presentation and loops in the link complement. This provides the interaction between small cancellation theory and normal surfaces.

By a loop we will mean either the path itself or its embedding. It will be clear from context which is meant, and since we will mostly work up to homotopy, this confusion does not cause any problems.

Let l be a loop in $S^3 - L$. Up to homotopy we may assume that l intersects the interiors of the regions of the link transversally. We will always assume this of any loop or arc. Further, since the union of the regions splits S^3 into two 3-balls, every arc between two intersection points whose interior does not intersect any regions, determines a unique homotopy class. So, up to homotopy, the only information that a particular (oriented) loop carries is which regions, in what order and in what direction it intersects these regions.

Of course we can consider a word in the (augmented) Dehn presentation as a based oriented loop in the (augmented) link complement. What about the other direction?

If an oriented loop is based then, it is equivalent to a word in the alphabet generated by the labels of the regions, x_0, \dots, x_n , constructed by following the loop in the direction of the orientation from the base point and assigning the letter x_i every time the loop passes downward through the region x_i and x_i^{-1} every time the loop passes upward through the region. We call the word generated in this way the *canonical word* determined by the loop. Note that all canonical words are even in length and alternating in sign.

We have constructed a 1-1 correspondence between alternating words of even length and the homotopy classes of based oriented loops in $S^3 - L$ relative to the set of intersection points with the union of the regions of the link. Let's see how this relates to the Dehn presentation.

Given a based oriented loop $l \subset S^3 - L$, we would like to obtain a canonical element in the augmented Dehn presentation. The usual way to do this is to pull everything upwards,

by homotopy, to the base point. This way is not suitable for our purposes as it introduces extra intersection points with the regions of the augmented link. Instead we prefer the following method. We replace each arc from a region x_i to a region x_j which lies completely above the regions with a path from the intersection point with x_i directly to the base point of the space and then directly back down to the intersection point with x_j . Each arc defined by the intersection of the loop with the regions which lies entirely underneath the regions, we homotope this by sweeping it around the outside of the \mathcal{O} component of the augmented link so that it intersects the base point to the space at one point. Up to homotopy we may assume that the base point of the loop coincides with that of the space. It is clear how this construction represents an element in the Dehn generators of the augmented link group. We call this the *canonical element* of the augmented Dehn presentation determined by l . It is easy to see that the canonical element of a loop is exactly the element in the augmented Dehn presentation given by the canonical word.

Of course this is not well defined. The problem being that if we are given two freely homotopic based oriented loops in the link complement, taking the canonical element fixes a path from the loop to the base point of the space and as elements of the fundamental group and these may represent different elements of the fundamental group. However, it is not hard to see that these two classes are conjugate. Therefore we have a correspondence between based oriented loops in the link complement and included words in the augmented Dehn presentation which is well defined up to conjugacy. Since we are interested in the word and conjugacy problems, this is sufficient for our purposes.

Remark 3.3. This is basically the folklore result that, for sufficiently nice topological spaces, the conjugacy problem is equivalent to determining whether two loops are freely homotopic.

3.6 Hierarchies and the Dehn Presentation

In this section L is an alternating link. We will explore the relationship between the checker-board hierarchy and the augmented Dehn presentation.

We constructed the black (resp. white) checker-board hierarchy from the regions of the link by identifying the black (resp. white) regions and removing a neighborhood of the boundaries of these surfaces. So we have a correspondence between the hierarchies and the regions. Furthermore, we may assume that the intersection points between the loops and the regions lie away from the parts of the regions which are removed during the construction, giving a correspondence between loops in the link complement containing a black or white checker-board hierarchy and the set of regions, which, by section 3.5, gives a correspondence with words in the augmented Dehn presentation. From this, one expects a correspondence between type 1 and type 2 moves and some actions on the augmented Dehn presentation. We will work out the details.

Although a type 1 reduction is performed with respect to a surface in the hierarchy,

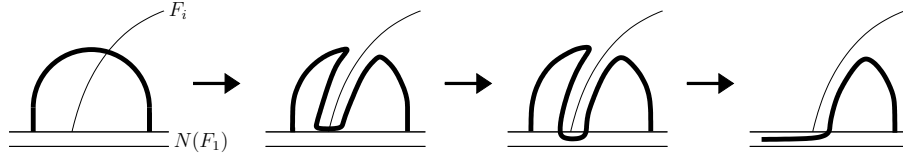

Figure 3.7: A type 2 deformation.

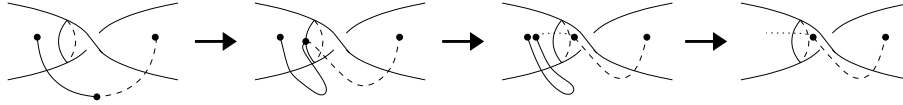

Figure 3.8: Realizing a type 2 deformation.

rather than the regions of the link, the two end points of the arc we are reducing must lie in the same region otherwise that arc would intersect another surface in the checker-board hierarchy. It is now easy to see that in terms of regions, a type 1 reduction is a move which pulls an arc which intersect a region x_i then comes straight back through in the opposite direction, completely through the region. In terms of the canonical words this corresponds to replacing $x_i^{\pm 1} x_i^{\mp 1}$ with 1, which is a free reduction. Similarly, a type 1 augmentation with respect to x_i introduces a subword $x_i^{\pm 1} x_i^{\mp 1}$.

Let's look at the more complicated type 2 deformation. A type 2 deformation can be thought of as a finger move which pushes an arc along F_i , $i \geq 2$, into $N(F_1)$, then push everything on one side of F_i into the neighborhood as in figure 3.7. Remembering that the hierarchies are formed by regions which intersect as in figure 3.2, we can interpret this in the link complement as a finger move which pushes the intersection point along F_i until it intersects the North-South axis. Then pushing it into $N(F_1)$, so that it does not intersect with F_i at all. Finally, push the relevant part of the arc so that part lies completely inside the neighbourhood. This is indicated in figure 3.8, where the dotted line may intersect more surfaces before returning to F_1 . Next we go on to push the arc lying in the neighbourhood through to the other side. This process is shown as a projection in figure 3.9 (where the type 2 deformation is with respect the black checker-board hierarchy). By the correspondence with the regions we see that a type 2 deformation of some loop corresponds to exchanging a pair in the canonical word.

Our final observation is that moving the base point of a based oriented loop just changes where we start (and finish) reading the canonical word and therefore corresponds to a cyclic permutation of the word.

3.7 A Comparison of the Algorithms for the Word Problem

We will apply the theory of sections 3.5 and 3.6 to the two solutions of the word problem for prime alternating link groups. We will begin by expressing Dugopolski's algorithm in terms

If we were successful at any point then a type 1 reduction with respect to F_1 is possible, otherwise one is not.

Now let l be an element of $\pi_1(S^3 - L)$, where L is an alternating link. Without loss of generality, we may assume that $\pi_1(S^3 - L)$ is given by the Dehn presentation. Then let w be the included canonical word representing this loop.

The following is a rewriting of algorithm 3.3 and hence it solves the word problem for the groups of alternating links.

Algorithm 3.5. If w contains letters of parity white only then freely reduce w . If this gives the empty word then $w =_\pi 1$ otherwise $w \neq_\pi 1$.

If w contains letters of parity black. Then if there is exactly one letter of parity black, $w \neq_\pi 1$, otherwise cyclically permute so that the first letter is black. Now w can be written as $\beta_1\omega_1\beta_2\omega_2\cdots\beta_n\omega_n$, where ω_i is a subword of white parity (and may be empty), and each β_i consists of exactly one letter of parity black. Pick a subword $\beta_i\omega_i\beta_{i+1}$, for i modulo n , and run algorithm 3.4. If the algorithm is successful freely reduce the subword or replace it with its switch as appropriate. Repeat this with the new word until no more such substitutions are possible.

If now there are only parity black letters then $w \neq_\pi 1$. If there are only parity white letters then freely reduce. If the word is now empty then $w =_\pi 1$ otherwise $w \neq_\pi 1$.

This simplifies to the following:

Algorithm 3.5'. Freely reduce w and its cyclic permutations. Chain collapse all chain words beginning and ending in a letter of parity black in w and its cyclic permutations. Freely reduce. If we obtain the empty word then $w =_\pi 1$ otherwise it does not.

Observing that we need never cyclically permute the word, we see that this is exactly algorithm 3.5, where the chain collapses are only carried out with respect to black chains.

We now turn our attention to the rewriting of the group theory algorithm in the language of normal surfaces.

We start with some included word w in the augmented Dehn presentation. Algorithm 3.1 tells us how to determine whether this represents the identity in terms of free cancellation and chain collapses. We know that a free reduction corresponds to a type 1 reduction. Let's see what we can do with a chain collapse.

Let atb be a chain word with inner link path s , where $t = t_1t_2\cdots t_n$ and $s = s_1s_2\cdots s_n$. Then we may view a chain collapse as a sequence of exchanging pairs followed by a free reduction: $at_1\cdots t_nb \rightarrow s_1u_1\cdots t_nb \rightarrow \cdots \rightarrow s_1\cdots s_nb^{-1}b \rightarrow s_1\cdots s_n$, where the u_i are the labels of the internal vertical edges in the chain. We want to write this as a sequence of moves on a loop. Recall that the hierarchies split the loop into subarcs. Starting from the

intersection of the loop with region a do a type 2 deformation (with respect to the checker-board hierarchy with the same colour as a) on the subarc between regions a and t_1 . Pushing this through the surface our subarc now intersects regions s_1 and u_1 . Now do the type 2 deformation on the next subarc between u_1 and t_2 . Continue like this until we reach a subarc between the region b (this is after n moves) and eliminate this through a type 1 reduction.

Letting F_1, \dots, F_n be the black checker-board hierarchy and H_1, \dots, H_n be the white checker-board hierarchy we can interpret algorithm 3.1 as:

Algorithm 3.6. If $l \cap \cup_{i=1}^n F_i = \emptyset$ then l is contractible. If $l \cap \cup_{i=1}^n F_i \neq \emptyset$ use process X to find and carry out all type 1 reductions except for those which would move the base point. If now $l \cap \cup_{i=1}^n F_i = \emptyset$ then l contracts. Otherwise use the black hierarchy to split l into arcs f_1, \dots, f_p and use the white hierarchy to split l into arcs h_1, \dots, h_q . Starting from the base point use algorithm 3.2 to search for a type 1 reduction with respect to both F_1 and H_1 . If any are found which do not include the base point of l , look at the arcs of l which they determine. These will be nested, so choose the innermost arc and carry out the sequence of moves required to make the relevant type 1 reduction. Use process X to find and eliminate any further type 1 reductions which do not move the base point. Repeat this until all such reductions are made. If now $l \cap \cup_{i=1}^n F_i = \emptyset$ then l contracts. Otherwise it does not.

Note that in this algorithm, we keep the base point fixed at all times and we are working with respect to two hierarchies.

Remark 3.4. By the geodesic characterization theorem, algorithm 3.6 will find a loop in the homotopy class of l such that the number of intersection points with the regions (or hierarchy) is minimal.

3.8 The Role of Non-Positive Curvature

The role of non-positive curvature in small cancellation theory is well known. In this section we will discuss where the non-positive curvature is hidden in the normal surface approach. This suggests why the two algorithms coincide on prime alternating links. The 2-complex discussed here was noted independently by Aitchison (unpublished) and Wise in [49] (see also [12]).

Given a link L construct a PE 2-complex as follows: take two 0-cells, v_- and v_+ . Add a 1-cell corresponding to each region of the link, oriented from v_+ to v_- and label each 1-cell according to the regions. Finally take one 2-cell D_i for each relator r_i and attach the 2-cells by a continuous map taking ∂D_i to the path in the 1-skeleton representing r_i . Give this complex a PE structure by regarding the 2-cells as regular 4-gons. We call this the *Dehn complex* of L and we call the Dehn complex of the augmented link the *augmented Dehn complex* of L .

Clearly the fundamental group of the (augmented) Dehn Complex of a link L is the (augmented) Dehn presentation of L .

Lemma 3.2. *Let L be a reduced link. Then the Dehn complex embeds into $S^3 - L$.*

Proof. Recall that we are assuming $L \subset \mathbb{R}^3 \cup \infty$ coincides with its projection except at crossing balls. Take v_+ to lie above $\mathbb{R}^2 \cup \infty$ and v_- to lie below. Position the 1-cells so that they pass through the region which label them. The result follows from the following picture which shows the embedding locally at a crossing.

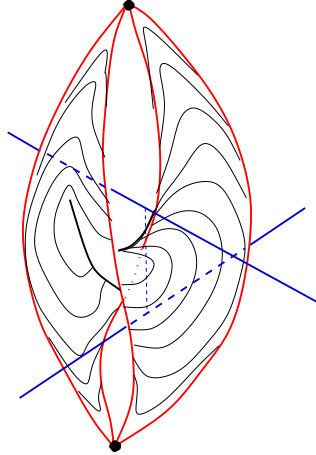

□

Remark 3.5. With a little more thought one can see that when L is reduced the Dehn complex is in fact a deformation retract of the link complement.

Consider the Dehn complex embedded as in the above lemma. Recall the discussion of section 3.5 which says that up to homotopy the relevant information of any loop are its intersections with the regions. So canonically we may assume that any loop coincides with the 1-skeleton of the Dehn complex. We may think of type 1 reductions and type 2 deformations as moves between paths in this 1-skeleton. In this situation, a type 1 reduction is clearly a move within the one skeleton. A type 2 deformation corresponds to exchanging a pair and it is easy to see that we may assume that this deformation lies on the appropriate 2-cell of the Dehn complex. Thus we see that Dugopolski's algorithm descends to an algorithm on the Dehn complex of a reduced alternating link.

The small cancellation properties of the augmented Dehn presentation are dependent upon the Dehn complex. We say that a PE 2-complex has *non-positive curvature* if traveling around the boundary of any small disk in the complex whose origin is at a 0-cell we travel through an angle of $\geq 2\pi$.

The following proposition is theorem 3.2 rephrased in terms of non-positively curved complexes.

Proposition 3.2 ([48, 49]). *The Dehn complex of a reduced link is non-positively curved if and only if the projection is prime and alternating.*

One can make any non-positively curved square complex into one with a $C''(4) - T(4)$ fundamental group by adding a 1-cell between a distinguished 0-cell and every other 0-cell in the complex. These observation and the above proposition indicate why the two approaches discussed in this chapter coincide.

3.9 A Small Cancellation Solution for the Conjugacy problem

In this section we will outline Johnsgard's solution of the conjugacy problem. Johnsgard analyzes the types of disc diagrams that are possible for $C''(4) - T(4)$ small cancellation groups and the restrictions imposed upon the diagrams by the geometry of the link. An algorithm is then provided for finding cyclic geodesic representatives of the conjugacy class of a given element. The reader is referred to [27] for the details and justification of the results discussed in this section.

First some nomenclature for $C''(4) - T(4)$ presentations. If there exists a letter b such that ab and $b^{-1}c$, where $c \neq a^{-1}$, are both pairs, we call ac a *sister-set*. If a disk of relator squares forms a "L" shape such that the inner crook of the "L" is not a pair, we call the word labeling the crook a *pseudo-pair*. Note that in a $T(4)$ presentation no pair is a sister-set and in a group presentation with parity, no pseudo-pair is a sister-set.

We say that a word is *cyclically geodesic* if all its cyclic permutations are geodesic. If a word is a cyclic permutation of another, we say that the two words are *cyclically equal*, and if two geodesic words represent the same group element we say they are *equivalent geodesics*.

We will use the following construction in algorithm 3.7. Regard the integral points (n, m) in the plane as potential 0-cells for a 1-complex. Let w be a geodesic word in a $C''(4) - T(4)$ presentation. We embed w in the plane in the following way. Start at the point $(0, 0)$, which we take to be a 0-cell. Choose a point at displacement \mathbf{i} away and also take the 1-cell between these points as part of the complex. Label this 1-cell with the first letter of w . If w has more letters then from this point choose a 0-cell and corresponding 1-cell a displacement of \mathbf{i} away and label this new 1-cell with the next letter in the word according to the following criterion: if the new letter and the preceding one form a pair or a pseudo-pair which is not a sister set, change direction from that most recently taken; otherwise keep going the same way. Continue in this way for the remainder of the word. The 1-complex thus obtained is called the *standard embedding* of w .

Denote the standard embedding by C_0 . From C_0 we construct a singular disc diagram by the following iterative procedure: consider each right angle in the plane that is not contained in consecutive edges of a relator square of C_i , if this right angle is labelled by a

pair then add the (unique) relator square to the diagram it determines. Call the resulting diagram C_{i+1} . Continue in this way until no more squares can be added.

The resulting diagram is called the *geodesic completion* of w . It is characterized by the following theorem:

Geodesic Completion Theorem ([28]). *A geodesic word in a $C''(4) - T(4)$ presentation uniquely determines a square tiling (the geodesic completion) bounded by a rectangle in the Euclidean plane such that every equivalent geodesic of the original word is a label of a geodesic rectilinear edge path which is path-homotopic to the edge path of the original word.*

The geodesic characterization theorem provides an easy method for replacing a word with a conjugate cyclic geodesic word by taking cyclic permutations and geodesic representatives of the word in $C''(4) - T(4)$ presentations.

We also note that by [27] proposition 4.1 and corollary 4.8, in an alternating $C''(4) - T(4)$ presentation with parity, conjugate cyclic geodesic words are of the equal even length, both alternate in sign, and have equal numbers of letters of each parity.

Let u' and w' be words in the augmented Dehn presentation of a prime alternating link. Then the following algorithm solves the conjugacy problem in polynomial (order 7) time.

Algorithm 3.7 ([27]). Take cyclic geodesic representatives u and w of u' and w' . We may assume these are non-empty words.

If u and w are not both of equal even length, alternating in sign with the same number of letters of each parity, then u' and w' are not conjugate. Otherwise there are two cases: whether w has letters of both parities or not.

First consider the case where w has letters of both parities. We are going to construct a planar 2-complex using relator squares of unit length coming from the presentation and regarding the integral points of the plane as possible 0-cells.

Begin by taking the geodesic completion of w . For simplicity, assume that the first letter of w is oriented in the \mathbf{i} direction and the path representing w lies in the first quadrant with endpoint (I, J) .

Some of the relator squares in the geodesic completion may intersect the lines $x = 0$ or $x = I$. Let l_1 (resp. r_1) be the word labelling the path in the geodesic completion which sits on the line $x = 0$ (resp. $x = I$). If l_1 is non-empty then add a path from (I, J) to $(I, J + |l_1|)$ labelled by l_1 to the complex and take the geodesic completion. If this creates a new path in the geodesic completion which lies on $x = 0$ (so its initial point is $(0, |l_1|)$), we label this l_2 . We place a copy of this path on top of $(I, J + |l_1|)$ and take the geodesic completion. Continue in this way until we either reach an l_i which is empty or until the 2-complex starts repeating itself.

Repeat this process with the words r_i which we add to the complex on the $-\mathbf{j}$ direction from the point $(0, 0)$.

Now check every path from point $(0, n)$ to $(I, J + n)$, where n is an integral point on the 2-complex, for cyclic permutations of u . If such a path is found u and w are conjugate otherwise they are not.

Now consider the case where w is composed entirely of letters of a single parity. Look for all letters x_{a_i} such that $x_{a_i}^{\pm 1} \cdot w \cdot x_{a_i}^{\mp 1}$ is a chain word. This determines some chains which all have a side labelled by w . Identify these chains along their common side to obtain a connected 2-complex. This 2-complex has a set of paths which are the sides of some chain. For each of these paths we look for all chains which have a side labelled by a path in this set and, unless it is a cyclic permutation of some chain which has been previously added to the complex, we identify the common edges of the chain and the 2-complex. Continue in this way until no new chains can be added to the complex.

If there is a path in this complex which was the side of a chain which is labelled by a cyclic permutation of u then u and w are conjugate otherwise they are not.

Remark 3.6. We will see in section 3.13 that the 2-complexes produced by the algorithm are in fact simply connected.

3.10 The Algorithm in Action

To aid the digestion of the conjugacy algorithm, we provide a few examples of the diagrams it produces.

First consider the trefoil. This has augmented Dehn presentation

$$\langle x_0, \dots, x_4 | x_1 x_4^{-1} x_2 x_0^{-1}, x_1 x_0^{-1} x_3 x_4^{-1}, x_2 x_4^{-1} x_3 x_0^{-1} \rangle.$$

The following diagrams are constructed by the algorithm for the words $w = x_3^{-1} x_4 x_0^{-1} x_2$ and $v = x_1 x_3^{-1}$. The diagram for w is on the right and for v the left.

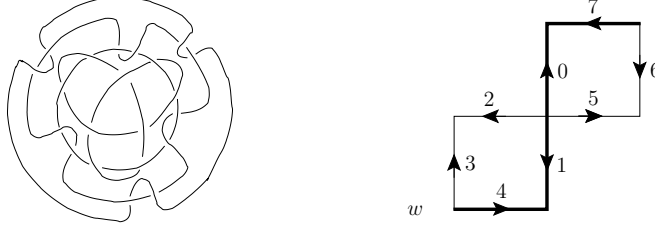

There exists a labelling of the regions of the above link such that $x_2x_1^{-1}x_4x_3^{-1}$ and $x_7x_6^{-1}x_5x_0^{-1}$ are relators and $x_2^{-1}x_0$, $x_1^{-1}x_5$, $x_7^{-1}x_3$ and $x_6^{-1}x_4$ are not pairs or pseudo-pairs. In fact in this labelling 1 and 0 are of opposite parity.

Notice that the diagram produced by algorithm 3.7 from the word $w = x_4x_1^{-1}x_0x_7^{-1}$ contains a split vertex and the diagram contains collinear edges with opposite parity. In fact, by the theory of [27] in such situations (where there is a two letter subword which is not a pair, sister set or pseudo-pair) all of the cyclic geodesic representative come from the geodesic completion.

3.11 Normal Surfaces and the Conjugacy Problem

In light of what has come before, it should come as no surprise that the small cancellation solution to the conjugacy problem gives a normal surfaces algorithm. Algorithm 3.7 finds finite sets of certain cyclic geodesic representatives of the conjugacy classes of the group. Moreover, every group element is conjugate to one of these representatives.

The algorithm starts with an included word $w = i_*(w')$, where i_* is the inclusion of the Dehn presentation into the augmented Dehn presentation, and constructs a planar diagram. From this diagram we can read off a set representatives of the conjugacy classes of w . By section 3.5, w can be represented as a based oriented loop in $S^3 - L$ and since we are interested in conjugacy, by section 3.7, we can work with these loops. In this section we will interpret the small cancellation methods for the conjugacy problem to find a normal surfaces solution to the conjugacy problem for prime alternating links. Our aim is to construct the (representatives of the) conjugacy classes geometrically.

We call a loop in $S^3 - L$ or $S^3 - (L \cup \mathcal{O})$ *minimal* if it attains the minimal number of intersections with the regions x_0, \dots, x_n (or equivalently, for $S^3 - L$, the hierarchy). Say that two loops are *equivalent minimal* if they are homotopic and minimal.

It is clear that canonical loops from cyclic geodesic words are minimal and loops of equivalent geodesics, cyclic permutations and inverses from a cyclic geodesic word are equivalent minimal.

First we need to understand the geometry behind the geodesic completion. Remember that by the geodesic completion theorem, the geodesic completion of a word w contains all of its equivalent geodesics. One point to bear in mind, is that different cyclic permutations

of the same word will in general produce different geodesic completions (unless there are no pseudo-pairs). This means that our interpretation to loops will depend upon the base point.

By the construction of the geodesic completion, it is clear that the following method will produce the set of all equivalent geodesics of a word w : Start with the set containing only w . Scan w for pairs. To each pair we find, take a copy of w and replace that pair with the other pair in the relator it determines. If this creates a word not already in the set add it to the set. Repeat this process with each new word we find which is not already in the set. Stop when we can't continue with this process.

Note that if w has n_w of letters of parity white and n_β of parity black, then there are at most $(n_\beta + n_w)!/n_\beta!n_w!$ equivalent geodesics.

Now since exchanging a pair corresponds to a type 2 deformation of the canonical loop, it is easily seen from the construction that the set of (minimal) loops produced is the set of loops which can be obtained from l_w by a sequence of type 2 deformations which keeps the base point fixed. Formally:

Lemma 3.3. *Let $l_{i_*(w)}$ be the oriented based loop representing a geodesic included word $i_*(w)$ in the augmented Dehn presentation of a prime alternating link. Construct a set of based oriented loops by performing all possible sequences of type 2 deformations while keeping the base point fixed. This set represents the equivalent geodesic words of w .*

We move on to the question of generating the set of representatives found by the algorithm in terms of geometric moves on loops. Denote by l_w the based oriented loop determined by the word w from the inclusion of $\pi_1(S^3 - L)$ into the augmented Dehn presentation.

The first step of algorithm 3.7 is to find cyclic geodesic representatives of the words. Algorithm 3.6 will do this.

The next step of the algorithm concerns words which are of odd length or non-alternating. Since words coming from the inclusion of the Dehn presentation into the augmented Dehn presentation are necessarily alternating and of even length, we need not consider this case.

Now suppose that w is alternating, of even length and contains letters of one parity only. Then algorithm 3.7 produces a finite strip in the plane. The set of representatives are the sides of the chains in this strip and the set of all geodesic representatives of the conjugacy class are their cyclic permutations. The set of representatives produced by the algorithm determines a set of minimal based loops. We would like to understand how to generate these geometrically starting from l_w . To do this it is sufficient to understand how to move between the sides of a single chain of the construction.

Consider a conjugacy chain with chain word ata^{-1} and inner link path s , where $t = t_1t_2 \cdots t_n$ and $s = s_1s_2 \cdots s_n$. So the sides s and t determine loops l_s and l_t respectively and we want to obtain l_t from l_s . On the level of groups, we can make the sequence of substitutions:
 $s_1 \cdots s_n \rightarrow a^{-1}s_1 \cdots s_n a \rightarrow t_1 b_1 s_2 \cdots s_n a \rightarrow t_1 t_2 b_2 s_3 \cdots s_n a \rightarrow \cdots \rightarrow t_1 \cdots t_n a^{-1} a \rightarrow t_1 \cdots t_n$.

From this we get the following geometric interpretation: Deform the arc of the link containing the base point so that the base point lies over region a and no further intersections with regions are added. Further deform this arc by a type 1 augmentation with respect to a (ie push the base point through region a). Follow the loop from the base point in the direction of the orientation. Each time we meet an intersection point carry out a type 2 deformation on the arc between that intersection point and the following one and continue following the loop. Continue in this way until we have carried out n deformations (or equivalently we have reached the final intersection point before the base point). Now carry out the type 1 reduction with respect to region a (since our original loop was minimal there is only one choice for the reduction). The reductions are with respect to the black or white checker-board hierarchy depending upon the parity of a .

Note that two loops are related by the above sequence of moves if and only if they can be represented as two sides of a chain.

So by algorithm 3.7 we have:

Lemma 3.4. *Let $l_{i_*(w)}$ be the oriented based loop representing a cyclic geodesic included word $i_*(w)$ which has letters of a single parity in the augmented Dehn presentation of a prime alternating link. Let S be the set of oriented loops given by forgetting the base point of the loops constructed from $l_{i_*(w)}$ by all possible repeated applications of the method described above. Then S represents all cyclic geodesic elements of the conjugacy class of $i_*(w)$.*

Now suppose that w contains letters of both parities, n_ω letters of parity white and n_β letters of parity black. Since we want to use the algorithm to generate all the geodesic representatives of the conjugacy class of w (up to cyclic permutation), rather than producing a diagram, will carry out algorithm 3.7 in the following way: find all equivalent geodesics of w (using the geodesic completion). If any of these words have the parity of the first letter opposite to that of the first letter of w , then choose one of them and call it w_{l1} , say. Similarly, if any of these words have the parity of the last letter opposite to that of the last letter of w , then choose one of them and call it w_{r1} . If w_{l1} exists, then cyclically permute it by one letter (so the first letter becomes the last). Call this new word w'_{l1} . Generate all of the equivalent geodesics of w'_{l1} . If any of these words have their first letter of opposite parity of the first letter of w , choose one and call it w_{l2} . Repeat this process for as long as is possible or until $\max\{n_\beta, n_\omega\}$ consecutive steps give no new words. Do an analogous process for w_{r1} .

There are three key step in the above process to interpret geometrically: generating the geodesics, recognizing the parity of the first letter and constructing w'_{lj} or w'_{rj} . The generation of geodesics was discussed earlier. The parity of the first letter is determined by the first intersection point of the loop. Constructing w'_{lj} from the permutation of w_{lj-1} and the cyclic permutation corresponds to moving the base point along the loop through one intersection point against the orientation.

Putting this together we get the following procedure: Given l_w minimal, based and

oriented. Note the colour of the first and last regions intersected by l_w . Carry out all possible sequences of type 2 deformations with respect to both checker-board hierarchies which fix the base point. If any of these new loops have the first (resp. last) intersection point of the opposite colour as the first (resp. last) as l_w choose one and move the base point forward (resp. backward) one intersection point and repeat this process. Continue like this for as long as we can or until we stop obtaining new loops.

Since algorithm 3.7 produces a set of cyclic geodesic words such that every conjugate cyclic geodesic word is a cyclic permutation of one of those produced, we see that by considering the set of all cyclic permutations of these words we get the set of all cyclic geodesic representatives of the conjugacy class. This obviously does not depend upon which particular cyclic geodesic we started with. This gives the following lemma.

Lemma 3.5. *Let $l_{i_*(w)}$ be the based oriented loop representing a cyclic geodesic included word $i_*(w)$, which has letters of a both parities, in the augmented Dehn presentation of a prime alternating link. Let S be the set of oriented loops given by forgetting the base point of the loops constructed from $l_{i_*(w)}$ and carry out all possible repeated applications of type 2 deformations. Then S represents all cyclic geodesic elements of the conjugacy class of $i_*(w)$.*

Putting all of this together we obtain the following geometric characterization of the conjugacy classes.

Proposition 3.3. *Let L be a prime alternating link, $s \in \pi_1(S^3 - L) \subset \pi_1(S^3 - (L \cup \mathcal{O}))$ and l be the oriented loop s determines. Then by using type 1 reduction and type 2 deformations with respect to both hierarchies of $S^3 - L$, l determines a set of loops with the property that every loop is minimal and represents the cyclic geodesics of the conjugacy class of s . Moreover, every loop representing an element in the conjugacy class of s is equivalent to an element of this set by a sequence of type 1 reductions and type 2 deformations.*

Although it should be fairly clear how to construct a polynomial time normal surface algorithm for the conjugacy problem for prime alternating links, for completeness we outline one.

Algorithm 3.8. Given two oriented loops $l_{w'}$ and $l_{u'}$ in the complement of a reduced prime alternating link. Use algorithm 3.6 to find equivalent minimal loops l_w and l_u respectively. There are two cases.

The first case is when l_w intersects two surfaces F_1 and F_i , for some $i \neq 1$. Use process X to look for and carry out all possible sequences of type 2 deformations (with respect to the checker-board hierarchy of the same colour as the first surface the loop intersects) . This produces a finite set of minimal loops. Choose some base point on each of these loops. If, when traveling round the loop from the base point in the direction of the orientation, we meet the surfaces in the hierarchy in the same order and direction as for l_u for any choice of base point then $l_{w'}$ and $l_{u'}$ are freely homotopic. Otherwise they are not.

The second case is when l_w intersects surfaces in the hierarchy of one colour only. Work with the checker-board hierarchy of the opposite colour. Use process X to carry out the procedure used in lemma 3.4 to produce a finite set of minimal loops. Choose some base point for each of these loops. If when traveling round the loop from the base point in the direction of the orientation produces we meet surfaces in the hierarchy in the same order and direction as for l_u for any choice of base point then l_w and l_u are freely homotopic. Otherwise they are not.

Remark 3.7. By considering annular diagrams (see [35]) one can show, quite unsurprisingly, that two words in the augmented Dehn presentation of an arbitrary link are conjugate if and only if one can be obtained from the other by a finite sequence of free reductions, exchanging pairs and adding a subword which can be freely reduced. Equivalently, two loops in a link complement are freely homotopic if and only if there is a finite sequence of type 1 reductions and augmentations and type 2 deformations. Of course our ability to find such a sequence is dependent upon our ability to solve the conjugacy problem.

A similar statement holds for the word problem.

3.12 Process X and the Petronio Cell Decomposition

Process X uses the fact that the hierarchy splits the manifold into 3-balls to check for type 1 and 2 moves. It is easy to see that the realizability of these moves only depends upon the positions of the endpoints of the arcs and how the hierarchy splits the manifold. More explicitly, the positions of the surfaces of the hierarchy determine a pattern on the boundary of the 3-balls and process X examines the positions and ordering of the intersections of the arc, which we will call the *intersection points*, in this pattern. By considering the Petronio (or pyramid) cell decomposition (see [11, 43]) of the link complement, we will fully describe process X for non-split alternating links.

Let L be a non-split link and D be its canonical projection. Construct a cell complex by taking as the 0-cells the North and South poles of the crossing balls. For the 1-cells, take the arcs of the link between the poles of the crossing balls and two 1-cells inside each crossing ball where each of these 1-cells has an end point on each of the poles. For the 2-cells we take two copies of each of the regions of the link and modify them slightly so that rather than having arcs lying on the north-south axes of the crossing balls, the arcs lie on the 1-cells of the complex. We do this in such a way that any intersection of the 2-cells is at one of these 1-cells. This 2-complex divides S^3 into 3-balls and we take these to be the 3-cells of the complex, where the attaching map is the obvious one.

Some of the 3-cells in this complex have non-trivial intersection with the regions of the link. We call such 3-cells the *sandwiched 3-cells*.

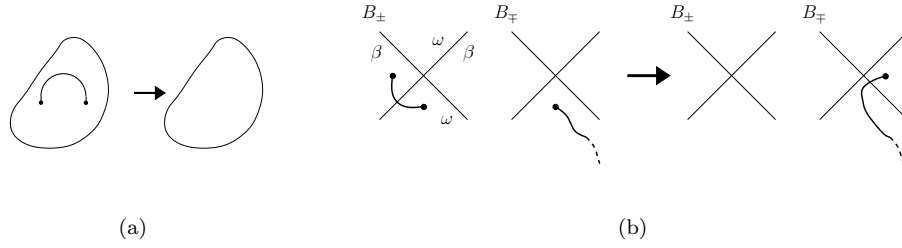

Figure 3.10: The moves on the Petronio cell decomposition.

What we have obtained is a cell decomposition of S^3 such that L is a sub 1-complex and $N(F_1) \cup_{i=1}^n F_i$ is a sub complex. In addition the 0-cells and 1-cells determine graphs on the non-sandwiched 3-cells. These are the ones required by process X.

Observe that if, in the above construction, we only add one 1-cell per crossing ball, one 2-cell per region of D and leave out the sandwiched 3-cells we still get the same graph on the boundary of the 3-balls. This gives a cell decomposition of S^3 with L as a sub-complex. This is called the *Petronio cell decomposition*. So our questions of intersections of arcs with the checker-board hierarchy may be phrased in terms intersections with the 2-cells of this complex. Finally, since this complex has the property that $S^3 - L = (S^3/L) - \{0 - \text{cells}\}$ and we are only concerned with points inside the 2-cells, we see that it is sufficient to use the Petronio cell decomposition. We will denote the 3-cells by B_+ and B_- , and call the graphs on them the *boundary graphs*.

Lemma 3.6. *Let L be a non-split alternating link. Then by examining the boundary graphs we see that:*

- (a) *A type 1 reduction can be recognized by two consecutive intersection points within the same region of the boundary graph. The reduction corresponds to deleting these two points (see figure 3.10(a), where the arcs connecting intersection points are to indicate the ordering).*
- (b) *A type 2 deformation is indicated by two consecutive intersection points in adjacent regions of the boundary path on B_{\pm} , which originate from a black region. The deformation replaces these two points with one coming out of the region opposite in the boundary graph on B_{\mp} (see remark 3.8), as in figure 3.10(b).*

Proof. The result follows by carrying the processes of section 3.6 through to the Petronio decomposition. □

Remark 3.8. When finding the image of a type 2 deformation on a boundary graph we must go back to the link to determine which region we should deform into. This has no bearing on process X since it only detects the presence of a type 1 or 2 move.

3.13 Planarity of the Conjugacy Algorithm

In section 3.9 it was claimed that the diagrams produced by the conjugacy algorithm for prime alternating links were planar (and therefore the algorithm is polynomial time). This was proved in [27]. Here we present a substantially shorter proof of the planarity of the diagrams produced by algorithm 3.7.

Define the *distance* between two regions of a link projection to be the minimum number of edges which a curve between the two regions must cross (in terms of the graph of a link with the usual metric it is the length of a geodesic path).

We have seen earlier that a pair corresponds to a arc of distance 1. It is not hard to see that a sister-set corresponds to an arc between two regions which are a distance 2 apart. Moreover, a region which is distance 1 from each of these regions is the element needed to form the two pairs in the definition of a sister-set. For completeness we note that a pseudo-pair corresponds to an arc between regions of distance 3.

Theorem 3.3. *The small cancellation diagrams produced by algorithm 3.7 are planar.*

Proof. Suppose we are given two cyclic geodesic included words in the augmented Dehn presentation of a prime alternating reduced link L . If the words contain letters of both parities the result follows since by theorem 3.1 there are exactly four chains on the boundary ([27, 28]). So assume that they both consist of letters of a single parity. In this case it is sufficient to show that a cyclic geodesic included word is the inner link path of a conjugacy chain then it is the inner link path of at most two conjugacy chains.

Suppose we are given a conjugacy chain with inner link path $w = w_1 \cdots w_n$ and chain word ava^{-1} , where $v = v_1 \cdots v_n$. Then $a^{-1}w_1$ and $w_n^{-1}a$ are pairs and so $w_i w_{i+1}$ and $v_i v_{i+1}$, where the indices are modulo n , are sister-sets. Interpreting this into the language of loops we see that the canonical loop l_w intersects regions of a single colour and consecutive intersection points of the loop occur in regions a distance of 2 apart. In particular, the first and last intersection points of l_w occur in regions w_1 and w_n a distance of two apart and the region a is adjacent to both of these regions. So either a , w_1 and w_n meet at a vertex with w_1 and w_n diagonally opposite to each other or they do not meet at a vertex and a is a region which shares edges with w_1 and w_n .

By section 3.11, we obtain the last and first intersection points of l_v from the last and first of l_w by a type 1 augmentation with respect to region a on an arc which contains the base point, carrying out two type 2 deformations and carrying out a type 1 reduction on the resulting intersection points (which occurs as the two final intersection points of the new loop). Note that since the link is alternating there are exactly two possible type 2 deformations. We examine the geometric consequences of these moves.

If the augmented link is the trivial link of two or more components there can be no chains. There are two cases remaining.

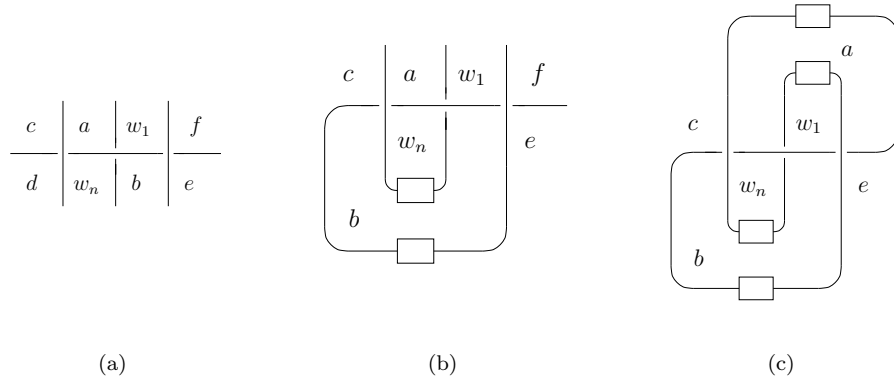

Figure 3.11: A diagram used in the proof of planarity.

Suppose first that the regions a , w_1 and w_n meet at a crossing. First consider the case indicated in figure 3.11(a). Since the canonical projection is elementary, a , b , w_1 and w_n are distinct regions. Then we have $w_n^{-1}w_1 = (w_n^{-1}a)(a^{-1}w_1) = (b^{-1}w_1)(c^{-1}d)$, by hypothesis this implies $b = d$. This means that there must be a sequence of edges as indicated in figure 3.11(b), where the boxes indicate the possibility of further knotting.

Now suppose that w is the inner link path of another conjugacy chain. This chain must have its chain word of the form bub^{-1} , for some word u , since a and b are the only regions distance one from w_1 and w_n . This chain gives $w_n^{-1}w_1 = (w_n^{-1}b)(b^{-1}w_1) = (f^{-1}e)(w_n^{-1}a)$, and hypothesis this implies that $a = f$ and the planar projection is of the form indicated in figure 3.11(c). Now since $a \neq b$ it is clear that there can be no more than two conjugacy chains.

The arguments for $w_nw_1^{-1}$, the other positions for a and for the opposite sign of the crossing are similar.

The second case is when the regions a , w_1 and w_n do not meet at a crossing. Consider the situation where the projection locally looks like figure 3.12(a) (note there are necessarily an even number of crossings with the edges of a in the boxes). Then $w_n^{-1}w_1 = (w_n^{-1}a)(a^{-1}w_1) = (e^{-1}b)(c^{-1}d)$, which by hypothesis implies that $b = c$.

Now suppose that w is the inner link path of another conjugacy chain. This chain must have its chain word of the form fuf^{-1} , for some word u . The the region f can only be positioned as in figure 3.12(b). This separates the part of the link on the left from the part of the link on the right of the projection as indicated in the figure. But this is impossible unless $b = c = f$, and by studying the figure it is clear that there are no more suitable regions in which to make a conjugacy chain. Thus there are at most two.

The arguments for $w_nw_1^{-1}$ and the opposite sign of crossings are similar. This completes the proof. □

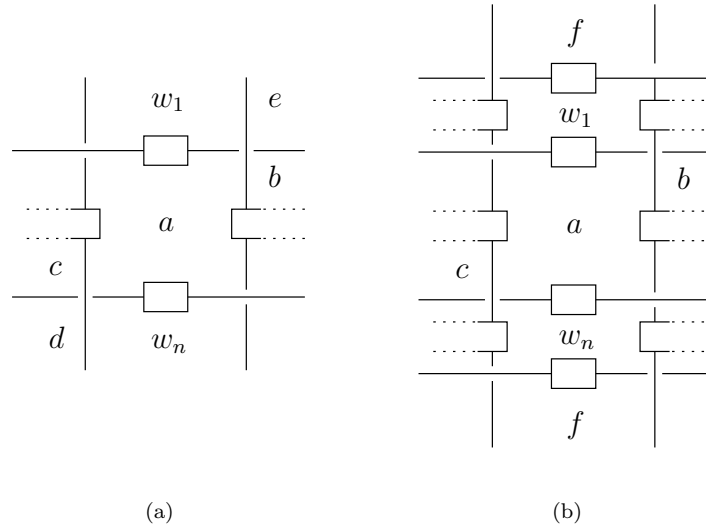

Figure 3.12: Another diagram used in the proof of planarity.

3.14 A New Proof that Alternating Links are Non-Trivial

There are several approaches in the literature for showing that alternating links are non-trivial - using the determinant in [4], the Alexander polynomial in [15] and [41], the Jones polynomial in [30], the Q-polynomial in [31] and geometrically in [38]. These proofs give varying degrees of intuition as to why the result holds. The argument presented here uses Dehn's lemma and the solvability of the word problem to show in a very direct way that spanning disks for the link can not exist giving a very intuitive feel for the non-triviality of alternating links. We prove:

Theorem 3.4. *If L is a link admitting a reduced, prime, alternating projection, then L is non-trivial.*

Note that since the connected sum of two non-trivial links is non-trivial restricting ourselves to prime links does not compromise the spirit of this section.

The i -th *double* of a link L is a parallel copy of the i -th component. We define the i -th longitude λ_i to be an element of the link group determined by the i -th double. Note that as in Chapter 1, our longitudes not necessarily null-homologous in the link complement. This is to simplify the argument and causes no real problems. The following piece of folklore is a consequence of Dehn's lemma and the loop theorem.

Folklore. *A link is trivial if and only if all of its longitudes are trivial in the link group.*

This reduces theorem 3.4 to solving the word problem for the longitudes of the link, which we shall do using small cancellation theory.

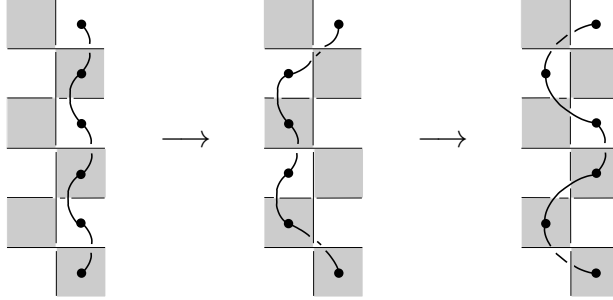

Figure 3.13: The argument of lemma 3.7.

Recall that the checker-board colouring of a link projection is an assignment of a colour black or white to each of the regions of the projection in such a way that adjacent regions are assigned a different colour.

Lemma 3.7. *The i -th double of an alternating link L is isotopic to a simple closed curve $J \subset S^3 - L$ such that, in terms of the projection, any “intersections” of J with white regions of the checker-board colouring occur before any “intersections” with black regions, with respect to a chosen base point and orientation.*

Proof. We work in terms of the alternating projection of the link L and its i -th double $D_i(L)$. We give the projection of L the checker-board colouring and look at the way that $D_i(L)$ intersects the regions.

First observe that $D_i(L)$ is a curve which travels parallel to the component of L and intersects adjacent regions of the projection. Choose a base point and orientation of $D_i(L)$ and label the intersection points of $D_i(L)$ with the regions v_1, \dots, v_n of the projection of L , where we travel in the direction of the orientation from the base point. We may assume that v_1 intersects a white region and therefore v_n intersects a black one. Since L is alternating we can fix the intersection points v_1 and v_n and isotope everything else so that v_2, \dots, v_{n-1} all lie in different regions (which are uniquely determined). Notice that v_2 now lies in a white region and v_{n-1} lies in a black region. Now fix v_2 and v_{n-1} and isotope so that v_3, \dots, v_{n-2} lie in different regions (in fact the regions they were originally in). This places v_3 in a white region and v_{n-2} in a black region. Repeating this process a finite number of times gives the required curve J .

This argument is embodied in figure 3.13. □

We can now prove the main result of this subsection.

*proof of theorem 3.4.*¹ By Lemma 3.7 and the geometric interpretation of the generators of the augmented Dehn presentation in section 3.5, the longitude can be represented by the conjugate of a non-empty word w which changes parity exactly once. Since the projection

¹16/11/05: This proof contains a small gap! See my paper *A new proof that alternating links are non-trivial* where this gap was plugged by a small extension of the argument.

is reduced, w is freely reduced. A word of this form can not contain a chain word (as these change parity twice) and since the augmented Dehn presentation is a $C''(4) - T(4)$ small cancellation group (lemma 3.2), the geodesic characterization theorem tells us that the longitudes are non-trivial. \square

Bibliography

- [1] K. I. Appel, *On the Conjugacy Problem for knot Groups*, Math. Z. **138** (1974), 273-294.
- [2] K. I. Appel and P.E. Schupp, *The Conjugacy Problem for the Group of any Tame Alternating Knot is Solvable*, Proc. Am. Math. Soc. **33** (1972), 329-336.
- [3] K. I. Appel and P.E. Schupp, *Artin Groups and Infinite Coxeter Groups*, Invent. Math. **72** (1983), 203-220.
- [4] C. Bankwitz, *Über die Torsionszahlen der alternierenden Knoten*, Math. Ann. **103** (1930), 145-161.
- [5] D. Bar-Natan, *On the Vassiliev knot invariants*, Topology **34** (1995), 423-472.
- [6] D. Bar-Natan, *Vassiliev homotopy string link invariants*, J. Knot. Theory Ramifications **4** (1995), 13-32.
- [7] D. Bar-Natan, S. Garoufalidis, L. Rozansky and D. P. Thurston, *The Århus integral of rational homology 3-spheres. I. A highly non trivial flat connection on S^3* , Selecta Math. (N.S.) **8** (2002), 315-339.
- [8] D. Bar-Natan, S. Garoufalidis, L. Rozansky and D. P. Thurston, *The Århus integral of rational homology 3-spheres. II. Invariance and universality*, Selecta Math. (N.S.) **8** (2002), 341-371.
- [9] D. Bar-Natan, S. Garoufalidis, L. Rozansky and D. P. Thurston, *The Århus integral of rational homology 3-spheres III: The Relation with the Le-Murakami-Ohtsuki Invariant*, preprint.
- [10] D. Bar-Natan, T. T. Q. Le and D. P. Thurston, *Two applications of elementary knot theory to Lie algebras and Vassiliev invariants*, Geom. Topol. **7** (2003), 1-31.
- [11] R. Benedetti and C. Petronio, *Lectures on Hyperbolic Geometry*, Springer-Verlag, Berlin (1992).
- [12] M. R. Bridson and A. Haefliger, *Metric Spaces of Non-Positive Curvature*, Springer-Verlag, Berlin (1999).

- [13] K. S. Brown, *Cohomology of Groups*, Graduate Texts in Mathematics **87**, Springer-Verlag, New York, 1994.
- [14] A. J. Casson, *Link cobordism and Milnor's invariant*, Bull. London Math. Soc. **7** (1975), 39-40.
- [15] R. H. Crowell, *Genus of alternating link types*, Ann. of Math. **69** (1959), 258-275.
- [16] M. J. Dugopolski, *A New Solution to the Word Problem in the Fundamental Groups of Alternating Knots and Links*, Trans. Am. Math. Soc. **272** (1982), 375-382.
- [17] D. B. A. Epstein, J. W. Cannon, D. F. Holt, S. V. F. Silvio, M. S. Paterson and W. P. Thurston, *Word Processing in Groups*, Jones and Bartlett, Boston, MA (1992).
- [18] B. D. Evans, *The conjugacy problem for boundary loops in 3-manifolds*, Trans. Am. Math. Soc. **240** (1978), 53-64.
- [19] S. Garoufalidis and J. Levine, *Tree-level invariants of three-manifolds, Massey products and the Johnson homomorphism*, preprint.
- [20] S. M. Gersten and H. Short, *Small Cancellation Theory and Automatic Groups*, Invent. Math. **102** (1990), 305-334.
- [21] S. M. Gersten and H. Short, *Small Cancellation Theory and Automatic Groups: Part II*, Invent. Math. **105** (1991), 641-662.
- [22] N. Habegger, *Milnor, Johnson and Tree Level Perturbative Invariants*, preprint.
- [23] N. Habegger and K. E. Orr, *Milnor link invariants and quantum 3-manifold invariants*, Comment. Math. Helv. **74** (1999), 322-344.
- [24] N. Habegger and G. Masbaum, *The Kontsevich Integral and Milnor's Invariants*, Topology **39** (2000), 1253-1289.
- [25] D. M. Jackson, I. Moffatt and A. Morales, in preparation.
- [26] K. Johnsgard, *The Structure of the Cayley Complex and a Cubic-time Algorithm for solving the conjugacy Problem for Groups of Prime Alternating Knots*, Univ. Illinois-Urbana-Champaign: Ph. D. thesis, 1993.
- [27] K. Johnsgard, *The Conjugacy Problem for Groups of Alternating Prime Tame Links is Polynomial-time*, Trans. Am. Math. Soc. **349** (1997), 857-901.
- [28] K. Johnsgard, *Geodesic Edge paths in Nonpositively curved complexes*, J. Pure Appl. Algebra, **147**, (2000), 59-93.
- [29] I. Kapovich, *Small Cancellation Groups and Translation Numbers*, Trans. Am. Math. Soc. **349** (1997), 1851-1875.

- [30] L. H. Kauffman, *State Models and the Jones Polynomial*, *Topology* **26** (1987), 395-407.
- [31] M. Kidwell, *On the degree of the Brandt-Lickorish-Millet-Ho polynomial of a link*, *Proc. Amer. Math. Soc.* **100** (1987), 755-762.
- [32] T.T.Q. Le, H. Murakami and T. Ohtsuki, *On a universal perturbative invariant of 3-manifolds*, *Topology* **37** (1998), 539-574
- [33] T. T. Q. Le, H. Murakami, J. Murakami and T. Ohtsuki, *A three-manifold invariant via the Kontsevich integral*, *Osaka J. Math.* **36** (1999), 365-395.
- [34] X. S. Lin, *Power series expansions and invariants of links*, In *Geometric Topology* (Athens, GA, 1993), volume 2 of AMS/IP stud. Adv. Math., pages 184-202. Amer. Math.Soc, Providence, RI, 1997.
- [35] R. C. Lyndon and P.E. Schupp, *Combinatorial Group Theory*, Springer-Verlag, Berlin (1977).
- [36] W. Magnus, A. Karass and D. Solitar, *Combinatorial Group Theory*, Dover Publications Inc., New York (1976).
- [37] W. Menasco, *Closed Incompressible Surfaces in Alternating Link Complements*, *Topology* **23** (1984), 37-44.
- [38] W. Menasco and M. B. Thistlethwaite, *A geometric proof that alternating knots are non-trivial*, *Math. Proc. Camb. Phil. Soc.* **109** (1991), 425-431.
- [39] J. Milnor, *Link Groups*, *Ann. of Math.* **59** (1954), 177-195.
- [40] J. Milnor, *Isotopy of Links*, In *Algebraic Geometry and Topology: A symposium in honour of S. Lefschetz*, Princeton University Press, Princeton, NJ, (1957), 208-306.
- [41] K. Murasugi, *On the genus of the alternating knot II*, *J. Math. Soc. Japan* **10** (1958), 235-248.
- [42] L. P. Neuwirth, *Knot Groups*, *Annals of Mathematical Studies No. 56*, Princeton University Press, Princeton, N.J. (1965).
- [43] C. Petronio, *An Algorithm Producing Hyperbolicity Equations for a Link Complement in S^3* , *Geom. Dedicata* **44** (1992), 67-104
- [44] H. Schubert, *Die eindeutige Zerlegbarkeit eines Knotens in Primknoten*, *Sitzungsber. Heidelberger Akad. Wiss. Math.-Natur. Kl.* **1949** (3), 57-104
- [45] J. Stallings, *Homology and Central Series of Groups*, *J. Algebra* **2** (1965), 170-181.
- [46] T. Stanford, *Braid commutators and Vassiliev invariants*, *Pacific J. Math.* **174** (1996), 269-276.

- [47] F. Waldhausen, *The Word Problem in Fundamental Groups of Sufficiently Large Irreducible 3-Manifolds*, Ann. of Math. **88** (1968), 272-280.
- [48] C. M. Weinbaum, *The Word and Conjugacy problems for the Knot Group of any Tame Prime Alternating Knot*, Proc. Am. Math. Soc. **30** (1971), 22-26.
- [49] D. T. Wise, *Non-positively Curved Squared Complexes, Aperiodic Tilings and Non-residually Finite Groups*, Princeton Univ.: Ph. D. thesis, 1996.