

# Classification of $n$ -component Brunnian links up to $C_n$ -move

Haruko Aida MIYAZAWA \*

Research Institute for Mathematics and Computer Science,  
Tsuda College  
Kodaira, Tokyo 187-8577, Japan  
e-mail: aida@tsuda.ac.jp

Akira YASUHARA

Department of Mathematics, Tokyo Gakugei University  
Nukuikita 4-1-1, Koganei, Tokyo 184-8501, Japan  
e-mail: yasuhara@u-gakugei.ac.jp

## ABSTRACT

We give a classification of  $n$ -component links up to  $C_n$ -move. In order to prove this classification, we characterize Brunnian links, and have that a Brunnian link is ambient isotopic to a band sum of trivial link and Milnor's links.

## 1. Introduction

A *tangle*  $T$  is a disjoint union of properly embedded arcs in the unit 3-ball  $B^3$ . A tangle  $T$  is *trivial* if there exists a properly embedded disk in  $B^3$  that contains  $T$ . A *local move* is a pair of trivial tangles  $(T_1, T_2)$  with  $\partial T_1 = \partial T_2$  such that for each component  $t$  of  $T_1$  there exists a component  $u$  of  $T_2$  with  $\partial t = \partial u$ . Two local moves  $(T_1, T_2)$  and  $(U_1, U_2)$  are *equivalent* if there is an orientation preserving self-homeomorphism  $\psi : B^3 \rightarrow B^3$  such that  $\psi(T_i)$  and  $U_i$  are ambient isotopic in  $B^3$  relative to  $\partial B^3$  for  $i = 1, 2$ . The definition of a local move follows from [12], [11].

A  $C_1$ -*move* is a local move  $(T_1, T_2)$  as illustrated in Fig. 1. Suppose that a  $C_k$ -move is defined. Let  $(T_1, T_2)$  be a  $C_k$ -move,  $t_1$  a component of  $T_1$  and  $t_2$  a component of  $T_2$  with  $\partial t_1 = \partial t_2$ . Let  $N_i$  ( $i = 1, 2$ ) be regular neighbourhoods of  $t_i$  in  $(B^3 - T_i) \cup t_i$  such that  $N_1 \cap \partial B^3 = N_2 \cap \partial B^3$ . Let  $\alpha$  be a disjoint union of properly embedded arcs in  $B^2 \times I$  as illustrated in Fig. 2. Let  $\psi_i : B^2 \times I \rightarrow N_i$  be a homeomorphism with  $\psi_i(B^2 \times \{0, 1\}) = N_i \cap \partial B^3$  for  $i = 1, 2$ . Suppose that  $\psi_1(\partial\alpha) = \psi_2(\partial\alpha)$  and that  $\psi_1(\alpha)$  and  $\psi_2(\alpha)$  are ambient isotopic in  $B^3$  relative to  $\partial B^3$ . Then we say that a local move  $((T_1 - t_1) \cup \psi_1(\alpha), (T_2 - t_2) \cup \psi_2(\alpha))$  is a  $C_{k+1}$ -*move*. Note that, for each natural number  $k$ , there are finitely many  $C_k$ -moves up to equivalence. It is easy to see that if  $(T_1, T_2)$  is

---

\*The first author is partially supported by the 21st COE program "Constitution of wide-angle mathematical basis focused on knots".

2000 *Mathematics Subject Classification*: Primary 57M25

*Keywords and Phrases*:  $C_n$ -move, Brunnian link, link homotopy

a  $C_k$ -move, then  $(T_2, T_1)$  is equivalent to a  $C_k$ -move. The *one-branched  $C_k$ -move* is a local move as illustrated in Fig. 3. It is shown that a  $C_k$ -move is generated by the one-branched  $C_k$ -move [3], [11]. So the one-branched  $C_k$ -move is often called the  $C_k$ -move. The definition of  $C_k$ -move is due to Habiro [3], [4].

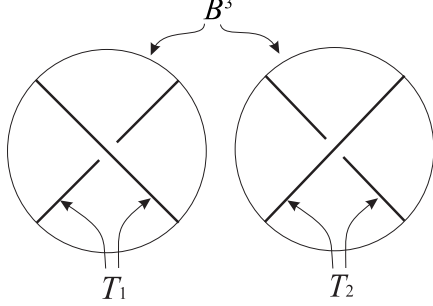

Fig. 1

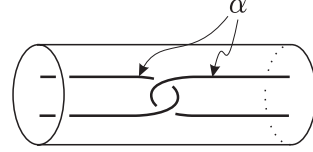

Fig. 2

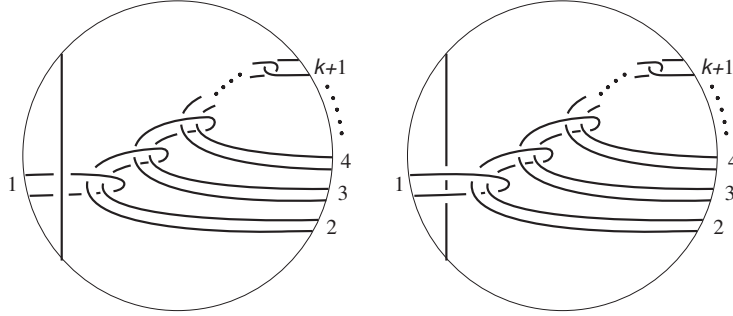

Fig. 3

Let  $L_1 = K_{11} \cup \dots \cup K_{1n}$  and  $L_2 = K_{21} \cup \dots \cup K_{2n}$  be oriented ordered  $n$ -component links (or ordered  $n$ -component tangle) in  $S^3$ , and let  $(T_1, T_2)$  be a local move. Suppose that there is an orientation preserving embedding  $h : B^3 \rightarrow S^3$  such that  $(h^{-1}(L_1), h^{-1}(L_2)) \cong (T_1, T_2)$  and  $L_1 - h(B^3) = L_2 - h(B^3)$  together with orientations and orders. Then  $L_2$  is said to be *obtained from  $L_1$  by  $(T_1, T_2)$* . And the set  $\{l | h(B^3) \cap K_{1l} \neq \emptyset\} (= \{l | h(B^3) \cap K_{2l} \neq \emptyset\})$  is the index of  $(T_1, T_2)$ . We call a (one-branched)  $C_k$ -move ( $k < n$ ) is (one-branched)  $d$ - $C_k$ -move, if the number of elements of the index is equal to  $k + 1$ .

Two oriented ordered links  $L_1$  and  $L_2$  are  $C_k$ -equivalent (resp.  $d$ - $C_k$ -equivalent, one-branched  $d$ - $C_k$ -equivalent) if  $L_2$  is obtained from  $L_1$  by a finite sequence of  $C_k$ -moves (resp.  $d$ - $C_k$ -moves, one-branched  $d$ - $C_k$ -moves) and ambient isotopies. These relations are equivalence relations.

A link is called *Brunnian* (or *almost trivial* [6]) if the proper sublinks of it are all trivial. The following proposition gives a characterization of Brunnian links.

**Proposition 1.1.** *Let  $L$  be an  $n$ -component link ( $n \geq 2$ ). The following conditions are mutually equivalent.*

- (1)  $L$  is a Brunnian link.
- (2)  $L$  is  $d$ - $C_{n-1}$ -equivalent to a trivial link.
- (3)  $L$  is one-branched  $d$ - $C_{n-1}$ -equivalent to a trivial link.

**Remarks.** (1) This proposition implies that an  $n$ -component Brunnian link is ambient isotopic to a *band sum* of a trivial link and the  $n$ -component *Milnor's link*. We will mention that more precisely in the next section (Proposition 2.3).

(2) Propositions 1.1 and 2.3 are also shown by Habiro [5] independently.

Two links are *link-homotopic* [6], if they are transformed into each other by a finite sequence of self crossing change and ambient isotopies. J. Milnor gave a classification theorem for Brunnian links up to link homotopy by using his  $\mu$ -invariants [6]. In this paper, we have

**Theorem 1.2.** *Two  $n$ -component Brunnian links  $L$  and  $L'$  are  $C_n$ -equivalent if and only if they are link-homotopic.*

**Remarks.** (1) Since for  $k < n$ , the  $C_n$ -equivalence implies the  $C_k$ -equivalence, by Proposition 1.1,  $n$ -component Brunnian links are  $C_k$ -equivalent to a trivial link if  $k < n$ .

(2) A  $C_2$ -move is equal to the *delta-move* defined by H. Murakami and Y. Nakanishi [7]. The  $C_2$ -equivalence can be classified by the linking number [7]. A  $C_3$ -move is equal to the *clasp-pass move* defined by Habiro [2]. Classifications for 3-component links and for algebraically split links up to  $C_3$ -move are given by K. Taniyama and the second author [10].

## 2. Band description of a link

From now on we consider links up to ambient isotopy of  $S^3$  and tangles up to ambient isotopy of  $B^3$  relative to  $\partial B^3$  without explicit mention.

In order to prove Proposition 1.1 and Theorem 1.2, we need the *band description* of a link defined in [11]. See also [8], [13], [14], [12]. A  $C_1$ -link model is a pair  $(\alpha, \beta)$  where  $\alpha$  is a disjoint union of properly embedded arcs in  $B^3$  and  $\beta$  is a disjoint union of arcs on  $\partial B^3$  with  $\partial\alpha = \partial\beta$  as illustrated in Fig. 4. Suppose that a  $C_k$ -link model  $(\alpha, \beta)$  is defined where  $\alpha$  is a disjoint union of  $k+1$  properly embedded arcs in  $B^3$  and  $\beta$  is a disjoint union of  $k+1$  arcs on  $\partial B^3$  with  $\partial\alpha = \partial\beta$  such that  $\alpha \cup \beta$  is a disjoint union of  $k+1$  circles. Let  $\gamma$  be a component of  $\alpha \cup \beta$  and  $W$  a regular neighbourhood of  $\gamma$  in  $(B^3 - (\alpha \cup \beta)) \cup \gamma$ . Let  $V$  be an oriented solid torus,  $D$  a disk in  $\partial V$ ,  $\alpha_0$  properly embedded arcs in  $V$  and  $\beta_0$  arcs on  $D$  as illustrated in Fig. 5. Let  $\psi : V \rightarrow W$  be an orientation preserving homeomorphism such that  $\psi(D) = W \cap \partial B^3$  and  $\psi(\alpha_0 \cup \beta_0)$  bounds disjoint disks in  $B^3$ . Then we call the pair  $((\alpha - \gamma) \cup \psi(\alpha_0), (\beta - \gamma) \cup \psi(\beta_0))$  a  $C_{k+1}$ -link model.

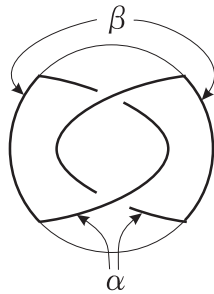

Fig. 4

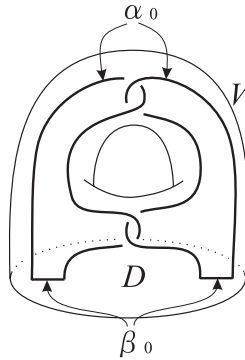

Fig. 5

Let  $(\alpha_i, \beta_i)$  be  $C_{\rho(i)}$ -link models ( $i = 1, \dots, l$ ). Let  $L = K_1 \cup \dots \cup K_n$  be an oriented link (resp. a tangle). Let  $\psi_i : B^3 \rightarrow S^3$  (resp.  $\psi_i : B^3 \rightarrow \text{int}B^3$ ) be an orientation preserving embedding for  $i = 1, \dots, l$  and  $b_{1,1}, b_{1,2}, \dots, b_{1,\rho(1)+1}, b_{2,1}, b_{2,2}, \dots, b_{2,\rho(2)+1}, \dots, b_{l,1}, b_{l,2}, \dots, b_{l,\rho(l)+1}$  mutually disjoint disks embedded in  $S^3$  (resp.  $B^3$ ). Suppose that they satisfy the following conditions;

- (1)  $\psi_i(B^3) \cap \psi_j(B^3) = \emptyset$  if  $i \neq j$ ,
- (2)  $\psi_i(B^3) \cap L = \emptyset$  for each  $i$ ,
- (3)  $b_{i,k} \cap L = \partial b_{i,k} \cap L$  is an arc for each  $i, k$ ,
- (4)  $b_{i,k} \cap (\bigcup_{j=1}^l \psi_j(B^3)) = \partial b_{i,k} \cap \psi_i(B^3)$  is a component of  $\psi_i(\beta_i)$  for each  $i, k$ .

Let  $L'$  be an oriented link (resp. a tangle) defined by

$$L' = L \cup \left( \bigcup_{i,k} \partial b_{i,k} \right) \cup \left( \bigcup_{i=1}^l \psi_i(\alpha_i) \right) - \bigcup_{i,k} \text{int}(\partial b_{i,k} \cap L) - \bigcup_{i=1}^l \psi_i(\text{int}\beta_i),$$

where the orientation of  $L'$  coincides that of  $L$  on  $L - \bigcup_{i,k} b_{i,k}$  if  $L$  is oriented. We call each  $b_{i,k}$  a *band*. We set  $\mathcal{B}_i = ((\alpha_i, \beta_i), \psi_i, \{b_{i,1}, \dots, b_{i,\rho(i)+1}\})$  and call  $\mathcal{B}_i$  a  $C_{\rho(i)}$ -*chord*. The set  $\{l | K_l \cap \{b_{i,1}, b_{i,2}, \dots, b_{i,\rho(i)+1}\} \neq \emptyset\}$  is called the *index* of  $\mathcal{B}_i$ . We denote  $L'$  by  $L' = \Omega(L; \{\mathcal{B}_1, \dots, \mathcal{B}_l\})$ , and say that  $L'$  is a *band sum* of  $L$  and chords  $\mathcal{B}_1, \dots, \mathcal{B}_l$  or a *band sum* of  $L$  and  $\{\mathcal{B}_1, \dots, \mathcal{B}_l\}$ .

A  $C_k$ -link model  $(\alpha, \beta)$  illustrated in Fig. 6 is called the *one-branched  $C_k$ -link model*. And a  $C_k$ -chord is called the *one-branched  $C_k$ -chord* if its link model is the one-branched  $C_k$ -link model. Note that  $\alpha \cup \beta \subset S^3$  is the  $(k+1)$ -component Milnor's link [6, Fig. 7].

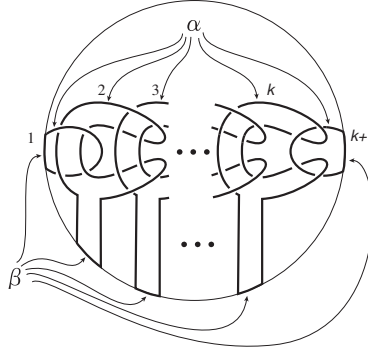

Fig. 6

By the arguments similar to that in the proofs of Lemmas 3.6 and 3.8 in [11], we have the following two lemmas respectively.

**Lemma 2.1.** (cf. [11, Lemma 3.6]) *A link  $L'$  is obtained from  $L$  by (one branched)  $C_{k_i}$ -moves with indices  $I_i$  ( $i = 1, \dots, m$ ) if and only if  $L'$  is a band sum of  $L$  and (one branched)  $C_{k_i}$ -chords with indices  $I_i$  ( $i = 1, \dots, m$ ).  $\square$*

**Lemma 2.2.** (cf. [11, Lemma 3.8]) *Let  $L = K_1 \cup \dots \cup K_n$ ,  $J = \Omega(L; \{\mathcal{B}\})$  and  $J' = \Omega(L; \{\mathcal{B}'\})$  be oriented links, where  $\mathcal{B}, \mathcal{B}'$  are  $C_k$ -chords with indices  $I$ . Suppose that  $J$  and  $J'$  differ locally as illustrated in Fig. 7 (a), (b), i.e.,  $J'$  is obtained from  $J$  by a crossing change between  $K_i$  and a band of the  $C_k$ -chord  $\mathcal{B}$ . Then  $J'$  is obtained from  $J$  by a  $C_{k+1}$ -move with index  $I \cup \{i\}$ .  $\square$*

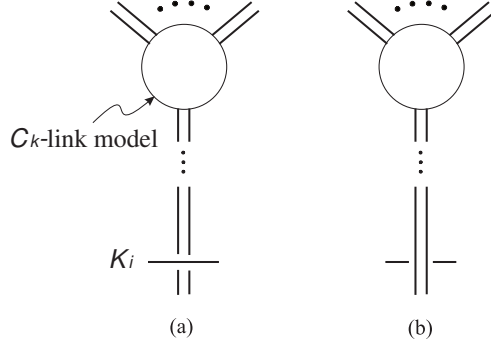

Fig. 7

Thus by combining Proposition 1.1 and Lemma 2.1, we have

**Proposition 2.3** *An  $n$ -component Brunnian link is a band sum of a trivial link and some one-branched  $C_{n-1}$ -chords with indices  $\{1, \dots, n\}$ .  $\square$*

### 3. Proofs of Proposition 1.1 and Theorem 1.2

A local move  $(T_1, T_2)$  is *trivial*, if  $(T_1, T_2)$  is equivalent to a local move  $(T_1, T_1)$ . Let  $(T_1, T_2)$  be a local move, and let  $t_1, t_2, \dots, t_k$  and  $u_1, u_2, \dots, u_k$  be the components with  $\partial t_i = \partial u_i$  ( $i = 1, 2, \dots, k$ ) of  $T_1$  and  $T_2$  respectively. We call  $(T_1, T_2)$  a  *$k$ -component Brunnian local move* ( $k \geq 2$ ), if each local move  $(T_1 - t_i, T_2 - u_i)$  is trivial ( $i = 1, 2, \dots, k$ ) [9]. It is easy to see that a  $C_k$ -move is a  $(k + 1)$ -component Brunnian local move.

**Proof of Proposition 1.1.** A proof of ‘(2) $\Leftrightarrow$ (3)’ follows the proof of Lemma 2.2 in [11]. Since a  $C_{n-1}$ -move is an  $n$ -component Brunnian local move, a  $d$ - $C_{n-1}$ -move preserves link types for any proper sublink of an  $n$ -component link. Thus we have ‘(2) $\Rightarrow$ (1)’.

We will show ‘(1) $\Rightarrow$ (2)’. Suppose that  $L = K_1 \cup \dots \cup K_n$  is an  $n$ -component Brunnian link. Since  $L - K_1$  is a trivial link, there is a link diagram  $\widetilde{L} = \widetilde{K}_1 \cup \dots \cup \widetilde{K}_n$  such that  $\widetilde{K}_2 \cup \dots \cup \widetilde{K}_n$  has no crossings.

Since  $\widetilde{L} - K_2$  is trivial,  $L$  is obtained from a trivial link by crossing changes between  $\widetilde{K}_1$  and  $\widetilde{K}_2$ . Since crossing change between  $K_1$  and  $K_2$  is a  $C_1$ -move with index  $\{1, 2\}$ , by Lemma 2.1,  $L$  is a band sum  $\Omega(O; \mathbf{B}_1)$  of a trivial link  $O = O_1 \cup \dots \cup O_n$  and a set  $\mathbf{B}_1$  of  $C_1$ -chords with indices  $\{1, 2\}$ .

Since  $\Omega(O; \mathbf{B}_1) - O_3 (= L - K_3)$  is trivial,  $L$  is obtained from a trivial link by crossing changes between  $O_3$  and some bands of the  $C_1$ -chords. By Lemmas 2.1 and 2.2,  $L$  is a band sum  $\Omega(O; \mathbf{B}_2)$  of a trivial link  $O = O_1 \cup \dots \cup O_n$  and a set  $\mathbf{B}_2$  of  $C_2$ -chords with indices  $\{1, 2, 3\}$ .

Note that  $\Omega(O; \mathbf{B}_2) - O_4$  is trivial. Repeating these processes, we have that  $L$  is a band sum  $\Omega(O; \mathbf{B}_{n-1})$  of a trivial link  $O$  and a set  $\mathbf{B}_{n-1}$  of  $C_{n-1}$ -chords with indices  $\{1, \dots, n\}$ . Hence, by Lemma 2.1,  $L$  is  $d$ - $C_{n-1}$ -equivalent a trivial link.  $\square$

**Proof of Theorem 1.2.** Suppose an  $n$ -component link  $L'$  is obtained from an  $n$ -component link  $L$  by a single  $C_n$ -move. Then there is an embedding  $h : B^3 \rightarrow S^3$  such that  $(h^{-1}(L), h^{-1}(L'))$  is a  $C_n$ -move. Since the tangles of  $C_n$ -move are  $(n + 1)$ -component, there are two components  $s, t$  of  $h(B^3) \cap L$  (resp.  $s', t'$  of  $h(B^3) \cap L'$ ) with  $\partial s = \partial s'$   $\partial t = \partial t'$

such that  $s$  and  $t$  are contained in a single component of  $L$  (resp.  $s'$  and  $t'$  are contained in a single component of  $L'$ ). Since  $C_n$ -move is  $(n + 1)$ -component Brunnian local move, we may assume  $(h^{-1}(L), h^{-1}(L'))$  has a diagram in the unit disk such that  $h^{-1}(L)$  has no crossings and that  $h^{-1}(L' - s')$  has no crossings. Since  $(h^{-1}(L - t), h^{-1}(L' - t'))$  is trivial local move,  $h^{-1}(L)$  is obtained from  $h^{-1}(L')$  by crossing changes between  $s'$  and  $t'$ . This implies  $L$  and  $L'$  are link homotopic. So the proof of ‘if’ part completes.

We will show ‘only if’ part. Suppose that  $L' = K_1 \cup \dots \cup K_n$  is link-homotopic to  $L$ . Since a self crossing change is a  $C_1$ -move with index  $\{i\}$  for some  $i \in \{1, \dots, n\}$ , then by Lemma 2.1,  $L'$  is a band sum of  $L$  and  $C_1$ -chords with indices  $\{i\}$  ( $i \in \{1, \dots, n\}$ ). Since  $L$  is Brunnian, by Proposition 1.1,  $L$  is a band sum  $\Omega(O; \mathbf{B}_{n-1})$  of a trivial link  $O = O_1 \cup \dots \cup O_n$  and a set  $\mathbf{B}_{n-1}$  of  $C_{n-1}$ -chords with indices  $\{1, \dots, n\}$ . By Sublemma 3.5 in [11],  $L'$  is a band sum of  $O$  and  $C_1$ -chords with indices  $\{i\}$ , the set  $\mathbf{B}_{n-1}$  of  $C_{n-1}$ -chords.

**Step 1:** Since  $L' - K_1$  is a trivial link, by Lemma 2.2,  $L'$  is obtained from a trivial link by the following moves;

- (1)  $C_1$ -moves with indices  $\{1\}$  that correspond to  $C_1$ -chords with indices  $\{1\}$ ,
- (2)  $C_2$ -moves with indices  $\{1, j\}$  ( $j \geq 2$ ) that correspond to crossing change between  $O_1$  and bands of  $C_1$ -chords with indices  $\{j\}$ ,
- (3) d- $C_{n-1}$ -moves correspond to  $\mathbf{B}_{n-1}$ .

Thus, by Lemma 2.1, we have that  $L'$  is a band sum of  $O$  and a set  $\mathbf{B}_1$  of  $C_1$ -chords with indices  $\{1\}$ , a set  $\mathbf{B}_2$  of  $C_2$ -chords with indices  $\{1, j\}$ , and  $\mathbf{B}_{n-1}$ .

**Step 2** Since  $L' - K_2$  is a trivial link, by Lemma 2.2,  $L' = \Omega(O; \mathbf{B}_1 \cup \mathbf{B}_2 \cup \mathbf{B}_{n-1})$  is obtained from a trivial link by the following moves;

- (1)  $C_2$ -moves with indices  $\{1, 2\}$  that correspond to  $C_2$ -chords with indices  $\{1, 2\}$  or crossing change between  $O_2$  and bands of  $C_1$ -chords with indices  $\{1\}$ ,
- (2)  $C_3$ -moves with indices  $\{1, 2, j\}$  ( $j \geq 3$ ) that correspond to crossing change between  $O_2$  and bands of  $C_2$ -chords with indices  $\{1, j\}$ ,
- (3) d- $C_{n-1}$ -moves correspond to  $\mathbf{B}_{n-1}$ .

Thus, by Lemma 2.1, we have that  $L'$  is a band sum of  $O$  and a set of  $C_2$ -chords with indices  $\{1, 2\}$ , a set of  $C_3$ -chords with indices  $\{1, 2, j\}$ , and  $\mathbf{B}_{n-1}$ .

Note that  $L' - K_3$  is trivial. Repeating these processes to Step  $n$ , we have that  $L'$  is obtained from a trivial link by  $C_n$ -moves with indices  $\{1, \dots, n\}$  and d- $C_{n-1}$ -moves correspond to  $\mathbf{B}_{n-1}$ . So  $L'$  is  $C_n$ -equivalent to a band sum of  $O$  and  $\mathbf{B}_{n-1}$ . This band sum may not be same as the band sum  $L = \Omega(O; \mathbf{B}_{n-1})$ . Since a small regular neighborhood of the bands and the link balls of  $\mathbf{B}_{n-1}$  are fixed in each step, by Lemma 2.2, these band sums are  $C_n$ -equivalent. This completes the proof.  $\square$

#### 4. $C_n$ -move and Brunnian local move

It is known that a  $C_n$ -move is an  $(n + 1)$ -component Brunnian local move, and that a Brunnian local move preserves Vassiliev invariants of order  $\leq n - 1$ . Goussarov-Habiro Theorem [2] [1] implies that two knots are  $C_n$ -equivalent if and only if their values of any Vassiliev invariants of order  $\leq n - 1$  are same. So, if two knots are equivalent up to  $(n + 1)$ -component Brunnian local moves, then they are  $C_n$ -equivalent. For links with two or more components, Goussarov-Habiro Theorem does not hold. Here, we consider a

relation between  $C_n$ -move and  $(n + 1)$ -component Brunnian local moves.

By the arguments similar to that in the proof of Proposition 1.1, we have the following. As we mentioned in the remark of Proposition 1.1, this is also shown by Habiro [5] independently.

**Proposition 4.1.** *Let  $(T_1, T_2)$  be an  $n$ -component Brunnian local move ( $n \geq 2$ ). Then  $T_2$  is obtained from  $T_1$  by a finite sequence of (one-branched)  $d$ - $C_{n-1}$ -moves.*

## References

1. M. N. Gusarov, Variations of knotted graphs. The geometric technique of  $n$ -equivalence. (Russian) *Algebra i Analiz* **12** (2000), 79-125; translation in *St. Petersburg Math. J.* **12** (2001), 569-604
2. K. Habiro, Clasp-pass moves on knots, unpublished, 1993.
3. K. Habiro, Aru musubime no kyokusyo sousa no zoku ni tuite (in Japanese), Master thesis in Tokyo University, 1994.
4. K. Habiro, Claspers and finite type invariants of links, *Geom. Topol.*, **4** (2000). 1-83.
5. K. Habiro, Brunnian links, claspers and Goussarov-Vassiliev finite type invariants, preprint.
6. J. Milnor, Link groups, *Ann. Math.*, **59** (1954), 177-195.
7. H. Murakami and Y. Nakanishi, On a certain move generating link-homology, *Math. Ann.*, **284** (1989), 75-89.
8. S. Suzuki, Local knots of 2-spheres in 4-manifolds, *Proc. Japan Acad.*, **45** (1969), 34-38.
9. K. Taniyama and A. Yasuhara, Realization of knots and links in a spatial graph, *Topology Appl.*, **112** (2001), 87-109
10. K. Taniyama and A. Yasuhara, Clasp-pass move on knots, links and spatial graphs, *Topology Appl.*, **122** (2002), 501-529.
11. K. Taniyama and A. Yasuhara, Band description of knots and Vassiliev invariants, *Math. Proc. Cambridge Philos. Soc.*, **133** (2002), 325-343.
12. K. Taniyama and A. Yasuhara, Local moves on spatial graphs and finite type invariants, *Pacific J. Math.* **211** (2003), 183-200.
13. M. Yamamoto, Knots in spatial embeddings of the complete graph on four vertices, *Topology Appl.*, **36** (1990), 291-298.
14. A. Yasuhara, Delta-unknotted operation and adaptability of certain graphs, *Proceedings of Knots 96*, S. Suzuki (ed.), World Sci. Publ. Co., 115-121, 1997.