

Some Combinatorial Aspects of Movies and Movie-moves in the Theory of Smoothly Knotted Surfaces in \mathbb{R}^4

Glenn Lancaster
DePaul University
Chicago, Illinois

Richard Larson
University of Illinois at Chicago
Chicago, Illinois

Jacob Towber
DePaul University
Chicago, Illinois

February 7, 2018

1 Introduction

Throughout this paper, by a *knotted surface* (or, synonymously, *2-knot*) will always be meant a *smooth* embedding in \mathbb{R}^4 of a compact 2-manifold M (where M is smooth, not necessarily connected, and is not assigned an orientation.)¹ By *isotopy* of two such smoothly knotted surfaces in \mathbb{R}^4 , will be meant smooth ambient isotopy.

There is a beautiful combinatorial description of the isotopy-classes of such smooth knotted surfaces in \mathbb{R}^4 , via the "doubly time-oriented movies" of Carter, Rieger and Saito ([CRS]), explained below in § 2.3. Putting all this in a more general context, the collection of smooth isotopy classes of knotted surfaces is a portion of the collection of "*two-tangles*", whose intricate structure (that of a "free braided monoidal 2-category with duals") has been elucidated by the work of Fischer ([F]), Kharlamov and Turaev ([KT]) Baez and Neuchl ([BN]) and especially in the recent work of Baez and Lang-

¹While there are also highly non-trivial questions concerning smooth embeddings of such M in \mathbb{R}^5 , the present paper will study *only* smooth embeddings in \mathbb{R}^4 . For $n \geq 6$, any two smoothly knotted surfaces in \mathbb{R}^n are smoothly ambient isotopic, so this third case is without further interest. The analogous theories of 2-knots in the PL- and continuous categories, are not studied in the present paper.

ford ([BL], and [LL]). Indeed, the method of CRS movies comes into its own, only with the extension to 2-tangles.

This theory of movies involves a remarkable interplay between low-dimensional differential topology, combinatorics, quantum groups and 2-category theory. In the present paper (except for a few elementary topological remarks, in §2.1, reviewing the classical theory of knotted curves in \mathbb{R}^3), we confine our attention strictly to the **combinatorial** portion of this theory—i.e., the portion related to such concepts as elementary transitions, flickers, and Carter-Rieger-Saito movies, explained in §2.2 and §2.3—and also the combinatorial concept of movie-moves, explained in §2.5 and §2.6.

The material which presents itself for study when we thus focus our attention, is divided in the present paper into the three following portions (in Sections 2, 3, 4 respectively).

In Section 2 of the present paper, we review the combinatorial portion of the material on movies in [CS2], [CRS], [LL] and [BL]. While this represents only a small portion of the full theory of these movies, these combinatorial movies, and the operations on them which occur naturally in this paper, form an intricate structure which it may be worthwhile disentangling from the existing literature.

In Section 2, this material is analyzed in an extremely detailed way. This level of detail is necessary, both for the purely mathematical purposes of the present paper, and also to make possible the program(s) described below.

More speculatively, the extremely detailed combinatorial information presented here for knotted surfaces, might possibly be useful data in the future extension of these results to yet higher-dimensional generalizations. It seems fascinating to speculate, about what might be the third term in the sequence of combinatorial structures which begins:

\mathcal{E} = set of elementary events = $\{Cup, Cap, NE, NW\}$, 5 Reidemeister and Yetter moves

— followed by:

\mathcal{ET} = set of elementary transitions, 31 types of movie-moves.

Another advantage to restricting to the combinatorial portion of the theory of CRS movies, is that it seems much easier to write a program for directly computing with this portion of the theory. Actually, we have written two such programs, based on somewhat different principles—with the idea that, when they both give the same result, this increases the reliability of the answer. These two (equivalent) programs— or rather, class libraries, one in C++ and one in Java— will be referred to in this paper, as C++2KnotsLib

and Java2KnotsLib.²

It should be emphasized that Section 2 is entirely an exposition of a subset of the results in [CRS] and [BL]. In Section 3 we present constructions, next to be sketched, which we believe have some novelty. Their explicit computation involves use of the programs and class-libraries just mentioned.

Let \mathcal{MM} denote the set of all movie-moves. This will be explained in more detail in §2.6 below. For now, it suffices to know that each movie-move is associated with a positive integer, which we shall call its **type**, which ranges from 1 to 31 inclusive. One application of the constructions in (III) is to study some aspects of this set \mathcal{MM} , in relation to the theory of 2-knots.

It is natural to ask, which of these 31 types of movie-move is really needed, in the sense of the following definition. For instance, it will be proved in this paper, that (in the sense of the following definition) movie-move 31 is not a consequence of the remaining 30 types.

Definition 1 *Let $1 \leq i \leq 31$. We shall say that movie-moves of type i are **essential** if there exist two CRS movies M and M' such that (working in the smooth category):*

1. M and M' have 0 strings coming in and 0 going out—ie the 2-tangles they represent are knotted surfaces.
2. The knotted surfaces represented by M and M' are ambient isotopic.
3. It is impossible to get from M to M' , by a sequence of movie-moves, all of type different from i .

*When such movies M, M' do not exist, we shall say that movie-moves of type i are **non-essential**.*

Using the constructions in §3, we shall prove that movie-moves of type 31 are essential. This result is proved in §3.6 below, utilizing the machinery next to be explained.

Define

$$\underline{31} := \{i \in \mathbb{Z} \mid 1 \leq i \leq 31\},$$

²These class libraries, together with some driver programs relevant to the present paper, are available (including source code) on the three following URL's:
<http://www.uic.edu/~rgl/javaknots.html> —this contains Java2KnotsLib
while C++2KnotsLib may be downloaded from either of:
<http://condor.depaul.edu/~jtowber/2knots> <http://condor.depaul.edu/~glan-cast/2knots>

and let \mathcal{U} denote any proper subset of $\underline{31}$. Let

$$\mathcal{U}^c := \{i \in \underline{31} \mid i \notin \mathcal{U}\}$$

denote the complement of \mathcal{U} in $\underline{31}$.

We now need the following higher-dimensional analogue of Kauffman's concept of "regular isotopy" of link-diagrams:

Definition 2 *Let \mathcal{U} and \mathcal{U}^c be as above. Let M and M' be two movies. Then we say M and M' are \mathcal{U} -regularly isotopic if it is possible to go from M to M' by a sequence of movie-moves NOT in \mathcal{U} —in more detail, if there is a non-empty ordered sequence*

$$\mathcal{M}_1, \dots, \mathcal{M}_N \quad (N > 0)$$

of movie-moves, with these three properties:

1. Each \mathcal{M}_i (for $1 \leq i \leq N$) is a movie-move of type in \mathcal{U}^c (i.e., NOT in \mathcal{U} .)
2. If \mathcal{U}_i is the movie-move ($M_i \rightsquigarrow M'_i$), then

$$M'_i = M_{i+1} \text{ for } 1 \leq i \leq N - 1$$

3. $M_1 = M$ and $M'_N = M'$.

Another key ingredient in our proof that movie-moves of type 31 are essential, is the construction of certain \mathcal{U} -regular isotopy invariants, which are here called \mathcal{U} -amplitude-invariants. The construction of these amplitude-invariants, which is next to be sketched, is based on $sl_q(2)$ and the Kauffman amplitude $\langle \rangle$.

Let

$$A = \mathbb{Z}[q, q^{-1}]$$

and let V be free over A of rank 2. As explained in §2.1, to every elementary event or still

$$E : m \rightarrow n ,$$

the Kauffman amplitude assigns an A -linear map

$$\langle E \rangle : V^{\otimes m} \rightarrow V^{\otimes n}$$

For technical reasons, our constructions become much simpler, if we replace A by its quotient-field

$$\mathbb{K} := \mathbb{Q}(q)$$

and V by the 2-dimensional vectorspace

$$V_1 := V \otimes_A \mathbb{K}$$

over \mathbb{K} , at the same time (by a slight abuse of notation) identifying the Kauffman bracket $\langle E \rangle$ with

$$\langle E \rangle \otimes_E \mathbb{K} : V_1^{\otimes m} \rightarrow V_1^{\otimes n}$$

We introduce in §3.1 a higher-dimensional analog of the Kauffman bracket: namely, the concept of an **amplitude-assignment** \mathcal{A} , which assigns to every elementary transition $\mathcal{E} : S \Rightarrow T : m \rightarrow n$, an \mathbb{K} -linear map

$$\langle \mathcal{E} \rangle_{\mathcal{A}} : V_1^{\otimes m} \rightarrow V_1^{\otimes n}$$

Such an \mathcal{A} assigns in a natural way (explained in Def.42) to every flicker

$$F : S \Rightarrow T : m \rightarrow n$$

an \mathcal{A} -amplitude $\langle F \rangle_{\mathcal{A}}$. Finally, the \mathcal{A} -amplitude of a movie M is defined to be given by the following construction:

Let the movie M consist of the stills S_1, \dots, S_N , with consecutive stills S_i, S_{i+1} joined by the flicker F_i for $1 \leq i \leq N - 1$. It is an important feature of the Carter-Rieger-Saito concept of movie, that two movies which have the same stills but different flickers between them, count in general as non-isotopic movies, and can represent non-isotopic 2-knots. This feature suggests that the \mathcal{A} -amplitude of M should be defined in such a way as to involve the F 's as well as the S 's; we here set

$$\langle M \rangle_{\mathcal{A}} := \langle S_1 \rangle - \langle F_1 \rangle_{\mathcal{A}} + \langle S_2 \rangle - \langle F_2 \rangle_{\mathcal{A}} + \langle S_3 \rangle - \dots + \langle S_N \rangle \quad (*)$$

We define an amplitude-assignment \mathcal{A} to be **\mathcal{U} -balanced** if the expression (*) just given, provides an \mathcal{U} -regular isotopy-invariant of movies. The main purpose of the present paper, is to construct (by using computer programs to be discussed below) \mathcal{U} -balanced amplitude-assignments \mathcal{A} , which then yield \mathcal{U} -regular isotopy invariants $\langle M \rangle_{\mathcal{A}}$ of knotted surfaces. \mathcal{U} -regular isotopy invariants obtained in this way, are here referred to as $sl_q(2)$ -based ³ amplitude-invariants.

³This represents a pious hope that these constructions may be generalized to apply to other quantum groups. The work presented here is organized strongly around the Kauffman bracket, which has $sl_q(2)$ as its quantum symmetry group, acting on its two-dimensional fundamental representation.

It is easy to see that an amplitude-assignment \mathcal{A} is \mathcal{U} -balanced, if and only if it ‘respects’ (in a suitable sense given by Def.45) all movie-moves not in \mathcal{U} . *A priori*, there are infinitely many movie-moves to be considered in this connection. At this point it is helpful to add a somewhat technical requirement, that \mathcal{A} be **semi-normal**, explained in Def.48 of §3.2. With this *Ansatz*, we may reduce to the consideration of only a finite collection of movie-moves, as follows:

Using the numbering of movie-moves furnished both in [CRS] and in [BL], it is proved that if \mathcal{A} is semi-normal, it automatically respects all movie-moves of types 15, 16, 22, (Prop. 48) and also all movie-moves of types 17,18,19,20 (Prop. 49) Moreover, the movie-moves of the 23 remaining types can be reduced to a finite subset, such that an amplitude-assignment \mathcal{A} is \mathcal{U} -balanced, if and only if all movie-moves in this finite subset, are respected by \mathcal{A} . (Prop.52).

In order to complete our construction of \mathcal{U} -balanced amplitude-assignments, we must augment our requirement of semi-normality, obtaining a stronger condition of **strong normality**, as given by Def.56. Now the search for \mathcal{U} -balanced strongly normal amplitude-assignments, reduces to a finite number of linear equations over A , via an explicit algorithm furnished by Prop.58 in §3.5.

We apply the machinery thus developed, to prove, in §3.6, the result (asserted above) that movie-move 31 is *essential* in the sense of Def. 1, i.e. is not a consequence of the remaining movie-moves. The proof to be presented here, involves explicitly solving the system $\text{Assoc}(\mathcal{U})$ of equations associated to \mathcal{U} , in the two special cases $\mathcal{U} = \{31\}$ and $\mathcal{U} = \emptyset$.

Finally, §4 is devoted to showing how our Program can be used to perform some miscellaneous computations on 7 sample movies (representing, respectively: an unknotted sphere, an unknotted Klein bottle, an unknotted torus, two knotted spheres, and the ‘1-twist and 2-twist spun trefoil’ described on p.36 of [CS2].)

We should like to express our gratitude to Carter and Saito for a large number of conversations in which they patiently explained some of their ideas about knotted surfaces. Without their help, this paper could not have been written. Also, the third author would like to express gratitude to the mathematics departments of Harvard, University of Chicago, and University of Illinois at Chicago, for extending hospitality during time in which work was done on the present paper.

2 Carter-Rieger-Saito Doubly Time-oriented Movies

2.1 Time-oriented Link-diagrams and their Kauffman Amplitudes

By a “link-diagram in \mathbb{R}^2 ” will be meant an ordered pair (D,C) , where D is a smooth immersion in \mathbb{R}^2 of a finite disjoint union of circles, which is “generic”, that is, such that the only singularities of D are simple transverse intersections; and where C is the additional structure furnished by the assignment for each singularity S of D , with branches b_1, b_2 over S , of a label “over-crossing” for one of these two branches, and “under-crossing” for the other one.

If L is a smooth link in \mathbb{R}^3 , then for almost every unit vector v in \mathbb{R}^3 , the projection

$$\mathbb{R}^3 \rightarrow \mathbb{R}^2$$

along v maps L to the portion D of such a link-diagram, with the additional structure C then determined so the direction from each over-crossing to the corresponding under-crossing is parallel (in the positive sense) to v .

The reader is assumed familiar with the fact that two such link diagrams are projections of isotopic links, if and only if it is possible to pass from one to the other by planar isotopies, together with a finite sequence of the three “Reidemeister moves” (as pictured in Fig. 1.) Moreover, certain mathematical constructions, reminiscent of constructions in quantum mechanics, have (since the revolutionary advent in 1984 of the Jones polynomial([J])) been used to import “amplitudes” into this situation, and so to obtain isotopy-invariants of links. The reader will not be assumed familiar with the subset of these constructions utilized in this paper (Yetter’s two additions to the Reidemeister moves, and the relation of these additions to the concept of braided monoidal categories and to the Kauffman amplitudes under “regular isotopy”.) This subset of these familiar constructions will next be discussed in the remainder of the present section, from a perspective which (it is hoped) will make more natural the higher-dimensional analogues of these constructions in the later portions of this paper.

Suppose we introduce an oriented “time” dimension, into the real Euclidean plane P containing the link diagrams under study—i.e., suppose we have chosen a specific unit vector τ in P (pointing from ‘past’ to ‘future’). (In all figures drawn in the present paper, τ will point from bottom to top. Many papers on the subject use the opposite convention.) This extra bit of structure makes possible the following further well-known modifications in the preceding set-up—and so makes possible the construction

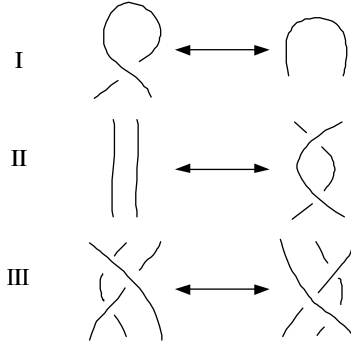

Figure 1: The Three Reidemeister Moves

of the monoidal category Σ (of 'stills') next to be described (a quotient of which is a braided monoidal category with duals, the category of 'tangles', which seems to underly the theory of the Jones , HOMFLY and Kauffman polynomials.)

Definition 3 Let τ be a unit vector in a Euclidean plane P , and let

$$(D : n.S^1 \rightarrow P, C)$$

be a link-diagram in P (where we denote by $n.S^1$ the disjoint union of n circles.)

Then we shall say that D is τ -regular if, for every singular point π of D (which, by hypothesis, is a simple transverse self-intersection) neither of the two tangents at π is parallel to τ .

Two such τ -regular link-diagrams $(D, C), (D', C')$ with

$$D, D' : n.S^1 \rightarrow P$$

will be called τ -equivalent if there is a smooth map $\phi : (n.S^1 \times [0, 1]) \rightarrow P$, with these two properties:

i) For each $t \in [0, 1]$,

$$\phi_t : n.S^1 \rightarrow P, x \mapsto \phi(x, t)$$

is a τ -regular link-diagram.

ii) $\phi_0 = D$ and $\phi_1 = D'$.

iii) In the obvious sense, ϕ takes C into C' .

When such a ϕ exists, we shall write

$$(D, C) \sim_1 (D', C').$$

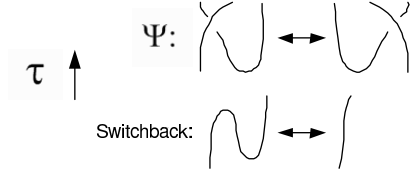

Figure 2: The Yetter Moves



Figure 3: Move 0 = Planar Isotopy

The point of all these definitions, is the following well-known refinement of Reidemeister’s results (which is precisely made-to-order for the extension below to knotted surfaces):

Theorem 4 *Let $(D, C), (D', C')$ be τ -regular projections of smooth links L resp. L' in \mathbb{R}^3 ; then, L and L' are ambient isotopic, if and only if it is possible to go from (D, C) to (D', C') by a finite sequence*

$$(D_0, C_0) = (D, C), (D_1, C_1), \dots, (D_s, C_s) = (D', C')$$

such that, for each i with $1 \leq i < s$, **either**

$$(D_i, C_i) \sim_1 (D_{i+1}, C_{i+1}) \tag{*}$$

(“move 0”), **or** (D_i, C_i) and (D_{i+1}, C_{i+1}) are related by one of the (various flavors of) the five moves in Figures 1 and 2) (i.e. either by one of the three Reidemeister moves in Fig. 1, or one of the two Yetter moves in Fig. 2). When this is the case, we shall write

$$(D, C) \sim_2 (D', C').$$

(Let us be a bit pedantic, and say that when (*) holds, (D_i, C_i) is obtained from (D_{i+1}, C_{i+1}) via Move 0: this will be a useful point of view later on—cf. Fig. 3)

There is yet a third equivalence relation, regular isotopy which plays a role, via the Kauffman amplitudes shortly to be defined, and which we shall denote by \sim_3 . It is important to note that only the equivalence-relation \sim_1 is used for the 1-morphisms (stills) in the 2-category of movies.

Let us denote by \mathcal{D}_0^τ the set of all τ -regular link-diagrams in \mathbb{R}^2 . This is contained in a larger set \mathcal{D}^τ which constitutes a braided monoidal category with duals, the category of ‘tangles’, as explained in [FY]. For the purposes of the present paper, we do not need the details of this construction; we only need the quotient Σ^τ of \mathcal{D}^τ by the equivalence relation extending τ -equivalence, or rather, we only need the purely combinatorial construction of this category, which we next present in some detail.

Definition 5 By an elementary event will be meant an element of the set of strings

$$\mathcal{E} = \{Cup, Cap, NE, NW\} .$$

By a framed event will be meant one of two kinds of object: **EITHER** an ordered triple (always to be enclosed in **square** brackets) of the form

$$[m, E, n] \tag{1a}$$

where m and n are natural numbers, and

$$E \in \mathcal{E} ,$$

OR a symbol of the form

$$1_n \tag{1b}$$

where n is a natural number..

Note: The 4 elementary events are to be thought of as associated with the 4 τ -regular link diagrams given in Figure 4. Also (with τ always drawn vertically, from the bottom of the page to its top) $[m, E, n]$ is to be thought of, as associated with the τ -regular link-diagram, obtained by adjoining to the diagram for E , m vertical strings to the left, and n vertical strings to the right—e.g., Figure 5 represents the framed event $[3, Cap, 1]$. Finally, 1_n is associated with the regular link-diagram, consisting of n vertical lines—e.g. Figure 6 represents the framed event 1_3 . In particular, 1_0 is associated with the 'empty' link-diagram, containing no strings at all.

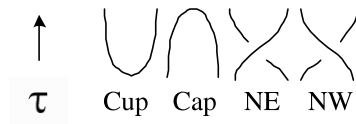

Figure 4: The 4 Elementary Events



Figure 5: Framed Event $[3,Cap,1]$



Figure 6: Framed Event 1_3

Definition 6 By the source and target of an elementary event E will be meant the integers specified by the following table. The source and target of a framed event are then defined by the formulas

$$\text{source}([m, E, n]) := m+n+\text{source}(E) ; \text{target}([m, E, n]) := m+n+\text{target}(E)$$

and

$$\text{source}(1_n) := n, \text{target}(1_n) := n$$

Event	Source	Target
NW	2	2
NE	2	2
Cup	0	2
Cap	2	0

Note: Thus, with the conventions in use in the present paper, the source of an event, or framed event, is the number of lines leading into its base, and the target is the number of lines going out its top—e.g. the framed event $[3, \text{Cap}, 1]$ in Fig. 5 has source 6 and target 4.

Definition 7 By a still S will be meant a finite non-empty sequence of framed events,

$$(F_1, \dots, F_s)$$

such that for each of these framed events F_i (except the last one) the target of F_i is equal to the source of the succeeding framed event F_{i+1} . We shall usually use a multiplicative notation to denote such a concatenation of framed events, writing

$$S = F_1 F_2 \cdots F_s$$

We denote by Σ the set of such stills. By the source of a non-empty still S will be meant the source of its first framed event, while its target is defined to be the target of its last framed event. By the empty still will be meant the still 1_0 ; note that, by the preceding definitions, the associated link-diagram to the empty still is empty, and the source and target of the empty still are both 0.

NOTE: Such a still is called a ‘word’ by Carter, Rieger and Saito—cf. [?], p.35.

EXAMPLE:

Consider the still $S \in \Sigma$ given by

$$S = [2, \text{NW}, 0][1, \text{Cap}, 1][0, \text{NE}, 0]$$

which is illustrated by Figure 7 (which is to be read from bottom to top, while S is read left-to-right. (Caution: some other authors use other conventions.)



Figure 7: Still $[2, NW, 0][1, Cap, 1][0, NE, 0]$

Note this sequence of 3 framed events satisfies the compatibility condition of Def.7, since

$$target([2, NW, 0]) = 4 = source[1, Cap, 1]$$

and

$$target([1, Cap, 1]) = 2 = source([0, NE, 0]) .$$

Note also that S has source 4 and target 2.

The set Σ , gives rise in the following way to a category (which, by a slight abuse of notation, will also be denoted by Σ):

The objects of the category Σ are the natural numbers; the morphisms are the stills. If m and n are natural numbers, $Hom_{\Sigma}(m, n)$ is the set of all stills S such that

$$source(S) = m \text{ and } target(S) = n$$

in which case we shall also write

$$S : m \rightarrow n .$$

Definition 8 *If S, S' are the stills defined, respectively, by the sequences⁴*

$$S = F_1 \cdots F_s, \quad S' = F'_1 \cdots F'_t$$

⁴By the conventions used in this paper, these compositions are read from **bottom** to **top**, e.g. F_1 occurs at the bottom of the still S , and F_s at the top.

of framed events, then the composite still $S \circ S'$ is defined in the category Σ , if and only if

$$\text{source}(S') = \text{target}(S) ,$$

in which case we set

$$S \circ S' = F_1 \cdots F_s F'_1 \cdots F'_t$$

The following operation on the category Σ will prove useful below:

Definition 9 Let m and n be natural numbers.

a) If F is a framed event, we define $m \bullet F \bullet n$ to be the framed event

$$\begin{cases} [m + m', E, n + n'] & \text{if } F = [m', E, n'] \\ 1_{m+n+p} & \text{if } F = 1_p \end{cases}$$

b) Let

$$S = F_1 \cdots F_p$$

be a still (where $1 \leq p$ and F_1, \dots, F_p are framed events.)

Then we define $m \bullet S \bullet n$ to be the still

$$m \bullet S \bullet n := (m \bullet F_1 \bullet n) \cdots (m \bullet F_p \bullet n)$$

In other words (by a slight generalization of the construction in Def.5), the link-diagram for the still $m \bullet S \bullet n$ is obtained from that for the still S , by appending m vertical strings to the left, and n to the right.

Let us next note the following two (commuting) symmetries t and f on the collection Σ of stills: First, f is the symmetry which "flips" over-crossings into under-crossings; in more detail:

Definition 10 THE SYMMETRY f :

(i) We define the action of f on the elementary events in \mathcal{E} by:

$$f \cdot \text{Cap} = \text{Cap}, f \cdot \text{Cup} = \text{Cup}, f \cdot \text{NE} = \text{NW}, f \cdot \text{NW} = \text{NE}$$

(ii) We define the action of f on framed events by:

$$f \cdot [m, E, n] = [m, f \cdot E, n] \text{ for } E \in \mathcal{E}, \text{ and } f \cdot 1_n = 1_n$$

(iii) Finally, if S is the still given by

$$S = F_1 \cdots F_s ,$$

where the F_i are framed events, then we define

$$f \cdot S := (f \cdot F_1) \cdots (f \cdot F_s)$$

Next, t is the symmetry which reverses the time-orientation τ ; in more detail:

Definition 11 THE SYMMETRY t :

(i) We define the action of t on the elementary events in \mathcal{E} by:

$$t \cdot \text{Cap} = \text{Cup}, t \cdot \text{Cup} = \text{Cap}, t \cdot \text{NE} = \text{NW}, t \cdot \text{NW} = \text{NE}$$

(ii) We define the action of t on framed events by:

$$t \cdot [m, E, n] = [m, t \cdot E, n] \text{ for } E \in \mathcal{E}, \text{ and } t \cdot 1_n = 1_n$$

(iii) Finally, if S is the still given by

$$S = F_1 \cdots F_s,$$

where the F_i are framed events, then we define

$$t \cdot S := (t \cdot F_s) \cdots (t \cdot F_1)$$

We next review one well-known further aspect of Σ which will be used in our later constructions—namely, the construction (due to L.Kauffman) which assigns to every still $S \in \Sigma$ a ‘Kauffman amplitude’ $\langle S \rangle$.⁵

Let V be free on $\{e_0, e_1\}$ over the ring $\mathbb{Z}[q, q^{-1}]$ of Laurent polynomials in one indeterminate q over the ring \mathbb{Z} of integers. Thus $V^{\otimes n}$ is free of rank 2^n over $\mathbb{Z}[q, q^{-1}]$, with free basis

$$\{e(i_1, \dots, i_n) := e_{i_1} \otimes e_{i_2} \otimes \cdots \otimes e_{i_n} \mid \text{all } i\text{'s}=0 \text{ or } 1\}$$

Let $S : m \rightarrow n$ be a still with source m and target n . (With the conventions described above, this means m strings lead into the bottom of the time-oriented diagram describing S , and n lead up out the top.) Then, we construct as follows a linear transformation

$$\langle S \rangle : V^{\otimes m} \rightarrow V^{\otimes n}.$$

In the first place, to the four elementary events in \mathcal{E} , we assign the following four $\mathbb{Z}[q, q^{-1}]$ -linear maps as amplitudes:

⁵It is more usual to call this the ‘Kauffman bracket’. Our present terminology is intended to distinguish this from the other **Kauffman bracket**, which has a similar definition and notation, but whose domain of definition is the set of non-time-oriented link-diagrams (of non-oriented links or tangles).

$\langle Cup \rangle: V^{\otimes 0} = \mathbb{Z}[q, q^{-1}] \rightarrow V^{\otimes 2}$ maps 1 to $-qe(0, 1) + q^{-1}e(1, 0)$;
 $\langle Cap \rangle: V^{\otimes 2} \rightarrow \mathbb{Z}[q, q^{-1}]$ maps both $e(0, 0)$ and $e(1, 1)$ to 0, maps $e(0, 1)$ to q and maps $e(1, 0)$ to $-q^{-1}$;
 $\langle NE \rangle: V^{\otimes 2} \rightarrow V^{\otimes 2}$ maps $e(i, i)$ to $qe(i, i)$ (for $i=0,1$) and maps $e(0, 1)$ to $q^{-1}e(1, 0)$ and $e(1, 0)$ to $q^{-1}e(0, 1) + (q - q^{-3})e(1, 0)$;
 $\langle NW \rangle: V^{\otimes 2} \rightarrow V^{\otimes 2}$ maps $e(i, i)$ to $q^{-1}e(i, i)$ (for $i=0,1$) and maps $e(1, 0)$ to $qe(0, 1)$ and $e(0, 1)$ to $(q^{-1} - q^3)e(0, 1) + qe(1, 0)$.

This construction extends in the obvious way from elementary events to framed events; namely, given an elementary event E with source s and target t , and given the related framed event $F = [m, E, n]$ (with source $m + s + n$ and target $m + t + n$), the Kauffman amplitude

$$\langle F \rangle: V^{\otimes m+s+n} \rightarrow V^{\otimes m+t+n}$$

is defined to be the tensor product $Id_{V^{\otimes m}} \otimes \langle E \rangle \otimes Id_{V^{\otimes n}}$. Also, $\langle 1_n \rangle$ is defined to be the identity map $Id_{V^{\otimes n}}$.

Finally, consider the general still S . We may write

$$S = F_1 F_2 \cdots F_s$$

where each F_i is a framed event, and where, for $1 \leq i < s$,

$$source(F_{i+1}) = target(F_i) .$$

Then we define the Kauffman amplitude of S to be

$$\langle S \rangle = \langle F_s \rangle \circ \langle F_{s-1} \rangle \circ \cdots \circ \langle F_1 \rangle: V^{\otimes source(S)} \rightarrow V^{\otimes target(S)} .$$

REMARK: For this construction, cf. for instance, Kauffman ([K], Part I, §9^o.) We have here made one trivial modification in this construction—namely, Kauffman’s original amplitudes

$\langle Cup \rangle$, $\langle Cap \rangle$ are respectively $-i$, i times those we shall use in the algorithm presented in this paper. With this modification we can work, not in $\mathbb{Z}[i, q, q^{-1}]$, but rather in the smaller ground-ring $\mathbb{Z}[q, q^{-1}]$, over which we shall later have a rather large number (over two thousand) of simultaneous linear equations to solve. This modification is ‘trivial’ in one important sense: if S is a still which arises from a link-diagram, so that

$$source(S) = 0 = target(S)$$

then if S has m minima (cups), it also has m maxima (caps), so Kauffman's original amplitude, and the modification to be used here, differ by a factor of

$$(-i)^m \cdot i^m = 1 ,$$

i.e. agree at least for such stills. Also, the present modification spoils, neither the $sl_q(2)$ -equivariance of the amplitude, nor the fact that the Kauffman amplitude respects the relation \sim_3 of regular isotopy.

2.2 Elementary Transitions

The set

$$\mathcal{E} = \{Cup, Cap, NE, NW\} .$$

of 'elementary events', discussed above, has in the higher-dimensional theory of knotted surfaces, an analog \mathcal{ET} (made up of two parts, one of cardinality 66 and the other consisting of 32 infinite sequences), which is now to be discussed. The elements of \mathcal{ET} will here be called **elementary transitions**; they are called **fundamental elementary string interactions** in [CRS]. Each elementary transition \mathcal{E} is an ordered pair of stills⁶, of which the first is called the **source** of \mathcal{E} , and the second the **target** of \mathcal{E} . An elementary transition \mathcal{E} is uniquely determined by its source S and target T , in which case we shall write

$$\mathcal{E} = [S \implies T] . \tag{1}$$

The reader is asked to bear with the (perhaps somewhat pedantic) detailed enumeration and labelling in this section of these elementary transitions. This is necessary, because we shall need carefully to assign individual 'amplitudes' to each of these, as explained below. More conjecturally, the detailed combinatorial data thus obtained may be also helpful in future investigations, in suggesting the still higher-dimensional analogues.

The tangle category $\Sigma/(\sim_2)$ sketched in §2.1, may be thought of as obtained via the following generators and relations construction:

i) The generators are the framed events, obtained by applying to the 4 elements of \mathcal{E} , the framing construction of Def. 9 (together with the identity

⁶Note that, for the purposes of the present paper, an elementary transition is a purely **combinatorial** object— it is no more and no less than an ordered pair of stills which occurs somewhere in our list. For the **topological** significance of these, as isotopy classes of specific 2-tangles in \mathbb{R}^3 , cf. [CRS], [CS2] and [LL].

morphisms 1_n), and then taking the \sim_2 -classes of the results.

ii) The defining relations are furnished by the three Reidemeister moves, the two Yetter moves, and the ‘zero’ move. (It is now necessary, carefully to draw these 6 moves in all possible “flavors”, and this will be done in the present section.)

The analogous generators-and-relations presentation, for the theory of knotted surfaces in \mathbb{R}^4 , contains:

for generators, objects (“flickers”) obtained by suitably framing the elementary transitions; and for relations, the collection of “movie-moves” explained below in §2.6. It is an observation, not original with the authors of the present paper (rather, it is an idea which seems well-known among experts in knotted surfaces) that there are **generators**—i.e., elementary transitions—for the higher-dimensional theory, which correspond precisely to the **relations** for the lower-dimensional theory (as well as some ‘new’ elementary transitions apparently not of this sort, namely those of type ET6 and ET7.)—and that this is a possible guide for what to expect, as the existing theory gets extended in the future into yet higher dimensions.

Enough speculation—let us next carefully examine the intricate collection of “elementary transitions” in some detail:

The elementary transitions fall into 9 types, samples of which are pictured in Fig. 8.

The second, third and fourth of these types, correspond (in accordance with the principle stated above) to the three Reidemeister moves. Let us next examine more closely the type ET1: This comes in eight “flavors”, i.e. there are 8 elementary transitions corresponding to Reid I, the first Reidemeister move (cf. Fig. 1); these 8 are labelled as follows, and illustrated in Figure 9. (In §3 below, when we come to assign “amplitudes” to elementary transitions, these 8 are assigned distinct amplitudes—and indeed, this needs to be done in many distinct ways. Thus it is essential to be able to deal with these 8 different flavors on an individual basis—and similarly for the other types treated below.)

$$\begin{aligned}
 ET1I &= [[0, Cup, 0][0, NE, 0] \implies [0, Cup, 0]], \\
 ET1R &= [[0, Cup, 0] \implies [0, Cup, 0][0, NE, 0]], \\
 ET1t &= [[0, NW, 0][0, Cap, 0] \implies [0, Cap, 0]], \\
 ET1tR &= [[0, Cap, 0] \implies [0, NW, 0][0, Cap, 0]], \\
 ET1f &= [[0, Cup, 0][0, NW, 0] \implies [0, Cup, 0]],
 \end{aligned}$$

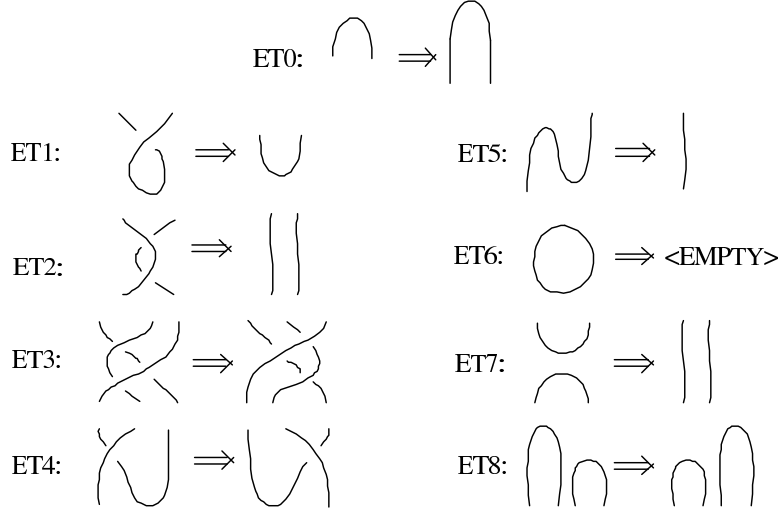

Figure 8: Elementary Transitions

$$\begin{aligned}
 ET1fR &= [[0, Cup, 0] \implies [0, Cup, 0][0, NW, 0]], \\
 ET1ft &= [[0, NE, 0][0, Cap, 0] \implies [0, Cap, 0]], \\
 ET1ftR &= [[0, Cap, 0] \implies [0, NE, 0][0, Cap, 0]].
 \end{aligned}$$

(Note this ordering derives from the ordering $R < t < f$.)

Next, there are 4 elementary transitions corresponding to the second Reidemeister move, Reid II:

$$\begin{aligned}
 ET2I &= [[0, NE, 0][0, NW, 0] \implies 1_2], \\
 ET2R &= [1_2 \implies [0, NE, 0][0, NW, 0]], \\
 ET2f &= [[0, NW, 0][0, NE, 0] \implies 1_2], \\
 ET2fR &= [1_2 \implies [0, NW, 0][0, NE, 0]].
 \end{aligned}$$

These are illustrated in Figure 10.

For the third Reidemeister move, Reid III, the number of associated elementary transitions increases to 12 (This is, in some ways, one of the most difficult of the 9 types. It is the type connected with the Yang-Baxter equation.) These are listed as follows (and pictured in Figure 11):

$$\begin{aligned}
 ET3bmt &= [[0, NE, 1][1, NE, 0][0, NE, 1] \implies [1, NE, 0][0, NE, 1][1, NE, 0]], \\
 ET3bmtR &= [[1, NE, 0][0, NE, 1][1, NE, 0] \implies [0, NE, 1][1, NE, 0][0, NE, 1]], \\
 ET3btm &= [[0, NW, 1][1, NE, 0][0, NE, 1] \implies [1, NE, 0][0, NE, 1][1, NW, 0]],
 \end{aligned}$$

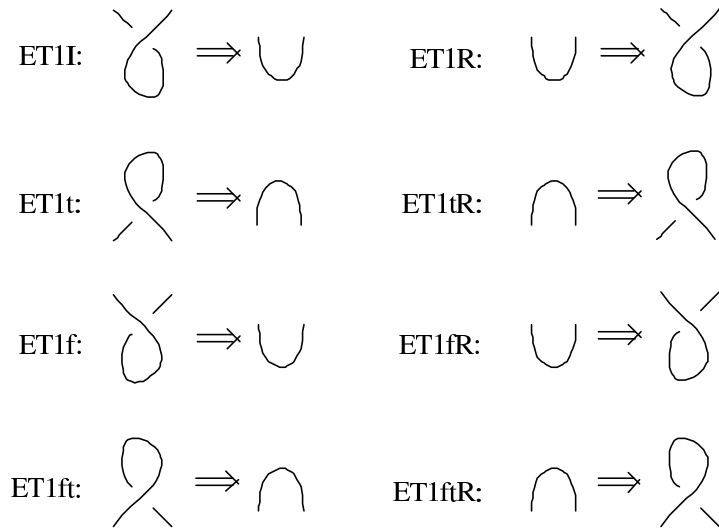

Figure 9: Elementary Transitions of Type ET1

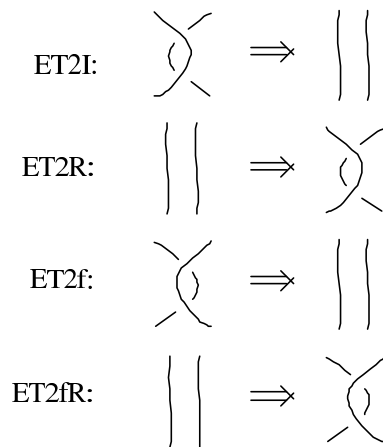

Figure 10: Elementary Transitions of Type ET2

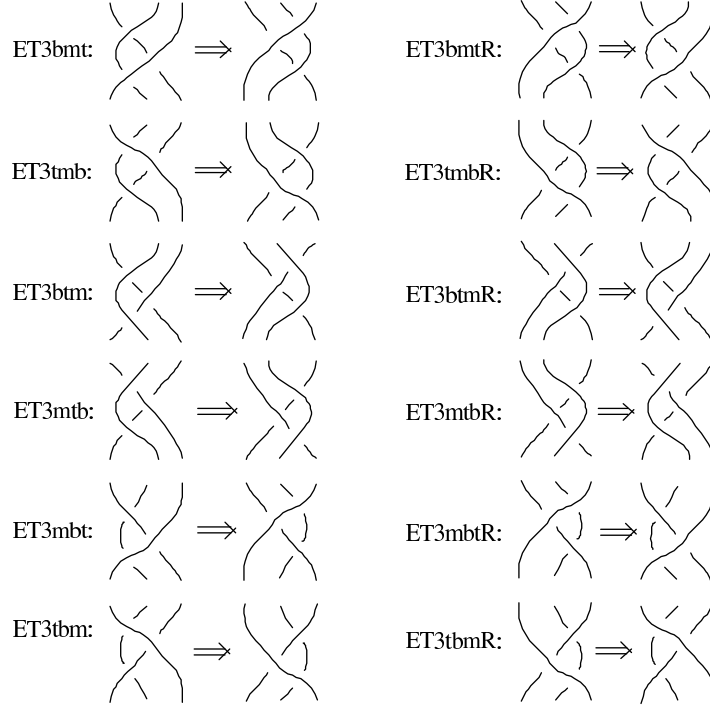

Figure 11: Elementary Transitions of Type ET3

$$\begin{aligned}
ET3btmR &= [[1, NE, 0][0, NE, 1][1, NW, 0] \Rightarrow [0, NW, 1][1, NE, 0][0, NE, 1]], \\
ET3mbt &= [[0, NE, 1][1, NE, 0][0, NW, 1] \Rightarrow [1, NW, 0][0, NE, 1][1, NE, 0]], \\
ET3mbtR &= [[1, NW, 0][0, NE, 1][1, NE, 0] \Rightarrow [0, NE, 1][1, NE, 0][0, NW, 1]], \\
ET3mtb &= [[0, NW, 1][1, NW, 0][0, NE, 1] \Rightarrow [1, NE, 0][0, NW, 1][1, NW, 0]], \\
ET3mtbR &= [[1, NE, 0][0, NW, 1][1, NW, 0] \Rightarrow [0, NW, 1][1, NW, 0][0, NE, 1]], \\
ET3tbm &= [[0, NE, 1][1, NW, 0][0, NW, 1] \Rightarrow [1, NW, 0][0, NW, 1][1, NE, 0]], \\
ET3tbmR &= [[1, NW, 0][0, NW, 1][1, NE, 0] \Rightarrow [0, NE, 1][1, NW, 0][0, NW, 1]], \\
ET3tmb &= [[0, NW, 1][1, NW, 0][0, NW, 1] \Rightarrow [1, NW, 0][0, NW, 1][1, NW, 0]], \\
ET3tmbR &= [[1, NW, 0][0, NW, 1][1, NW, 0] \Rightarrow [0, NW, 1][1, NW, 0][0, NW, 1]].
\end{aligned}$$

There are 8 elementary transitions, associated to the Yetter "Ψ" move, tabulated as follows (and pictured in Figure 12):

$$\begin{aligned}
ET4I &= [[1, Cup, 0][0, NE, 1] \Rightarrow [0, Cup, 1][1, NW, 0]], \\
ET4R &= [[0, Cup, 1][1, NW, 0] \Rightarrow [1, Cup, 0][0, NE, 1]],
\end{aligned}$$

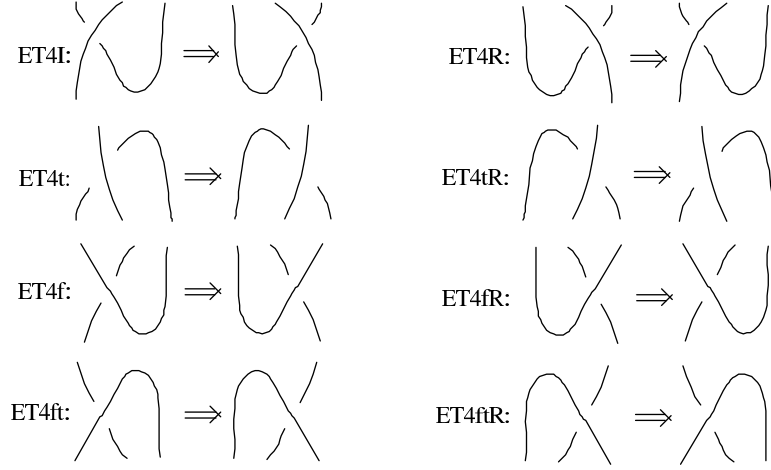

Figure 12: Elementary Transitions of Type ET4

$$\begin{aligned}
ET4t &= [[0, NW, 1][1, Cap, 0] \Rightarrow [1, NE, 0][0, Cap, 1]], \\
ET4tR &= [[1, NE, 0][0, Cap, 1] \Rightarrow [0, NW, 1][1, Cap, 0]], \\
ET4f &= [[1, Cup, 0][0, NW, 1] \Rightarrow [0, Cup, 1][1, NE, 0]], \\
ET4fR &= [[0, Cup, 1][1, NE, 0] \Rightarrow [1, Cup, 0][0, NW, 1]], \\
ET4ft &= [[0, NE, 1][1, Cap, 0] \Rightarrow [1, NW, 0][0, Cap, 1]], \\
ET4ftR &= [[1, NW, 0][0, Cap, 1] \Rightarrow [0, NE, 1][1, Cap, 0]],
\end{aligned}$$

There are 4 elementary transitions, associated to the second Yetter "switchback" move, tabulated as follows (and pictured in Figure 13):

$$\begin{aligned}
ET5I &= [[1, Cup, 0][0, Cap, 1] \Rightarrow 1_1], \\
ET5R &= [1_1 \Rightarrow [1, Cup, 0][0, Cap, 1]], \\
ET5t &= [[0, Cup, 1][1, Cap, 0] \Rightarrow 1_1], \\
ET5tR &= [1_1 \Rightarrow [0, Cup, 1][1, Cap, 0]]
\end{aligned}$$

The next two types of elementary transition, seem to have no direct analog in the relations ('moves') of the lower-dimensional theory. The first is sometimes called the "birth-death" transition; it comes in precisely two flavors, tabulated as follows, and pictured in Figure 14:

$$\begin{aligned}
ET6I &= [[0, Cup, 0][0, Cap, 0] \Rightarrow 1_0], \\
ET6R &= [1_0 \Rightarrow [0, Cup, 0][0, Cap, 0]]
\end{aligned}$$

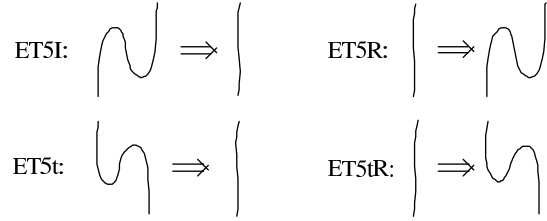

Figure 13: Elementary Transitions of Type ET5

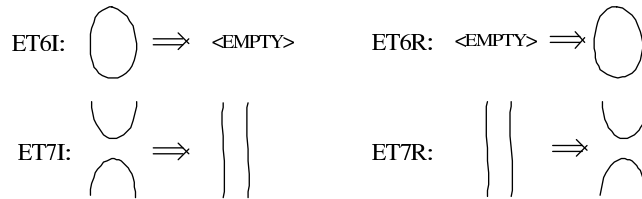

Figure 14: Elementary Transitions of Type ET6 and ET7

The next is the "surgery" or "syzygy" transition; it comes in the two flavors tabulated below, and also pictured in Figure 14:

$$\begin{aligned}
 ET7I &= [[0, Cap, 0][0, Cup, 0] \Rightarrow 1_2], \\
 ET7R &= [1_2 \Rightarrow [0, Cap, 0][0, Cup, 0]]
 \end{aligned}$$

(Perhaps *ET6* may be thought of as a higher-dimensional analogue of *Cup, Cap*, and *ET7* of *NE, NW*.)

There still remain two types of elementary transitions to discuss, namely *ET0* and *ET8*. These are of a more formal nature, and may be regarded as the elementary transitions analogous to "move 0" in our earlier discussion associated with Theorem 4. (We need to be careful to get these two types *ET0* and *ET8* straight—especially for the rather difficult proofs of Props.49 and 50 below— though in fact these two types play no role in the linear equations used later to determine amplitude assignments. Like "move 0", they sometimes seem like more trouble than they are worth...)

The elementary transitions of type *ET0*, relate to the way the framed events $1_n : n- > n$ play the role (in the tangle category approach to knotted circles in \mathbb{R}^3) of identity morphisms. Thus, if $\pi : m- > n$ is an elementary event with source m and target n , then associated to π we have the 4 elementary transitions

$$ET0\pi l := [\pi \Rightarrow 1_m \pi], ET0\pi l R := [1_m \pi \Rightarrow \pi], ET0\pi r := [\pi \Rightarrow \pi 1_n]$$

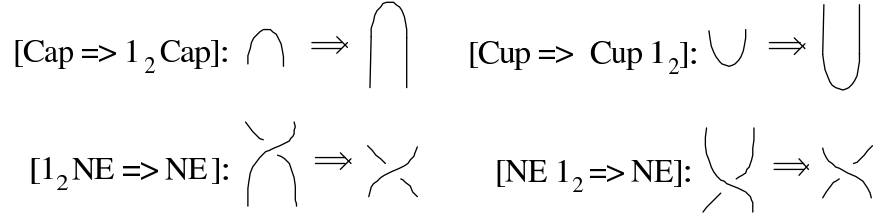

Figure 15: Four Elementary Transitions of Type ET0

and

$$ET0\pi rR = [\pi 1_n => \pi] .$$

Since π can be any one of 4 elementary events, we thus obtain 16 elementary transitions of type ET0, of which four are pictured in Figure 15. Each of these modifies a still, by inserting or removing an appropriate collection of vertical lines.

Finally, there are an infinite number of elementary transitions of type ET8, which we next define.

Let E, E' be elementary states—i.e. elements (possibly equal) of

$$\mathcal{E} = \{Cup, Cap, NE, NW\} ,$$

and let n be a natural number. Associated to such data, there is a law in the category of tangles, which is roughly speaking a commutative law—it asserts the isotopy of two "products" $L_n(E, E')$ and $U_n(E, E')$ (each of two elementary events, separated by n vertical strings) which are next to be defined—and so in the category of movies we get corresponding elementary transitions of type ET8. In more detail:

In the first place, we denote by $L_n(E, E')$, where n is any natural number, the still which is defined—roughly speaking—by placing E **below** and **to the left** of E' , with n vertical strands between.). More precisely, here is a case-by-case definition of $L_n(E, E')$:

(cf. Figure 16, where the first four of these are pictured with $n = 1$.)

$$\begin{aligned} L_n(Cup, Cup) &:= [0, Cup, n][n + 2, Cup, 0], \\ L_n(Cup, Cap) &:= [0, Cup, n + 2][n + 2, Cap, 0], \\ L_n(Cup, NE) &:= [0, Cup, n + 2][n + 2, NE, 0], \\ L_n(Cup, NW) &:= [0, Cup, n + 2][n + 2, NW, 0], \\ L_n(Cap, Cup) &:= [0, Cap, n][n, Cup, 0], \\ L_n(Cap, Cap) &:= [0, Cap, n + 2][n, Cap, 0], \end{aligned}$$

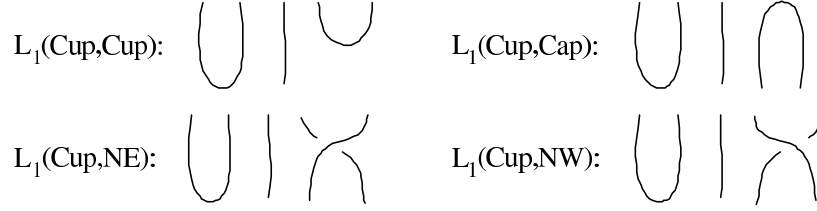

Figure 16: $L_1(\text{Cup}, *)$

$$\begin{aligned}
L_n(\text{Cap}, \text{NE}) &:= [0, \text{Cap}, n+2][n, \text{NE}, 0], \\
L_n(\text{Cap}, \text{NW}) &:= [0, \text{Cap}, n+2][n, \text{NW}, 0], \\
L_n(\text{NE}, \text{Cup}) &:= [0, \text{NE}, n][n+2, \text{Cup}, 0], \\
L_n(\text{NE}, \text{Cap}) &:= [0, \text{NE}, n+2][n+2, \text{Cap}, 0], \\
L_n(\text{NE}, \text{NE}) &:= [0, \text{NE}, n+2][n+2, \text{NE}, 0], \\
L_n(\text{NE}, \text{NW}) &:= [0, \text{NE}, n+2][n+2, \text{NW}, 0], \\
L_n(\text{NW}, \text{Cup}) &:= [0, \text{NW}, n][n+2, \text{Cup}, 0], \\
L_n(\text{NW}, \text{Cap}) &:= [0, \text{NW}, n+2][n+2, \text{Cap}, 0], \\
L_n(\text{NW}, \text{NE}) &:= [0, \text{NW}, n+2][n+2, \text{NE}, 0], \\
L_n(\text{NW}, \text{NW}) &:= [0, \text{NW}, n+2][n+2, \text{NW}, 0].
\end{aligned}$$

These 16 separate formulas are all subsumed in:

$$L_n(E, E') := [0, E, n + \text{source}(E')][n + \text{target}(E), E', 0] \text{ for } E, E' \in \mathcal{E}.$$

Similarly, $U_n(E, E')$ is defined, roughly speaking, to be the still which contains E **above** and to the **left** of E' , with n vertical strands between. ('L' for lower, 'U' for upper...) More precisely, here is a case-by-case definition: (cf. also Figure 17.)

$$\begin{aligned}
U_n(\text{Cup}, \text{Cup}) &:= [n, \text{Cup}, 0][0, \text{Cup}, n+2], \\
U_n(\text{Cup}, \text{Cap}) &:= [n, \text{Cap}, 0][0, \text{Cup}, n], \\
U_n(\text{Cup}, \text{NE}) &:= [n, \text{NE}, 0][0, \text{Cup}, n+2], \\
U_n(\text{Cup}, \text{NW}) &:= [n, \text{NW}, 0][0, \text{Cup}, n+2], \\
U_n(\text{Cap}, \text{Cup}) &:= [n+2, \text{Cup}, 0][0, \text{Cap}, n+2], \\
U_n(\text{Cap}, \text{Cap}) &:= [n+2, \text{Cap}, 0][0, \text{Cap}, n], \\
U_n(\text{Cap}, \text{NE}) &:= [n+2, \text{NE}, 0][0, \text{Cap}, n+2], \\
U_n(\text{Cap}, \text{NW}) &:= [n+2, \text{NW}, 0][0, \text{Cap}, n+2], \\
U_n(\text{NE}, \text{Cup}) &:= [n+2, \text{Cup}, 0][0, \text{NE}, n+2], \\
U_n(\text{NE}, \text{Cap}) &:= [n+2, \text{Cap}, 0][0, \text{NE}, n], \\
U_n(\text{NE}, \text{NE}) &:= [n+2, \text{NE}, 0][0, \text{NE}, n+2], \\
U_n(\text{NE}, \text{NW}) &:= [n+2, \text{NW}, 0][0, \text{NE}, n+2],
\end{aligned}$$

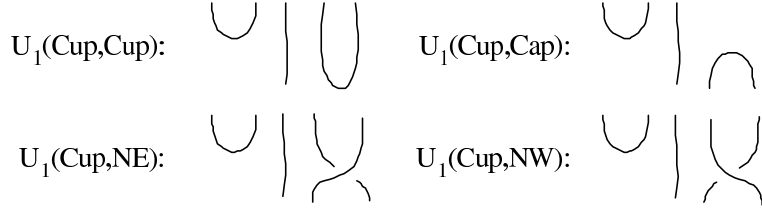

Figure 17: $U_1(\text{Cup}, *)$

$$U_n(\text{NW}, \text{Cup}) := [n + 2, \text{Cup}, 0][0, \text{NW}, n + 2],$$

$$U_n(\text{NW}, \text{Cap}) := [n + 2, \text{Cap}, 0][0, \text{NW}, n],$$

$$U_n(\text{NW}, \text{NE}) := [n + 2, \text{NE}, 0][0, \text{NW}, n + 2],$$

$$U_n(\text{NW}, \text{NW}) := [n + 2, \text{NW}, 0][0, \text{NW}, n + 2].$$

These 16 separate formulas are all subsumed in:

$$U_n(E, E') := [n + \text{source}(E), E', 0][0, E, n + \text{target}(E')] \text{ for } E, E' \in \mathcal{E}.$$

Finally, with every ordered pair E, E' of elementary events, and every natural number n , we associate two elementary transitions of type ET8, as follows:

$$ET8L_n(E, E') := [L_n(E, E') \Rightarrow U_n(E, E')], \quad ET8U_n(E, E') := [U_n(E, E') \Rightarrow L_n(E, E')]$$

The authors refuse to draw here pictures for all 32 families of these, but perhaps the 6 pictures in Fig. 18 will help convey the general idea.

We shall refer to elementary transitions of type ET8 as ‘commutation transitions’. In [CS](cf.p.34) these transitions (and the corresponding isomorphisms in the lower-dimensional category) are referred to as ‘exchanging the levels of distant critical points’—perhaps in analogy to the axiom in relativistic quantum field theory, according to which the commutators of amplitudes of events ‘distant’ (in the sense they are separated by a space-like interval), are given by suitable Dirac deltas. Of course, in the present case, what are ‘commuted’ are **adjacent** framed events in the τ direction, **distant** in the sense they may be separated by one or more vertical lines.

This completes our construction and labelling of the set \mathcal{ET} .

We conclude this subsection by making a few elementary observations, on some of the combinatorial structure on this set \mathcal{ET} , which will be useful

$$\begin{array}{l}
\text{ET8U}_0(\text{Cup,Cap}) : \quad \begin{array}{c} \cup \\ \cap \end{array} \Rightarrow \cup \cap \\
\text{ET8U}_1(\text{Cap,Cap}) : \quad \begin{array}{c} \cap | \cap \\ \cap | \cap \end{array} \Rightarrow \cap | \cap \\
\text{ET8L}_2(\text{NW,Cap}) : \quad \begin{array}{c} \cup | \cap \\ \cup | \cap \end{array} \Rightarrow \begin{array}{c} \cup | \cap \\ \cup | \cap \end{array} \\
\text{ET8L}_2(\text{Cup,NE}) : \quad \begin{array}{c} \cup | \cap \\ \cup | \cap \end{array} \Rightarrow \begin{array}{c} \cup | \cap \\ \cup | \cap \end{array}
\end{array}$$

Figure 18: Some Elementary Transitions of type $ET8$

for the constructions in the present paper:

Here is a table, showing how the elementary transitions are divided into types and flavors:

Type	0	1	2	3	4	5	6	7	8
Number of flavors	16	8	4	12	8	4	2	2	∞

And, just to be totally explicit, an elementary transition listed above as of type ETi ($0 \leq i \leq 8$), will also be said to be **of type i** . Also, if E is an elementary transition of type i , we shall sometimes write $t(E) = i$.

Let us next note the following three basic symmetries of elementary transitions (whose definition is based on the earlier symmetries on stills given by Defs.10 and 11):

Definition 12 THE SYMMETRY R:

Let $\mathcal{E} = [S \Rightarrow T]$ be an elementary transition; then by $R \cdot \mathcal{E}$ will be meant the elementary transition $[T \Rightarrow S]$.

Definition 13 THE SYMMETRY t:

Let $\mathcal{E} = [S \Rightarrow T]$ be an elementary transition; then by $t \cdot \mathcal{E}$ will be meant the elementary transition $[(t \cdot S) \Rightarrow (t \cdot T)]$

Definition 14 THE SYMMETRY f:

Let $\mathcal{E} = [S \Rightarrow T]$ be an elementary transition; then by $f \cdot \mathcal{E}$ will be meant the elementary transition $[(f \cdot S) \Rightarrow (f \cdot T)]$

Note that these three symmetries on elementary transitions are well-defined, i.e. examination of the above collection of pictures shows that, if $[S \Rightarrow T]$ is an elementary transition, so are $[T \Rightarrow S]$, $[t \cdot T \Rightarrow t \cdot S]$ and $[f \cdot S \Rightarrow f \cdot T]$. Also, these three symmetries commute pairwise, with each having square equal to the identity, and so give rise to an action on \mathcal{ET} of the finite Abelian group

$$\mathcal{SYM} = \{I, R, t, tR, f, fR, ft, ftR\} \cong \mathbb{Z}/(2) \times \mathbb{Z}/(2) \times \mathbb{Z}/(2)$$

of order 8, generated by R, t and f .

REMARK: It might seem appropriate to add a fourth symmetry—call it m —consisting in reflecting in a vertical midline in each still (without changing the assigned over- and under-crossings, or the movie-ordering of stills.) However, observe that $mt = tm$ consists in rotating by 180° in each still, thus resulting in a movie easily shown to be isotopic to the original movie. **For this reason, m will not be needed, and will not occur, in our further discussions of symmetries.** (With two exceptions: in the proof of Prop.50 below, and also in the proof of Prop.54, while the symmetry m is not absolutely needed in the proof itself, it clarifies and simplifies the proof.)

Utilizing these definitions of symmetries, let us now clarify the rationale behind our notation above for the elementary transitions—it is important to get this straight, since it underlies our later notation for the 102 variables (called ‘amplitude-parameters’), in the system of linear equations we shall need to solve.

Consider first the 8 flavors of $ET1$ (cf.Fig.9).The group

$$\mathcal{SYM} = \{I, R, t, tR, f, fR, ft, ftR\}$$

acts freely on this set of 8 flavors. We choose (quite arbitrarily) one of these 8 to be the ‘origin’ $ET1I$, and then for any π in \mathcal{SYM} , we denote $\pi \cdot ET1I$ by $ET1\pi$.

The 4 flavors of $ET2$ (cf.Fig.10) are labelled similarly, with this minor variation: Note first, the symmetry t in \mathcal{SYM} fixes each of the 4 flavors of $ET2$. We choose (again quite arbitrarily) one of these four to be $ET2I$, and then the other 3, labelled respectively $ET2R, ET2f, ET2fR$ are obtained from our choice of $ET2I$ by acting on it, respectively, by R, f, fR .

The labelling for the flavors of $ET4, 5, 6, 7$ (as supplied in Figures 12, 13 and 14) should now be self-explanatory.

Our labelling for the 12 flavors of $ET3$ (cf. Fig. 11) involves the following different ideas:

Consider any one of the 12 pictures in Fig. 11. It is of the form $S \Rightarrow T$, where each of the stills S and T involves 3 strings and 3 intersections. Of the 3 strings which make up S (in the picture chosen), one lies above the other two, one lies above another string and below the other one, and one lies beneath the other two— label these t, m, b respectively (for top, middle, bottom). Let us (arbitrarily) choose the top (rather than the bottom) of S to label with these 3 letters—and note that we have labelled the picture, by this permutation of b, t, m **OR** by this permutation followed by R . (see Fig. 11 for the two transitions corresponding to the permutation btm) For a given permutation π of $\{b, t, m\}$ correspond **TWO** elementary transitions of type $ET3$, one labelled $ET3\pi$ and the other labelled $ET\pi R$, where the former has the appearance

$$ET3\pi = [[0, *, 1][1, *, 0][0, *, 1] \Rightarrow [1, *, 0][0, *, 1][1, *, 0]]$$

(with each $*$ replaced by a suitable value of NE or NW) and the latter has the appearance

$$ET\pi R = [[1, *, 0][0, *, 1][1, *, 0] \Rightarrow [0, *, 1][1, *, 0][0, *, 1]] .$$

(As a check on these computations, note that each of these 12 elementary transitions $S \Rightarrow T$ of type $ET3$ is a palindrome, in the sense that if we read S in our present notation from right to left, we obtain the notation for T .)

Proposition 15 *Let E be an elementary transition, with source S and target T ; then*

$$source(S) = source(T) \text{ and } target(S) = target(T) .$$

PROOF: Direct examination of all pictures in this section, together with Def.7.

Definition 16 *Let $E : S \Rightarrow T$ be an elementary transformation; then by $in(E)$ will be meant the common value of $source(S)$ and $source(T)$, while by $out(E)$ will be meant the common value of $target(S)$ and $target(T)$.*

EXAMPLE: Examination of Fig.9 shows that

$$in(ET1I) = 0, \text{ and } out(ET1I) = 2$$

Because of the great importance of $[LL]$ in the theory of 2-knots, and also because of our need below to refer to $[LL]$ in the discussion of movie-moves, it seems worthwhile to conclude the present section, by presenting

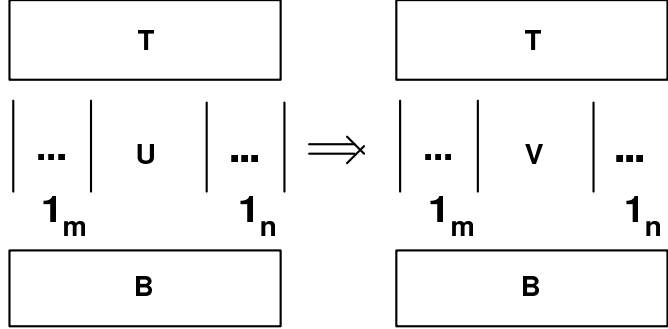

Figure 19: Flicker $\mathcal{F} = (U \Rightarrow V, B, m, n, T)$

2.3 Flickers and Movies

We next shall define the combinatorial concept (due in its final form to Carter, Rieger and Saito, [CRS]), of a **‘movie’**. Very roughly speaking, this is a sequence of stills, each obtained from the preceding one by a permissible kind of transition, next to be explained, called a **‘flicker’** in the present paper. More precisely:

Recall first that, in the lower-dimensional theory sketched in §2.1, a *‘framed event’* $[m, E, n]$ was obtained by enhancing an *‘elementary event’* E by m vertical strings on the left, and n on the right (cf. Fig. 4). A *‘flicker’* is the next-higher-dimensional analog of this: it is obtained from an elementary transition $\mathcal{E} : U \Rightarrow V$ upon enhancing \mathcal{E} by a ‘bottom still’ B below, m vertical strings to the left of \mathcal{E} and n to the right, and then a ‘top still’ T above. (cf. Figure 19 for a schematic illustration). In more detail (cf. Def. 5.):

Definition 17 *By a “flicker”. will be meant one of two types of object:*

TYPE ONE: *an ordered 5-tuple*

$$\mathcal{F} = (\mathcal{E}, B, m, n, T) \tag{2}$$

where \mathcal{E} is an elementary transition, B and T are stills (either or both of which may be empty), m and n are natural numbers (which may be 0), such that the two following relations are satisfied:

$$\text{target}(B) = m + \text{in}(\mathcal{E}) + n \tag{3a}$$

$$\text{source}(T) = m + \text{out}(\mathcal{E}) + n \tag{3b}$$

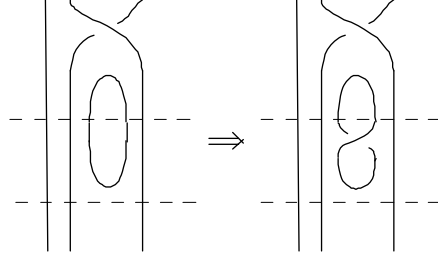

Figure 20: $(\mathcal{E}, 1_3, 2, 1, [2, Cap, 1][1, NW, 0])$

(with $in(\mathcal{E}), out(\mathcal{E})$ as defined in Def.16.) This being the case, we then define the source and target of the flicker \mathcal{F} , to be the stills

$$source(\mathcal{F}) = T \circ (m \bullet source(\mathcal{E}) \bullet n) \circ B \quad (4a)$$

$$target(\mathcal{F}) = T \circ (m \bullet target(\mathcal{E}) \bullet n) \circ B \quad (4b)$$

(cf. Defs.8 and 9), and we then write

$$\mathcal{F} : source(\mathcal{F}) \Longrightarrow target(\mathcal{F})$$

If \mathcal{E} is of type i (so $0 \leq i \leq 8$) then we shall also say that the flicker \mathcal{F} is of type i .

TYPE TWO: a symbol of the form

$$1_S \quad (5)$$

where S is a still; both the source and target of this flicker are defined to be S .

EXAMPLE: Let $\mathcal{E} = ET1R$ (cf.Fig. 9), then the flicker

$$(\mathcal{E}, 1_3, 2, 1, [2, Cap, 1][1, NW, 0])$$

is represented by Figure 20.

Proposition and Definition 18 Let \mathcal{F} denote a flicker, with source S and target T ; then

$$source(S) = source(T) \text{ and } target(S) = target(T) .$$

By $in(\mathcal{F})$ will be meant the common value of $source(S)$ and $source(T)$, while by $out(\mathcal{F})$ will be meant the common value of $target(S)$ and $target(T)$.

PROOF: We must consider two cases:

If

$$\mathcal{F} = (\mathcal{E}, B, m, n, T)$$

is of type (2) in Def.17, then by (4a) and (4b), $source(\mathcal{F})$ and $target(\mathcal{F})$ both have sources equal to $source(B)$, and targets equal to $target(T)$

On the other hand, if \mathcal{F} has the form 1_U , then $S = T = U$.

Q.E.D.

Definition 19 *Let \mathcal{F} be a flicker, and let p, q be natural numbers; then by $p \bullet \mathcal{F} \bullet q$ will be meant the flicker defined as follows:*

Case 1) If $\mathcal{F} = (\mathcal{E}, B, m, n, T)$ is of type (2) in Def.17, then (cf. Def.9)

$$p \bullet \mathcal{F} \bullet q := (\mathcal{E}, p \bullet B \bullet q, p + m, q + n, p \bullet T \bullet q)$$

Case 2) If $\mathcal{F} = 1_U$ then

$$p \bullet \mathcal{F} \bullet q := 1_{p \bullet U \bullet q}$$

We next extend to flickers, the action of the group \mathcal{SYM} on elementary transitions, given in Defs.12, 13 and 14. It suffices to define the action on flickers, of the commuting generators R, t and f :

Definition 20 *Let \mathcal{F} be a flicker; then we define $R \cdot \mathcal{F}$, $t \cdot \mathcal{F}$ and $f \cdot \mathcal{F}$ as follows:*

Case 1) If $\mathcal{F} = (\mathcal{E}, B, m, n, T)$ is of type (2) in Def.17, then we set

$$R \cdot \mathcal{F} := (R \cdot \mathcal{E}, B, m, n, T),$$

$$t \cdot \mathcal{F} := (t \cdot \mathcal{E}, t \cdot T, m, n, t \cdot B),$$

$$f \cdot \mathcal{F} := (f \cdot \mathcal{E}, f \cdot B, m, n, f \cdot T).$$

Case 2) If $\mathcal{F} = 1_U$ (for some still U) then we set

$$R \cdot \mathcal{F} := \mathcal{F}; \quad t \cdot \mathcal{F} := 1_{t \cdot U} \quad \text{and} \quad f \cdot \mathcal{F} := 1_{f \cdot U}.$$

The following definition should be compared with Def.7.

Definition 21 *A Carter-Rieger-Saito movie (or simply movie, when there is no danger of confusion with other senses of ‘movie’⁷) is defined to be a finite non-empty sequence of flickers,*

$$M = (F_1, \dots, F_s) \tag{6}$$

⁷Some different senses of the word ‘movie’ may be found, for instance, in [CS1], which involves a sense proposed earlier by Carter and Saito involving only one rather than two time-orientations, in ([CS2], §1.4) and in [Ka], Chapter 8.

such that the flickers F_i satisfy

$$\text{target}(F_i) = \text{source}(F_{i+1}) \text{ for } 1 \leq i < s .$$

By the source of a movie M , will be meant the source of its first flicker, i.e. $\text{source}(F_1)$ if (6) holds, while its target is defined to be the target of its last flicker, i.e. $\text{target}(F_s)$. If the stills S, T are the source (resp. target) of the movie M , we write $M : S \implies T$. We shall often use a multiplicative notation to express (6), writing instead

$$M = F_1 F_2 \dots F_s .$$

Finally, we define $\text{in}(M)$ to be the common value of all $\text{in}(F_i)$, and $\text{out}(M)$ to be the common value of all $\text{out}(F_i)$.

As elucidated in [BL] and [LL], movies take part in an intricate structure, a small portion of which which has already been defined above. For the purposes of the present paper, we shall only need the further structure on movies given by the following four definitions (which will play a role in the discussion below (§2.6) of movie-moves).

Definition 22 *Let*

$$M = F_1 \cdots F_s, \quad M' = F'_1 \cdots F'_t$$

be two movies. We shall say that M is composable with M' if the target of M equals the source of M' , ie if

$$\text{target}(F_s) = \text{source}(F'_1)$$

—in which case the composite movie $M \circ M'$ is defined to be the movie consisting of the sequence

$$(F_1, \dots, F_s, F'_1, \dots, F'_t)$$

of $s + t$ flickers.

NOTE: In [BL] this is called the **vertical composite**; movies modulo movie-moves have a structure of 2-category, which means there is also defined another operation on movies (modulo movie-moves), the **horizontal composite**, which will not be utilized in this paper. We here choose the ordering-convention for vertical composition, which coincides with that in [BL] and [LL].

Definition 23 Let $M = (F_1, \dots, F_s)$ be a movie, and let m, n be natural numbers.

Then (cf. Def.19) we define $m \bullet M \bullet n$ to be the movie

$$(m \bullet F_1 \bullet n, \dots, m \bullet F_s \bullet n)$$

Definition 24 Let

$$M = (F_1, \dots, F_s)$$

be a movie, with

$$\text{in}(M) = m, \text{out}(M) = n$$

(so each still F_i of M has m strings leading into the bottom, and n strings leading out the top.) Let S, T be stills, such that

$$\text{target}(S) = m, \text{source}(T) = n ;$$

then we define $S \circ M \circ T$ to be the movie

$$((S \circ F_1 \circ T), \dots, (S \circ F_s \circ T))$$

(cf. Def.8)

Finally, we define the action of the group \mathcal{SYM} on movies. It suffices to define the action on movies, of the commuting generators R, t and f :

Definition 25 Let

$$M = (F_1, \dots, F_s)$$

be a movie; then we define :

$$R \cdot M := (R \cdot F_s, \dots, R \cdot F_1)$$

$$t \cdot M := (t \cdot F_1, \dots, t \cdot F_s),$$

$$f \cdot M := (f \cdot F_1, \dots, f \cdot F_s).$$

2.4 Notation for Stills, Flickers, and Movies

In order for the reader to utilize the program 2KnotsLib (in particular, for computing \mathcal{U} -regular amplitude-invariants of movies), we now need to explain the notation used, both for some of the mathematical arguments in this paper, and also used to input stills, flickers and movies into that program.

NOTE: Unfortunately, in trying to ensure the two programs C++2KnotsLib and Java2KnotsLib were written fairly independently (and so could be used

to check one another’s results), slightly different methods of inputting data were developed for these two programs. The notation explained in this sub-section, is that originally developed for the library C++2KnotsLib and its driver programs. As indicated above, this notation will also be used in many of the proofs in the present paper.

- a) The other library, Java2KnotsLib, cheerfully accepts all the notation explained in this sub-section, with one exception:
 what the C++ version denotes by 1_n , the Java version only accepts as $[n_1, null, n_2]$ with $n_1 + n_2 = n$ (case insensitive, i.e. *Null* is OK).
- b) The Java version *also* accepts some other slight variations in this section’s notation, as explained in the ReadMe for the Java version. The C++ version *only* accepts the notation next to be explained.

The notation for stills used in this paper, will be that explained in the preceding § 2.1 —so, for example, the notation for the still in Fig. 7 is $[2, NW, 0][1, Cap, 1][0, NE, 0]$. Note the framed event 1_n is written without square brackets. This is practically the notation used in [CS]—slightly modified to facilitate inputting via keyboard where the [CS] notation is, rather, more suitable for coding into T_EX— e.g. $[2, Cup, 0]$ here replaces the Carter-Saito $\cup_{2,0}$. We here translate their X, \bar{X} by NW, NE —this choice of translation involves an arbitrariness caused by the symmetry f . We again remind the reader, that our time-ordering convention for stills runs from bottom to top of the page—this is (alas) the opposite of the convention used in [CS] and in [CRS].

We next need a notation for flickers. One unambiguous notation is furnished by (2) and (5) of Def. 17, but we also need a notation which describes a flicker in terms of its source and target. For this purpose, a little care is needed:

CAUTION: Let F be a flicker, with source S and target T . As was noted above, if F is an elementary transition, F is uniquely determined by S and T . **This is not true for flickers in general.** For example, (cf. [CS],p.35), if

$$S = [0, Cup, 0][0, Cap, 0] , T = [0, Cup, 0][0, Cap, 0][0, Cup, 0][0, Cap, 0] \quad (*)$$

we have

$$F, F' : S => T$$

for the *distinct* flickers

$$F = (ET6R, 1_0, 0, 0, [0, Cup, 0][0, Cap, 0]), F' = (ET6R, [0, Cup, 0][0, Cap, 0], 0, 0, 1_0)$$

with notation as in (2) in Def.17. (These are pictured in Fig. 21.) Thus, we need a notation for flickers, which determines explicitly which ‘path’ from S to T is intended.

The notation used here, which we call the ‘**sf-notation**’, solves this problem in the way now to be described. (Note however that two other, rather different, solutions may be found in the literature: one in in [CRS], [CS] and the other in [BL], [LL]).

Consider the flicker represented (in the notation of Def. 17) as

$$\mathcal{F} = (\mathcal{E}, B, m, n, T) .$$

Let

$$B = F_1 \cdots F_u , T = F'_1 \cdots F'_v$$

express the stills B, T as sequences of framed events (here read, the reader is reminded, from the bottom of the page to the top.) We wish to express, in our notation, the way this flicker is derived from its source

$$source(\mathcal{E}) = (F_1 \cdots F_u) \circ (m \bullet source(\mathcal{E}) \bullet n) \circ (F'_1 \cdots F'_v)$$

and its target

$$target(\mathcal{E}) = (F_1 \cdots F_u) \circ (m \bullet target(\mathcal{E}) \bullet n) \circ (F'_1 \cdots F'_v)$$

Then here is the ‘sf-notation’ for this flicker F :

$$F = [(F_1 \cdots F_u)s(m \bullet source(\mathcal{E}) \bullet n)s(F'_1 \cdots F'_v)] => [(F_1 \cdots F_u)f(m \bullet target(\mathcal{E}) \bullet n)f(F'_1 \cdots F'_v)]$$

Thus, in the source of F , s—for ‘start’—frames the source ⁸ $m \bullet source(\mathcal{E}) \bullet n$ of the framed elementary transition $m \bullet \mathcal{E} \bullet n$, while in the target of F , f—for finish—frames the target $m \bullet target(\mathcal{E}) \bullet n$ of $m \bullet \mathcal{E} \bullet n$. The addition of these two s and f’s to our notation, precisely resolves the ambiguity explained at the start of this section.

NOTE: If the flicker F is of type i , there is the option of expressing this fact by writing i immediately after the symbol $=>$. The program works perfectly well if this i is omitted (it knows how to compute i from the source and target decorated with s and f), but including the i allows the program to give a better diagnostic message if the input contains some error.

For instance, returning to the situation pictured in Fig. 21, the two flickers $F, F' : S => T$ described above, may now be written (unambiguously) as

⁸This source $m \bullet source(\mathcal{E}) \bullet n$ may be ‘empty’, as in the two flickers next described—in which case it is denoted by 1_0 . Similarly for the target $m \bullet target(\mathcal{E}) \bullet n$.

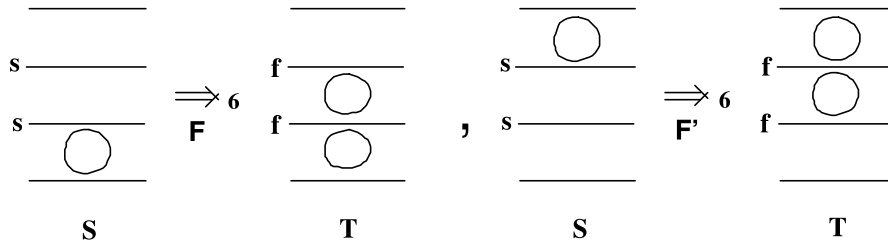

Figure 21: Two flickers for same still pair (S,T)

$F = [$
 $s1_0s [0, Cup, 0] [0, Cap, 0] => f [0, Cup, 0] [0, Cap, 0] f [0, Cup, 0] [0, Cap, 0]]$

and

$F' = [$
 $[0, Cup, 0] [0, Cap, 0] s1_0s => [0, Cup, 0] [0, Cap, 0] f [0, Cup, 0] [0, Cap, 0] f]$

respectively. (There is in each case the option of writing $=>$ as $=> 6$.) For another example, we observe there is yet a third path (this time involving two steps) from S to T , (pictured in Fig. 22) consisting of the flicker

$[[0, Cup, 0] ss [0, Cap, 0] => [0, Cup, 0] f1_2f [0, Cap, 0]]$

of type ET0, followed by the flicker

$[[0, Cup, 0] s1_2s [0, Cap, 0] => [0, Cup, 0] f [0, Cap, 0] [0, Cup, 0] f [0, Cap, 0]]$

of type ET7. We may combine these two flickers, to obtain the following movie (with source S and target T) in sf-notation:

MOVIE A: $[0, Cup, 0] ss [0, Cap, 0] => [0, Cup, 0] sf1_2fs [0, Cap, 0] => [0, Cup, 0] f [0, Cap, 0] [0, Cup, 0] f [0, Cap, 0]$

We shall see many more examples below, of movies in sf-notation—for now, let us make just five observations on this first example in this paper, Movie A, of a movie with more than one flicker:

- Just as in this example, so also for the sf-notation for any movie containing more than one flicker—the first still contains two s's, the last still contains 2 f's, and all intermediate stills contain both. **We make the convention that, for a movie consisting of a single flicker $1_S : S => T$, we omit both s and f.**

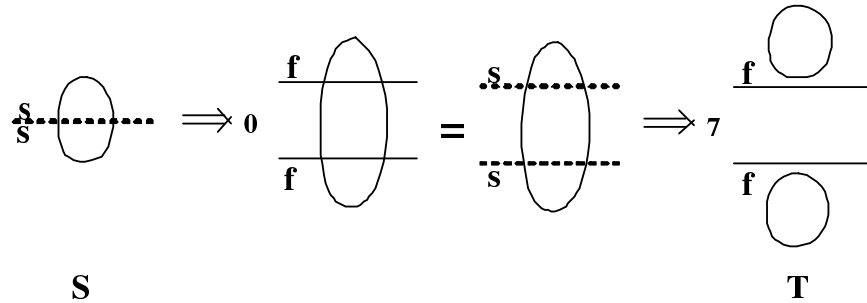

Figure 22: Movie A

- In a single still it is permitted that two s's or two f.s shall be adjacent— ss is then interpreted as $s1_0s$ (so that the first flicker of Fig.21 could also be input as

$$F = [ss [0, Cup, 0] [0, Cap, 0] \Rightarrow f [0, Cup, 0] [0, Cap, 0] f [0, Cup, 0] [0, Cap, 0]]$$

- It is permitted that an s be adjacent to an f—in such a situation, their ordering is irrelevant. (For example, it would make no difference if, in the second still in Movie A above, one had instead written

$$[0, Cup, 0] fs1_2fs[0, Cap, 0]$$

or...)

- We have used a double arrow \Rightarrow to indicate a flicker, motivated by the fact that, in the Baez-Langford theory, flickers are 2-morphisms. Following this double arrow, we write a number 0 to 8, indicating the **type** of the flicker—in our program, this is **optional**—these integers may be omitted on some or all double arrows when inputting a movie. If the option to supply some or all of these numbers is chosen, it helps the program check the input for errors.
- The square brackets $[]$ framing the description of a flicker are optional—for instance, they are omitted for all the movies in §4.

Many more examples of this notation will occur in §4, giving further illustrations of the points just made. When using the program(s) explained in this paper, the notation accepted by the program(s) is that just explained—the further necessary details (how the program input begins and ends a

movie, how comments are written, etc.) will be found carefully explained for each program in a ReadMe file supplied on the URL from which the program is to be downloaded.

2.5 Movie-isotopy and the Carter-Rieger-Saito Movie-move Theorem

Definition 26 *A movie M will be called compact if its source and target are both the empty still, i.e. if*

$$source(M) = target(M) = 1_0$$

In [CS] and [CRS] it is explained how every compact movie defines an isotopy-class of knotted surfaces (in \mathbb{R}^4), and it is proved that every isotopy-class of knotted surfaces arises this way. The question immediately suggests itself: Given two compact movies M, M' , when do they give rise to the same isotopy-class of knotted surfaces? Let us say that two compact movies M, M' are isotopic when this is the case.

Note that *a priori*, this relation between movies is (at least, in terms of its definition) topological rather than purely combinatorial; the work of Carter, Rieger and Saito converts this to an equivalent purely combinatorial notion, in a way next to be described.

This notion of isotopy between movies has an immediate generalization to non-compact movies, as follows. Recall that the composite movie $A \circ B$ is defined whenever A, B are movies with

$$source(A) = target(B) .$$

Definition 27 *Let M, M' be movies, not necessarily compact. M and M' are defined to be isotopic when the two following statements hold:*

- a) $source(M) = source(M')$ and $target(M) = target(M')$,
- and
- b) For all movies A, B of the type

$$A : [1_0] \Rightarrow source(M), B : target(M) \Rightarrow [1_0]$$

the movies $A \circ M \circ B$ and $A \circ M' \circ B$ (both necessarily compact) are isotopic.

We now turn to the beautiful theorem of Carter, Rieger and Sato (extending earlier work of Roseman, and of Carter and Saito—cf. [R],[R2],

and [CS1],[CS2]) which answers (though perhaps non-effectively) the question just raised above. The statement of this theorem, involves an infinite collection \mathcal{MM} of “**movie-moves**”, first constructed completely⁹ by Carter,Rieger and Saito ([CRS]), which play for knotted surfaces the same role played in the lower-dimensional theory by: the Reidemeister and Yetter moves (or more precisely, by the framings of these.)

A more detailed study of \mathcal{MM} will be the subject of §2.6 below. A few preliminary observations for now:

The elements of \mathcal{MM} are ordered pairs of movies (not necessarily compact). We shall sometimes use the notation $(M == M')$ to denote an ordered pair (M, M') in \mathcal{MM} —as this notation is intended to suggest, M is always isotopic to M' when $(M == M')$ is a movie-move. (However, the converse is certainly not true.)

We are now ready to state (without proof—for proof, the reader is referred to [CS] and [CRS]) what may be regarded as the fundamental theorem concerning the matters here under study. (Note this is a higher-dimensional analogue of the Theorem 4 asserted above.)

Theorem 28 (Carter-Rieger-Saito) *Let M and M' be two movies; then, M and M' are isotopic, if and only if it is possible to go from M to M' by a finite sequence*

$$M = M_0, M_1, \dots, M_s = M'$$

of movies, such that, for each i with $1 \leq i < s$,

$$(M_i, M_{i+1}) \in \mathcal{MM} .$$

2.6 The Set \mathcal{MM} of Movie-Moves

The construction of a set \mathcal{MM} so that Th. 28 shall hold, seems to require much greater effort than the analogous construction, by explicit enumeration, of \mathcal{ET} in §2.2 above. The first completely explicit enumeration of the set of Carter-Rieger-Saito movie-moves— in particular, sufficiently explicit to enable putting these matters in a program— seems (to the present authors) to be that furnished by Baez and Langford in ([BL], p.47-50) and also in ([LL],p.44-50). The earlier construction given in [CRS], and a bit later in [CS2], while essentially correct topologically, seems to present the following combinatorial difficulty:

⁹This enumeration of \mathcal{MM} by Carter, Rieger and Saito, presents one possible difficulty, at least in terms of the explicitness needed for programming purposes. This difficulty was fixed up in the later work of Baez and Langford([BL],[LL])—as explained in the discussion at the beginning of §2.6.

After giving a list of movie-moves on pages 75–78 in [CS], which supply a proper subset of \mathcal{MM} , Carter and Saito then explain, (on p.74), rules for enlarging this subset to the full collection \mathcal{MM} : **“Furthermore, we include the following four variations to the list”**. The fourth of these ‘variations’, involves the following instructions:

“Change X to \bar{X} and vice versa in the relations consistently whenever possible....¹⁰ Thus a given sentence may also be valid with such a replacement, and there is a move on sentences when these (and similar) replacements are valid. Add such variations to the list...”

As the present authors interpret these instructions for constructing ‘variations’ on the original smaller list of movie-moves, they involve an easier combinatorial part, (recognizing which changes are ‘consistent’), and a much harder topological part (recognizing which variations are ‘valid’):

As applied to a movie-move $M \equiv M'$, the easier part involves changing some (not necessarily all) NE’s to NW’s and vice-versa, in all possible ways such that the resulting pair (\bar{M}, \bar{M}') is again acceptable —“consistent”— in some sense not explicitly stated in [CRS]. Results seem compatible with those in [BL] if we interpret “consistent” as meaning, that \bar{M} and \bar{M}' are again movies, such that

$$source(\bar{M}) = source(\bar{M}') \text{ and } target(\bar{M}) = target(\bar{M}') .$$

The harder topological part then seems to require recognizing, for which of these newly constructed consistent pairs, \bar{M} and \bar{M}' are isotopic (which seems to be the meaning here of ‘valid’) —while not undecidable, this still involves a hefty sequence of rather nontrivial topological exercises in order to construct \mathcal{MM} following these instructions. Let us note also that the set of movie-moves (M, M') to which these instructions must be applied, is infinite.

In other words, this construction of the set \mathcal{MM} seems not to be purely *combinatorial*—while this is perhaps not so relevant to the original purposes of [CRS], it is an important obstacle to the purposes of the present paper.

These auxiliary topological exercises are not required (or have already been carried out) in the purely combinatorial construction of \mathcal{MM} presented by Baez and Langford (in [BL] and [LL]), which the present authors found invaluable for the insertion of the relevant movie-moves into the program for computing amplitudes made available in footnote 2, as well as for the

¹⁰Note: In the notation used in the present paper, X, \bar{X} are replaced by NW, NE respectively.

purely mathematical considerations in §3.2. (We are indebted to Carter for suggesting to us, that the work of Baez and Langford would be useful for the requirements of our program in this connection.)

CAUTION: Prof. Langford has informed us about the following erratum in the construction in [BL] and [LL] just discussed: namely, there is a typo in the movie-move numbered 14 in [BL] and 21 in [LL], which can be corrected as follows: replace the fourth flicker in the left-hand movie by

$$B_{i;m,n} J_{A;m+1,n} X_{m,n+2}$$

both in [LL] and in [BL]; and, in [LL], replace the third flicker in the right-hand movie by

$$\cap_{m,n+2} W_{i;m+1,n} .$$

Here are some useful definitions, suggested by the preceding discussion:

Definition 29 *Let M, M' be two movies.*

- a) *The ordered pair (M, M') will be called **grammatical** provided M and M' have the same source and the same target.*
- b) *The ordered pair (M, M') will be called **valid** provided that M and M' are isotopic.*

REMARKS: ‘valid’ implies ‘grammatical’, but not conversely. Note that the assertion: ‘ (M, M') is grammatical’ is purely combinatorial, and its truth-value is easily decided, while the assertion ‘ (M, M') is valid’ seems to lie much deeper. The present authors do not know if ‘validity’ (in this sense) is effectively decidable. All movie-moves are valid, hence are grammatical.

Proposition and Definition 30 *If the ordered pair of movies $\mathcal{M} = (M, M')$ is grammatical (hence a fortiori if it is valid) then*

$$\text{in}(M) = \text{in}(M'), \text{out}(M) = \text{out}(M')$$

(in which case let us define $\text{in}(\mathcal{M})$ to be the common value of $\text{in}(M), \text{in}(M')$, and similarly $\text{out}(\mathcal{M})$ to be the common value of $\text{out}(M), \text{out}(M')$)

PROOF: Immediate.

Let us now begin to examine more carefully the collection of movie-moves constructed in [BL], pp.47-50. The construction in [LL] is essentially

the same, but here the formulation in [BL] will be preferred, because it has the desirable feature of utilizing the same numbering for the movie-moves, that is used in [CS] and in [CRS]. **In the following, when we say a movie-move is of type i , it is always this numbering to which reference is made.** In [BL], the notation they use is that explained at the end of §2.2 in the present paper; in our discussion of the work of Baez and Langford, we shall translate their notation into the “ sf -notation” explained above in §2.4.

AT THIS POINT, AN IMPORTANT COMPLICATION ARISES:

To be quite precise concerning the set \mathcal{MM} , we must note that while Baez-Langford ([BL]) have 30 basic types of movie-moves, Carter-Rieger-Saito ([CRS]) have a 31st type of movie-move, (the last in the list on pp.75–79 in [Carter-Saito]), which is omitted from the list in Baez-Langford. On p.47 of [BL], Baez and Langford say concerning this, “We omit their 31st movie-move, since it follows from the definition of a 2-category.” Thus, two possible candidates for \mathcal{MM} seem to present themselves: the one consisting of 31 types, as defined by [CRS] with the difficulty explained above, the other as defined more explicitly in [BL] and [LL] and consisting only of the first 30 types in [CRS].

For our present paper, the set \mathcal{MM} must be defined so that Th.28 holds. We shall prove below that Th.28 would NOT hold (at least, as here stated), if we took \mathcal{MM} to consist only of movie-moves of types 1–30. Thus, for the purposes of the present paper, we must consider (as do Carter-Rieger-Saito in their original proof of Th.28) \mathcal{MM} as also including all these movie-moves of type 31. We shall thus adopt the notation

$$\mathcal{MM} = \mathcal{MM}_{BL} \cup \mathcal{MM}_{31} \tag{3}$$

where \mathcal{MM}_{BL} denotes the set of movie-moves of types 1–30, as explicitly defined in [BL]— while \mathcal{MM}_{31} denotes the set of movie-moves of type 31, as explicitly defined in §2.7 below, and further discussed in §3.3. More generally, we denote the set of all movie-moves of type i by \mathcal{MM}_i , for $1 \leq i \leq 31$.

We must note explicitly that, as a consequence of [BL] and [LL], Th.28 indeed holds with the definition of \mathcal{MM} just indicated.

2.7 Movie-move 31

We now turn to the explicit definition of movie-moves of type 31, in terms of the sf -notation explained in §2.4. First, here is how the movie-moves of type 31 are defined on p.76 of [CS]:

“($WZ_1Z_2V, WZ'_1Z_2V, WZ'_1Z'_2V$) \leftrightarrow ($WZ_1Z_2V, WZ_1Z'_2V, WZ'_1Z'_2V$) where the changes Z_i to Z'_i for $i=1,2$ are FESI’s.”

We next translate this into our *sf*-notation. (It must be admitted this looks a bit clumsier in our present more explicit *sf*-notation, which however seems better-suited for some later computations in §3.3 below.)¹¹

Definition 31 *Let*

$$E_1 : U_1 \Rightarrow V_1 \text{ and } E_2 : U_2 \Rightarrow V_2$$

be two elementary transitions (not necessarily different); and let

$$m_1, n_1, m_2, n_2$$

be natural numbers such that

$$m_1 + \text{out}(E_1) + n_1 = m_2 + \text{in}(E_2) + n_2 ; \quad (4)$$

then we define (cf. Fig. 23)

$$\mathcal{M}(E_1, E_2; m_1, n_1, m_2, n_2) = (M_1, M_2) \quad (5)$$

*to be the ordered pair of movies given (in *sf*-notation), by:*

$$\begin{aligned} M_1 = [& \\ & (m_2 \bullet U_2 \bullet n_2) \circ s(m_1 \bullet U_1 \bullet n_1) s \\ & \Rightarrow t(E_1) \\ & s(m_2 \bullet U_2 \bullet n_2) s \circ f(m_1 \bullet V_1 \bullet n_1) f \\ & \Rightarrow t(E_2) \\ & f(m_2 \bullet V_2 \bullet n_2) f \circ (m_1 \bullet V_1 \bullet n_1) \\ &] \end{aligned}$$

and by

$$\begin{aligned} M_2 = [& \\ & s(m_2 \bullet U_2 \bullet n_2) s \circ (m_1 \bullet U_1 \bullet n_1) \\ & \Rightarrow t(E_2) \\ & f(m_2 \bullet V_2 \bullet n_2) f \circ s(m_1 \bullet U_1 \bullet n_1) s \\ & \Rightarrow t(E_1) \\ &] \end{aligned}$$

¹¹By “FESI” [CS] mean, what we are here calling “elementary transition”. To obtain Def.31 from the [CS] definition, we replace:

$$F_i : Z_i \text{ to } Z'_i \text{ by } E_i : U_i \Rightarrow V_i, W \text{ by } W, V \text{ by } X .$$

$$\begin{array}{c}
M_1: \quad \left| \begin{array}{c} \dots \\ m_2 \end{array} \right| \left| \begin{array}{c} U_2 \\ n_2 \end{array} \right| \left| \begin{array}{c} \dots \\ m_2 \end{array} \right| \left| \begin{array}{c} \dots \\ n_2 \end{array} \right| \xRightarrow{E_2} \left| \begin{array}{c} \dots \\ m_2 \end{array} \right| \left| \begin{array}{c} V_2 \\ n_2 \end{array} \right| \left| \begin{array}{c} \dots \\ m_1 \end{array} \right| \left| \begin{array}{c} \dots \\ n_1 \end{array} \right| \\
\left| \begin{array}{c} \dots \\ m_1 \end{array} \right| \left| \begin{array}{c} U_1 \\ n_1 \end{array} \right| \xRightarrow{E_1} \left| \begin{array}{c} \dots \\ m_1 \end{array} \right| \left| \begin{array}{c} V_1 \\ n_1 \end{array} \right| \left| \begin{array}{c} \dots \\ m_1 \end{array} \right| \left| \begin{array}{c} \dots \\ n_1 \end{array} \right| \\
\\
\\
M_2: \quad \left| \begin{array}{c} \dots \\ m_2 \end{array} \right| \left| \begin{array}{c} U_2 \\ n_2 \end{array} \right| \xRightarrow{E_2} \left| \begin{array}{c} \dots \\ m_2 \end{array} \right| \left| \begin{array}{c} V_2 \\ n_2 \end{array} \right| \left| \begin{array}{c} \dots \\ m_2 \end{array} \right| \left| \begin{array}{c} \dots \\ n_2 \end{array} \right| \\
\left| \begin{array}{c} \dots \\ m_1 \end{array} \right| \left| \begin{array}{c} U_1 \\ n_1 \end{array} \right| \left| \begin{array}{c} \dots \\ m_1 \end{array} \right| \left| \begin{array}{c} \dots \\ n_1 \end{array} \right| \xRightarrow{E_1} \left| \begin{array}{c} \dots \\ m_1 \end{array} \right| \left| \begin{array}{c} V_1 \\ n_1 \end{array} \right| \left| \begin{array}{c} \dots \\ m_1 \end{array} \right| \left| \begin{array}{c} \dots \\ n_1 \end{array} \right|
\end{array}$$

Figure 23: Movie Move 31

$$\begin{array}{l}
(m_2 \bullet V_2 \bullet n_2) \circ f(m_1 \bullet V_1 \bullet n_1) f \\
]
\end{array}$$

(Recall that if E is an elementary transition of type i , we have set $t(E) = i$.)
We then define a **movie-move of type 31** to be an ordered pair of movies

$$(W \circ (M_1) \circ X, W \circ (M_2) \circ X) \tag{6}$$

where W, X are stills and either (M_1, M_2) or (M_2, M_1) is an ordered pair of the form (5) with each of which W, X are composable. We denote the set of all movie-moves of type 31 by \mathcal{MM}_{31} .

2.8 Some of the Structure on the Set \mathcal{MM} of Movie-Moves

In the first place, we have

$$\mathcal{MM} = \bigcup_{1 \leq i \leq 31} \mathcal{MM}_i = (\mathcal{MM}_{BL}) \cup \mathcal{MM}_{31}$$

where, for $1 \leq i \leq 31$, \mathcal{MM}_i is the set (infinite for each such i) of all movie-moves of type i , and where

$$\mathcal{MM}_{BL} = \bigcup_{1 \leq i \leq 30} \mathcal{MM}_i.$$

Let us next note that every movie-move is valid, and hence grammatical (in the sense of Def. 29).

We next describe some structure on the set $\mathcal{M}\mathcal{M}^+$ of all grammatical ordered pairs of movies—i.e., the set

$$\{(M, M') \mid M \text{ and } M' \text{ are movies, } source(M) = source(M'), target(M) = target(M')\}$$

(It will then be proved that this structure is inherited via

$$\mathcal{M}\mathcal{M}_{BL} \subseteq \mathcal{M}\mathcal{M}^+$$

by the set $\mathcal{M}\mathcal{M}_{BL}$, at least in the sense given by Prop.40 below.)

Definition 32 *Let (M, M') be a grammatical ordered pair of movies, and let B, C be two stills. Then we shall say B, C are composable with (M, M') , provided that*

$$target(C) = in(M)(= in(M')), source(B) = out(M)(= out(M')) \quad (7)$$

(cf. Prop.30) in which case we define $B \circ (M, M') \circ C$ to be the pair of movies given by

$$B \circ (M, M') \circ C := (B \circ M \circ C, B \circ M' \circ C) \quad (8)$$

Definition 33 *Let (M, M') be a grammatical pair of movies, and let $\pi \in \mathcal{SYM}$; then we define $\pi \circ (M, M')$ to be the pair $(\pi \circ M, \pi \circ M')$*

Definition 34 *Let (M, M') be a grammatical pair of movies, and let m, n be natural numbers; then we define $m \bullet (M, M') \bullet n$ to be the pair*

$$(m \bullet M \bullet n, m \bullet M' \bullet n)$$

Definition 35 *Let (M, M') be a grammatical pair of movies; then we define $(M, M')^C$ — the converse of (M, M') — to be (M', M)*

We omit the easy proof of the following straightforward but useful proposition:

Proposition 36 *Let M, M' be a grammatical pair of movies.*

a) *Suppose the stills B, C are composable with (M, M') ; then also*

$$B \circ (M, M') \circ C$$

is grammatical. If also (M, M') is valid, so is $B \circ (M, M') \circ C$.

b) *If $\pi \in \mathcal{SYM}$ then $\pi \circ (M, M')$ is grammatical. If also (M, M') is valid, so*

is $\pi \circ (M, M')$.

c) Let m, n be natural numbers; then

$$m \bullet (M, M') \bullet n = (m \bullet M \bullet n, m \bullet M' \bullet n)$$

is grammatical, and is valid if (M, M') is.

d) $(M, M')^C$ is grammatical, and is valid if (M, M') is.

REMARK: In a sense, this proposition underlies the construction of the list \mathcal{MM} of movie-moves, both in [BL] and in [CRS]. The sense in which this is so will become clearer in a little while.

We have proceeded about as far as we can in this subsection, without actually examining the detailed explicit construction of \mathcal{MM}_{BL} in [BL]. To begin this examination, let us consider the case \mathcal{MM}_1 :

• **EXAMPLE A):** Thus, we begin by examining (in the light of the preceding definitions) the first movie-move in [BL]. (This is illustrated by Fig.52 on p.86 of [CS], where this movie-move has the bemusing name, “an elliptic confluence of branch points”. See also Fig. 24 in the present paper.)

For movie-move 1, [BL] (p.47) lists $W_{m,n}W_{m,n}^* = 1$. In the notation of the present paper, this is the movie-move $(M_1(m, n) == N_1(m, n))$, where

$$\begin{aligned} M_1(m, n) = [& \\ s[m, Cap, n]s & \\ => 1 & \\ sf[m, NW, n][m, Cap, n]sf & \\ => 1 & \\ f[m, Cap, n]f & \\] & \end{aligned}$$

and $N(m, n) = [[m, Cap, n]]$.

m and n represent arbitrary natural numbers, so we have here an infinity of movie-moves of type 1 (though not **all** movie-moves of type 1 are in this list.)

All movie-moves of type 1, can be derived (by processes next to be explained) from the single ‘reduced’ movie-move

$$(M_1^{red} == N_1^{red}) = (M(0, 0), N(0, 0))$$

obtained by setting $m = n = 0$ in the movie-move above.

To see how this works, note first that the most general movie-move of type 1, in the Carter-Rieger-Saito notation, reads

$$(W \cap_{m,n} V, W \cap_{m,n} X_{m,n} V, W \cap_{m,n} V) \leftrightarrow (W \cap_{m,n} V) \quad (9)$$

$$\begin{aligned}
M_1(m,n) &= \left[\underbrace{\left[\begin{array}{|c|} \hline \dots \\ \hline \end{array} \right]}_m \cap \underbrace{\left[\begin{array}{|c|} \hline \dots \\ \hline \end{array} \right]}_n \Rightarrow_1 \underbrace{\left[\begin{array}{|c|} \hline \dots \\ \hline \end{array} \right]}_m \text{ } \underbrace{\left[\begin{array}{|c|} \hline \dots \\ \hline \end{array} \right]}_n \Rightarrow_1 \underbrace{\left[\begin{array}{|c|} \hline \dots \\ \hline \end{array} \right]}_m \cap \underbrace{\left[\begin{array}{|c|} \hline \dots \\ \hline \end{array} \right]}_n \right] \\
N_1(m,n) &= \left[\underbrace{\left[\begin{array}{|c|} \hline \dots \\ \hline \end{array} \right]}_m \cap \underbrace{\left[\begin{array}{|c|} \hline \dots \\ \hline \end{array} \right]}_n \right] \\
M_1^{\text{red}} &= \left[\cap \Rightarrow_1 \text{ } \Rightarrow_1 \cap \right] \\
N_1^{\text{red}} &= \left[\cap \right]
\end{aligned}$$

Figure 24: Movie Move I. $M_1(m, n) == N_1(m, n)$ and $M_1^{\text{red}} == N_1^{\text{red}}$

(See also Fig. 25 in the present paper.) Here V and W denote arbitrary stills, subject to the composability conditions

$$\text{source}(W) = m + n, \text{ target}(V) = m + n + 2$$

In the notation explained in §2.4, combined with the above Def.32 (and switching from the [CRS] convention which reads stills from top to bottom, to the opposite convention utilized in the present paper) this movie-move (read from left to right) may be written:

$$V \circ (m \bullet M^{\text{red}} \bullet n) \circ W == V \circ (m \bullet N^{\text{red}} \bullet n) \circ W \quad (A)$$

where we define $[M^{\text{red}} == N^{\text{red}}]$, as above, to be the movie-move defined by:

$$M^{\text{red}} = [s[0, \text{Cap}, 0]s \Rightarrow_1 sf[0, \text{Cap}, 0][0, \text{NW}, 0]sf \Rightarrow_1 f[0, \text{Cap}, 0]f],$$

$$N^{\text{red}} = [[0, \text{Cap}, 0]].$$

—i.e. the infinitely many movie-moves given by (9), are all derived via (A) from the **single** ‘reduced’ movie-move

$$\mathcal{M}_1^{\text{red}} = (M^{\text{red}} == N^{\text{red}}) .$$

Finally, the most general movie-move of type 1, is obtained via this framing-process from one of the 8 ‘reduced’ movie-moves

$$\pi \circ (M^{\text{red}}, N^{\text{red}}) \quad (\pi \in \mathcal{SYM})$$

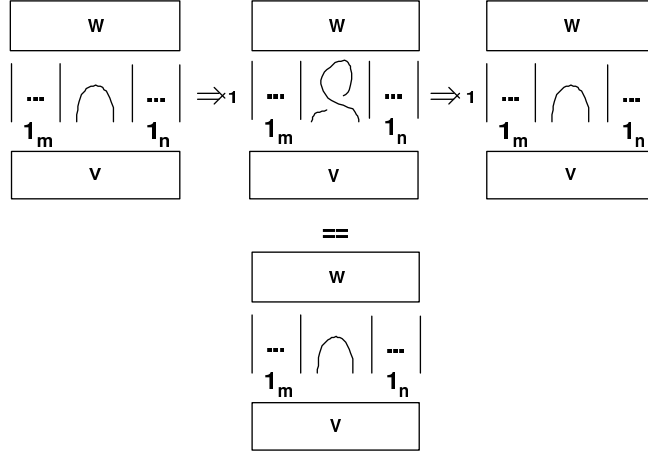

Figure 25: General Movie-Move of Type 1 (Carter-Rieger-Saito)

i.e. has the form

$$V \circ (m \bullet (\text{source}(\pi \circ \mathcal{M}_1^{\text{red}}) \bullet n) \circ W) = V \circ (m \bullet (\text{target}(\pi \circ \mathcal{M}_1^{\text{red}}) \bullet n) \circ W) \quad (B)$$

Precisely the same pattern holds throughout the entire construction of \mathcal{MM}_{BL} in [BL], that was just exhibited for movie-move 1. To explain this pattern in more detail, two further definitions will be helpful:

Definition 37 Given a grammatical pair of movies (M, N) , a pair $(\overline{M}, \overline{N})$ will be called **strictly derived from** (M, N) when either $(\overline{M}, \overline{N})$ or its converse has the form (A) , i.e., when there exist natural numbers m and n , and stills V and W , such that

$$\text{either } (\overline{M}, \overline{N}) \text{ or } (\overline{N}, \overline{M}) = (V \circ (m \bullet M \bullet n) \circ W, V \circ (m \bullet N \bullet n) \circ W) .$$

(Of course, this equation presupposes that V and W satisfy the composability conditions of Def. 32)

Definition 38 Given a grammatical pair of movies

$$\mathcal{M} = (M, N) ,$$

a pair $(\overline{M}, \overline{N})$ will be called **derived from** (M, N) **in the extended sense**, when there exists $\pi \in \mathcal{SYM}$ such that $(\overline{M}, \overline{N})$ is strictly derived from $\pi \circ \mathcal{M}$.

The above discussion of movie-moves of type 1 asserts, in terms of the two preceding definitions, that all movie-moves of type 1 are derived from a *single* “reduced” one $(M^{red}(1), N^{red}(1))$ by the derivation process (in the extended sense).

Having found this formulation. we next observe that it essentially holds more generally —with a suitable definition of ‘reduced’ movie-moves— for the entire list of movie-moves in [BL],p.47-50 (all of which have type < 31). To see this, it must first be noted that, for $1 \leq i \leq 30$, the movie-moves of type i listed in ([BL],p.47—50) consist of one or more movie-moves involving two arbitrary natural numbers m and n : i.e., the movie-moves there listed, are the elements of a set (possibly infinite, depending on i), this set being explicitly described in [BL], which has the form

$$\{(M_\alpha^{m,n}(i) == N_\alpha^{m,n}(i)) | \alpha \in \mathcal{P}_i\}$$

We then define (still for $1 \leq i \leq 30$) the BL-reduced movie-moves of type i to be the elements of the set¹²

$$\mathcal{MM}^{red}(i) := \{(M_\alpha^{0,0}(i) == N_\alpha^{0,0}(i)) | \alpha \in \mathcal{P}_i\} \quad (10)$$

obtained by setting $m = n = 0$ in the former set.

Example A illustrates this construction. Here are two more examples:

• **EXAMPLE B): $i=5$**

For movie-moves of type 5, ([BL]) lists 6 families involving two natural numbers m and n . These families are indexed by the set \mathcal{P}_5 consisting of the 6 elementary transitions which in the [BL] notation are

$S_0, S_1, S_2, S_0^*, S_1^*, S_2^*$; and, in the notation of the present paper, are: ET3tmb, ET3tbm, ET3mbt, ET3tmbR, ET3tbmR, ET3mbtR.

If $\mathcal{E} = [S \Rightarrow T]$ is one of these 6 elementary transitions in \mathcal{P}_5 , the corresponding family of movie-moves of type 5, is

$$((M_\mathcal{E}^{m,n}(5) == N_\mathcal{E}^{m,n}(5)))$$

where

$$M_\mathcal{E}^{m,n}(5) = [[m, S, n] \Rightarrow 3 [m, T, n] \Rightarrow 3 [m, S, n]]$$

and

$$N_\mathcal{E}^{m,n}(5) = [[m, S, n]]$$

—while the 6 BL-reduced movie-moves in $\mathcal{MM}^{red}(5)$ are obtained by setting $m = n = 0$ in the preceding.

¹²We shall also define later the set $\mathcal{MM}^{red}(31)$ in a somewhat more complicated way.

• **EXAMPLE C): $i=17$**

\mathcal{P}_{17} is infinite (as will become clear below in the proof of Prop. 50)—and so there are infinitely many BL-reduced movie-moves of type 17.

To sum up, the list in [BL],p.47-50, gives rise (by the procedure just described) to a collection (unfortunately still infinite) of “BL-reduced” movie-moves, from which every other movie-move may be obtained by the process explained in Def. 38 —more precisely:

Proposition 39 *Let $1 \leq i \leq 30$; then the collection*

$$\mathcal{MM}^{red}(i) := \{(M_\alpha^{red}(i) == N_\alpha^{red}(i)) | \alpha \in \mathcal{P}_i\} \quad (11)$$

of movie-moves, constructed above, has the property that an ordered pair \mathcal{M} of movies, is a movie-move of type i , if and only if \mathcal{M} is derived in the extended sense (i.e, in the sense of the preceding Def.38) from one of the movie-moves in the list (11).

As an immediate Corollary, we have (as promised above):

Proposition 40 *If (M, N) is any movie-move of type ≤ 30 , every pair derived from it in the extended sense is again a movie-move.*

We define the set of all BL-reduced movie-moves by

$$\mathcal{MM}_{BL}^{red} := \bigcup_{1 \leq i \leq 30} \mathcal{MM}_i^{red} \quad (12)$$

NOTE: Let $1 \leq i \leq 30$. The set of movie-moves of type i , as defined in [BL], is a **proper** subset of the set denoted in this paper by \mathcal{MM}_i —the latter set consists of all movie-moves derived from the former set via Def.32. (This more generous definition of \mathcal{MM} and \mathcal{MM}_i is needed, in this paper, so that Th.28 may hold.) The relation between these two sets is very simple, and may become clearer, upon comparing Figures 24 and 25.

3 \mathcal{U} -Regular Amplitude-Invariants for Movies, 2-Knots and 2-Tangles

Throughout this section, it will be convenient to replace the ground-ring $A = \mathbb{Z}[q, q^{-1}]$ by its quotient-field

$$\mathbb{K} := \mathbb{Q}(q)$$

(mainly because it is easier to handle systems of linear equations over \mathbb{K} than over A .) We denote by V_1 , the two-dimensional vector-space $V \otimes_A \mathbb{K}$ over \mathbb{K} . If S is a still, we shall (by a slight abuse of notation) denote the \mathbb{K} -linear transformation

$$\langle S \rangle \otimes_A \mathbb{K} : V_1^{\text{source}(S)} \rightarrow V_1^{\text{target}(S)}$$

simply by $\langle S \rangle$, and will continue to refer to it as the Kauffman bracket of S .

3.1 \mathcal{A} -Amplitudes for Elementary Transitions, Flickers and Movies

Definition 41 *By an **amplitude-assignment** will be meant a map \mathcal{A} which assigns to every elementary transition $E \in \mathcal{ET}$, a \mathbb{K} -linear map*

$$\langle E \rangle_{\mathcal{A}} : V_1^{\otimes \text{in}(E)} \longrightarrow V_1^{\otimes \text{out}(E)} .$$

*which will be called the **\mathcal{A} -amplitude** of E .*

Such an assignment of ‘amplitudes’ to elementary transitions, extends immediately to assignments of ‘amplitudes’ to flickers and to movies, as follows:

Definition 42 *Let \mathcal{A} be an amplitude-assignment, and let F be a flicker. Then the **\mathcal{A} -amplitude** of F is defined to be the \mathbb{K} -linear map*

$$\langle F \rangle_{\mathcal{A}} : V_1^{\otimes \text{in}(F)} \longrightarrow V_1^{\otimes \text{out}(F)}$$

constructed as follows:

By Def.17, F has one of the two forms (2) or (5).

Suppose first (2) holds, so $F = (\mathcal{E}, B, m, n, T)$ (as illustrated by Fig. 19).

Then we set

$$\langle F \rangle_{\mathcal{A}} := \langle T \rangle \circ (Id_{V_1^{\otimes m}} \otimes \langle \mathcal{E} \rangle_{\mathcal{A}} \otimes Id_{V_1^{\otimes n}}) \circ \langle B \rangle : V_1^{\otimes \text{in}(F)} \longrightarrow V_1^{\otimes \text{out}(F)}$$

(where $\langle B \rangle, \langle T \rangle$ denote the Kauffman brackets of the stills B, T .)

On the other hand, if (5) holds, so $F = 1_S : S \Rightarrow S$, where S is a still with source m and target n , then we define

$$\langle F \rangle_{\mathcal{A}} : V^m \longrightarrow V^n$$

to be simply the Kauffman bracket $\langle S \rangle$ (which we note is, in the case that (5) holds, of course independent of the choice of \mathcal{A}).

Definition 43 Let \mathcal{A} be an amplitude-assignment, and let

$$M = F_1 \cdots F_s$$

be a movie. Let us label the $s + 1$ stills of the movie M as follows:

$$S_1 = \text{source}(F_1), S_i = \text{source}(F_i) = \text{target}(F_{i-1}) \text{ for } 1 < i \leq s, S_{s+1} = \text{target}(F_s).$$

Then we construct as follows, a \mathbb{K} -linear map

$$\langle M \rangle_{\mathcal{A}}: V_1^{\otimes \text{in}(M)} \longrightarrow V_1^{\otimes \text{out}(M)}.$$

—which we shall call the **\mathcal{A} -amplitude of M** —
namely, this map is defined to be the alternating sum

$$\langle M \rangle_{\mathcal{A}} := \langle S_1 \rangle - \langle F_1 \rangle_{\mathcal{A}} + \langle S_2 \rangle - \langle F_2 \rangle_{\mathcal{A}} + \cdots - \langle F_s \rangle_{\mathcal{A}} + \langle S_{s+1} \rangle. \quad (13)$$

3.2 \mathcal{U} -balanced and Semi-normal Amplitude-Assignments

Define

$$\underline{31} := \{i \in \mathbb{Z} \mid 1 \leq i \leq 31\},$$

Throughout the following discussion, we shall let \mathcal{U} denote any proper subset of $\underline{31}$; and

$$\mathcal{U}^c := \{i \in \underline{31} \mid i \notin \mathcal{U}\}$$

will denote the non-empty complement of \mathcal{U} in $\underline{31}$.

The reader is asked to review the definition (in the Introduction) of \mathcal{U} -regular isotopy of movies (Def.2). Note that this equivalence relation on movies, is stronger than (or equal to) isotopy.

As a technique for manufacturing \mathcal{U} -regular isotopy invariants of movies, we shall utilize the \mathcal{A} -amplitude construction of Def.43.

Thus, we now turn to the question: when does the construction $\langle M \rangle_{\mathcal{A}}$ furnished by Def.43, yield \mathcal{U} -regular isotopy-invariants of movies?

Definition 44 Let \mathcal{A} be an amplitude-assignment. We define \mathcal{A} to be **\mathcal{U} -balanced** if it has this property:

Whenever M and M' are \mathcal{U} -isotopic movies—whence, by Prop.30,

$$\text{in}(M) = \text{in}(M'), \text{out}(M) = \text{out}(M')$$

—we then have

$$\langle M \rangle_{\mathcal{A}} = \langle M' \rangle_{\mathcal{A}}: V_1^{\otimes \text{in}(M)} \longrightarrow V_1^{\otimes \text{out}(M)}. \quad (14)$$

Definition 45 Let \mathcal{A} be an amplitude-assignment, and let

$$\mathcal{M} = (M_1, M_2)$$

be an ordered pair of movies. Then we say that \mathcal{A} respects \mathcal{M} if the following holds:

$$\langle M_1 \rangle_{\mathcal{A}} = \langle M_2 \rangle_{\mathcal{A}}$$

We note the following immediate consequence of our definitions:

An amplitude-assignment \mathcal{A} is \mathcal{U} -balanced, iff. it respects all movie-moves whose type is not in \mathcal{U} .

As it stands, to see if \mathcal{A} is \mathcal{U} -balanced, this criterion requires us to test, for every $i \in \mathcal{U}^c$, all movie-moves in the infinite set $\mathcal{M}\mathcal{M}_i$. However, the considerations in the remainder of this sub-section, and (to deal with movie-move 31) in the next, allow us to cut down, (at the cost of restricting to a smaller collection of ‘**semi-normal**’ amplitude-assignments, explained in Def. 48 below) to a finite number of tests, thus making feasible (as will be seen) a computer approach to these matters.

Proposition 46 Let \mathcal{A} be an amplitude-assignment, and let

$$\mathcal{M} = (M == N) \in \mathcal{M}\mathcal{M}$$

be a movie-move. Suppose \mathcal{A} respects \mathcal{M} .

a) Let B and C be stills, such that

$$\text{target}(C) = \text{in}(M), \text{ source}(B) = \text{out}(M)$$

(i.e., such that B, C is composable with \mathcal{M}). Then \mathcal{A} respects

$$B \circ \mathcal{M} \circ C := ((B \circ M \circ C) == (B \circ N \circ C))$$

b) Let m, n be natural numbers; then \mathcal{A} respects

$$m \bullet \mathcal{M} \bullet n := ((m \bullet M \bullet n) == (m \bullet N \bullet n)) .$$

PROOF:By hypothesis,

$$\langle M \rangle_{\mathcal{A}} = \langle M' \rangle_{\mathcal{A}}: V_1^{\otimes \text{in}(M)} \longrightarrow V_1^{\otimes \text{out}(M)}$$

We have

$$\langle B \circ M \circ C \rangle_{\mathcal{A}} = \langle B \rangle \circ \langle M \rangle_{\mathcal{A}} \circ \langle C \rangle = \langle B \rangle \circ \langle N \rangle_{\mathcal{A}} \circ \langle C \rangle = \langle B \circ N \circ C \rangle_{\mathcal{A}}$$

which proves a). Similarly,

$$\langle m \bullet M \bullet n \rangle_{\mathcal{A}} = 1_{V_1^{\otimes m}} \otimes \langle M \rangle_{\mathcal{A}} \otimes 1_{V_1^{\otimes n}} = 1_{V_1^{\otimes m}} \otimes \langle N \rangle_{\mathcal{A}} \otimes 1_{V_1^{\otimes n}} = \langle m \bullet N \bullet n \rangle_{\mathcal{A}}$$

which proves b).

Q.E.D.

As an immediate corollary, we have:

Proposition 47 *If an amplitude-assignment \mathcal{A} respects every element in a collection \mathcal{C} of ordered pairs of movies, then it respects every ordered pair of movies strictly derived from \mathcal{C} (in the sense of Def. 37).*

Next note, that if $E : S \Rightarrow T$ is an elementary transition of type either 0 or 8, then S and T have the same Kauffman amplitude. For this reason, the following definition makes sense:

Definition 48 *An amplitude-assignment \mathcal{A} will be called semi-normal when, for every elementary transition $E : S \Rightarrow T$ of type either 0 or 8,*

$$\langle E \rangle_{\mathcal{A}} = \langle S \rangle = \langle T \rangle .$$

As noted at the end of §2.6, we shall use the same numbering for movie-moves, as that employed in [CS],[CRS] and (except for the inclusion in the present paper of movie-move 31 in \mathcal{MM}) in [BL].

Proposition 49 *If \mathcal{A} is a semi-normal amplitude-assignment, then \mathcal{A} respects all movie-moves of types 15,16 or 22.*

PROOF: Let $(M == M')$ be a movie-move of type 15, 16 or 22. We begin by showing that every flicker in M and in M' is of type 8:

Indeed, it is easy to see that if this is so for $(M == M')$, and if

$$\pi \in \mathcal{SYM}$$

then also the movie-move $\pi \circ (M == M')$ has the same property. Now, all the movie-moves of types 15,16 or 22, result by acting by \mathcal{SYM} on the three (sets of) movie-moves listed under these numbers on p.48 and 49 of [BL], and inspection shows each of the latter has the required property.

Thus every flicker F in M and in M' is of type 8, and since \mathcal{A} is semi-normal, we then have

$$\langle source(F) \rangle = \langle target(F) \rangle = \langle F \rangle_{\mathcal{A}} .$$

Let

$$M = F_1 \cdots F_s, \quad M' = F'_1 \cdots F'_t ;$$

then all of the stills of M (i.e. all the sources and targets of the flickers F_1, \dots, F_s) have the same Kauffman amplitude, say A . Also, since (M, M') is a movie-move, it is grammatical, so $F_1 = F'_1$. Hence all the stills of M' also have the Kauffman amplitude A , and so

$$\langle M \rangle_{\mathcal{A}} = A - A + \cdots + A = A = \langle M' \rangle_{\mathcal{A}} ,$$

Q.E.D.

Proposition 50 *If \mathcal{A} is a semi-normal amplitude-assignment, then \mathcal{A} respects all movie-moves of types 17, 18, 19 and 20.*

PROOF: Throughout the following argument, we assume $i \in \{17, 18, 19, 20\}$, and then set

$$I(i) = \begin{cases} 3 & \text{when } i = 17, \\ 5 & \text{when } i = 18, \\ 1 & \text{when } i = 19, \\ 4 & \text{when } i = 20. \end{cases}$$

We set $\nu(i)$ equal to the number of elementary transitions of type $I(i)$, as given by the following table:

i	17	18	19	20
$\nu(i)$	12	4	8	8

Finally, we assume the $\nu(i)$ elementary transitions of type $I(i)$, enumerated and with notation as in §2.2, as follows:

$$ET(I(i), j) = \{[F_{ij1} \cdots F_{ijs(j)} \Rightarrow I(i) \quad G_{ij1} \cdots G_{ijt(j)}] \mid 1 \leq j \leq \nu(i)\}$$

The reader is invited at this point to examine the listings given for movie-move 17–20 on p.49 of [BL]; such an examination shows that every movie-move of type i , is derived in the extended sense (as explained above in Def.

38) from a movie-move in the two lists $\mathcal{L}_i, \mathcal{L}'_i$ next to be constructed, whose union

$$\mathcal{L}_i \cup \mathcal{L}'_i = \mathcal{MM}_i^{red}$$

makes up the set of BL-reduced movie-moves of type i.

STEP ONE: A RESPECTS ALL MOVIE-MOVES IN \mathcal{L}_i :

Let us first construct \mathcal{L}_i :

Each movie-move ($M == N$) in the list \mathcal{L}_i is constructed from the following data:

Definition 51 An *i*-datum $\mathcal{D}_i(E, n, \mathcal{T})$ is defined to consist of the following three items:

- An elementary event $E \in \mathcal{E} = \{Cup, Cap, NE, NW\}$, with source a and target b :

$$source(E) = a, target(E) = b$$

- A natural number n
- An elementary transition $\mathcal{T} = [F_1 \cdots F_p ==> G_1 \cdots G_q]$ of type $I(i)$

We denote by $\mathcal{MD}_i(E, n, \mathcal{T})$ the movie-move (M, N) of type i, constructed from this data in the manner next to be described. This movie-move is pictured in Figure 26. (Then \mathcal{L}_i is defined to be the set of all such $\mathcal{MD}_i(E, n, \mathcal{T})$) Note that the common source S of M and of N , consists of E above and to the left of the source $F_1 \cdots F_p$ of \mathcal{T} , with n vertical strings in between. Similarly, the common target T of M and N , consists of E below and to the left of the target $G_1 \cdots G_q$ of \mathcal{T} , again with n vertical strings in between.

M and M' then furnish two paths $S ==> T$, constructed as follows:

In the first place, in accordance with Fig. 26, the left-hand movie M consists of $p + 1$ flickers of type 8, followed by one flicker of type $I(i)$, and is given in *sf*-notation by:

```

M=[
[a+n,F1,0] ... [a+n,F(p-1),0]s[a+n,Fp,0] [0,E,n+target(Fp)]s =>8
[a+n,F1,0] ... s[a+n,F(p-1),0]f[0,E,n+target(F(p-1))]s[b+n,Fp,0]f => 8
.....
..... =>8
f[0,E,n+source(F1)]s[b+n,F1,0]f ... [b+n,F_p,0]s =>I(i)
[0,E,n+source(G1)]f[b+n,G1,0] ... [b+n,Gq,0]f
]

```

Since \mathcal{A} is, by hypothesis, semi-normal, A is then also the \mathcal{A} -amplitude of the $p + 1$ flickers in M of type 8 (i.e., the first $p + 1$ flickers of M). As for the last flicker \mathcal{F} in M , of type $I(i)$, its \mathcal{A} -amplitude is (by Def. 42)

$$\begin{aligned} \langle \mathcal{F} \rangle_{\mathcal{A}} &= (Id_{V^{\otimes(\text{source}(E)+n)}} \otimes \langle \mathcal{T} \rangle_{\mathcal{A}}) \circ (\langle E \rangle \otimes Id_{V^{\otimes(n+\text{target}(F_p))}}) \\ &= \langle E \rangle \otimes V^{\otimes n} \langle \mathcal{T} \rangle_{\mathcal{A}} \end{aligned}$$

Hence, by Def. 43,

$$\begin{aligned} \langle M \rangle_{\mathcal{A}} &= A - A + \cdots + A - \langle \mathcal{F} \rangle_{\mathcal{A}} + A \\ &= (p + 2)A - pA - (\langle E \rangle \otimes V^{\otimes n} \otimes \langle \mathcal{T} \rangle_{\mathcal{A}}) \\ &= 2A - (\langle E \rangle \otimes V^{\otimes n} \otimes \langle \mathcal{T} \rangle_{\mathcal{A}}). \end{aligned}$$

Since M and N have the same first still, A is also the common Kauffman amplitude of all stills of N . A precisely similar computation, now shows that the right-hand movie N has the same \mathcal{A} -amplitude as does M :

$$\begin{aligned} \langle N \rangle_{\mathcal{A}} &= (q + 2)A - qA - (\langle E \rangle \otimes Id_{V^{\otimes(n+\text{target}(F_p))}}) \circ (Id_{V^{\otimes(\text{source}(E)+n)}} \otimes \langle \mathcal{T} \rangle_{\mathcal{A}}) \\ &= 2A - (\langle E \rangle \otimes V^{\otimes n} \otimes \langle \mathcal{T} \rangle_{\mathcal{A}}). \end{aligned}$$

Hence, as asserted, \mathcal{A} respects every movie-move in \mathcal{L}_i —provided $i = 17$, 18 or 20.

Ad Case 2: Here $i = 19$, so $I(i) = 1$, i.e. \mathcal{T} is of type $ET1$. There is a slight extra complication in this case, because Reidemeister I moves do not preserve the Kauffman amplitude. Thus, instead of all stills in M and in N having the same Kauffman amplitude (as in Case 1) there are now among these stills **two** Kauffman amplitudes. Namely, in M the $q + 1$ stills involving F 's all have the same Kauffman amplitude $\langle S \rangle$ as does the common source S of M and N , since they arise from S (the first still of M) by a sequence of ET8's (which preserve the Kauffman bracket), leaving the one still $\langle T \rangle$ in M with a possibly different Kauffman amplitude. Similarly, in the right-hand movie N , the $q + 1$ stills involving G 's all have Kauffman amplitude $\langle T \rangle$, and there is one remaining still with amplitude $\langle S \rangle$. (Note: Since here \mathcal{T} is of type 1, (p, q) is $(2, 0)$ or $(0, 2)$. Using this fact seems unhelpful—it seems to require unnecessarily subdividing the argument into lots of cases. It seems neater to stick with p and q ...)

Next let us consider the \mathcal{A} -amplitudes of the flickers of M and N . Since \mathcal{A} is semi-normal, the flickers of type 8 divide as follows: In M there are q of \mathcal{A} -amplitude $\langle S \rangle$, and in N there are p of \mathcal{A} -amplitude $\langle T \rangle$. Finally, M contains one flicker \mathcal{F} (the last) of type ET1, and N contains one flicker

\mathcal{F}' (the first) of type ET1. Exactly as in Case 1, one verifies that \mathcal{F} and \mathcal{F}' have the same \mathcal{A} -amplitude:

$$\langle \mathcal{F} \rangle_{\mathcal{A}} = \langle \mathcal{F}' \rangle_{\mathcal{A}} = \langle E \rangle \otimes V^{\otimes n} \langle \mathcal{T} \rangle_{\mathcal{A}}$$

Putting these facts together, we finally obtain:

$$\begin{aligned} \langle \mathcal{M} \rangle_{\mathcal{A}} &= (p+1) \langle S \rangle + \langle T \rangle - p \langle S \rangle - \langle \mathcal{F} \rangle_{\mathcal{A}} \\ &= \langle S \rangle + \langle T \rangle - \langle E \rangle \otimes V^{\otimes n} \langle \mathcal{T} \rangle_{\mathcal{A}} \\ &= \langle \mathcal{N} \rangle_{\mathcal{A}} \end{aligned}$$

i.e. in both cases, \mathcal{A} respects all movie-moves (M, N) in \mathcal{L}_i , as was to be proved.

STEP TWO: \mathcal{A} RESPECTS ALL MOVIE-MOVES IN \mathcal{L}'_i :

Given the i -datum $\mathcal{D}_i(E, n, \mathcal{T})$ described above, a second movie-move

$$\mathcal{M}'\mathcal{D}_i(E, n, \mathcal{T}) = (M1, N1)$$

(these then making up the collection \mathcal{L}'_i) is constructed as follows:¹³

M1=[
 [0, F1, n+a] ... [0, F(p-1), n+a] s [0, Fp, n+a] [n+target(Fp), E, 0] s=>8
 [0, F1, n+a] ... s [0, F(p-1), n+a] f [n+target(F(p-1)), E, 0] s [0, Fp, n+b] f=>8

=>8
 f [n+source(F1), E, 0] s [0, F1, n+b] f ... [0, F(p-1), n+b] [0, Fp, n+b] s=>I(i)
 [n+source(G1), E, 0] f [0, G1, n+b] ... [0, G(q-1), n+b] [0, Gq, n+b] f
]
 and
 N1=[
 s [0, F1, n+a] ... [0, F(p-1), n+a] [0, Fp, n+a] s [n+target(Fp), E, 0] =>I(i)
 f [0, G1, n+a] ... [0, Q(q-1), n+a] s [0, Gq, n+a] f [n+target(Gq), E, 0] s=>8
 [0, G1, n+a] ... s [0, Q(q-1), n+a] f [n+target(Gq), E, 0] s [0, Gq, n+b] f=>8

=>8
 [n+source(G1), E, 0] f [0, G1, n+b] ... [0, G(q-1), n+b] [0, Gq, n+b] f
]

¹³As a check, note that if m is reflection in the vertical midline, i.e. is the symmetry which interchanges left and right, then $(M1, N1) = (m \circ N, m \circ M)$. If we apply this reflection to Fig. 26, we obtain the diagram for \mathcal{L}'_i .

(The instructions in [BL].p.49 tell us to obtain the latter movie-moves from the former “relations”—i.e., movie-moves— “where ... $N_{Y_{m,n},\chi_{j,k}}^*$ is replaced by $N_{\chi_{j,k},Y_{m,n}}$ ”, Translation into the present notation gives precisely the preceding M1,N1. It is readily verified, by amplitude-computations similar to the preceding ones, that (with notation as above)

$$\begin{aligned} & \langle M1 \rangle_{\mathcal{A}} = \langle N1 \rangle_{\mathcal{A}} = \\ = & \begin{cases} 2A - \langle \mathcal{T} \rangle_{\mathcal{A}} \otimes Id_{(V^{\otimes n})} \otimes \langle E \rangle & \text{when } i=17,18 \text{ or } 20 \\ \langle S \rangle + \langle T \rangle - \langle \mathcal{T} \rangle_{\mathcal{A}} \otimes Id_{(V^{\otimes n})} \otimes \langle E \rangle & \text{when } i=19 \end{cases} \end{aligned}$$

Thus, as asserted, \mathcal{A} respects every movie $(M1, N1)$ in \mathcal{L}'_i .

STEP THREE: \mathcal{A} RESPECTS $\mathcal{SYM} \circ \mathcal{L}_i$ AND $\mathcal{SYM} \circ \mathcal{L}'_i$

We are finally ready to tackle the general problem, of proving that every semi-normal amplitude assignment \mathcal{A} , respects every movie-move of type 17, 18, 19 or 20. For this purpose, we use the construction of movie-moves of these four types, given in [BL], p.49, augmented by the addenda on the bottom of loc.cit., p.50. Translated into the terminology of the present paper, this characterizes the movie-moves of one of these types i , as the set of all pairs of movies, derived in the extended sense (cf. Def.38) from the movie-moves in the set

$$\mathcal{L}_i \cup \mathcal{L}'_i .$$

—or equivalently, as the set of all pairs of movies, strictly derived (cf. Def. 37) from the movie-moves in the set

$$(\mathcal{SYM} \circ \mathcal{L}_i) \cup (\mathcal{SYM} \circ \mathcal{L}'_i) \tag{15}$$

Hence, by Prop 47, to prove that \mathcal{A} respects all movie-moves of such types i , it suffices to show that it respects all elements of (15).

For this purpose, let us first note that the set (15) is made up of the lists \mathcal{L}_i and \mathcal{L}'_i just described above, together with two more lists \mathcal{L}''_i and \mathcal{L}'''_i whose construction is next to be explained:

$$(\mathcal{SYM} \circ \mathcal{L}_i) \cup (\mathcal{SYM} \circ \mathcal{L}'_i) = \mathcal{L}_i \cup \mathcal{L}'_i \cup \mathcal{L}''_i \cup \mathcal{L}'''_i$$

Figure 27 gives a sketchy picture of the movie-move

$$\mathcal{M}''\mathcal{D}_i(E, n, \mathcal{T}) = (M2 == N2)$$

. This movie-move and the related movie-move¹⁴

$$\mathcal{M}'''\mathcal{D}_i(E, n, \mathcal{T}) = (M3 == N3)$$

¹⁴If m is reflection in the vertical midline, i.e. is the symmetry which interchanges left and right, then $(M3, N3) = (m \circ N2, m \circ M2)$ If we apply this reflection to Fig. 27, we obtain the diagram for \mathcal{L}'''_i .

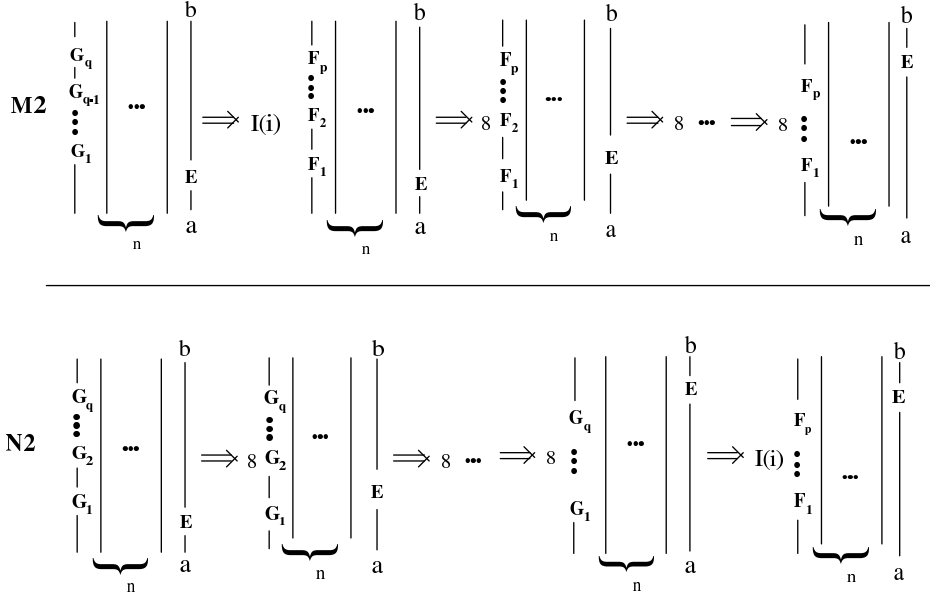

Figure 27: \mathcal{L}_i''

make up (respectively)

$$\mathcal{L}_i'' = t \circ \mathcal{L}_i = R \circ \mathcal{L}_i$$

and

$$\mathcal{L}_i''' = t \circ \mathcal{L}_i' = R \circ \mathcal{L}_i'.$$

Examination of the figure for \mathcal{L}_i'' (and a similar figure for \mathcal{L}_i''') shows that we have

$$\mathcal{M}''\mathcal{D}_i(E, n, \mathcal{T}) = (R \circ \mathcal{M}\mathcal{D}_i(E, n, \mathcal{R} \circ \mathcal{T}))^C$$

and

$$\mathcal{M}'''\mathcal{D}_i(E, n, \mathcal{T}) = (R \circ \mathcal{M}'\mathcal{D}_i(E, n, \mathcal{R} \circ \mathcal{T}))^C$$

which implies

$$\mathcal{L}_i'' = (\mathcal{L}_i)^C \text{ and } \mathcal{L}_i''' = (\mathcal{L}_i')^C \tag{16}$$

Now observe that if \mathcal{A} respects a movie-move ($M = N$), it of course respects the converse movie-move ($N = M$). Since we have proved that \mathcal{A} (assumed semi-normal) respects all movie-moves in \mathcal{L}_i and in \mathcal{L}_i' , it follows from eqn. 16 that \mathcal{A} also respects all movie-moves in \mathcal{L}_i'' and in \mathcal{L}_i''' . As noted above, this shows \mathcal{A} respects all movie-moves of type i , Q.E.D.

Let $A = \{15, 16, 17, 18, 19, 20, 22\}$, and let B be the set of integers between 1 and 30 which are not in A . Thus,

$$B := \{i \mid 1 \leq i \leq 14\} \cup \{21\} \cup \{i \mid 23 \leq i \leq 30\} \quad (17)$$

Let us continue to assume that \mathcal{A} is a semi-normal amplitude assignment. It follows from Props.49 and 50, that \mathcal{A} respects all movie-moves whose type lies in A . The following proposition shows that if $i \in B$, a finite number of tests suffice to check whether \mathcal{A} respects the (infinitely many) movie-moves of type i ; more precisely:

Proposition 52 *Let \mathcal{C} denote the set of all BL-reduced movie-moves whose type lies in B , and let \mathcal{A} be a semi-normal amplitude-assignment. Then:*

a) \mathcal{C} , hence also $\mathcal{SYM} \circ \mathcal{C}$, is a finite set.

b) If $i \in B$, then \mathcal{A} respects all movie-moves of type i , if and only if it respects each of the finitely many movie-moves in

$$(\mathcal{SYM} \circ \mathcal{C}) \cap \mathcal{MM}_i = \mathcal{SYM} \circ (\mathcal{C} \cap \mathcal{MM}_i)$$

.

PROOF:

Ad a) Here is a table (easily obtained by examining the lists of movie-moves on p.47–50 of [BL]) giving for all i in B , the cardinality—which we shall denote by $\mathcal{N}(i)$ — of the set \mathcal{MM}_i^{red} (of all BL-reduced movie-moves of type i):

i in B	1	2	3	4	5	6	7	8	9	10	11	12	13	14	21	23
$\mathcal{N}(i)$	1	1	1	1	6	6	2	1	1	1	2	2	1	3	1	2
i in B	24	25	26	27	28	29	30									
$\mathcal{N}(i)$	1	2	1	1	1	1	1									

Since $\mathcal{N}(i)$ is finite for every $i \in B$, it follows that \mathcal{C} is a finite set, of cardinality

$$\sum_{i \in B} \mathcal{N}(i) = 40$$

Hence also $\mathcal{SYM} \circ \mathcal{C}$ is finite, with cardinality bounded above by

$$\#(\mathcal{SYM}) \times 40 = 320.$$

Ad b) This follows immediately from Prop.47.

Up to this point, we have left open the question of what conditions are needed, for an amplitude-assignment to respect all movie-moves of type 31. This requires special considerations, to which we now turn.

3.3 Reduced Movie-moves of Type 31

In the following proposition, it will be convenient to use $\langle\langle m \rangle\rangle$ as an abbreviation for $Id_{V_1^{\otimes m}}$ (where m is any natural number.)

Proposition 53 *Let \mathcal{A} be an amplitude-assignment; let*

$$E_1 : U_1 \Rightarrow V_1 \text{ and } E_2 : U_2 \Rightarrow V_2$$

be two elementary transitions and let

$$m_1, n_1, m_2, n_2$$

be natural numbers such that (4) holds—i.e., such that $m_1 + \text{out}(E_1) + n_1 = m_2 + \text{in}(E_2) + n_2$.

Construct the movie-move

$$\mathcal{M}(E_1, E_2; m_1, n_1, m_2, n_2) = (M_1 == M_2)$$

(as in Definition 31.) Then:

(a) \mathcal{A} respects $(M_1 == M_2)$, if and only if the following equation holds:

$$\begin{aligned} & (\langle\langle m_2 \rangle\rangle \otimes \langle U_2 \rangle \otimes \langle\langle n_2 \rangle\rangle) \circ (\langle\langle m_1 \rangle\rangle \otimes \langle V_1 \rangle \otimes \langle\langle n_1 \rangle\rangle) - \quad (18) \\ & (\langle\langle m_2 \rangle\rangle \otimes \langle V_2 \rangle \otimes \langle\langle n_2 \rangle\rangle) \circ (\langle\langle m_1 \rangle\rangle \otimes \langle U_1 \rangle \otimes \langle\langle n_1 \rangle\rangle) = \\ & (\langle\langle m_2 \rangle\rangle \otimes \langle U_2 \rangle \otimes \langle\langle n_2 \rangle\rangle) \circ (\langle\langle m_1 \rangle\rangle \otimes \langle E_1 \rangle_{\mathcal{A}} \otimes \langle\langle n_1 \rangle\rangle) + \\ & (\langle\langle m_2 \rangle\rangle \otimes \langle E_2 \rangle_{\mathcal{A}} \otimes \langle\langle n_2 \rangle\rangle) \circ (\langle\langle m_1 \rangle\rangle \otimes \langle V_1 \rangle \otimes \langle\langle n_1 \rangle\rangle) - \\ & (\langle\langle m_2 \rangle\rangle \otimes \langle E_2 \rangle_{\mathcal{A}} \otimes \langle\langle n_2 \rangle\rangle) \circ (\langle\langle m_1 \rangle\rangle \otimes \langle U_1 \rangle \otimes \langle\langle n_1 \rangle\rangle) - \\ & (\langle\langle m_2 \rangle\rangle \otimes \langle V_2 \rangle \otimes \langle\langle n_2 \rangle\rangle) \circ (\langle\langle m_1 \rangle\rangle \otimes \langle E_1 \rangle_{\mathcal{A}} \otimes \langle\langle n_1 \rangle\rangle) \end{aligned}$$

(b) If \mathcal{A} is semi-normal, and at least one of E_1, E_2 is of type ET8, then (18) holds (and hence \mathcal{A} respects the movie-move $(M_1 == M_2)$).

PROOF:

The left movie M_1 consists (in movie-time ordering, and using the sf -notation) of the three stills S_1, S_2, S_3 given by:

$$\begin{aligned} S_1 &= s(m_1 \bullet U_1 \bullet n_1) s \circ (m_2 \bullet U_2 \bullet n_2) \\ S_2 &= f(m_1 \bullet V_1 \bullet n_1) f \circ s(m_2 \bullet U_2 \bullet n_2) s \\ S_3 &= (m_1 \bullet V_1 \bullet n_1) \circ f(m_2 \bullet V_2 \bullet n_2) f \end{aligned}$$

joined by the two flickers F_1, F_2 given by

$$\begin{aligned} F_1 &= (m_1 \bullet E_1 \bullet n_1) \circ (m_2 \bullet U_2 \bullet n_2) \\ F_2 &= (m_1 \bullet V_1 \bullet n_1) \circ (m_2 \bullet E_2 \bullet n_2) \end{aligned}$$

We then have

$$\langle M_1 \rangle_{\mathcal{A}} = \langle S_1 \rangle + \langle S_2 \rangle + \langle S_3 \rangle - \langle F_1 \rangle_{\mathcal{A}} - \langle F_2 \rangle_{\mathcal{A}}$$

Similarly, the right movie M_2 consists of the three stills:

$$\begin{aligned} S'_1 &= S_1 \\ S'_2 &= s(m_1 \bullet U_1 \bullet n_1) s \circ f(m_2 \bullet V_2 \bullet n_2) f \\ S'_3 &= S_3 \end{aligned}$$

and the two flickers

$$\begin{aligned} F'_1 &= (m_1 \bullet U_1 \bullet n_1) \circ (m_2 \bullet E_2 \bullet n_2) \\ F'_2 &= (m_1 \bullet E_1 \bullet n_1) \circ (m_2 \bullet V_2 \bullet n_2) \end{aligned}$$

so that

$$\langle M_2 \rangle_{\mathcal{A}} = \langle S_1 \rangle + \langle S'_2 \rangle + \langle S_3 \rangle - \langle F'_1 \rangle_{\mathcal{A}} - \langle F'_2 \rangle_{\mathcal{A}}$$

Since the terms $\langle S_1 \rangle$ and $\langle S_3 \rangle$ are common to these two movie-amplitudes, we have

$$\langle M_1 \rangle_{\mathcal{A}} - \langle M_2 \rangle_{\mathcal{A}} = \langle S_2 \rangle - \langle S'_2 \rangle - \langle F_1 \rangle_{\mathcal{A}} - \langle F_2 \rangle_{\mathcal{A}} + \langle F'_1 \rangle_{\mathcal{A}} + \langle F'_2 \rangle_{\mathcal{A}}$$

Replacing these amplitudes by their explicit values ¹⁵now yields eqn. (18), as the necessary and sufficient condition that

$$\langle M_1 \rangle_{\mathcal{A}} = \langle M_2 \rangle_{\mathcal{A}},$$

i.e., that \mathcal{A} respect $(M_1 = M_2)$ —which proves (a).

We now turn to (b). Assume \mathcal{A} is semi-normal, and consider the case that E_1 is of type *ET8* (— we omit the precisely similar argument for the case that it is E_2 that is of type *ET8*.) This assumption implies that

$$\langle U_1 \rangle = \langle V_1 \rangle = \langle E_1 \rangle_{\mathcal{A}}: V^{\otimes in(E_1)} \rightarrow V^{\otimes out(E_1)}$$

This implies the equality of the 3 \mathbb{K} -linear maps $\langle\langle m_1 \rangle\rangle \otimes \langle U_1 \rangle \otimes \langle\langle n_1 \rangle\rangle, \langle\langle m_1 \rangle\rangle \otimes \langle V_1 \rangle \otimes \langle\langle n_1 \rangle\rangle$

¹⁵The reader is reminded that (with our present conventions) still-composition occurs from the bottom to the top ('past' to 'future') of link-diagrams, and that the Kauffman bracket is then *contravariant*, i.e. $\langle S_1 \circ S_2 \rangle = \langle S_2 \rangle \circ \langle S_1 \rangle$.

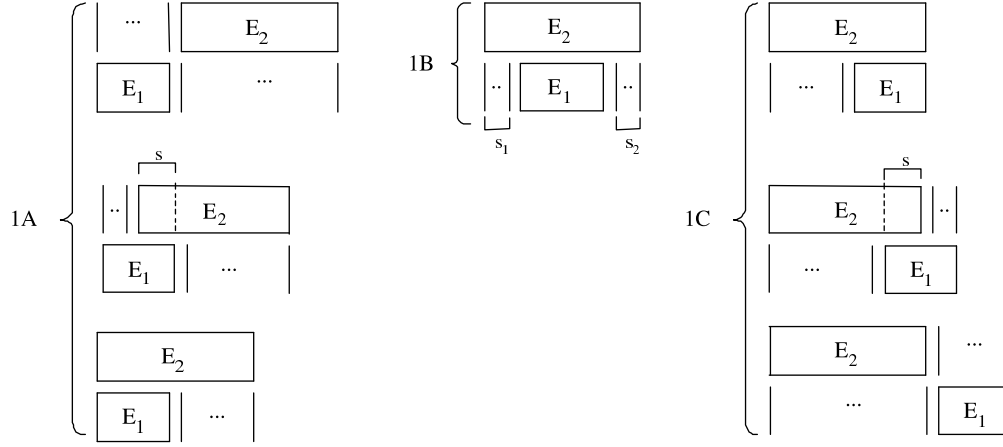

Figure 28: \mathcal{MM}_{31}^{red}

and $\langle\langle m_1 \rangle\rangle \otimes \langle E_1 \rangle_{\mathcal{A}} \otimes \langle\langle n_1 \rangle\rangle$ —let us denote their common value by

$$\mathcal{S} : V^{\otimes(m_1+in(E_1)+n_1)} \rightarrow V^{\otimes(m_1+out(E_1)+n_1)} .$$

Then (18) is, in this case, the result of applying $\circ\mathcal{S}$ on the right of the obviously correct equation

$$\begin{aligned} &\langle\langle m_2 \rangle\rangle \otimes \langle U_2 \rangle \otimes \langle\langle n_2 \rangle\rangle - \langle\langle m_2 \rangle\rangle \otimes \langle V_2 \rangle \otimes \langle\langle n_2 \rangle\rangle = \\ &\langle\langle m_2 \rangle\rangle \otimes \langle U_2 \rangle \otimes \langle\langle n_2 \rangle\rangle + \langle\langle m_2 \rangle\rangle \otimes \langle E_2 \rangle \otimes \langle\langle n_2 \rangle\rangle - \\ &\langle\langle m_2 \rangle\rangle \otimes \langle E_2 \rangle \otimes \langle\langle n_2 \rangle\rangle - \langle\langle m_2 \rangle\rangle \otimes \langle V_2 \rangle \otimes \langle\langle n_2 \rangle\rangle , \end{aligned}$$

Q.E.D.

We now turn to the definition of **reduced** movie-moves of type 31—these will then be defined to make up the finite set \mathcal{MM}_{31}^{red} . This is analogous to (but rather more complicated than) the above concept of *BL*-reduced (for movie-moves of types ≤ 30), and is chosen so that the analogue of Prop.52 holds (this analogue being Prop.54 below.)

ALGORITHM A (FOR GENERATING THE FINITE SET \mathcal{MM}_{31}^{red} :)

Using the notation of Def.31, the **reduced** movie-moves

$$\mathcal{M} = \mathcal{MM}(E_1, E_2 : m_1, n_1, m_2, n_2) \quad (*)$$

of type 31, are now defined to be all those obtained by the following procedure:

In the first place, choose in all possible 1596 ways, two elementary transitions E_1, E_2 (not necessarily distinct), such that neither E_1 nor E_2 is of type $ET8$. Let us set

$$t_1 := \text{target}(E_1), t_2 = \text{source}(E_2) .$$

At this point, we must subdivide into 3 disjoint cases:

Case 1: $t_1 < t_2$ **Case 2:** $t_1 = t_2$ **Case 3:** $t_1 > t_2$

In each case, we construct $t_1 + t_2 + 1$ quadruples (m_1, n_1, m_2, n_2) as described below, insert into $(*)$ to obtain a set—call it $\mathcal{MM}_{31}^{red}(E_1, E_2)$ —consisting of $t_1 + t_2 + 1$ movie-moves of type 31. Finally, we set

$$\mathcal{MM}_{31}^{red} := \bigcup \{ \mathcal{MM}_{31}^{red}(E_1, E_2) \mid E_1, E_2 \text{ elementary transitions neither of type } ET8 \}$$

In more detail:

Suppose first we are in Case 1, so that $t_1 < t_2$. We subdivide into three parametrized SUB-CASES, each providing a value for the quadruple (m_1, n_1, m_2, n_2) , as follows:

SUB-CASE 1A(s) (parametrized by s with $0 \leq s \leq t_1$)

Here $(m_1, n_1, m_2, n_2) = (0, t_2 - s, t_1 - s, 0)$

SUB-CASE 1B(s_1, s_2) (parametrized by s_1, s_2 with

$$0 < s_1, 0 < s_2, s_1 + s_2 = t_2 - t_1)$$

—here $(m_1, n_1, m_2, n_2) = (s_1, s_2, 0, 0)$.

SUB-CASE 1C(s) (parametrized by s with $0 \leq s \leq t_1$)

Here $(m_1, n_1, m_2, n_2) = (t_2 - s, 0, 0, t_1 - s)$

The number of quadruples (m_1, n_1, m_2, n_2) produced in this way is

$$(t_1 + 1) + (t_2 - 1 + 1) + (t_1 + 1) = t_1 + t_2 + 1$$

as asserted above; inserting these quadruples into $(*)$, we obtain the $t_1 + t_2 + 1$ reduced movie-moves of type 31 in $\mathcal{MM}_{31}^{red}(E_1, E_2)$.

We next consider Case 2, where $t_1 = t_2$. Here we have three SUB-CASES, as follows:

SUB-CASE 2A (parametrized by s with $0 \leq s < t_1$)

$(m_1, n_1, m_2, n_2) = (0, t_1 - s, t_1 - s, 0)$

SUB-CASE 2B $(m_1, n_1, m_2, n_2) = (0, 0, 0, 0)$

SUB-CASE 2Cs (parametrized by s with $0 \leq s < t_1$)

$$(m_1, n_1, m_2, n_2) = (t_1 - s, 0, 0, t_1 - s)$$

Inserting these values into (*), we obtain $\mathcal{M}\mathcal{M}_{31}^{red}(E_1, E_2)$ in the present case.

There remains Case 3, where $t_1 > t_2$. Here we have the three SUB-CASES:

SUB-CASE 3A (parametrized by s with $0 \leq s \leq t_2$)

$$(m_1, n_1, m_2, n_2) = (0, t_2 - s, t_1 - s, 0)$$

SUB-CASE 3B (parametrized by s_1, s_2 with

$$0 \leq s_1, 0 \leq s_2, s_1 + s_2 = t_1 - t_2)$$

$$(m_1, n_1, m_2, n_2) = (0, 0, s_1, s_2)$$

SUB-CASE 3C (parametrized by s with $0 \leq s \leq t_2$)

$$(m_1, n_1, m_2, n_2) = (t_2 - s, 0, 0, t_1 - s)$$

Inserting these values into (*), we obtain $\mathcal{M}\mathcal{M}_{31}^{red}(E_1, E_2)$ in the present case.

The motivation for the preceding algorithm, is the need to ensure that the following proposition be true—the algorithm may appear more natural, upon carefully examining the following proof.

Proposition 54 *Let \mathcal{A} be a semi-normal amplitude-assignment; then \mathcal{A} respects all movie-moves of type 31, if and only if \mathcal{A} respects all **reduced** movie-moves of type 31 (i.e., all elements in the finite set $\mathcal{M}\mathcal{M}_{31}^{red}$).*

PROOF:

Let us make the following three assumptions:

1. \mathcal{A} is a semi-normal amplitude-assignment.
2. \mathcal{M} is a movie-move of type 31
3. \mathcal{A} respects every reduced movie-move of type 31.

It suffices to deduce from these assumptions, that \mathcal{A} respects \mathcal{M} .

In the sense of Def.37, \mathcal{M} is strictly derived from a movie-move \mathcal{M}' of the form

$$\mathcal{M}' = \mathcal{M}(E_1, E_2; m_1, n_1, m_2, n_2)$$

where E_1, E_2 are elementary transitions, and the m's and n's are natural numbers. It follows from Prop.47, that it suffices to deduce from our three assumptions, that \mathcal{A} respects \mathcal{M}' . Moreover, it follows from Prop.53(b), that we may assume without loss of generality, that neither E_1 nor E_2 is of type ET8.

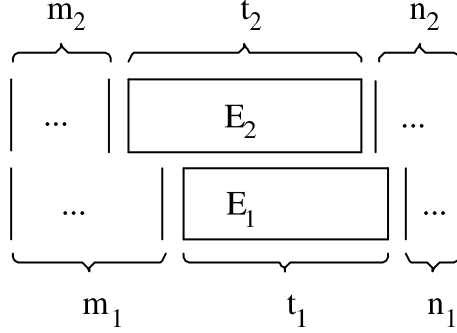

Figure 29: Schematic Construction of \mathcal{M}

It follows from the preceding paragraph, that we may, without loss of generality, strengthen Assumption 2 as follows:

2'. \mathcal{M} has the form

$$\mathcal{M} = \mathcal{M}(E_1, E_2; m_1, n_1, m_2, n_2)$$

with neither E_1 nor E_2 of type ET8.

It suffices to prove, (as we shall in the remainder of our argument), that given Assumptions 1, 2' and 3, it follows that there exists a reduced movie-move \mathcal{M}^{red} , such that

$$\mathcal{A} \text{ respects } \mathcal{M}^{red} \Rightarrow \mathcal{A} \text{ respects } \mathcal{M} \quad (19)$$

Now let us set

$$t_1 = \text{target}(E_1), \quad t_2 = \text{source}(E_2)$$

Note that assumption 2' then implies

$$m_1 + t_1 + n_1 = m_2 + t_2 + n_2 \quad (20)$$

In order to understand the rationale of the somewhat elaborate case-divisions which follow, the reader may find it helpful to examine Figure 29; the case-divisions are according to the possible relations of the portions of this Figure.

We begin by again considering (as in Algorithm A) three cases, according as t_1 is $<$, $=$ or $>$ t_2 .

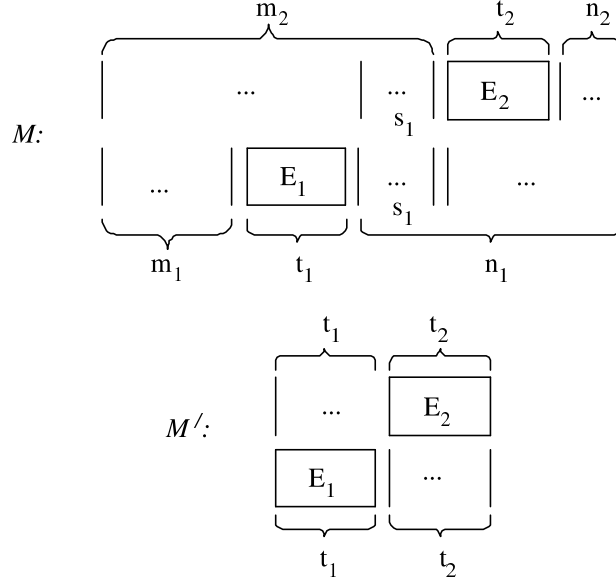

Figure 30: Sub-case 1a

CASE 1 $t_1 < t_2$:

We subdivide this case further, into five disjoint sub-cases, as follows:

SUB-CASE 1a $m_2 \geq m_1 + t_1$:

(In terms of Figure 29, this means that all of E_1 is to the left of all of E_2 : cf. Fig. 30). We must construct a reduced movie-move \mathcal{M}' such that (19) holds. It is now claimed that this is the case for

$$\mathcal{M}' = \mathcal{M}(E_1, E_2; 0, t_2, t_1, 0)$$

Indeed, examination of Algorithm A shows that \mathcal{M}' is reduced (it falls under SUB-CASE 1A(0) of the Algorithm). It remains to verify (19):

Thus, assume that \mathcal{A} respects \mathcal{M}' . In (a) of Prop. 53, with m_1, n_1, m_2, n_2 replaced by their values $0, t_2, t_1, 0$ for \mathcal{M}' , the first term of Eqn.18 becomes

$$(\langle\langle t_1 \rangle\rangle \otimes \langle U_2 \rangle) \circ (\langle V_1 \otimes \langle\langle t_2 \rangle\rangle) = \langle V_1 \rangle \otimes \langle U_2 \rangle$$

—and similarly for the other 5 terms. We thus obtain

$$T'_1 \otimes U'_1 - T'_2 \otimes U'_2 = T'_3 \otimes U'_3 + T'_4 \otimes U'_4 - T'_5 \otimes U'_5 - T'_6 \otimes U'_6 \quad (21)$$

where the \mathbb{K} -linear transformations

$$T'_i : V^{\otimes t_1} \rightarrow V^{\otimes t_1} \text{ and } U'_i : V^{\otimes t_2} \rightarrow V^{\otimes t_2} \quad (1 \leq i \leq 6)$$

are given by

$$T'_1 = \langle V_1 \rangle, T'_2 = \langle U_1 \rangle, T'_3 = \langle E_1 \rangle_{\mathcal{A}}, T'_4 = \langle V_1 \rangle, T'_5 = \langle U_1 \rangle, T'_6 = \langle E_1 \rangle_{\mathcal{A}}$$

and

$$U'_1 = \langle U_2 \rangle, U'_2 = \langle V_2 \rangle, U'_3 = \langle U_2 \rangle, U'_4 = \langle E_2 \rangle_{\mathcal{A}}, U'_5 = \langle E_2 \rangle_{\mathcal{A}}, U'_6 = \langle V_2 \rangle$$

On the other hand, setting $s = m_2 - m_1 - t_2$, (a) of Prop.53, together with examination of Fig. 30 in this case, shows that \mathcal{A} respects \mathcal{M} , if and only if

$$T^{(1)} + T^{(2)} = T^{(3)} + T^{(4)} - T^{(5)} - T^{(6)} \quad (22)$$

where the \mathbb{K} -linear transformations $T^{(i)}$ are given by:

$$\begin{aligned} T^{(1)} &= (\langle\langle m_1 \rangle\rangle \otimes \langle\langle t_2 \rangle\rangle \otimes \langle\langle s_1 \rangle\rangle \otimes \langle U_2 \rangle \otimes \langle\langle m_2 \rangle\rangle) \circ \\ &\quad (\langle\langle m_1 \rangle\rangle \otimes \langle V_1 \rangle \otimes \langle\langle s_1 \rangle\rangle \otimes \langle\langle t_2 \rangle\rangle \otimes \langle\langle n_2 \rangle\rangle) \\ &= \langle\langle m_1 \rangle\rangle \otimes \langle V_1 \rangle \otimes \langle\langle s_1 \rangle\rangle \otimes \langle U_2 \rangle \otimes \langle\langle n_2 \rangle\rangle \end{aligned}$$

—and similarly,

$$\begin{aligned} T^{(2)} &= \langle\langle m_1 \rangle\rangle \otimes \langle U_1 \rangle \otimes \langle\langle s_1 \rangle\rangle \otimes \langle V_2 \rangle \otimes \langle\langle n_2 \rangle\rangle \\ T^{(3)} &= \langle\langle m_1 \rangle\rangle \otimes \langle E_1 \rangle_{\mathcal{A}} \otimes \langle\langle s_1 \rangle\rangle \otimes \langle U_2 \rangle \otimes \langle\langle n_2 \rangle\rangle \\ T^{(4)} &= \langle\langle m_1 \rangle\rangle \otimes \langle V_1 \rangle \otimes \langle\langle s_1 \rangle\rangle \otimes \langle E_2 \rangle_{\mathcal{A}} \otimes \langle\langle n_2 \rangle\rangle \\ T^{(5)} &= \langle\langle m_1 \rangle\rangle \otimes \langle U_1 \rangle \otimes \langle\langle s_1 \rangle\rangle \otimes \langle E_2 \rangle_{\mathcal{A}} \otimes \langle\langle n_2 \rangle\rangle \\ T^{(6)} &= \langle\langle\langle m_1 \rangle\rangle \otimes \langle E_1 \rangle_{\mathcal{A}} \otimes \langle\langle s_1 \rangle\rangle \otimes \langle V_2 \rangle \otimes \langle\langle n_2 \rangle\rangle \end{aligned}$$

Clearly, eqn.(21) implies eqn.(22), which completes the proof in this first Sub-case 1a.

SUB-CASE 1b $m_1 + t_1 > m_2, n_2 + t_2 > n_1, m_1 \leq m_2$ and $n_2 \leq n_1$

Here the argument is much simpler than in the preceding Sub-case:

Using eqn.20, let us set

$$s := m_1 + t_1 - m_2 \text{ and } n_2 + t_2 - n_1 .$$

Examination of Fig. 31 shows that here

$$\mathcal{M} = m_1 \bullet \mathcal{M}' \bullet n_2$$

where we set

$$\mathcal{M}' := \mathcal{M}(0, t_2 - s, t_1 - s, 0)$$

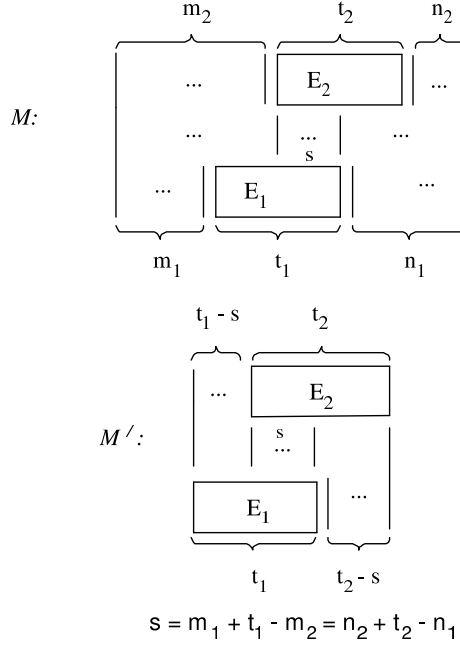

Figure 31: Sub-case 1b

The movie-move \mathcal{M}' of type 31, is in fact reduced— falling under Subcase 1A(s) of Algorithm A. By Assumption 3, \mathcal{A} respects \mathcal{M}' , hence, by (b) of Prop.46, \mathcal{A} respects \mathcal{M} —which proves our proposition holds in the Sub-case 1b.

SUB-CASE 1c $m_1 > m_2$ and $n_1 > n_2$

We then set

$$s_1 := m_1 - m_2 \text{ and } s_2 := n_1 - n_2$$

so that $s_1 > 0, s_2 > 0$ and (because of eqn.(20))

$$s_1 + s_2 = t_2 - t_1 .$$

Hence the movie-move

$$\mathcal{M}' := \mathcal{M}(E_1, E_2; s_1, s_2, 0, 0)$$

of type 31, is reduced. (It falls under Sub-case 1B(s_1, s_2) of Algorithm A.) Examination of Fig. 32 shows that

$$\mathcal{M} = m_1 \bullet \mathcal{M}' \bullet n_2 ,$$

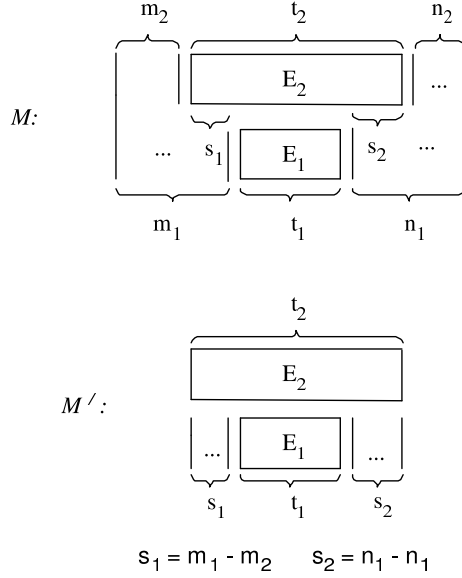

Figure 32: Sub-case 1c

and we conclude by precisely the same argument used in the preceding Sub-case.

The remaining two Sub-cases of Case 1, are:

SUB-CASE 1d $m_2 + t_2 > m_1, n_2 + t_1 > n_1, m_2 \leq m_1$ and $n_2 \leq n_1$
and

SUB-CASE 1e $n_2 \geq n_1 + t_1$.

These are obtained from Sub-cases 1b and 1a (in that order) by interchanging left and right (i.e., by the symmetry m .) The related reduced movie-moves are, respectively,

$$\mathcal{M}(E_1, E_2; t_2 - s, 0, 0, t_1 - s) \text{ where } s = t_1 + n_2 - n_1 = t_2 + m_2 - m_1$$

and

$$\mathcal{M}(E_1, E_2; t_2, 0, 0, t_1) .$$

Case 3, where $t_1 > t_2$, is precisely similar to Case 1 (Also, it can be obtained from Case 1, by applying the symmetry t .) Finally, Case 2, where $t_1 = t_2$, is like Cases 1 and 3.

3.4 Strongly Normal Amplitude-Assignments

In the following, we shall be studying certain linear equations over the ground-field

$$\mathbb{K} := \mathbb{Q}(q) .$$

Let m, n be natural numbers. Recall that, in the category Σ , defined in §2.1, we denote by $Hom_{\Sigma}(m, n)$ the set of stills S such that

$$source(S) = m, target(S) = n ,$$

i.e., which have m lines coming in at the bottom, and n lines going out at the top. Also, we shall denote by $Map(m, n)$ the set of all \mathbb{K} -linear maps from $V_1^{\otimes m}$ to $V_1^{\otimes n}$, where

$$V_1 := V \otimes_{\mathbb{Z}[q, q^{-1}]} \mathbb{K}$$

If S is a still in $Hom_{\Sigma}(m, n)$, then by a slight abuse of notation, its Kauffman amplitude $\langle S \rangle$ will be identified with the corresponding element

$$\langle S \rangle \otimes \mathbb{K}$$

in $Map(m, n)$.

For each elementary transition \mathcal{T} , of type between 1 and 7, the ordered pair

$$(in(\mathcal{T}), out(\mathcal{T}))$$

is one of the ordered pairs in the set

$$\mathcal{P} = \{(0, 0), (2, 0), (1, 1), (0, 2), (3, 1), (2, 2), (1, 3), (3, 3)\}$$

Definition 55 *To each pair (m, n) in \mathcal{P} , we associate a positive integer $N(m, n)$, and a collection of $N(m, n)$ stills in $Hom_{\Sigma}(m, n)$, as follows. (See Fig. 33)*

$$\underline{\text{if } (m, n) = (0, 0) : N(0, 0) = 1, S_1^{0,0} = 1_0}$$

$$\underline{\text{if } (m, n) = (2, 0) : N(2, 0) = 1, S_1^{2,0} = [0, Cap, 0]}$$

$$\underline{\text{if } (m, n) = (1, 1) : N(1, 1) = 1, S_1^{1,1} = 1_1}$$

$$\underline{\text{if } (m, n) = (0, 2) : N(0, 2) = 1, S_1^{0,2} = [0, Cup, 0]}$$

$$\underline{\text{if } (m, n) = (3, 1) : N(3, 1) = 2, S_1^{3,1} = [1, Cap, 0], S_2^{3,1} = [0, Cap, 1]}$$

$$\underline{\text{if } (m, n) = (2, 2) : N(2, 2) = 2, S_1^{2,2} = 1_2, S_2^{2,2} = [0, Cap, 0][0, Cup, 0]}$$

$$\underline{\text{if } (m, n) = (1, 3) : N(1, 3) = 2, S_1^{1,3} = [1, Cup, 0], S_2^{1,3} = [0, Cup, 1]}$$

$$\underline{\text{if } (m, n) = (3, 3) : N(3, 3) = 5, S_1^{3,3} = 1_3, S_2^{3,3} = [1, Cap, 0][1, Cup, 0],}$$

$$S_3^{3,3} = [0, Cap, 1][0, Cup, 1], S_4^{3,3} = [0, Cap, 1][1, Cup, 0], S_5^{3,3} = [1, Cap, 0][0, Cup, 1].$$

$$\begin{aligned}
\mathbf{S}_1^{0,0} &= \langle \text{EMPTY} \rangle \\
\mathbf{S}_1^{2,0} &= \cap \\
\mathbf{S}_1^{1,1} &= | \\
\mathbf{S}_1^{0,2} &= \cup \\
\mathbf{S}_1^{3,1} &= |\cap \quad \mathbf{S}_2^{3,1} = \cap| \\
\mathbf{S}_1^{2,2} &= || \quad \mathbf{S}_2^{2,2} = \cup \\
\mathbf{S}_1^{1,3} &= |\cup \quad \mathbf{S}_2^{1,3} = \cup| \\
\mathbf{S}_1^{3,3} &= ||| \quad \mathbf{S}_2^{3,3} = |\cup \quad \mathbf{S}_3^{3,3} = \cup| \quad \mathbf{S}_4^{3,3} = \cup| \cup \quad \mathbf{S}_5^{3,3} = \cup| \cap
\end{aligned}$$

Figure 33: Basic Stills

Definition 56 Let \mathcal{A} be an amplitude-assignment. Recall that \mathcal{A} is called **semi-normal** when, for every elementary transition $E : S \Rightarrow T$ of type either 0 or 8,

$$\langle E \rangle_{\mathcal{A}} = \langle S \rangle = \langle T \rangle .$$

\mathcal{A} will be called **strongly normal** if it is semi-normal, and if, in addition, for every elementary transition E of type between 1 and 7 inclusive, the linear transformation

$$\langle E \rangle_{\mathcal{A}} : V_1^{\text{in}(E)} \Rightarrow V_1^{\text{out}(E)}$$

satisfies the following condition:

Let $m = \text{in}(E)$ and $n = \text{out}(E)$ (so that (m, n) is an element of \mathcal{P});

then $\langle E \rangle_{\mathcal{A}}$ is a \mathbb{K} -linear combination of the $N(m, n)$ Kauffman amplitudes

$$\{\langle S_j^{m,n} \rangle \mid 1 \leq j \leq N(m, n)\} . \quad (23)$$

By imposing this Ansatz of strong normality¹⁶, the problem of constructing an amplitude-assignment which is \mathcal{U} -balanced, becomes, as we shall now

¹⁶The maps (23) are in fact $sl_q(2)$ -linear. As motivation for this definition of ‘strongly normal’, we note that it is equivalent to the requirement that each $\langle E \rangle_{\mathcal{A}}$ be $sl_q(2)$ -linear. We omit the proof, since it is not needed for any later results, and would add considerably to the length of the paper, without producing any further invariants.

see, the feasible problem of solving a manageable number of linear equations (over two thousand, for instance, if $\mathcal{U} = \{31\}$) in a manageable number 102 of unknowns. (The price paid for this desirable reduction, is that we lose track in this paper, of whatever 2-knot invariants arise via the present constructions from non-strongly normal amplitude-assignments.)

We may now coordinatize strongly normal amplitude-assignments \mathcal{A} via 102 parameters in \mathbb{K} , as follows:

If \mathcal{A} is a strongly normal amplitude-assignment, and if E is an elementary transition of type between 1 and 7 inclusive—say with $m = in(E)$ and $n = out(E)$ —then, as just proved, there exist uniquely $N(m, n)$ elements

$$\{PE_j(\mathcal{A}) \mid 1 \leq j \leq N(m, n)\} \quad (24)$$

in the ground-field \mathbb{K} , such that

$$\langle E \rangle_{\mathcal{A}} = \sum_{j=1}^{N(m,n)} PE_j(\mathcal{A}) \langle S_j^{m,n} \rangle . \quad (25)$$

In this way, we associate to every strongly normal amplitude-assignment \mathcal{A} , a collection

$\{P_j^E(\mathcal{A}) \mid E \text{ an elementary transition with } 1 \leq type(E) \leq 7, 1 \leq j \leq N(in(E), out(E))\}$ consisting of

$$\begin{aligned} & \sum_{i=1}^7 \sum_{(E \text{ an elementary transition of type } i)} N(in(E), out(E)) \\ & = 8 \times 1 + 4 \times 2 + 12 \times 5 + 8 \times 2 + 4 \times 1 + 2 \times 1 + 2 \times 2 = 102 \end{aligned}$$

elements of \mathbb{K} , which we shall call the **normal coordinates** of \mathcal{A} .

By means of these normal coordinates, the set of all strongly normal amplitude-assignments \mathcal{A} , is put in bijection with the free module of rank 102 over \mathbb{K} . The condition that such \mathcal{A} be \mathcal{U} -balanced, is, as will next be proved, equivalent to a collection of linear equations over \mathbb{K} in its normal coordinates which we shall call the **associated equations**. The final task in the program we have called Program A, is the computation of the associated equations, and their complete solution over \mathbb{K} .

Let us denote by \mathcal{PARM} the set of 102 formal symbols

$$\{PE_j \mid E \in \mathcal{ET}, 1 \leq j \leq N(in(E), out(E))\} ,$$

and by $\mathbb{K}.\mathcal{PARM}$ the free \mathbb{K} -module on the set \mathcal{PARM} . Thus, the ‘normal coordinates’ described above, give the bijection

$$\Phi : \{\text{strongly normal amplitude-assignments } \mathcal{A}\} \simeq \mathbb{K}.\mathcal{PARM},$$

$$\mathcal{A} \mapsto \sum_{E \in \mathcal{ET}} \sum_{j=1}^{N(in(E), out(E))} PE_j(\mathcal{A}) PE_j$$

(where \mathcal{A} may be reconstructed from its image $\Phi(\mathcal{A})$ via Def.48 and Eqn.(25).)

3.5 Associated Equations

We next turn to this question:

Given a flicker F and a strongly normal amplitude-assignment \mathcal{A} , how do we compute $\langle F \rangle_{\mathcal{A}}$ in terms of the normal coordinates of \mathcal{A} ?

We subdivide the set of flickers into 3 disjoint subsets, which yield somewhat different answers to this question.

CASE 1: F is of type 0 or 8

With the notation of Def. 17,

$$F = (E, B, m, n, T)$$

where $E : S' \Rightarrow S''$ is an elementary transition of type 0 or 8, B and T are stills (either or both of which may be empty), m and n are natural numbers (which may be 0), such that the two following relations are satisfied:

$$\text{target}(B) = m + \text{in}(E) + n$$

$$\text{source}(T) = m + \text{out}(E) + n$$

By assumption, \mathcal{A} is strongly normal and hence semi-normal, so

$$\langle E \rangle_{\mathcal{A}} = \langle S' \rangle = \langle S'' \rangle$$

Hence,

$$\langle F \rangle_{\mathcal{A}} = \langle T \rangle \circ (\text{Id}_{V_1^{\otimes m}} \otimes \langle S' \rangle \otimes \text{Id}_{V_1^{\otimes n}}) \circ \langle B \rangle$$

and so finally

$$\langle F \rangle_{\mathcal{A}} = \langle S_F \rangle \tag{A_1}$$

where

$$S_F = T \circ (m \bullet S' \bullet n) \circ B . \tag{A_2}$$

(Note that in this case, $\langle F \rangle_{\mathcal{A}} = \langle S_F \rangle$ is independent of \mathcal{A} .)

CASE 2: F is of type i with $1 \leq i \leq 7$

Here again, $F = (E, B, m, n, T)$ where now E is an elementary transition of type i . Let us assume that $p = \text{in}(E)$ and $q = \text{out}(E)$; then by Eqn. 25,

$$\langle E \rangle_{\mathcal{A}} = \sum_{j=1}^{N(p,q)} PE_j(\mathcal{A}) \langle S_j^{p,q} \rangle .$$

By Def. 42,

$$\langle F \rangle_{\mathcal{A}} = \langle T \rangle \circ (\text{Id}_{V_1^{\otimes m}} \otimes \langle E \rangle_{\mathcal{A}} \otimes \text{Id}_{V_1^{\otimes n}}) \circ \langle B \rangle$$

Combining the two preceding equations, we get

$$\langle F \rangle_{\mathcal{A}} = \sum_{j=1}^{N(p,q)} PE_j(\mathcal{A}) \langle S_j^{p,q}(F) \rangle, \quad (B_1)$$

where the stills $S_j^{p,q}(F)$ (which we note are independent of \mathcal{A}) are given by

$$S_j^{p,q}(F) = T \circ (m \bullet S_j^{p,q} \bullet n) \circ B. \quad (B_2)$$

CASE 3: $F = 1_S$

Here, by definition,

$$\langle F \rangle_{\mathcal{A}} = \langle S \rangle. \quad (C)$$

We next consider the analogous question, with flickers replaced by movies:

Proposition 57 *Given a movie M , with*

$$m = in(M), \quad n = out(M)$$

there exist the following (depending on M , but not on \mathcal{A}):

- *Natural numbers p, q*
- *$\epsilon_1, \dots, \epsilon_p, \epsilon'_1, \dots, \epsilon'_q$ in $\{1, -1\}$*
- *Stills $S_1, \dots, S_p, T_1, \dots, T_q$ (not necessarily all distinct) with origin m and terminus n*
- *Elements (not necessarily all distinct) $(E^1, k^{(1)}), \dots, (E^q, k^{(q)})$ in \mathcal{PARM}*

*such that, for every strongly normal amplitude-assignment \mathcal{A} ,*¹⁷

$$\langle M \rangle_{\mathcal{A}} = \sum_{i=1}^p \epsilon_i \langle S_i \rangle + \sum_{j=1}^q \epsilon'_j (PE^j)_{k^{(j)}}(\mathcal{A}) \langle T_j \rangle. \quad (26)$$

¹⁷If p or q is 0, we use the usual convention that an empty sum is 0.

PROOF:

Let us assume the flickers in M are given by

$$M = F_1 \cdots F_p ,$$

so that the $p + 1$ stills in M are given by

$$S_1 = \text{source}(F_1), S_i = \text{source}(F_i) = \text{target}(F_{i-1}) \text{ for } 1 \leq i \leq p, S_{p+1} = \text{target}(F_p) ,$$

Then Def. 43 implies

$$\langle M \rangle_{\mathcal{A}} = \sum_{i=1}^{p+1} \langle S_i \rangle - \sum_{i=1}^p \langle F_i \rangle_{\mathcal{A}} . \quad (27)$$

Consider the set \mathcal{E} of all \mathbb{K} -linear maps

$$V_1^{\otimes m} \mapsto V_1^{\otimes n}$$

that can be expressed in the form given by the right side of (26). If F and G lie in \mathcal{E} then also $\pm F \pm G$ can be expressed in this form; since each term in the right side of (27) lies in \mathcal{E} , (using equations (A), (B), (C) in the preceding discussion), so does $\langle M \rangle_{\mathcal{A}}$,

Q.E.D.

Proposition 58 *Let $\mathcal{M} = (M_1, M_2)$ be a grammatical pair of movies; then there exists a finite collection (say, of cardinality $\nu(\mathcal{M})$) of inhomogeneous equations in the 102 variables PE_j :*

$$\sum_{PE_j \in \text{PARAM}} C(E, j, k) PE_j = D(E, j, k) \quad (1 \leq k \leq \nu(\mathcal{M})) \quad (28)$$

having all coefficients C and D in \mathbb{K} —with this property:

For every strongly normal amplitude-assignment \mathcal{A} , the system of $\nu(\mathcal{M})$ equations (28) are necessary and sufficient for \mathcal{A} to respect \mathcal{M} —more precisely,

$$\begin{aligned} \langle M_1 \rangle_{\mathcal{A}} = \langle M_2 \rangle_{\mathcal{A}} &\iff \\ \sum_{PE_j \in \text{PARAM}} C(E, j, k) PE_j(\mathcal{A}) &= D(E, j, k) \text{ for } 1 \leq k \leq \nu(\mathcal{M}) . \end{aligned}$$

Note: We shall call the system (28) of simultaneous linear equations over \mathbb{K} , the *equations associated to \mathcal{M}* .

PROOF of Prop. 58:

The assumption that \mathcal{M} is grammatical, implies (cf. Prop.30) that there exist natural numbers $m = in(\mathcal{M})$, $n = out(\mathcal{M})$ such that

$$m = in(M_1) = in(M_2) , n = out(M_1) = out(M_2) . \quad (29)$$

$\langle M_1 \rangle_{\mathcal{A}}$ and $\langle M_2 \rangle_{\mathcal{A}}$ may (by the preceding proposition) be written in the form (26), and hence so can $\langle M_1 \rangle - \langle M_2 \rangle_{\mathcal{A}}$ — i.e. there exist

$$p, q, \epsilon_1, \dots, \epsilon_p, \epsilon'_1, \dots, \epsilon'_q, S_1, \dots, S_p, T_1, \dots, T_q, (E^1, k^{(1)}), \dots, (E^q, k^{(q)})$$

as in the preceding proposition, (depending on \mathcal{M} but not on \mathcal{A}) such that, for every strongly normal amplitude-assignment \mathcal{A} ,

$$\langle M_1 \rangle_{\mathcal{A}} - \langle M_2 \rangle_{\mathcal{A}} = \sum_{i=1}^p \epsilon_i \langle S_i \rangle + \sum_{j=1}^q \epsilon'_j (PE^j)_{k^{(j)}}(\mathcal{A}) \langle T_j \rangle .$$

Hence, for every strongly normal amplitude-assignment \mathcal{A} , \mathcal{A} respects \mathcal{M} , if and only if

$$\sum_{i=1}^p \epsilon_i \langle S_i \rangle + \sum_{j=1}^q \epsilon'_j (PE^j)_{k^{(j)}}(\mathcal{A}) \langle T_j \rangle = 0 \quad (30)$$

Now, the Kauffman amplitudes

$$\langle S_i \rangle, \langle T_j \rangle \quad (*)$$

in (30), are all \mathbb{K} -linear maps from $V_1^{\otimes m}$ to $V_1^{\otimes n}$. If we choose \mathbb{K} -bases for $V_1^{\otimes m}$ and $V_1^{\otimes n}$, the amplitudes in (*) are all represented by $2^n \times 2^m$ matrices, so that the equation (30) between matrices, is equivalent (as asserted) to a collection of 2^{m+n} simultaneous linear equations over \mathbb{K} of the form (28).

In more detail:

Let \mathcal{B}_m denote the set of 2^m ordered m -tuples of 0's and 1's:

$$\mathcal{B}_m = \{(\epsilon_0, \dots, \epsilon_m) : \text{all } \epsilon'_s \in \{0, 1, \}\}$$

$V_1^{\otimes m}$ has the \mathbb{K} -basis (indexed by \mathcal{B}_m)

$$B_m = \{e_\alpha = e_{\epsilon_1} \otimes \dots \otimes e_{\epsilon_m} \mid \alpha = (\epsilon_1, \dots, \epsilon_m) \in \mathcal{B}_m\}$$

and $V_1^{\otimes n}$ has the similar basis B_n . With respect to this choice of bases for $V_1^{\otimes m}$ and $V_1^{\otimes n}$, let us assume that $\langle S_i \rangle, \langle T_j \rangle$ are represented, respectively, by the $2^m \times 2^m$ matrices

$$\mathcal{S}_{\beta,\alpha}^{(i)}, \mathcal{T}_{\beta,\alpha}^{(j)} \quad (\alpha \in \mathcal{B}_m, \beta \in \mathcal{B}_n)$$

over \mathbb{K} —i.e., that, for all α in \mathcal{B}_m ,

$$\langle S_i \rangle (e_\alpha) = \sum_{\beta \in \mathcal{B}_n} \mathcal{S}_{\beta,\alpha}^{(i)} e_\beta \quad \text{for } 1 \leq i \leq p$$

and

$$\langle T_j \rangle (e_\alpha) = \sum_{\beta \in \mathcal{B}_n} \mathcal{T}_{\beta,\alpha}^{(j)} e_\beta \quad \text{for } 1 \leq j \leq q$$

Then the necessary and sufficient condition that \mathcal{A} respect \mathcal{M} , i.e., that (30) hold, is that, for all α in \mathcal{B}_m and all β in \mathcal{B}_n ,

$$\sum_{i=1}^p \epsilon_i \mathcal{S}_{\beta,\alpha}^{(i)} + \sum_{j=1}^q \epsilon'_j (PE^j)_{k(j)}(\mathcal{A}) \mathcal{T}_{\beta,\alpha}^{(j)} = 0 \quad (31)$$

Since each of the 2^{m+n} equations (31) is essentially in the format (28) the proof of Prop. 58 is complete.

REMARKS:

REMARK ONE: For the purposes of the present paper, the proof just presented should be thought of, not so much as demonstrating a mathematical existence theorem, but rather as sketching an algorithm for computing the system of equations associated to a movie-move \mathcal{M} . This algorithm is incorporated in 2KnotsLib.

REMARK TWO: Let us note that the preceding proof gives a **specific** collection (28) of equations associated to \mathcal{M} , which we shall denote by $Assoc(\mathcal{M})$. The cardinality of $Assoc(\mathcal{M})$ is $\nu(\mathcal{M}) = 2^{in(\mathcal{M})+out(\mathcal{M})}$.

We are finally ready to construct —using our class libraries—a driver program for computing \mathcal{U} -balanced amplitude-assignments. This program will only consider **strongly normal** amplitude-assignments; the present authors do not know if there exist \mathcal{U} -balanced amplitude-assignments which are not strongly normal, and if there are, our present considerations seem to give no information concerning them. By contrast, we shall explicitly compute **all** \mathcal{U} -balanced strongly normal amplitude-assignments.

We shall from now on assume that \mathcal{A} is a strongly normal amplitude-assignment. By combining Propositions 52, 54 and 58, we obtain an explicitly computable collection of linear equations over \mathbb{K} , for the strongly normal coordinates of \mathcal{A} , whose solutions give the set of all such \mathcal{A} which are \mathcal{U} -balanced. In more detail:

We divide into two cases, according as $31 \in \mathcal{U}$ or not.

Consider first the case that $31 \in \mathcal{U}$:

Since strongly normal implies semi-normal, we may apply (b) of Prop. 52, which says that \mathcal{A} is \mathcal{U} -balanced, if and only if it respects each of the finitely many movie-moves in the set

$$\mathcal{S} := \bigcup_{i \in \mathcal{U}^c} ((\mathcal{SYM} \circ \mathcal{C}) \cap \mathcal{MM}_i) \quad (32)$$

(Recall that \mathcal{C} denotes the set of 40 BL-reduced movie-moves whose type lies in $B = \{i \mid 1 \leq i \leq 14\} \cup \{21\} \cup \{i \mid 23 \leq i \leq 30\}$.)

Let $\mathcal{M} = (M_1, M_2)$ be a movie-move in \mathcal{S} . Movie-moves are grammatical, so we may apply Prop. 58 to \mathcal{M} : there is a finite collection $Assoc(\mathcal{M})$, consisting of

$$\nu(\mathcal{M}) = 2^{in(\mathcal{M})+out(\mathcal{M})}$$

inhomogeneous linear equations in the 102 normal coordinates of \mathcal{A} with coefficients in \mathbb{K} :

$$\sum_{PE_j \in \mathcal{PARM}} C(E, j, k) PE_j(\mathcal{A}) = D(E, j, k) \text{ for } 1 \leq k \leq \nu(\mathcal{M}) .$$

which hold simultaneously, if and only if \mathcal{A} respects \mathcal{M} .

Let us define the set $Assoc(\mathcal{U})$ of \mathcal{U} -associated equations, to be the union of the sets of associated equations to all movie-moves in (32).

Then, combining the two preceding observations, we see that \mathcal{A} is \mathcal{U} -balanced, if and only if its 102 normal coordinates satisfy each of the linear equations in the finite set $Assoc(\mathcal{U})$ of associated equations—provided that $31 \in \mathcal{U}$.

Consider next the case $31 \notin \mathcal{U}$:

The computation precisely is the same as that in the preceding case, except that we must replace \mathcal{S} (given by (32)) by

$$\mathcal{S}_1 := \left(\bigcup_{i \in \mathcal{U}^c \setminus \{31\}} ((\mathcal{SYM} \circ \mathcal{C}) \cap \mathcal{MM}_i) \right) \bigcup \mathcal{MM}_{31}^{red}$$

and then define $Assoc(\mathcal{U})$ to be the union of the sets of associated equations to all movie-moves in \mathcal{S}_1 .

3.6 Proof that Movie-move 31 is Essential

As an application of the machinery developed above, we now sketch a proof of the result, announced in the introduction, that the movie-moves of type 31 are ‘essential’, i.e. cannot be deduced from the remaining movie-moves, in the sense of Def. 1.

The proof to be presented here, involves explicitly solving the system $\text{Assoc}(\mathcal{U})$ of equations associated to \mathcal{U} , in the two special cases $\mathcal{U} = \{31\}$ and $\mathcal{U} = \emptyset$.

What is the cardinality of the set $\text{Assoc}(\{31\})$? Both versions of the 2KnotsLib (augmented in both cases by the driver Program A) furnish the same answer to this question, namely 12288. There are not ‘really’ that many equations to solve: we can reduce this number substantially, by the two simple expedients of:

- a) removing wherever it occurs in $\text{Assoc}(\{31\})$, the equation $0 = 0$, and,
- b) if any equation occurs more than once in $\text{Assoc}(\{31\})$, retaining only one copy (If one equation is a scalar multiple of a second— but not identical with it—they are to count as distinct in this new tally.)

Let us denote by $\text{Assoc}'(\{31\})$ the smaller (but equivalent) collection of equations thus obtained. 2KnotsLib tells us the cardinality of $\text{Assoc}'(\{31\})$ is 2856. The most general solution to this set $\text{Assoc}'(\{31\})$ of 2856 inhomogeneous linear equations over the field K in 102 unknowns is furnished by both versions of the driver Program B, with the following results (which would seem difficult to establish without use of the computer, at least using only the methods of the present paper):

The rank of this system of 2856 equations in 102 unknowns is 98. The family of all solutions represents an affine subspace of F^{102} , of affine ¹⁸rank $102 - 98 = 4$. (The reader who wishes to see explicitly the resulting $\{31\}$ -balanced amplitude-assignments, is referred to §4.1 below)

NOTE: Since there are many more equations than unknowns, it seems like more good luck than one should have a right to expect, that this method of constructing $\{31\}$ -regular isotopy invariants for 2-knots works. Perhaps the credit for this minor miracle should go to Def. 43, i.e. the preceding paragraph furnishes evidence for the suitability of formula (13) for the amplitude of a movie. In another direction: When equations have more solutions than

¹⁸Recall that, if S is an affine subspace of K^n , then if S is empty, it is said to have affine rank -1 , while if there exists $v \in S$, then $\{v' - v | v' \in S\}$ is a vector subspace of K^n , whose dimension over K (which is independent of the choice of v in S) is called the affine rank of S .

one might anticipate, one suspects the explanation involves the action of some symmetry—here perhaps the action of the quantum group $sl_q(2)$.

More generally, for any proper subset \mathcal{U} , we may define $\text{rk}(\mathcal{U})$ to be the affine rank of the affine subspace of K^{102} , defined by the system of equations $\text{Assoc}(\mathcal{U})$. The preceding discussion shows that $\text{rk}(\{31\}) = 4$. Another application of the two 2KnotsLib class libraries shows that $\text{rk}(\emptyset)=1$ (cf §4.1 below, based on solving a reduced system $\text{Assoc}'(\emptyset)$ of 10,208 equations in 102 unknowns).

Proposition 59 *Let $1 \leq i \leq 31$; then $\text{rk}(\{i\}) \geq 1$, and a sufficient condition for i to be essential, is that $\text{rk}(\{i\}) > 1$.*

Sketch of proof: Let S, S_0 be the affine subspaces of K^{102} defined respectively by $\text{Assoc}(\{i\})$ and $\text{Assoc}(\emptyset)$. Since

$$\text{Assoc}(\{i\}) \subseteq \text{Assoc}(\emptyset)$$

we have $S \supseteq S_0$ and hence $\text{rk}(\{i\}) \geq 1$.

Now assume that i is not essential; then every $\{i\}$ -balanced amplitude-assignment is \emptyset -balanced, which implies $S = S_0$, and hence $\text{rk}(\{i\}) = 1$. Q.E.D.

Corollary: *Movie-moves of type 31 are essential* (i.e. the Carter-Rieger-Saito Movie-move Theorem would no longer be correct if they were omitted from the full list of movie-moves.)

AN OPEN QUESTION

Our program shows that not every i between 1 and 31 satisfies the condition

$$\text{rk}(\{i\}) > 1$$

of Prop. 59—for instance, for type 6 (a collection of movie-moves related to the Knizhnik-Zamolodchikov equations, as Reidemeister III is to the Yang-Baxter equations) both versions of the 2Knots class library show that $\text{rk}(\{6\})=1$.

This raises the question, which unfortunately we must leave open at this time, whether the converse to Prop. 59 holds:

CONJECTURE 1: Let $1 \leq i \leq 31$; then movie-moves of type i are essential, if and only if

$$\text{rk}(\{i\}) > 1 .$$

4 Some Examples

In §3.9 we discussed the general solution to the set of equations $Assoc(\mathcal{U})$ for the two cases $\mathcal{U} = \{31\}$ and $\mathcal{U} = \emptyset$. In the present section, we continue this discussion, and compute the associated \mathcal{U} -regular isotopy invariants for seven specific examples of 2-knots—namely, an unknotted sphere, Klein bottle and torus, two knotted spheres and the ‘1-twist and 2-twist spun trefoil’ described on p.36 of [CS2].

These seven examples are given in the **sf-notation** described in section 2.4. This is the input format for both the Java and C++ programs. However the two programs use slightly different syntax for comments and end markers for input movies. The Java program expects movies to be terminated by a ‘.’ and comment lines to begin with ‘#’; the C++ program (whose notation will be used in the present section) uses ‘%’ to begin comment lines and ‘#’ to terminate each input movie. See the class libraries’ respective documentations for details.

4.1 \mathcal{U} -regular isotopy for $\mathcal{U} = \{31\}$ and for $\mathcal{U} = \emptyset$

The Case $\mathcal{U} = \{31\}$

As we saw in §3.9, the $\{31\}$ -regular isotopy invariants are furnished by the solutions to a set (furnished by our driver program A) of 2856 inhomogenous linear equations over the ground-field $\mathbb{K} = \mathbb{Q}(q)$ in 102 unknowns.

This system of 2856 equations in the 102 normal coordinates has affine rank 4 (cf. footnote (18)). The family of all solutions is parametrized below, where t_1, t_2, t_3 , and t_4 can have arbitrary values from $\mathbb{K} = \mathbb{Q}(q)$. (See the ReadMes accompanying our two class libraries, for discussion of how this parametrization is obtained.)

$$\begin{array}{lll}
 P_{ET1I_1} & = t_1 & P_{ET3mbt_3} = q^{-1} & P_{ET3tmb_1} = q^{-3} \\
 P_{ET1R_1} & = -t_1 + 1 - q^{-3} & P_{ET3mbt_4} = q^{-3} & P_{ET3tmb_2} = q^{-1} \\
 P_{ET1t_1} & = (q^3)t_1 - q^3 + 1 & P_{ET3mbt_5} = q & P_{ET3tmb_3} = q^{-1} \\
 P_{ET1tR_1} & = (-q^3)t_1 & P_{ET3mbtR_1} = q & P_{ET3tmb_4} = q \\
 P_{ET1f_1} & = (q^3)t_1 - q^3 + 1 & P_{ET3mbtR_2} = q^{-1} & P_{ET3tmb_5} = q \\
 P_{ET1fR_1} & = (-q^3)t_1 & P_{ET3mbtR_3} = q^{-1} & P_{ET3tmbR_1} = q^{-3} \\
 P_{ET1ft_1} & = t_1 & P_{ET3mbtR_4} = q^{-3} & P_{ET3tmbR_2} = q^{-1} \\
 P_{ET1ftR_1} & = -t_1 + 1 - q^{-3} & P_{ET3mbtR_5} = q & P_{ET3tmbR_3} = q^{-1} \\
 P_{ET2I_1} & = 1 & P_{ET3tmb_1} = q^{-1} & P_{ET3tmbR_4} = q \\
 P_{ET2I_2} & = 0 & P_{ET3tmb_2} = q & P_{ET3tmbR_5} = q \\
 P_{ET2R_1} & = 1 & P_{ET3tmb_3} = q & P_{ET4I_1} = q
 \end{array}$$

$$\begin{array}{lll}
P_{ET2R_2} = 0 & P_{ET3mtb_4} = q^3 & P_{ET4I_2} = q^{-1} \\
P_{ET2f_1} = 1 & P_{ET3mtb_5} = q^{-1} & P_{ET4R_1} = q \\
P_{ET2f_2} = 0 & P_{ET3mtbR_1} = q^{-1} & P_{ET4R_2} = q^{-1} \\
P_{ET2fR_1} = 1 & P_{ET3mtbR_2} = q & P_{ET4t_1} = q^{-1} \\
P_{ET2fR_2} = 0 & P_{ET3mtbR_3} = q & P_{ET4t_2} = q \\
P_{ET3bmt_1} = q^3 & P_{ET3mtbR_4} = q^3 & P_{ET4tR_1} = q^{-1} \\
P_{ET3bmt_2} = q & P_{ET3mtbR_5} = q^{-1} & P_{ET4tR_2} = q \\
P_{ET3bmt_3} = q & P_{ET3tbm_1} = q^{-1} & P_{ET4f_1} = q^{-1} \\
P_{ET3bmt_4} = q^{-1} & P_{ET3tbm_2} = q & P_{ET4f_2} = q \\
P_{ET3bmt_5} = q^{-1} & P_{ET3tbm_3} = q & P_{ET4fR_1} = q^{-1} \\
P_{ET3bmtR_1} = q^3 & P_{ET3tbm_4} = q^{-1} & P_{ET4fR_2} = q \\
P_{ET3bmtR_2} = q & P_{ET3tbm_5} = q^3 & P_{ET4ft_1} = q \\
P_{ET3bmtR_3} = q & P_{ET3tbmR_1} = q^{-1} & P_{ET4ft_2} = q^{-1} \\
P_{ET3bmtR_4} = q^{-1} & P_{ET3tbmR_2} = q & P_{ET4ftR_1} = q \\
P_{ET3bmtR_5} = q^{-1} & P_{ET3tbmR_3} = q & P_{ET4ftR_2} = q^{-1} \\
P_{ET3btm_1} = q & P_{ET3tbmR_4} = q^{-1} & \\
P_{ET3btm_2} = q^{-1} & P_{ET3tbmR_5} = q^3 & \\
P_{ET3btm_3} = q^{-1} & P_{ET5I_1} = -t_4 + (q^2 + q^{-2})(t_3 - 1) - t_2 + 2 & \\
P_{ET3btm_4} = q & P_{ET5R_1} = t_4 + (-q^2 - q^{-2})(t_3 - 1) + t_2 & \\
P_{ET3btm_5} = q^{-3} & P_{ET5t_1} = -t_4 + (q^2 + q^{-2})(t_3 - 1) - t_2 + 2 & \\
P_{ET3btmR_1} = q & P_{ET5tR_1} = t_4 + (-q^2 - q^{-2})(t_3 - 1) + t_2 & \\
P_{ET3btmR_2} = q^{-1} & P_{ET6I_1} = (q^2 - 1 + q^{-2})(t_4 + t_3 - 2) - t_2 & \\
P_{ET3btmR_3} = q^{-1} & P_{ET6R_1} = t_2 & \\
P_{ET3btmR_4} = q & P_{ET7I_1} = (q^2 + q^{-2})(t_3 - 1) - t_2 + 1 & \\
P_{ET3btmR_5} = q^{-3} & P_{ET7I_2} = t_3 & \\
P_{ET3mbt_1} = q & P_{ET7R_1} = t_4 + (-q^2 + 1 - q^{-2})(t_3 - 1) + t_2 & \\
P_{ET3mbt_2} = q^{-1} & P_{ET7R_2} = t_4 &
\end{array}$$

We will denote by \mathcal{A}_0 the $\{31\}$ -balanced normal amplitude assignment obtained from our solution by setting each $t_i = 0$. In addition, for each $i = 1, 2, 3, 4$, we define a $\{31\}$ -balanced normal amplitude assignment \mathcal{A}_i to be the normal coordinate assignment obtained from our solutions, where $t_i = 1$ and $t_j = 0$ for each $j \neq i$.

For a movie M ,

$$\langle M \rangle_i := \langle M \rangle_{\mathcal{A}_i} \quad (0 \leq i \leq 4)$$

will denote the amplitudes of M for the $\{31\}$ -balanced amplitude assignments \mathcal{A}_i .

The Case $\mathcal{U} = \emptyset$:

Consideration of the set \mathcal{M}_{31}^{red} alone generates 3194 \emptyset -associated equations after removing zero equations and repetitions.

With the extra associated equations provided by movie move 31, the solutions to the \emptyset -associated equations in the 102 normal coordinates affine rank 1. The general solution in this case is given below where t can have arbitrary value in the ground-field, \mathbb{K} .

$$\begin{array}{lll}
P_{ET1I_1} & = (1 + q^{-3})t - q^{-3} & P_{ET3mbt_3} = q^{-1} & P_{ET3tmb_1} = q^{-3} \\
P_{ET1R_1} & = (-1 - q^{-3})t + 1 & P_{ET3mbt_4} = q^{-3} & P_{ET3tmb_2} = q^{-1} \\
P_{ET1t_1} & = (q^3 + 1)t - q^3 & P_{ET3mbt_5} = q & P_{ET3tmb_3} = q^{-1} \\
P_{ET1tR_1} & = (-q^3 - 1)t + 1 & P_{ET3mbtR_1} = q & P_{ET3tmb_4} = q \\
P_{ET1f_1} & = (q^3 + 1)t - q^3 & P_{ET3mbtR_2} = q^{-1} & P_{ET3tmb_5} = q \\
P_{ET1fR_1} & = (-q^3 - 1)t + 1 & P_{ET3mbtR_3} = q^{-1} & P_{ET3tmbR_1} = q^{-3} \\
P_{ET1ft_1} & = (1 + q^{-3})t - q^{-3} & P_{ET3mbtR_4} = q^{-3} & P_{ET3tmbR_2} = q^{-1} \\
P_{ET1ftR_1} & = (-1 - q^{-3})t + 1 & P_{ET3mbtR_5} = q & P_{ET3tmbR_3} = q^{-1} \\
P_{ET2I_1} & = 1 & P_{ET3mtb_1} = q^{-1} & P_{ET3tmbR_4} = q \\
P_{ET2I_2} & = 0 & P_{ET3mtb_2} = q & P_{ET3tmbR_5} = q \\
P_{ET2R_1} & = 1 & P_{ET3mtb_3} = q & P_{ET4I_1} = q \\
P_{ET2R_2} & = 0 & P_{ET3mtb_4} = q^3 & P_{ET4I_2} = q^{-1} \\
P_{ET2f_1} & = 1 & P_{ET3mtb_5} = q^{-1} & P_{ET4R_1} = q \\
P_{ET2f_2} & = 0 & P_{ET3mtbR_1} = q^{-1} & P_{ET4R_2} = q^{-1} \\
P_{ET2fR_1} & = 1 & P_{ET3mtbR_2} = q & P_{ET4t_1} = q^{-1} \\
P_{ET2fR_2} & = 0 & P_{ET3mtbR_3} = q & P_{ET4t_2} = q \\
P_{ET3bmt_1} & = q^3 & P_{ET3mtbR_4} = q^3 & P_{ET4tR_1} = q^{-1} \\
P_{ET3bmt_2} & = q & P_{ET3mtbR_5} = q^{-1} & P_{ET4tR_2} = q \\
P_{ET3bmt_3} & = q & P_{ET3tbtm_1} = q^{-1} & P_{ET4f_1} = q^{-1} \\
P_{ET3bmt_4} & = q^{-1} & P_{ET3tbtm_2} = q & P_{ET4f_2} = q \\
P_{ET3bmt_5} & = q^{-1} & P_{ET3tbtm_3} = q & P_{ET4fR_1} = q^{-1} \\
P_{ET3bmtR_1} & = q^3 & P_{ET3tbtm_4} = q^{-1} & P_{ET4fR_2} = q \\
P_{ET3bmtR_2} & = q & P_{ET3tbtm_5} = q^3 & P_{ET4ft_1} = q \\
P_{ET3bmtR_3} & = q & P_{ET3tbtmR_1} = q^{-1} & P_{ET4ft_2} = q^{-1} \\
P_{ET3bmtR_4} & = q^{-1} & P_{ET3tbtmR_2} = q & P_{ET4ftR_1} = q \\
P_{ET3bmtR_5} & = q^{-1} & P_{ET3tbtmR_3} = q & P_{ET4ftR_2} = q^{-1} \\
P_{ET3btm_1} & = q & P_{ET3tbtmR_4} = q^{-1} & \\
P_{ET3btm_2} & = q^{-1} & P_{ET3tbtmR_5} = q^3 & \\
P_{ET3btm_3} & = q^{-1} & P_{ET5I_1} = 1 & \\
P_{ET3btm_4} & = q & P_{ET5R_1} = 1 &
\end{array}$$

$$\begin{array}{ll}
P_{ET3btm_5} = q^{-3} & P_{ET5t_1} = 1 \\
P_{ET3btmR_1} = q & P_{ET5tR_1} = 1 \\
P_{ET3btmR_2} = q^{-1} & P_{ET6I_1} = (q^2 + 1 + q^{-2})t - q^2 - q^{-2} \\
P_{ET3btmR_3} = q^{-1} & P_{ET6R_1} = (-q^2 - 1 - q^{-2})t + 1 \\
P_{ET3btmR_4} = q & P_{ET7I_1} = t \\
P_{ET3btmR_5} = q^{-3} & P_{ET7I_2} = -t + 1 \\
P_{ET3mbt_1} = q & P_{ET7R_1} = -t + 1 \\
P_{ET3mbt_2} = q^{-1} & P_{ET7R_2} = t
\end{array}$$

We will denote by \mathcal{A}_a the \emptyset -balanced normal amplitude assignment obtained from the preceding solution by setting $t = 0$, and by \mathcal{A}_b the \emptyset -balanced normal amplitude assignment obtained by setting $t = 1$. For a movie M , we then set

$$\langle M \rangle_a := \langle M \rangle_{\mathcal{A}_a}$$

and

$$\langle M \rangle_b := \langle M \rangle_{\mathcal{A}_b}$$

Note that, for any 2-tangle K , $\langle M \rangle_a$ has the same value for all movies M representing K , — and the same is true for $\langle \rangle_b$. (This is one of the few places in the present paper, where use is made of Th. 28.) However, the computations below provide evidence that the resulting isotopy invariants $\langle \rangle_a$ and $\langle \rangle_b$ are of a rather trivial nature —that is, these computations support the following conjecture:

Conjecture 2: For every 2-knot K , and every CRS movie M representing K ,

$$\langle M \rangle_a = \langle M \rangle_b = \text{the number of connected components of } K .$$

4.2 Example: An Unknotted Sphere

The first 2-knot is a simple unknotted 2-sphere.

```
% UnknottedSphere
ss => sf [0,Cup,0] [0,Cap,0] sf => ff #
```

with amplitudes:

Amplitudes for ($\mathcal{U} = \{31\}$):

$$\begin{aligned}
\langle \text{UnknottedSphere} \rangle_0 &= q^{-2} + q^2 \\
\langle \text{UnknottedSphere} \rangle_1 &= q^{-2} + q^2 \\
\langle \text{UnknottedSphere} \rangle_2 &= q^{-2} + q^2 \\
\langle \text{UnknottedSphere} \rangle_3 &= 1 \\
\langle \text{UnknottedSphere} \rangle_4 &= 1
\end{aligned}$$

Amplitudes for ($\mathcal{U} = \emptyset$):

$$\begin{aligned}
\langle \text{UnknottedSphere} \rangle_a &= 1 \\
\langle \text{UnknottedSphere} \rangle_b &= 1
\end{aligned}$$

4.3 Example: A Knotted Sphere

The next 2-knot is a knotted sphere communicated to us by Carter.

```

% KnottedSphereA
ss => ssf [0,Cup,0] [0,Cap,0] f =>
f [0,Cup,0] [0,Cap,0] f [0,Cup,0] ss [0,Cap,0] =>
[0,Cup,0] [0,Cap,0] [0,Cup,0] f [1,Cup,1] ss [0,Cap,2] f [0,Cap,0] =>
[0,Cup,0] [0,Cap,0] [0,Cup,0] [1,Cup,1] ssf [1,Cap,1] [1,Cup,1] f
[0,Cap,2] [0,Cap,0]
=> [0,Cup,0] [0,Cap,0] [0,Cup,0] [1,Cup,1] f [2,NW,0] [2,NE,0] f
[1,Cap,1] s [1,Cup,1] [0,Cap,2] s [0,Cap,0]
=> [0,Cup,0] [0,Cap,0] [0,Cup,0] [1,Cup,1] [2,NW,0] s [2,NE,0]
[1,Cap,1] sff [0,Cap,0]
=> [0,Cup,0] [0,Cap,0] [0,Cup,0] s [1,Cup,1] [2,NW,0] sf [1,NW,1]
[2,Cap,0] f [0,Cap,0]
=> [0,Cup,0] [0,Cap,0] [0,Cup,0] f [2,Cup,0] s [1,NE,1] f [1,NW,1] s
[2,Cap,0] [0,Cap,0]
=> [0,Cup,0] [0,Cap,0] s [0,Cup,0] [2,Cup,0] sff [2,Cap,0] [0,Cap,0] =>
[0,Cup,0] [0,Cap,0] f [0,Cup,0] s [0,Cup,2] f [2,Cap,0] s [0,Cap,0] =>
[0,Cup,0] s [0,Cap,0] [0,Cup,0] sf [0,Cap,0] [0,Cup,0] f [0,Cap,0] =>
[0,Cup,0] f [2,Cup,0] s [0,Cap,2] f [0,Cap,0] s [0,Cup,0] [0,Cap,0] =>
[0,Cup,0] [2,Cup,0] ssf [2,Cap,0] [0,Cap,0] f [0,Cup,0] [0,Cap,0] =>
[0,Cup,0] s [2,Cup,0] f [1,NE,1] s [1,NW,1] f [2,Cap,0] [0,Cap,0]
[0,Cup,0] [0,Cap,0]
=> [0,Cup,0] f [1,Cup,1] [2,NW,0] sf [1,NW,1] [2,Cap,0] s [0,Cap,0]
[0,Cup,0] [0,Cap,0]

```

```

=> [0,Cup,0] [1,Cup,1] s [2,NW,0] f [2,NE,0] s [1,Cap,1] f [0,Cap,0]
    [0,Cup,0] [0,Cap,0]
=> [0,Cup,0] [1,Cup,1] s s f f [1,Cap,1] [0,Cap,0] [0,Cup,0] [0,Cap,0] =>
[0,Cup,0] [1,Cup,1] f [2,NE,0] s [2,NW,0] f [1,Cap,1] s [0,Cap,0]
    [0,Cup,0] [0,Cap,0]
=> [0,Cup,0] s [1,Cup,1] [2,NE,0] s f [1,NE,1] [2,Cap,0] f [0,Cap,0]
    [0,Cup,0] [0,Cap,0]
=> [0,Cup,0] f [2,Cup,0] s [1,NW,1] f [1,NE,1] s [2,Cap,0] [0,Cap,0]
    [0,Cup,0] [0,Cap,0]
=> [0,Cup,0] [2,Cup,0] s f f [2,Cap,0] [0,Cap,0] s [0,Cup,0] [0,Cap,0] =>
[0,Cup,0] s [2,Cup,0] f [0,Cap,2] s [0,Cap,0] f [0,Cup,0] [0,Cap,0] =>
[0,Cup,0] f [0,Cap,0] [0,Cup,0] s f [0,Cap,0] [0,Cup,0] s [0,Cap,0] =>
[0,Cup,0] [0,Cap,0] s [0,Cup,0] f [0,Cup,2] s [2,Cap,0] f [0,Cap,0] =>
[0,Cup,0] [0,Cap,0] f [0,Cup,0] [2,Cup,0] s s f [2,Cap,0] [0,Cap,0] =>
[0,Cup,0] [0,Cap,0] [0,Cup,0] s [2,Cup,0] f [1,NE,1] s [1,NW,1] f
    [2,Cap,0] [0,Cap,0]
=> [0,Cup,0] [0,Cap,0] [0,Cup,0] f [1,Cup,1] [2,NW,0] s f [1,NW,1]
    [2,Cap,0] s [0,Cap,0]
=> [0,Cup,0] [0,Cap,0] [0,Cup,0] [1,Cup,1] s [2,NW,0] f [2,NE,0] s
    [1,Cap,1] f [0,Cap,0]
=> [0,Cup,0] [0,Cap,0] [0,Cup,0] [1,Cup,1] s s f f [1,Cap,1] [0,Cap,0] =>
[0,Cup,0] [0,Cap,0] [0,Cup,0] [1,Cup,1] f [2,NE,0] s [2,NW,0] f
    [1,Cap,1] s [0,Cap,0]
=> [0,Cup,0] [0,Cap,0] [0,Cup,0] s [1,Cup,1] [2,NE,0] s f [1,NE,1]
    [2,Cap,0] f [0,Cap,0]
=> [0,Cup,0] [0,Cap,0] [0,Cup,0] f [2,Cup,0] s [1,NW,1] f [1,NE,1] s
    [2,Cap,0] [0,Cap,0]
=> [0,Cup,0] [0,Cap,0] s [0,Cup,0] [2,Cup,0] s f f [2,Cap,0] [0,Cap,0] =>
[0,Cup,0] [0,Cap,0] f [0,Cup,0] s [0,Cup,2] f [2,Cap,0] s [0,Cap,0] =>
[0,Cup,0] s [0,Cap,0] [0,Cup,0] s f [0,Cap,0] [0,Cup,0] f [0,Cap,0] =>
[0,Cup,0] f [2,Cup,0] s [0,Cap,2] f [0,Cap,0] s [0,Cup,0] [0,Cap,0] =>
[0,Cup,0] [2,Cup,0] s s f [2,Cap,0] [0,Cap,0] f [0,Cup,0] [0,Cap,0] =>
[0,Cup,0] s [2,Cup,0] f [1,NW,1] s [1,NE,1] f [2,Cap,0] [0,Cap,0]
    [0,Cup,0] [0,Cap,0]
=> [0,Cup,0] f [1,Cup,1] [2,NE,0] s f [1,NE,1] [2,Cap,0] s [0,Cap,0]
    [0,Cup,0] [0,Cap,0]
=> [0,Cup,0] [1,Cup,1] s [2,NE,0] f [2,NW,0] s [1,Cap,1] f [0,Cap,0]
    [0,Cup,0] [0,Cap,0]
=> [0,Cup,0] [1,Cup,1] s s f f [1,Cap,1] [0,Cap,0] [0,Cup,0] [0,Cap,0] =>
[0,Cup,0] [1,Cup,1] f [2,NW,0] s [2,NE,0] f [1,Cap,1] s [0,Cap,0]

```

```

[0, Cup, 0] [0, Cap, 0]
=> [0, Cup, 0] s [1, Cup, 1] [2, NW, 0] sf [1, NW, 1] [2, Cap, 0] f [0, Cap, 0]
[0, Cup, 0] [0, Cap, 0]
=> [0, Cup, 0] f [2, Cup, 0] s [1, NE, 1] f [1, NW, 1] s [2, Cap, 0] [0, Cap, 0]
[0, Cup, 0] [0, Cap, 0]
=> s [0, Cup, 0] [2, Cup, 0] sff [2, Cap, 0] [0, Cap, 0] [0, Cup, 0] [0, Cap, 0] =>
f [0, Cup, 0] s [0, Cup, 2] f [2, Cap, 0] s [0, Cap, 0] [0, Cup, 0] [0, Cap, 0] =>
[0, Cup, 0] sf [0, Cap, 0] [0, Cup, 0] sf [0, Cap, 0] [0, Cup, 0] [0, Cap, 0] =>
[0, Cup, 0] ff [0, Cap, 0] s [0, Cup, 0] [0, Cap, 0] s => s [0, Cup, 0] [0, Cap, 0] sff
=> ff #

```

with amplitudes:

Amplitudes for ($\mathcal{U} = \{31\}$):

$$\begin{aligned}
\langle \text{KnottedSphereA} \rangle_0 &= -q^{-8} - q^{-6} - 3q^{-4} - q^{-2} - 4 - q^2 - 3q^4 - q^6 - q^8 \\
\langle \text{KnottedSphereA} \rangle_1 &= -q^{-8} - q^{-6} - 3q^{-4} - q^{-2} - 4 - q^2 - 3q^4 - q^6 - q^8 \\
\langle \text{KnottedSphereA} \rangle_2 &= -q^{-8} - 2q^{-6} - 4q^{-4} - 4q^{-2} - 6 - 4q^2 - 4q^4 - 2q^6 - q^8 \\
\langle \text{KnottedSphereA} \rangle_3 &= q^{-6} + q^{-4} + 3q^{-2} + 3 + 3q^2 + q^4 + q^6 \\
\langle \text{KnottedSphereA} \rangle_4 &= -q^{-8} - q^{-6} - 4q^{-4} - 3q^{-2} - 5 - 3q^2 - 4q^4 - q^6 - q^8
\end{aligned}$$

Amplitudes for ($\mathcal{U} = \emptyset$):

$$\begin{aligned}
\langle \text{KnottedSphereA} \rangle_a &= 1 \\
\langle \text{KnottedSphereA} \rangle_b &= 1
\end{aligned}$$

4.4 Example: Another knotted sphere

The next 2-knot is a knotted sphere from (Colin C. Adams, The Knot Book, Fig.10.13):

```

% KnottedSphereB
ss => f [0, Cup, 0] ss [0, Cap, 0] f =>
[0, Cup, 0] f [0, Cup, 2] ss [0, Cap, 2] f [0, Cap, 0] =>
[0, Cup, 0] [0, Cup, 2] f [1, NE, 1] ss [1, NW, 1] f [0, Cap, 2] [0, Cap, 0] =>
[0, Cup, 0] [0, Cup, 2] [1, NE, 1] f [0, NW, 2] ss [0, NE, 2] f [1, NW, 1]
[0, Cap, 2] [0, Cap, 0]
=> [0, Cup, 0] [0, Cup, 2] [1, NE, 1] [0, NW, 2] f [2, NW, 0] ss [2, NE, 0] f
[0, NE, 2] [1, NW, 1] [0, Cap, 2] [0, Cap, 0]
=> [0, Cup, 0] [0, Cup, 2] [1, NE, 1] [0, NW, 2] [2, NW, 0] f [2, Cup, 2]
[1, Cap, 3] sff [2, NE, 0] [0, NE, 2] [1, NW, 1] [0, Cap, 2] [0, Cap, 0]
=> [0, Cup, 0] [0, Cup, 2] [1, NE, 1] [0, NW, 2] [2, NW, 0] [2, Cup, 2] [1, Cap, 3]

```

$ssf [1, \text{Cup}, 3] [2, \text{Cap}, 2] f [2, \text{NE}, 0] [0, \text{NE}, 2] [1, \text{NW}, 1] [0, \text{Cap}, 2] [0, \text{Cap}, 0]$
 $\Rightarrow [0, \text{Cup}, 0] [0, \text{Cup}, 2] [1, \text{NE}, 1] [0, \text{NW}, 2] [2, \text{NW}, 0] [2, \text{Cup}, 2]$
 $s [1, \text{Cap}, 3] f [1, \text{Cap}, 1] s [1, \text{Cup}, 1] f [1, \text{Cup}, 3] [2, \text{Cap}, 2]$
 $[2, \text{NE}, 0] [0, \text{NE}, 2] [1, \text{NW}, 1] [0, \text{Cap}, 2] [0, \text{Cap}, 0]$
 $\Rightarrow [0, \text{Cup}, 0] [0, \text{Cup}, 2] [1, \text{NE}, 1] [0, \text{NW}, 2] [2, \text{NW}, 0] s [2, \text{Cup}, 2] f$
 $[3, \text{Cap}, 1] s [1, \text{Cap}, 1] f [1, \text{Cup}, 1] [1, \text{Cup}, 3] [2, \text{Cap}, 2] [2, \text{NE}, 0]$
 $[0, \text{NE}, 2] [1, \text{NW}, 1] [0, \text{Cap}, 2] [0, \text{Cap}, 0]$
 $\Rightarrow [0, \text{Cup}, 0] [0, \text{Cup}, 2] [1, \text{NE}, 1] [0, \text{NW}, 2] [2, \text{NW}, 0] ff [1, \text{Cap}, 1]$
 $s [1, \text{Cup}, 1] [1, \text{Cup}, 3] s [2, \text{Cap}, 2] [2, \text{NE}, 0] [0, \text{NE}, 2] [1, \text{NW}, 1]$
 $[0, \text{Cap}, 2] [0, \text{Cap}, 0]$
 $\Rightarrow [0, \text{Cup}, 0] [0, \text{Cup}, 2] [1, \text{NE}, 1] [0, \text{NW}, 2] [2, \text{NW}, 0] [1, \text{Cap}, 1]$
 $f [1, \text{Cup}, 1] s [3, \text{Cup}, 1] f [2, \text{Cap}, 2] s [2, \text{NE}, 0] [0, \text{NE}, 2] [1, \text{NW}, 1]$
 $[0, \text{Cap}, 2] [0, \text{Cap}, 0]$
 $\Rightarrow [0, \text{Cup}, 0] [0, \text{Cup}, 2] [1, \text{NE}, 1] [0, \text{NW}, 2] [2, \text{NW}, 0] s [1, \text{Cap}, 1] [1, \text{Cup}, 1] s$
 $ff [2, \text{NE}, 0] [0, \text{NE}, 2] [1, \text{NW}, 1] [0, \text{Cap}, 2] [0, \text{Cap}, 0]$
 $\Rightarrow [0, \text{Cup}, 0] [0, \text{Cup}, 2] [1, \text{NE}, 1] [0, \text{NW}, 2] s [2, \text{NW}, 0] ff [2, \text{NE}, 0] s$
 $[0, \text{NE}, 2] [1, \text{NW}, 1] [0, \text{Cap}, 2] [0, \text{Cap}, 0]$
 $\Rightarrow [0, \text{Cup}, 0] [0, \text{Cup}, 2] [1, \text{NE}, 1] s [0, \text{NW}, 2] ff [0, \text{NE}, 2] s [1, \text{NW}, 1]$
 $[0, \text{Cap}, 2] [0, \text{Cap}, 0]$
 $\Rightarrow [0, \text{Cup}, 0] [0, \text{Cup}, 2] s [1, \text{NE}, 1] ff [1, \text{NW}, 1] s [0, \text{Cap}, 2] [0, \text{Cap}, 0] \Rightarrow$
 $[0, \text{Cup}, 0] s [0, \text{Cup}, 2] ff [0, \text{Cap}, 2] s [0, \text{Cap}, 0] \Rightarrow s [0, \text{Cup}, 0] ff [0, \text{Cap}, 0] s$
 $\Rightarrow ff \#$

with amplitudes:

Amplitudes for $(\mathcal{U} = \{31\})$:

$$\begin{aligned}
\langle \text{KnottedSphereB} \rangle_0 &= 2q^{-16} - q^{-14} + 2q^{-12} - 2q^{-6} - 2q^{-4} - 2q^{-2} - 4 \\
&\quad - 2q^2 - 2q^4 - 2q^6 + 2q^{12} - q^{14} + 2q^{16} \\
\langle \text{KnottedSphereB} \rangle_1 &= 2q^{-16} - q^{-14} + 2q^{-12} - 2q^{-6} - 2q^{-4} - 2q^{-2} - 4 \\
&\quad - 2q^2 - 2q^4 - 2q^6 + 2q^{12} - q^{14} + 2q^{16} \\
\langle \text{KnottedSphereB} \rangle_2 &= 2q^{-16} + q^{-14} + 2q^{-12} - 2q^{-6} - 4q^{-4} - 6q^{-2} - 8 \\
&\quad - 6q^2 - 4q^4 - 2q^6 + 2q^{12} + q^{14} + 2q^{16} \\
\langle \text{KnottedSphereB} \rangle_3 &= -2q^{-14} + 2q^{-4} + 4q^{-2} + 5 + 4q^2 + 2q^4 - 2q^{14} \\
\langle \text{KnottedSphereB} \rangle_4 &= 2q^{-16} + 2q^{-12} - 2q^{-6} - 4q^{-4} - 6q^{-2} - 7 \\
&\quad - 6q^2 - 4q^4 - 2q^6 + 2q^{12} + 2q^{16}
\end{aligned}$$

Amplitudes for $(\mathcal{U} = \emptyset)$:

$$\begin{aligned}
\langle \text{KnottedSphereB} \rangle_a &= 1 \\
\langle \text{KnottedSphereB} \rangle_b &= 1
\end{aligned}$$

4.5 Example: Klein Bottle

The next 2-knot is a Klein bottle

```
% Klein bottle
ss => f [0,Cup,0] ss [0,Cap,0] f =>
[0,Cup,0] ssf [0,Cup,2] [1,Cap,1] f [0,Cap,0] =>
[0,Cup,0] f [1,Cup,1] s [0,Cap,2] f [0,Cup,2] s [1,Cap,1] [0,Cap,0] =>
[0,Cup,0] [1,Cup,1] sfsf [1,Cap,1] [0,Cap,0] =>
[0,Cup,0] s [1,Cup,1] f [2,NE,0] s [2,NW,0] f [1,Cap,1] [0,Cap,0] =>
[0,Cup,0] f [2,Cup,0] [1,NW,1] fs [2,NW,0] [1,Cap,1] s [0,Cap,0] =>
[0,Cup,0] [2,Cup,0] s [1,NW,1] f [1,NE,1] s [2,Cap,0] f [0,Cap,0] =>
[0,Cup,0] [2,Cup,0] sfsf [2,Cap,0] [0,Cap,0] =>
[0,Cup,0] s [2,Cup,0] f [1,Cap,1] s [1,Cup,1] f [2,Cap,0] [0,Cap,0] =>
[0,Cup,0] ffs [1,Cup,1] [2,Cap,0] s [0,Cap,0] => s [0,Cup,0] ff [0,Cap,0] s
=> ff #
```

with amplitudes:

Amplitudes for ($\mathcal{U} = \{31\}$):

$$\begin{aligned} \langle \text{KleinBottle} \rangle_0 &= q^{-4} + 2 + q^4 \\ \langle \text{KleinBottle} \rangle_1 &= q^{-4} + 2 + q^4 \\ \langle \text{KleinBottle} \rangle_2 &= q^{-4} + 2 + q^4 \\ \langle \text{KleinBottle} \rangle_3 &= 1 \\ \langle \text{KleinBottle} \rangle_4 &= 1 \end{aligned}$$

Amplitudes for ($\mathcal{U} = \emptyset$):

$$\begin{aligned} \langle \text{KleinBottle} \rangle_a &= 1 \\ \langle \text{KleinBottle} \rangle_b &= 1 \end{aligned}$$

4.6 Example: Simple Torus

The next 2-knot is a simple (unknotted) torus

```
% SimpleTorus
ss => f [0,Cup,0] ss [0,Cap,0] f =>
[0,Cup,0] fs [0,Cap,0] [0,Cup,0] fs [0,Cap,0] => s [0,Cup,0] ff [0,Cap,0] s
=> ff #
```

with amplitudes:

Amplitudes for ($\mathcal{U} = \{31\}$):

$$\begin{aligned}
\langle \text{SimpleTorus} \rangle_0 &= q^{-4} + 2 + q^4 \\
\langle \text{SimpleTorus} \rangle_1 &= q^{-4} + 2 + q^4 \\
\langle \text{SimpleTorus} \rangle_2 &= q^{-4} + 2 + q^4 \\
\langle \text{SimpleTorus} \rangle_3 &= 1 \\
\langle \text{SimpleTorus} \rangle_4 &= 1
\end{aligned}$$

Amplitudes for ($\mathcal{U} = \emptyset$):

$$\begin{aligned}
\langle \text{SimpleTorus} \rangle_a &= 1 \\
\langle \text{SimpleTorus} \rangle_b &= 1
\end{aligned}$$

4.7 Example: 1-Twist Spun Trefoil

The next knot is a spun trefoil from [CS2]

```

% 1-twist spun trefoil: C&S p. 36
ss => f[0,Cup,0]ss[0,Cap,0]f =>
[0,Cup,0]f[0,Cup,2]ss[0,Cap,2]f[0,Cap,0] =>
[0,Cup,0][0,Cup,2]f[1,NE,1]ss[1,NW,1]f[0,Cap,2][0,Cap,0] =>
[0,Cup,0][0,Cup,2][1,NE,1]f[1,NE,1]ss[1,NW,1]f[1,NW,1];
[0,Cap,2][0,Cap,0]
=> [0,Cup,0][0,Cup,2][1,NE,1][1,NE,1]f[1,NE,1]ss[1,NW,1]f
[1,NW,1][1,NW,1][0,Cap,2][0,Cap,0]
=> [0,Cup,0][0,Cup,2][1,NE,1][1,NE,1][1,NE,1]f[2,Cap,0]s
[2,Cup,0]f[1,NW,1]s[1,NW,1][1,NW,1][0,Cap,2][0,Cap,0]
=> [0,Cup,0][0,Cup,2][1,NE,1][1,NE,1][1,NE,1][2,Cap,0]sf
[1,Cup,1]s[2,NE,0]f[1,NW,1][1,NW,1][0,Cap,2][0,Cap,0]
=> [0,Cup,0][0,Cup,2][1,NE,1][1,NE,1][1,NE,1][2,Cap,0]f
[1,Cup,1]s[1,NE,1]f[2,NE,0][1,NW,1]s[1,NW,1];
[0,Cap,2][0,Cap,0]
=> [0,Cup,0][0,Cup,2][1,NE,1][1,NE,1][1,NE,1][2,Cap,0];
[1,Cup,1]f[2,NW,0][1,NE,1][2,NE,0]f[1,NW,1]s
[0,Cap,2][0,Cap,0]s
=> [0,Cup,0][0,Cup,2][1,NE,1][1,NE,1][1,NE,1][2,Cap,0];
[1,Cup,1][2,NW,0]s[1,NE,1][2,NE,0][1,NW,1]sf
[2,Cap,0][0,Cap,0]f
=> [0,Cup,0][0,Cup,2][1,NE,1][1,NE,1][1,NE,1][2,Cap,0]s
[1,Cup,1][2,NW,0]sf[2,NW,0][1,NE,1][2,NE,0]f

```

```

[2,Cap,0][0,Cap,0]
=> [0,Cup,0][0,Cup,2][1,NE,1][1,NE,1][1,NE,1][2,Cap,0]f
[2,Cup,0][1,NE,1]f[2,NW,0][1,NE,1]s[2,NE,0];
[2,Cap,0]s[0,Cap,0]
=> [0,Cup,0][0,Cup,2][1,NE,1][1,NE,1][1,NE,1][2,Cap,0]s
[2,Cup,0]s[1,NE,1][2,NW,0][1,NE,1]f[2,Cap,0]f[0,Cap,0]
=> [0,Cup,0][0,Cup,2][1,NE,1][1,NE,1][1,NE,1][2,Cap,0]f
[2,Cup,0]s[2,NE,0]f[1,NE,1][2,NW,0]s[1,NE,1];
[2,Cap,0][0,Cap,0]
=> [0,Cup,0][0,Cup,2][1,NE,1][1,NE,1][1,NE,1][2,Cap,0];
[2,Cup,0]f[1,NW,1][2,NE,0][1,NE,1]sf[1,NE,1];
[2,Cap,0]s[0,Cap,0]
=> [0,Cup,0][0,Cup,2][1,NE,1][1,NE,1][1,NE,1][2,Cap,0];
[2,Cup,0][1,NW,1]s[2,NE,0][1,NE,1]f[2,NW,0]s
[1,Cap,1]f[0,Cap,0]
=> [0,Cup,0][0,Cup,2][1,NE,1][1,NE,1][1,NE,1][2,Cap,0];
[2,Cup,0][1,NW,1]f[1,NW,1][2,NE,0]s[1,NE,1]f
[1,Cap,1]s[0,Cap,0]
=> [0,Cup,0][0,Cup,2][1,NE,1][1,NE,1][1,NE,1][2,Cap,0];
[2,Cup,0][1,NW,1][1,NW,1]s[2,NE,0]f[1,Cap,1]sf[0,Cap,0]
=> [0,Cup,0][0,Cup,2][1,NE,1][1,NE,1][1,NE,1][2,Cap,0];
[2,Cup,0][1,NW,1][1,NW,1]f[1,NW,1]s[2,Cap,0]f[0,Cap,0]f
=> [0,Cup,0][0,Cup,2][1,NE,1][1,NE,1][1,NE,1]s[2,Cap,0];
[2,Cup,0]s[1,NW,1][1,NW,1][1,NW,1]f[0,Cap,2][0,Cap,0]f
=> [0,Cup,0][0,Cup,2][1,NE,1][1,NE,1]s[1,NE,1]ff[1,NW,1]s
[1,NW,1][1,NW,1][0,Cap,2][0,Cap,0]
=> [0,Cup,0][0,Cup,2][1,NE,1]s[1,NE,1]ff[1,NW,1]s[1,NW,1];
[0,Cap,2][0,Cap,0]
=> [0,Cup,0][0,Cup,2]s[1,NE,1]ff[1,NW,1]s[0,Cap,2][0,Cap,0] =>
[0,Cup,0]s[0,Cup,2]ff[0,Cap,2]s[0,Cap,0] => s[0,Cup,0]ff[0,Cap,0]s
=> ff #

```

with amplitudes:

Amplitudes for ($\mathcal{U} = \{31\}$):

$$\langle 1\text{-TwistSpunTrefoil} \rangle_0 = q^{-14} + q^{14}$$

$$\langle 1\text{-TwistSpunTrefoil} \rangle_1 = q^{-14} + q^{14}$$

$$\langle 1\text{-TwistSpunTrefoil} \rangle_2 = q^{-14} + q^{14}$$

$$\langle 1\text{-TwistSpunTrefoil} \rangle_3 = 1$$

$$\langle 1\text{-TwistSpunTrefoil} \rangle_4 = 1$$

Amplitudes for ($\mathcal{U} = \emptyset$):

$$\begin{aligned}\langle 1\text{-TwistSpunTrefoil} \rangle_a &= 1 \\ \langle 1\text{-TwistSpunTrefoil} \rangle_b &= 1\end{aligned}$$

4.8 Example: 2-twist spun trefoil

The next knot is another spun trefoil from [CS2]

```
% 2-twist spun trefoil: C&S p. 36
ss => f [0,Cup,0] ss [0,Cap,0] f =>
[0,Cup,0] f [0,Cup,2] ss [0,Cap,2] f [0,Cap,0] =>
[0,Cup,0] [0,Cup,2] f [1,NE,1] ss [1,NW,1] f [0,Cap,2] [0,Cap,0] =>
[0,Cup,0] [0,Cup,2] [1,NE,1] f [1,NE,1] ss [1,NW,1] f [1,NW,1] ;
  [0,Cap,2] [0,Cap,0]
=> [0,Cup,0] [0,Cup,2] [1,NE,1] [1,NE,1] f [1,NE,1] ss [1,NW,1] f
  [1,NW,1] [1,NW,1] [0,Cap,2] [0,Cap,0]
=> [0,Cup,0] [0,Cup,2] [1,NE,1] [1,NE,1] [1,NE,1] f [2,Cap,0] s
  [2,Cup,0] f [1,NW,1] s [1,NW,1] [1,NW,1] [0,Cap,2] [0,Cap,0]
=> [0,Cup,0] [0,Cup,2] [1,NE,1] [1,NE,1] [1,NE,1] [2,Cap,0] sf
  [1,Cup,1] s [2,NE,0] f [1,NW,1] [1,NW,1] [0,Cap,2] [0,Cap,0]
=> [0,Cup,0] [0,Cup,2] [1,NE,1] [1,NE,1] [1,NE,1] [2,Cap,0] f
  [1,Cup,1] s [1,NE,1] f [2,NE,0] [1,NW,1] s [1,NW,1] ;
  [0,Cap,2] [0,Cap,0]
=> [0,Cup,0] [0,Cup,2] [1,NE,1] [1,NE,1] [1,NE,1] [2,Cap,0] ;
  [1,Cup,1] f [2,NW,0] [1,NE,1] [2,NE,0] f [1,NW,1] s
  [0,Cap,2] [0,Cap,0] s
=> [0,Cup,0] [0,Cup,2] [1,NE,1] [1,NE,1] [1,NE,1] [2,Cap,0] ;
  [1,Cup,1] [2,NW,0] s [1,NE,1] [2,NE,0] [1,NW,1] sf
  [2,Cap,0] [0,Cap,0] f
=> [0,Cup,0] [0,Cup,2] [1,NE,1] [1,NE,1] [1,NE,1] [2,Cap,0] s
  [1,Cup,1] [2,NW,0] sf [2,NW,0] [1,NE,1] [2,NE,0] f
  [2,Cap,0] [0,Cap,0]
=> [0,Cup,0] [0,Cup,2] [1,NE,1] [1,NE,1] [1,NE,1] [2,Cap,0] f
  [2,Cup,0] [1,NE,1] f [2,NW,0] [1,NE,1] s [2,NE,0] ;
  [2,Cap,0] s [0,Cap,0]
=> [0,Cup,0] [0,Cup,2] [1,NE,1] [1,NE,1] [1,NE,1] [2,Cap,0] s
  [2,Cup,0] s [1,NE,1] [2,NW,0] [1,NE,1] f [2,Cap,0] f [0,Cap,0]
=> [0,Cup,0] [0,Cup,2] [1,NE,1] [1,NE,1] [1,NE,1] [2,Cap,0] f
  [2,Cup,0] s [2,NE,0] f [1,NE,1] [2,NW,0] s [1,NE,1] ;
  [2,Cap,0] [0,Cap,0]
```



```

=> [0,Cup,0] [0,Cup,2] [1,NE,1] [1,NE,1] [1,NE,1] [2,Cap,0] ;
    [2,Cup,0] f [1,NW,1] [2,NE,0] [1,NE,1] sf [1,NE,1] ;
    [2,Cap,0] s [0,Cap,0]
=> [0,Cup,0] [0,Cup,2] [1,NE,1] [1,NE,1] [1,NE,1] [2,Cap,0] ;
    [2,Cup,0] [1,NW,1] s [2,NE,0] [1,NE,1] f [2,NW,0] s
    [1,Cap,1] f [0,Cap,0]
=> [0,Cup,0] [0,Cup,2] [1,NE,1] [1,NE,1] [1,NE,1] [2,Cap,0] ;
    [2,Cup,0] [1,NW,1] f [1,NW,1] [2,NE,0] s [1,NE,1] f
    [1,Cap,1] s [0,Cap,0]
=> [0,Cup,0] [0,Cup,2] [1,NE,1] [1,NE,1] [1,NE,1] [2,Cap,0] ;
    [2,Cup,0] [1,NW,1] [1,NW,1] s [2,NE,0] f
    [1,Cap,1] sf [0,Cap,0]
=> [0,Cup,0] [0,Cup,2] [1,NE,1] [1,NE,1] [1,NE,1] [2,Cap,0] ;
    [2,Cup,0] [1,NW,1] [1,NW,1] f [1,NW,1] s
    [2,Cap,0] f [0,Cap,0] s
=> [0,Cup,0] [0,Cup,2] [1,NE,1] [1,NE,1] [1,NE,1] [2,Cap,0] s
    [2,Cup,0] [1,NW,1] s [1,NW,1] [1,NW,1] f [0,Cap,2] [0,Cap,0] f
=> [0,Cup,0] [0,Cup,2] [1,NE,1] [1,NE,1] [1,NE,1] [2,Cap,0] sf
    [1,Cup,1] s [2,NE,0] f [1,NW,1] [1,NW,1] [0,Cap,2] [0,Cap,0]
=> [0,Cup,0] [0,Cup,2] [1,NE,1] [1,NE,1] [1,NE,1] [2,Cap,0] f
    [1,Cup,1] s [1,NE,1] f [2,NE,0] [1,NW,1] s [1,NW,1] ;
    [0,Cap,2] [0,Cap,0]
=> [0,Cup,0] [0,Cup,2] [1,NE,1] [1,NE,1] [1,NE,1] [2,Cap,0] ;
    [1,Cup,1] f [2,NW,0] [1,NE,1] [2,NE,0] f [1,NW,1] s
    [0,Cap,2] [0,Cap,0] s
=> [0,Cup,0] [0,Cup,2] [1,NE,1] [1,NE,1] [1,NE,1] [2,Cap,0] ;
    [1,Cup,1] [2,NW,0] s [1,NE,1] [2,NE,0] [1,NW,1] sf
    [2,Cap,0] [0,Cap,0] f
=> [0,Cup,0] [0,Cup,2] [1,NE,1] [1,NE,1] [1,NE,1] [2,Cap,0] s
    [1,Cup,1] [2,NW,0] sf [2,NW,0] [1,NE,1] [2,NE,0] f
    [2,Cap,0] [0,Cap,0]
=> [0,Cup,0] [0,Cup,2] [1,NE,1] [1,NE,1] [1,NE,1] [2,Cap,0] f
    [2,Cup,0] [1,NE,1] f [2,NW,0] [1,NE,1] s [2,NE,0] ;
    [2,Cap,0] s [0,Cap,0]
=> [0,Cup,0] [0,Cup,2] [1,NE,1] [1,NE,1] [1,NE,1] [2,Cap,0] s
    [2,Cup,0] s [1,NE,1] [2,NW,0] [1,NE,1] f [2,Cap,0] f [0,Cap,0]
=> [0,Cup,0] [0,Cup,2] [1,NE,1] [1,NE,1] [1,NE,1] [2,Cap,0] f
    [2,Cup,0] s [2,NE,0] f [1,NE,1] [2,NW,0] s [1,NE,1] ;
    [2,Cap,0] [0,Cap,0]
=> [0,Cup,0] [0,Cup,2] [1,NE,1] [1,NE,1] [1,NE,1] [2,Cap,0] ;

```

$[2, \text{Cup}, 0] f [1, \text{NW}, 1] [2, \text{NE}, 0] [1, \text{NE}, 1] s f [1, \text{NE}, 1] ;$
 $[2, \text{Cap}, 0] s [0, \text{Cap}, 0]$
 $\Rightarrow [0, \text{Cup}, 0] [0, \text{Cup}, 2] [1, \text{NE}, 1] [1, \text{NE}, 1] [1, \text{NE}, 1] [2, \text{Cap}, 0] ;$
 $[2, \text{Cup}, 0] [1, \text{NW}, 1] s [2, \text{NE}, 0] [1, \text{NE}, 1] f [2, \text{NW}, 0] s$
 $[1, \text{Cap}, 1] f [0, \text{Cap}, 0]$
 $\Rightarrow [0, \text{Cup}, 0] [0, \text{Cup}, 2] [1, \text{NE}, 1] [1, \text{NE}, 1] [1, \text{NE}, 1] [2, \text{Cap}, 0] ;$
 $[2, \text{Cup}, 0] [1, \text{NW}, 1] f [1, \text{NW}, 1] [2, \text{NE}, 0] s [1, \text{NE}, 1] f$
 $[1, \text{Cap}, 1] s [0, \text{Cap}, 0]$
 $\Rightarrow [0, \text{Cup}, 0] [0, \text{Cup}, 2] [1, \text{NE}, 1] [1, \text{NE}, 1] [1, \text{NE}, 1] [2, \text{Cap}, 0] ;$
 $[2, \text{Cup}, 0] [1, \text{NW}, 1] [1, \text{NW}, 1] s [2, \text{NE}, 0] f [1, \text{Cap}, 1] s f [0, \text{Cap}, 0]$
 $\Rightarrow [0, \text{Cup}, 0] [0, \text{Cup}, 2] [1, \text{NE}, 1] [1, \text{NE}, 1] [1, \text{NE}, 1] [2, \text{Cap}, 0] ;$
 $[2, \text{Cup}, 0] [1, \text{NW}, 1] [1, \text{NW}, 1] f [1, \text{NW}, 1] s [2, \text{Cap}, 0] f [0, \text{Cap}, 0] s$
 $\Rightarrow [0, \text{Cup}, 0] [0, \text{Cup}, 2] [1, \text{NE}, 1] [1, \text{NE}, 1] [1, \text{NE}, 1] s [2, \text{Cap}, 0] ;$
 $[2, \text{Cup}, 0] s [1, \text{NW}, 1] [1, \text{NW}, 1] [1, \text{NW}, 1] f [0, \text{Cap}, 2] [0, \text{Cap}, 0] f$
 $\Rightarrow [0, \text{Cup}, 0] [0, \text{Cup}, 2] [1, \text{NE}, 1] [1, \text{NE}, 1] s [1, \text{NE}, 1] f f [1, \text{NW}, 1] s$
 $[1, \text{NW}, 1] [1, \text{NW}, 1] [0, \text{Cap}, 2] [0, \text{Cap}, 0]$
 $\Rightarrow [0, \text{Cup}, 0] [0, \text{Cup}, 2] [1, \text{NE}, 1] s [1, \text{NE}, 1] f f [1, \text{NW}, 1] s [1, \text{NW}, 1] ;$
 $[0, \text{Cap}, 2] [0, \text{Cap}, 0]$
 $\Rightarrow [0, \text{Cup}, 0] [0, \text{Cup}, 2] s [1, \text{NE}, 1] f f [1, \text{NW}, 1] s [0, \text{Cap}, 2] [0, \text{Cap}, 0] \Rightarrow$
 $[0, \text{Cup}, 0] s [0, \text{Cup}, 2] f f [0, \text{Cap}, 2] s [0, \text{Cap}, 0] \Rightarrow s [0, \text{Cup}, 0] f f [0, \text{Cap}, 0] s$
 $\Rightarrow f f \#$

with amplitudes:

Amplitudes for $(\mathcal{U} = \{31\})$:

$$\begin{aligned}
\langle 2\text{-TwistSpunTrefoil} \rangle_0 &= q^{-14} + q^{14} \\
\langle 2\text{-TwistSpunTrefoil} \rangle_1 &= q^{-14} + q^{14} \\
\langle 2\text{-TwistSpunTrefoil} \rangle_2 &= q^{-14} + q^{14} \\
\langle 2\text{-TwistSpunTrefoil} \rangle_3 &= 1 \\
\langle 2\text{-TwistSpunTrefoil} \rangle_4 &= 1
\end{aligned}$$

Amplitudes for $(\mathcal{U} = \emptyset)$:

$$\begin{aligned}
\langle 2\text{-TwistSpunTrefoil} \rangle_a &= 1 \\
\langle 2\text{-TwistSpunTrefoil} \rangle_b &= 1
\end{aligned}$$

References

- [BL] J.C.Baez and L.Langford, *Higher-dimensional Algebra IV: 2-Tangles*, Adv.Math., **180** (2003), 705-764.

- [BN] J.Baez and M.Neuchl, *Higher-dimensional Algebra I: Braided Monoidal 2-Categories*, Adv.Math., **121**(1996), 196-244
- [CFS] J.S.Carter, D.E.Flath and M.Saito, *The Classical and Quantum 6j - symbols*, Mathematical Series **43**, Princeton University Press, Princeton, New Jersey, 1995
- [CRS] J.S.Carter, J.H.Rieger and M.Saito, *A Combinatorial Description of Knotted Surfaces and Their Isotopies*, Adv.Math., **127**, (1997), 1-51.
- [CS1] J.S.Carter and M.Saito, *A Diagrammatic Theory of Knotted Surfaces*, Quantum Topology, 91-115, Ser.Knots Everything, **3**, World Sci.Publishing, River Edge, N.J., 1993
- [CS2] J.S.Carter and M.Saito, *Knotted Surfaces and Their Diagrams*, Math. Surveys and Monographs, **Volume 55** American Mathematical Society, Providence, 1998
- [F] J.Fischer, *2-categories and 2-knots*, Duke Math. J. , **75**, (1994), 493-526.
- [FR] R.Fenn and C.Rourke, *Racks and Links in Codimension 2*, J. of Knot Theory and its Ramifications, **Vol.1 No.4** (1992) 343-406
- [FY] P.Freyd and D.Yetter, *Braided Compact Monoidal Categories with Applications to Low-Dimensional Topology*, Adv.Math., **77**, (1989), 156-182
- [J] V.F.R.Jones, *A polynomial invariant for knots and links via von Neumann algebras*, Bull.AMS **12** (1985) 103-111
- [K] L.H.Kauffman, *Knots and Physics (Second Edition)*, World Scientific (Singapore-New Jersey-London-Hong Kong),1993
- [Ka] S. Kamada, *Braid and Knot Theory in Dimension Four*, Math. Surveys and Monographs, **Volume 95** American Mathematical Society, Providence, R.I., 2002
- [KT] V.Kharlamov and V.Turaev, *On the Definition of the 2-Category of 2-Knots*, Mathematics in Saint Petersburg, 205-221, Amer. Math. Soc. Transl. Ser.2, **174** Amer. Math. Soc., Providence, RI, 1996
- [KV] M.Kapranov and V.Voevodsky, *2-Categories and Zamolodchikov Tetrahedra Equations*, in *Proc. Symp. Pure Math.* **56**(1994) Part2, AMS, Providence, pp.177-260

- [KV2] M.Kapranov and V.Voevodsky, *Braided monoidal 2-categories and Manin-Schechtman higher braid groups*, J.Pure and Applied Algebra, **92** (1994) 241-267
- [Kassel] C.Kassel, *Quantum Groups*, Graduate Texts in Mathematics, **155** Springer-Verlag, New York etc., 1995
- [LL] L.Langford, *2-Tangles as a Free Braided Monoidal 2-Category with Duals*, Ph.D. dissertation, U.C.Riverside, 1997
- [R] D.Roseman, *Reidemeister-type moves for surfaces in four-dimensional space*, Preprint
- [R2] D.Roseman, *Projections of knots*, Fund.Math. **89** (1975), no.2, 99-110
- [Smith] S.P.Smith, *Introduction to Quantum Groups for Ring Theorists*, Proc. of 1989 MSRI Conference on Non-commutative Noetherian Rings,, Ed. L.W.Small, (1991), pp.131-178
- [W] H.Weyl, *The Theory of Groups and Quantum Mechanics*, (translated from the second revised German edition by H.P.Robertson) Dover Publications Inc., New York, N.Y., 1950