

HEEGAARD SURFACES AND MEASURED LAMINATIONS, II: NON-HAKEN 3-MANIFOLDS

TAO LI

ABSTRACT. A famous example of Casson and Gordon shows that a Haken 3-manifold can have an infinite family of irreducible Heegaard splittings with different genera. In this paper, we prove that a closed non-Haken 3-manifold has only finitely many irreducible Heegaard splittings, up to isotopy. This is much stronger than the Waldhausen conjecture. Another immediate corollary is that for any irreducible non-Haken 3-manifold M , there is a number N , such that any two Heegaard splittings of M are equivalent after at most N stabilizations.

CONTENTS

1. Introduction	1
2. Heegaard surfaces and branched surfaces	3
3. Measured laminations	7
4. Limits of compact surfaces	10
5. Helix-turn-helix bands	17
6. Proof of the main theorem	24
7. The Casson-Gordon example	35
References	37

1. INTRODUCTION

A Heegaard splitting of a closed orientable 3-manifold is said to be reducible if there is an essential closed curve in the Heegaard surface bounding disks in both handlebodies. Haken proved that a Heegaard splitting of a reducible 3-manifold is always reducible [9].

The classification of irreducible Heegaard splittings has been a long-standing fundamental problem in 3-manifold topology. Such classification has been achieved for certain non-hyperbolic manifolds, such as S^3 by Waldhausen [33], Lens spaces by Bonahon and Otal [3], and Seifert fiber spaces by [2, 22, 23]. The main theorem of this paper is a finiteness result for non-Haken 3-manifolds.

Theorem 1.1. *A closed orientable non-Haken 3-manifold has only finitely many irreducible Heegaard splittings, up to isotopy.*

Partially supported by an NSF grant.

An important question in the study of Heegaard splittings is whether there are ways to construct different Heegaard splittings. By adding trivial handles, one can always construct an infinite family of Heegaard splittings for every 3-manifold. Theorem 1.1 says that, for irreducible non-Haken manifolds, adding trivial handles is virtually the only way of obtaining new Heegaard splittings.

The study of Heegaard splitting has been dramatically changed since Casson and Gordon introduced the notion of strongly irreducible Heegaard splitting [4]. They showed that [4] an irreducible Heegaard splitting of a non-Haken 3-manifold is also strongly irreducible. Using the thin-position argument, Rubinstein established relations between strongly irreducible Heegaard splittings and normal surface theory. The results in [4] have also been used to attack the virtually Haken conjecture [14, 19].

Casson and Gordon found the first 3-manifolds containing infinitely many different irreducible Heegaard splittings, see [5, 31, 13], and Theorem 1.1 says that this can only happen in Haken 3-manifolds. In section 7, we will show the relation between an incompressible surface and the infinite family of strongly irreducible Heegaard splittings in the Casson-Gordon example. This interpretation of the Casson-Gordon example was independently discovered by [24], where the authors proved a special case for the theorem.

The Waldhausen conjecture [34] says that a closed orientable 3-manifold has only finitely many Heegaard splittings of any fixed genus, up to homeomorphism. Johannson [11, 12] proved this conjecture for Haken 3-manifolds. Together with Johannson's theorem, Theorem 1.1 implies the Waldhausen conjecture. In fact, in a previous paper [18], we proved a generalized version of Waldhausen conjecture using similar techniques.

Another important question in the study of Heegaard splittings is how different Heegaard splittings are related. This is the so-called stabilization problem, asking the number of stabilizations required to make two Heegaard splittings equivalent. It has been shown that the number of stabilizations is bounded by a linear function of the genera of the two splittings [28], but it remains unknown whether there is a universal bound. We hope the techniques used in this paper can shed some light on this question. Corollary 1.2 follows from Theorem 1.1 and [28].

Corollary 1.2. *For any closed, orientable, irreducible and non-Haken 3-manifold M , there is a number N such that any two Heegaard splittings are equivalent after at most N stabilizations.*

We briefly describe the main ideas of the proof. The basic idea is similar in spirit to the proof of [16]. By [9, 4, 2, 3, 23], we may assume M is irreducible, atoroidal and not a small Seifert fiber space, and the Heegaard splittings are strongly irreducible. By a theorem in [18], there is a finite collection of branched surfaces in M such that every strongly irreducible Heegaard surface is fully carried by a branched surface in this collection. Moreover, the branched surfaces in this collection have some remarkable

properties, such as they do not carry any normal 2-sphere or normal torus. Each surface carried by a branched surface corresponds to an integer solution to the system of branch equations [6]. One can also define the projective lamination space for a branched surfaces, see [18]. If a branched surface in this collection carries an infinite number of strongly irreducible Heegaard surfaces, then we have an infinite sequence of points in the projective lamination space. By compactness, there must be an accumulation point which corresponds to a measured lamination μ . The main task is to prove that μ is incompressible and hence yields a closed incompressible surface, contradicting the hypothesis that M is non-Haken. The proof utilizes properties of both strongly irreducible Heegaard splittings and measured laminations.

We organize this paper as follows. In section 2, we briefly review some results from [18] and show some relations between branched surfaces and strongly irreducible Heegaard splittings. In sections 3 and 4, we prove some technical lemmas concerning measured laminations. In section 5, we explain a key construction. We finish the proof of Theorem 1.1 in section 6. In section 7, we show how to interpret the limit of the infinite family of strongly irreducible Heegaard surfaces in the Casson-Gordon example.

Acknowledgments. I would like to thank Bus Jaco, Saul Schleimer and Ian Agol for useful conversations. I also thank Cynthia Chen for some technical assistance.

2. HEEGAARD SURFACES AND BRANCHED SURFACES

Notation. Throughout this paper, we will denote the interior of X by $\text{int}(X)$, the closure (under path metric) of X by \overline{X} , and the number of components of X by $|X|$. We will also use $|n|$ to denote the absolute value of n if n is a number. We will use $\eta(X)$ to denote the closure of a regular neighborhood of X . We will also use the same notations on branched surfaces and laminations as in sections 2 and 3 of [18].

Let M be a closed orientable and non-Haken 3-manifold. A theorem of Haken [9] says that a reducible 3-manifold cannot have any irreducible Heegaard splitting. By [2, 3, 22, 23], Theorem 1.1 is true for small Seifert fiber spaces. So, we may assume M is irreducible and not a small Seifert fiber space. Casson and Gordon [4] showed that irreducible Heegaard splittings are equivalent to strongly irreducible Heegaard splittings for non-Haken 3-manifolds. Hence, we assume the Heegaard splittings in this paper are strongly irreducible. We call the Heegaard surface of a strongly irreducible splitting a strongly irreducible Heegaard surface.

By [27, 32], each strongly irreducible Heegaard surface can be isotoped into an almost normal surface with respect to a triangulation. Similar to [6], we can use normal disks and almost normal pieces to construct a finite collection of branched surfaces such that each strongly irreducible Heegaard surface is fully carried by a branched surface in this collection. By a theorem of [18] (Theorem 2.1 below), we can split these branched surfaces into a larger

collection of branched surfaces so that each strongly irreducible Heegaard surface is still fully carried by a branched surface in this collection and no branched surface in this collection carries any normal 2-sphere or normal torus.

Theorem 2.1 (Theorem 1.3 in [18]). *Let M be a closed orientable irreducible and atoroidal 3-manifold, and suppose M is not a Seifert fiber space. Then, M has a finite collection of branched surfaces, such that*

- (1) *each branched surface in this collection is obtained by gluing together normal disks and at most one almost normal piece with respect to a fixed triangulation,*
- (2) *up to isotopy, each strongly irreducible Heegaard surface is fully carried by a branched surface in this collection,*
- (3) *no branched surface in this collection carries any normal 2-sphere or normal torus.*

Our goal is to prove that each branched surface in Theorem 2.1 only carries a finite number of strongly irreducible Heegaard surfaces. We will use various properties of strongly irreducible Heegaard splittings, branched surfaces and measured laminations, and we refer to sections 2 and 3 of [18] for an overview of some results and techniques in these areas. In this section, we prove some easy lemmas which establish some connections between branched surfaces and Heegaard surfaces.

Let B be a branched surface, $N(B)$ be a fibered neighborhood of B , and $\pi : N(B) \rightarrow B$ be the map collapsing each I -fiber of $N(B)$ to a point. We say an annulus $A = S^1 \times I \subset N(B)$ is a *vertical annulus* if every $\{x\} \times I \subset A$ ($x \in S^1$) is a subarc of an I -fiber of $N(B)$. We say a surface Γ is carried by $N(B)$ if $\Gamma \subset N(B)$ is transverse to the I -fibers of $N(B)$.

Proposition 2.2. *Let B be a branched surface and $A \subset N(B)$ be an embedded vertical annulus. Suppose there is an embedded annulus Γ carried by $N(B)$ such that $\partial\Gamma \subset A$ and $\text{int}(\Gamma) \cap A$ is an essential closed curve in Γ . Then, B carries a torus.*

Proof. The idea of the proof is that one can perform some cutting and pasting on A and Γ to get a torus carried by B . The circle $\text{int}(\Gamma) \cap A$ cuts Γ into 2 sub-annuli, say Γ_1 and Γ_2 , with $\text{int}(\Gamma_i) \cap A = \emptyset$ ($i = 1, 2$). Let A_i be the sub-annulus of A bounded by $\partial\Gamma_i$. So, $A_i \cup \Gamma_i$ is an embedded torus. We have two cases here. The first case is that Γ_i connects A from different sides, more precisely, after smoothing out the corners, the torus $A_i \cup \Gamma_i$ is transverse to the I -fibers of $N(B)$, as shown in Figure 2.1 (a). The second case is that both Γ_1 and Γ_2 connect A from the same side. Then, as shown in Figure 2.1(b, c), we can always use the annuli Γ_i and A_i to assemble a torus carried by B . \square

The following lemma is a variation of Lemma 2.2 in [29] and the proof is similar.

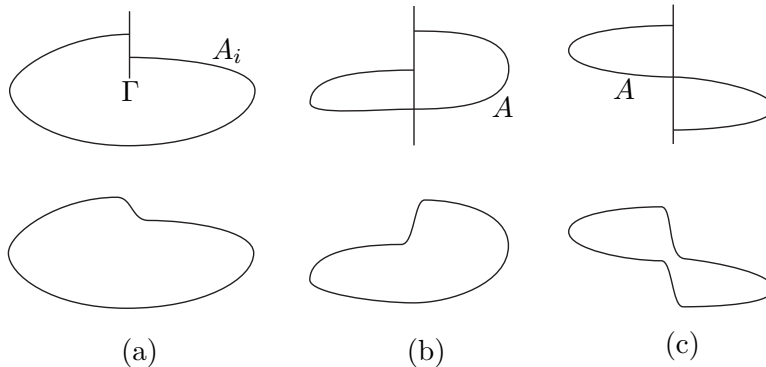

FIGURE 2.1.

Lemma 2.3. *Let $M = H_1 \cup_S H_2$ be a strongly irreducible Heegaard splitting, S the Heegaard surface, and D an embedded disk in M with $\partial D \subset S$. Suppose D is transverse to S and $\text{int}(D) \cap S$ is a single circle γ . Let $D_1 \subset D$ be the disk bounded by γ , and suppose $D_1 \subset H_1$ is a compressing disk of the handlebody H_1 . Then, the annulus $A = D - \text{int}(D_1)$ must be ∂ -parallel in the handlebody H_2 .*

Proof. Since S is strongly irreducible, γ does not bound a disk in H_2 . So, A is incompressible in H_2 , and hence A is ∂ -compressible. Let $E \subset H_2$ be a ∂ -compressing disk for the annulus $A = D - \text{int}(D_1)$. We may suppose ∂E consists of two arcs, α and β , where $\alpha \subset A$ is an essential arc in A , $\beta \subset S$ and $\partial\alpha = \partial\beta \subset \partial A$.

Now, we compress A along E , in other words, we perform a simple surgery, replacing a small neighborhood of α in A by two parallel copies of E . The resulting surface is a disk properly embedded in H_2 . We denote this disk by D_2 . After a small perturbation, we may assume ∂D_2 is disjoint from ∂D_1 . Since $M = H_1 \cup_S H_2$ is a strongly irreducible Heegaard splitting and D_1 is a compressing disk in H_1 , D_2 must be a ∂ -parallel disk in H_2 . Hence A must be ∂ -parallel in H_2 . \square

The following lemma follows easily from Proposition 2.2 and Lemma 2.3.

Lemma 2.4. *Let S be a strongly irreducible Heegaard surface fully carried by a branched surface B , and suppose B does not carry any torus. Let A be an embedded vertical annulus in $N(B)$, and suppose $A \cap S = \cup_{i=1}^n c_i$ consists of n nontrivial circles in S . If some c_i bounds a compressing disk in one of the two handlebodies, then there is a number K depending only on B such that $n = |A \cap S| < K$.*

Proof. Suppose $M = H_1 \cup_S H_2$ is the Heegaard splitting. Let A_i be the sub-annulus bounded by $c_i \cup c_{i+1}$ in A , and we may assume A_i is properly embedded in H_1 if i is odd and in H_2 if i is even.

If c_1 bounds a compressing disk in H_2 , since $c_1 \cup c_2$ bounds an annulus A_1 in H_1 , by Lemma 2.3, A_1 is ∂ -parallel in H_1 . By pushing A_1 into H_2 , we have that c_2 bounds a disk in H_2 . Since A_2 lies in H_2 , the union of A_2 and the disk bounded by c_2 in H_2 is a disk bounded by c_3 . Since each c_i is nontrivial in S , c_3 bounds a compressing disk in H_2 . Again, since A_3 lies in H_1 , by Lemma 2.3, A_3 is ∂ -parallel in H_1 . Inductively, we conclude that A_{2k+1} is ∂ -parallel in H_1 for each k . So, for each k , there is an annulus $\Gamma_k \subset S$ such that $\partial\Gamma_k = \partial A_{2k+1}$ and $A_{2k+1} \cup \Gamma_k$ bounds a solid torus T_k in H_1 . It is clear that any two such solid tori T_i and T_j are either disjoint or nested.

Suppose T_i and T_j are nested, say $T_i \subset T_j$. Hence, $\Gamma_i \subset \Gamma_j$ and $\partial A_{2i+1} \subset \Gamma_j$. Since $\Gamma_j \subset S$ is an annulus carried by $N(B)$ and $\partial A_{2i+1} \subset \Gamma_j \cap A$, by Proposition 2.2, B carries a torus, contradicting our hypotheses. Thus, the solid tori T_i 's are pairwise disjoint. However, by the construction, each solid torus T_i must contain a component of $\partial_h N(B)$, and hence the number of such solid tori is bounded by the number of components of $\partial_h N(B)$. Therefore, there is a number K depending only on B such that $n = |A \cap S| < K$.

If c_1 bounds a compressing disk in H_1 , since $c_1 \cup c_2$ bounds the annulus A_1 in H_1 , c_2 bounds a compressing disk in H_1 . As A_2 is an annulus in H_2 , by Lemma 2.3, we have that A_2 is ∂ -parallel in H_2 . Using the same proof, we can inductively conclude that A_{2k} is ∂ -parallel in H_2 for each k , and obtain such a bound K on $n = |A \cap S|$. \square

The following Proposition for branched surfaces is well-known, see also [6, 1].

Proposition 2.5. *Let B be a branched surface in M . Suppose $M - B$ is irreducible and $\partial_h N(B)$ is incompressible in $M - \text{int}(N(B))$. Let C be a component of $M - \text{int}(N(B))$ and suppose C contains a monogon. Then, C must be a solid torus in the form of $D \times S^1$, where D is a monogon.*

Proof. Let D be a monogon in C , i.e., the disk D is properly embedded in C , ∂D consists of two arcs, $\alpha \subset \partial_v N(B)$ and $\beta \subset \partial_h N(B)$, and α is a vertical arc in $\partial_v N(B)$. Let v be the component of $\partial_v N(B)$ containing α . Then, as shown in Figure 5.4 (a), the union of two parallel copies of D and a rectangle in v is a disk E properly embedded in C , with $\partial E \subset \partial_h N(B)$. Since $\partial_h N(B)$ is incompressible in $M - \text{int}(N(B))$, ∂E must bound a disk in $\partial_h N(B) \cap \partial C$. Since C is irreducible, C must be a solid torus in the form of $D \times S^1$, where D is the monogon above. \square

Before we proceed, we quote two results of Scharlemann that we will use later.

Lemma 2.6 (Lemma 2.2 of [29]). *Suppose $H_1 \cup_S H_2$ is a strongly irreducible Heegaard splitting of a 3-manifold M and F is a disk in M transverse to S with $\partial F \subset S$. Then ∂F also bounds a disk in some H_i .*

Theorem 2.7 (Theorem 2.1 of [29]). *Suppose $H_1 \cup_S H_2$ is a strongly irreducible Heegaard splitting of a 3-manifold M and B is 3-ball in M . Let T_i be the planar surface $\partial B \cap H_i$ properly embedded in H_i , and suppose T_i is incompressible in H_i . Then $S \cap B$ is connected and ∂ -parallel in B .*

Corollary 2.8 follows trivially from Scharlemann's theorem.

Corollary 2.8. *Suppose $H_1 \cup_S H_2$ is a strongly irreducible Heegaard splitting of a 3-manifold. Let P be a planar surface properly embedded in H_1 . Suppose P is incompressible in H_1 , and each boundary component of P bounds a disk in H_2 . Then P is ∂ -parallel in H_1 .*

□

3. MEASURED LAMINATIONS

The purpose of this section is to prove Lemma 3.7, which is an easy consequence of some properties of laminations and results from [18].

The following theorem is one of the fundamental results in the theory of measured laminations and foliations. It also plays an important role in [18]. An exceptional minimal lamination is a lamination in which every leaf is dense, and the intersection of any transversal with such a lamination is a Cantor set, see section 3 of [18].

Theorem 3.1 (Theorem 3.2 in Chapter I of [21], pp 410). *Let μ be a co-dimension one measured lamination in a closed connected 3-manifold M , and suppose $\mu \neq M$. Then, μ is the disjoint union of a finite number of sub-laminations. Each of these sub-laminations is of one of the following types:*

- (1) *A family of parallel compact leaves,*
- (2) *A twisted family of compact leaves,*
- (3) *An exceptional minimal measured lamination.*

Definition 3.2 (Definition 4.2 of [18]). Let μ be a lamination in M and l_0 be a leaf. We call a simple closed curve $f_0 : S^1 \rightarrow l_0$ an *embedded vanishing cycle* in μ if f_0 extends to an embedding $F : [0, 1] \times S^1 \rightarrow M$ satisfying the following properties.

- (1) $F^{-1}(\mu) = C \times S^1$, where C is a closed set of $[0, 1]$, and for any $t \in C$, the curve $f_t(S^1)$, defined by $f_t(x) = F(t, x)$, is contained in a leaf l_t ,
- (2) for any $x \in S^1$, the curve $t \rightarrow F(t, x)$ is transverse to μ ,
- (3) f_0 is an essential curve in l_0 , but there is a sequence of points $\{t_n\}$ in C such that $\lim_{n \rightarrow \infty} t_n = 0$ and $f_{t_n}(S^1)$ bounds a disk in l_{t_n} for all t_n .

The following lemma from [18] will be useful in our proof of Lemma 3.7.

Lemma 3.3 (Lemma 4.3 of [18]). *Let M be a closed orientable and irreducible 3-manifold, and let $\mu \subset M$ be an exceptional minimal measured*

lamination. Suppose μ is fully carried by a branched surface B and B does not carry any 2-sphere. Then, μ has no embedded vanishing cycle.

The proof of the follow lemma is similar in spirit to part of the proof of Lemma 4.5 in [18].

Lemma 3.4. *Let B be a branched surface in a closed, orientable and irreducible 3-manifold M , and $M \neq T^3$. Suppose B does not carry any 2-sphere or torus, and suppose B carries a measured lamination μ . Then, μ does not contain any plane leaf, infinite annular leaf or infinite Möbius band leaf.*

Proof. By Theorem 3.1, we may assume μ is an exceptional minimal measured lamination, in particular, every leaf is dense in μ .

Suppose every leaf of μ is a plane. After trivially eliminating all the disks of contacts in $N(B)$ that are disjoint from μ , we have that $\partial_h N(B)$ consists of disks. So there is no monogon and μ is an essential lamination. By a Theorem in [7] (also see Proposition 4.2 of [15]), $M \cong T^3$.

So, at least one leaf of μ is not a plane. Let γ be an essential simple closed curve in a non-plane leaf. Since μ is a measured lamination, there is no holonomy. So, there is an embedded vertical annulus $S^1 \times I \subset N(B)$ such that $\gamma \subset S^1 \times I$ and $\mu \cap (S^1 \times I)$ is a union of parallel circles. Suppose L is a plane leaf of μ . Since every leaf is dense, $L \cap (S^1 \times I)$ contains infinitely many circles whose limit is γ . As L is a plane, these circles bound disks in L . By Definition 3.2, γ is an embedded vanishing cycle, and this contradicts Lemma 3.3. So, μ does not contain any plane leaf.

Suppose $\mu \subset N(B)$ and A is an infinite annular leaf (or an infinite Möbius band leaf) of μ . Let γ be a simple closed essential curve in A . There is an embedded vertical annulus $S^1 \times I \subset N(B)$ such that $\gamma \subset S^1 \times I$, and $\mu \cap (S^1 \times I)$ is a union of parallel circles. Since every leaf is dense in μ , $A \cap (S^1 \times I)$ contains infinitely many circles whose limit is γ . By Lemma 3.3, we may assume that only finitely many circles in $A \cap (S^1 \times I)$ are trivial in A . Let γ_i ($i = 1, 2, 3$) be 3 essential simple closed curves in $A \cap (S^1 \times I)$, such that $\gamma_1 \cup \gamma_3$ bounds a compact sub-annulus A_γ in A with $\text{int}(A_\gamma) \cap (S^1 \times I) = \gamma_2$. By Proposition 2.2, B carries a torus, contradicting our hypotheses. \square

Lemma 3.5. *Let B be a branched surface in M . Suppose $N(B)$ does not contain any disk of contact and $\partial_h N(B)$ has no disk component. Let $\lambda \subset N(B)$ be a lamination fully carried by $N(B)$. Then, every leaf of λ is π_1 -injective in the 3-manifold $N(B)$.*

Proof. We may use the arguments in [8] to prove this lemma directly, but it is more convenient to simply use a theorem of [8]. Since $\partial_h N(B)$ has no disk component, no component of $\partial N(B)$ is a 2-sphere. For each component S of $\partial N(B)$, we may glue to $N(B)$ (along S) a compact orientable and irreducible 3-manifold M_S , whose boundary $\partial M_S \cong S$ is incompressible in M_S . So, we can obtain a closed 3-manifold M' this way with $N(B) \subset M'$.

Moreover, by our construction, the inclusion $i : N(B) \hookrightarrow M'$ induces an injection on π_1 .

If $\partial_h N(B)$ is compressible in $M' - \text{int}(N(B))$, then we have a compressing disk D with $\partial D \subset \partial_h N(B) \cap S$, where S is a boundary component of $N(B)$. As S is incompressible in M_S , ∂D must bound a disk E in S , which implies that E contains a disk component of $\partial_h N(B)$, contradicting our hypotheses. So, $\partial_h N(B)$ must be incompressible in $M' - \text{int}(N(B))$. There is clearly no monogon by the construction and no disk of contact by our hypotheses. Moreover, since $\partial_h N(B)$ has no disk component and there is no monogon, it is easy to see that there is no Reeb component for $N(B)$. Therefore, by [8], λ is an essential lamination in the closed manifold M' , and every leaf of λ is π_1 -injective in M' hence π_1 -injective in $N(B)$. \square

The following lemma from [18] is also useful in the proof of Lemma 3.7.

Lemma 3.6 (Lemma 4.1 of [18]). *Let B be a branched surface fully carrying a lamination μ with $\mu \subset \text{int}(N(B))$. Suppose $\partial_h N(B)$ contains no disk component and $N(B)$ does not contain any disk of contact that is disjoint from μ . Then, $N(B)$ does not contain any disk of contact.*

Now, Lemma 3.7 follows easily from the previous lemmas.

Lemma 3.7. *Let B be a branched surface in a closed, orientable and irreducible 3-manifold M . Suppose B does not carry any 2-sphere or torus, and B fully carries a measured lamination μ . Then, B can be split into a branched surface B_1 such that B_1 still fully carries μ , no component of $\partial_h N(B_1)$ is a disk, and every leaf of μ is π_1 -injective in $N(B_1)$.*

Proof. By Theorem 3.1, we may assume that μ is an exceptional minimal measured lamination. Since B does not carry any 2-sphere or torus, by Lemma 3.4, no leaf of μ is a plane. After some isotopy, we may assume $\partial_h N(B) \subset \mu$. Hence, we can split $N(B)$ so that each component of $\partial_h N(B)$ contains an essential curve of the corresponding leaf. So, no component of $\partial_h N(B)$ is a disk.

We may push μ back into $\text{int}(N(B))$. After a finite number of splittings on $N(B)$, we may also assume $N(B)$ does not contain any disk of contact that is disjoint from μ . So, by Lemma 3.6, $N(B)$ does not contain any disk of contact. Now the lemma follows from Lemma 3.5. \square

The following Proposition is well-known. It also plays a fundamental role in [16].

Proposition 3.8. *Let M be a closed irreducible and orientable 3-manifold and let B be a branched surface in M carrying a measured lamination μ . If μ is an essential lamination, then B carries an incompressible surface and hence M is Haken.*

Proof. By [8], if μ is an essential lamination, then one can split B into an incompressible branched surface B' that fully carries μ . Since μ is a

measured lamination, the system of branch equations for B' must have a positive solution. Since the coefficients of each branch equation are integers, the system of branch equations must have a positive integer solution. Thus, B' fully carries a closed orientable surface. By [6], every closed surface fully carried by an incompressible branched surface is incompressible. \square

4. LIMITS OF COMPACT SURFACES

Let B be a branched surface in a closed 3-manifold M , and $F \subset N(B)$ be a closed surface carried by B . Then, F corresponds to a nonnegative integer solution to the branch equations of B , see section 3 of [18] for a brief explanation and see [6, 25] for more details. We use $\mathcal{S}(B) \subset \mathbb{R}^N$ to denote the set of non-negative solutions to the branch equations of B , where N is the number of branch sectors of B . There is a one-to-one correspondence between a closed surface carried by B and an integer point in $\mathcal{S}(B)$. A surface is fully carried by B if and only if every coordinate of the corresponding point in $\mathcal{S}(B)$ is positive.

Every point in $\mathcal{S}(B)$, integer point or non-integer point, corresponds to a measured lamination carried by B . Such a measured lamination μ can be considered as the inverse limit of a sequence of splittings $\{B_n\}_{n=0}^\infty$, where $B_0 = B$ and B_{i+1} is obtained by splitting B_i . Note that if B_{i+1} is obtained by splitting B_i , one may naturally consider $N(B_{i+1}) \subset N(B_i)$. We refer to section 3 of [18] for a brief description, see [25] and section 3 of [10] for more details (also see Definition 4.1 and Lemma 4.2 of [8]). There is a one-to-one correspondence between each point in $\mathcal{S}(B)$ and a measured lamination constructed in this fashion. This one-to-one correspondence is slightly different from the one above for integer points of $\mathcal{S}(B)$. For an integer point, the sequence of splittings on B above stop in a finite number of steps (i.e., $B_{i+1} = B_i$ is a closed surface if i is large), and the measured lamination constructed this way is the horizontal foliation of an I -bundle over a closed surface.

We define the *projective lamination space* of B , denoted by $\mathcal{PL}(B)$, to be the set of points in $\mathcal{S}(B)$ satisfying $\sum_{i=1}^N x_i = 1$. Let $p : \mathcal{S}(B) - \{0\} \rightarrow \mathcal{PL}(B)$ be the natural projection sending (x_1, \dots, x_N) to $\frac{1}{s}(x_1, \dots, x_N)$, where $s = \sum_{i=1}^N x_i$. To simplify notation, we do not distinguish a point $x \in \mathcal{S}(B)$ and its image $p(x) \in \mathcal{PL}(B)$ unless necessary. $\mathcal{PL}(B)$ is a compact set. If F_1, \dots, F_n are a sequence of distinct closed surfaces carried by B , then the images of the corresponding points in $\mathcal{PL}(B)$ (under the map p) has an accumulation point, which corresponds to a measured lamination μ . To simplify notation, we simply say that the measured lamination μ is an accumulation point of this sequence of surfaces in $\mathcal{PL}(B)$. Throughout this paper, when we consider a compact surface carried by B , we identify the surface with an integer point in $\mathcal{S}(B)$, but when we consider μ as a limit point of a sequence of compact surfaces in $\mathcal{PL}(B)$, we identify the point

$\mu \in \mathcal{PL}(B)$ to a measured lamination as the inverse limit of the sequence of splittings on B above.

Proposition 4.1. *Let B be a branched surface with n branch sectors and $\{S_k = (x_1^{(k)}, \dots, x_n^{(k)})\}$ be an infinite sequence of integer points in $\mathcal{S}(B)$ whose images in $\mathcal{PL}(B)$ are distinct points. Suppose $\mu = (z_1, \dots, z_n) \in \mathcal{PL}(B)$ is the limit point of $\{S_k\}$ in the projective lamination space. Let $f(x_1, \dots, x_n)$ be a homogeneous linear function with n variables. Then, we have the following.*

- (1) if $z_i = 0$ and $z_j \neq 0$, then $\lim_{k \rightarrow \infty} x_i^{(k)}/x_j^{(k)} = 0$.
- (2) if $z_i > z_j$, then $x_i^{(k)} > x_j^{(k)}$ if k is sufficiently large.
- (3) if the sequence $\{f(S_k)\}$ is bounded, then $f(\mu) = 0$.

Proof. Let $s_k = \sum_{i=1}^n x_i^{(k)}$. Then, the corresponding point of S_k in the projective lamination space is $[S_k] = (x_1^{(k)}/s_k, \dots, x_n^{(k)}/s_k)$. By our hypotheses, $\lim_{k \rightarrow \infty} x_i^{(k)}/s_k = z_i$ for each i . Thus, if $z_i = 0$ and $z_j \neq 0$, then $\lim_{k \rightarrow \infty} x_i^{(k)}/x_j^{(k)} = z_i/z_j = 0$.

Since $x_i^{(k)}/s_k > x_j^{(k)}/s_k$ is equivalent to $x_i^{(k)} > x_j^{(k)}$, part 2 is obvious.

Since $f(x_1, \dots, x_n)$ is a homogeneous linear function, $f([S_k]) = f(S_k)/s_k$ and $\lim_{k \rightarrow \infty} f([S_k]) = f(\mu)$. Since the sequence $\{S_k = (x_1^{(k)}, \dots, x_n^{(k)})\}$ ($k = 1, 2, \dots$) are distinct non-negative integer solutions, the integers $\{s_k\}$ are unbounded. So, after passing to a subsequence if necessary, we have $\lim_{k \rightarrow \infty} s_k = \infty$. Therefore, if the sequence $\{f(S_k)\}$ is bounded from above, then $\lim_{k \rightarrow \infty} f(S_k)/s_k = f(\mu) = 0$. \square

Corollary 4.2. *Let $\{S_k\}$ be a sequence of distinct compact connected surfaces carried by a branched surface $N(B)$. Let $\mu \subset N(B)$ be the measured lamination corresponding to the limit of $\{S_k\}$ in $\mathcal{PL}(B)$, and let K be an I -fiber of $N(B)$ such that $K \cap \mu \neq \emptyset$. Then, if k is large, $|K \cap S_k|$, the number of intersection points of K and S_k , is large.*

Proof. The number of intersection points of an I -fiber and S_k is equal to the integer value of a coordinate of the corresponding point in $\mathcal{S}(B)$. So, the corollary follows immediately from part 3 of Proposition 4.1 after setting the linear function to $f(x_1, \dots, x_n) = x_i$, where x_i corresponds to the branch sector of B that contains the point $\pi(K)$ ($x_i = |K \cap S_k|$). \square

We call a lamination μ a normal lamination with respect to a triangulation if every leaf of μ is a (possibly non-compact) normal surface.

Corollary 4.3. *Let M be a closed 3-manifold with a fixed triangulation, and let B be a branched surface obtained by gluing together a collection of normal disks and at most one almost normal piece. Suppose $\{S_n\}$ is an infinite sequence of distinct connected almost normal surfaces fully carried by B . Then, each accumulation point of $\{S_n\}$ in $\mathcal{PL}(B)$ must correspond to a normal measured lamination.*

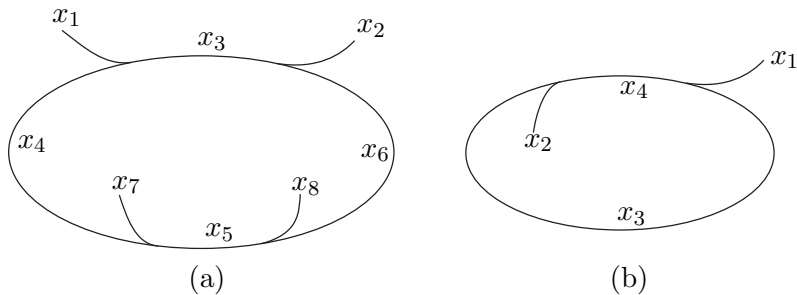

FIGURE 4.1.

Proof. If B does not contain an almost normal piece, then there is nothing to prove. So, suppose s is a branch sector of B containing the almost normal piece. By the hypotheses, $B - \text{int}(s)$ must be a sub branched surface of B and every lamination carried by $B - \text{int}(s)$ is normal ($B - \text{int}(s)$ is called the normal part of B in section 2 of [18]). Suppose $S_n = (x_1, \dots, x_N) \in \mathcal{S}(B)$ and suppose x_1 is the coordinate corresponding to the branch sector s . Since an almost normal surface has at most one almost normal piece, $x_1 = 1$ for each S_n . Suppose $\mu = (z_1, \dots, z_N) \in \mathcal{PL}(B)$. By Proposition 4.1 and Corollary 4.2, z_1 must be zero. Hence, μ is carried by $B - \text{int}(s)$ and is a normal lamination. \square

Now, we will use two examples to illustrate the limit of closed surfaces. Although the two examples are train tracks, similar results hold for branched surfaces.

Example 4.4. Let τ be a train track in the plane as shown in Figure 4.1(a). There are 8 branch sectors in τ , and the branch equations are $x_1 + x_4 = x_3 = x_2 + x_6$ and $x_7 + x_4 = x_5 = x_8 + x_6$. Suppose $\{\gamma_n\}$ is an infinite sequence of compact arcs carried by τ whose limit in $\mathcal{PL}(\tau)$ is the point $\mu = (0, 0, 1/4, 1/4, 1/4, 1/4, 0, 0)$. Geometrically μ is the measured lamination consisting of parallel circles carried by τ . We identify γ_n with an integer point in $\mathcal{S}(\tau)$ and suppose the γ_n 's are different points in $\mathcal{S}(\tau)$. Note that γ_n contains a circle if and only if $x_1 = x_2$ and $x_7 = x_8$. By Proposition 4.1 and Corollary 4.2, as n tends to infinity, the values x_6 and x_6/x_2 of γ_n tend to infinity. This implies that, if n is large, γ_n contains either many parallel circles or a spiral wrapping around the circle many times.

In the proof of the main theorem, we will consider the limit lamination μ of an infinite sequence of almost normal Heegaard surfaces carried by a branched surface B . The measured lamination μ is fully carried by a sub branched surface B^- of B . In many situations, we would like to split B^- into a nicer branched surface B_1^- . In fact, by considering $\mu \subset N(B^-) \subset N(B)$, we can split $N(B^-)$ and $N(B)$ simultaneously and obtain $\mu \subset N(B_1^-) \subset N(B_1)$, such that B_1^- is the sub branched surface of B_1 that fully carries μ , B_1 is obtained by some splittings on B , and B_1 still carries

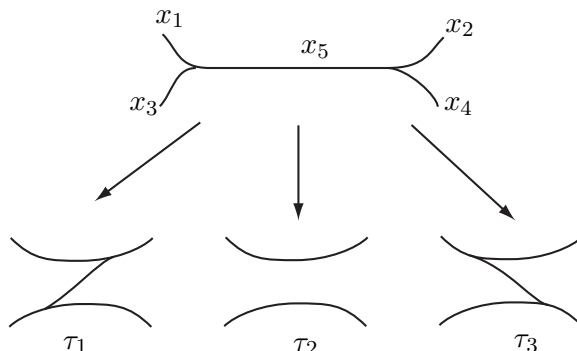

FIGURE 4.2.

an infinite sub-sequence of $\{S_n\}$. Next, we will use Example 4.5 to illustrate how the local splittings work. We also formulate this fact in Proposition 4.6. Proposition 4.6 is similar in spirit to Lemma 6.1 of [18].

Example 4.5. Let τ be the train track on the top of Figure 4.2. As shown in Figure 4.2, τ can be split into 3 different train tracks τ_1 , τ_2 and τ_3 . Suppose μ is a lamination fully carried by τ . Let x_1, \dots, x_5 be the weights of μ at the branch sectors of τ . These x_i 's satisfy the branch equations $x_1 + x_3 = x_5 = x_2 + x_4$. It is easy to see that $x_1 < x_2$ (resp. $x_1 > x_2$) if and only if μ is fully carried by τ_1 (resp. τ_3), and $x_1 = x_3$ if and only if μ is fully carried by τ_2 . Suppose $\{S_n\}$ is an infinite sequence of compact arcs carried by τ and suppose each S_n corresponds to a different integer point in $\mathcal{S}(\tau)$. Suppose the limit of $\{S_n\}$ in $\mathcal{P}\mathcal{L}(\tau)$ is μ .

By part 2 of Proposition 4.1, if $x_1 < x_2$ (resp. $x_1 > x_2$) for μ , we can split τ into τ_1 (resp. τ_3), and τ_1 (resp. τ_3) fully carries μ and an infinite sub-sequence of $\{S_n\}$. Now, we consider the case $x_1 = x_2$ for μ . Although we can split τ (along μ) into τ_2 which fully carries μ , τ_2 may not carry infinitely many S_n 's. Nonetheless, if τ_2 only carries finitely many S_n 's, then at least one of τ_1 and τ_3 , say τ_1 , must carry an infinite sub-sequence of $\{S_n\}$. Moreover, τ_1 can be considered as the train track obtained by adding a branch sector to τ_2 , and τ_1 can be obtained by splitting τ .

Now we consider the splittings on branched surfaces. Note that any splitting on a branched surface can be viewed as a sequence of successive local splittings, and the operations of such local splittings on a branched surface is basically the same as the splitting on the train track in Example 4.5. So, we have the following proposition.

Proposition 4.6. *Let B be a branched surface and $\{S_n\} \subset \mathcal{S}(B)$ be a sequence of distinct compact surfaces carried by B . Suppose $\mu \in \mathcal{P}\mathcal{L}(B)$ is the limit point of $\{S_n\}$ in $\mathcal{P}\mathcal{L}(B)$. Let B^- be the sub branched surface of B that fully carries μ . Let B_1^- be any branched surface obtained by splitting B^- along μ , and suppose B_1^- still fully carries μ . Then, similar to the*

operation of obtaining τ_1 by adding a branch sector to τ_2 in Example 4.5, one can add some branch sectors to B_1^- and form a branched surface B_1 , such that B_1 can be obtained by splitting B , and B_1 carries an infinite sub-sequence of $\{S_n\}$.

Remark 4.7. In Proposition 4.6, B_1^- is the sub branched surface of B_1 that fully carries μ . Since any lamination carried by B_1 is carried by B , it is easy to see that $\mu \subset N(B_1)$ is still the limit point in $\mathcal{PL}(B_1)$ of the sub-sequence of $\{S_n\}$ carried by B_1 .

Remark 4.8. Let $\{S_n\}$ be an infinite sequence of distinct closed surfaces carried by $N(B)$ whose limit in $\mathcal{PL}(B)$ is a measured lamination μ . Let γ be a simple closed essential curve in a leaf of μ . If every I -fiber of $N(B)$ intersects γ in at most one point, then (after a slight enlargement) $\pi^{-1}(\pi(\gamma))$ can be considered as a fibered neighborhood of a train track consisting of a circle $\pi(\gamma)$ and some “tails” along the circle similar to Figure 4.1, where $\pi : N(B) \rightarrow B$ is the map collapsing each I -fiber to a point. Since the limit of $\{S_n\}$ is μ , $\pi^{-1}(\pi(\gamma)) \cap S_i$ ($i = 1, 2, \dots$) is a sequence of curves whose limit is a measured lamination containing the circle γ . As in Example 4.4, if n is large, $\pi^{-1}(\pi(\gamma)) \cap S_n$ must contain either many circles parallel to γ or a spiral winding around γ many times. If there is an I -fiber of $N(B)$ intersecting γ in more than one point, then $\pi(\gamma)$ is an immersed curve in B . Since γ is an embedded essential curve in a leaf of μ , by Theorem 3.1, after a finite step of splittings on B , we get a branched surface B_1 such that B_1 still carries μ and $\pi|_\gamma$ is injective, where $\pi : N(B_1) \rightarrow B_1$ is the collapsing map, (i.e., every I -fiber of $N(B_1)$ intersects γ in at most one point). Moreover, by Proposition 4.6, we may assume B_1 still carries an infinite sub-sequence of $\{S_n\}$. Now, the situation is the same as above after replacing B by B_1 .

The next lemma says that, if the branched surface is nice, then the limit of trivial circles in a sequence of closed surfaces cannot be an essential circle in the limit lamination.

Lemma 4.9. *Let M be a closed 3-manifold with a fixed triangulation, and let B be a branched surface obtained by gluing together a collection of normal disks and at most one almost normal piece. Suppose $N(B)$ does not carry any normal 2-sphere or normal torus. Let $\{S_n\}$ be a sequence of distinct closed almost normal surfaces fully carried by $N(B)$ whose limit in $\mathcal{PL}(B)$ is a measured lamination μ . Let γ be an essential simple closed curve in a leaf of μ . Then, B can be split into a branched surface B_1 that carries both μ and an infinite sub-sequence $\{S_{n_k}\}$ of $\{S_n\}$, such that, for any embedded vertical annulus $A \supset \gamma$ in $N(B_1)$, $A \cap S_{n_k}$ does not contain any circle that is trivial in the surface S_{n_k} , for each S_{n_k} .*

Proof. Let A_γ be an embedded vertical annulus in $N(B)$ containing γ . Suppose $A_\gamma \cap S_n$ contains a trivial circle in S_n for each n . Such a trivial circle bounds a disk D_n in S_n . So, D_n is transverse to the I -fiber of $N(B)$

and with $\partial D_n \subset A_\gamma$. Let s be the branch sector containing the almost normal piece, and let $B' = B - \text{int}(s)$ be the sub branched surface of B (B' is called the normal part of B , see section 2 of [18]). By Corollary 4.3, μ is carried by B' . So, we can assume that if D_n contains an almost normal piece, the almost normal piece lies in $\text{int}(D_n)$. Since S_n is an almost normal surface, D_n contains at most one almost normal piece.

Claim. Up to B -isotopy, there are only finitely many such disks D_n .

To prove the claim, we first consider such disks that do not contain almost normal pieces. If D_n does not contain an almost normal piece, then we may assume that D_n lies in $N(B')$ transverse to the I -fibers of $N(B')$, and consider A_γ as an embedded vertical annulus in $N(B')$. Let \mathcal{S}_γ be the set of embedded compact surfaces F in $N(B')$ with the properties that F is transverse to the I -fibers of $N(B')$ and ∂F is a single circle in A_γ . Similar to $\mathcal{S}(B')$, we can describe \mathcal{S}_γ as the set of non-negative integer solutions of a system of non-homogeneous linear equations as follows, see [1] for such a description for disks of contact. Let L' be the branch locus of B' and suppose $\pi(A_\gamma)$ is an immersed curve in B' . Suppose b_1, \dots, b_N are the components of $B' - L' - \pi(A_\gamma)$. For each b_i and any $F \in \mathcal{S}_\gamma$, let $x_i = |F \cap \pi^{-1}(b_i)|$. One can describe F using a non-negative integer point $(x_1, \dots, x_N) \in \mathbb{R}^N$, and (x_1, \dots, x_N) is a solution of the system of (non-homogeneous) linear equations of the forms $x_k = x_i + x_j$ and $x_i = x_j + 1$. Equations like $x_i = x_j + 1$ occur when two pieces are glued along $\pi(A_\gamma)$, because $\pi(\partial F) = \pi(A_\gamma)$. Up to B' -isotopy, there are only finitely many surfaces corresponding to the same integer point in \mathcal{S}_γ . Moreover, the corresponding homogeneous system is exactly the system of branch equations for B' . Suppose there is an infinite sequence of distinct disks $\{D_n\}$ in \mathcal{S}_γ . Then, one can find $D_i = (x_1, \dots, x_N)$ and $D_j = (y_1, \dots, y_N)$ such that $x_k \leq y_k$ for each k . Thus, $D_j - D_i = (y_1 - x_1, \dots, y_N - x_N)$ is a non-negative integer solution to the corresponding homogeneous system, i.e., the system of branch equations. So, $D_j - D_i$ corresponds to a closed surface carried by B' . Since the genus is additive, $\chi(D_j - D_i) = \chi(D_j) - \chi(D_i) = 0$. This means B' carries a closed surface (may not be connected) with total Euler character 0, which implies that B' must carry a connected surface with non-negative Euler characteristic. If B' carries a Klein bottle (or projective plane), B' must carry a torus (or 2-sphere) because M is orientable. Since $B' = B - \text{int}(s)$, every surface carried by B' is normal. This contradicts the hypothesis that B does not carry any normal 2-sphere or normal torus.

Suppose there is an infinite sequence of disks $\{D_n\}$ from the S_i 's, such that each D_n contains an almost normal piece. As above, we can also identify each D_n as an integer solution of a system of non-homogeneous linear equations. Up to B -isotopy, there are only finitely many such disks corresponding to the same integer point. If $\{D_n\}$ correspond to different integer points, then one can find $D_i = (x_1, \dots, x_K)$ and $D_j = (y_1, \dots, y_K)$ such that $x_k \leq y_k$ for each k . Suppose the first coordinate corresponds to

the branch sector s that contains the almost normal piece. Since each S_n is an almost normal surface, each D_n contains only one almost normal piece. Hence, $x_1 = y_1 = 1$ and the first coordinate of $D_j - D_i$ is $y_1 - x_1 = 0$. So, $D_j - D_i$ does not contain an almost normal piece and is carried by B' . Now, the argument is the same as above. This finishes the proof of the claim.

Let B^- be the sub branched surface of B fully carrying μ . As described earlier in this section and in section 3 of [18], we may consider μ as the inverse limit of an infinite sequence of splittings on B^- . Suppose $\{B_n^-\}$ is such a sequence of branched surfaces, with each B_i^- obtained by splitting B_{i-1}^- and μ being the inverse limit of the sequence $\{N(B_n^-)\}$. Note that if μ consists of compact leaves, then such splittings are a finite process. By Theorem 3.1, we only consider the case that μ is an exceptional minimal measured lamination, and the proof for the case that μ consists of compact leaves is similar. By Proposition 4.6, we may assume there is a sequence of branched surfaces $\{B_n\}$ such that, for each n , B_{n+1} is obtained by splitting B_n , B_n carries μ and an infinite sub-sequence of $\{S_n\}$, and B_n^- is a sub branched surface of B_n .

Let $A_k \subset N(B_k^-)$ be a vertical annulus containing γ . By Lemma 3.7, after some splittings, we may assume that if k is sufficiently large, every leaf of μ is π_1 -injective in $N(B_k^-)$. Since γ is an essential curve in a leaf, if k is sufficiently large, there is no disk D in $N(B_k^-)$ with $\partial D \subset A_k$. Now, suppose $D \subset N(B_k)$ is a disk in S_n with $\partial D \subset A_k$. So, D cannot be totally in $N(B_k^-)$. If $\mu \cap D \neq \emptyset$ under any B_k -isotopy, since μ is the inverse limit of the infinite sequence of splittings, these splittings $\{B_k\}$ will eventually cut through D . By the claim above, there are only finitely many such disks D . So, if m is sufficiently large, there is no such a disk $D \subset N(B_m)$ with $\mu \cap D \neq \emptyset$. If $D \cap \mu = \emptyset$, we can split B_k and B_k^- further so that D is carried by $B_k - B_k^-$ and hence $\partial D \not\subset A_k$ after this splitting. By the claim above, there are only finitely many such disks D , so after a finite step of splittings, we get a branched surface B_k satisfying the requirements of the lemma.

We should note that the assumption that B does not carry any normal torus is important. For example, if μ is a torus, one can easily construct a counter-example using an infinite sequence of disks wrapping around μ like the Reeb component. \square

Lemma 4.10. *Let M , B , $\{S_n\}$ and μ be as in Lemma 4.9. Let γ be an immersed essential closed curve in a leaf of μ . Then, B can be split into a branched surface B_1 that carries μ and an infinite sub-sequence $\{S_{n_k}\}$ of $\{S_n\}$, such that, for each k , S_{n_k} contains no embedded disk D with the property that $\pi(\partial D) = \pi(\gamma)$, where $\pi : N(B_1) \rightarrow B_1$ is the collapsing map.*

Proof. This lemma is basically the same as Lemma 4.9. Although the curve γ may not be embedded, each S_n is embedded. Hence, there are only finitely many different configuration for ∂D . So, the lemma follows from the same arguments in the proof of Lemma 4.9. \square

5. HELIX-TURN-HELIX BANDS

A technical part in the proof of the main theorem is to construct compressing disks for the two handlebodies in the Heegaard splitting, using $N(B)$. Such compressing disks are constructed using a complicated band in $N(B)$ that connects two parallel monogons, as shown in Figure 5.4 (a). The purpose of this section is to demonstrate how to construct these bands. Such bands are constructed using a local picture of the limit lamination of a sequence of Heegaard surfaces. We will start with a one-dimension lower example.

Definition 5.1. Let $A = S^1 \times I$ be an annulus and α be a compact spiral in A transverse to the I -fibers. We define the *winding number* of α , denoted by $w(\alpha)$, to be the smallest intersection number of α with an I -fiber of A .

Example 5.2. Let τ be a train track obtained by attaching two “tails” to a circle γ , as shown in Figure 4.1(b). Curves fully carried by τ must consist of spirals. We use x_1, \dots, x_4 to denote the 4 branch sectors of τ , and the branch equations are $x_1 + x_3 = x_4$ and $x_2 + x_3 = x_4$. Suppose $\{\gamma_n\}$ is an infinite sequence of positive integer solutions to the branch equations whose limit μ in $\mathcal{PL}(\tau)$ is a measured lamination consisting of parallel circles carried by τ . So, the coordinates of μ in $\mathcal{PL}(\tau)$ is $(0, 0, 1/2, 1/2)$. Let $\gamma_i = (x_1^{(i)}, \dots, x_4^{(i)}) \in \mathcal{S}(\tau)$ be the corresponding integer point. For each γ_i , we denote the number of components of γ_i by $h(\gamma_i)$ and clearly, $h(\gamma_i) = x_1^{(i)} = x_2^{(i)}$. Moreover, the winding number of each component of γ_i is $w(\gamma_i) = x_3^{(i)} / h(\gamma_i)$. Because of the branch equations, we have $\gamma_i = (x_1^{(i)}, x_1^{(i)}, x_3^{(i)}, x_1^{(i)} + x_3^{(i)})$. Since the limit of these points in $\mathcal{PL}(\tau)$ is $(0, 0, 1/2, 1/2)$, by part 1 of Proposition 4.1, we have that $\lim_{i \rightarrow \infty} x_1^{(i)} / x_3^{(i)} = 0$, in other words $\lim_{i \rightarrow \infty} w(\gamma_i) = \infty$.

In general, a train track near a circle can have many “tails” like Figure 4.1 (a), but the argument above still work (using part 2 of Proposition 4.1). If the limit of a sequence of spiral curves $\{\gamma_i\}$ is a measured lamination by circles, then the winding numbers tend to infinity, $\lim_{i \rightarrow \infty} w(\gamma_i) = \infty$.

Let $S^1 \times I$ be an annulus, and let γ be a collection of disjoint spirals properly embedded in $S^1 \times I$ and transverse to the I -fibers. Suppose the winding number for each spiral is at least 2. We fix an I -fiber $\{x\} \times I$. Let β be a subarc of a spiral in γ with $\beta \cap (\{x\} \times I) = \partial\beta$. Let α be the subarc of $\{x\} \times I$ between the two endpoints of β . We define the *discrepancy* for γ to be $1 + |\gamma \cap \text{int}(\alpha)|$. It is very easy to see that the discrepancy is equal to the number of components of γ and does not depend on the choice of β .

Next, we consider the two-dimensional version of Example 5.2.

Example 5.3. If we take a product of the train track in Example 5.2 and an interval, we get a branched surface, see the shaded region in Figure 5.1 (a). As shown in Figure 5.1 (a), we may assume this branched surface is sitting in $A \times I$, where A is a horizontal annulus, and this branched surface is

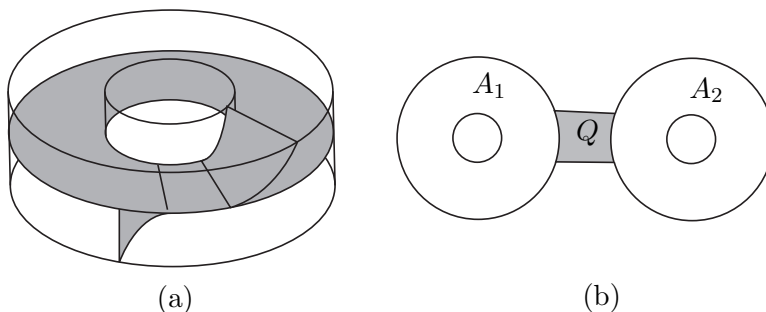

FIGURE 5.1.

transverse to the I -fibers of $A \times I$. For any essential simple closed curve c in A , the intersection of the cylinder $c \times I$ in $A \times I$ and the branched surface is a train track in Example 5.2. Suppose there is a sequence of spiraling disks $\{S_n\}$ fully carried by this branched surface and the limit lamination of $\{S_n\}$ is a union of horizontal annuli of the form $A \times \{x\}$, $x \in I$. Then, we can define the winding number similarly, and if n tends to infinity, the winding number of S_n tends to infinity as well. To fit this in the bigger picture, we should consider the $A \times I$ as a small portion of $N(B)$ and these S_n 's are parts of the Heegaard surfaces.

Let h be the number of components of S_n and suppose $h \geq 2$. Then, in each vertical cylinder $c \times I \subset A \times I$, where c is an essential simple closed curve in A , we have an embedded helical band $l \times J$, as shown in Figure 5.2 (a), where J is an interval, $l \times \partial J$ is a pair of spirals in $S_n \cap (c \times I)$, and each $\{x\} \times J$ ($x \in l$) is a subarc of an I -fiber of $A \times I$. In fact, we can thicken this helical band $l \times J \subset c \times I$ to contain all the h spirals of $S_n \cap (c \times I)$, with 2 spirals being $l \times \partial J$ and $h - 2$ spirals in $l \times \text{int}(J)$. We call $\partial l \times J$ the two ends of the band and define the wrapping number the band to be the wrapping number of a spiral $l \times \{p\}$. We call such a band $l \times J$ as shown in Figure 5.2 (a) a *helical band*, and define the *thickness* of a helical band $l \times J$ to be the number of components of $S_n \cap (l \times J)$. Thus, by the construction, the thickness of an embedded helical band is at least 2 and can be as large as h .

Example 5.4. Let A_1 and A_2 be two annuli and Q be a quadrilateral. By connecting A_1 and A_2 using Q , we get a pair of pants P , as shown in Figure 5.1 (b). Now, we consider the product $P \times I$. Let $\{S_n\}$ be a sequence of compact surface in $P \times I$ transverse to the I -fibers, and suppose the limit lamination of $\{S_n\}$ is of the form $P \times C$, where C is a closed set in I . Suppose each component of $S_n \cap (Q \times I)$ is of the form $Q \times \{x\}$, $x \in \text{int}(I)$, and suppose $S_n \cap (A_i \times I)$ ($i = 1, 2$) consists of spiraling disks as in Example 5.3. We will use h_i to denote the number of components of $S_n \cap (A_i \times I)$, and use w_i to denote the winding number of a spiraling disk in $S_n \cap (A_i \times I)$. As in Example 5.2, if n is large, the

winding number w_i is large. In this paper, we will also assume each h_i is an even number and $h_i \geq 2$, $i = 1, 2$.

$S_n \cap (A_i \times I)$ consists of h_i spiraling disks ($i = 1, 2$). Topologically, each spiraling disk is a meridian disk of the solid torus $A_i \times I$, and the intersection of these spiraling disks with each annulus in $A_i \times \partial I$ is a union of parallel essential arcs in the annulus. We say an arc K is a *proper vertical arc* if K is a subarc of an I -fiber of $P \times I$ and K is properly embedded in $\overline{P \times I - S_n}$. Let $\gamma \times J$ be an embedded rectangle in $P \times I$. We call $\gamma \times J$ a *vertical band* if each $\{x\} \times J$ is a subarc of an I -fiber and $\gamma \times \partial J$ lies in S_n . Note that the helical bands described in Example 5.3 are vertical bands. We define the *thickness* of the vertical band $\gamma \times J$ to be the number of components of $S_n \cap (\gamma \times I)$. So, the thickness of a vertical band is at least 2.

By our assumptions, the number of components of $S_n \cap (Q \times I)$ is roughly $w_1 h_1 = w_2 h_2$. Let J be a proper vertical arc in $Q \times I$ and α_J be an arc in $Q \times I$ connecting a point in $\text{int}(J)$ to $Q \times \{0\}$. We define the *height* of J to be the minimal number of intersection points in $S_n \cap \alpha_J$. We take a vertical band $\beta \times J$ around $A_i \times I$ and with both vertical arcs $\partial\beta \times J$ in $Q \times I$, as in Figure 5.2 (b), and suppose each $\{x\} \times J$ ($x \in \beta$) is a proper vertical arc. Then, since $S_n \cap (A_i \times I)$ consists of spiraling disks, the height difference between the two proper vertical arcs $\partial\beta \times J$ is equal to the discrepancy (see the definition of discrepancy before Example 5.3) of the spirals around $A_i \times I$. Hence, the height difference for the two arcs $\partial\beta \times J$ is equal to h_i . Moreover, two proper vertical arcs in $(A_i \cap Q) \times I$ belong to the same component of $\overline{A_i \times I - S_n}$ if and only if the height difference between the two arcs is kh_i for some integer k .

Now, we are in position to construct our bands. We have two situations. Recall that, as in Example 5.4, we assume each h_i is an even number and $h_i \geq 2$.

Example 5.5 (Helix-turn-helix bands). We first consider the case $h_1 = h_2$. Let J_1 be a proper vertical arc in $\overline{(A_1 \cap Q) \times I - S_n}$. We first take a vertical band σ around $A_2 \times I$, connecting J_1 to another proper vertical arc $J_2 \subset (A_1 \cap Q) \times I$, as shown in Figure 5.2(b). The height difference between J_1 and J_2 is h_2 . Since $h_1 = h_2$, J_1 and J_2 lie in the same component of $\overline{A_1 \times I - S_n}$. Then, we take a helical band σ_i ($i = 1, 2$), as in Figure 5.2 (a), connecting J_i to a proper vertical arc J'_i , where J'_i has an endpoint in the bottom annulus $A_1 \times \{0\}$. We can choose σ_1 and σ_2 in different vertical cylinders in $A_1 \times I$, so we may assume $\sigma_1 \cap \sigma_2 = \emptyset$ and $\Sigma = \sigma_1 \cup \sigma \cup \sigma_2$ is an embedded vertical band connecting J'_1 to J'_2 . Note that since the height difference between J_1 and J_2 is $h_2 = h_1$, the winding numbers for σ_1 and σ_2 differ by one. We may write $\Sigma = \gamma \times J$, where γ is an arc and J is a closed interval. Σ has the properties that $\Sigma \cap S_n = \gamma \times \partial J$, each $\{x\} \times J$ is a subarc of an I -fiber of $P \times I$, and

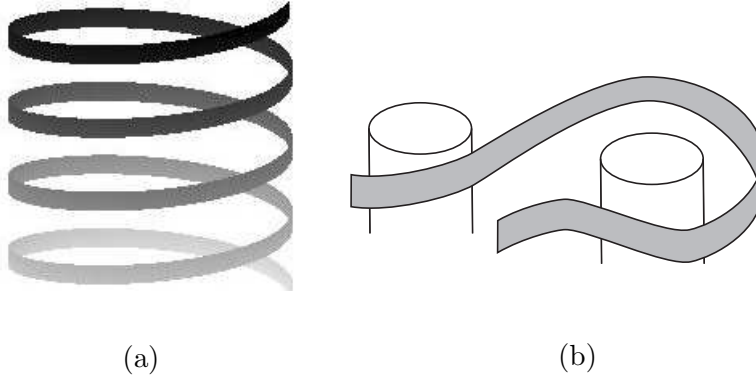

FIGURE 5.2.

$\partial\gamma \times J = J'_1 \cup J'_2$. We call Σ a *helix-turn-helix* (or HTH) band. Note that the thickness of the vertical band Σ in this example is 2.

Since J'_1 and J'_2 lie in the same component of $A_1 \times I - S_n$ and each J'_i has an endpoint in the bottom annulus $A_1 \times \{0\}$, we may glue a small vertical band δ to Σ , connecting J'_1 to J'_2 , and get a vertical annulus $A_\Sigma = \Sigma \cup \delta$ properly embedded in $(P \times I) - S_n$. Note that $J'_1 \cup J'_2$ is a pair of opposite edges of δ and δ has an edge totally in the bottom annulus $A \times \{0\}$. Let x_i be the element in $\pi_1(P \times I)$ represented by the core of $A_i \times I$ ($i = 1, 2$). Then, this vertical annulus A_Σ represents the element $x_1^{-k} \cdot x_2 \cdot x_1^{k+1}$ in $\pi_1(P \times I)$.

Example 5.6. In this example, we consider the case $h_1 < h_2$. Let J_1 be a proper vertical arc in $(A_1 \cap Q) \times I$, and suppose $height(J_1) = t$. We first take a vertical band σ_1 around $A_1 \times I$, connecting J_1 to another proper vertical arc $J_2 \subset Q \times I$ with $height(J_2) = t + h_1$. Then, we take a vertical band σ_2 around $A_2 \times I$, connecting J_2 to a proper vertical arc $J_3 \subset Q \times I$ with $height(J_3) = height(J_2) \pm h_2 = t + h_1 \pm h_2$. The next step is to use a vertical band σ_3 around $A_1 \times I$, connecting J_3 to a proper vertical arc $J_4 \subset Q \times I$ with $height(J_4) = height(J_3) - h_1 = t \pm h_2$. There is also a vertical band σ_4 around $A_2 \times I$, connecting J_4 to a proper vertical arc $J_5 \subset (A_1 \cap Q) \times I$ with $height(J_5) = height(J_4) \mp h_2 = t$. Let σ be the concatenation of these σ_i 's. So, the two ends of σ J_1 and J_5 have the same height. Since $h_1 < h_2$, J_1 , J_2 , J_3 and J_4 have different heights. If we project σ to P via the projection $\pi : P \times I \rightarrow P$, $\pi(\sigma)$ is an immersed arc, as shown in Figure 5.3 (the shaded region in Figure 5.3 is part of Q). By the height assumptions above, we may assume σ is embedded in $P \times I$. Now, similar to Example 5.5, we can attach two disjoint helical bands to J_1 and J_5 to reach down to the bottom annulus $A_1 \times \{0\}$. We denote the resulting vertical band by Σ and also call it an HTH band. We may also assume the two ends of Σ are close to each other, and by gluing a small

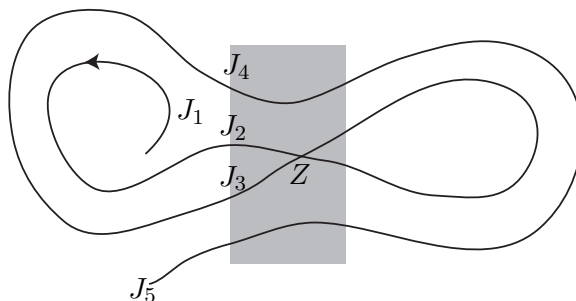

FIGURE 5.3.

vertical band δ to Σ as in Example 5.5, we can obtain a vertical annulus $A_\Sigma = \Sigma \cup \delta$ properly embedded in $\overline{P \times I - S_n}$. A_Σ represents the element $x_1^{-k} \cdot c \cdot x_1^k$ in $\pi_1(P \times I)$, where $c = x_1 \cdot x_2 \cdot x_1^{-1} \cdot x_2^{-1}$ is a commutator. Note that one can also use this construction in the case that $h_1 = h_2$, but the construction in Example 5.5 is much simpler.

Example 5.7. Similar to Example 5.3, we can trivially thicken the HTH band constructed in Example 5.5 to an embedded vertical band $\hat{\Sigma}$ so that the thickness of $\hat{\Sigma}$ is h_1 ($h_1 = h_2$ in Example 5.5). We have to be more careful about Example 5.6. Let Σ be the HTH band constructed in Example 5.6. Σ is constructed by gluing two helical bands to a vertical band σ , and the projection $\pi(\sigma)$ of σ in P is as shown in Figure 5.3. We first trivially thicken Σ as above to a band $\hat{\Sigma}$ so that the thickness of $\hat{\Sigma}$ is h_1 . We claim that $\hat{\Sigma}$ is an embedded vertical band. Let $I_Z = \pi^{-1}(Z)$ be the I -fiber of $P \times I$ corresponding to the double point Z of $\pi(\sigma)$ in Figure 5.3 ($I_Z \subset Q \times I$). Similar to Example 5.3, the only possible singularity of $\hat{\Sigma}$ occurs at the I -fiber I_Z . We need to calculate the height difference of the two proper vertical arcs of $\sigma \cap I_Z$. If the height difference is at least h_1 , then no singularity occurs at I_Z when we thicken Σ to $\hat{\Sigma}$. Recall that in the construction in Example 5.6, $height(J_1) = t$, $height(J_2) = t + h_1$ and $height(J_3) = t + h_1 \pm h_2$. Thus, the height difference for the two proper vertical arcs at I_Z is $|height(J_2) - height(J_3)| = h_2$. Since we have $h_1 < h_2$ in Example 5.6, the thickened vertical band $\hat{\Sigma}$ is embedded. We will also call the thickened vertical band $\hat{\Sigma}$ an HTH band.

Example 5.8. In Examples 5.5 and 5.6, if the winding numbers w_1 and w_2 are large, we can construct many disjoint HTH bands. To see this, we first divide $P \times I$ into N parts, $P \times I_i$ ($i = 1, \dots, N$), where $I_i = [\frac{i-1}{N}, \frac{i}{N}]$. We may assume the intersection of S_n with each $P \times I_i$ is as described in Example 5.4. Suppose the winding numbers w_1 and w_2 are large. Then, we can carry out the constructions in Examples 5.5 and 5.6 on each $P \times I_i$. Then, we glue a pair of long helical bands to the two ends of each vertical band constructed in $P \times I_i$ to reach down to the bottom annulus $A_1 \times \{0\}$.

By choosing these helical bands to be in disjoint vertical cylinders, we may assume these bands are disjoint. Let $\Sigma_i = \gamma_i \times J$ ($i = 1, \dots, N$) be the N disjoint HTH bands above. Each component of $\partial\gamma_i \times J$ is a proper vertical arc with an endpoint in $A_1 \times \{0\}$. We may also construct the HTH bands so that these Σ_i 's lie in the same component of $\overline{P \times I - S_n}$. We may also assume that, for each i , the two proper vertical arcs $\partial\gamma_i \times J$ are close to each other. Hence, similar to Examples 5.5 and 5.6 we can glue a small vertical band δ_i to each Σ_i and get a collection of disjoint vertical annuli $A_{\Sigma_i} = \Sigma_i \cup \delta_i$ ($i = 1, \dots, N$) properly embedded in the same component of $\overline{P \times I - S_n}$. The elements represented by these A_{Σ_i} 's in $\pi_1(P \times I)$ are conjugate. In fact, we can isotope these annuli A_{Σ_i} in $\overline{P \times I - S_n}$ so that $\pi(A_{\Sigma_i})$ is the same closed curve in P for all i , where $\pi : P \times I \rightarrow P$ is the projection. Furthermore, similar to Example 5.7, we can trivially thicken these Σ_i 's into a collection of embedded disjoint HTH bands with thickness h_1 .

Let Σ and A_Σ be the HTH band and the vertical annulus constructed in the examples above. So, after a small perturbation, we may assume $\pi(A_\Sigma)$ is an immersed essential closed curve in P , where $\pi : P \times I \rightarrow P$ is the projection. By Example 5.8, if w_1 and w_2 are large, we can choose N disjoint HTH bands Σ_i ($i = 1, \dots, N$) and N disjoint vertical annuli A_{Σ_i} . Moreover, after some isotopy, $\pi(A_{\Sigma_i})$ is the same curve in P for all i . Thus, regardless of the configurations of S_n , as long as n is large, there is a fixed finite set of immersed essential closed curves in P , denoted by \mathcal{C}_P , such that $\pi(A_{\Sigma_i})$ above is a curve in \mathcal{C}_P , up to isotopy.

The following lemma follows trivially from Lemma 4.10.

Lemma 5.9. *Let M , B , $\{S_n\}$ and μ be as in Lemma 4.9. Let P be a sub-surface of a leaf l of μ . Suppose P is a pair of pants and no component of ∂P bounds a disk in l . Let \mathcal{C}_P be the finite set of curves in P as above. Then, B can be split into a branched surface B_1 that carries μ and an infinite sub-sequence $\{S_{n_k}\}$ of $\{S_n\}$, such that no S_{n_k} contains any disk D with the property that $\pi(\partial D) = \pi(\gamma)$ for any $\gamma \in \mathcal{C}_P$.*

Proof. By the hypotheses, every curve $\gamma \in \mathcal{C}_P$ is essential in the leaf l . So, the lemma follows from Lemma 4.10. \square

Definition 5.10. Let S_n be a closed embedded surface carried by $N(B)$, and let ν be a subarc of an I -fiber of $N(B)$ with $\partial\nu \subset S_n$. We say that ν bounds a monogon if there is an embedded disk E such that $\partial E = \nu \cup \alpha$, where $\alpha \subset S_n$ and $\partial\alpha = \partial\nu$. We call the disk E a *monogon*, see Figure 6.1(b) for a picture. We call E an *innermost monogon* if $E \cap S_n = \alpha$. Since $\nu \subset N(B)$, we may assume that a neighborhood of ν in E is a sub-disk $\kappa = a \times J$ of E such that each $\{x\} \times J$ is a subarc of an I -fiber of $N(B)$, $a \times \partial J \subset \alpha \subset \partial E$, and ν is a component of $\partial a \times J$. We call κ the *tail* of the monogon. We define the *thickness* of the tail to be $|S_n \cap \nu|$ and

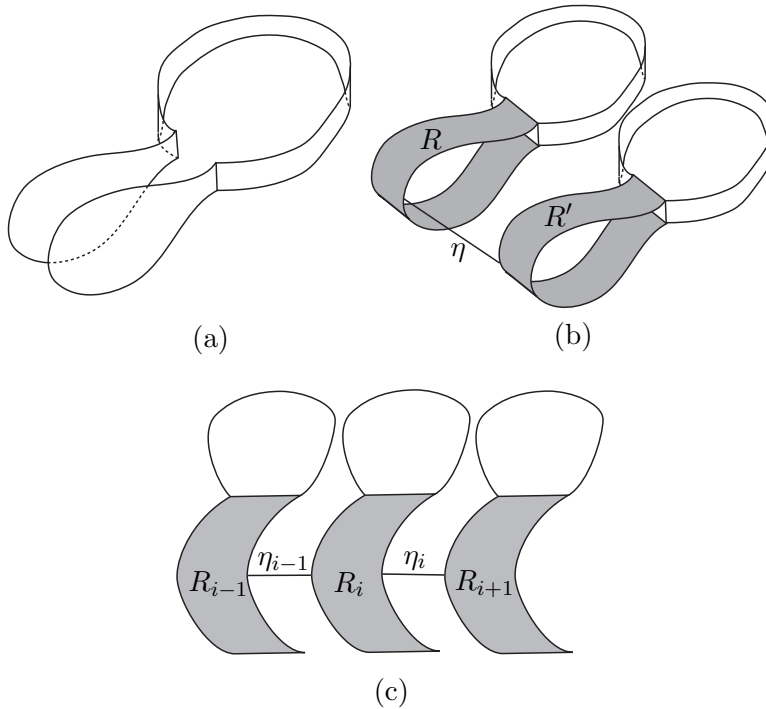

FIGURE 5.4.

define the length of the tail to be the length of a component of $a \times \partial J$. So, if E is innermost, the thickness of the tail is 2. Let $\Sigma = \gamma \times J$ be an HTH band constructed in Examples 5.5, 5.6 and 5.7, and let ν be a component of $\partial\gamma \times J$. Suppose ν bounds a monogon E disjoint from Σ . Then, we can glue Σ and two parallel copies of E together, forming an embedded disk Δ as shown in Figure 5.4 (a). By our construction, $\partial\Delta$ is a simple closed curve in S_n . We call the disk Δ constructed in this fashion a *pinched disk*. Since Δ is constructed using parallel copies of E , there is a rectangle $R \subset S_n$ between the two monogons, see the shaded regions of Figure 5.4(b). Let Σ' be another HTH band constructed in Example 5.8. We can glue Σ' and another two parallel copies of E together, forming an embedded disk Δ' . Similarly, there is a rectangle $R' \subset S_n$ between the two monogons, as shown in Figure 5.4 (b). By our construction in Example 5.8, $\Delta \cap \Delta' = \emptyset$ and $R \cap R' = \emptyset$. Moreover, there is a short arc $\eta \subset S_n$ connecting R to R' , as shown in Figure 5.4(b). We call such an arc η constructed in this fashion an *η -arc*.

Remark 5.11. Let Σ , Δ and R be as in Definition 5.10. We can denote $R = \alpha \times \beta$, where α and β are intervals, and suppose $R \cap \Delta = \alpha \times \partial\beta \subset \partial\Delta$. Moreover, $(\partial\Delta - \alpha \times \partial\beta) \cup (\partial\alpha \times \beta)$ is exactly the boundary of the annulus A_Σ constructed in Examples 5.5 and 5.6.

Lemma 5.12. *Let M , μ , P , B_1 and $\{S_{n_k}\}$ be as in Lemma 5.9. Suppose $P \times I$ is embedded in $N(B_1)$ with each $\{x\} \times I$ a subarc of an I -fiber of $N(B_1)$. Suppose $S_{n_k} \cap (P \times I)$ is a surfaces as described in Example 5.4 and we assume the two winding numbers w_1 and w_2 are large enough. Let $\Sigma = \gamma \times J$ be an HTH band constructed in the examples above. Suppose the arcs $\partial\gamma \times J$ bound a pair of parallel embedded monogons E_1 and E_2 in $M - P \times (\epsilon, 1]$, where $\epsilon \in I$ is a small number such that $\partial\gamma \times J \subset P \times [0, \epsilon]$. As in Definition 5.10, let $\Delta = E_1 \cup \Sigma \cup E_2$ be an embedded pinched disk with $\partial\Delta \subset S_{n_k}$. Then, $\partial\Delta$ is essential in S_{n_k} .*

Proof. By our construction, we can glue a small rectangle δ to Σ and form an embedded annulus A_Σ with $\partial A_\Sigma \subset S_{n_k}$. By Lemma 5.9, ∂A_Σ is a pair of essential curves in S_{n_k} . Note that, since E_1 and E_2 may not be innermost monogons, $\Delta \cap S_{n_k}$ may contain other circles.

Since E_1 and E_2 are parallel monogons, there is a thin rectangles $R \subset S_{n_k}$ between ∂E_1 and ∂E_2 , and $E_1 \cup E_2 \cup \delta \cup R$ is an embedded 2-sphere in M , see the shaded region in Figure 5.4 (b) for a picture of R .

Since the two winding numbers w_1 and w_2 in Example 5.4 are large, we may assume the number ϵ in the lemma is very small. Hence, as in Example 5.8, we can find another disjoint HTH band $\Sigma' = \gamma' \times J$ and construct an annulus $A_{\Sigma'}$ by gluing a small rectangle δ' to Σ' . By Lemma 5.9, $\partial A_{\Sigma'}$ is also essential in S_{n_k} . Moreover, we can choose Σ' so that $\partial\gamma' \times J$ bounds a pair of monogons E'_1 and E'_2 that are parallel to E_1 and E_2 . Similarly, $\Delta' = E'_1 \cup \Sigma' \cup E'_2$ is also an embedded disk with $\partial\Delta' \subset S_{n_k}$.

Similar to R , there is also a thin rectangles $R' \subset S_{n_k}$ between $\partial E'_1$ and $\partial E'_2$. Moreover, by our construction, $R \cap R' = \emptyset$. Since the 4 monogons E_1 , E_2 , E'_1 , E'_2 are parallel to each other, there is a short arc $\eta \subset S_{n_k}$ outside $P \times I$ connecting R to R' , as shown in Figure 5.4 (b), where the two shaded regions are R and R' .

Now, suppose $\partial\Delta$ is a trivial curve in S_{n_k} , and we use D to denote the disk in S_{n_k} bounded by $\partial\Delta$. By Remark 5.11, $R \cap \partial\Delta$ is a pair of opposite edges of R , and the union of the other pair of opposite edges of R and $\partial\Delta - R$ is ∂A_Σ . Since ∂A_Σ is essential in S_{n_k} , the rectangle R must lie in $S_{n_k} - \text{int}(D)$. Hence, the arc η must lie inside D . Since $R \cup \partial\Delta$ is disjoint from $R' \cup \partial\Delta'$, $R' \cup \partial\Delta'$ must lie in D . This implies $\partial A_{\Sigma'}$ lies in D and hence is trivial in S_{n_k} , contradicting our assumptions. \square

6. PROOF OF THE MAIN THEOREM

Suppose M is a closed orientable irreducible and non-Haken 3-manifold and M is not a Seifert fiber space. By Theorem 2.1, M has a finite collection of branched surfaces such that,

- (1) each branched surface in this collection is obtained by gluing together normal disks and at most one almost normal piece with respect to a fixed triangulation,

- (2) up to isotopy, every strongly irreducible Heegaard surface is fully carried by a branched surface in this collection.
- (3) no branched surface in this collection carries any normal 2-sphere or normal torus.

The goal of this section is to prove Theorem 6.1. It is clear that Theorem 6.1 and Theorem 2.1 imply the main theorem.

Theorem 6.1. *Suppose M is a closed, orientable, irreducible and non-Haken 3-manifold. Let B be a branched surface in Theorem 2.1. Then, B carries only finitely many irreducible Heegaard surfaces, up to isotopy.*

Proof. Each closed surface fully carried by B corresponds to an positive integer solution to the branch equations. Since the projective lamination space $\mathcal{PL}(B)$ is compact, if B fully carries an infinite number of distinct strongly irreducible Heegaard surfaces, then there is an accumulation point in the projective lamination space, which corresponds to a measured lamination μ . We may consider μ as the limit of these Heegaard surfaces, see section 4. Our goal is to show that μ is also an essential lamination, and by Proposition 3.8, M is Haken, which contradicts our hypothesis.

Because of Theorem 3.1, we divide the proof into two parts. Part A is the case that μ is an exceptional minimal lamination and Part B is the case is that μ is a closed surface. The proofs for the two cases are slightly different.

Part A. μ is an exceptional minimal measured lamination.

The main task is to prove the following lemma.

Lemma 6.2. *μ is incompressible in M .*

Proof of Lemma 6.2. Suppose $\{S_n\}$ is an infinite sequence of strongly irreducible Heegaard surfaces fully carried by B and μ is the limit point of $\{S_n\}$ in $\mathcal{PL}(B)$. The lamination μ is carried by B , but it may not be fully carried by B . Let B^- be the sub branched surface of B that fully carries μ . By Corollary 4.3, μ must be a normal lamination. Hence, B^- does not contain the almost normal piece and every surface carried by B^- is normal. So, by our hypotheses, B^- does not carry any 2-sphere or torus.

We may assume $N(B^-) \subset N(B)$ has the induced I -fiber structure. By Proposition 4.6, we can arbitrarily split B^- along μ and then split B accordingly so that the resulting branched surface still carries an infinite sub-sequence of $\{S_n\}$. Therefore, by Proposition 4.6 and Lemma 3.7, after splitting B and B^- and taking an infinite sub-sequence of $\{S_n\}$, we may assume no component of $\partial_h N(B^-)$ is a disk and each leaf of μ is π_1 -injective in $N(B^-)$.

After some isotopy, we may assume $\partial_h N(B^-) \subset \mu$. Suppose μ is compressible and let D be a compressing disk. After some splittings on B and B^- as in Proposition 4.6, we may assume $\partial_h N(B^-)$ is compressible and D is a compressing disk in $M - \text{int}(N(B^-))$.

So, $\gamma_1 = \partial D$ is an essential curve in a leaf l of μ . Since μ has no holonomy, there is a vertical annulus V in $N(B^-)$ such that V contains γ_1

and $\mu \cap V$ is a union of parallel circles. Thus, after some splittings on B^- and B as in Proposition 4.6 and Remark 4.8, we may assume $\pi(\gamma_1)$ is a simple closed curve in $B^- - L^-$ and $V = \pi^{-1}(\pi(\gamma_1))$, where $\pi : N(B^-) \rightarrow B^-$ is the collapsing map and L^- is the branch locus of B^- .

By Lemma 4.9, after some splittings and taking a sub-sequence of $\{S_n\}$, we may assume that $S_n \cap V$ does not contain any circle that is trivial in S_n , for each n . Since γ_1 bounds an embedded disk in M , by Lemma 2.6, if $S_n \cap V$ consists of circles, then each circle bounds a compressing disk in one of the two handlebodies. However, if $S_n \cap V$ consists of circles, by Corollary 4.2 and Example 5.2, the number of circles in $S_n \cap V$ tends to infinity as n tends to infinity. This gives a contradiction to Lemma 2.4. Therefore, $S_n \cap V$ cannot be a union of circles if n is large enough. So, we may assume $S_n \cap V$ consists of spirals.

Since every leaf is dense, $l \cap V$ contains an infinite number of circles. Since B^- does not carry any torus, by Proposition 2.2 and our assumptions on $N(B^-)$ above, there must be a circle $\gamma_2 \subset l \cap V$ such that γ_2 is nontrivial and not homotopic to γ_1 in l . Let $\gamma_i \times I \subset V$ ($i = 1, 2$) be a pair of disjoint small vertical annuli such that $\gamma_i \subset \gamma_i \times I$ and $\mu \cap (\gamma_i \times I)$ is a union of parallel circles. Let $\alpha \subset l$ be a simple arc connecting γ_1 to γ_2 and $\Gamma = \gamma_1 \cup \alpha \cup \gamma_2$ be a 1-complex in l . By choosing $\gamma_i \times I$ to be thin enough, we may assume $\gamma_1 \times I$ and $\gamma_2 \times I$ are connected by a rectangle $\alpha \times I$, forming an embedded 2-complex $\Gamma \times I$ with each $\{x\} \times I$ ($x \in \Gamma$) a subarc of an I -fiber of $N(B^-)$. By our construction, $\mu \cap (\Gamma \times I)$ is a union of 1-complexes parallel to Γ .

Let $A_i \subset l$ ($i = 1, 2$) be a small annular neighborhood of γ_i in l , Q be a small neighborhood of α in l , and $P = A_1 \cup Q \cup A_2$ be a small neighborhood of Γ in l . We can extend $\Gamma \times I$ to a product $P \times I \subset N(B^-)$. So, $\mu \cap (P \times I)$ is a union of compact surfaces parallel to P . Moreover, since γ_1 and γ_2 are not homotopic in l , P is an essential sub-surface of l .

Since every leaf is dense in μ , after some splittings along μ , we may assume $\pi(P) \subset B^- - L^-$ and $P \times I = \pi^{-1}(\pi(P \times I))$, where $\pi : N(B^-) \rightarrow B^-$ is the collapsing map and L^- is the branch locus of B^- . By Proposition 4.6, we may split B accordingly and assume B still carries an infinite sequence of Heegaard surfaces $\{S_n\}$ whose limit lamination is μ .

By the construction above, we may consider $\mu \cap (P \times I)$ as the limit lamination of the sequence $\{S_n \cap (P \times I)\}$. Since $S_n \cap V$ consists of spirals and $\gamma_i \times I \subset V$, we may assume $S_n \cap (A_i \times I)$ is a union of spiraling disks as described in Example 5.4. We use the same notations as section 5, and in particular, let h_i be the number of components of $S_n \cap (A_i \times I)$. Since $\gamma_1 \times I$ and $\gamma_2 \times I$ are disjoint sub-annuli of V before the splitting, we may assume the spirals in $S_n \cap V$ wind around both $\gamma_i \times I$ many times. So, the spirals in $S_n \cap (\gamma_i \times I)$ are part of longer spirals in $S_n \cap V$. Hence, the discrepancies (see section 5 for the definition of discrepancy) of the spirals in $S_n \cap (\gamma_i \times I)$ ($i = 1, 2$) are the same. Therefore, we have $h_1 = h_2$.

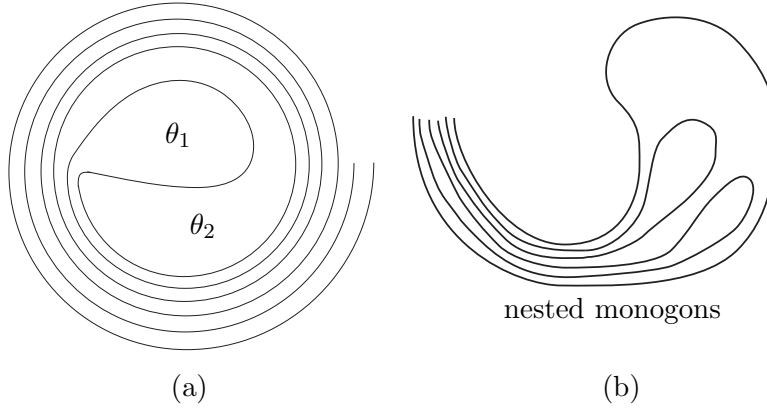

FIGURE 6.1.

By Lemma 5.9, after some splittings and taking a sub-sequence of $\{S_n\}$, we may assume that no S_n contains a disk E with the property that $\pi(\partial E) = \pi(\gamma)$ for any curve $\gamma \in \mathcal{C}_P$, where \mathcal{C}_P is as in Lemma 5.9.

Recall that γ_1 bounds a compressing disk D in $M - \text{int}(N(B^-))$. Let $\hat{D} = D \cup (\gamma_1 \times I)$, where $\gamma_1 \times I \subset P \times I$. By our construction above, \hat{D} is an embedded disk in M . As S_n is a compact surface, $S_n \cap \hat{D}$ must produce a monogon with a long “tail” spiraling around $\gamma_1 \times I$, as shown in Figure 6.1 (a). In fact, there are at least 2 monogons as the θ_1 and θ_2 in Figure 6.1 (a). Note that $\hat{D} \cap S_n$ may contain circles.

We will first consider the case that $\hat{D} \cap S_n$ does not contain any circle.

Case 1. $\hat{D} \cap S_n$ does not contain any circle.

Since S_n is a separating surface, we may assume each h_i (i.e. the number of components in $S_n \cap (A_i \times I)$) is an even number. Since $h_1 = h_2$, we have the following 2 subcases.

Subcase 1a. $h_1 \geq 4$.

Since $h_1 \geq 4$, $\hat{D} \cap S_n$ contains at least two curves. Note that each curve of $\hat{D} \cap S_n$ cuts \hat{D} into 2 monogons, as the θ_1 and θ_2 in Figure 6.1 (a). Thus, we can find a monogon E which is not innermost, but each monogon in the interior of E is innermost, as shown in Figure 6.1(b). Let h_E be the thickness of the tail of E and clearly $h_E \leq h_1$.

Let E_1 and E_2 be two parallel copies of E . Since $h_E \leq h_1$, by Example 5.7, we can connect the tails of E_1 and E_2 using an HTH band $\hat{\Sigma}$ with thickness h_E . We denote $E_1 \cup \hat{\Sigma} \cup E_2$ by Δ . So, Δ is an embedded disk with $\partial\Delta \subset S_n$. Let c_1, \dots, c_m be the components of $S_n \cap \text{int}(\Delta)$, and let Δ_i be the disk in Δ bounded by c_i . Similar to Δ , each Δ_i is the union of a sub-band of $\hat{\Sigma}$ and two parallel copies of a sub-monogon of E . Since we have assumed each sub-monogon in $\text{int}(E)$ is innermost, $\Delta_i \cap S_n = \partial\Delta_i$. By Lemma 5.12 and our assumptions above, $\partial\Delta$ and each $\partial\Delta_i$ are essential curves in S_n . So, each Δ_i is a compressing disk in a handlebody, say

H_1 . By Lemma 2.6, $\partial\Delta$ must bound a disk in a handlebody. Since the Heegaard splitting is strongly irreducible, $\partial\Delta$ must bound a compressing disk in H_1 as well. So, $P_\Delta = \Delta - \cup_{i=1}^m \text{int}(\Delta_i)$ is a planar surface properly embedded in H_2 . If P_Δ is compressible in H_2 , then we can compress P_Δ into a collection of disjoint incompressible planar surface P_1, \dots, P_s . By Corollary 2.8, each P_i is ∂ -parallel in H_2 . Let Q_i be the sub-surface of S_n that is parallel to P_i in H_2 . Since the P_i 's are disjoint, any two surfaces Q_i and Q_j are either disjoint or nested in S_n .

By Example 5.8, we can construct another HTH band $\hat{\Sigma}'$ with thickness h_E , connecting two monogons E'_1 and E'_2 , where E'_1 and E'_2 are also two parallel copies of E . We use Δ' to denote the disk $E'_1 \cup \hat{\Sigma}' \cup E'_2$. By our construction $\Delta \cap \Delta' = \emptyset$. Similar to Δ , $\Delta' \cap S_n$ is a union of circles c'_1, \dots, c'_m and the disk Δ'_i in Δ' bounded by c'_i is a compressing disk for the handlebody H_1 . Similarly, we can compress the planar surface $\Delta' - \cup_{i=1}^m \text{int}(\Delta'_i)$ into a collection of incompressible planar surfaces P'_1, \dots, P'_t . Since $\Delta \cap \Delta' = \emptyset$, we may assume these P_i 's and P'_j 's are all disjoint in H_2 . So, each P'_i is also ∂ -parallel in H_2 and we use Q'_i to denote the sub-surface of S_n that is parallel to P'_i . Since these planar surfaces P_i 's and P'_j 's are disjoint and ∂ -parallel, any two surfaces Q_i and Q'_j are either disjoint or nested in S_n .

To unify notations, we also denote $\Delta, \partial\Delta, \Delta', \partial\Delta'$ by $\Delta_0, c_0, \Delta'_0, c'_0$ respectively.

By our construction above, for each $c_i = \partial\Delta_i$ (resp. c'_i), there is a rectangle $R_i = \alpha_i \times \beta_i$ (resp. $R'_i = \alpha'_i \times \beta'_i$) in S_n , see the shaded region in Figure 5.4(b), such that $R_i \cap c_i$ (resp. $R'_i \cap c'_i$) is a pair of opposite edges $\alpha_i \times \partial\beta_i$ (resp. $\alpha'_i \times \partial\beta'_i$). Moreover, these R_i and R'_j are pairwise disjoint. By our construction in section 5, $(c_i - \alpha_i \times \partial\beta_i) \cup (\partial\alpha_i \times \beta_i)$ (resp. $(c'_i - \alpha'_i \times \partial\beta'_i) \cup (\partial\alpha'_i \times \beta'_i)$) is the boundary of an embedded vertical annulus A_{Σ_i} (resp. $A_{\Sigma'_i}$) in $P \times I$, and by our assumptions, ∂A_{Σ_i} (resp. $\partial A_{\Sigma'_i}$) is a pair of essential curves in S_n .

Let W_i (resp. W'_i) be the closure of a small neighborhood of $c_i \cup R_i$ (resp. $c_i \cup R_i$) in S_n . So, two boundary circles of W_i (resp. W'_i) are parallel to the two components of ∂A_{Σ_i} (resp. $\partial A_{\Sigma'_i}$) above, and the other boundary component of W_i (resp. W'_i) is parallel to c_i (resp. c'_i). So, by our assumptions above, each boundary circle of W_i (resp. W'_i) is an essential curve in S_n . Moreover, there is an η -arc (see Definition 5.10) $\eta_i \subset S_n$ connecting R_i to R'_i , as shown in Figure 5.4 (b).

Let Q_i be a planar surface as above, and suppose c_0, \dots, c_s are the boundary components of Q_i . Next, we will show that at least one R_j ($0 \leq j \leq s$) lying in $S_n - \text{int}(Q_i)$. Otherwise, suppose $R_j \subset Q_i$ for every j . Then, for each j , $\partial\alpha_j \times \beta_j$ is a pair of arcs properly embedded in Q_i . Since Q_i is a planar surface and since there is a rectangle R_j attached to each c_j , by an innermost-surface argument, it is easy to see that, for some j , $\partial\alpha_j \times \beta_j$ is a pair of ∂ -parallel arcs in Q_i . This implies that a

boundary component of W_j bounds a disk in Q_i and hence is trivial in S_n , contradicting our assumptions. This argument also holds for each Q'_i . Therefore, for each Q_i (resp. Q'_i), there is always such a rectangle R_j (resp. R'_j), lying outside $\text{int}(Q_i)$ (resp. $\text{int}(Q'_i)$) and with two opposite edges in ∂Q_i (resp. $\partial Q'_i$).

Let Q_i be any planar surface above. Suppose c_k is a boundary circle of Q_i and suppose $R_k = \alpha_k \times \beta_k$ is a rectangle outside $\text{int}(Q_i)$. So, $R_k \cap Q_i = R_k \cap c_k = \alpha_k \times \partial\beta_k$. By our construction before, there is an arc η_k connecting R_k to R'_k , and $\text{int}(\eta_k)$ is disjoint from any c_j or c'_j . Moreover, the two boundary points of η_k lie in $\alpha_k \times \partial\beta_k \subset c_k$ and $\alpha'_k \times \partial\beta'_k \subset c'_k$. Suppose c'_k is a boundary component of Q'_j . Since R_k lies outside $\text{int}(Q_i)$, η_k must lie in Q_i . Hence, $c'_k \subset Q_i$. Since the planar surfaces Q_i and Q'_j are either disjoint or nested, $c'_k \subset Q_i$ implies that $Q'_j \subset Q_i$. This means that for each Q_i , there is some Q'_j such that $Q'_j \subset Q_i$.

However, we can apply the same argument on Q'_i and conclude that, for each Q'_i , there is some Q_k such that $Q_k \subset Q'_i$. This is impossible because there is always an innermost planar surface among these Q_i 's and Q'_j 's.

Subcase 1b. $h_1 = 2$.

In this case, $S_n \cap \hat{D}$ is basically a single curve with both ends wrapping around $\gamma_1 \times I$, as shown in Figure 6.1(a). So, we have two innermost monogons θ_1 and θ_2 in the different handlebodies. After a small perturbation in a small neighborhood of \hat{D} , we may assume $\partial\theta_1$ and $\partial\theta_2$ are disjoint in S_n . As in Examples 5.8, we can find two disjoint HTH bands Σ_1 and Σ_2 , such that Σ_i ($i = 1, 2$) connects two parallel copies of θ_i forming a pinched disk Δ_i . By Lemma 5.12 and our construction, Δ_1 and Δ_2 are compressing disks in different handlebodies and $\partial\Delta_1 \cap \partial\Delta_2 = \emptyset$, which contradicts the assumption that S_n is a strongly irreducible Heegaard surface.

Case 2. $\hat{D} \cap S_n$ contains circles.

Similar to Case 1, each non-circular curve cuts \hat{D} into a pair of monogons, though there may be circles in the monogons. We say a monogon E is innermost, if E does not contain other monogon, but E may contain circles in $\hat{D} \cap S_n$. We first consider innermost monogons. Let E be an innermost monogon and let c_1, \dots, c_K be the outermost circles in $E \cap S_n$. Since the sequence of surfaces $\{S_n\}$ are carried by B , by assuming \hat{D} to be transverse to B , it is easy to see that the number of such outermost circles c_1, \dots, c_K is bounded from above by a number independent of S_n . Since we assume n is large, the winding number w_i of the spiraling disks in $A_i \times I$ is large. So, by Example 5.8, we can find a large number of disjoint HTH bands $\Sigma_1, \dots, \Sigma_N$. Moreover, we can take $2N$ parallel copies of E , denoted by $E_1, E'_1, \dots, E_N, E'_N$, so that the disks $\Delta_i = E_i \cup \Sigma_i \cup E'_i$ are disjoint and embedded in M . By Lemma 5.12, we may assume each $\partial\Delta_i$ is an essential curve in S_n . Since K is bounded by a number independent of S_n , we may assume N is much larger than K , and this is a key point in the proof.

Between each pair E_i and E'_i , there is a rectangle $R_i \subset S_n$ with two opposite edges in ∂E_i and $\partial E'_i$, see the shaded region in Figure 5.4 (b). By the construction in section 5, we may assume there is an η -arc (see Definition 5.10) η_i connecting R_i to R_{i+1} for each $i = 1, \dots, N-1$, as shown in Figure 5.4 (c). The interior of each η_i is disjoint from these disks Δ_j 's.

If c_i is a trivial curve in S_n , since M is irreducible, we can perform some isotopy on E (fixing ∂E) and get a monogon disk with fewer circles in $E \cap S_n$. So, we may assume each c_i is essential in S_n . By Lemma 2.6, each circle c_i bounds a compressing disk in a handlebody. Let d_i be the disk in the monogon E bounded by c_i ($i = 1, \dots, K$), and suppose $E - \cup_{i=1}^K d_i$ lies in H_1 . If some c_i bounds a disk in H_1 , then we can replace d_i by a disk in H_1 and obtain a monogon with fewer circles. If we can eliminate all the outermost circles c_i 's in this fashion, then we get an innermost monogon disk E with $\text{int}(E) \cap S_n = \emptyset$. By our construction, we may assume these isotopies and surgeries on E above do not affect the HTH bands Σ_i 's. Hence, after these isotopies and surgeries, each Δ_i is still an embedded disk in M . Suppose we cannot eliminate these circles c_i . Then, by the arguments above, we may assume each c_i bounds a compressing disk in H_2 .

The arguments next involve compression bodies and strongly irreducible Heegaard splittings for manifold with boundary. We refer to [4] for definitions and fundamental results.

Let W be the 3-manifold obtained by adding K 2-handles to H_1 along these c_i 's, and let \hat{W} be the manifold obtained by capping off the 2-sphere components of ∂W by 3-balls. Since each Δ_i is constructed using parallel copies of E , we may assume each Δ_i is a properly embedded disk in W . Note that after pushing S_n into $\text{int}(\hat{W})$, S_n becomes a Heegaard surface for \hat{W} , bounding the handlebody H_1 on one side and a compression body W_2 on the other side. Since each c_i bounds a compressing disk in H_2 and $M = H_1 \cup_{S_n} H_2$ is strongly irreducible, by [4], the Heegaard splitting $\hat{W} = H_1 \cup_{S_n} W_2$ is also strongly reducible. By our assumption on E above, at least one 2-handle is added to H_1 and hence W_2 is not a trivial compression body. Thus, by a theorem of Casson and Gordon (Theorem 2.1 of [4]), \hat{W} is irreducible, and if $\partial \hat{W} \neq \emptyset$, $\partial \hat{W}$ is incompressible in \hat{W} . Therefore, each $\partial \Delta_i$ bounds a disk D_i in ∂W ($i = 0, 1, \dots, N$).

Since W is obtained by attaching K 2-handles to H_1 , there are $2K$ disjoint disks m_1, \dots, m_{2K} in $\partial W - S_n$ parallel to the cores of these 2-handles. Note that one can obtain the handlebody H_2 by attaching 1-handles to $M - \text{int}(W)$ along these disks m_i 's. Since each $\partial \Delta_i = \partial D_i$ is essential in S_n , each disk $D_i \subset \partial W$ ($i = 0, 1, \dots, N$) must contain some m_j ($1 \leq j \leq 2K$). Recall that K is bounded by a number independent of S_n and we have assumed that N is very large compared with K . Since each D_i contains some m_j , for any integer p , if N is large enough, there

exist a sequence of p nested disks $D_{a_1} \subset D_{a_2} \subset \dots \subset D_{a_p}$ ($0 \leq a_i \leq N$). Note that if $p > 2K$, at least one annulus $D_{a_{i+1}} - D_{a_i}$ does not contain any disk m_j . So, by assuming N is large enough, one can find 3 nested disks, say $D_1 \subset D_2 \subset D_3$, such that the two annuli $D_3 - \text{int}(D_2)$ and $D_2 - \text{int}(D_1)$ do not contain any disk m_i .

Recall that $\partial D_2 = \partial \Delta_2$ and there is a rectangle $R_2 \subset S_n$ with two opposite edges attached to $\partial \Delta_2$. By the construction of W , we also have $R_2 \subset \partial W$. Moreover, $\text{int}(R_2)$ is disjoint from the circles $\partial \Delta_j$'s. So, R_2 lies in one of the two annuli, $D_3 - \text{int}(D_2)$ or $D_2 - \text{int}(D_1)$. Let $W(\partial \Delta_2 \cup R_2)$ be the closure of a small neighborhood of $\partial \Delta_2 \cup R_2$ in S_n . By our assumptions before, each boundary circle of $W(\partial \Delta_2 \cup R_2)$ is essential in S_n . Since the two annuli $D_3 - \text{int}(D_2)$ and $D_2 - \text{int}(D_1)$ do not contain any disk m_i , one boundary circle of $W(\partial \Delta_2 \cup R_2)$ must be a trivial circle in both ∂W and S_n , which contradicts our constructions and assumptions on the R_i 's before.

The arguments above shows that, for any innermost monogon E , after some isotopies, we can eliminate the circles c_i 's and have $\text{int}(E) \cap S_n = \emptyset$. Now, similar to Case 1, we have two subcases.

Subcase 2a. $h_1 = 2$.

In this subcase, $\hat{D} \cap S_n$ contains exactly one non-circular curve and this curve cuts \hat{D} into a pair of innermost monogons. So, by the arguments above on innermost monogons, we can eliminate all the circles in $\hat{D} \cap S_n$, and then the situation is the same as Subcase 1b.

Subcase 2b. $h_1 \geq 4$.

The proof for this subcase is a combination of the proof of Subcase 1a and the arguments on innermost monogons above. Similar to Subcase 1a, we can find a monogon E which is not innermost, but each monogon in the interior of E is innermost. As in Subcase 1a, by connecting two parallel copies of E and a thick HTH band Σ , we get a pinched disk Δ (see Definition 5.10), with $\partial \Delta \subset S_n$. Let $\epsilon_1, \dots, \epsilon_k$ be the monogons in $\text{int}(E)$. Then, the corresponding parallel copies of ϵ_i and a sub-band of Σ form a pinched disk $\Delta_i \subset \Delta$ ($i = 1, \dots, k$). By Lemma 5.12 and our assumptions before, $\partial \Delta$ and each $\partial \Delta_i$ are essential in S_n . By the arguments on innermost monogons, after some isotopy, we may assume $S_n \cap \text{int}(\epsilon_i) = \emptyset$ and each Δ_i is a compressing disk in a handlebody. Since S_n is strongly irreducible, these Δ_i 's are compressing disks in the same handlebody, say H_2 .

Let c_1, \dots, c_K be the outermost circles in $E \cap S_n$. As above, K is bounded by a number independent of S_n . By our assumption on innermost monogons, these c_i 's lie in $E - \cup_{i=1}^k \epsilon_i$. By the construction of the pinched disks, $S_n \cap (\Delta - \cup_{i=1}^k \Delta_i)$ has $2K$ outermost circles c_1, \dots, c_K and c'_1, \dots, c'_K , where each c'_i is parallel to c_i in S_n . As before, we may assume each c_i is an essential curve in S_n . Let d_i (resp. d'_i) be the disk in Δ bounded by c_i (resp. c'_i). We use P_Δ to denote the closure of $\Delta - \cup_{i=1}^k \Delta_i - \cup_{i=1}^K d_i - \cup_{i=1}^K d'_i$. So, P_Δ is a properly embedded planar

surface in the handlebody H_1 , and by our previous assumptions, each component of ∂P_Δ is essential in S_n . So, by Lemma 2.6, each circle in ∂P_Δ bounds a compressing disk in a handlebody. Since each $\partial \Delta_i$ bounds a disk in H_2 and the Heegaard surface S_n is strongly irreducible, each component of ∂P_Δ bounds a compressing disk in H_2 . By Lemma 2.8, if P_Δ is incompressible in H_1 , then P_Δ is ∂ -parallel in H_1 .

Similar to the arguments for the innermost monogons, we can take $2N$ parallel copies of E and use N disjoint HTH bands to construct N pinched disks, $\tilde{\Delta}_1, \dots, \tilde{\Delta}_N$. Since these pinched disks are constructed using parallel copies of the same monogon E , we may apply the arguments for Δ and P_Δ above on each of the N pinched disks $\tilde{\Delta}_1, \dots, \tilde{\Delta}_N$. Let P_1, \dots, P_N be the planar sub-surfaces of these N pinched disks constructed in the same way as the P_Δ above. In particular, each P_i is properly embedded in H_1 and each circle in ∂P_i bounds a compressing disk in H_2 . Each boundary circle of P_i is either the boundary of a pinched disk or a circle parallel to some c_j in S_n . To simplify notation, we assume each P_i is incompressible. The proof for the compressible case is the same after we compress the P_i 's into incompressible pieces, as in Subcase 1a. So, by Lemma 2.8, each P_i is ∂ -parallel in H_1 .

Let W be the 3-manifold obtained by adding K 2-handles to H_1 along these c_1, \dots, c_K . Since the N pinched disks are constructed using parallel copies of the same monogon E , each P_i can be extended to a properly embedded planar surface \hat{P}_i in W . \hat{P}_i can be considered as the planar surface obtained by capping off the c_i 's and c_i' 's by disks. So, by our assumption on ∂P_i , each boundary circle of \hat{P}_i is the boundary of a pinched disk which is either some $\tilde{\Delta}_j$ or a pinched disk in $\text{int}(\tilde{\Delta}_j)$ formed by innermost monogons.

By the construction in section 5, there is a rectangle in S_n with two opposite edges glued to the boundary of each pinched disk, as shown in the shaded regions in Figure 5.4 (b). Since these c_i 's are circles in E , by our construction, these rectangles are in ∂W . Hence, there is such a rectangle in ∂W attached to each boundary circle of \hat{P}_i . Moreover, for any two adjacent pinched disks, there is also a short η -arc connecting the two rectangles, as shown in Figure 5.4 (b). Similar to the argument on innermost monogons, we may assume these $\tilde{\Delta}_i$ have a natural order in the following sense: If R_i is a rectangle attached to a circle in $\partial \hat{P}_i$ with $2 \leq i \leq N - 1$, then as shown in Figure 5.4 (c), there are two arcs η_{i-1} and η_i connecting R_i to two rectangles R_{i-1} and R_{i+1} , where R_{i-1} (resp. R_{i+1}) is a rectangle attached to a circle in $\partial \hat{P}_{i-1}$ (resp. $\partial \hat{P}_{i+1}$). Therefore, we may assume that, if $i \neq 1$ and $i \neq N$, there are two η -arcs for each component of $\partial \hat{P}_i$, connecting the attached rectangle to $\partial \hat{P}_{i-1}$ and $\partial \hat{P}_{i+1}$, as shown in Figure 5.4 (c), where \hat{P}_{i-1} and \hat{P}_{i+1} are different planar surfaces. The fact that \hat{P}_{i-1} and \hat{P}_{i+1} are different surfaces is important to our proof.

Since each P_i is ∂ -parallel in H_1 , each \hat{P}_i must be ∂ -parallel in W . Let $Q_i \subset \partial W$ be the sub-surface of ∂W that is parallel to \hat{P}_i and with $\partial Q_i = \partial \hat{P}_i$. Since these \hat{P}_i 's are disjoint, any two planar surfaces Q_i and Q_j are either disjoint or nested.

Similar to the arguments on the innermost monogons, let m_1, \dots, m_{2K} be the $2K$ disks in $\partial W - S_n$ parallel to the cores of the 2-handles added to H_1 . Suppose some Q_k ($1 \leq k \leq N$) does not contain any disk m_i . Since any planar surface inside Q_k does not contain any disk m_i either, we may assume Q_k is innermost. Then, by the arguments in Subcase 1a on the Q_i 's, there is a rectangle R attached to ∂Q_k and lying in $S_n - \text{int}(Q_k)$. So, the η -arc attached to R must lie in Q_k and hence Q_k must contain another planar surface Q_j ($j \neq k$), which contradicts the assumption that Q_k is innermost. So, we may assume each Q_k contains some disk m_i .

Since K is bounded by a number independent of S_n , similar to the arguments on the innermost monogons above, if N is large enough, we can find 3 nested planar surfaces, say $Q_{n_1} \subset Q_{n_2} \subset Q_{n_3}$, such that $Q_{n_3} - Q_{n_2}$ and $Q_{n_2} - Q_{n_1}$ do not contain any disk m_i . Moreover, if N is large, we can find many such nested planar surfaces so that $n_2 \neq 1$ and $n_2 \neq N$. Since each Q_k contains some disk m_i , $Q_{n_3} - Q_{n_2}$ and $Q_{n_2} - Q_{n_1}$ do not contain any other planar surface Q_k . Moreover, we can choose the Q_{n_1} , Q_{n_2} and Q_{n_3} so that there is no Q_k satisfying $Q_{n_1} \subset Q_k \subset Q_{n_2}$ or $Q_{n_2} \subset Q_k \subset Q_{n_3}$.

Let α be a boundary circle of Q_{n_2} . Since Q_{n_3} is a planar surface and $Q_{n_2} \subset Q_{n_3}$, α is separating in Q_{n_3} and bounds a sub-surface Q_α in Q_{n_3} . We can choose α so that $Q_{n_2} \subset Q_\alpha$. Let R be the rectangle attached to this boundary circle α of Q_{n_2} . By our assumption on n_2 , there is a pair of η -arcs connecting the rectangle R to two different planar surfaces. However, by our assumptions on Q_{n_1} , Q_{n_2} , Q_{n_3} and α , if $R \subset Q_{n_2}$, both η -arcs must connect R to ∂Q_{n_3} ; if $R \subset S_n - \text{int}(Q_{n_2})$, both η -arcs must connect R to ∂Q_{n_1} , which contradicts previous assumption that the pair of η -arcs connect R to different \hat{P}_i 's, see Figure 5.4 (c). This finishes the proof Lemma 6.2. \square

Lemma 6.3. μ is end-incompressible.

Proof of Lemma 6.3. As before, by Proposition 4.6, we can split B^- and B so that B^- has no disk of contact and fully carried μ . We may also split B^- so that the number of component of $M - B^-$ is the smallest among all the branched surfaces fully carrying μ . After some isotopy, we may assume that $\partial_h N(B^-) \subset \mu$. Since μ is incompressible by Lemma 6.2, $\partial_h N(B^-)$ is incompressible in $M - \text{int}(N(B^-))$. Suppose μ is not end-incompressible and let E be a monogon in $M - \text{int}(N(B^-))$. Let \hat{E} be the component of $M - \text{int}(N(B^-))$ containing E . By Proposition 2.5, \hat{E} must be a solid torus of the form $E \times S^1$. Let L be the leaf that contains the horizontal boundary component of \hat{E} . Since $|M - B^-|$ is the smallest, we cannot split μ along L connecting \hat{E} to other components of $M - \text{int}(N(B^-))$.

We may assume L is an orientable surface. We claim that L must be an infinite annulus. If L is not an infinite annulus, we can construct a compressing disk for L by connecting two parallel copies of the monogon E and a long vertical band, as shown in Figure 5.4 (a), similar to the construction of a pinched disk before. Thus, L is an infinite annulus. Since B^- does not carry any 2-sphere or torus, this contradicts Lemma 3.4. \square

Since B^- does not carry any 2-sphere, Lemmas 6.2 and 6.3 imply that μ is an essential lamination. By Proposition 3.8, M is Haken, which contradicts the hypothesis. This finishes the proof for part A.

Part B. μ consists of compact leaves.

The only difference between the proofs for Part A and Part B is the construction of $P \times I$. By Theorem 3.1, we may assume μ is either a family of parallel orientable closed surfaces or a twisted family of parallel closed surfaces. In both cases, μ corresponds to a rational point in $\mathcal{PL}(B)$. For any non-orientable surface S carried by B , the boundary of a twisted I -bundle over S is an orientable closed surface carried by B and corresponding to the same point in $\mathcal{PL}(B)$ as S . Thus, by using the boundary of a twisted I -bundle if necessary, we may assume μ consists of parallel orientable closed surfaces. Let B^- be the sub branched surface of B fully carrying μ . By Proposition 4.6, we may split B^- into an orientable closed surface. Thus, we may assume B^- is an orientable closed surface and $N(B^-)$ is a product of an interval and the closed surface B^- . Moreover, by Corollary 4.3 and our assumptions on B before, B^- is a normal surface in M with genus at least 2.

Since M is non-Haken, there is a compressing disk D_1 for the closed surface B^- . Since the genus of B^- is at least 2, after compressing B^- along D_1 , we can find another compressing disk D_2 . Note that $\text{int}(D_2)$ may intersect B^- before the compression along D_1 . Nonetheless, we can always find two disjoint embedded disks D_1 and D_2 in M such that ∂D_1 and ∂D_2 are non-parallel essential simple closed curves in B^- , where D_1 is a compressing disk but $\text{int}(D_2)$ may intersect B^- . After choosing a different compressing disk D_1 if necessary, we can find an arc $\alpha \subset B^-$ connecting ∂D_1 to ∂D_2 such that $\text{int}(\alpha)$ does not intersect $D_1 \cup D_2$. Let A_i ($i = 1, 2$) be an annulus neighborhood of ∂D_i in B^- and Q be a small neighborhood of α in B^- . Then, $P = A_1 \cup Q \cup A_2$ is a subsurface of B^- . Since ∂D_1 and ∂D_2 are non-parallel essential curves, no boundary circle of P bounds any disk in B^- . Let $P \times I = \pi^{-1}(P)$ and $A_i \times I = \pi^{-1}(A_i)$ ($i = 1, 2$), where $\pi : N(B^-) \rightarrow B^-$ is the projection. We may consider P as the limit of $\{S_n \cap (P \times I)\}$. We will use this $P \times I$ to construct our HTH bands, as in section 5.

Let $\gamma_i = \partial D_i \subset A_i$. As before, we may assume the sequence of surfaces $\{S_n\}$ satisfy Lemma 5.9. By Lemma 4.9, we may assume $S_n \cap (\gamma_i \times I)$ ($i = 1, 2$) does not contain any circle that is trivial in S_n , for each n . As before, if $S_n \cap (\gamma_i \times I)$ consists of circles, then each circle is essential in

S_n and hence bounds a compressing disk in one of the two handlebodies by Lemma 2.6. However, if $S_n \cap (\gamma_i \times I)$ consists of circles, by Corollary 4.2 and Example 5.2, the number of circles in $S_n \cap (\gamma_i \times I)$ tends to infinity as n goes to infinity. This gives a contradiction to Lemma 2.4. So, $S_n \cap (\gamma_i \times I)$ cannot be a union of circles if n is large enough. Hence, we may assume $S_n \cap (\gamma_i \times I)$ consists of spirals for each n .

Therefore, we may assume $S_n \cap (A_i \times I)$ ($i = 1, 2$) consists of spiraling disks and $S_n \cap (P \times I)$ satisfies the conditions in Example 5.4. We use the same notations as section 5. Let h_i be the number of components of $S_n \cap (A_i \times I)$ ($i = 1, 2$), and we may assume n is sufficiently large. Since both γ_1 and γ_2 bound embedded disks in M , there is no difference between $A_1 \times I$ and $A_2 \times I$ in our construction. So, we may assume $h_1 \leq h_2$. Then, we can use Example 5.6 to construction our HTH bands. The remainder of the proof is the same as Part A. This finishes the proof of Theorems 6.1 and 1.1. \square

7. THE CASSON-GORDON EXAMPLE

Casson and Gordon gave an example of a 3-manifold that has an infinite family of strongly irreducible Heegaard splittings with different genera [5], see [13, 31]. By Theorem 1.1, such a 3-manifold must be Haken. In fact, it is easy to show that the 3-manifolds in the Casson-Gordon example are Haken. The proof of Theorem 1.1 indicates that there should be an incompressible surface as the limit of the infinite family of Heegaard surfaces. In this section, we construct such an incompressible surface.

Before carrying out the construction, we give a brief overview of the Casson-Gordon example and we refer to [13, 31] for more details. We first take a pretzel knot $K = (p_1, p_2, p_3, 1, p_4)$ in S^3 , where $|p_i| \geq 5$. The standard Seifert surface F_1 from the Seifert algorithm is a free Seifert surface. Let S be a 2-sphere in S^3 that cuts the knot into 2 tangles, as shown in Figure 7.1 (a). If we flip a tangle bounded by S along a horizontal axis by 180° , we get the same knot with a different projection $(p_1, -1, p_2, p_3, 1, 1, p_4)$. By a theorem of Parris [26], the standard Seifert surface F_2 from the Seifert algorithm is also a free Seifert surface with $genus(F_2) = genus(F_1) + 1$. By flipping the tangle k times, we get an infinite family of free Seifert surfaces $\{F_k\}$ with increasing genus.

Let $\eta(K)$ be a tubular neighborhood of the knot K and let $M_0 = S^3 - \eta(K)$ be the knot exterior. Let H_k be the closure of a small neighborhood of F_k in M_0 . So H_k is a handlebody. Since F_k is a free Seifert surface, $\overline{M_0 - H_k}$ is also a handlebody. Let $K(p/q)$ be the closed manifold obtained by the Dehn filling to M_0 along the slope p/q . We may regard H_k as a handlebody in $K(p/q)$. In fact, if $p = 1$, $K(1/q) - int(H_k)$ is also a handlebody and $S_k = \partial H_k$ is a Heegaard surface for $K(1/q)$. Casson and Gordon showed that [5, 13, 23], if $|q| \geq 6$, then this Heegaard splitting of

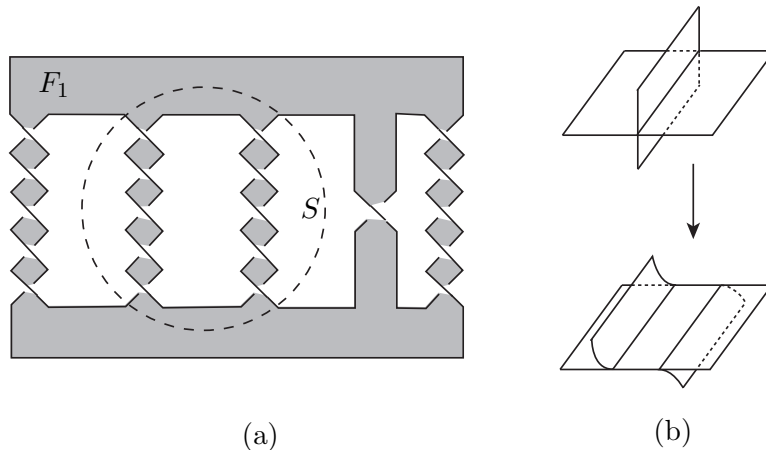

FIGURE 7.1.

$K(1/q)$ by $S_k = \partial H_k$ is strongly irreducible. So, we get an infinite family of strongly irreducible Heegaard surfaces $\{S_k\}$ for $M = K(1/q)$ ($|q| \geq 6$).

In [13], Kobayashi gave an interpretation of the sequence of free Seifert surfaces $\{F_k\}$ through branched surfaces. Let F_1 be the free Seifert surface of $M_0 = S^3 - \eta(K)$ above, and S the punctured 2-sphere as shown in Figure 7.1 (a). By fixing a normal direction for F_1 and S , we can deform $F_1 \cup S$ into a branched surface B_0 , as shown in Figure 7.1 (b). Both F_1 and S are carried by B_0 , so we can assume F_1 and S lie in $N(B_0)$, a fibered neighborhood of B_0 . Then, the canonical cutting and pasting on F_1 and S produce another Seifert surface $F_1 + S$. Kobayashi showed that $F_2 = F_1 + S$ is the same free Seifert surface described above. Moreover, $F_k = F_1 + (k - 1)S$.

As we mentioned before, the closed manifold $M = K(1/q)$ is Haken. The 2-sphere $S \subset S^3$ in Figure 7.1 (a) cuts (S^3, K) into a pair of non-trivial tangles (E_1, K_1) and (E_2, K_2) , where E_1 and E_2 are the pair of 3-balls in S^3 bounded by S and $K_i \subset E_i$ is a pair of strings. Let $\eta(K_1)$ be a small neighborhood of K_1 in E_1 . Then, $\Gamma = \partial(E_1 - \eta(K_1))$ is a close surface of genus 2 in $S^3 - K$. It is not hard to see that Γ is incompressible in $S^3 - K$ (for instance see [35]). By a theorem of Menasco [20], Γ remains incompressible after any non-trivial Dehn surgery on K .

Next we will show that Γ can be considered as the limit of the sequence of Heegaard surfaces $\{S_k\}$.

We start with the Seifert surface F_1 and consider $K = \partial F_1$. Let A be a thin annular neighborhood of ∂F_1 in F_1 and $F'_1 = F_1 - A$. So, F'_1 is isotopic to F_1 and $F'_1 \cap \Gamma = F_1 \cap \Gamma$. Let $\eta(F'_1)$ be a small neighborhood of F'_1 in $S^3 - K$. By the construction, we can consider the Heegaard surface S_1 of $M = K(1/q)$ as the boundary surface of the closure of $\eta(F'_1)$. $S_1 \cap \Gamma$ consists of closed curves.

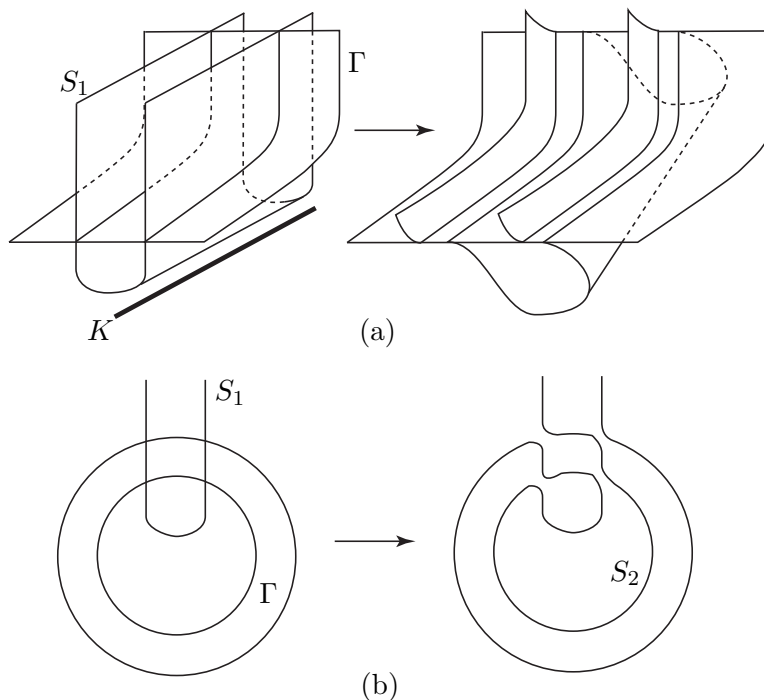

FIGURE 7.2.

Similar to the construction of the branched surface B_0 above, we can deform $S_1 \cup \Gamma$ into a branched surface B as shown in Figure 7.2 (a). B carries both S_1 and Γ , so we can assume Γ and S_1 lie in $N(B)$ and transverse to the I -fibers. Then, we perform the canonical cutting and pasting on S_1 and 2 parallel copies of Γ , as shown in Figure 7.2 (b). It is not hard to see that the resulting surface $S_1 + 2\Gamma$ is isotopic to S_2 . Similarly, $S_3 = S_2 + 2\Gamma$ and $S_k = S_1 + 2(k-1)\Gamma$. By our discussion on projective lamination spaces, Γ is indeed the limit of the sequence of Heegaard surfaces $\{S_k\}$.

REFERENCES

- [1] Ian Agol and Tao Li *An algorithm to detect laminar 3-manifolds*. *Geom. Topol.* 7 (2003) 287–309
- [2] M. Boileau and D.J. Collins and H. Zieschang, *Genus 2 Heegaard decompositions of small Seifert manifolds*. *Ann. Inst. Fourier (Grenoble)* 41 (1991), no. 4, 1005–1024.
- [3] F. Bonahon and J.P. Otal, *Scindements de Heegaard des espaces lenticulaires*, *Ann. Sci. Ec. Norm. Sup.* 16 (4) (1983) 451–466
- [4] Andrew Casson and Cameron Gordon, *Reducing Heegaard splittings*. *Topology and its Applications*, 27 275–283 (1987).
- [5] Andrew Casson and Cameron Gordon, unpublished.
- [6] William Floyd and Ulrich Oertel, *Incompressible surfaces via branched surfaces*. *Topology* 23 (1984), no. 1, 117–125.

- [7] David Gabai, *Foliations and 3-manifolds*. Proceedings of the International Congress of Mathematicians, Vol. I (Kyoto, 1990) 609–619.
- [8] David Gabai and Ulrich Oertel, *Essential laminations in 3-manifolds*. Ann. of Math. (2), **130** (1989) 41–73
- [9] Wolfgang Haken, *Some results on surfaces in 3-manifolds*. Studies in Modern Topology, Math. Assoc. Amer., distributed by Prentice-Hall, (1968) 34–98.
- [10] A. Hatcher, *Measured lamination spaces for surfaces, from the topological viewpoint*. Topology and its Applications **30** (1988) 63–88.
- [11] Klaus Johannson, *Heegaard surfaces in Haken 3-manifolds*. Bull. Amer. Math. Soc. **23** (1990), no. 1, 91–98.
- [12] Klaus Johannson, *Topology and combinatorics of 3-manifolds*. Lecture Notes in Mathematics, **1599**, Springer-Verlag, Berlin, 1995.
- [13] Tsuyoshi Kobayashi, *A construction of 3-manifolds whose homeomorphism classes of Heegaard splittings have polynomial growth*. Osaka Journal of Mathematics, **29** (1992), 653–674.
- [14] Marc Lackenby, *The asymptotic behaviour of Heegaard genus*. Preprint. arXiv:math.GT/0210316
- [15] Tao Li, *Laminar branched surfaces in 3-manifolds*. Geometry and Topology, **6** (2002), 153–194.
- [16] Tao Li, *Boundary curves of surfaces with the 4-plane property*. Geometry and Topology, **6** (2002), 609–647.
- [17] Tao Li, *An algorithm to find vertical tori in small Seifert fiber spaces*. preprint, arXiv:math.GT/0209107
- [18] Tao Li, *Heegaard surfaces and measured laminations, I: the Waldhausen conjecture*. Preprint. arXiv:math.GT, also available at: www.math.okstate.edu/~tli/publications
- [19] Joseph Masters and William Menasco and Xingru Zhang, *Heegaard splittings and virtually Haken Dehn filling*. Preprint, arXiv:math.GT/0210412
- [20] William Menasco, *Closed incompressible surfaces in alternating knot and link complements*. Topology **23** (1984), no. 1, 37–44.
- [21] John Morgan and Peter Shalen, *Degenerations of hyperbolic structures, II: Measured laminations in 3-manifolds*. Annals of Math. **127** (1988), 403–456.
- [22] Yoav Moriah, *Heegaard splittings of Seifert fibered spaces*. Invent. Math. **91** (1988), 465–481.
- [23] Yoav Moriah and Jennifer Schultens, *Irreducible Heegaard splittings of Seifert fibered spaces are either vertical or horizontal*. Topology **37** (1998) 1089–1112.
- [24] Yoav Moriah and Saul Schleimer and Eric Sedgwick, *Heegaard splittings of the form $H + nK$* , Preprint, arXiv:math.GT/0408002
- [25] Ulrich Oertel, *Measured laminations in 3-manifolds*. Trans. Amer. Math. Soc. **305** (1988), no. 2, 531–573.
- [26] Parris, *Pretzel Knots*. Ph.D. Thesis, Princeton University (1978).
- [27] Hyam Rubinstein, *Polyhedral minimal surfaces, Heegaard splittings and decision problems for 3-dimensional manifolds*. Proc. Georgia Topology Conference, Amer. Math. Soc./Intl. Press, 1993.
- [28] Hyam Rubinstein; Martin Scharlemann, *Comparing Heegaard splittings of non-Haken 3-manifolds*. Topology **35** (1996), no. 4, 1005–1026
- [29] Martin Scharlemann, *Local detection of strongly irreducible Heegaard splittings*. Topology and its Applications, **90** (1998) 135–147.
- [30] Saul Schleimer, *The disjoint curve property*. Geometry and Topology, Vol. 8 (2004), 77–113.
- [31] Eric Sedgwick, *An infinite collection of Heegaard splittings that are equivalent after one stabilization*. Math. Ann. **308**, 65–72 (1997).
- [32] Michelle Stocking, *Almost normal surfaces in 3-manifolds*. Trans. Amer. Math. Soc. **352**, 171–207 (2000).

- [33] Friedhelm Waldhausen, *Heegaard-Zerlegungen der 3-Sphäre*. *Topology* **7** 1968 195–203.
- [34] Friedhelm Waldhausen, *Some problems on 3-manifolds*, *Proc. Symp. Pure Math.* **32** (1978) 313–322.
- [35] Ying-Qing Wu, *Dehn surgery on arborescent knots*. *J. Differential Geom.* **43** (1996), no. 1, 171–197.

DEPARTMENT OF MATHEMATICS, OKLAHOMA STATE UNIVERSITY, STILLWATER, OK
74078, USA

E-mail address: `tli@math.okstate.edu`