

# HOMOLOGY OF GENERALIZED PARTITION POSETS

BRUNO VALLETTE

ABSTRACT. We define a family of posets of partitions associated to an operad. We prove that the operad is Koszul if and only if the posets are Cohen-Macaulay. On the one hand, this characterization allows us to compute completely the homology of the posets. The homology groups are isomorphic to the Koszul dual cooperad. On the other hand, we get new methods for proving that an operad is Koszul.

## INTRODUCTION

The homology of the lattice of partitions of the sets  $\{1, \dots, n\}$  has been studied for more than 20 years by many authors. First, A. Björner proved in [B] that the only non-vanishing homology groups are in top dimension. Since the symmetric groups  $\mathbb{S}_n$  act on these posets, the homology groups of top dimension are  $\mathbb{S}_n$ -modules. It took several years to completely compute these representations of  $\mathbb{S}_n$ . We refer to the introduction of [F] for a complete survey on the subject. Actually, these homology groups are given by the linear dual of the multi-linear part of the free Lie algebra twisted by the signature representation. In [F], B. Fresse explained why such a result : the partition lattices are build upon the operad *Com* of commutative algebras and the homology of the partition lattices is isomorphic to its Koszul dual cooperad *Lie* corresponding to Lie algebras.

In this article, we make explicit a general relation between operads and partition type posets. From any operad in the category of sets, we associate a family of partition type posets. For a class of algebraic operads coming from set operads, we prove the equivalence of two homological notions : Koszul operad and Cohen-Macaulay posets.

An operad is an algebraic object that represents the operations acting on certain types of algebras. For instance, one has an *As* operad, a *Com* operad and a *Lie* operad for associative algebras, commutative algebras and Lie algebras. An important issue in the operadic theory is to show that an operad is Koszul. In this case, the associated algebras have interesting properties.

The homology of posets was studied by many authors (*cf.* D. Quillen [Q], A. Björner, A.M. Garsia and R.P. Stanley [BGS] for instance). In this framework, there exist many methods to show that the homology of a poset is concentrated in top dimension and likewise for each interval. In this case, the poset is called Cohen-Macaulay.

The main purpose of this paper is to show that an operad is Koszul if and only if the related posets are Cohen-Macaulay (Theorem 9). In this case, we can compute

the homology of the poset. This homology is equal to the Koszul dual cooperad. Since there exist an explicit formula for this dual, one can use it to compute the homology groups of the posets in terms of  $\mathbb{S}_n$ -modules. On the other hand, we can use the combinatorial methods of poset theory to show that the posets associated to an operad is Cohen-Macaulay. Hence, it provides new methods for proving that an operad is Koszul. Notice that these methods prove in the same time that the posets are Cohen-Macaulay over any field  $k$  and over the ring of integers  $\mathbb{Z}$ . Therefore these new methods work over any field  $k$  and over  $\mathbb{Z}$ . The classical methods found in the literature are based on the acyclicity of the Koszul complex defined by the Koszul dual cooperad. One advantage of the method using the partition posets is that we do not need to compute the Koszul dual cooperad (and its coproduct) of an operad to prove that it is Koszul.

We introduce several partition type posets (pointed, ordered, with block size restriction) associated to operads appearing in the literature. Since these operads are Koszul, we can compute the homology of the posets. It is concentrated in top dimension and given by the Koszul dual cooperad. To handle the case of multi-pointed partitions poset, we introduce a new operad, called *ComTrias* for commutative trialgebras. We describe its Koszul dual and we show that it is a Koszul operad in the appendix.

It is worth mentioning here that in [CV], F. Chapoton and the author studied the proprieties of the pointed and multi-pointed posets and applied the results of this paper to prove that the operads *Perm* and *ComTrias* are Koszul over  $\mathbb{Z}$ .

Sections 1 and 2 contain respectively a survey of the homology of posets and of Koszul duality for operads. In Section 3, we describe the construction of the partitions posets associated to a (set) operad. We also prove in this section the main theorem of this paper, namely Theorem 9, which claims that the operad is Koszul if and only if the related posets are Cohen-Macaulay. Examples and applications are treated in Section 4. Finally, we prove in the Appendix that the operads *ComTrias* and *PostLie* are Koszul.

Let  $k$  be the ring  $\mathbb{Z}$ , the field  $\mathbb{Q}$ ,  $\mathbb{F}_p$  or any field of characteristic 0. Unless otherwise stated, all  $k$ -modules are assumed to be projective.

## CONTENTS

Introduction	1
1. Order complex of a poset	3
1.1. Poset	3
1.2. Partition Poset	3
1.3. Order complex	4
1.4. Cohen-Macaulay poset	5
2. Operads and Koszul duality	5
2.1. Definition of an operad and examples	5
2.2. Koszul Duality for operads	7
3. Partition posets associated to an operad	10
3.1. Construction of a partition poset from an operad	10

---

**HOMOLOGY OF GENERALIZED PARTITION POSETS**

---

3.2. Simplicial and normalized bar construction over a Koszul operad	12
3.3. Homology of a partition poset associated to an operad	14
4. Examples	17
4.1. Homology of the partition poset $\Pi$ and the operad $Com$	17
4.2. Homology of the pointed partition poset $\Pi_P$ and the operad $Perm$	17
4.3. Homology of the multi-pointed partition poset $\Pi_{MP}$ and the operad $ComTrias$	19
4.4. Homology of the ordered partition poset $\Pi_O$ and the operad $\mathcal{A}s$	21
4.5. Homology of the pointed ordered partition poset $\Pi_{PO}$ and the operad $Dias$	23
4.6. Homology of the multi-pointed ordered partition poset $\Pi_{MPO}$ and the operad $Trias$	24
4.7. Comparison between the various partition posets	25
APPENDIX : Koszul duality of the operads $ComTrias$ and $PostLie$	27
References	34

1. ORDER COMPLEX OF A POSET

We recall the basic definitions of a poset and the example of the partition poset. (For more details, we refer the reader to Chapter 3 of [S].) We define the order complex of a poset and the notion of Cohen-Macaulay.

1.1. **Poset.**

DEFINITION (Poset). A *poset*  $(\Pi, \leq)$  is a set  $\Pi$  equipped with a partial order relation, denoted by  $\leq$ .

The posets considered in the sequel are finite. We denote by  $Min(\Pi)$  and  $Max(\Pi)$  the sets of minimal and maximal elements of  $\Pi$ . When each set  $Min(\Pi)$  and  $Max(\Pi)$  has only one element, the poset is said to be *bounded*. In this case, one denotes by  $\hat{0}$  the element of  $Min(\Pi)$  and by  $\hat{1}$  the element of  $Max(\Pi)$ .

For  $x \leq y$  in  $\Pi$ , we denoted the closed interval  $\{z \in \Pi \mid x \leq z \leq y\}$  by  $[x, y]$  and the open interval  $\{z \in \Pi \mid x < z < y\}$  by  $(x, y)$ . For any  $\alpha \in Min(\Pi)$  and any  $\omega \in Max(\Pi)$ , the closed interval  $[\alpha, \omega]$  is a bounded poset. If  $\Pi$  is a bounded poset, one defines the *proper part*  $\bar{\Pi}$  of  $\Pi$  by the open interval  $(\hat{0}, \hat{1})$ .

For elements  $x < y$ , if there exists no  $z$  such that  $x < z < y$ , then we say that  $y$  *covers*  $x$ . The covering relation is denoted by  $x \prec y$ .

DEFINITION (Chain, maximal chain). A *chain*  $\lambda_0 < \lambda_1 < \dots < \lambda_l$  is a growing sequence of elements of a poset  $(\Pi, \leq)$ . Its *length* is equal to  $l$ .

A *maximal chain* between  $x$  and  $y$ , is a chain  $x = \lambda_0 \prec \lambda_1 \prec \dots \prec \lambda_l = y$  which can not be lengthened. A *maximal chain of*  $\Pi$  is a maximal chain between an element of  $Min(\Pi)$  and an element of  $Max(\Pi)$ .

A poset is *pure* if for any  $x \leq y$ , the maximal chains between  $x$  and  $y$  have same length. If a poset is both bounded and pure, it is called a *graded* poset.

1.2. **Partition Poset.** The set  $\{1, \dots, n\}$  is denoted by  $[n]$ .

DEFINITION (Partitions of  $[n]$ ). A *partition* of the set  $[n]$  is an unordered collection of subsets  $B_1, \dots, B_k$ , called *blocks* or *components*, which are nonempty, pairwise disjoint, and whose union gives  $[n]$ .

DEFINITION (Partition poset,  $\Pi$ ). For any integer  $n$ , one defines a partial order  $\leq$ , on the set of partitions of  $[n]$ , by the *refinement of partitions*. This partially ordered set is called the *partition poset* (or partition lattice) and denoted by  $\Pi(n)$ .

For instance, one has  $\{\{1, 3\}, \{2, 4\}\} \leq \{\{1\}, \{3\}, \{2, 4\}\}$ . The single set  $\{\{1, \dots, n\}\}$  forms the smallest partition of  $[n]$  whereas the collection  $\{\{1\}, \dots, \{n\}\}$  forms the largest partition. Therefore, this poset is graded. Observe that this definition is dual to the one found in the literature.

The set of partitions of  $[n]$  is equipped with a right action of the symmetric group  $\mathbb{S}_n$ . Let  $\sigma : \{1, \dots, n\} \rightarrow \{1, \dots, n\}$  be a permutation, the image of the partition  $\{\{i_1^1, \dots, i_{j_1}^1\}, \dots, \{i_1^k, \dots, i_{j_k}^k\}\}$  under  $\sigma$  is the partition  $\{\{\sigma(i_1^1), \dots, \sigma(i_{j_1}^1)\}, \dots, \{\sigma(i_1^k), \dots, \sigma(i_{j_k}^k)\}\}$ .

**1.3. Order complex.** We consider the set of chains  $\lambda_0 < \lambda_1 < \dots < \lambda_l$  of a poset  $(\Pi, \leq)$  such that  $\lambda_0 \in \text{Min}(\Pi)$  and  $\lambda_l \in \text{Max}(\Pi)$ . This set is denoted by  $\Delta(\Pi)$ . More precisely, a chain  $\lambda_0 < \lambda_1 < \dots < \lambda_l$  of length  $l$  belongs to  $\Delta_l(\Pi)$

DEFINITION (Order complex,  $\Delta(\Pi)$ ). The set  $\Delta(\Pi)$  can be equipped with face maps. For  $0 < i < l$ , the face map  $d_i$  is given by the omission of  $\lambda_i$  in the sequence  $\lambda_0 < \lambda_1 < \dots < \lambda_l$ . If we take the convention  $d_0 = d_l = 0$ , the module  $k[\Delta(\Pi)]$  is a presimplicial module. The induced chain complex on  $k[\Delta(\Pi)]$  is called the *order complex* of  $\Pi$ .

DEFINITION (Homology of a poset  $\Pi$ ,  $H_*(\Pi)$ ). The *homology of a poset*  $(\Pi, \leq)$  is the homology of the presimplicial set  $\Delta(\Pi)$  with coefficients in  $k$ . We denote it by  $H_*(\Pi)$ .

REMARK. In the literature (*cf.* for instance [BGS]), the *reduced* homology of a poset is defined in the following way. One denotes by  $\tilde{\Delta}_l(\Pi)$  the set of chains  $\lambda_0 < \lambda_1 < \dots < \lambda_l$ , with no restriction on  $\lambda_0$  and  $\lambda_l$ . The face maps  $d_i$  are defined by the omission of  $\lambda_i$  for  $0 \leq i \leq l$ . By convention, this complex is augmented by  $\tilde{\Delta}_{-1}(\Pi) = \{\emptyset\}$ . We have  $k[\tilde{\Delta}_{-1}(\Pi)] = k$ . The associated homology groups are denoted by  $\tilde{H}_*(\Pi)$ . This definition is convenient when applied to the proper part of a bounded poset.

The relation between the two definitions is given by the following formula

$$\Delta_l(\Pi) = \bigsqcup_{(\alpha, \omega) \in \text{Min}(\Pi) \times \text{Max}(\Pi)} \tilde{\Delta}_{l-2}(\alpha, \omega),$$

which induces an isomorphism of presimplicial complexes. Therefore, we have

$$H_l(\Pi) = \bigoplus_{(\alpha, \omega) \in \text{Min}(\Pi) \times \text{Max}(\Pi)} \tilde{H}_{l-2}(\alpha, \omega).$$

When a poset  $(\Pi, \leq)$  is equipped with an action of a group  $G$ , compatible with the partial order  $\leq$ , the modules  $k[\Delta_l(\Pi)]$  are  $G$ -modules. Since, the chain map commutes with the action of  $G$ , the homology groups  $H_*(\Pi)$  are  $G$ -modules too. In the case of the partition poset, the module  $k[\Delta(\Pi(n))]$  is an  $\mathbb{S}_n$ -presimplicial module.

**1.4. Cohen-Macaulay poset.**

DEFINITION (Cohen-Macaulay poset). Let  $\Pi$  be a graded poset. It is said to be *Cohen-Macaulay* (over  $k$ ) if the homology of each interval is concentrated in top dimension. For any  $x \leq y$ , let  $d$  be the length of maximal chains between  $x$  and  $y$ , we have

$$H_l([x, y]) = \tilde{H}_{l-2}((x, y)) = 0,$$

for  $l \neq d$ .

We refer the reader to the article of A. Björner, A.M. Garsia and R.P. Stanley [BGS] for a short survey on Cohen-Macaulay posets.

**2. OPERADS AND KOSZUL DUALITY**

In this section, we define the notions related to operads. We recall the results of the Koszul duality theory for operads that will be used later in the text.

**2.1. Definition of an operad and examples.** We recall the definition of an operad. We give the examples of free and quadratic operads.

**2.1.1. Definition.** The survey of J.-L. Loday [L1] provides a good introduction to operads and the book of M. Markl, S. Shnider and J. Stasheff [MSS] gives a full treatment of this notion.

An *algebraic operad* is an algebraic object that models the operations acting on certain type of algebras. For instance, there exists an operad  $\mathcal{A}s$  coding the operations of associative algebras, an operad  $\mathcal{C}om$  for commutative algebras and an operad  $\mathcal{L}ie$  for Lie algebras.

The operations acting on  $n$  variables form a right  $\mathbb{S}_n$ -module  $\mathcal{P}(n)$ . A collection  $(\mathcal{P}(n))_{n \in \mathbb{N}^*}$  of  $\mathbb{S}_n$ -modules is called an  $\mathbb{S}$ -*module*. One defines a monoidal product  $\circ$  in the category of  $\mathbb{S}$ -modules by the formula :

$$\mathcal{P} \circ \mathcal{Q}(n) := \bigoplus_{1 \leq k \leq n} \left( \bigoplus_{i_1 + \dots + i_k = n} \mathcal{P}(k) \otimes (\mathcal{Q}(i_1) \otimes \dots \otimes \mathcal{Q}(i_k)) \otimes_{\mathbb{S}_{i_1} \times \dots \times \mathbb{S}_{i_k}} k[\mathbb{S}_n] \right)_{\mathbb{S}_k},$$

where the coinvariants are taken with respect to the action of the symmetric group  $\mathbb{S}_k$  given by  $(p \otimes q_1 \dots q_k \otimes \sigma)^\nu := p^\nu \otimes q_{\nu(1)} \dots q_{\nu(k)} \otimes \bar{\nu}^{-1} \cdot \sigma$  for  $p \in \mathcal{P}(k)$ ,  $q_j \in \mathcal{Q}(i_j)$ ,  $\sigma \in \mathbb{S}_n$  and  $\nu \in \mathbb{S}_k$ , such that  $\bar{\nu}$  is the induced block permutation.

This product reflects the compositions of operations and an element of  $\mathcal{P} \circ \mathcal{Q}$  can be represented by 2-levelled trees whose vertices are indexed by the elements of the operads (*cf.* [Figure 1]).

The unit of this monoidal category is given by the  $\mathbb{S}$ -module  $I = (k, 0, 0, \dots)$ .

DEFINITION (Operad). An *operad* (or *algebraic operad*)  $(\mathcal{P}, \mu, \eta)$  is a monoid in the monoidal category  $(\mathbb{S}\text{-Mod}, \circ, I)$ . This means that the *composition* morphism  $\mu : \mathcal{P} \circ \mathcal{P} \rightarrow \mathcal{P}$  is associative and that the morphism  $\eta : I \rightarrow \mathcal{P}$  is a *unit*.

EXAMPLE. Let  $V$  be a  $k$ -module. The  $\mathbb{S}$ -module  $(Hom_k(V^{\otimes n}, V))_{n \in \mathbb{N}^*}$  of morphisms between  $V^{\otimes n}$  and  $V$  forms an operad with the classical composition of morphisms. This operad is denoted by  $End(V)$ .

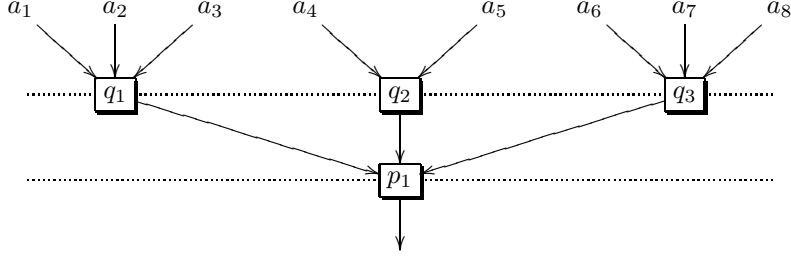
FIGURE 1. Example of composition of operations  $\mathcal{P} \circ \mathcal{Q}(8)$ 

We have recalled the definition of an operad in the symmetric category of  $k$ -module. One can generalize it to any symmetric category. For instance, we consider the category  $(Set, \times)$  of *Sets* equipped with the symmetric monoidal product given by the cartesian product  $\times$ . We call an  $\mathbb{S}$ -Set a collection  $(\mathcal{P}_n)_{n \in \mathbb{N}^*}$  of sets  $\mathcal{P}_n$  equipped with an action of the group  $\mathbb{S}_n$ .

DEFINITION (Set operad). A monoid  $(\mathcal{P}, \mu, \eta)$  in the monoidal category of  $\mathbb{S}$ -sets is called a *set operad*.

If  $\mathcal{P}$  is a set operad, then the free  $k$ -module  $\tilde{\mathcal{P}}(n) := k[\mathcal{P}_n]$  is an (algebraic) operad.

For any element  $(\nu_1, \dots, \nu_t)$  of  $\mathcal{P}_{i_1} \times \dots \times \mathcal{P}_{i_t}$ , we denote by  $\mu_{(\nu_1, \dots, \nu_t)}$  the following map defined by the product of the set operad  $\mathcal{P}$ .

$$\begin{aligned} \mu_{(\nu_1, \dots, \nu_t)} : \mathcal{P}_t &\rightarrow \mathcal{P}_{i_1 + \dots + i_t} \\ \nu &\mapsto \mu(\nu(\nu_1, \dots, \nu_t)). \end{aligned}$$

DEFINITION (Basic-set operad). A *basic-set* operad is a set operad  $\mathcal{P}$  such that for any  $(\nu_1, \dots, \nu_t)$  in  $(\mathcal{P}_{i_1}, \dots, \mathcal{P}_{i_t})$  the composition maps  $\mu_{(\nu_1, \dots, \nu_t)}$  are injective.

EXAMPLES. The operads *Com*, *Perm* and *As*, for instance, are basic-set operads (cf. section 4).

This extra condition will be crucial in the proof of the theorem 7.

REMARK. Dually, one can define the notion of *cooperad* which is an operad in the opposite category  $(\mathbb{S}\text{-mod}^{\text{op}}, \circ, I)$ . A cooperad  $(C, \Delta, \epsilon)$  is an  $\mathbb{S}$ -module  $C$  equipped with a map  $\Delta : C \rightarrow C \circ C$  coassociative and a map  $\epsilon : C \rightarrow I$  which is a counit.

An operad  $(\mathcal{P}, \mu, \eta)$  is *augmented* if there exists a morphism of operads  $\epsilon : \mathcal{P} \rightarrow I$  such that  $\epsilon \circ \eta = id_I$ .

DEFINITION ( $\mathcal{P}$ -algebra). A  $\mathcal{P}$ -algebra structure on a module  $V$  is given by a morphism  $\mathcal{P} \rightarrow \text{End}(V)$  of operads.

It is equivalent to have a morphism

$$\mu_A : \mathcal{P}(A) := \bigoplus_{n \in \mathbb{N}^*} \mathcal{P}(n) \otimes_{\mathbb{S}_n} A^{\otimes n} \rightarrow A$$

such that the following diagram commutes

$$\begin{array}{ccc}
 \mathcal{P} \circ \mathcal{P}(A) & \xrightarrow{\mu^{(A)}} & \mathcal{P}(A) \\
 \downarrow \mathcal{P}(\mu_A) & & \downarrow \mu_A \\
 \mathcal{P}(A) & \xrightarrow{\mu_A} & A.
 \end{array}$$

REMARK. The free  $\mathcal{P}$ -algebra on the module  $V$  is defined by the module  $\mathcal{P}(V) = \bigoplus_{n \in \mathbb{N}^*} \mathcal{P}(n) \otimes_{\mathbb{S}_n} V^{\otimes n}$ .

### 2.1.2. Free and quadratic operads.

DEFINITION (Free operad,  $\mathcal{F}(V)$ ). The forgetful functor from the category of operads to the category of  $\mathbb{S}$ -modules has a left adjoint functor which gives the *free operad* on an  $\mathbb{S}$ -module  $V$ , denoted by  $\mathcal{F}(V)$ .

REMARK. The construction of the free operad on  $V$  is given by trees whose vertices are indexed by the elements of  $V$ . The free operad is equipped with a natural graduation which corresponds to the number of vertices of the trees. We denote this graduation by  $\mathcal{F}_{(n)}(V)$ .

On the same  $\mathbb{S}$ -module  $\mathcal{F}(V)$ , one can define two maps  $\Delta$  and  $\epsilon$  such that  $(\mathcal{F}(V), \Delta, \epsilon)$  is the cofree connected cooperad on  $V$ . This cooperad is denoted by  $\mathcal{F}^c(V)$ .

For more details on free and cofree operads, we refer the reader to [V].

DEFINITION (Quadratic operad). A *quadratic operad*  $\mathcal{P}$  is an operad  $\mathcal{P} = \mathcal{F}(V)/(R)$  generated by an  $\mathbb{S}$ -module  $V$  and a space of relations  $R \subset \mathcal{F}_{(2)}(V)$ , where  $\mathcal{F}_{(2)}(V)$  is the direct summand of  $\mathcal{F}(V)$  generated by the trees with 2 vertices.

EXAMPLES.

- ▷ The operad  $\mathcal{A}s$  coding associative algebras is a quadratic operad generated by a binary operation  $V = \mu.k[\mathbb{S}_2]$  and the associative relation  $R = (\mu(\mu(\bullet, \bullet), \bullet) - \mu(\bullet, \mu(\bullet, \bullet))).k[\mathbb{S}_3]$
- ▷ The operad  $\mathcal{C}om$  coding commutative algebras is a quadratic operad generated by a symmetric binary operation  $V = \mu.k$  and the associative relation  $R = \mu(\mu(\bullet, \bullet), \bullet) - \mu(\bullet, \mu(\bullet, \bullet))$
- ▷ The operad  $\mathcal{L}ie$  coding Lie algebras is a quadratic operad generated by an anti-symmetric operation  $V = \mu.sgn_{\mathbb{S}_2}$  and the Jacobi relation  $R = \mu(\mu(\bullet, \bullet), \bullet).(id + (123) + (132))$

Throughout the text, we will only consider quadratic operads generated by  $\mathbb{S}$ -modules  $V$  such that  $V(1) = 0$ . Therefore, the operad verifies  $\mathcal{P}(1) = k$ . We say that  $V$  is an *homogenous*  $\mathbb{S}$ -module if  $V(t) \neq 0$  for only one  $t$ .

2.2. **Koszul Duality for operads.** We recall the results of the theory of Koszul duality for operads that will be used in this article. This theory was settled by V. Ginzburg and M.M. Kapranov in [GK]. The reader can find a short survey of the subject in the article of J.-L. Loday [L1] and in the appendix B of [L2]. For a full treatment and the generalization over a field of characteristic  $p$  (or a Dedekind ring), we refer to the article of B. Fresse [F].

**2.2.1. Koszul dual operad and cooperad.** To a quadratic operad, one can associate a Koszul dual operad and cooperad.

The Czech dual of an  $\mathbb{S}$ -module  $V$  is the linear dual of  $V$  twisted by the signature representation.

**DEFINITION** (Czech dual of an  $\mathbb{S}$ -module,  $V^\vee$ ). To an  $\mathbb{S}$ -module  $V$ , one can associate another  $\mathbb{S}$ -module, called the *Czech dual of  $V$*  and denoted by  $V^\vee$ , by the formula  $V^\vee(n) = V(n)^* \otimes \text{sgn}_{\mathbb{S}_n}$ , where  $V^*$  is the linear dual of  $V$  and  $\text{sgn}_{\mathbb{S}_n}$  is the signature representation of  $\mathbb{S}_n$ .

**DEFINITION** (Koszul dual of an operad,  $\mathcal{P}^!$ ). Let  $\mathcal{P} = \mathcal{F}(V)/(R)$  be a quadratic operad. Its *Koszul dual operad* is the quadratic operad generated by the  $\mathbb{S}$ -module  $V^\vee$  and the relation  $R^\perp$ . This operad is denoted by  $\mathcal{P}^! = \mathcal{F}(V^\vee)/(R^\perp)$ .

**EXAMPLES.**

- ▷ The operad  $\mathcal{A}s$  is autodual  $\mathcal{A}s^! \cong \mathcal{A}s$ .
- ▷ The operads  $\mathcal{C}om$  and  $\mathcal{L}ie$  are dual to each other,  $\mathcal{C}om^! \cong \mathcal{L}ie$  and  $\mathcal{L}ie^! \cong \mathcal{C}om$ .

**DEFINITION** (Koszul dual cooperad,  $\mathcal{P}^i$ ). Let  $\mathcal{P} = \mathcal{F}(V)/(R)$  be a quadratic operad generated by a finite dimensional  $\mathbb{S}$ -module  $V$ . The *Koszul dual cooperad* of  $\mathcal{P}$  is defined by the Czech dual of  $\mathcal{P}^!$  and denoted by  $\mathcal{P}^i = \mathcal{P}^{!\vee}$ .

**2.2.2. Koszul complex and Koszul operads.** An operad is said to be a *Koszul operad* if its Koszul complex is acyclic.

**DEFINITION** (Koszul complex). To a quadratic operad  $\mathcal{P}$ , one associates the following boundary map on the  $\mathbb{S}$ -module  $\mathcal{P}^i \circ \mathcal{P}$  :

$$\partial : \mathcal{P}^i \circ \mathcal{P} \xrightarrow{\Delta'} \mathcal{P}^i \circ \underbrace{\mathcal{P}^!}_1 \circ \mathcal{P} \xrightarrow{\mathcal{P}^i \circ (I + \alpha) \circ \mathcal{P}} \mathcal{P}^i \circ \mathcal{P} \circ \mathcal{P} \xrightarrow{\mathcal{P}^i \circ \mu_{\mathcal{P}}} \mathcal{P}^i \circ \mathcal{P},$$

where  $\Delta'$  is the projection of the coproduct  $\Delta = \mu_{\mathcal{P}^i}^\vee$  of the cooperad  $\mathcal{P}^i$  on the  $\mathbb{S}$ -module  $\mathcal{P}^i \circ \underbrace{\mathcal{P}^!}_1$  with only one element of  $\mathcal{P}^!$  on the right and  $\alpha$  is the following composition :

$$\alpha : \mathcal{P}^i = (\mathcal{F}(V^\vee)/(R^\perp))^\vee \rightarrow (V^\vee)^\vee \simeq V \hookrightarrow \mathcal{P} = \mathcal{F}(V)/(R).$$

**DEFINITION** (Koszul operad). A quadratic operad  $\mathcal{P}$  is a *Koszul operad* if its Koszul complex  $(\mathcal{P}^i \circ \mathcal{P}, \partial)$  is acyclic.

**EXAMPLES.** The operads  $\mathcal{A}s$ ,  $\mathcal{C}om$  and  $\mathcal{L}ie$  are Koszul operads.

**2.2.3. Operadic homology.** To any quadratic operad  $\mathcal{P} = \mathcal{F}(V)/(R)$ , one can define a homology theory for  $\mathcal{P}$ -algebras.

**DEFINITION** (Operadic chain complex,  $\mathcal{C}_*^{\mathcal{P}}(A)$ ). Let  $A$  be  $\mathcal{P}$ -algebra. On the modules  $\mathcal{C}_n^{\mathcal{P}}(A) := \mathcal{P}^i(n) \otimes_{\mathbb{S}_n} A^{\otimes n}$ , one defines a boundary map by the formula :

$$\mathcal{P}^i(A) \xrightarrow{\Delta'} \mathcal{P}^i \circ \underbrace{\mathcal{P}^!}_1 \circ A \xrightarrow{\mathcal{P}^i \circ (I + \alpha) \circ A} \mathcal{P}^i \circ \mathcal{P}(A) \xrightarrow{\mathcal{P}^i \circ \mu_A} \mathcal{P}^i(A).$$

The related homology is denoted by  $H_*^{\mathcal{P}}(A)$ .

**EXAMPLES.**



---

## HOMOLOGY OF GENERALIZED PARTITION POSETS

---

- ▷ In the *As* case, the operadic homology theory correspond to the Hochschild homology of associative algebras.
- ▷ In the *Com* case, the operadic homology theory correspond to the Harrison homology of commutative algebras.
- ▷ In the *Lie* case, the operadic homology theory correspond to the Chevalley-Eilenberg homology of Lie algebras.

Let us recall that an operad  $\mathcal{P}$  is a Koszul operad if the operadic homology of the free  $\mathcal{P}$ -algebra  $\mathcal{P}(V)$  is acyclic for every  $k$ -module  $V$ ,

$$H_*^{\mathcal{P}}(\mathcal{P}(V)) = \begin{cases} V & \text{if } * = 1, \\ 0 & \text{elsewhere.} \end{cases}$$

REMARK. An operad  $\mathcal{P}$  is Koszul if and only if its dual  $\mathcal{P}^\dagger$  is Koszul.

**2.2.4. Differential bar construction of an operad.** One can generalize the differential bar construction of associative algebras to operads.

Let  $\mathcal{P} = \mathcal{F}(V)/(R)$  be a quadratic operad. The natural graduation of the free operad  $\mathcal{F}(V)$  induces a graduation on  $\mathcal{P}$ . We call it the *weight* and we denote it by  $\mathcal{P}_{(n)} := \text{Im}(\mathcal{F}_{(n)}(V) \rightarrow \mathcal{F}(V)/(R))$ . Any quadratic operad is augmented and the ideal of augmentation is given by  $\bar{\mathcal{P}} := \bigoplus_{n>0} \mathcal{P}_{(n)}$ .

We consider the *desuspension* of the ideal of augmentation  $\Sigma^{-1}\bar{\mathcal{P}}$  which corresponds to shift the weight by  $-1$ . An element  $\nu$  of weight  $n$  in  $\bar{\mathcal{P}}$  gives an element  $\Sigma^{-1}\nu$  of weight  $n - 1$  in  $\Sigma^{-1}\bar{\mathcal{P}}$ .

DEFINITION (Differential bar construction of an operad,  $\mathcal{B}(\mathcal{P})$ ). The *differential bar construction* of a quadratic operad  $\mathcal{P}$  is given by the cofree connected cooperad on  $\Sigma^{-1}\bar{\mathcal{P}}$ , namely  $\mathcal{F}^c(\Sigma^{-1}\bar{\mathcal{P}})$ , where the coboundary map is the unique coderivation  $\delta$  induced by the partial product of  $\mathcal{P}$  :

$$\mathcal{F}_{(2)}^c(\Sigma^{-1}\bar{\mathcal{P}}) \xrightarrow{\bar{\mu}} \Sigma^{-1}\bar{\mathcal{P}}.$$

This differential cooperad is denoted by  $(\mathcal{B}(\mathcal{P}), \delta)$ .

The cohomological degree of the differential bar construction is induced by the global weight of  $\mathcal{F}^c(\Sigma^{-1}\bar{\mathcal{P}})$  and the desuspension. We denote it by  $\mathcal{B}^n(\mathcal{P})$ . For instance, a tree with  $l$  vertices indexed by operations  $\Sigma^{-1}\nu_1, \dots, \Sigma^{-1}\nu_l$  of weight  $p_1 - 1, \dots, p_l - 1$  represents an element of cohomological degree equals to  $p_1 + \dots + p_l - l$ .

**2.2.5. Koszul duality.** We recall here the main theorem of the Koszul duality theory for operads.

For a quadratic operad, the differential bar construction has the following form :

$$0 \xrightarrow{\delta} \mathcal{B}^0(\mathcal{P}) = \mathcal{F}^c(\Sigma^{-1}V) \xrightarrow{\delta} \mathcal{B}^1(\mathcal{P}) \xrightarrow{\delta} \dots$$

REMARK. The differential bar construction is a direct sum of subcomplexes indexed by the global weight coming from  $\mathcal{P}$  taken without the desuspension. We denote it by  $\mathcal{B}(\mathcal{P}) = \bigoplus_{m \in \mathbb{N}} \mathcal{B}(\mathcal{P})_{(m)}$ .

The main theorem of the Koszul duality theory used in this article is the following one.

THEOREM 1. [GK-F] *Let  $\mathcal{P}$  be a quadratic operad generated by a finite dimensional space  $V$ .*

- (1) *One has  $H^0(\mathcal{B}(\mathcal{P})) \cong \mathcal{P}^i$  (more precisely, one has  $H^0(\mathcal{B}(\mathcal{P})_{(m)}) \cong \mathcal{P}_{(m)}^i = (\mathcal{P}_{(m)}^i)^*$ ).*
- (2) *The operad  $\mathcal{P}$  is a Koszul operad if and only if  $H^k(\mathcal{B}^*(\mathcal{P})) = 0$  for  $k > 0$ .*

REMARK. Notice the similarity with the notion of a Cohen-Macaulay poset. A Cohen-Macaulay poset has its homology concentrated in top dimension and a Koszul operad is an operad such that the homology of its bar construction is concentrated in some degree too.

### 3. PARTITION POSETS ASSOCIATED TO AN OPERAD

We give the definition of the partition poset associated to an operad. We recall the definition of the simplicial bar construction of an operad. And we prove that the operad is Koszul if and only if the related poset is Cohen-Macaulay.

**3.1. Construction of a partition poset from an operad.** To any set operad, we define a family of posets of partitions.

**3.1.1.  $\mathcal{P}$ -partition.** Let  $(\mathcal{P}, \mu, \eta)$  be a set operad. By definition, the set  $\mathcal{P}_n$  is equipped with an action of the symmetric group  $\mathbb{S}_n$ . Let  $I$  be a set  $\{x_1, \dots, x_n\}$  of  $n$  elements. We consider the cartesian product  $\mathcal{P}_n \times \mathcal{I}$ , where  $\mathcal{I}$  is the set of ordered sequences of elements of  $I$ , each element appearing once. We define the diagonal action of  $\mathbb{S}_n$  on  $\mathcal{P}_n \times \mathcal{I}$  as follows. The image of  $\nu_n \times (x_{i_1}, \dots, x_{i_n})$  under a permutation  $\sigma$  is given by  $\nu_n \cdot \sigma \times (x_{\sigma^{-1}(i_1)}, \dots, x_{\sigma^{-1}(i_n)})$ . We denote by  $\overline{\nu_n \times (x_{i_1}, \dots, x_{i_n})}$  the orbit of  $\nu_n \times (x_{i_1}, \dots, x_{i_n})$  and by  $\mathcal{P}_n(I) := \mathcal{P}_n \times_{\mathbb{S}_n} \mathcal{I}$  the set of orbits under this action. We have

$$\mathcal{P}(I) = \left( \coprod_{\substack{f: \text{bijection} \\ [n] \rightarrow I}} \mathcal{P}_n \right) \sim$$

where the equivalence relation  $\sim$  is given by  $(\nu_n, f) \sim (\nu_n \cdot \sigma, f \circ \sigma^{-1})$ .

DEFINITION ( $\mathcal{P}$ -partition). Let  $\mathcal{P}$  be a set operad. A  $\mathcal{P}$ -partition of  $[n]$  is a set of components  $\{B_1, \dots, B_t\}$  such that each  $B_j$  belongs to  $\mathcal{P}_{i_j}(I_j)$  where  $i_1 + \dots + i_t = n$  and  $\{I_j\}_{1 \leq j \leq t}$  is a partition of  $[n]$ .

REMARK. A  $\mathcal{P}$ -partition is a classical partition enriched by the operations of  $\mathcal{P}$ .

**3.1.2. Operadic partition poset.** We give the definition of the poset associated to an operad.

We generalize the maps  $\mu_{(\nu_1, \dots, \nu_t)}$  (see section 2) to the  $\mathcal{P}(I)$ .

PROPOSITION 2. *Let  $\{I_1, \dots, I_t\}$  be a partition of a set  $I$ , where the number of elements of  $I_r$  is equal to  $i_r$ . Let  $(C_1, \dots, C_t)$  be an element of  $\mathcal{P}_{i_1}(I_1) \times \dots \times \mathcal{P}_{i_t}(I_t)$ . Each  $C_r$  can be represented by  $\overline{\nu_r \times (x_1^r, \dots, x_{i_r}^r)}$ , where  $\nu_r \in \mathcal{P}_{i_r}$  and  $I_r = \{x_1^r, \dots, x_{i_r}^r\}$ . The map  $\tilde{\mu}$  given by the formula*

$$\begin{aligned} \tilde{\mu} : \mathcal{P}_t \times (\mathcal{P}_{i_1}(I_1) \times \dots \times \mathcal{P}_{i_t}(I_t)) &\rightarrow \mathcal{P}_{i_1 + \dots + i_t}(I) \\ \nu \times (C_1, \dots, C_t) &\mapsto \overline{\mu(\nu(\nu_1, \dots, \nu_t)) \times (x_1^1, \dots, x_{i_t}^t)}, \end{aligned}$$

---

## HOMOLOGY OF GENERALIZED PARTITION POSETS

---

is well defined and equivariant under the action of  $\mathbb{S}_t$ .

PROOF. It is a direct consequence of the definition of a set operad. □

To a set operad  $\mathcal{P}$ , we associate a partial order on the set of  $\mathcal{P}$ -partitions as follows.

DEFINITION (Operadic partition poset,  $\Pi_{\mathcal{P}}$ ). Let  $\mathcal{P}$  be a set operad. Let  $\lambda = \{B_1, \dots, B_r\}$  and  $\mu = \{C_1, \dots, C_s\}$  be two  $\mathcal{P}$ -partitions of  $[n]$ , where  $B_k$  belongs to  $\mathcal{P}_{i_k}(I_k)$  and  $C_l$  to  $\mathcal{P}_{j_l}(J_l)$ . The  $\mathcal{P}$ -partition  $\mu$  is said to be *larger* than  $\lambda$  if, for any  $k \in \{1, \dots, r\}$ , there exist  $\{p_1, \dots, p_t\} \subset \{1, \dots, s\}$  such that  $\{J_{p_1}, \dots, J_{p_t}\}$  is a partition of  $I_k$  and if there exists an element  $\nu$  in  $\mathcal{P}_t$  such that  $B_k = \tilde{\mu}(\nu \times (C_{p_1}, \dots, C_{p_t}))$ . We denote this relation by  $\lambda \leq \mu$ . We call this poset, the *operadic partition poset* associated to the operad  $\mathcal{P}$  and we denote it by  $\Pi_{\mathcal{P}}$ .

Throughout the text, we suppose that the operad  $\mathcal{P}$  is such that the set  $\mathcal{P}_1$  is reduced to one element, the identity for the composition. In this context, the poset  $\Pi_{\mathcal{P}}(n)$  has only one maximal element corresponding to the partition  $\{\{1\}, \dots, \{n\}\}$ , where  $\{i\}$  represents the unique element of  $\mathcal{P}_1(\{i\})$ . Following the classical notations, we denote this element by  $\hat{1}$ . The set of minimal elements is  $\mathcal{P}_n([n])$ .

REMARK. If the operad  $\mathcal{P}$  is a quadratic operad generated by an homogenous  $\mathbb{S}$ -set  $V$  such that  $V(t) \neq 0$ , then the  $\mathcal{P}$ -partitions have restricted block size. The possible lengths for the blocks are  $l(t-1) + 1$  with  $l \in \mathbb{N}$ .

**3.1.3. Operadic order complex.** We consider the following order complex associated to the poset  $\Pi_{\mathcal{P}}$ .

DEFINITION (Operadic order complex,  $\Delta(\Pi_{\mathcal{P}})$ ). The *operadic order complex* is the presimplicial complex induced by the chains  $\lambda_0 < \lambda_1 < \dots < \lambda_l$  of  $\Pi_{\mathcal{P}}$ , where  $\lambda_0$  is a minimal element and  $\lambda_l = \hat{1}$ . We denoted by  $\Delta_l(\Pi_{\mathcal{P}})$  the set of chains of length  $l$ .

PROPOSITION 3. *Let  $\mathcal{P}$  be a set operad.*

- (1) *Each  $k$ -module  $k[\mathcal{P}_n]$  has finite rank if and only if each poset  $\Pi_{\mathcal{P}}(n)$  is finite.*
- (2) *Moreover, if  $\mathcal{P}$  is a quadratic operad generated by an homogenous  $\mathbb{S}$ -set  $V$  such that  $V(t) \neq 0$ . then all the maximal chains of  $\Pi_{\mathcal{P}}$  have the same length. More precisely, if  $\lambda \leq \mu$  the maximal chains in the closed interval  $[\lambda, \mu]$  have length  $(b_{\mu} - b_{\lambda})/(t-1)$ , where  $b_{\lambda}$  denotes the number of blocks of the  $\mathcal{P}$ -partition  $\lambda$ .  
The subposets  $[\alpha, \hat{1}]$ , for  $\alpha \in \text{Min}(\Pi_{\mathcal{P}}(n)) = \mathcal{P}_n([n])$  are graded posets. The length of maximal chains between a minimal element and  $\hat{1}$  in  $\Pi_{\mathcal{P}}(n)$  is equal to  $l+1$  if  $n = l(t-1) + 1$  and 0 otherwise.*

PROOF. The first point is obvious. In the second case, the condition on  $V$  implies that all the blocks have size  $l(t-1) + 1$ . The surjection of the compositions gives that every block of size  $l(t-1) + 1$  is refinable if  $l > 1$ . Since each closed interval of the form  $[\alpha, \hat{1}]$ , for  $\alpha \in \text{Min}(\Pi_{\mathcal{P}}(n)) = \mathcal{P}_n([n])$  is bounded and pure, it is graded by definition. □

### 3.2. Simplicial and normalized bar construction over a Koszul operad.

We recall the definition of the simplicial and the normalized bar construction of an operad. They are always quasi-isomorphic. We recall the quasi-isomorphism between the simplicial and the differential bar construction of an operad due to B. Fresse in [F].

**3.2.1. Definition of the simplicial and the normalized bar construction of an operad.** Following the classical methods of monoidal categories (*cf.* S. Mac Lane [MacL]), we recall the construction of the simplicial bar construction of an operad.

DEFINITION (Simplicial bar construction of an operad,  $\mathcal{C}(\mathcal{P})$ ). Let  $(\mathcal{P}, \mu, \eta, \epsilon)$  be an augmented operad. We define the  $\mathbb{S}$ -module  $\mathcal{C}(\mathcal{P})$  by the formula  $\mathcal{C}_l(\mathcal{P}) = \mathcal{P}^{\circ l}$ .

The face maps  $d_i$  are given by

$$\begin{aligned} d_i &= \mathcal{P}^{\circ(i-1)} \circ \mu \circ \mathcal{P}^{\circ(l-i-1)} : \\ \mathcal{P}^{\circ l} &= \mathcal{P}^{\circ(i-1)} \circ (\mathcal{P} \circ \mathcal{P}) \circ \mathcal{P}^{\circ(l-i-1)} \rightarrow \mathcal{P}^{\circ(i-1)} \circ \mathcal{P} \circ \mathcal{P}^{\circ(l-i-1)} = \mathcal{P}^{\circ(l-1)}, \end{aligned}$$

for  $0 < i < l$  and otherwise by

$$\begin{aligned} d_0 &= \epsilon \circ \mathcal{P}^{\circ(l-1)} : \mathcal{P}^{\circ l} \rightarrow \mathcal{P}^{\circ(l-1)} \\ d_l &= \mathcal{P}^{\circ(l-1)} \circ \epsilon : \mathcal{P}^{\circ l} \rightarrow \mathcal{P}^{\circ(l-1)}. \end{aligned}$$

The degeneracy maps  $s_j$  are given by

$$\begin{aligned} s_j &= \mathcal{P}^{\circ j} \circ \eta \circ \mathcal{P}^{\circ(l-j)} : \\ \mathcal{P}^{\circ l} &= \mathcal{P}^{\circ j} \circ I \circ \mathcal{P}^{\circ(l-j)} \rightarrow \mathcal{P}^{\circ j} \circ \mathcal{P} \circ \mathcal{P}^{\circ(l-j)} = \mathcal{P}^{\circ(l+1)}, \end{aligned}$$

for  $0 \leq j \leq l$ .

This simplicial module is called the *simplicial (or categorical) bar construction of the operad  $\mathcal{P}$* .

Since the composition and unit morphisms of an operad preserve the action of the symmetric groups  $\mathbb{S}_n$ , the face and the degeneracy maps of the simplicial bar construction  $\mathcal{C}(\mathcal{P})$  are morphisms of  $\mathbb{S}$ -modules.

The  $\mathbb{S}_n$ -modules  $\mathcal{C}_l(\mathcal{P})(n)$  can be represented by  $l$ -levelled trees with  $n$  leaves, whose vertices are indexed by operations of  $\mathcal{P}$ . In this framework, the faces  $d_i$  correspond to the notion of *level contraction*.

We consider the normalization of this simplicial complex.

DEFINITION (Normalized bar construction,  $\mathcal{N}(\mathcal{P})$ ). The *normalized bar construction* of an augmented operad  $\mathcal{P}$  is the quotient

$$\mathcal{N}_l(\mathcal{P}) := \mathcal{C}_l(\mathcal{P}) / \sum_{0 \leq j \leq l-1} \text{Im}(s_j)$$

equipped with the boundary map induced by the faces.

The  $\mathbb{S}$ -module  $\mathcal{N}_l(\mathcal{P})$  is isomorphic to the direct summand of  $\mathcal{C}_l(\mathcal{P})$  composed by  $l$ -levelled trees with at least one element of  $\bar{\mathcal{P}}$  on each level. The canonical projection of complexes  $\mathcal{C}(\mathcal{P}) \rightarrow \mathcal{N}(\mathcal{P})$  is a quasi-isomorphism (see E.B. Curtis [Cu] Section 3 or J.P. May [May] Chapter V for this classical result).

Once again, the simplicial bar construction of a quadratic operad  $\mathcal{P}$  is a direct sum, indexed by  $m \in \mathbb{N}$ , of the subcomplexes of  $\mathcal{C}(\mathcal{P})$  composed by elements of global

---

## HOMOLOGY OF GENERALIZED PARTITION POSETS

---

weight  $m$ , and denoted by  $\mathcal{C}(\mathcal{P})_{(m)}$ . The same decomposition holds for the normalized bar construction  $\mathcal{N}(\mathcal{P}) = \bigoplus_{m \in \mathbb{N}} \mathcal{N}(\mathcal{P})_{(m)}$ , and the canonical projection preserves this weight. Therefore, the canonical projection maps  $\mathcal{C}(\mathcal{P})_{(m)} \rightarrow \mathcal{N}(\mathcal{P})_{(m)}$  are quasi-isomorphisms.

**3.2.2. Homology of the normalized bar construction and Koszul duality of an operad.** We recall the quasi-isomorphism between the differential and the normalized bar constructions of an operad due to B. Fresse. It shows that a quadratic operad is Koszul if and only if the homology of the normalized bar construction is concentrated in top dimension.

One can consider the homological degree of the bar construction given by the number of vertices of the trees. We denote it by  $\mathcal{B}_{(l)}(\mathcal{P}) = \mathcal{F}_{(l)}^c(\Sigma^{-1}\bar{\mathcal{P}})$ . It is equal to the number of signs  $\Sigma^{-1}$  used to write an element. Be careful, this degree is different from the cohomological degree  $(p_1 + \dots + p_l - l)$  and also different from the global weight taken without the desuspension  $(p_1 + \dots + p_l)$ . The relation between these three graduations is obvious. The sum of the homological degree with the cohomological degree gives the global weight.

In [F] (section 4), B. Fresse defines a morphism, called the *levelization morphism*, between the differential bar construction and the normalized bar construction of an operad. It is defined from  $\mathcal{B}_{(l)}(\mathcal{P})$  to  $\mathcal{N}_l(\mathcal{P})$ . This levelization morphism induces a morphism of complexes when one considers the homological degree on the differential bar construction.

**THEOREM 4.** [F] (Theorem 4.1.8.) *Let  $\mathcal{P}$  be an operad such that  $\mathcal{P}(0) = 0$  and  $\mathcal{P}(1) = k$ . The levelization morphism  $\mathcal{B}(\mathcal{P}) \rightarrow \mathcal{N}(\mathcal{P})$  is a quasi-isomorphism.*

**REMARK.** Since the normalized and the simplicial bar constructions are quasi-isomorphic, the bar construction  $\mathcal{B}(\mathcal{P})$  of an operad is quasi-isomorphic to the simplicial bar construction  $\mathcal{C}(\mathcal{P})$ .

As we have seen before, the normalized bar construction of a quadratic operad  $\mathcal{P}$  is a direct sum, indexed by the weight  $(m)$ , of the subcomplexes of  $\mathcal{N}(\mathcal{P})$ , composed by elements of global weight  $m$ . The levelization morphism preserves this weight. Therefore, the legalization morphism  $\mathcal{B}_{(l)}(\mathcal{P})_{(m)} \rightarrow \mathcal{N}_l(\mathcal{P})_{(m)}$  is a quasi-isomorphism for any  $l$  and any  $m$ .

**COROLLARY 5.** *Let  $\mathcal{P}$  be a quadratic operad generated by a finite dimensional space  $V$ .*

- (1) *We have  $H_m(\mathcal{N}_*(\mathcal{P})_{(m)}) \cong \mathcal{P}_{(m)}^i$ .*
- (2) *The operad  $\mathcal{P}$  is a Koszul operad if and only if  $H_l(\mathcal{N}_*(\mathcal{P})_{(m)}) = 0$  for  $l \neq m$ .*

**PROOF.** This corollary is the analog of Theorem 1 with the quasi-isomorphisms given in Theorem 4. For the first point, we have the following identities

$$\mathcal{P}_{(m)}^i \cong H^0(\mathcal{B}^*(\mathcal{P})_{(m)}) = H_m(\mathcal{B}_{(*)}(\mathcal{P})_{(m)}) \cong H_m(\mathcal{N}_*(\mathcal{P})_{(m)}).$$

For the second point, we know from Theorem 1 that  $\mathcal{P}$  is a Koszul operad if and only if  $H^k(\mathcal{B}^*(\mathcal{P})) = 0$  for any  $k > 0$ , which is equivalent to  $H_l(\mathcal{B}_{(*)}(\mathcal{P})_{(m)}) = 0$  for  $l \neq m$  with the homological degree. The isomorphisms between the differential and the normalized bar constructions of Theorem 4 give that  $\mathcal{P}$  is a Koszul operad if and only if  $H_l(\mathcal{N}_{(*)}(\mathcal{P})_{(m)}) = 0$  for  $l \neq m$ .  $\square$

**3.3. Homology of a partition poset associated to an operad.** We prove that an operad is Koszul if and only if the related complex is Cohen-Macaulay. In this case, the homology of the poset is isomorphic, as an  $\mathbb{S}$ -module, to the Koszul dual cooperad.

Let  $\mathcal{P}$  be a set operad and  $\tilde{\mathcal{P}} = k[\mathcal{P}]$  the corresponding algebraic operad.

DEFINITION ( $\mathcal{C}(\mathcal{P})(I)$  and  $\mathcal{N}(\mathcal{P})(I)$ ). Let  $I$  be a set with  $n$  element ( $\{x_1, \dots, x_n\}$  or  $[n]$  for instance). The set  $\mathcal{C}_l(\mathcal{P})(I)$  is the set of  $l$ -levelled trees with the vertices indexed by elements of  $\mathcal{P}$  and where each leaf is indexed by a different element of  $I$  (cf. figure 2). When  $I = [n]$ , we denote the set  $\mathcal{C}(\mathcal{P})(I)$  by  $\mathcal{C}(\mathcal{P})(n)$ .

The normalized part  $\mathcal{N}(\mathcal{P})(I)$  is given by the subset of  $\mathcal{C}(\mathcal{P})(I)$  generated by the same levelled trees such that at least one vertex on each level is indexed by an element of  $\mathcal{P}_n$  with  $n > 1$ .

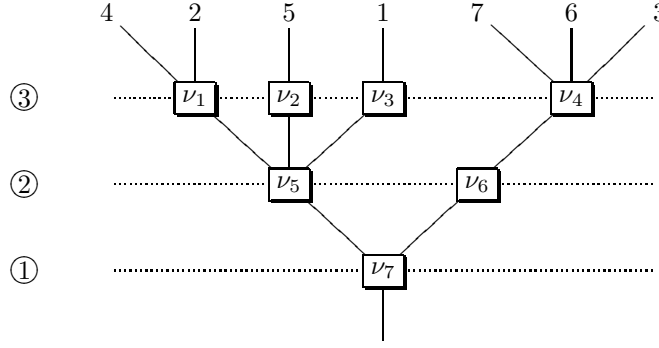

FIGURE 2. An example of a 3-levelled tree with the vertices indexed by elements of  $\mathcal{P}$ .

LEMMA 6.

- (1) The set  $\mathcal{C}(\mathcal{P})(n)$  is stable under the face maps  $d_i$  and the degeneracy maps  $s_j$  of the simplicial bar construction  $\mathcal{C}(\tilde{\mathcal{P}})(n)$ , making it a simplicial set. The set  $\mathcal{N}(\mathcal{P})(n)$  is its normalized associated set.
- (2) The set  $\mathcal{C}(\mathcal{P})$  is a basis over  $k$  of the simplicial bar construction  $\mathcal{C}(\tilde{\mathcal{P}})$  and  $\mathcal{N}(\mathcal{P})$  is a basis of the normalized bar construction  $\mathcal{N}(\tilde{\mathcal{P}})$ .

PROOF. The proof is a direct consequence of the definition of a set operad  $\mathcal{P}$ .  $\square$

In the rest of the text, we will need that the set operad  $\mathcal{P}$  is a basic set operad (see section 2).

THEOREM 7. Let  $\mathcal{P}$  be a basic-set operad.

For any  $n \in \mathbb{N}^*$ , the order set  $\Delta_*(\Pi_{\mathcal{P}}(n))$  is isomorphic to  $\mathcal{N}_*(\mathcal{P})(n)$ . This isomorphism preserves the face maps  $d_i$  for  $0 < i < l$  and the action of  $\mathbb{S}_n$ . It induces an isomorphism of presimplicial  $k[\mathbb{S}_n]$ -modules between the order complex  $k[\Delta(\Pi_{\mathcal{P}}(n))]$  and the normalized bar construction  $\mathcal{N}(\tilde{\mathcal{P}})(n)$ .

---

**HOMOLOGY OF GENERALIZED PARTITION POSETS**

---

PROOF. We are going to describe a bijection  $\Psi$  between  $\mathcal{N}_l(\mathcal{P})(n)$  and  $\Delta_l(\Pi_{\mathcal{P}}(n))$ .

Let  $\mathfrak{T}$  be a non planar tree with  $l$  levels and  $n$  leaves whose vertices are indexed by elements of  $\mathcal{P}$ . To such a tree, we build a chain of  $\mathcal{P}$ -partitions of  $[n]$  in the following way : we cut the tree  $\mathfrak{T}$  along the  $i^{th}$  level and we look upwards. We get  $t$  indexed and labelled subtrees. Each of them induces an element in a  $\mathcal{P}_{i_j}(I_j)$  by composing the operations indexing the vertices along the scheme given by the subtree. The figure 3 shows an example in the case of the operad  $Com$ .

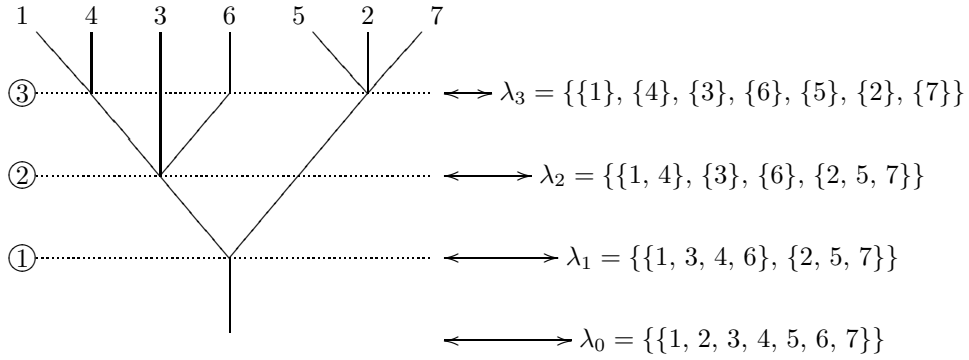

FIGURE 3. An example of the image of  $\Psi$  in the case  $\mathcal{P} = Com$ .

The union of these elements forms a  $\mathcal{P}$ -partition  $\lambda_i$  of  $[n]$ . At the end, by cutting the tree  $\mathfrak{T}$  at the root, we get one minimal  $\mathcal{P}$ -partition  $\lambda_0 \in \mathcal{P}_n([n])$ .

Since  $\lambda_{i+1}$  is a strict refinement of  $\lambda_i$ , the growing sequence of  $\mathcal{P}$ -partitions  $\lambda_0 < \lambda_1 < \dots < \lambda_l$  is an element of  $\Delta_l(\Pi_{\mathcal{P}}(n))$ . We denote this map by  $\Psi$ .

The surjectivity of the map  $\Psi$  comes from the definition of the partial order between the  $\mathcal{P}$ -partitions. And the injectivity of the maps  $\mu_{(\nu_1, \dots, \nu_t)}$  induces the injectivity of  $\Psi$ . Therefore,  $\Psi$  is a bijection.

Contracting the  $i^{th}$  and the  $(i + 1)^{th}$  levels of the tree  $\mathfrak{T}$  corresponds, via  $\Psi$ , to removing the  $i^{th}$  partition of the chain  $\lambda_0 < \lambda_1 < \dots < \lambda_l$ . Moreover  $\Psi$  preserves the action of the symmetric group  $\mathbb{S}_n$ . Therefore,  $\Psi$  induces an isomorphism of presimplicial  $k[\mathbb{S}_n]$ -modules.  $\square$

**THEOREM 8.** *Let  $\mathcal{P}$  be a basic-set and quadratic operad generated by an homogenous  $\mathbb{S}$ -set  $V$  such that  $V(t) \neq 0$ .*

- (1) *We have  $H_m(\Pi_{\mathcal{P}}(m(t - 1) + 1)) \cong \tilde{\mathcal{P}}_{(m)}^i$ .*
- (2) *The operad  $\tilde{\mathcal{P}}$  is a Koszul operad if and only if  $H_l(\Pi_{\mathcal{P}}(m(t - 1) + 1)) = 0$  for  $l \neq m$ .*

PROOF. Since the operad  $\mathcal{P}$  is quadratic and generated by  $t$ -ary operations, we have  $\mathcal{N}_*(\mathcal{P})_{(m)} = \mathcal{N}_*(\mathcal{P})(m(t - 1) + 1)$ . The theorem 7 implies that  $H_l(\mathcal{N}_*(\mathcal{P})(m(t - 1) + 1)) = H_l(\Pi_{\mathcal{P}}(m(t - 1) + 1))$  for any  $k$ . With this quasi-isomorphism, this theorem is a rewriting of the corollary 5, in the framework of posets.  $\square$

With the notion of Cohen-Macaulay posets, this theorem implies the following one.

**THEOREM 9.** *Let  $\mathcal{P}$  be a basic-set and quadratic operad generated by an homogenous  $\mathbb{S}$ -set  $V$  such that  $V(t) \neq 0$ .*

*The operad  $\tilde{\mathcal{P}}$  is a Koszul operad if and only if each subposet  $[\alpha, \hat{1}]$  of each  $\Pi_{\mathcal{P}}(n)$  is Cohen-Macaulay, where  $\alpha$  belongs to  $\text{Min}(\Pi_{\mathcal{P}}(n)) = \mathcal{P}_n([n])$ .*

**PROOF.**

( $\Rightarrow$ ) The proposition 3 shows that  $\Pi_{\mathcal{P}}$  is pure. Therefore, each subposet of the form  $[\alpha, \hat{1}]$  is graded.

If the operad  $\tilde{\mathcal{P}}$  is Koszul, we have by Theorem 8 that the homology of each poset  $\Pi_{\mathcal{P}}(m(t-1)+1)$  is concentrated in top dimension  $m$ . Since

$$H_l(\Pi_{\mathcal{P}}(m(t-1)+1)) = \bigoplus_{\alpha \in \text{Min}(\Pi_{\mathcal{P}}(m(t-1)+1))} \tilde{H}_{l-2}((\alpha, \hat{1})),$$

we have  $H_l([\alpha, \hat{1}]) = \tilde{H}_{l-2}((\alpha, \hat{1})) = 0$  for  $l \neq m$ . Let  $x \leq y$  be two elements of  $\Pi_{\mathcal{P}}(m(t-1)+1)$ . Denote the  $\mathcal{P}$ -partition  $x$  by  $\{B_1, \dots, B_r\}$  and  $y$  by  $\{C_1, \dots, C_s\}$ . Each  $B_k \in \beta_{i_k}(I_k)$  is refined by some  $C_l$ . For any  $1 \leq k \leq r$ , we consider the subposet  $[x_k, y_k]$  of  $\Pi_{\mathcal{P}}(I_k)$ , where  $x_k = B_k$  and  $y_k$  the corresponding set of  $C_l$ . There exists one  $\alpha_k \in \text{Min}(\Pi_{\mathcal{P}}(|y_k|))$  such that the poset  $[x_k, y_k]$  is isomorphic to  $[\alpha_k, \hat{1}]$ , which is a subposet of  $\Pi_{\mathcal{P}}(|y_k|)$ . (The notation  $|y_k|$  represents the number of  $C_l$  in  $y_k$ .) This decomposition gives, with the Künneth theorem, the following formula

$$\tilde{H}_{l-1}((x, y)) \cong \bigoplus_{l_1 + \dots + l_r = l} \bigotimes_{k=1}^r \tilde{H}_{l_k-1}((x_k, y_k)) \cong \bigoplus_{l_1 + \dots + l_r = l} \bigotimes_{k=1}^r \tilde{H}_{l_k-1}((\alpha_k, \hat{1})).$$

(We can apply Künneth formula since we are working with chain complexes of free modules over an hereditary ring  $k$ . The extra Tor terms in Künneth formula come from homology groups of lower dimension which are null). If we define  $m_k$  by  $|y_k| = m_k(t-1) + 1$ , the homology groups  $\tilde{H}_{l_k-1}((\alpha_k, \hat{1}))$  are null for  $l_k \neq m_k - 1$ . Therefore, if  $l$  is different from  $\sum_{k=1}^r (m_k - 1)$ , we have  $\tilde{H}_{l-1}((x, y)) = 0$ . Since, the length of maximal chains between  $x$  and  $y$  is equal to  $d = \sum_{k=1}^r (m_k - 1) + 1$  (cf. proposition 3), the homology of the interval  $[x, y]$  is concentrated in top dimension. ( $\Leftarrow$ ) Conversely, if the poset  $\Pi_{\mathcal{P}}$  is Cohen-Macaulay over the ring  $k$ , we have for any  $m \geq 1$  and any  $\alpha \in \text{Min}(\Pi_{\mathcal{P}}(m(t-1)+1))$  that  $\tilde{H}_{l-2}((\alpha, \hat{1})) = 0$ , if  $l \neq m$ . Therefore, we get

$$H_l(\Pi_{\mathcal{P}}(m(t-1)+1)) = \bigoplus_{\alpha \in \text{Min}(\Pi_{\mathcal{P}}(m(t-1)+1))} \tilde{H}_{l-2}((\alpha, \hat{1})) = 0,$$

if  $l \neq m$ . And we conclude by the theorem 8.  $\square$

**REMARK.** To a graded poset, one can associate an algebra called *incidence algebra*. This incidence algebra is Koszul if and only if the poset is Cohen-Macaulay (cf. C. Cibils [Ci], P. Polo [P] and D. Woodcock [W]). To a basic-set operad, one can define many incidence algebras (one for each  $n \in \mathbb{N}^*$  and each  $\alpha \in \mathcal{P}_n([n])$ ). A direct corollary of this theorem and the present work claims that a basic-set operad is Koszul if and only if all its associated incidence algebras are Koszul.



4. EXAMPLES

We introduce new partition type posets arising from operads. Using the last theorem, we compute their homology in terms of the Koszul dual cooperad.

**4.1. Homology of the partition poset  $\Pi$  and the operad  $Com$ .** In this section, we mainly recall the result of [F] which relates the homology of the partition poset with the operad  $Com$  of commutative algebras.

The operad  $Com$  is a binary quadratic operad corresponding to commutative algebras. Since there is only one multi-linear operations with  $n$  variables on a commutative algebra, the module  $Com_n$  has only one element.

**DEFINITION (Operad  $Com$ ).** The operad  $Com$  is defined by  $Com_n := \{e_n\}$ , with  $e_n$  invariant under the action of  $\mathbb{S}_n$ . Since  $Com_n$  has only one element the composition of the operad  $Com$  is obvious. The operad  $Com$  is a basic set operad.

Since  $\overline{e_n \times (x_1, \dots, x_n)} = \overline{e_n \times (x_{\sigma^{-1}(1)}, \dots, x_{\sigma^{-1}(n)})}$ , we have that  $Com(I)$  has only one element which corresponds to the block  $\{x_1, \dots, x_n\}$ . Therefore a  $Com$ -partition is a classical partition of  $[n]$  and the order between  $Com$ -partitions is given by the refinement of partitions.

A. Björner showed in [B] that the posets of partitions are Cohen-Macaulay by defining an EL-labelling on them. Hence, the homology of the partition poset is concentrated in top dimension and given by

$$H_l(\Pi(n)) \cong \begin{cases} \mathcal{L}ie(n)^* \otimes \text{sgn}_n & \text{if } l = n - 1 \\ 0 & \text{otherwise,} \end{cases}$$

where  $\mathcal{L}ie(n)$  is the representation of  $\mathbb{S}_n$  defined by the operad  $\mathcal{L}ie$  of Lie algebras (cf. [F, RW]).

**REMARK.** P. Hanlon and M. Wachs have defined posets of partitions with restricted block size in [HW]. Each poset corresponds to an operadic poset build on the operad  $t - Com$  generated by a  $t$ -ary commutative operation (cf. [G]). The same EL-labelling as in the classical partition poset works here. Therefore, we get that the operads  $t - Com$  and their duals  $t - \mathcal{L}ie$  are Koszul over  $\mathbb{Z}$  and over any field  $k$ .

**4.2. Homology of the pointed partition poset  $\Pi_P$  and the operad  $Perm$ .** Following the same ideas, we introduce the poset of pointed partitions coming from the operad  $Perm$ . We show that the homology of the pointed partition posets is given by the Koszul dual cooperad of the operad  $Perm : \mathcal{P}relie^\vee$ .

**4.2.1. The operad  $Perm$ .** The operad  $Perm$ , for permutation, has been introduced by F. Chapoton in [C1].

A *Perm-algebra* is an associative algebra such that  $x * y * z = x * z * y$  for any  $x$ ,  $y$  and  $z$ .

**DEFINITION (operad  $Perm$ ).** The operad  $Perm$  is the quadratic operad generated by a binary operation  $*$  and the following relations

- (1) (*Associativity*)  $(x * y) * z = x * (y * z)$  for any  $x$ ,  $y$  and  $z$ ,
- (2) (*Permutation*)  $x * y * z = x * z * y$  for any  $x$ ,  $y$  and  $z$ .

We recall a result due to F. Chapoton. The algebraic operad  $\mathcal{P}erm$  comes from the following set operad  $\mathcal{P}erm_n := \{e_1^n, \dots, e_n^n\}$  and, the composition  $\mu$  is given by the formula :

$$\begin{aligned} \mathcal{P}erm_n \otimes \mathcal{P}erm_{i_1} \otimes \dots \otimes \mathcal{P}erm_{i_n} &\xrightarrow{\mu} \mathcal{P}erm_{i_1+\dots+i_n} \\ e_k^n \otimes e_{j_1}^{i_1} \otimes \dots \otimes e_{j_n}^{i_n} &\mapsto e_{i_1+\dots+i_{k-1}+j_k}^{i_1+\dots+i_n} \end{aligned}$$

(We denote by  $\mathcal{P}erm$  the two operads.) The image under the action of  $\sigma \in \mathbb{S}_n$  of the vector  $e_k^n$  is  $e_{\sigma^{-1}(k)}^n$ .

PROPOSITION 10. *The operad  $\mathcal{P}erm$  is a basic-set operad.*

PROOF. The above formula of  $\mu$  shows that every maps of the form  $\mu_{(\nu_1, \dots, \nu_n)}$ , where  $\nu_l = e_{j_l}^{i_l}$ , are injective.  $\square$

4.2.2. **The posets  $\Pi_{\mathcal{P}}$  of pointed partitions.** We describe the posets associated to the operad  $\mathcal{P}erm$  in terms of pointed partitions.

Since  $\overline{e_i^n \times (x_1, \dots, x_n)} = \overline{e_{\sigma^{-1}(i)}^n \times (x_{\sigma^{-1}(1)}, \dots, x_{\sigma^{-1}(n)})}$  in  $\mathcal{P}erm(I)$ , we choose to represent this class of elements by  $\{x_1, \dots, \bar{x}_i, \dots, x_n\}$ , where the order between the  $x_i$  does not care. The only remaining information is which element is pointed. With this identification, the set  $\mathcal{P}erm_n([n])$  is equal to the set  $\{\{1, \dots, \bar{i}, \dots, n\}\}_{1 \leq i \leq n}$ , for any  $n \in \mathbb{N}^*$ .

DEFINITION (Pointed partitions). A *pointed partition*  $\{B_1, \dots, B_k\}$  of  $[n]$  is a partition on which one element of each block  $B_i$  is emphasized.

For instance,  $\{\{\bar{1}, 3\}, \{2, \bar{4}\}\}$  is a pointed partition of  $\{1, 2, 3, 4\}$ .

The partial order on pointed partitions is a pointed variation of the one for classical partitions. It is defined as follows.

DEFINITION (Pointed partition poset,  $\Pi_{\mathcal{P}}$ ). Let  $\lambda$  and  $\mu$  be two pointed partitions. We say that  $\mu$  is larger than  $\lambda$  ( $\lambda \leq \mu$ ) if the pointed integers of  $\lambda$  belongs to the set of the pointed integers of  $\mu$  and if  $\mu$  is a refinement of  $\lambda$  as a partition. This poset is called the *pointed partition poset* and denoted by  $\Pi_{\mathcal{P}}(n)$ .

For example, one has  $\{\{\bar{1}, 3\}, \{2, \bar{4}\}\} \leq \{\{\bar{1}\}, \{\bar{3}\}, \{2, \bar{4}\}\}$ . The largest element is  $\{\{\bar{1}\}, \dots, \{\bar{n}\}\}$ . But there are  $n$  minimal elements of the type  $\{\{1, \dots, \bar{i}, \dots, n\}\}$ . This poset is pure but not bounded.

We extend the action of the symmetric group in this case. Since the image of a pointed integer under a permutation  $\sigma \in \mathbb{S}_n$  gives a pointed integer, the symmetric group  $\mathbb{S}_n$  acts on the pointed partitions of  $\{1, \dots, n\}$ .

PROPOSITION 11. *The operadic poset  $\Pi_{\mathcal{P}erm}$  associated to the operad  $\mathcal{P}erm$  is isomorphic to the poset of pointed partitions  $\Pi_{\mathcal{P}}$ .*

PROOF. In the case of the poset  $\Pi_{\mathcal{P}erm}$ , the order is defined by the refinement of  $\mathcal{P}erm$ -partitions. With the identification  $\mathcal{P}erm_n([n]) = \{\{1, \dots, \bar{i}, \dots, n\}\}_{1 \leq i \leq n}$ , it corresponds to the refinement of pointed partitions.  $\square$

**4.2.3. Homology of the poset  $\Pi_P$ .** We can use the properties of the operad  $\mathcal{P}erm$  to compute the homology of the pointed partition poset.

DEFINITION (PreLie algebra). A *PreLie algebra* is a  $k$ -module  $L$  equipped with a binary operation  $\circ$  such that

$$(x \circ y) \circ z - x \circ (y \circ z) = (x \circ z) \circ y - x \circ (z \circ y).$$

We denote by  $\mathcal{P}relie$  the related operad.

PROPOSITION 12. [CV] *The pointed partition posets are totally semi-modular. Recall that it implies that these posets are Cohen-Macaulay over  $k$ .*

THEOREM 13 (Homology of the pointed partition poset,  $\Pi_P$ ). *The homology of the pointed partition poset is the  $\mathbb{S}_n$ -module*

$$H_l(\Pi_P(n)) \cong \begin{cases} \mathcal{P}relie(n)^* \otimes \text{sgn}_{\mathbb{S}_n} & \text{if } l = n - 1 \\ 0 & \text{otherwise.} \end{cases}$$

PROOF. The proof is a direct consequence of Theorems 8 and 12. □

REMARK. The operad  $\mathcal{P}relie$  is isomorphic to the operad  $\mathcal{RT}$  of *Rooted Trees* [CL]. Therefore, the  $\mathbb{S}_n$ -module  $\mathcal{P}relie(n)$  is isomorphic to the free  $k$ -module on rooted trees whose vertices are labelled by  $\{1, \dots, n\}$ , with the natural action of  $\mathbb{S}_n$  on them.

We refer the reader to the article [CV] of F. Chapoton and the author for a study of the properties of the pointed partition posets.

**4.3. Homology of the multi-pointed partition poset  $\Pi_{MP}$  and the operad  $\mathcal{ComTrias}$ .** To compute the homology of the multi-pointed partition poset, we define a commutative version of the operad  $\mathcal{T}rias$ , which we call the  $\mathcal{ComTrias}$  operad. We study its Koszul dual operad, called the  $\mathcal{PostLie}$  operad. (We prove in the appendix that these operads are Koszul.)

**4.3.1. The operad  $\mathcal{ComTrias}$ .**

DEFINITION (Commutative trialgebra). A *commutative trialgebra* is a  $k$ -module  $A$  equipped with two binary operations  $*$  and  $\bullet$  such that  $(A, *)$  is a  $\mathcal{P}erm$ -algebra

$$(x * y) * z = x * (y * z) = x * (z * y),$$

$(A, \bullet)$  is a commutative algebra

$$\begin{cases} x \bullet y & = & y \bullet x, \\ (x \bullet y) \bullet z & = & x \bullet (y \bullet z), \end{cases}$$

and the two operations  $*$  and  $\bullet$  must verify the following compatibility relations

$$\begin{cases} x * (y \bullet z) & = & x * (y * z), \\ (x \bullet y) * z & = & x \bullet (y * z). \end{cases}$$

DEFINITION ( $\mathcal{ComTrias}$  operad). We denote by  $\mathcal{ComTrias}$ , the operad coding the commutative trialgebras.

The operad  $\mathcal{ComTrias}$  is an operad generated by two operations  $*$  and  $\bullet$  and the relations defined before. As a consequence of Theorem 28, giving the free commutative trialgebra, we have the following complete description of this operad.

THEOREM 14. For any  $n \leq 1$ , the  $\mathbb{S}_n$ -module  $ComTrias(n)$  is isomorphic to the free  $k$ -module on  $ComTrias_n = \{e_J^n / J \subset [n], J \neq \emptyset\}$ , where the action of  $\mathbb{S}_n$  is induced by the natural action on the subsets  $J$  of  $[n]$ .

The composition of the operad  $ComTrias$  is given by the formula

$$\begin{aligned} ComTrias_k \otimes ComTrias_{i_1} \otimes \cdots \otimes ComTrias_{i_k} &\rightarrow ComTrias_{i_1 + \cdots + i_k = n} \\ e_J^k \otimes e_{J_1}^{i_1} \otimes \cdots \otimes e_{J_k}^{i_k} &\mapsto e_J^n, \end{aligned}$$

where  $\bar{J} = \bigcup_{j \in J} (i_1 + \cdots + i_{j-1}) + J_j$ . (The subset of  $[n]$  denoted by  $(i_1 + \cdots + i_{j-1}) + J_j$  is defined by  $\bigcup_{a \in J_j} \{i_1 + \cdots + i_{j-1} + a\}$ .)

PROOF. Let  $\mathcal{P}$  be the  $\mathbb{S}$ -module generated by the sets  $ComTrias_n$  ( $\mathcal{P}(n) = k[ComTrias_n]$ ). We consider the Schur functor associated to  $\mathcal{P}$ . For any  $k$ -module  $V$ , we have  $\mathcal{S}_{\mathcal{P}}(V) = \bigoplus_{n \geq 1} k[\beta_n] \otimes_{\mathbb{S}_n} V^{\otimes n}$ . We denote the element  $e_J^n \otimes (x_1, \dots, x_n)$  of  $k[ComTrias_n] \otimes V^{\otimes n}$  by  $x_{j_1} \dots x_{j_k} \otimes x_{l_1} \dots x_{l_m}$ , where  $J = \{j_1, \dots, j_k\}$  and  $[n] - J = \{l_1, \dots, l_m\}$ . Therefore, we get

$$\mathcal{S}_{\mathcal{P}}(V) = \bigoplus_{n \geq 1} \bigoplus_{j=1}^n \bigoplus_{|J|=j} k[e_J^n] \otimes_{\mathbb{S}_n} V^{\otimes n} \cong \bigoplus_{n \geq 1} \bigoplus_{j=1}^n \bar{S}_j(V) \otimes S_{n-j}(V) = \bar{S}(V) \otimes S(V).$$

Since  $\mathcal{S}_{\mathcal{P}}(V)$  is equal to  $\mathcal{S}_{ComTrias}(V)$  for any  $k$ -module  $V$ , the  $\mathbb{S}$ -module  $\mathcal{P}$  is isomorphic to  $ComTrias$ . With the following identifications

$$e_{\{1\}}^2 \longleftrightarrow * \quad , \quad e_{\{2\}}^2 \longleftrightarrow *^{(1,2)} \quad , \quad e_{\{1,2\}}^2 \longleftrightarrow \bullet,$$

one can easily see that  $\mathcal{S}_{\mathcal{P}}(V)$  is the free commutative trialgebra defined in the previous theorem. The following diagram is commutative.

$$\begin{array}{ccc} \mathcal{S}_{\mathcal{P}} \circ \mathcal{S}_{\mathcal{P}} & \xrightarrow{\quad} & \mathcal{S}_{ComTrias} \circ \mathcal{S}_{ComTrias} \\ \downarrow \mu_{\mathcal{P}} & & \downarrow \mu_{ComTrias} \\ \mathcal{S}_{\mathcal{P}} & \xrightarrow{\quad} & \mathcal{S}_{ComTrias} \end{array}$$

We conclude that the operads  $\mathcal{P}$  and  $ComTrias$  are isomorphic.  $\square$

COROLLARY 15. The operad  $ComTrias$  is a basic-set operad.

PROOF. It remains to prove that on the  $ComTrias_n$  the maps  $\mu_{(\nu_1, \dots, \nu_k)}$  are injective, which is straightforward.  $\square$

REMARK. The elements of  $ComTrias(n)$  can be indexed by the cells of the simplex of dimension  $n - 1$ :  $\Delta^{n-1}$ . The action of  $\mathbb{S}_n$  on  $ComTrias(n)$  corresponds to the action of  $S_n$  on the faces of  $\Delta^{n-1}$ .

4.3.2. **The posets  $\Pi_{MP}$  of multi-pointed partitions.** We describe the posets  $\Pi_{ComTrias}$  in terms of multi-pointed partitions.

Following the same idea as in the previous case, we choose to represent the element  $e_J^n \times (x_1, \dots, x_n)$  of  $ComTrias_n([n])$  by  $\{x_1, \dots, \bar{x}_{j_1}, \dots, \bar{x}_{j_k}, \dots, x_n\}$ , where  $J = \{j_1, \dots, j_k\}$ .

DEFINITION (Multi-pointed partition). A *multi-pointed partition*  $\{B_1, \dots, B_k\}$  of  $[n]$  is a partition on which at least one element of each block  $B_i$  is emphasized.

---

## HOMOLOGY OF GENERALIZED PARTITION POSETS

---

DEFINITION (Multi-pointed partition poset,  $\Pi_{MP}$ ). Let  $\lambda$  and  $\mu$  be two multi-pointed partitions. We say that  $\mu$  is larger than  $\lambda$  ( $\lambda \leq \mu$ ) if  $\mu$  is a refinement of  $\lambda$  as a partition and if for each block  $B$  of  $\mu$ , all the pointed integers of  $B$  remain pointed in  $\lambda$  or all become unpointed. This poset is called the *multi-pointed partition poset* and denoted by  $\Pi_{MP}(n)$ .

The action of the symmetric group is defined in a similar way and preserves the partial order  $\leq$ . With this identification, one can see that the refinement of *ComTrias*-partitions corresponds to the refinement of multi-pointed partitions. Therefore, we have the following proposition.

PROPOSITION 16. *The operadic poset  $\Pi_{ComTrias}$  is isomorphic to the poset of multi-pointed pointed partitions  $\Pi_{MP}$ .*

### 4.3.3. Homology of the poset $\Pi_{MP}$ .

DEFINITION (PostLie algebra). A *PostLie algebra* is a  $k$ -module  $L$  equipped with two binary operations  $\circ$  and  $[\ , \ ]$  such that  $(L, [\ , \ ])$  is a Lie algebra

$$\begin{cases} [x, y] = -[y, x] \\ [x, [y, z]] + [y, [z, x]] + [z, [x, y]] = 0 \end{cases}$$

and such that the two operations  $\circ$  and  $[\ , \ ]$  verify the following compatibility relations

$$\begin{cases} (x \circ y) \circ z - x \circ (y \circ z) - (x \circ z) \circ y + x \circ (z \circ y) = x \circ [y, z], \\ [x, y] \circ z = [x \circ z, y] + [x, y \circ z] \end{cases}$$

DEFINITION (*PostLie* operad). We denote by  $\mathcal{P}ostLie$ , the operad coding the PostLie algebras.

Theorem 30 proves that the operad  $\mathcal{P}ostLie$  is the Koszul dual of *ComTrias*. In [CV], we have shown that the posets of multi-pointed partitions are totally semi-modular. Therefore, they are Cohen-Macaulay and we have the following theorem.

THEOREM 17 (Homology of the multi-pointed partition poset,  $\Pi_{MP}$ ). *The homology of the multi-pointed partition poset  $\Pi_{MP}$  with coefficient in  $k$  is the  $\mathbb{S}_n$ -module*

$$H_l(\Pi_{MP}(n)) \cong \begin{cases} (\mathcal{L}ie \circ \mathcal{M}ag)^*(n) \otimes sgn_{\mathbb{S}_n} & \text{if } l = n - 1 \\ 0 & \text{otherwise.} \end{cases}$$

REMARK. We refer the reader to [CV] for further properties on the multi-pointed partition posets.

### 4.4. Homology of the ordered partition poset $\Pi_O$ and the operad $\mathcal{A}s$ .

The posets associated to the operad  $\mathcal{A}s$  are the posets of ordered partitions (or bracketing). The homology of these posets is given by the Koszul dual cooperad of the operad  $\mathcal{A}s : \mathcal{A}s^\vee$ .

4.4.1. **The operad  $\mathcal{A}s$ .** The operad  $\mathcal{A}s$  corresponds to the operad of associative algebras. This operad is generated by one non-symmetric binary operation and the associativity relation. One has a complete description of it. Up to permutation, there exists only one associative operation on  $n$  variables. Therefore, we have  $\mathcal{A}s(n) = k[\mathbb{S}_n]$ , the regular representation of  $\mathbb{S}_n$ .

The operad  $\mathcal{A}s$  comes from the set operad  $\mathcal{A}s_n = \mathbb{S}_n$  with the following composition maps

$$\begin{aligned} \mathbb{S}_n \times \mathbb{S}_{i_1} \times \cdots \times \mathbb{S}_{i_n} &\xrightarrow{\mu} \mathbb{S}_{i_1+\cdots+i_n} \\ \pi \times (\tau_1, \dots, \tau_n) &\mapsto [\tau_{\pi^{-1}(1)}, \dots, \tau_{\pi^{-1}(n)}], \end{aligned}$$

where  $[\tau_{\pi^{-1}(1)}, \dots, \tau_{\pi^{-1}(n)}]$  is the block permutation of  $\mathbb{S}_{i_1+\cdots+i_n}$  induced by  $\tau_{\pi^{-1}(1)}, \dots, \tau_{\pi^{-1}(n)}$ .

The image under the action of  $\sigma \in \mathbb{S}_n$  of the vector  $\tau \in \beta_n = \mathbb{S}_n$  is  $\tau\sigma$ .

PROPOSITION 18. *The operad  $\mathcal{A}s$  is a basic-set operad.*

PROOF. The composition maps  $\mu_{(\tau_1, \dots, \tau_n)}$  are clearly injective.  $\square$

4.4.2. **The posets  $\Pi_O$  of ordered partitions.** For any  $n \in \mathbb{N}^*$ , we choose to represent the element

$$\overline{\sigma \times (x_1, \dots, x_n)} = \overline{id \times (x_{\sigma(1)}, \dots, x_{\sigma(n)})}$$

of  $\mathcal{A}s_n([n])$  by  $(x_{\sigma(1)}, \dots, x_{\sigma(n)})$ .

DEFINITION (Ordered partitions). Any set  $\{B_1, \dots, B_r\}$  of ordered sets of elements of  $[n]$  that gives a partition when forgetting the order between the integers of each block is called an *ordered partition*.

For instance  $\{(3, 1), (2, 4)\}$  and  $\{(1), (3), (2, 4)\}$  are two ordered partitions of  $\{1, 2, 3, 4\}$ .

A partial order on the set of ordered partitions is defined as follows.

DEFINITION (Ordered partition poset,  $\Pi_O$ ). Let  $\lambda = \{B_1, \dots, B_r\}$  and  $\mu = \{C_1, \dots, C_s\}$  be two ordered partitions of  $[n]$ . We say that  $\mu$  is larger than  $\lambda$  ( $\lambda \leq \mu$ ) if, for every  $B_i$ , there exists an ordered sequence of  $C_j$  such that  $B_i = (C_{j_1}, \dots, C_{j_i})$ . We call this poset the *ordered partition poset* and we denote it by  $\Pi_O$ .

In the previous example,  $\{(3, 1), (2, 4)\} \leq \{(1), (3), (2, 4)\}$ . The minimal elements are of the form  $\{(\tau(1), \dots, \tau(n))\}$ , for  $\tau \in \mathbb{S}_n$ , and the maximal one is  $\{(1), \dots, (n)\}$ . This poset is pure.

The ordered partition poset is equipped with the natural action of the symmetric group  $\mathbb{S}_n$  which is compatible with the partial order. Observe that the action of  $\mathbb{S}_n$  on the set  $\Delta(\Pi_O(n))$  is free. All the intervals  $[\alpha, \hat{1}]$ , with  $\alpha \in \text{Min}(\Pi_O(n))$ , are isomorphic and the isomorphism between two of them is given by the action of an element of  $\mathbb{S}_n$ .

PROPOSITION 19. *The operadic poset  $\Pi_{\mathcal{A}s}$  associated to the operad  $\mathcal{A}s$  is isomorphic to the poset of ordered partitions  $\Pi_O$ .*

4.4.3. **Homology of the poset  $\Pi_O$ .**

PROPOSITION 20. *Every interval of the form  $[\alpha, \hat{1}]$  with  $\alpha \in \text{Min}(\Pi_O(n))$  is isomorphic to the boolean lattice of subsets of  $[n-1]$ . Therefore, the intervals  $[\alpha, \hat{1}]$  with  $\alpha \in \text{Min}(\Pi_O(n))$  are Cohen-Macaulay over  $k$ .*

---

## HOMOLOGY OF GENERALIZED PARTITION POSETS

---

PROOF. Since these intervals are all isomorphic, it is enough to prove it for one of them. Let  $\alpha$  be the ordered partition  $(1, 2, \dots, n)$  coming from the identity in  $\mathbb{S}_n = \mathcal{A}s_n$ . To an ordered partition  $(1, \dots, i_1), (i_1 + 1, \dots, i_2), \dots, (i_k + 1, \dots, n)$  of  $[\alpha, \hat{1}]$  with  $i_1 < i_2 < \dots < i_k$ , one can associate the subset  $\{i_1, \dots, i_k\}$  of  $[n - 1]$ . This map defines an isomorphism of posets.

THEOREM 21 (Homology of the ordered partition poset,  $\Pi_O$ ). *The homology of the ordered partition poset  $\Pi_O$  is the  $\mathbb{S}_n$ -module*

$$H_l(\Pi_O(n)) \cong \begin{cases} k[\mathbb{S}_n] & \text{if } l = n - 1 \\ 0 & \text{otherwise.} \end{cases}$$

REMARK. Proposition 20 proves that the operad  $\mathcal{A}s$  is Koszul over  $k$ .

**4.5. Homology of the pointed ordered partition poset  $\Pi_{PO}$  and the operad  $Dias$ .** From the operad  $Dias$  of associative dialgebras, we construct the pointed ordered partition posets. The homology of the pointed ordered partition poset  $\Pi_{PO}$  is given by the Koszul dual cooperad of the operad  $Dias : Dend^V$ .

**4.5.1. The operad  $Dias$ .** J.-L. Loday has defined the notion of *associative dialgebra* (cf. [L2]) in the following way. A *associative dialgebra* is a vector space  $D$  equipped with two binary operations  $\dashv$  and  $\vdash$  such that

$$\left\{ \begin{array}{l} (x \dashv y) \dashv z = x \dashv (y \vdash z) \\ (x \dashv y) \vdash z = x \dashv (y \dashv z) \\ (x \vdash y) \dashv z = x \vdash (y \dashv z) \\ (x \dashv y) \vdash z = x \vdash (y \vdash z) \\ (x \vdash y) \vdash z = x \vdash (y \vdash z) \end{array} \right.$$

The associated binary quadratic operad is denoted by  $Dias$ .

We have seen that the operad  $Perm$  is a pointed version of  $Com$ . The operad  $Dias$  is a pointed version of  $\mathcal{A}s$  mainly because  $Dias = Perm \otimes \mathcal{A}s$  (cf. [C1]). Each operation on  $n$  variables in  $Dias(n)$ , is an associative operation where one input is emphasized. Therefore, the  $\mathbb{S}_n$ -module  $Dias(n)$  is isomorphic to  $n$  copies of  $\mathcal{A}s(n)$ :

$$Dias(n) = k^n \otimes k[\mathbb{S}_n].$$

This operad comes from the following set operad  $Dias_n = \{e_k^n\}_{1 \leq k \leq n} \times \mathbb{S}_n$ .

PROPOSITION 22. *The operad  $Dias$  is a basic-set operad.*

PROOF. The proof is a direct consequence of the case  $Perm$  and  $\mathcal{A}s$ . □

**4.5.2. The posets  $\Pi_{PO}$  of pointed ordered partitions.** The set  $Dias_n([n])$  corresponds to the set  $\{(\tau(1), \dots, \overline{\tau(i)}, \dots, \tau(n))\}_{\tau \in \mathbb{S}_n, 1 \leq i \leq n}$ .

DEFINITION (Pointed ordered partition). A *pointed ordered partition* is an ordered partition  $\{B_1, \dots, B_k\}$  of  $[n]$  where, for each  $1 \leq i \leq k$ , an element of the sequence  $B_i$  is emphasized.

The partial order on pointed ordered partitions is a pointed variation of the one on ordered partitions.

DEFINITION (Pointed ordered partition poset,  $\Pi_{PO}$ ). Let  $\lambda$  and  $\mu$  be two pointed ordered partitions. We say that  $\mu$  is larger than  $\lambda$  if the pointed integers of  $\lambda$  belongs to the set of the pointed integers of  $\mu$  and if  $\mu$  is a larger then  $\lambda$  as ordered

partitions. This poset is called the *pointed ordered partition poset* and denoted by  $\Pi_{PO}$ .

For example, we have  $\{(3, \bar{1}), (2, \bar{4})\} \leq \{(\bar{1}), (\bar{3}), (2, \bar{4})\}$ . Any element of the form  $\{(\tau(1), \dots, \tau(i), \dots, \tau(n))\}$  is a minimal element in this poset, and  $\{(\bar{1}), \dots, (\bar{n})\}$  is the maximal element. Once again, this poset is pure.

The action of the symmetric group  $\mathbb{S}_n$  is defined in a similar way and is compatible with the partial order. Once again, the action of  $\mathbb{S}_n$  on the set  $\Delta(\Pi_{PO}(n))$  is free. All the intervals  $[\alpha, \hat{1}]$ , with  $\alpha \in \text{Min}(\Pi_{PO}(n))$ , are isomorphic and the isomorphism between two of them is given by the action of an element of  $\mathbb{S}_n$ .

PROPOSITION 23. *The operadic poset  $\Pi_{Dias}$  associated to the operad  $Dias$  is isomorphic to the poset of pointed ordered partitions.*

4.5.3. **Homology of the poset  $\Pi_{PO}$ .** The Koszul dual of the operad  $Dias$  is the operad  $Dend$  of dendriform algebras (cf. [L2]). Up to permutations, the linear operations on  $n$  variables of a dendriform algebra can be indexed by the planar binary trees with  $n$  vertices  $Y_n$ . One has  $Dend(n) \simeq k[Y_n] \otimes k[\mathbb{S}_n]$ .

PROPOSITION 24. *Every interval  $[\alpha, \hat{1}]$  of  $\Pi_{PO}(n)$  with  $\alpha \in \text{Min}(\Pi_{PO}(n))$  is totally semi-modular and therefore Cohen-Macaulay over  $k$ .*

PROOF. The proof is the same as the one for pointed partitions in [CV].

THEOREM 25 (Homology of the pointed ordered poset,  $\Pi_{PO}$ ). *The homology of the pointed ordered partition poset  $\Pi_{PO}$  is the  $\mathbb{S}_n$ -module*

$$H_l(\Pi_{PO}(n)) \cong \begin{cases} k[Y_n] \otimes k[\mathbb{S}_n] & \text{if } l = n - 1 \\ 0 & \text{otherwise.} \end{cases}$$

REMARK. Proposition 20 proves that the operads  $Dias$  and  $Dend$  are Koszul over  $k$ .

4.6. **Homology of the multi-pointed ordered partition poset  $\Pi_{MPO}$  and the operad  $Trias$ .** The multi-pointed ordered partition posets  $\Pi_{MPO}$  arise from the operad  $Trias$  of associative trialgebras. Therefore the homology of the multi-pointed ordered partition poset is given by the Koszul dual cooperad of  $Trias$ , namely  $TriDend^V$ .

The notion of an *associative trialgebra* has been defined by J.-L. Loday and M.O. Ronco in [LR]. Following the same methods as before, one can prove that the operad  $Trias$  is a basic-set operad. The corresponding partition poset is isomorphic to the poset of multi-pointed ordered partitions.

DEFINITION (Multipointed ordered partition). A *multipointed ordered partition* is an ordered partition  $\{B_1, \dots, B_k\}$  of  $[n]$  where, for each  $i$ , at least one element of the sequence  $B_i$  is emphasized.

DEFINITION (Multipointed ordered partition poset,  $\Pi_{MPO}$ ). Let  $\lambda$  and  $\mu$  be two multipointed ordered partitions. We say that  $\mu$  is larger than  $\lambda$  if the pointed integers of  $\lambda$  belongs to the set of the pointed integers of  $\mu$  and if  $\mu$  is a larger than  $\lambda$  as ordered partitions. This poset is called the *multipointed ordered partition poset* and denoted by  $\Pi_{MPO}$ .



## HOMOLOGY OF GENERALIZED PARTITION POSETS

PROPOSITION 26. *Every interval  $[\alpha, \hat{1}]$  of  $\Pi_{MPO}(n)$  with  $\alpha \in \text{Min}(\Pi_{MPO}(n))$  is totally semi-modular and therefore Cohen-Macaulay over  $k$ .*

The  $\mathbb{S}_n$ -modules of the operad  $\mathcal{T}riDend$  are given by  $\mathcal{T}riDend(n) = k[T_n] \otimes k[\mathbb{S}_n]$ , where  $T_n$  denotes the set of planar trees with  $n$  leaves. (It corresponds to the cells of the associahedra.)

THEOREM 27 (Homology of the multi-pointed ordered partition poset,  $\Pi_{MPO}$ ). *The homology of the multi-pointed ordered partition poset  $\Pi_{MPO}$  is the  $\mathbb{S}_n$ -module*

$$H_l(\Pi_{MPO}(n)) \cong \begin{cases} k[T_n] \otimes k[\mathbb{S}_n] & \text{if } l = n - 1 \\ 0 & \text{otherwise.} \end{cases}$$

4.7. **Comparison between the various partition posets.** We sum up the various cases in the following table.

Partition poset $\Pi_{\mathcal{P}}$	Operad $\mathcal{P}$	$\mathcal{P}^!$	$\mathbf{H}_{n-1}(\Pi_{\mathcal{P}}(\mathbf{n})) = \mathcal{P}^!(\mathbf{n})$
classical $\Pi$	$\mathcal{C}om$	$\mathcal{L}ie$	$\mathcal{L}ie^*(n) \otimes \text{sgn}_{\mathbb{S}_n}$
$t$ -restricted block size	$t - \mathcal{C}om$	$t - \mathcal{L}ie$	
pointed $\Pi_{\mathcal{P}}$	$\mathcal{P}erm$	$\mathcal{P}relie$	$\mathcal{R}\mathcal{T}^*(n) \otimes \text{sgn}_{\mathbb{S}_n}$
multi-pointed $\Pi_{MP}$	$\mathcal{C}om\mathcal{T}rias$	$\mathcal{P}ost\mathcal{L}ie$	$(\mathcal{L}ie \circ \mathcal{M}ag)^*(n) \otimes \text{sgn}_{\mathbb{S}_n}$
ordered $\Pi_{\mathcal{O}}$	$\mathcal{A}s$	$\mathcal{A}s$	$k[\mathbb{S}_n]$
pointed ordered $\Pi_{PO}$	$\mathcal{D}ias$	$\mathcal{D}end$	$k[Y_n] \otimes k[\mathbb{S}_n]$
multi-pointed ordered $\Pi_{MPO}$	$\mathcal{T}rias$	$\mathcal{T}riDend$	$k[T_n] \otimes k[\mathbb{S}_n]$

We can define inclusion and forgetful maps linking the six cases of partition posets defined above.

DEFINITION (Forgetful maps  $F_{\mathcal{O}}$  and  $F_{\mathcal{P}}$ ). The forgetful map  $F_{\mathcal{O}}$  is obtained from an ordered type partition by forgetting the internal order inside each block. The forgetful map  $F_{\mathcal{P}}$  unmark all emphasized integers of a pointed partition (resp. a pointed ordered partition) in order to get a partition (resp. an ordered partition).

Since a pointed type partition is a multipointed type partition, this defines an injective map from pointed type partitions to multipointed type partitions.

These maps induce morphisms of presimplicial sets that commute with the action of the symmetric group  $\mathbb{S}_n$ . We sum up the six cases studied above in the following diagram.

$$\begin{array}{ccc}
 \Pi_{MPO} & \xrightarrow{F_{\mathcal{O}}} & \Pi_{MP} \\
 \uparrow & & \uparrow \\
 \Pi_{PO} & \xrightarrow{F_{\mathcal{O}}} & \Pi_{\mathcal{P}} \\
 \downarrow F_{\mathcal{P}} & & \downarrow F_{\mathcal{P}} \\
 \Pi_{\mathcal{O}} & \xrightarrow{F_{\mathcal{O}}} & \Pi
 \end{array}$$

The comparison diagram between the various posets corresponds to the following diagram of operads. The next diagram gives the homology of the various posets.

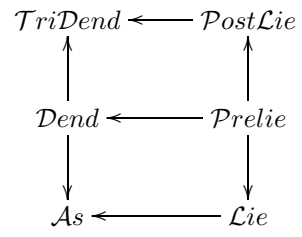
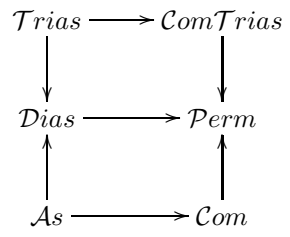

---

## HOMOLOGY OF GENERALIZED PARTITION POSETS

---

### APPENDIX : KOSZUL DUALITY OF THE OPERADS $ComTrias$ AND $PostLie$

We define a commutative version of the operad  $Trias$ , which we call the  $ComTrias$  operad. We study its Koszul dual operad, which we call the  $PostLie$  operad. We prove that the operads  $ComTrias$  and  $PostLie$  are Koszul operads.

Let  $k$  be a field of characteristic 0.

#### 1. $ComTrias$ operad

DEFINITION (Commutative trialgebra). A *commutative trialgebra* is a  $k$ -module  $A$  equipped with two binary operations  $*$  and  $\bullet$  such that  $(A, *)$  is a *Perm*-algebra

$$(x * y) * z = x * (y * z) = x * (z * y),$$

$(A, \bullet)$  is a commutative algebra

$$\begin{cases} x \bullet y &= y \bullet x, \\ (x \bullet y) \bullet z &= x \bullet (y \bullet z), \end{cases}$$

and the two operations  $*$  and  $\bullet$  must verify the following compatibility relations

$$\begin{cases} x * (y \bullet z) &= x * (y * z), \\ (x \bullet y) * z &= x \bullet (y * z). \end{cases}$$

DEFINITION ( $ComTrias$  operad). We denote by  $ComTrias$ , the operad coding the commutative trialgebras.

REMARK. The operad  $ComTrias$  does not fall into the construction of M. Markl (cf. [M]) called *distributive laws* because of the first compatibility relation. Therefore, we will have to use other methods to show that this operad is Koszul.

THEOREM 28 (Free commutative trialgebra). *The free commutative trialgebra algebra on a module  $V$ , denoted by  $ComTrias(V)$  is given by the module  $\bar{S}(V) \otimes S(V)$  equipped with the following operations*

$$\begin{aligned} (x_1 \dots x_k \otimes y_1 \dots y_l) * (x'_1 \dots x'_m \otimes y'_1 \dots y'_n) &= x_1 \dots x_k \otimes y_1 \dots y_l x'_1 \dots x'_m y'_1 \dots y'_n, \\ (x_1 \dots x_k \otimes y_1 \dots y_l) \bullet (x'_1 \dots x'_m \otimes y'_1 \dots y'_n) &= x_1 \dots x_k x'_1 \dots x'_m \otimes y_1 \dots y_l y'_1 \dots y'_n. \end{aligned}$$

PROOF. It is easy to check that the  $k$ -module  $ComTrias(V)$  equipped with the two operations  $*$  and  $\bullet$  is a commutative trialgebra.

Let  $(T, *, \bullet)$  be a commutative trialgebra. The inclusion  $V \hookrightarrow V \otimes 1$  is denoted by  $i$ . Associated to each morphism of  $k$ -modules  $f : V \rightarrow T$ , we will show that there exists a unique morphism of commutative trialgebras  $\tilde{f} : \bar{S}(V) \otimes S(V) \rightarrow T$  such that the following diagram is commutative

$$\begin{array}{ccc} V & \xrightarrow{i} & \bar{S}(V) \otimes S(V) \\ & \searrow f & \downarrow \tilde{f} \\ & & T. \end{array}$$

We define  $\tilde{f}$  by the formula

$$\begin{aligned} \tilde{f}(X \otimes Y) = \tilde{f}(x_1 \dots x_k \otimes y_1 \dots y_l) &:= (\tilde{f}(x_1) \bullet \dots \bullet \tilde{f}(x_k)) * (\tilde{f}(y_1) * \dots * \tilde{f}(y_l)) \\ \tilde{f}(x_1 \dots x_k \otimes 1) &:= \tilde{f}(x_1) \bullet \dots \bullet \tilde{f}(x_k). \end{aligned}$$

The map  $\tilde{f}$  is a morphism of commutative trialgebras. We have

$$\begin{aligned}
\tilde{f}(X \otimes Y * X' \otimes Y') &= \tilde{f}(x_1 \dots x_k \otimes y_1 \dots y_l x'_1 \dots x'_m y'_1 \dots y'_n) \\
&= (\tilde{f}(x_1) \bullet \dots \bullet \tilde{f}(x_k)) * (\tilde{f}(y_1) * \dots * \tilde{f}(y_l) * \\
&\quad \tilde{f}(x'_1) * \dots * \tilde{f}(x'_m) * \tilde{f}(y'_1) * \dots * \tilde{f}(y'_n)) \\
&= (\tilde{f}(x_1) \bullet \dots \bullet \tilde{f}(x_k)) * ((\tilde{f}(y_1) * \dots * \tilde{f}(y_l)) * \\
&\quad (\tilde{f}(x'_1) \bullet \dots \bullet \tilde{f}(x'_m)) * (\tilde{f}(y'_1) * \dots * \tilde{f}(y'_n))) \\
&= ((\tilde{f}(x_1) \bullet \dots \bullet \tilde{f}(x_k)) * (\tilde{f}(y_1) * \dots * \tilde{f}(y_l))) * \\
&\quad ((\tilde{f}(x'_1) \bullet \dots \bullet \tilde{f}(x'_m)) * (\tilde{f}(y'_1) * \dots * \tilde{f}(y'_n)))) \\
&= \tilde{f}(X \otimes Y) * \tilde{f}(X' \otimes Y'),
\end{aligned}$$

and

$$\begin{aligned}
\tilde{f}(X \otimes Y \bullet X' \otimes Y') &= \tilde{f}(x_1 \dots x_k x'_1 \dots x'_m \otimes y_1 \dots y_l y'_1 \dots y'_n) \\
&= (\tilde{f}(x_1) \bullet \dots \bullet \tilde{f}(x_k) \bullet \tilde{f}(x'_1) \bullet \dots \bullet \tilde{f}(x'_m)) * \\
&\quad (\tilde{f}(y_1) * \dots * \tilde{f}(y_l) * \tilde{f}(y'_1) * \dots * \tilde{f}(y'_n)).
\end{aligned}$$

In any commutative trialgebra, one has

$$\begin{aligned}
(a \bullet a') * (b * b') &= (a' \bullet a) * (b * b') = (a' \bullet (a * b)) * b' = ((a * b) \bullet a') * b' \\
&= (a * b) \bullet (a' * b').
\end{aligned}$$

Therefore, we get

$$\begin{aligned}
\tilde{f}(X \otimes Y \bullet X' \otimes Y') &= ((\tilde{f}(x_1) \bullet \dots \bullet \tilde{f}(x_k)) * (\tilde{f}(y_1) * \dots * \tilde{f}(y_l))) \bullet \\
&\quad ((\tilde{f}(x'_1) \bullet \dots \bullet \tilde{f}(x'_m)) * (\tilde{f}(y'_1) * \dots * \tilde{f}(y'_n))) \\
&= \tilde{f}(X \otimes Y) \bullet \tilde{f}(X' \otimes Y').
\end{aligned}$$

Let  $g : \text{ComTrias}(V) \rightarrow T$  be a morphism of commutative trialgebras such that  $g \circ i = f$ . Since a tensor  $x_1 \dots x_k \otimes y_1 \dots y_l$  in  $\bar{S}(V) \otimes S(V)$  is equal to  $(x_1 \otimes 1 \bullet \dots \bullet x_k \otimes 1) * (y_1 \otimes 1 * \dots * y_l \otimes 1)$ , we have

$$\begin{aligned}
g(X \otimes Y) &= g((x_1 \otimes 1 \bullet \dots \bullet x_k \otimes 1) * (y_1 \otimes 1 * \dots * y_l \otimes 1)) \\
&= (g(x_1 \otimes 1) \bullet \dots \bullet g(x_k \otimes 1)) * (g(y_1 \otimes 1) * \dots * g(y_l \otimes 1)) \\
&= (f(x_1) \bullet \dots \bullet f(x_k)) * (f(y_1) * \dots * f(y_l)) \\
&= \tilde{f}(X \otimes Y).
\end{aligned}$$

□

We recall from theorem 14 that the  $\mathbb{S}_n$ -modules  $\text{ComTrias}(n)$  are free  $k$ -modules.

REMARK. There exists a differential graded variation of the operad  $\text{ComTrias}$  defined by F. Chapoton in [C2].

## 2. $\mathcal{P}ost\mathcal{L}ie$ operad

DEFINITION (PostLie algebra). A *PostLie algebra* is a  $k$ -module  $L$  equipped with two binary operations  $\circ$  and  $[\ , \ ]$  such that  $(L, [\ , \ ])$  is a Lie algebra

$$\begin{cases} [x, y] = -[y, x] \\ [x, [y, z]] + [y, [z, x]] + [z, [x, y]] = 0 \end{cases}$$

and such that the two operations  $\circ$  and  $[\ , \ ]$  verify the following compatibility relations

$$\begin{cases} (x \circ y) \circ z - x \circ (y \circ z) - (x \circ z) \circ y + x \circ (z \circ y) = x \circ [y, z], \\ [x, y] \circ z = [x \circ z, y] + [x, y \circ z] \end{cases}$$

DEFINITION ( $\mathcal{P}ost\mathcal{L}ie$  operad). We denote by  $\mathcal{P}ost\mathcal{L}ie$ , the operad coding the PostLie algebras.

REMARK. A Lie algebra  $(L, [\ , \ ])$  equipped an extra operation  $\circ = 0$  is a PostLie algebra. A PostLie algebra  $(L, \circ, [\ , \ ])$  such that  $[\ , \ ] = 0$  is a PreLie algebra for the product  $\circ$ . Therefore the operad  $\mathcal{P}ost\mathcal{L}ie$  is an “extension” of the operad  $\mathcal{P}re\mathcal{L}ie$  by the operad  $\mathcal{L}ie$ .

We will compute the free PostLie algebra. It is expressed with the free magmatic algebra  $(\mathcal{M}ag(V), \diamond)$ . A *magmatic algebra* is a  $k$ -module  $A$  equipped with a binary operation. Therefore, the free magmatic algebra on a  $k$ -module  $V$  is defined on the  $k$ -module

$$\mathcal{M}ag(V) := \bigoplus_{n \geq 1} k[Y_{n-1}] \otimes V^{\otimes n},$$

where  $Y_{n-1}$  denote the set of planar binary trees with  $n$  leaves. It is equipped with the following product

$$(t \otimes (x_1, \dots, x_m)) \diamond (s \otimes (x'_1, \dots, x'_n)) := (t \vee s) \otimes (x_1, \dots, x_m, x'_1, \dots, x'_n),$$

where  $t$  belongs to  $Y_{m-1}$  and  $s$  belongs to  $Y_{n-1}$ . The notation  $t \vee s$  represents to the grafting of trees (cf. J.-L Loday [L2] Appendix A)

$$t \vee s = \begin{array}{c} t \qquad s \\ \diagdown \quad \diagup \\ \text{---} \end{array}$$

THEOREM 29 (Free PostLie algebra). *The free PostLie algebra on the  $k$ -module  $V$  is given by the module  $\mathcal{L}ie(\mathcal{M}ag(V))$ , where the bracket  $[\ , \ ]$  is the bracket coming from the free Lie algebra on  $\mathcal{M}ag(V)$ .*

PROOF. The  $\mathcal{P}ost\mathcal{L}ie$  operad is a quadratic operad generated by two operations  $\circ$  and  $[\ , \ ]$ . We have  $\mathcal{P}ost\mathcal{L}ie = \mathcal{F}([\ , \ ], \text{sgn}_{\mathbb{S}_2} \oplus \circ.k[\mathbb{S}_2]) / (R)$ , where the module of relations  $R$  is the direct sum  $R_{[\ , \ ]} \oplus R_r \oplus R_l$ . The module  $R_{[\ , \ ]}$  corresponds to the Jacobi relation. The module  $R_r$  corresponds to the first compatibility relation between  $\circ$  and  $[\ , \ ]$ , where the bracket is “on the right” and the module  $R_l$  corresponds to the second compatibility relation, where the bracket is ”on the left”. The free operad  $\mathcal{F}([\ , \ ], \text{sgn}_{\mathbb{S}_2} \oplus \circ.k[\mathbb{S}_2]) / (R)$  is isomorphic the  $\mathbb{S}$ -module generated by binary trees where the vertices are indexed by  $\circ$  or  $[\ , \ ]$ . The relation  $R_r$  allows us to replace the

following pattern

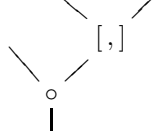

by a sum of trees with vertices only indexed by  $\circ$ . And the relation  $R_l$  allows to replace the pattern

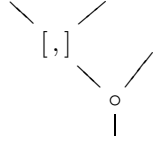

by a sum of trees where the vertex indexed by  $\circ$  is above the vertex indexed by  $[,]$ . Therefore, the operad  $\mathcal{PostLie}$  is a quotient of the free module generated by binary trees where the vertices are indexed by  $\circ$  or  $[,]$ , such that the vertices indexed by  $\circ$  are above the vertices indexed by  $[,]$ . With this presentation, the only remaining relation is the Jacobi relation for the bracket  $[,]$ . The operad  $\mathcal{PostLie}$  is isomorphic to the product  $\mathcal{Lie} \circ \mathcal{Mag}$ , which concludes the proof.  $\square$

Once again, the  $\mathbb{S}_n$ -modules  $\mathcal{PostLie}(n)$  are free  $k$ -modules.

**THEOREM 30.** *The operad  $\mathcal{PostLie}$  is the Koszul dual operad of the operad  $\mathcal{ComTrias}$*

**PROOF.** We have  $\mathcal{ComTrias} = \mathcal{F}(V)/(R)$  with  $V = *k[\mathbb{S}_2] \oplus \bullet k$ . The module of relation is the direct sum  $R = R_{\mathcal{P}erm} \oplus R_{\mathcal{C}om} \oplus R_{\mathcal{M}ix}$ , where  $R_{\mathcal{P}erm}$  denotes the Perm-relation of  $*$ ,  $R_{\mathcal{C}om}$  denotes the associativity of  $\bullet$  and  $R_{\mathcal{M}ix}$  represents the compatibility relations between  $*$  and  $\bullet$ . The operad  $\mathcal{PostLie}$  is equal to  $\mathcal{F}(W)/(S)$  with  $W = \circ k[\mathbb{S}_2] \oplus [, ] \text{sgn}_{\mathbb{S}_2}$ . The module of relations  $S$  is the direct sum  $S_{[, ]} \oplus S_{\mathcal{M}ix}$  where  $S_{[, ]}$  is the Jacobi relation and  $S_{\mathcal{M}ix}$  represents the compatibility relations. The rank of the  $k$ -module  $\mathcal{F}_{(2)}(V) = \mathcal{F}(V)(3)$  is 27 and the rank of  $R$  is  $9+2+9 = 20$  (for  $R_{\mathcal{P}erm}$ ,  $R_{\mathcal{C}om}$  and  $R_{\mathcal{M}ix}$ ). We identify the linear dual of  $*$  with  $\circ$  and the linear dual of  $\bullet$  with  $[,]$ . Therefore, we get  $V^\vee \cong W$ . With this identification, one can easily see that  $S \subset R^\perp$ . Since the rank of  $S$  is  $1 + 6 = 7 = 27 - 20$ , the  $k$ -module  $S$  is equal to  $R^\perp$  and  $\mathcal{ComTrias}^\dagger = \mathcal{F}(V^\vee)/(R^\perp) \cong \mathcal{F}(W)/(S) = \mathcal{PostLie}$ .  $\square$

### 3. Koszul duality and homology of PostLie algebras

#### 3.1. The Lie algebra associated to a PostLie algebra

**PROPOSITION 31.** *Let  $(L, \circ, [, ])$  be a PostLie algebra. The bracket defined by the formula*

$$\{x, y\} := x \circ y - y \circ x + [x, y]$$

*is a Lie bracket. We denote by  $L_{\{\cdot, \cdot\}}$  the Lie algebra  $(L, \{\cdot, \cdot\})$ .*

**PROOF.** The proof is given by a direct calculation.  $\square$

---

**HOMOLOGY OF GENERALIZED PARTITION POSETS**

---

PROPOSITION 32. A *PostLie algebra*  $(L, \circ, [, ])$  is a right module over the Lie algebra  $L_{\{\cdot, \cdot\}}$  for the following action

$$\begin{aligned} L \times L_{\{\cdot, \cdot\}} &\rightarrow L \\ (x, y) &\mapsto x \circ y. \end{aligned}$$

PROOF. Once again, the proof is given by a direct calculation. □

One can extend the action of  $L_{\{\cdot, \cdot\}}$  on  $L$  to a right action of the enveloping Lie algebra  $\mathcal{U}(L_{\{\cdot, \cdot\}})$  by the formula

$$\begin{aligned} L \times \mathcal{U}(L_{\{\cdot, \cdot\}}) &\rightarrow L \\ (g, v_1 \otimes \cdots \otimes v_n) &\mapsto ((g \circ v_1) \cdots) \circ v_n. \end{aligned}$$

We denote the action of  $\mathcal{U}(L_{\{\cdot, \cdot\}})$  on  $L$  by  $\star$ .

PROPOSITION 33. Let  $L = (\mathcal{L}ie(\mathcal{M}ag(V)), \circ, [, ])$  the free *PostLie algebra* on  $V$ . The module  $\mathcal{M}ag(V) \subset L$  is a stable under the action of the Lie algebra  $L_{\{\cdot, \cdot\}}$ .

PROOF. It is an easy consequence of the avoiding pattern chosen in the proof of Theorem 29. □

Therefore,  $\mathcal{M}ag(V)$  is a right module over the enveloping algebra  $\mathcal{U}(L_{\{\cdot, \cdot\}})$ .

PROPOSITION 34. The right  $\mathcal{U}(L_{\{\cdot, \cdot\}})$ -module  $\mathcal{M}ag(V)$  is isomorphic to the free right  $\mathcal{U}(L_{\{\cdot, \cdot\}})$ -module generated by  $V$

$$\mathcal{M}ag(V) \cong V \otimes \mathcal{U}(L_{\{\cdot, \cdot\}}).$$

PROOF. We consider the following surjective morphism  $\Phi$  of  $\mathcal{U}(L_{\{\cdot, \cdot\}})$ -modules

$$\begin{aligned} V \otimes \mathcal{U}(L_{\{\cdot, \cdot\}}) &\rightarrow \mathcal{M}ag(V) \\ v \otimes u &\mapsto v \star u. \end{aligned}$$

We give an inverse of  $\Phi$ . We define a magmatic structure on  $V \otimes \mathcal{U}(L_{\{\cdot, \cdot\}})$  by the product

$$(v \otimes u) \diamond (v' \otimes u') := v \otimes (u \otimes i(v') \star u'),$$

where  $i$  denotes the inclusion  $V \hookrightarrow \mathcal{M}ag(V)$ . Let  $j$  be the inclusion

$$\begin{aligned} V &\rightarrow V \otimes \mathcal{U}(L_{\{\cdot, \cdot\}}) \\ v &\mapsto v \otimes 1. \end{aligned}$$

The morphism  $\Phi$  preserves the binary products  $\diamond$  and  $\circ$ . We have

$$\begin{aligned} \Phi((v \otimes u) \diamond (v' \otimes u')) &= v \star (u \otimes (i(v') \star u')) = (v \star u) \star (v' \star u') \\ &= (v \star u) \circ (v' \star u') = \Phi(v \otimes u) \circ \Phi(v' \otimes u'). \end{aligned}$$

By definition of the free magmatic algebra, there exists a unique morphism of magmatic algebras  $\Psi$  such that the following diagram commutes

$$\begin{array}{ccc} V & \xrightarrow{i} & \mathcal{M}ag(V) \\ & \searrow j & \downarrow \Psi \\ & & V \otimes \mathcal{U}(L_{\{\cdot, \cdot\}}). \end{array}$$

Since  $\Phi \circ \Psi \circ i = i$ , we have by definition of  $\mathcal{M}ag(V)$  that  $\Phi \circ \Psi = id$ .

It remains to prove that  $\Psi$  is a morphism of right  $\mathcal{U}(L_{\{\cdot, \cdot\}})$ -modules. It is enough to prove that  $\Psi(t \star u) = \Psi(t) \star u$  for  $u \in L$ . We denote by  $\mathcal{L}ie_{(k)}(\mathcal{M}ag(V))$  the elements of the free PostLie algebra  $L$  coming from trees with  $k$  vertices indexed by  $[\cdot, \cdot]$ . We show the previous statement by induction on  $k$ .

- ▷ If  $u$  belongs to  $\mathcal{L}ie_{(0)}(\mathcal{M}ag(V)) = \mathcal{M}ag(V)$ , we have  $\Psi(t \star u) = \Psi(t \circ u) = \Psi(t) \diamond \Psi(u)$ . We denote  $\Psi(t)$  by  $\sum_i v_i \otimes u_i$  and  $\Psi(u)$  by  $\sum_j v'_j \otimes u'_j$ . Therefore, we have

$$\begin{aligned} \Psi(t) \diamond \Psi(u) &= \sum_i v_i \otimes (u_i \otimes \sum_j v'_j \star u'_j) = \sum_i v_i \otimes (u_i \otimes \Phi \circ \Psi(u)) \\ &= \sum_i v_i \otimes (u_i \otimes u) = \Psi(t) \star u. \end{aligned}$$

- ▷ Suppose that the statement is true for  $k \leq n$ . Let  $u$  be an element of  $\mathcal{L}ie_{(n+1)}(\mathcal{M}ag(V))$ . In  $\mathcal{L}ie(\mathcal{M}ag(V))$ , this element is a sum of elements of the form  $[w_1, w_2]$ , where  $w_1 \in \mathcal{L}ie_{(k_1)}(\mathcal{M}ag(V))$  and  $w_2 \in \mathcal{L}ie_{(k_2)}(\mathcal{M}ag(V))$  with  $k_1, k_2 \leq n$ . We have

$$\begin{aligned} \Psi(t \star u) &= \Psi(t \star \sum [w_1, w_2]) \\ &= \sum \Psi(t \star (w_1 \otimes w_2 - w_2 \otimes w_1 - w_1 \circ w_2 + w_2 \circ w_1)). \end{aligned}$$

Since  $w_1 \circ w_2$  and  $w_2 \circ w_1$  belong to  $\mathcal{L}ie_{(m)}(\mathcal{M}ag(V))$  for  $m \leq n$ , we have for induction hypothesis that

$$\begin{aligned} \Psi(t \star u) &= \sum \Psi(t) \star (w_1 \otimes w_2 - w_2 \otimes w_1 - w_1 \circ w_2 + w_2 \circ w_1) \\ &= \Psi(t) \star u. \end{aligned}$$

Since  $\Psi \circ \Phi \circ j = j$ , we have  $\Psi \circ \Phi = id$  by definition of the free  $\mathcal{U}(L_{\{\cdot, \cdot\}})$ -module on  $V$ , which concludes the proof.  $\square$

### 3.2. Homology of a PostLie algebra

**THEOREM 35** (Homology of a PostLie algebra). *Let  $(L, \circ, [\cdot, \cdot])$  be a PostLie algebra. Its operadic homology theory is defined on the module  $ComTrias^\vee(L) = \bar{\Lambda}(V) \otimes \Lambda(V)$  by the following boundary map :*

$$\begin{aligned} d(x_1 \wedge \dots \wedge x_k \otimes y_1 \wedge \dots \wedge y_l) &= \\ &\sum_{1 \leq i < j \leq k} \pm x_1 \wedge \dots \wedge [x_i, x_j] \wedge \dots \wedge \hat{x}_j \wedge \dots \wedge x_k \otimes y_1 \wedge \dots \wedge y_l + \\ &\sum_{1 \leq i < j \leq k} \pm x_1 \wedge \dots \wedge x_k \otimes y_1 \wedge \dots \wedge \{y_i, y_j\} \wedge \dots \wedge \hat{y}_j \wedge \dots \wedge y_l + \\ &\sum_{\substack{1 \leq i \leq k \\ 1 \leq j \leq l}} \pm x_1 \wedge \dots \wedge \hat{x}_i \wedge \dots \wedge x_k \wedge (x_i \circ y_j) \otimes y_1 \wedge \dots \wedge \hat{y}_j \wedge \dots \wedge y_l, \end{aligned}$$

where the signs are given by the Koszul-Quillen rule.

**PROOF.** Since the Koszul dual of  $\mathcal{P}ostLie$  is the operad  $ComTrias$ , the operadic homology for a PostLie algebra  $L$  is given by the module  $\mathcal{P}ostLie^i(L) = ComTrias^\vee(L)$  (cf. section 2). The boundary maps are induced by the partial coproduct of the



---

## HOMOLOGY OF GENERALIZED PARTITION POSETS

---

cooperad  $ComTrias^\vee$ . The result is obtained by identifying the linear bidual of  $\circ$  to  $*$  and the bidual of  $\bullet$  to  $[\cdot, \cdot]$ .  $\square$

We denote by  $d_{[\cdot]}(x_1 \wedge \dots \wedge x_k \otimes y_1 \wedge \dots \wedge y_l)$  the first part  $\sum_{1 \leq i < j \leq k} \pm x_1 \wedge \dots \wedge [x_i, x_j] \wedge \dots \wedge \widehat{x}_j \wedge \dots \wedge x_k \otimes y_1 \wedge \dots \wedge y_l$  of the previous boundary map and by  $d_{\{\cdot\}}(x_1 \wedge \dots \wedge x_k \otimes y_1 \wedge \dots \wedge y_l)$  the second part. Therefore, the map  $d$  is equal to  $d_{[\cdot]} + d_{\{\cdot\}}$ .

**THEOREM 36** (Homology of the free PostLie algebra). *Let  $L = (\mathcal{L}ie(\mathcal{M}ag(V)), \circ, [\cdot, \cdot])$  the free Post-Lie algebra on  $V$ . Its homology is equal to*

$$H_l^{\mathcal{P}ost\mathcal{L}ie}(L) = \begin{cases} V & \text{if } l = 1, \\ 0 & \text{otherwise.} \end{cases}$$

**PROOF.** We consider the following filtration on the operadic complex  $(\bar{\Lambda}(V) \otimes \Lambda(V), d)$  of the free PostLie algebra  $L$

$$F_p := \bar{\Lambda}(V) \otimes \Lambda_{\leq p}(V).$$

By the definition of the boundary map  $d$ , we get that this filtration is preserved by  $d$ . We have  $E_{p,q}^0 = \Lambda_q(L) \otimes \Lambda_p(L)$  and  $d_0 = d_{[\cdot]}$ . Therefore, the modules  $E_{p,*}^1$  are equal to  $H_*^{\mathcal{L}ie}(\mathcal{L}ie(\mathcal{M}ag(V)), k) \otimes \Lambda_p(L)$ , where  $H_*^{\mathcal{L}ie}(\mathcal{L}ie(\mathcal{M}ag(V)), k)$  is the Chevalley-Eilenberg homology of the free Lie algebra on  $\mathcal{M}ag(V)$  with coefficient in  $k$ . This homology is equal to

$$E_{p,*}^1 = \begin{cases} \mathcal{M}ag(V) \otimes \Lambda_p(L) & \text{if } * = 1 \\ 0 & \text{otherwise.} \end{cases}$$

Since for  $q = 1$ , we have  $E_{p,q}^1 = \mathcal{M}ag(V) \otimes \Lambda_p(L)$  and  $d_1 = d_{\{\cdot\}}$ , the second term of the spectral sequence is isomorphic to

$$E_{p,1}^2 = H_p^{\mathcal{L}ie}(L_{\{\cdot\}}, \mathcal{M}ag(V)) = Tor_p^{\mathcal{U}(L_{\{\cdot\}})}(\mathcal{M}ag(V), k).$$

We have seen in the proposition 34 that  $\mathcal{M}ag(V)$  is the free  $\mathcal{U}(L_{\{\cdot\}})$ -module on  $V$ . We finally get

$$E_{p,1}^2 = Tor_p^{\mathcal{U}(L_{\{\cdot\}})}(\mathcal{M}ag(V), k) = \begin{cases} V & \text{if } p = 0 \\ 0 & \text{otherwise.} \end{cases}$$

This spectral sequence is bounded. By the classical convergence theorem of bounded spectral sequences, we have that  $E^*$  converges to the homology of the free PostLie algebra on  $V$  which concludes the proof.  $\square$

**COROLLARY 37.** *The operads  $ComTrias$  and  $PostLie$  are Koszul operads over any field  $k$  of characteristic 0.*

**REMARK.** In [CV], we prove that the intervals of maximal length in the posets of multi-pointed partitions are totally semi-modular. It shows that they are Cohen-Macaulay over any field  $k$  and over the ring of integers  $\mathbb{Z}$ . As a consequence of Theorem 9, we get that the operads  $ComTrias$  and  $PostLie$  are Koszul over any field  $k$  and over the ring of integers  $\mathbb{Z}$ .

### ACKNOWLEDGEMENTS

I wish to express my gratitude to Jean-Louis Loday for many useful discussions on these subjects. I also would like to thank B. Fresse for his help in my works and Roland Berger for pointing me out the article of C. Cibils, P. Polo and W.

Woodcock.

This paper was finished at the Mittag-Leffler Institut in Stockholm, whose hospitality and financial support was greatly appreciated.

## REFERENCES

- [B] A. Björner, *Shellable and Cohen-Macaulay partially ordered sets*, Trans. Amer. Math. Soc. **260**, 159-183.
- [BGS] A. Björner, A.M. Garsia, R.P. Stanley, *An introduction to Cohen-Macaulay partially ordered sets* in *Ordered sets* (ed. I. Rival ; Reidel \*, Dordrecht, 1982) 583-615.
- [C1] F. Chapoton, *Un endofoncteur de la catégorie des opérades*, in “Dialgebras and Related Operads”, Lecture Notes in Mathematics **1763**, Springer-Verlag, 2001.
- [C2] F. Chapoton, *Opérades différentielles graduées sur les simplexes et les permutoèdres*, Bull. Soc. Math. France **130** (2002), no. 2, 233-251.
- [CL] F. Chapoton, M. Livernet, *Pre-Lie algebras and the rooted trees operad*, Internat. Res. Notices, **8**, (2001), 395-408.
- [CV] F. Chapoton, B. Vallette, *Pointed and multi-pointed partitions of type A and B*, [math.QA/0410051](#), to appear in Journal of Algebraic Combinatorics.
- [Cu] E.B. Curtis, *Simplicial homotopy theory*. Advances in Math. **6** (1971), 107-209.
- [Ci] C. Cibils, *Cohomology of incidence algebras and simplicial complexes*, J. of Pure and Appl. Algebra, **56**, (1989), 221-232.
- [F] B. Fresse, *Koszul duality of operads and homology of partition posets*, in “Homotopy theory : Relations with algebraic geometry, group cohomology and algebraic K-theory”, Contemp. Math. **346**, AMS (2004).
- [G] A.V. Gnedbaye, *Opérades des algèbres  $(k+1)$ -aires*, in “Operads: proceedings of renaissance conferences (Hartford/Luminy, 1995)”, Contemp. Math. **202** (1997), 83-113.
- [GK] V. Ginzburg, M.M. Kapranov, *Koszul duality for operads*, Duke Math. J. **76** (1995), 203-272.
- [HW] P. Hanlon, M. Wachs, *On Lie  $k$ -algebras*, Advances in Math. **113** (1995) 206-236.
- [L1] J.-L. Loday, *La renaissance des opérades*, Séminaire Bourbaki (Exp. No. 792), Astérisque **237** (1996), 47-74.
- [L2] J.-L. Loday, *Dialgebras*, in “Dialgebras and Related Operads”, Lecture Notes in Mathematics **1763**, Springer-Verlag, 2001.
- [LR] J.-L. Loday, M. Ronco, *Trialgebras and families of polytopes*, in “Homotopy theory : Relations with algebraic geometry, group cohomology and algebraic K-theory”, Contemp. Math. **346**, AMS (2004).
- [MacL] S. Mac Lane, *Categories for the working mathematician (second edition)*, Oxford Mathematical Monographs, Oxford University Press, 1995.
- [M] M. Markl, *Distributive laws and Koszulness*, Ann. Inst. Fourier **46** (1996), no. 2, 307-323.
- [MSS] M. Markl, S. Shnider, J. Stasheff, *Operads in algebra, topology and physics*, Mathematical Surveys and Monographs **96**, American Mathematical Society, 2002.
- [May] J. P. May, *Simplicial Objects in Algebraic Topology*, Chicago Lectures in Mathematics, 1993.
- [P] P. Polo, *On Cohen-Macaulay posets, Koszul algebras and certain modules associated to Schubert varieties*, Bull. London Math. Soc. **27** (1995) 425-434.
- [Q] D. Quillen, *Homotopy properties of the poset of non-trivial  $p$ -subgroups of a group*, Advances in Math. **28** (1978) 101-128.
- [RW] A. Robinson, S. Whitehouse, *The tree representation of  $\Sigma_{n+1}$* , J. Pure Appl. Algebra **111** (1996), 245-253.
- [S] R.P. Stanley, *Enumerative Combinatorics*. Vol. I. Cambridge University Press (1997).
- [V] B. Vallette, *A Koszul duality for props*, [math.AT/0411542](#), to appear in Transactions of the A.M.S.
- [W] D. Woodcock, *Cohen-Macaulay complexes and Koszul rings*, Bull. London Math. Soc. **57** (1998) 398-410.

LABORATOIRE J.-A. DIEUDONNÉ, UNIVERSITÉ DE NICE SOPHIA-ANTIPOLIS, PARC VAL-ROSE, 06108 NICE CEDEX, FRANCE

## HOMOLOGY OF GENERALIZED PARTITION POSETS

E-mail address: [brunov@math.unice.fr](mailto:brunov@math.unice.fr)  
URL: <http://math.unice.fr/~brunov>