

Curvature Functionals, Optimal Metrics, and the Differential Topology of 4-Manifolds

Claude LeBrun

ABSTRACT. This paper investigates the question of which smooth compact 4-manifolds admit Riemannian metrics that minimize the L^2 -norm of the curvature tensor. Metrics with this property are called *optimal*; Einstein metrics and *scalar-flat anti-self-dual* metrics provide us with two interesting classes of examples. Using twistor methods, optimal metrics of the second type are constructed on the connected sums $k\overline{\mathbb{C}P}_2$ for $k > 5$. However, related constructions also show that large classes of simply connected 4-manifolds *do not* admit any optimal metrics at all. Interestingly, the difference between existence and non-existence turns out to delicately depend on one's choice of smooth structure; there are smooth 4-manifolds which carry optimal metrics, but which are homeomorphic to infinitely many distinct smooth 4-manifolds on which no optimal metric exists.

1. Introduction

“Does every smooth compact manifold admit a best metric?” René Thom allegedly first posed this naïve but fundamental question to Marcel Berger [10] at some point in the early 1960s. By the early 1990s, it had emerged from the world of informal discussion to find itself in print, as the leading entry on one of S.-T. Yau's celebrated problem lists [61].

Of course, Thom's question, as formulated above, seems to be less a problem than a *meta-problem*; after all, we are being asked to find some interpretation of the word “best” which will lead to an interesting conclusion. Nevertheless, the question always had some unambiguous content, because Thom had clarified his question by means of a paradigmatic example. What he of course had in mind was the classical uniformization theorem, which tells us that every compact 2-manifold carries metrics of constant curvature. This paradigm moreover gives us some vital clues concerning what we ought to look for. First, the definition of “best metric” should somehow involve the Riemannian curvature, and should be invariant under the action of the diffeomorphism group. Second, one might hope that metrics of constant sectional curvature, when they exist, would turn out to be the “best metrics” on the manifold in question. And third, we should not expect our “best”

Supported in part by NSF grant DMS-0305865.

metric to necessarily be absolutely unique; a finite-dimensional moduli space of “best metrics” would certainly be quite acceptable.

If we agree that the flat metrics are the best metrics on the n -dimensional torus $T^n = S^1 \times \cdots \times S^1$, then it seems rather natural to look for metrics on other manifolds which are “as flat as possible,” in the sense that they minimize some norm of curvature. For example, one might try to minimize the L^p -norm of the Riemann curvature tensor for some fixed $p > 1$. However, this is simply not a sensible problem for most choices of p ; one can typically find a sequence of metrics for which the L^p norm of curvature tends to zero by just multiplying a fixed metric by a suitable sequence of constants. Indeed, there is only one value of p for which this trick does *not* work: namely, $p = n/2$, where n is the dimension of the manifold.

Given a smooth compact n -manifold M , and letting

$$\mathcal{G}_M = \{ \text{smooth Riemannian metrics } g \text{ on } M \},$$

we are thus led to consider the functional

$$\mathcal{K} : \mathcal{G}_M \longrightarrow \mathbb{R}$$

given by

$$\mathcal{K}(g) = \int_M |\mathcal{R}_g|_g^{n/2} d\mu_g,$$

where \mathcal{R} denotes the Riemann curvature tensor, $|\mathcal{R}|$ is its point-wise norm with respect to the metric, and $d\mu$ is the n -dimensional volume measure determined by the metric. Berger [10] has suggested the minima of \mathcal{K} as natural candidates for Thom’s “best metrics.” Let us codify this proposal:

DEFINITION 1.1. *Let M be a smooth compact n -dimensional manifold, $n \geq 3$. A smooth Riemannian metric g on M will be called an optimal metric if it is an absolute minimizer of the functional \mathcal{K} , in the sense that*

$$\mathcal{K}(g') \geq \mathcal{K}(g)$$

for every smooth Riemannian metric g' on M .

Notice that we have defined an optimal metric to be a *minimum*, not just a critical point, of the functional \mathcal{K} . This brings into play a natural diffeomorphism invariant which is defined even in the absence of an optimal metric:

DEFINITION 1.2. *For any smooth compact n -dimensional manifold M , we define $\mathcal{I}_{\mathcal{R}}(M)$ to be the non-negative real number given by*

$$\mathcal{I}_{\mathcal{R}}(M) = \inf_{g \in \mathcal{G}_M} \mathcal{K}(g) = \inf_g \int_M |\mathcal{R}_g|_g^{n/2} d\mu_g.$$

Thus $\mathcal{I}_{\mathcal{R}}$ coincides with the number Berger [10] calls $\min \|\mathcal{R}\|^{n/2}$. Of course, our definitions have precisely been chosen so that any metric on g on M automatically satisfies

$$\mathcal{K}(g) \geq \mathcal{I}_{\mathcal{R}}(M),$$

with equality iff g is an optimal metric.

While it generally remains unclear to what extent optimal metrics really represent an appropriate response to Thom’s question, the situation in dimension 4 is rather encouraging. In particular [10, 11], an Einstein metric on any compact 4-manifold is optimal. However, the converse is by no means true; and the primary

purpose of this article is to explore this aspect of the problem. Here is what will emerge:

- We will construct infinitely many new examples of non-Einstein optimal metrics on simply connected compact 4-manifolds.
- We will show that there are many simply connected compact 4-manifolds which do not admit optimal metrics.
- We will see that the existence or non-existence of optimal metrics depends strictly on the diffeotype of a simply connected 4-manifold; it is not determined by the homeotype alone.
- We will calculate the invariant $\mathcal{I}_{\mathcal{R}}$ for many simply connected 4-manifolds (some common-garden, others a bit more exotic).
- We will show that the value of $\mathcal{I}_{\mathcal{R}}$ depends strictly on the diffeotype of a 4-manifold. Different differentiable structures on an underlying topological 4-manifold can often be distinguished by the fact that the corresponding values of $\mathcal{I}_{\mathcal{R}}$ are different. However, we will also see many examples of distinct differentiable structures which *cannot* be distinguished in this way.

2. Four-Dimensional Geometry

Our investigation of optimal metrics on 4-manifolds will necessarily presuppose a certain familiarity with the rudiments of 4-dimensional geometry and topology. The present section will attempt to offer a quick introduction to some of this essential background material.

The notion of self-duality plays a fundamental rôle in four-dimensional Riemannian geometry. If (M, g) is an oriented Riemannian 4-manifold, the Hodge star operator

$$\star : \Lambda^2 \rightarrow \Lambda^2$$

satisfies $\star^2 = 1$, and so yields a decomposition

$$(1) \quad \Lambda^2 = \Lambda^+ \oplus \Lambda^-,$$

where Λ^+ is the $(+1)$ -eigenspace of \star , and Λ^- is the (-1) -eigenspace. Both Λ^+ and Λ^- are rank-3 vector bundles over M . Reversing the orientation of M interchanges these two bundles.

DEFINITION 2.1. *On any smooth oriented 4-manifold, sections of Λ^+ are called self-dual 2-forms, whereas sections of Λ^- are called anti-self-dual 2-forms.*

Because the curvature of any connection is a bundle-valued 2-form, the decomposition (1) allows one to break any curvature tensor up into more primitive pieces. This idea has particularly important ramifications when applied to the Riemannian curvature of the metric itself. Indeed, first notice that, by raising an index, the Riemann curvature tensor may be reinterpreted as a linear map $\Lambda^2 \rightarrow \Lambda^2$, called the *curvature operator*. But decomposing the 2-forms according to (1) then allows us to view this linear map as consisting of four blocks:

$$(2) \quad \mathcal{R} = \left(\begin{array}{c|c} W_+ + \frac{s}{12} & \mathring{r} \\ \hline \mathring{r} & W_- + \frac{s}{12} \end{array} \right).$$

Here W_{\pm} are the trace-free pieces of the appropriate blocks, and are called the self-dual and anti-self-dual Weyl curvatures, respectively. The scalar curvature s is understood to act by scalar multiplication, whereas the trace-free Ricci curvature $\mathring{r} = r - \frac{s}{4}g$ acts on 2-forms by

$$\varphi_{ab} \mapsto \mathring{r}_{ac} \varphi^c_b - \mathring{r}_{bc} \varphi^c_a.$$

An important feature of the decomposition (1) is that it is *conformally invariant*, in the sense that it is unchanged if g is replaced by u^2g , where u is an arbitrary smooth positive function. Similarly, the self-dual and anti-self-dual Weyl curvatures are also conformally invariant (when considered as sections of $\Lambda^2 \otimes \text{End}(TM)$).

Since our objective is to better understand metrics on 4-manifolds which minimize the quadratic curvature integral

$$\mathcal{K}(g) = \int |\mathcal{R}|^2 d\mu,$$

it is highly relevant that there are two other quadratic curvature integrals which actually compute topological invariants. Indeed, no matter which metric g we choose on a smooth compact oriented 4-manifold M , the generalized Gauss-Bonnet theorem [1] tells us that the Euler characteristic is given by

$$(3) \quad \chi(M) = \frac{1}{8\pi^2} \int_M \left(\frac{s^2}{24} + |W_+|^2 + |W_-|^2 - \frac{|\mathring{r}|^2}{2} \right) d\mu,$$

while the Hirzebruch signature theorem [31] tells us that the *signature* is given by

$$(4) \quad \tau(M) = \frac{1}{12\pi^2} \int_M (|W_+|^2 - |W_-|^2) d\mu.$$

Let us recall that the signature of a smooth compact 4-manifold may be defined in terms of the *intersection pairing*

$$\begin{aligned} \smile: H^2(M, \mathbb{R}) \times H^2(M, \mathbb{R}) &\longrightarrow \mathbb{R} \\ ([\varphi], [\psi]) &\longmapsto \int_M \varphi \wedge \psi \end{aligned}$$

on de Rham cohomology. By Poincaré duality, this is a non-degenerate pairing; and it is symmetric, since 2-forms commute with respect to the wedge product. We may therefore find a basis for $H^2(M, \mathbb{R})$ in which the intersection pairing is represented by the diagonal matrix

$$\begin{bmatrix} 1 & & & & & & \\ & \ddots & & & & & \\ & & 1 & & & & \\ & & \underbrace{\hspace{2cm}}_{b_+(M)} & & & & \\ & & & \begin{cases} -1 \\ \\ \\ -1 \end{cases} & & & \\ & & & & \ddots & & \\ & & & & & & -1 \end{bmatrix},$$

and the numbers $b_{\pm}(M)$ are then topological invariants of M . Their difference

$$\tau(M) = b_+(M) - b_-(M)$$

is the signature of M , whereas their sum

$$b_2(M) = b_+(M) + b_-(M)$$

is just the second Betti number.

A more concrete interpretation of the numbers $b_{\pm}(M)$ can be given by using a bit of Hodge theory. Since every de Rham class on M has a unique harmonic representative with respect to g , we have a canonical identification

$$H^2(M, \mathbb{R}) = \{\varphi \in \Gamma(\Lambda^2) \mid d\varphi = 0, d\star\varphi = 0\}.$$

But the Hodge star operator \star defines an involution of the right-hand side. We thus obtain a direct sum decomposition

$$(5) \quad H^2(M, \mathbb{R}) = \mathcal{H}_g^+ \oplus \mathcal{H}_g^-,$$

where

$$\mathcal{H}_g^{\pm} = \{\varphi \in \Gamma(\Lambda^{\pm}) \mid d\varphi = 0\}$$

are the spaces of self-dual and anti-self-dual harmonic forms. The intersection form is then positive-definite on \mathcal{H}_g^+ , and negative-definite on \mathcal{H}_g^- , so we have

$$b_{\pm}(M) = \dim \mathcal{H}_g^{\pm}.$$

Notice that the spaces \mathcal{H}_g^{\pm} only depend on the conformal class of the metric.

One can easily construct 4-manifolds with any desired values of b_+ and b_- by means of the following construction:

DEFINITION 2.2. *Let M_1 and M_2 be smooth connected compact oriented n -manifolds.*

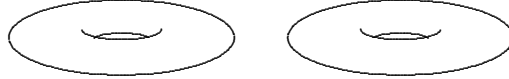

Their connected sum $M_1 \# M_2$ is then the smooth connected oriented n -manifold obtained by deleting a small ball from each manifold

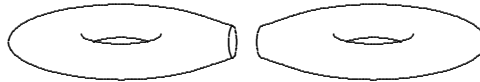

and identifying the resulting S^{n-1} boundaries



via a reflection.

If M_1 and M_2 are simply connected 4-manifolds, then $M = M_1 \# M_2$ is also simply connected, and has $b_{\pm}(M) = b_{\pm}(M_1) + b_{\pm}(M_2)$. Now let us use $\mathbb{C}\mathbb{P}_2$ denote

the complex projective plane with its *standard* orientation, and $\overline{\mathbb{C}\mathbb{P}_2}$ denote the same smooth 4-manifold with the *opposite* orientation. Then the iterated connected sum

$$j\mathbb{C}\mathbb{P}_2\#k\overline{\mathbb{C}\mathbb{P}_2} = \underbrace{\mathbb{C}\mathbb{P}_2\#\cdots\#\mathbb{C}\mathbb{P}_2}_j \# \underbrace{\overline{\mathbb{C}\mathbb{P}_2}\#\cdots\#\overline{\mathbb{C}\mathbb{P}_2}}_k$$

is a simply connected 4-manifold with $b_+ = j$ and $b_- = k$. Notice that $\chi(j\mathbb{C}\mathbb{P}_2\#k\overline{\mathbb{C}\mathbb{P}_2}) = 2 + j + k$ and that $\tau(j\mathbb{C}\mathbb{P}_2\#k\overline{\mathbb{C}\mathbb{P}_2}) = j - k$.

These 4-manifolds are *non-spin*, meaning that their tangent bundles have $w_2 \neq 0$. For a simply connected compact 4-manifold M , this is equivalent to saying that M contains a compact oriented surface of odd self-intersection.

Is this a complete list of the simply connected non-spin 4-manifolds? Well, yes and no. In the affirmative direction, the remarkable work of Michael Freedman [20] tells us the following:

THEOREM 2.3 (Freedman). *Two smooth compact simply connected oriented 4-manifolds are orientedly homeomorphic if and only if*

- they have the same value of b_+ ;
- they have the same value of b_- ; and
- both are spin, or both are non-spin.

Thus, up to *homeomorphism*, the connected sums $j\mathbb{C}\mathbb{P}_2\#k\overline{\mathbb{C}\mathbb{P}_2}$ provide us with a complete list of the simply connected *non-spin* 4-manifolds. However, many of these topological 4-manifolds turn out to have infinitely many distinct *known* smooth structures, and it is generally thought that many of these manifolds will turn out to have exotic smooth structures that no one has even yet imagined.

Freedman's surgical techniques also allow one to classify simply connected *topological* 4-manifolds, but the classification is much more involved. One of the key ingredients that makes it possible to give Theorem 2.3 the simple phrasing used above is the main theorem of Donaldson's thesis [16], which showed that the anti-self-dual Yang-Mills equations implied previously unsuspected constraints on the homotopy types of smooth 4-manifolds:

THEOREM 2.4 (Donaldson). *Let M be any smooth compact simply connected 4-manifold with $b_+ = 0$. Then M is homotopy equivalent to S^4 or to a connected sum $k\overline{\mathbb{C}\mathbb{P}_2}$.*

In particular, if M is a simply connected differentiable 4-manifold with $b_+(M) = 0$ and $b_-(M) \neq 0$, this result tells us that M cannot be spin.

We have just seen that Theorem 2.3 allows us to compile a complete list of simply connected non-spin homeotypes. In the spin case, the situation remains more unsettled, but a conjectural complete list of smoothable simply connected spin homeotypes consists of S^4 , $S^2 \times S^2$, $K3$, their connect sums, and orientation reverses of these. Here $K3$ means the unique simply connected smooth compact 4-manifold admitting a complex structure with $c_1 = 0$. This 4-manifold has $b_+ = 3$ and $b_- = 19$. An interesting model of $K3$ was discovered by Kummer, who considered the involution of T^4 with 16 fixed points which arises as the product of two copies of the Weierstrass involution of an elliptic curve:

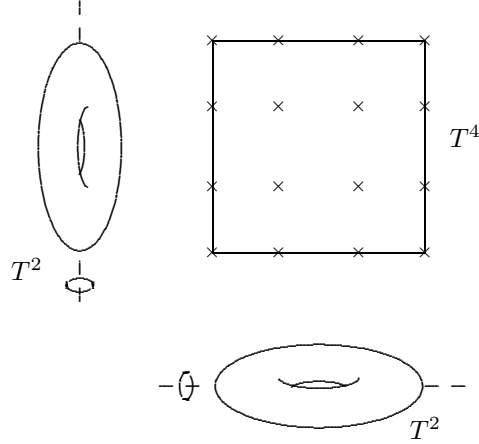

Kummer’s model of $K3$ is then obtained from the orbifold T^4/\mathbb{Z}_2 by replacing each singular point with a $\mathbb{C}\mathbb{P}_1$ of self-intersection -2 . Analogous constructions will turn out to play a central rôle in this paper.

3. Optimal Geometries in Dimension Four

A Riemannian metric is said to be *Einstein* if it has constant Ricci curvature. Since the Ricci curvature of g is by definition the function $v \mapsto r(v, v)$ on the unit tangent bundle $g(v, v) = 1$, where r denotes the Ricci tensor, this is clearly equivalent to the requirement that

$$r = \lambda g$$

for some constant λ . This in turn can be rewritten as the pair of conditions

$$\mathring{r} = 0, \quad s = \text{constant},$$

where $s = \text{trace}_g(r)$ is the scalar curvature, and where $\mathring{r} = r - \frac{s}{n}g$ is the trace-free part of the Ricci tensor. However, double contraction of the second Bianchi identity tells us that

$$\nabla \cdot \mathring{r} = \frac{n-2}{n} ds,$$

so, in any dimension $n \neq 2$, a metric is Einstein iff it satisfies the equation

$$\mathring{r} = 0.$$

An important motivation for the study of optimal metrics is that [10, 11] any Einstein metric is optimal in dimension 4. Indeed, let M be a smooth compact 4-manifold, and let g be an arbitrary Riemannian metric on M . Then the 4-dimensional Gauss-Bonnet formula (3) allows us to rewrite

$$\mathcal{K}(g) = \int_M |\mathcal{R}|^2 d\mu_g$$

as

$$(6) \quad \mathcal{K}(g) = 8\pi^2 \chi(M) + \int_M |\mathring{r}_g|^2 d\mu_g .$$

Thus any metric g with $\mathring{r} = 0$ minimizes \mathcal{K} ; and when such a metric exists, the Einstein metrics are the *only* optimal metrics on M .

However, similar arguments also show that smooth compact 4-manifolds often do not admit Einstein metrics, even in the simply connected case. Indeed, a judicious combination of (3) with (4) reads

$$(7) \quad (2\chi + 3\tau)(M) = \frac{1}{4\pi^2} \int_M \left(\frac{s^2}{24} + 2|W_+|^2 - \frac{|\mathring{r}|^2}{2} \right) d\mu_g,$$

so that a compact oriented 4-manifold M can only admit an Einstein metric if it satisfies the *Hitchin-Thorpe inequality* [32, 57]

$$(2\chi + 3\tau)(M) \geq 0.$$

Thus, for example, the simply connected 4-manifolds $k\overline{\mathbb{C}\mathbb{P}}_2$ do not admit an Einstein metric when $k > 4$, since these spaces have $2\chi + 3\tau = 4 - k$.

In the boundary case of the Hitchin-Thorpe inequality, we also get a striking amount of additional information. Indeed, if $(2\chi + 3\tau)(M) = 0$ and M admits an Einstein metric g , then the Riemannian connection on $\Lambda^+ \rightarrow M$ must be flat, since its curvature tensor is algebraically determined by r and W_+ ; such a metric is said to be *locally hyper-Kähler*. Any locally hyper-Kähler 4-manifold is finitely covered [11, 32] by a flat 4-torus or a Calabi-Yau $K3$. In particular, a simply connected 4-manifold with $2\chi + 3\tau = 0$ can admit an Einstein metric only if it is diffeomorphic to $K3$. In particular, $4\overline{\mathbb{C}\mathbb{P}}_2$ does not admit an Einstein metric, since it has $2\chi + 3\tau = 0$, but is not even homotopy equivalent to $K3$.

It should therefore seem a bit reassuring that there are many simply connected 4-manifolds which carry optimal metrics which are not Einstein [45]. To see this, we may begin by observing that (3) and (4) allow one to re-express \mathcal{K} as

$$(8) \quad \mathcal{K}(g) = -8\pi^2(\chi + 3\tau)(M) + 2 \int_M \left(\frac{s^2}{24} + 2|W_+|^2 \right) d\mu_g.$$

This brings another important class of metrics to the fore:

DEFINITION 3.1. *If M is a smooth oriented 4-manifold, a Riemannian metric g on M will be said to be anti-self-dual (or, for brevity, ASD) if its self-dual Weyl curvature is identically zero:*

$$W_+ \equiv 0.$$

A metric g will be called scalar-flat (or, more briefly, SF) if it satisfies

$$s = 0.$$

Finally, we will say that g is scalar-flat anti-self-dual (or SFASD) if it satisfies both of these conditions.

Equation (8) then immediately yields the following:

PROPOSITION 3.2. *Suppose that M is a smooth compact oriented 4-manifold. If M carries a scalar-flat anti-self-dual metric g , then g is optimal. When this happens, moreover, every other optimal metric g' on M is SFASD, too.*

This fact seems to have first been noticed by Lafontaine [42], who simultaneously discovered an important obstruction to the existence of SFASD metrics. Indeed, equation (7) and our previous discussion of the locally hyper-Kähler manifolds immediately gives us the following upside-down version of the Hitchin-Thorpe inequality:

PROPOSITION 3.3 (Lafontaine). *Let (M, g) be a compact scalar-flat anti-self-dual 4-manifold. Then*

$$(2\chi + 3\tau)(M) \leq 0,$$

with equality if and only if (M, g) is finitely covered by a flat 4-torus or a Calabi-Yau K3.

However, a completely different set of topological constraints is imposed by the following result [43]:

PROPOSITION 3.4. *Let (M, g) be a compact scalar-flat anti-self-dual 4-manifold. Then either*

- $b_+(M) = 0$; or
- $b_+(M) = 1$, and g is a scalar-flat Kähler metric; or else
- $b_+(M) = 3$, and g is a hyper-Kähler metric.

PROOF. Recall that $b_+(M)$ is exactly the dimension of the space of harmonic self-dual 2-forms on M . However, any self-dual 2-form φ on any Riemannian 4-manifold satisfies the Weitzenböck formula [13]

$$(d + d^*)^2\varphi = \nabla^*\nabla\varphi - 2W_+(\varphi, \cdot) + \frac{s}{3}\varphi,$$

so if φ is harmonic and if g is SFASD we obtain

$$0 = \int_M \langle \varphi, \nabla^*\nabla\varphi \rangle d\mu = \int_M |\nabla\varphi|^2 d\mu.$$

Thus, when (M, g) is a compact SFASD manifold, $b_+(M)$ is exactly the dimension of the space of the parallel self-dual 2-forms.

Now $SO(4)$ is a double cover of $SO(3) \times SO(3)$, where the factor projections to $SO(3)$ are given by its action on Λ^\pm . The subgroup of $SO(4)$ stabilizing a non-zero element of Λ^+ is thus the double cover $U(2)$ of $SO(2) \times SO(3)$, whereas the subgroup acting trivially on Λ^+ , or even on a 2-dimensional subspace of it, is the universal cover $SU(2) = Sp(1)$ of $SO(3)$. Thus an oriented Riemannian 4-manifold with a non-trivial parallel self-dual 2-form has holonomy $\subset U(2)$, and is Kähler, whereas the existence of 2 independent parallel self-dual 2-forms would force the manifold to have holonomy $\subset Sp(1)$, and so to be hyper-Kähler. \square

Let us now assume that (M, g) is a *simply connected* SFASD manifold, and see what the above results now tell us. By Proposition 3.4, the only possibilities for $b_+(M)$ are 0, 1 and 3. If $b_+ = 3$, we would have a simply connected hyper-Kähler manifold; such an object is necessarily a K3 surface. If $b_+ = 1$, we have a simply connected complex surface with non-trivial canonical line bundle and a Kähler metric of zero scalar curvature; by a plurigenus vanishing theorem of Yau [59] and the Enriques-Kodaira classification [7], such a complex surface must be obtained from $\mathbb{C}\mathbb{P}_2$ by blowing up and down, and hence diffeomorphic to either $S^2 \times S^2$ or a connected sum $\mathbb{C}\mathbb{P}_2 \# k\overline{\mathbb{C}\mathbb{P}_2}$; and since Proposition 3.3 tells us that $2\chi + 3\tau = 4 - 4b_+ + 5b_+ - b_- = 9 - b_-$ is negative, we conclude in this case that M is diffeomorphic to $\mathbb{C}\mathbb{P}_2 \# k\overline{\mathbb{C}\mathbb{P}_2}$ for some $k > 9$. Finally, if $b_+ = 0$, Theorems 2.4 and 2.3 tell us that M is at least *homeomorphic* to either S^4 or a connected sum $k\overline{\mathbb{C}\mathbb{P}_2}$; and since Proposition 3.3 tells us that $2\chi + 3\tau = 4 - b_-$ is negative, we conclude in this case that M is homeomorphic to $k\overline{\mathbb{C}\mathbb{P}_2}$ for some $k > 4$. Summarizing, we have [43]

PROPOSITION 3.5. *Let M be a smooth compact simply connected 4-manifold. If M admits a scalar-flat anti-self-dual metric g , then*

- M is homeomorphic to $k\overline{\mathbb{C}\mathbb{P}}_2$ for some $k \geq 5$; or
- M is diffeomorphic to $\mathbb{C}\mathbb{P}_2 \# k\overline{\mathbb{C}\mathbb{P}}_2$ for some $k \geq 10$; or else
- M is diffeomorphic to $K3$.

A major objective of this paper is to prove the following partial converse:

THEOREM A. *A simply connected 4-manifold M admits scalar-flat anti-self-dual metrics if*

- M is diffeomorphic to $k\overline{\mathbb{C}\mathbb{P}}_2$ for some $k \geq 6$; or
- M is diffeomorphic to $\mathbb{C}\mathbb{P}_2 \# k\overline{\mathbb{C}\mathbb{P}}_2$ for some $k \geq 14$; or
- M is diffeomorphic to $K3$.

In particular, each of these manifolds carries optimal metrics.

It is worth emphasizing that, except in the $K3$ case, the optimal metrics of Theorem A are necessarily non-Einstein.

On the other hand, Corollary 3.5 and a computation of $\mathcal{I}_{\mathcal{R}}$ will allow us to show that the existence of optimal metrics is highly sensitive to the choice of smooth structure:

THEOREM B. *For each $k \geq 9$, the topological manifold $\mathbb{C}\mathbb{P}_2 \# k\overline{\mathbb{C}\mathbb{P}}_2$ admits infinitely many “exotic” smooth structures for which the corresponding smooth compact 4-manifold does not admit optimal metrics. Similarly, the topological manifold $K3$ admits infinitely many exotic smooth structures for which the corresponding smooth 4-manifold does not admit optimal metrics.*

Similar ideas will also allow us to prove the non-existence of optimal metrics for smooth manifolds representing many more homeotypes:

THEOREM C. *If $j \geq 2$ and $k \geq 9j$, the smooth simply connected 4-manifold $j\mathbb{C}\mathbb{P}_2 \# k\overline{\mathbb{C}\mathbb{P}}_2$ does not admit optimal metrics. Moreover, if $j \geq 5$ and $j \not\equiv 0 \pmod{8}$, the underlying topological manifold of this space admits infinitely many distinct differentiable structures for which no optimal metric exists.*

4. Constructing anti-self-dual metrics

The condition of anti-self-duality is *conformally invariant*; if g is an ASD metric, so is u^2g , for any $u > 0$. The strategy of our proof of Theorem A will be to first construct a family of anti-self-dual conformal classes of metrics on $k\overline{\mathbb{C}\mathbb{P}}_2$, $k \geq 6$, and then show that some of the constructed conformal classes contain scalar-flat metrics. Our approach to both aspects of this problem will be carried out using methods of complex analysis via the Penrose *twistor correspondence*, to which we now provide a brief introduction.

Given any oriented Riemannian 4-manifold (M, g) , one can construct an associated almost-complex 6-manifold (Z, J) , where $\pi : Z \rightarrow M$ is the S^2 -bundle $S(\Lambda^+)$ of unit self-dual 2-forms. The almost-complex structure $J : TZ \rightarrow TZ$ preserves the decomposition of TZ into horizontal and vertical components with respect to the Levi-Civita connection. On the tangent spaces of each fiber S^2 , J simply acts by rotation by -90° . Meanwhile, in the horizontal sub-bundle, which we identify with π^*TM , J acts at $\phi \in S(\Lambda^+)$ by $v \mapsto \sqrt{2}(v \lrcorner \phi)^\sharp$. Each fiber S^2

of $S(\Lambda^+) \rightarrow M$ is thus a J -holomorphic curve, and the fiber-wise antipodal map $\sigma : S(\Lambda^+) \rightarrow S(\Lambda^+)$ is J -anti-holomorphic, in the sense that $\sigma_* \circ J = -J \circ \sigma_*$. A remarkable and non-obvious feature of this construction is that the almost-complex structure J is actually *conformally invariant*, despite the fact that replacing g with u^2g alters the horizontal subspaces on $Z = (\Lambda^+ - 0)/\mathbb{R}^+$.

Now recall that an almost-complex manifold is a complex manifold iff it admits sufficiently many local holomorphic functions. In general, the obstruction [52] to the existence of such functions is the *Nijenhuis tensor*, but in the present case the Nijenhuis tensor of (Z, J) just amounts to the self-dual Weyl curvature W_+ of (M, g) . When (M, g) is anti-self-dual, (Z, J) thus acquires the structure of a complex manifold [4, 53]:

THEOREM 4.1 (Penrose/Atiyah-Hitchin-Singer). *The almost-complex manifold (Z, J) is a complex 3-manifold iff $W_+ = 0$. Moreover, a complex 3-manifold arises by this construction iff it admits a fixed-point-free anti-holomorphic involution $\sigma : Z \rightarrow Z$ and a foliation by σ -invariant rational curves $\mathbb{C}P_1$, each of which has normal bundle $\mathcal{O}(1) \oplus \mathcal{O}(1)$. Finally, the complex manifold (Z, J) and the real structure σ suffice to determine the metric g on M up to conformal rescaling.*

DEFINITION 4.2. *The complex 3-manifold (Z, J) associated with an anti-self-dual 4-manifold (M, g) by Theorem 4.1 is called the twistor space of $(M, [g])$.*

DEFINITION 4.3. *Let (M, g) be an anti-self-dual 4-manifold, let (Z, J) be its twistor space, and let $x \in M$. Then the holomorphic curve $P_x \subset Z$ given by $\pi^{-1}(x) = S(\Lambda_x^+)$ will be called the real twistor line corresponding to x .*

The moduli space of holomorphic curves $\mathbb{C}P_1 \subset Z$ near the real twistor lines is a complex 4-manifold \mathcal{M} , and is a complexification of the original real 4-manifold M . The term *complex twistor line* (or just *twistor line*) is used to refer to any $\mathbb{C}P_1$ in this larger family.

One of the cornerstones of the theory of anti-self-dual manifolds is the connected sum construction of Donaldson and Friedman [15]. If M_1 and M_2 admit anti-self-dual metrics, this allows one to construct anti-self-dual metrics on the connected sum $M_1 \# M_2$, provided the twistor spaces Z_1 and Z_2 of the given manifolds satisfy $H^2(Z_j, \mathcal{O}(TZ_j)) = 0$, $j = 1, 2$. An orbifold generalization of this construction was later developed by the present author in collaboration with Michael Singer [48], and allows one to build up non-singular anti-self-dual manifolds by gluing special orbifolds across $\mathbb{R}P^3 \times \mathbb{R}$ necks. We will now review those features of this generalized construction which will be needed in what follows.

Let (Y, g) be a compact anti-self-dual manifold with twistor space Z , and let us assume from the outset that $H^2(Z, \mathcal{O}(TZ)) = 0$. Let $\phi : Y \rightarrow Y$ be an isometry of (Y, g) with $\phi^2 = \text{id}_Y$, and assume that ϕ has exactly k fixed points, for some positive integer k . Each fixed point is therefore isolated, and in geodesic normal coordinates around any fixed point, ϕ therefore just becomes the involution $\vec{v} \rightarrow -\vec{v}$ of \mathbb{R}^4 ; in particular, ϕ is orientation-preserving. We thus have an induced map $\phi^* : S(\Lambda^+) \rightarrow S(\Lambda^+)$, and this map may be viewed as a holomorphic involution $\hat{\phi} : Z \rightarrow Z$. The fixed point set of $\hat{\phi}$ then consists of a disjoint union of k real twistor lines, one for each fixed point of ϕ . Let \tilde{Z} be obtained by blowing up Z along these k twistor lines, and notice that $\hat{\phi}$ induces a holomorphic involution $\tilde{\phi}$ of \tilde{Z} . The fixed point set of $\tilde{\phi}$ then consists of k quadrics $\mathbb{C}P_1 \times \mathbb{C}P_1$ with normal bundle $\mathcal{O}(1, -1)$, and the $\tilde{\phi}$ acts on their normal bundles by multiplication by -1 .

The quotient \tilde{Z}/\mathbb{Z}_2 is therefore a non-singular compact complex 3-fold containing k hypersurfaces Q_1, \dots, Q_k , each biholomorphic to $\mathbb{CP}_1 \times \mathbb{CP}_1$, and each with normal bundle $\mathcal{O}(2, -2)$. The complement of these hypersurfaces is just the twistor space of $[Y - \{\text{fixed points}\}]/\mathbb{Z}_2$. In this complement, choose $\ell \geq 0$ twistor lines, and blow them up to obtain ℓ hypersurfaces $Q_{k+1}, \dots, Q_{k+\ell}$, each biholomorphic to $\mathbb{CP}_1 \times \mathbb{CP}_1$, and each with normal bundle $\mathcal{O}(1, -1)$. Let Z_+ denote this blow-up of \tilde{Z}/\mathbb{Z}_2 , and notice that our original anti-holomorphic involution σ of Z induces an anti-holomorphic involution $\sigma_+ : Z_+ \rightarrow Z_+$.

The next ingredient we will need is a compactification of the twistor space of the Eguchi-Hanson metric. The usual Eguchi-Hanson metric [19] is a locally asymptotically flat hyper-Kähler metric on T^*S^2 which, up to homothety, is the metric-space completion of the Riemannian metric

$$g_{EH,\epsilon} = \frac{d\varrho^2}{1 - \varrho^{-4}} + \varrho^2 (\sigma_1^2 + \sigma_2^2 + [1 - \varrho^{-4}] \sigma_3^2)$$

on $(1, \infty) \times S^3/\mathbb{Z}_2$, where $\{\sigma_j\}$ is the standard left-invariant co-frame on $S^3/\mathbb{Z}_2 = SO(3)$. However, because this metric is asymptotic to the flat metric on $(\mathbb{R}^4 - \{0\})/\mathbb{Z}_2$ as $\varrho \rightarrow \infty$, its conformal class naturally extends to an orbifold ASD conformal metric on $T^*S^2 \cup \{\infty\}$, where the added point is singular, with a neighborhood modeled on $\mathbb{R}^4/\mathbb{Z}_2$. Blowing up the twistor line of this added ‘‘point at infinity’’ then yields a non-singular complex 3-fold \tilde{Z}_{EH} which contains a hypersurface $Q \cong \mathbb{CP}_1 \times \mathbb{CP}_1$ with normal bundle $\mathcal{O}(2, -2)$ arising as the exceptional divisor of the blow-up. The complex 3-fold \tilde{Z}_{EH} is [48] a small resolution of the hypersurface

$$xy = z^2 - t^2 \zeta_1^2 \zeta_2^2$$

in the \mathbb{CP}_3 -bundle $\mathbb{P}(\mathcal{O}(2)^{\oplus 3} \oplus \mathcal{O})$ over \mathbb{CP}_1 , where $x, y, z \in \mathcal{O}(2)$, $t \in \mathcal{O}$, and $[\zeta_1 : \zeta_2]$ are the homogeneous coordinates on \mathbb{CP}_1 . The small resolutions replace the two singular points $x = y = z = 0$ with rational curves.

Finally, consider the Fubini-Study metric on \mathbb{CP}_2 , which, up to homothety, may be characterized as the the unique $SU(3)$ -invariant metric on the complex projective plane. Because the isotropy subgroup $U(2) \subset SU(3)$ is so large, the Fubini-Study metric has $W_- = 0$ for representation-theoretic reasons; reversing the orientation, the Fubini-Study metric thus becomes an ASD metric on $\overline{\mathbb{CP}}_2$. Let Z_{FS} denote the twistor space of this metric, and let \tilde{Z}_{FS} denote its blow-up along a real twistor line. Explicitly, Z_{FS} may be realized [4] as

$$\{([x_1 : x_2 : x_3], [y_1 : y_2 : y_3]) \in \mathbb{CP}_2 \times \mathbb{CP}_2 \mid \sum_j x_j y_j = 0\},$$

and we may take the relevant twistor line to be given by $x_1 = y_1 = 0$. Blowing up of this twistor line provides us with a preferred hypersurface $\mathbb{CP}_1 \times \mathbb{CP}_1$ with normal bundle $\mathcal{O}(1, -1)$.

Now let Z_- be the disjoint union of k copies of \tilde{Z}_{EH} and ℓ copies of \tilde{Z}_{FS} , and let σ_- be the real structure it inherits from the twistor spaces of the Eguchi-Hanson and Fubini-Study metrics. Let $Q_- \subset Z_-$ be the disjoint union of $k + \ell$ copies of $\mathbb{CP}_1 \times \mathbb{CP}_1$, each being a copy of the constructed exceptional divisor in a copy of \tilde{Z}_{EH} or \tilde{Z}_{FS} . Remembering that Z_+ also contains a disjoint union $Q_+ = Q_1 \sqcup \dots \sqcup Q_{k+\ell}$ of the same number of copies of $\mathbb{CP}_1 \times \mathbb{CP}_1$, we may thus form a 3-dimensional complex-analytic space Z_0 with normal crossing singularities

by identifying Q_+ with Q_- . However, we carry out this identification according to a few simple rules. First of all, the quadrics Q_1, \dots, Q_k are each to be identified with a quadric in a copy of \tilde{Z}_{EH} , while the remaining quadrics Q_{k+1}, \dots, Q_{k+l} are each to be identified with a quadric in a copy of \tilde{Z}_{FS} . Secondly, we always interchange the factors of $\mathbb{CP}_1 \times \mathbb{CP}_1$ when gluing Q_+ to Q_- , thereby making the normal bundles of each quadric relative to Z_+ and Z_- dual to each other. Finally, we always make our identifications in such a way that the real structures σ_+ and σ_- agree on the locus Q obtained by identifying Q_+ with Q_- , so that Z_0 comes equipped with an anti-holomorphic involution $\sigma_0 : Z_0 \rightarrow Z_0$.

Because we have assumed that $H^2(Z, \mathcal{O}(TZ)) = 0$, one can show [48] that $\mathbf{Ext}_{Z_0}^2(\Omega^1, \mathcal{O}) = 0$, and a generalization of Kodaira-Spencer theory [21] then yields a versal deformation of Z_0 , parameterized by a neighborhood of the origin in $\mathbf{Ext}_{Z_0}^1(\Omega^1, \mathcal{O})$. The generic fiber of this family is non-singular

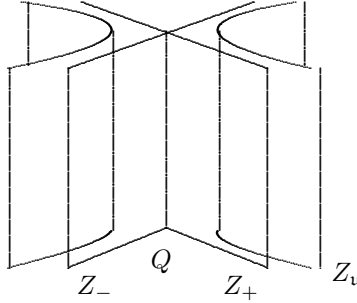

and the real structure σ_0 extends to act on the total space of this family.

Rather than working with the entire versal family, it is convenient to restrict one's attention to certain subfamilies, called *standard deformations*. A 1-parameter *standard deformation* of Z_0 is by definition a flat proper holomorphic map $\varpi : \mathcal{Z} \rightarrow \mathcal{U}$ together with an anti-holomorphic involution $\sigma : \mathcal{Z} \rightarrow \mathcal{Z}$, such that

- \mathcal{Z} is a complex 4-manifold;
- $\mathcal{U} \subset \mathbb{C}$ is an open neighborhood of 0;
- $\varpi^{-1}(0) = Z_0$;
- $\sigma|_{Z_0} = \sigma_0$;
- σ covers complex conjugation in \mathcal{U} ;
- ϖ is a submersion away from $Q \subset Z_0$; and
- near any point of Q , ϖ is modeled on $(x, y, z, w) \mapsto xy$.

When $u \in \mathcal{U} \subset \mathbb{C}$ is real, non-zero, and sufficiently small, the corresponding fiber $Z_u = \varpi^{-1}(u)$ is a twistor space, and we obtain the following result [15, 48]:

THEOREM 4.4. *Let (Y, g) be a compact anti-self-dual 4-manifold equipped with an isometric \mathbb{Z}_2 -action with exactly ℓ fixed points, for some positive integer ℓ . Let Z denote the twistor space of (Y, g) , and suppose that $H^2(Z, \mathcal{O}(TZ)) = 0$. Let $X = Y/\mathbb{Z}_2$, and let \tilde{X} be the oriented manifold obtained by replacing each singularity of X with a 2-sphere of self-intersection -2 . Then, for any integer $k \geq 0$, there are anti-self-dual conformal classes on $\tilde{X} \# k\overline{\mathbb{CP}}_2$ whose twistor spaces arise as fibers in a 1-parameter standard deformation of $Z_0 = (\tilde{Z}/\mathbb{Z}_2) \cup \ell\tilde{Z}_{EH} \cup k\tilde{Z}_{FS}$.*

Similarly, one can define standard deformations depending on several parameters. For example, a 2-parameter *standard deformation* of Z_0 is by definition a flat

proper holomorphic map $\varpi : \mathcal{Z} \rightarrow \mathcal{U}$ together with an anti-holomorphic involution $\sigma : \mathcal{Z} \rightarrow \mathcal{Z}$, such that

- \mathcal{Z} is a complex 5-manifold;
- $\mathcal{U} \subset \mathbb{C}^2$ is an open neighborhood of $(0, 0)$;
- $\varpi^{-1}(0, 0) = Z_0$;
- $\sigma|_{Z_0} = \sigma_0$;
- σ covers complex conjugation in \mathcal{U} ;
- ϖ is a submersion away from $Q \subset Z_0$; and
- near any point of Q , ϖ is modeled on $(x, y, z, v, w) \mapsto (xy, z)$.

When $(\mathbf{u}_1, \mathbf{u}_2) \in \mathcal{U} \subset \mathbb{C}^2$ is real, and sufficiently close to $(0, 0)$, with $\mathbf{u}_1 \neq 0$, the corresponding fiber $Z_{\mathbf{u}} = \varpi^{-1}(\mathbf{u}_1, \mathbf{u}_2)$ is a twistor space. By extracting such standard deformations from the versal deformation of Z_0 , the same proof tells one the following:

THEOREM 4.5. *Let Y be a compact real-analytic oriented 4-manifold equipped with a \mathbb{Z}_2 -action with exactly ℓ fixed points, for some positive integer ℓ . Let $[g_t]$, $t \in (-\varepsilon, \varepsilon)$, be a real-analytic 1-parameter family of \mathbb{Z}_2 -invariant anti-self-dual conformal metrics on Y . Let $X = Y/\mathbb{Z}_2$, and let \tilde{X} be the oriented manifold obtained by replacing each singularity of X with a 2-sphere of self-intersection -2 . Let Z denote the twistor space of $(Y, [g_0])$, and suppose that $H^2(Z, \mathcal{O}(TZ)) = 0$. Then, for any $k \geq 0$, there is a 2-parameter standard deformation of $Z_0 = (\tilde{Z}/\mathbb{Z}_2) \cup \ell \tilde{Z}_{EH} \cup k \tilde{Z}_{FS}$ such that, for all small real numbers $\mathbf{u}_1 > 0$ and \mathbf{u}_2 , the fiber $Z_{(\mathbf{u}_1, \mathbf{u}_2)}$ is the twistor spaces of a family of an anti-self-dual metric on $\tilde{X} \#_k \overline{\mathbb{C}\mathbb{P}_2}$, and such that, for all sufficiently small real numbers t , the fiber over $Z_{(0,t)}$ is the complex-analytic space with normal crossings built from the twistor space of $(Y, [g_t])$ by analogy to the construction of Z_0 .*

5. Conformal Green's Functions

Let (M, g) be a compact Riemannian 4-manifold, and assume that its Yamabe Laplacian $\Delta + s/6$ has trivial kernel; the latter is automatic if the conformal class $[g]$ contains a metric with $s > 0$, never happens if $[g]$ contains a metric with $s \equiv 0$, and may or may not happen if $[g]$ contains a metric with $s < 0$. Since the operator $\Delta + s/6$ is self-adjoint, it also has trivial cokernel, and the equation

$$(\Delta + s/6)u = f$$

therefore has a unique smooth solution u for any smooth function f ; it follows that it also has a unique distributional solution u for any distribution f . If $y \in M$ is any point, and if δ_y is the Dirac delta distribution centered at y , we thus have a unique distributional solution G_y of the equation

$$(\Delta + s/6)G_y = \delta_y.$$

Since δ_y is identically zero on $M - \{y\}$, elliptic regularity tells us that G_y is actually smooth away from y . In general, one has an expansion

$$G_y = \frac{1}{4\pi^2} \frac{1}{\varrho^2} + O(\log \varrho)$$

near ϱ denotes the distance from y , but when (M, g) is anti-self-dual it in fact turns out [3] that

$$G_y = \frac{1}{4\pi^2} \frac{1}{\varrho^2} + \text{bounded terms.}$$

In this article, the function G_y will be called the *conformal Green's function* of (M, g, y) .

The motivation for this terminology is that the Yamabe Laplacian is a *conformally invariant* differential operator when viewed as a map between sections of suitable real line bundles; the geometric reason for this is that for any smooth function $u \neq 0$, the expression $6u^{-3}(\Delta + s/6)u$ computes the scalar curvature of the conformally related metric u^2g on the open set $u \neq 0$. One useful consequence of this is that, for any smooth function $u > 0$ on M , a constant times $u^{-1}G_y$ is the conformal Green's function of (M, u^2g, y) .

Now the celebrated proof of the Yamabe conjecture [49] tells us that any conformal class on any compact manifold contains metrics of constant scalar curvature. In particular, any conformal class contains metrics whose scalar curvature has the same sign at every point. But actually, this last assertion is much more elementary. Indeed, if $u \neq 0$ is an eigenfunction corresponding to the lowest eigenvalue λ of the Yamabe Laplacian, then u has empty nodal set, and u^2g is therefore a conformally related metric whose scalar curvature has the same sign as λ everywhere on M . Similar considerations also show that if two metrics with scalar curvatures of fixed signs are conformally related, then their scalar curvatures have the same sign. The *sign of Yamabe constant* of a conformal class, meaning the sign of the constant scalar curvature of the metric produced by the proof of the Yamabe conjecture, therefore coincides with the sign of the smallest Yamabe eigenvalue λ for any metric in the conformal class.

Here is another way of determining the sign of the Yamabe constant:

LEMMA 5.1. *Let (M, g) be a compact Riemannian 4-manifold whose Yamabe Laplacian $\Delta + s/6$ has trivial kernel. Let $y \in M$ be any point. Then the conformal class $[g]$ contains a metric of positive scalar curvature if and only if $G_y(x) \neq 0$ for all $x \in M - \{y\}$. Moreover, if $[g]$ contains a metric of negative scalar curvature, then $G_y(x) < 0$ for some $x \in M$.*

These assertions also hold for any finite sum $G_{y_1} + \dots + G_{y_m}$, or for any other finite linear combinations of conformal Green's functions with positive coefficients.

PROOF. Since the Yamabe Laplacian is conformally invariant when viewed as acting on functions of the appropriate conformal weight, we may assume from the outset that either $s > 0$ everywhere, or else $s < 0$ everywhere.

Now notice that notice that

$$\frac{1}{6} \int sG_y \, d\mu = \int (\Delta + s/6)G_y \, d\mu = \int \delta_y \, d\mu = 1 > 0.$$

Thus, if $s < 0$, G_y must be negative somewhere, and since $G_y \rightarrow +\infty$ at y , the Green's function must also have a zero by continuity. Notice that the same argument works for any finite linear combinations of Green's functions with positive coefficients.

On the other hand, $G_y^{-1}((-\infty, a])$ is compact for any $a \in \mathbb{R}$, and it follows that G_y has a minimum. But if $s > 0$, then $G_y = \frac{1}{s} \nabla \cdot \nabla G_y$ on $M - \{y\}$, and hence $G_y \geq 0$ at its minimum. Moreover, if the minimum were actually zero, we could apply Hopf's strong maximum principle [26, 54] to $-G_y$, and conclude that $G_y \equiv 0$, contradicting the fact that $G_y \rightarrow \infty$ at y . Thus $G_y > 0$ everywhere, as claimed. As a consequence, any finite linear combinations of Green's functions with

positive coefficients is a sum of positive functions, and so is positive at all points where its value is defined. \square

Now suppose that (M, g) is a compact *anti-self-dual* Riemannian 4-manifold, and let Z be its twistor space. If $U \subset M$ is any open subset, and if $Z_U \subset Z$ is its inverse image in the twistor space, the Penrose transform [5, 33] gives a natural one-to-one correspondence between $H^1(Z_U, \mathcal{O}(K^{1/2}))$ and the smooth complex-valued functions on U which solve $(\Delta + s/6)u = 0$. Given a cohomology class $\psi \in H^1(Z_U, \mathcal{O}(K^{1/2}))$, the value of the corresponding function u_ψ at $x \in U$ is obtained by restricting u_ψ to the real twistor line $P_x \subset Z$ to obtain an element of $H^1(P_x, \mathcal{O}(K_Z^{1/2})) \cong H^1(\mathbb{C}\mathbb{P}_1, \mathcal{O}(-2)) \cong \mathbb{C}$. Note that u_ψ is ostensibly only a section of a line bundle, but the choice of a metric g in the conformal class turns out to determine a canonical trivialization of this line bundle [33], and u_ψ then becomes a function in the ordinary sense.

In particular, our compact anti-self-dual 4-manifold (M, g) satisfies $\ker(\Delta + s/6) = 0$ iff its twistor space Z satisfies $H^1(Z, \mathcal{O}(K^{1/2})) = 0$, and Serre duality tells us that the latter happens iff $H^2(Z, \mathcal{O}(K^{1/2})) = 0$. When any of these three equivalent conditions is met, we then have a conformal Green's function G_y for any chosen $y \in M$, and G_y then corresponds to a particular element of $H^1(Z - P_y, \mathcal{O}(K^{1/2}))$, where P_y is the twistor line corresponding to y . What is this mysterious cohomology class? The answer was discovered by Atiyah [3], and involves a construction largely due to Serre [56] and Horrocks [34]:

LEMMA 5.2. *Let W be a (possibly non-compact) complex manifold, and let $V \subset W$ be a closed complex submanifold of complex codimension 2. Let $N \rightarrow V$ denote the normal bundle TW/TV of V , and suppose that there is a holomorphic line bundle $L \rightarrow W$ such that*

- $L|_V \cong \wedge^2 N$;
- $H^1(W, \mathcal{O}(L)) = 0$; and
- $H^2(W, \mathcal{O}(L)) = 0$.

Then there is a rank-2 holomorphic vector bundle $E \rightarrow W$, together with a holomorphic section $\zeta \in \Gamma(W, \mathcal{O}(E))$ such that

- $\wedge^2 E \cong L$;
- $\zeta = 0$ exactly at W ; and
- $d\zeta : N \rightarrow E$ is an isomorphism.

This (E, ζ) is unique up to isomorphism if we also demand that the isomorphism $\det d\zeta : \wedge^2 N \rightarrow \wedge^2 E|_V$ should agree with a given isomorphism $\wedge^2 N \rightarrow L|_V$. The pair (E, ζ) gives rise to an extension

$$0 \rightarrow \mathcal{O}(L^*) \rightarrow \mathcal{O}(E^*) \xrightarrow{\cdot\zeta} \mathcal{I}_V \rightarrow 0,$$

where \mathcal{I}_V is the ideal sheaf of V ; and by restriction to $W - V$, this extension determines an element of $H^1(W - V, \mathcal{O}(L^))$.*

PROOF. Because [2, 28] $V \subset W$ is smooth and of codimension 2,

$$\mathcal{E}xt^q(\mathcal{O}_V, \mathcal{O}(L^*)) = \begin{cases} 0 & q = 0, 1, \\ \mathcal{O}_V(L^* \otimes \wedge^2 N) & q = 2, \end{cases}$$

and the spectral sequence

$$E_2^{p,q} = H^p(W, \mathcal{E}xt^q(\mathcal{O}_V, \mathcal{O}(L^*))) \implies \mathbf{E}xt_W^{p+q}(\mathcal{O}_V, \mathcal{O}(L^*))$$

therefore tells us that

$$\mathbf{Ext}_W^2(\mathcal{O}_V, \mathcal{O}(L^*)) = \Gamma(V, \mathcal{O}_V(L^* \otimes \wedge^2 N)).$$

On the other hand, the tautological short exact sequence of sheaves

$$0 \rightarrow \mathcal{I}_V \rightarrow \mathcal{O} \rightarrow \mathcal{O}_V \rightarrow 0$$

induces a long exact sequence

$$\begin{aligned} \cdots \rightarrow \mathbf{Ext}_W^1(\mathcal{O}, \mathcal{O}(L^*)) &\rightarrow \mathbf{Ext}_W^1(\mathcal{I}_V, \mathcal{O}(L^*)) \\ \rightarrow \mathbf{Ext}_W^2(\mathcal{O}_V, \mathcal{O}(L^*)) &\rightarrow \mathbf{Ext}_W^2(\mathcal{O}, \mathcal{O}(L^*)) \rightarrow \cdots \end{aligned}$$

and since

$$\mathbf{Ext}_W^j(\mathcal{O}, \mathcal{O}(L^*)) = H^j(W, \mathcal{O}(L^*))$$

is assumed to vanish when $j = 1, 2$, the Bockstein map of this long exact sequence therefore gives us an isomorphism

$$\mathbf{Ext}_W^1(\mathcal{I}_V, \mathcal{O}(L^*)) \cong \Gamma(V, \mathcal{O}_V(L^* \otimes \wedge^2 N)).$$

In particular, any choice of isomorphism $\wedge^2 N \rightarrow L|_V$ gives us an extension

$$(9) \quad 0 \rightarrow \mathcal{O}(L^*) \rightarrow \mathcal{O}(E^*) \rightarrow \mathcal{I}_V \rightarrow 0$$

of sheaves on W . The class of this extension is called the *Serre class* $\lambda(V) \in \mathbf{Ext}_W^1(\mathcal{I}_V, \mathcal{O}(L^*))$, and its restriction to $W - V$ is an element of $H^1(W - V, \mathcal{O}(L^*))$. Strictly speaking, the Serre class depends on a choice of isomorphism $\wedge^2 N \rightarrow L|_V$, but any two such extensions are intertwined by an automorphism of $L|_V$.

Since any isomorphism $\wedge^2 N \rightarrow L|_V$ corresponds to a section of $\mathcal{E}xt^2(\mathcal{O}_V, \mathcal{O}(L^*))$ which is non-zero at each point of V , the corresponding extension (9) is locally free, with $\wedge^2 E^* = L^*$. Tensoring the inclusion $\mathcal{O}(L^*) \hookrightarrow \mathcal{O}(E^*)$ by L , we thus obtain an inclusion

$$\mathcal{O} \hookrightarrow \mathcal{O}(E^* \otimes \wedge^2 E) = \mathcal{O}(E),$$

and the image of 1 under this map is then a section $\zeta \in \Gamma(W, \mathcal{O}(E))$ with all the advertised properties. \square

PROPOSITION 5.3 (Atiyah). *Let (M, g) be a compact anti-self-dual 4-manifold with twistor space Z , and assume that (M, g) has*

$$\ker(\Delta + s/6) = 0.$$

Let $y \in M$ be any point, and let $P_y \subset Z$ be the corresponding twistor line. Then the image of the Serre class $\lambda(P_y) \in \mathbf{Ext}_Z^1(\mathcal{I}_{P_y}, \mathcal{O}(K^{1/2}))$ in $H^1(Z - P_y, \mathcal{O}(K^{1/2}))$ is the Penrose transform of the Green's function G_y times a non-zero constant.

Indeed, if one identifies $K_Z^{1/2}|_{P_y}$ with K_{P_y} according to the isomorphism determined by g and the conventions of [33], the relevant constant turns out to be exactly 4π .

Combining this remarkable result with Lemma 5.1 now gives us a twistorial criterion for determining whether an anti-self-dual conformal class has positive Yamabe constant:

PROPOSITION 5.4. *Let Z be the twistor space of a compact anti-self-dual 4-manifold $(M, [g])$, and let $P_y \subset Z$ be a real twistor line. Then the conformal class $[g]$ contains a metric g of positive scalar curvature if and only if*

- $H^1(Z, \mathcal{O}(K^{1/2})) = 0$, and

- the holomorphic vector bundle $E \rightarrow Z$ with $\wedge^2 E \cong K^{-1/2}$ associated to P_y by Lemma 5.2 satisfies $E|_{P_x} \cong \mathcal{O}(1) \oplus \mathcal{O}(1)$ for every real twistor line P_x .

PROOF. Let us first recall that

$$\ker(\Delta + s/6) = H^1(Z, \mathcal{O}(K^{1/2})) = [H^2(Z, \mathcal{O}(K^{1/2}))]^*,$$

so that a necessary condition for the positivity of the Yamabe constant is certainly the vanishing of $H^1(Z, \mathcal{O}(K^{1/2}))$. When this happens, Lemma 5.2 then allows us to construct $E \rightarrow Z$. On $Z - P_y$, E is then given by an extension

$$0 \rightarrow \mathcal{O} \rightarrow \mathcal{O}(E) \rightarrow \mathcal{O}(K^{-1/2}) \rightarrow 0,$$

and this extension is represented by an element of $H^1(Z - P_y, \mathcal{O}(K^{1/2}))$. The value of the Penrose transform of this class at $x \neq y$ is obtained via the restriction map

$$H^1(Z - P_y, \mathcal{O}(K^{1/2})) \rightarrow H^1(P_x, \mathcal{O}_{P_x}(K^{1/2})) \cong \mathbb{C}$$

and its value at x is therefore non-zero iff the induced extension

$$0 \rightarrow \mathcal{O} \rightarrow E|_{P_x} \rightarrow \mathcal{O}(2) \rightarrow 0$$

does not split; and this happens iff $E|_{P_x} \cong \mathcal{O}(1) \oplus \mathcal{O}(1)$. Since we also have $E|_{P_y} \cong \mathcal{O}(1) \oplus \mathcal{O}(1)$ by construction, the result now follows from lemma 5.1 and Proposition 5.3. \square

6. The Sign of the Scalar Curvature

We are now ready to approach the problem of determining the sign of the Yamabe constant for the anti-self-dual conformal classes constructed in Theorem 4.4. The results obtained in this section are loosely inspired by the work of Dominic Joyce [37] on the Yamabe constants of certain conformal classes on connect sums, although the techniques employed here are completely different from Joyce's.

LEMMA 6.1. *Let $\varpi : \mathcal{Z} \rightarrow \mathcal{U}$ be a 1-parameter standard deformation of Z_0 , where Z_0 is as in Theorem 4.4, and $\mathcal{U} \subset \mathbb{C}$ is an open disk about the origin. Let $k\tilde{Z}_{EH}$ be the union of the Eguchi-Hanson components of $Z_- \subset Z_0$, which is a non-singular complex hypersurface in \mathcal{Z} , and let $\mathcal{I}_{k\tilde{Z}_{EH}} \subset \mathcal{O}$ denotes its ideal sheaf. Then the invertible sheaf $\mathcal{I}_{k\tilde{Z}_{EH}}(K_{\mathcal{Z}}) \subset \mathcal{O}_{\mathcal{Z}}(K_{\mathcal{Z}})$ has a square-root as a holomorphic line bundle.*

PROOF. A holomorphic line bundle has a holomorphic square-root iff its second Stieffel-Whitney class $w_2 \in H^2(\mathbb{Z}_2)$ vanishes. Write \mathcal{Z} as $U \cup V$, where U is a tubular neighborhood of Z_+ , V is a tubular neighborhood of Z_- , and $U \cap V$ is a tubular neighborhood of Q , so that these open sets deform retract to Z_+ , Z_- , and Q , respectively. Since each component of Q is simply connected, the Mayer-Vietoris sequence

$$\cdots \rightarrow H^1(U \cap V, \mathbb{Z}_2) \rightarrow H^2(U \cup V, \mathbb{Z}_2) \rightarrow H^2(U, \mathbb{Z}_2) \oplus H^2(V, \mathbb{Z}_2) \rightarrow \cdots$$

therefore tells us that it is enough to check that the restrictions of our line bundle to Z_+ and Z_- both have square-roots.

It thus suffices to produce an explicit square-root of the restrictions of $\mathcal{I}_{k\tilde{Z}_{EH}} \otimes K_{\mathcal{Z}}$ to each copy of \tilde{Z}_{FS} , each copy of \tilde{Z}_{EH} , and to Z_+ . On each copy of \tilde{Z}_{FS} , such a square-root is given by $[Q] \otimes K_{Z_{FS}}^{1/2}$, where $[Q]$ is the divisor of the exceptional

quadric, and where $Z_{FS}^{1/2}$ is the pull-back of $K^{1/2}$ from the twistor space Z_{FS} via the blowing-down map. On each copy of \tilde{Z}_{EH} , such a square-root is given by the pull-back of $\mathcal{O}(-2)$ via the projection $\tilde{Z}_{EH} \rightarrow \mathbb{C}\mathbb{P}_1$. And on Z_+ , there is a natural choice of square-root whose sections are the \mathbb{Z}_2 invariant sections of $K_Z^{1/2}$, pulled-back to the blow-up \tilde{Z} , twisted by the divisors $Q_{k+1}, \dots, Q_{k+\ell}$. That each of these bundles really has the correct square can be verified directly using the adjunction formula; the details are left as an exercise for the interested reader. \square

LEMMA 6.2. *Let $\varpi : \mathcal{Z} \rightarrow \mathcal{U}$ be a 1-parameter standard deformation of Z_0 , where Z_0 is as in Theorem 4.4, and $\mathcal{U} \subset \mathbb{C}$ is a neighborhood of the origin. Let $L \rightarrow \mathcal{Z}$ be the holomorphic line bundle defined by*

$$\mathcal{O}(L^*) = [\mathcal{I}_{k\tilde{Z}_{EH}}(K_{\mathcal{Z}})]^{1/2} \otimes \mathcal{I}_{\ell\tilde{Z}_{FS}},$$

where the hypersurface $\ell\tilde{Z}_{FS} \subset \mathcal{Z}$ is the union of the Fubini-Study components of Z_- . If the twistor space Z of $(Y, [g])$ satisfies $H^1(Z, \mathcal{O}(K^{1/2})) = 0$, then by possibly replacing \mathcal{U} with a smaller neighborhood of $0 \in \mathbb{C}$ and simultaneously replacing \mathcal{Z} with its inverse image, we can arrange for our complex 4-fold \mathcal{Z} to satisfy

$$H^1(\mathcal{Z}, \mathcal{O}(L^*)) = H^2(\mathcal{Z}, \mathcal{O}(L^*)) = 0.$$

PROOF. Since any open set in \mathbb{C} is Stein, the Leray spectral sequence tells us that it would suffice to show that the direct image sheaves $\varpi_*^j \mathcal{O}(L^*)$ vanish for $j = 1, 2$. But since ϖ is flat and we are allowed to shrink \mathcal{U} if necessary, semi-continuity [6] asserts that it is enough to show that $H^j(Z_0, \mathcal{O}(L^*)) = 0$ for $j = 1, 2$.

The normalization of Z_0 is the disjoint union $Z_+ \sqcup Z_-$, and we have an exact sequence

$$0 \rightarrow \mathcal{O}_{Z_0}(L^*) \rightarrow \nu_* \mathcal{O}_{Z_+}(L^*) \oplus \nu_* \mathcal{O}_{Z_-}(L^*) \rightarrow \mathcal{O}_Q(L^*) \rightarrow 0$$

where $\nu : Z_+ \sqcup Z_- \rightarrow Z_0$ is the identification map. However, $\mathcal{O}_{Z_0}(L^*)$ exactly consists of \mathbb{Z}_2 -invariant sections of the pull-back of $K_Z^{1/2}$, and the Leray spectral sequence therefore tells us that

$$H^j(Z, \mathcal{O}(K^{1/2})) = 0 \implies H^j(Z_+, \mathcal{O}(L^*)) = 0,$$

so our vanishing hypothesis guarantees that these groups vanish for all j . On the other hand,

$$H^j(\tilde{Z}_{EH}, \mathcal{O}(L^*)) = H^j(\tilde{Z}_{FS}, \mathcal{O}(L^*)) = H^j(Q_j, \mathcal{O}(L^*)) = \begin{cases} \mathbb{C} & j = 1, \\ 0 & j \neq 1. \end{cases}$$

and each of the relevant restriction maps, from $H^1(\tilde{Z}_{EH}, \mathcal{O}(L^*))$ or $H^1(\tilde{Z}_{FS}, \mathcal{O}(L^*))$ to the cohomology group $H^1(\mathbb{C}\mathbb{P}_1 \times \mathbb{C}\mathbb{P}_1, \mathcal{O}(-2, 0))$ of the appropriate quadric Q_j , is an isomorphism. Hence $H^j(Z_0, \mathcal{O}(L^*)) = 0$ for all j , and the result follows. \square

Now choose a real twistor line $P_x \in Z_+$, and extend this as a 1-parameter family of twistor lines in $P_{x_u} \in Z_u$ for u near $0 \in \mathbb{C}$ and such that P_{x_u} is a real twistor line for u real. By possibly shrinking \mathcal{U} , we may then arrange that $\mathcal{P} = \cup_u P_{x_u}$ is a closed submanifold of \mathcal{Z} and that $H^1(\mathcal{Z}, \mathcal{O}(L^*)) = H^2(\mathcal{Z}, \mathcal{O}(L^*)) = 0$. The hypotheses of Lemma 5.2 are then satisfied, and we thus obtain a holomorphic vector bundle $E \rightarrow \mathcal{Z}$ and a holomorphic section ζ vanishing exactly along \mathcal{P} ; moreover, the corresponding extension

$$0 \rightarrow \mathcal{O}(L^*) \rightarrow \mathcal{O}(E^*) \rightarrow \mathcal{I}_{\mathcal{P}} \rightarrow 0$$

gives us an element of $\lambda(\mathcal{P}) \in H^1(\mathcal{Z} - \mathcal{P}, \mathcal{O}(L^*))$. Since the restriction of L^* to any smooth fiber Z_u , $u \neq 0$, is just $K^{1/2}$, Proposition 5.3 tells us that the restriction of $\lambda(\mathcal{P})$ to Z_u , $u > 0$, has Penrose transform equal to a positive constant times the conformal Green's function of $(\tilde{X} \# \ell \overline{\mathbb{C}\mathbb{P}_2}, g_u, x_u)$ for any $u > 0$. However, we may also restrict (E, ζ) to Z_+ , and, by pulling-back and pushing down, convert this into a \mathbb{Z}_2 -invariant holomorphic vector bundle on the twistor space Z of (Y, g) . This bundle on Z then has determinant line bundle $K^{-1/2}$, and comes equipped with a section vanishing exactly at the twistor lines of the two pre-images of y_1, y_2 of $x \in X$; by Proposition 5.3, the Penrose transform of this object corresponds, according to your taste, either to the Green's function G_x on (X, g) or to the sum $G_{y_1} + G_{y_2}$ on (Y, g) . If g has negative scalar curvature, Lemma 5.1 thus tells us that is a region of X where $G_x < 0$, and defroming the twistor lines of this into Z_u for small $u > 0$ then shows that the conformal Green's function of $[g_u]$ is negative somewhere for any small u . By Lemma 5.1, we thus obtain the following:

THEOREM 6.3. *In Theorem 4.4, suppose that (Y, g) is an anti-self-dual manifold with $s < 0$ and $\ker(\Delta + s/6) = 0$. Then for all sufficiently small $u > 0$, the conformal class $[g_u]$ contains a metric of negative scalar curvature.*

The positive case is similar, but is slightly more delicate. Instead of just restricting $\lambda(\mathcal{P})$ on rational curves in Z_+ , we must also consider what happens when we restrict this class to twistor lines in Z_- . However, we already saw in the proof of Lemma 6.2, an element of $H^1(\tilde{Z}_{EH}, \mathcal{O}(L^*)) \cong \mathbb{C}$ or $H^1(\tilde{Z}_{FS}, \mathcal{O}(L^*)) \cong \mathbb{C}$ is non-zero iff its restriction to the corresponding exceptional quadric is non-zero, and this has the effect that the restriction of the cohomology class to every twistor line in either of these spaces is non-zero if there is a rational curve in the quadric on which the class is non-zero. Thus, when the conformal Green's function G_x of (X, g) is positive, the vector bundle E determined by $\lambda(\mathcal{P})$ has splitting type $\mathcal{O}(1) \oplus \mathcal{O}(1)$ on all the σ_0 -invariant rational curves in Z_0 which are limits of real twistor lines in Z_u as $u \rightarrow 0$. It therefore has the same splitting type on all the real twistor lines of Z_u for u small, and Proposition 5.4 therefore tells us:

THEOREM 6.4. *In Theorem 4.4, suppose that (Y, g) is an anti-self-dual manifold with $s > 0$. Then for all sufficiently small $u > 0$, the conformal class $[g_u]$ contains a metric of positive scalar curvature.*

In this positive case, it is interesting to re-examine the above construction in purely Riemannian terms. In this setting, the positivity of the Green's functions allows us to define a family of asymptotically flat, scalar-flat, anti-self-dual metrics $\tilde{g}_u = G_{x_u}^2 g_u$ on $(\tilde{X} \# \ell \overline{\mathbb{C}\mathbb{P}_2}) - \{pt\}$. What the above construction tells us is that these metrics converge, in the pointed Gromov-Hausdorff sense [29], to the orbifold metric $\tilde{g} = G_x^2 g$ on $X - x$. However, there is something else going on in certain regions, where viewing these metrics under higher and higher magnification results in a family that converges to the Eguchi-Hanson metric or to the Burns metric, meaning the Green's function rescaling of the Fubini-Study metric on $\overline{\mathbb{C}\mathbb{P}_2} - \{pt\}$. It is the appearance of the ideal sheaves in the definition of L^* which accounts for the fact that these seemingly incompatible pictures simultaneously apply at wildly different length-scales.

7. Conformally Flat Orbifolds

Consider the involution of $S^1 \times S^3 \subset \mathbb{C} \times \mathbb{H}$ given by $(z, q) \mapsto (\bar{z}, \bar{q})$. This involution has only four fixed points, namely $(z, q) = (\pm 1, \pm 1)$; and near each of these isolated fixed points, the involution necessarily looks exactly like reflection through the origin in \mathbb{R}^4 . We can therefore construct an involution of the connected sum $(S^1 \times S^3) \# (S^1 \times S^3)$ by cutting out a ball centered at a fixed point of the involution of each copy of $S^1 \times S^3$, and then being careful to carry out the usual gluing procedure in a \mathbb{Z}_2 -equivariant manner. The resulting involution

$$\phi : (S^1 \times S^3) \# (S^1 \times S^3) \rightarrow (S^1 \times S^3) \# (S^1 \times S^3)$$

then has exactly 6 fixed points, and may usefully be thought of as a 4-dimensional analog of the hyperelliptic involution



of a Riemann surface of genus 2.

In this section, we will be interested in conformally flat orbifold metrics on $X = [(S^1 \times S^3) \# (S^1 \times S^3)] / \mathbb{Z}_2$, or in other words, in ϕ -invariant, conformally flat metrics on $(S^1 \times S^3) \# (S^1 \times S^3)$. The key result we'll need is the following:

PROPOSITION 7.1. *There is a real-analytic family g_t , $t \in (0, 1)$, of Riemannian metrics on $(S^1 \times S^3) \# (S^1 \times S^3)$ with the following properties:*

- for each t , the metric g_t is locally conformally flat;
- for each t , the involution ϕ is an isometry of g_t ;
- for each t , the scalar curvature s of g_t has a fixed sign;
- when t is sufficiently close to 0, g_t has $s > 0$;
- when t is sufficiently close to 1, g_t has $s < 0$;
- the set of t for which $\ker(\Delta + s/6) \neq \{0\}$ is discrete; and
- there are only finitely many values of t for which g_t has $s \equiv 0$.

Consequently, there is a $t_0 \in (0, 1)$ and an $\varepsilon > 0$ such that, for all $t \in (t_0 - \varepsilon, t_0 + \varepsilon)$, the scalar curvature of g_t has the same sign as $t_0 - t$, and such that the Yamabe Laplacian $\Delta + s/6$ has trivial kernel for all $t \in (t_0 - \varepsilon, t_0) \cup (t_0, t_0 + \varepsilon)$.

Our proof of the existence of such a family hinges on a result of Schoen and Yau [55], and the construction used here is analogous to related constructions of Kim [39] and Nayatani [51]. Let us begin by observing that $(S^1 \times S^3) \# (S^1 \times S^3)$ can be obtained from S^4 by deleting four balls, and identifying the resulting boundary spheres in pairs via reflections. Now think of S^4 as $\mathbb{H}P^1 = \mathbb{H} \cup \{\infty\}$, and let $D_t \subset \mathbb{H} \cup \{\infty\}$ be the complement of the four open balls

$$B_t(\sqrt{3}), B_t(-\sqrt{3}), B_t(i), B_t(-i) \subset \mathbb{H}$$

of radius t ; and we henceforth stipulate that $t < 1$, so as to guarantee that the closures of these four balls are pairwise disjoint. We may then think of $(S^1 \times S^3) \# (S^1 \times S^3)$ as obtained from D_t by identifying $\partial B_t(i)$ with $\partial B_t(-i)$ via the reflection $q \mapsto \bar{q}$, and identifying $\partial B_t(\sqrt{3})$ with $\partial B_t(-\sqrt{3})$ via the reflection $q \mapsto -\bar{q}$:

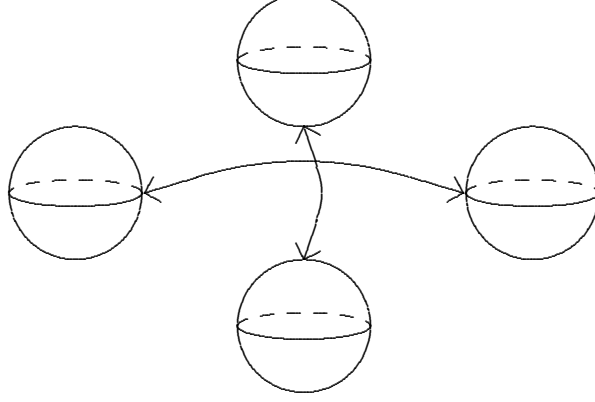

Since the reflections that we have used to identify the boundary components in pairs are just the restrictions to the relevant spheres of the global conformal transformations

$$q \mapsto t^2(q+i)^{-1} + i \text{ and } q \mapsto -t^2(q-\sqrt{3})^{-1} - \sqrt{3}$$

of $S^4 = \mathbb{H} \cup \{\infty\}$, we may therefore define a unique flat conformal metric $[g_t]$ on $(S^1 \times S^3) \# (S^1 \times S^3)$ by restricting the standard conformal metric on S^4 to D_t , and then pushing this structure down to D_t / \sim .

To complete the picture, we let ϕ act on D_t / \sim by $q \mapsto -q$. Note that we obviously have $\phi^*[g_t] = [g_t]$. The six fixed points of ϕ are just $i \pm t, \sqrt{3} \pm t, 0$ and ∞ . That this ϕ coincides with the previously-described involution of $(S^1 \times S^3) \# (S^1 \times S^3)$ may be seen, when $t \in (0, 1/3)$, by first decomposing $\mathbb{H} \cup \{\infty\}$ into the hemispheres $\|q\| \leq 4/3$ and $\|q\| \geq 4/3$. Thus ϕ can be constructed by first letting $q \mapsto -q$ act on two separate copies of S^4 minus *two* balls, each with its boundary components identified via reflections, and then forming the \mathbb{Z}_2 -equivariant connected sum of these manifolds; but each of these two building blocks looks like $S^3 \times ([-1, 1] / \{-1, 1\})$ equipped with the involution $(q, t) \mapsto (\bar{q}, -t)$, so the claim follows.

So far, we have only constructed a family $[g_t]$ of ϕ -invariant flat conformal classes, but we next need to worry about how nicely these conformal structures vary with t . However, it is not hard to see that they are real-analytic in t , since on a given open neighborhood U of a given $D_{t'} \subset S^4$, we are simply gluing together neighborhoods of the boundary spheres via the the Möbius transformations

$$q \mapsto t^2(q+i)^{-1} + i, \text{ and } q \mapsto -t^2(q-\sqrt{3})^{-1} - \sqrt{3}$$

for t near t' , and these transformations depend real-analytically on t . Since the sheaf of real-analytic functions is acyclic [30], we can now choose a real-analytic family of ϕ -invariant metrics h_t which represents the family of conformal classes $[g_t]$. Let λ_t be the smallest eigenvalue of the Yamabe Laplacian $\Delta_{h_t} + s_{h_t}/6$ of h_t , and let f_t be an eigenfunction of eigenvalue λ_t and integral 1. By the minimum principle [26], f_t is everywhere positive, and it follows that it must be unique; in particular, f_t must be ϕ -invariant. Moreover, this uniqueness tells us that λ_t has

multiplicity 1. Hence λ_t never meets another eigenvalue as t varies, so perturbation theory [38] tells us that λ_t and f_t depend real-analytically on t . Now set

$$g_t = f_t^2 h_t,$$

and notice that the scalar curvature

$$s_{g_t} = f_t^{-3}(6\Delta_{h_t} + s_{h_t})f_t = 6\lambda_t f_t^{-2}$$

of this metric has the same sign as λ_t at every point. Thus g_t is a real-analytic family of ϕ -invariant metrics representing the constructed conformal classes $[g_t]$, with the desirable property that the scalar curvature is of a fixed sign for each t .

But what is the sign of the scalar curvature? To answer this, first observe that, for each $t \in (0, 1)$, the universal cover of Y can naturally be realized as an open set of S^4 , namely the union Ω_t of all translates of D_t via elements of the group generated by the Möbius transformations $q \mapsto t^2(q+i)^{-1} + i$ and $q \mapsto -t^2(q-\sqrt{3})^{-1} - \sqrt{3}$ of $S^4 = \mathbb{H}\mathbb{P}_1$. In other words,

$$(S^1 \times S^3) \# (S^1 \times S^3) = \Omega_t / \mathbb{Z} * \mathbb{Z},$$

where Ω_t is the region of discontinuity of the Kleinian group

$$\mathbb{Z} * \mathbb{Z} \subset PSL(2, \mathbb{C}) \subset PGL(2, \mathbb{H})$$

generated by

$$\frac{1}{t} \begin{bmatrix} 1 & i - it^2 \\ -i & 1 \end{bmatrix} \text{ and } \frac{1}{t} \begin{bmatrix} \sqrt{3} & t^2 - 3 \\ -1 & \sqrt{3} \end{bmatrix} \in SL(2, \mathbb{C}).$$

These Kleinian groups are of the special type known as *Schottky groups* [50]. Henceforth, D_t is to be understood as a fundamental domain for the corresponding group action.

The complement $\Lambda_t = S^4 - \Omega_t$ of the region of discontinuity is called the *limit set* of the group action. If we think of S^4 as the boundary of the 5-disk, on whose interior $PGL(2, \mathbb{H}) = SO^\uparrow(5, 1)$ acts by isometries of the hyperbolic metric, then the limit set may also be characterized as the accumulation points of the orbit of any point in the open 5-ball. Since we have arranged for each of our subgroups of $PGL(2, \mathbb{H}) = SO^\uparrow(5, 1)$ to actually lie in $PSL(2, \mathbb{C}) = SO^\uparrow(3, 1)$, it follows that we have $\Lambda_t \subset \mathbb{C}\mathbb{P}_1 \subset \mathbb{H}\mathbb{P}_1$. This will later allow us to use planar diagrams to understand the structure of the limit set.

For our purposes, the ultimate utility of the Kleinian point of view stems from a remarkable result of Schoen and Yau [55] that relates the scalar curvature of a uniformized conformally flat manifold to the size of the corresponding limit set. The form of this result we will use is actually a slight refinement due to Nayatani [51]:

LEMMA 7.2 (Schoen-Yau, Nayatani). *Let $(M, [g])$ be a compact, locally conformally flat n -manifold, $n \geq 3$, which can be uniformized as*

$$M = \Omega / G,$$

where $G \subset SO^\uparrow(n+1, 1)$ is a Kleinian group and where $\Omega \subset S^n$ is the region of discontinuity of G . Let $g \in [g]$ be a metric on M in the fixed conformal class for

which the scalar curvature s does not change sign. Assume that the limit set Λ of G is infinite, and let $\dim(\Lambda) > 0$ denotes its Hausdorff dimension. Then

$$\begin{aligned} s > 0 &\iff \dim(\Lambda) < \frac{n}{2} - 1 \\ s = 0 &\iff \dim(\Lambda) = \frac{n}{2} - 1 \\ s < 0 &\iff \dim(\Lambda) > \frac{n}{2} - 1. \end{aligned}$$

The original argument given by Schoen and Yau is rather indirect, but Nayatani's proof actually constructs a particular metric for which the scalar curvature does not change sign; his conformal factor is obtained by convolving an appropriate power of the Euclidean distance with the Patterson-Sullivan measure of the limit set. Because this construction is so natural and canonical, it might seem tempting to simply use Nayatani's algorithm to define our family of metrics g_t . We have avoided doing so here, however, in order avoid the technical problem of proving that these metrics depend analytically on the parameter t .

To prove Proposition 7.1, we now proceed by showing that $\dim(\Lambda_t) < 1$ for t close to 0, and that $\dim(\Lambda_t) > 1$ for t close to 1.

Since the region of discontinuity Ω_t is the union of all translates of D_t , the limit set Λ_t may be thought of as the intersection of a nested sequence of balls in $\mathbb{R}^4 = \mathbb{H}$, where each of our original four balls contains the reflections of the other three, each of these in turn contains another three, and so forth. However, we have also observed that $\Lambda_t = \Lambda_t \cap \mathbb{C}$, so the limit set may instead be thought of as the generalized Cantor set in \mathbb{C} given by the intersection of a nested sequence of disks, where, in passing from one level to the next, each disk is replaced by three smaller ones. Now the two generators of our Schottky group both have derivatives satisfying

$$\left| \frac{d}{dz} \left(\pm \frac{t^2}{z-c} \pm c \right) \right| \leq t^2 \text{ whenever } |z-c| \geq 1.$$

Since the disks at the k^{th} level of the nesting are obtained by applying compositions of k generators to one of the original 4 disks, this implies that the the disks at the k^{th} level have Euclidean radius $< t^{2k}$. There are $4 \cdot 3^k$ of these,

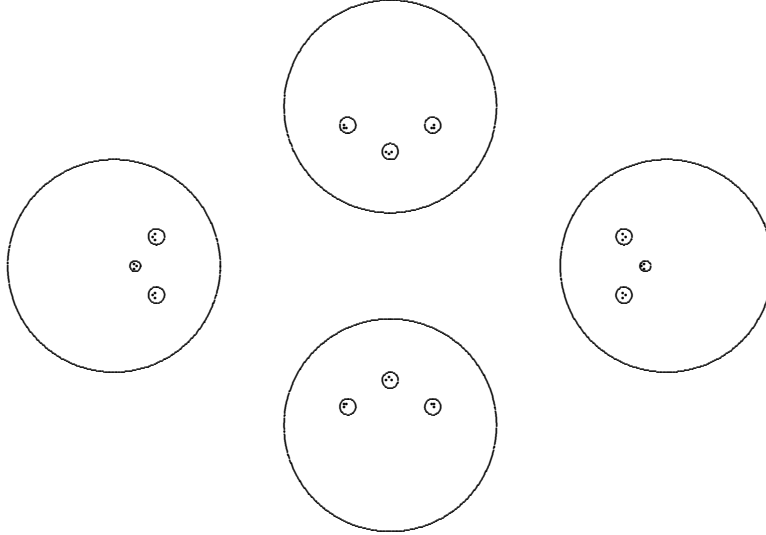

so the d -dimensional Hausdorff measure of Λ_t is less than a constant times $(3t^{2d})^k$ for all k , and vanishes if $\log 3 + 2d \log t < 0$. It therefore follows that

$$\dim(\Lambda_t) \leq -\frac{\log 3}{2 \log t}.$$

In particular, $\dim(\Lambda_t) < 1$ for all $t \in (0, 1/2]$, and for these values of t our ϕ -invariant conformally flat metrics g_t will have $s > 0$. The interested reader may enjoy the exercise of constructing explicit choices of g_t with $s > 0$ when t is extremely small, and comparing the results obtainable in this way with the predictions of the above limit-set argument.

Next, we need to show that $\dim(\Lambda_t) > 1$ when t is sufficiently close to 1. To see this, first consider the Kleinian group $G \subset PSL(2, \mathbb{C})$ generated by

$$\begin{bmatrix} 1 & 0 \\ -i & 1 \end{bmatrix} \text{ and } \begin{bmatrix} \sqrt{3} & -2 \\ -1 & \sqrt{3} \end{bmatrix} \in SL(2, \mathbb{C}).$$

which is the limiting case of our construction that arises by naïvely setting $t = 1$. We can still construct a fundamental domain D domain for this action as the complement of four balls, but certain pairs our four balls in \mathbb{H} will now have a boundary point in common. The corresponding system of nested disks in \mathbb{C} then contains two ‘bracelets’ of disks arranged around a pair of circles in the plane:

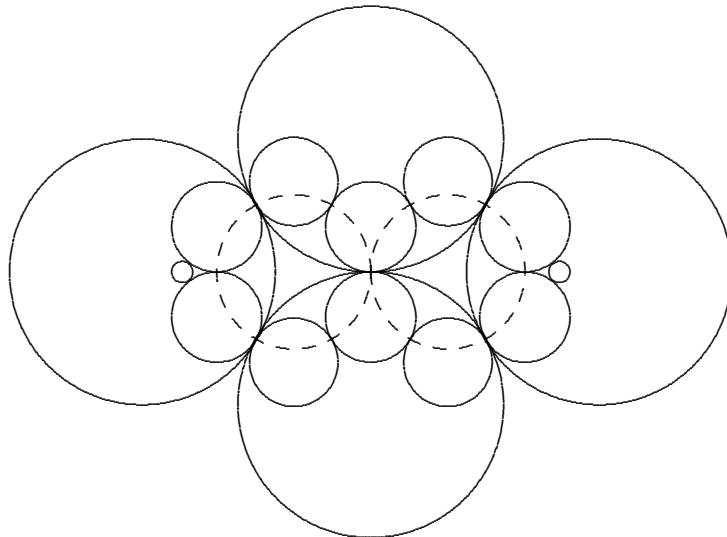

As one passes from one level of the nesting to the next, both of these circles continue to be completely covered by bracelets of smaller and smaller disks. Hence these two circles are both contained in the limit set of G . But, by a result of Bishop and Jones [12], this implies that the Hausdorff dimension of the corresponding limit set must be strictly greater than one:

LEMMA 7.3 (Bishop-Jones). *Let $G \subset PSL(2, \mathbb{C})$ be a finitely generated Kleinian group with infinite limit set $\Lambda \subset \mathbb{C}P_1$. If Λ is not totally disconnected, then either Λ is a single geometric circle, or else $\dim(\Lambda) > 1$.*

Now, to clinch the argument, we would like to somehow use this to estimate the Hausdorff dimension of Λ_t as $t \rightarrow 1$. A second general result of Bishop and Jones [12] provides the machinery needed to do this:

LEMMA 7.4 (Bishop-Jones). *Let $G \subset PSL(2, \mathbb{C})$ be a finitely generated Kleinian group, and suppose that G is the limit of subgroups $G_j \subset PSL(2, \mathbb{C})$, in the sense of convergence of a set of generators. If Λ is the limit set of G , and if Λ_j is the limit sets of G_j , then $\liminf \dim(\Lambda_j) \geq \dim(\Lambda)$.*

In our case, it follows that there is an $\epsilon > 0$ such that

$$\dim(\Lambda_t) > 1 \text{ whenever } t > 1 - \epsilon,$$

since otherwise there would exist a sequence $t_j \nearrow 1$ with $\dim(\Lambda_{t_j}) \leq 1$, and hence with $\liminf \dim(\Lambda_{t_j}) \leq 1 < \dim(\Lambda)$, in contradiction to the lemma. For $t \in (1 - \epsilon, 1)$, the corresponding ϕ -invariant conformally flat metrics g_t therefore have $s < 0$.

To wrap up our proof of Proposition 7.1, it just remains to show that

$$(10) \quad B = \left\{ t \in (0, 1) \mid g_t \text{ has } \ker(\Delta + \frac{s}{6}) \neq 0 \right\},$$

is a discrete set, so that the subset $A \subset B \cap [\frac{1}{2}, 1 - \epsilon]$ defined by

$$(11) \quad A = \left\{ t \in (0, 1) \mid g_t \text{ has } s \equiv 0 \right\}$$

is consequently finite. In principle this could again be done by appealing to the perturbation theory of the spectrum of the Yamabe Laplacian, but, just for fun, let us give a twistorial proof, in the spirit of §5. Indeed, the Penrose transform tells us that we can re-express (10) as

$$B = \left\{ t \in (0, 1) \mid H^1(Z_t, \mathcal{O}(K^{1/2})) \neq 0 \right\},$$

where Z_t is the twistor space of (Y, g_t) . However, Z_t is constructed by taking an open set in $\mathbb{C}P_3$ (namely the the inverse image of some open neighborhood of $D_t \subset \mathbb{H}P_1$ via the twistor projection) and making identifications using the two bi-holomorphisms given by the $PSL(4, \mathbb{C})$ -transformations arising from the generators of our Schottky group $\mathbb{Z} * \mathbb{Z}$ via the inclusions

$$PSL(2, \mathbb{C}) \hookrightarrow PGL(2, \mathbb{H}) \hookrightarrow PSL(4, \mathbb{C}).$$

But our generators depend algebraically on t , so we may extend our construction of the Z_t to t in an open neighborhood \mathcal{U} of $(0, 1) \subset \mathbb{C}$, giving us an analytic family of complex 3-folds. The semi-continuity principle [6] then implies that the set of $t \in \mathcal{U}$ for which $H^1(Z_t, \mathcal{O}(K^{1/2})) \neq 0$ is closed in the analytic Zariski topology; in other words, it is either discrete, or else is all of \mathcal{U} . Since $\Delta + \frac{s}{6}$ is a positive operator for t small, this shows that the set B defined by (10) is discrete. The compact set $A \subset B$ defined by (11) is thus finite, as claimed.

It follows that the element of A defined by

$$t_0 = \sup\{t \in (0, 1) \mid g_t \text{ has } s > 0\}$$

has a neighborhood $(t_0 - \epsilon, t_0 + \epsilon) \subset (0, 1)$ which does not meet $A - \{t_0\}$. For t in this neighborhood, the scalar curvature s of g_t then has the same sign as $t_0 - t$, and our proof of Proposition 7.1 is therefore done.

8. A Vanishing Theorem

At this point, we have constructed an interesting family of locally conformally flat metrics on the orbifold $X = Y/\mathbb{Z}_2$, where $Y = 2(S^1 \times S^3)$. However, our aim is to eventually smooth the orbifold singularities of these metrics in order to produce a similar family of anti-self-dual metrics on a simply connected manifold. To carry this out, we will need to know that the Kodaira-Spencer deformation theory is unobstructed for the corresponding family of twistor spaces. In fact, the relevant vanishing theorem easily follows from a decade-old unpublished paper of Eastwood and Singer [18], whose beautiful ideas will be given a self-contained exposition in this section.

Let (Y, g) be an oriented, locally conformally flat Riemannian 4-manifold, and let \mathcal{C} denote the complete presheaf of *conformal Killing fields* on (Y, g) , defined by setting

$$\mathcal{C}_U = \{v \in \mathcal{E}_U(TY) \mid \mathcal{L}_v g \propto g\}$$

for any open set $U \subset Y$; here, as throughout, \mathcal{E} is used to indicate the C^∞ sections of a given vector bundle. Now observe that there is a rank-15 vector bundle $F \rightarrow Y$, equipped with a flat connection ∇ , such that \mathcal{C} is the sheaf of parallel sections of (F, ∇) . Indeed, if $U \subset Y$ is any *simply connected* open set, then we can conformally immerse U onto an open subset of S^4 by means of the *developing map* [41], and \mathcal{C}_U is thereby identified with the 15-dimensional space $\mathfrak{so}(5, 1)$ of global conformal Killing fields on the round 4-sphere S^4 . As we pass from one such choice of U to another, these identifications will be related to one another by elements of $SO^\uparrow(5, 1)$, acting on $\mathfrak{so}(5, 1)$ via the adjoint representation. These elements of $SO^\uparrow(5, 1)$ are exactly the transition of functions of F , relative to a collection of local trivializations of F in which the flat connection ∇ has vanishing connection 1-forms.

Now we could certainly construct a fine resolution of \mathcal{C} by just considering the F -valued differential forms on Y , but this would involve using vector bundles of rather high rank. A more efficient resolution was first discovered by Gasqui and Goldschmidt [24] using Spencer cohomology, and later rediscovered by Eastwood and Rice [17] in the setting of Bernstein-Gelfand-Gelfand resolutions. This resolution takes the form

$$0 \rightarrow \mathcal{C} \rightarrow \mathcal{E}(TY) \xrightarrow{L_0} \mathcal{E}(\odot_0^2 \Lambda^1) \xrightarrow{L_1} \mathcal{E} \left(\begin{array}{c} \odot_0^2 \Lambda^+ \\ \oplus \\ \odot_0^2 \Lambda^- \end{array} \right) \xrightarrow{L_2} \mathcal{E}(\odot_0^2 \Lambda^1) \xrightarrow{L_3} \mathcal{E}(TY) \rightarrow 0$$

where \odot_0^2 indicates the trace-free symmetric-tensor-product of a vector bundle with itself. Here L_0 is the first-order operator

$$L_0(v) = \text{trace-free part of } \mathcal{L}_v g$$

which measures the way the conformal class $[g]$ is distorted by the the flow of a given vector field. The next step in the sequence is the linearization $L_1 = DW$ of the Weyl curvature tensor; and for our purposes, it will be important to recognize this second-order differential operator can be decomposed as $DW = DW_+ + DW_-$, where the operators

$$\begin{aligned} DW_+ &: \mathcal{E}(\odot_0^2 \Lambda^1) \rightarrow \mathcal{E}(\odot_0^2 \Lambda^+) \\ DW_- &: \mathcal{E}(\odot_0^2 \Lambda^1) \rightarrow \mathcal{E}(\odot_0^2 \Lambda^-) \end{aligned}$$

are the linearizations

$$DW_{\pm}(h) = \frac{d}{dt} W_{\pm}(g + th) \Big|_{t=0}$$

of the self-dual and anti-self-dual Weyl curvatures. The next step is again a second-order operator, and is given by

$$L_2 = (DW_+)^* - (DW_-)^*.$$

The sequence then culminates with the first-order operator

$$L_3 = L_0^*.$$

Clearly, all of these operators are conformally invariant, provided that each bundle in the complex is given the correct conformal weight.

Since each of the sheaves in the Gasqui-Goldschmidt resolution is fine, and hence acyclic, the abstract de Rham theorem [58] immediately tells us that the sheaf cohomology of Y with coefficients in \mathcal{C} is exactly the cohomology of the corresponding complex of global sections:

$$H^p(Y, \mathcal{C}) = \frac{\ker L_p}{\operatorname{im} L_{p-1}}.$$

However, the Gasqui-Goldschmidt resolution is also an elliptic complex; thus, provided Y is compact, we have [25]

$$H^p(Y, \mathcal{C}) = \ker L_p \cap \ker L_{p-1}^*,$$

by a generalized form of the Hodge theorem. Since

$$DW_{\pm} = \frac{1}{2}(L_1^* \pm L_2),$$

this immediately gives us the following result:

PROPOSITION 8.1. *Let (Y, g) be any compact, oriented, locally conformally flat 4-manifold. Then*

$$\begin{aligned} H^2(Y, \mathcal{C}) &= \ker(DW_+)^* \oplus \ker(DW_-)^* \\ &\subset \mathcal{E}_Y(\odot_0^2 \Lambda^+) \oplus \mathcal{E}_Y(\odot_0^2 \Lambda^+). \end{aligned}$$

Using this key observation, it is now easy to deduce the desired vanishing result:

THEOREM 8.2 (Eastwood-Singer). *Let g be any conformally flat metric on the oriented 4-manifold*

$$Y = k(S^1 \times S^3) = \underbrace{(S^1 \times S^3) \# \cdots \# (S^1 \times S^3)}_k,$$

$k \geq 1$, and let Z be the twistor space of (Y, g) . Then

$$DW_+ : \mathcal{E}(\odot_0^2 \Lambda^1) \rightarrow \mathcal{E}(\odot_0^2 \Lambda^+)$$

is surjective on (Y, g) , and

$$H^2(Z, \mathcal{O}(TZ)) = 0.$$

PROOF. By Serre duality, $H^2(Z, \mathcal{O}(TZ))$ is the dual of $H^1(Z, \Omega^1(K))$. However, the latter sheaf cohomology group corresponds, via the Penrose transform [5], to $\mathbb{C} \otimes \ker(DW_+)^*$. By Proposition 8.1, it therefore suffices to show that $H^2(Y, \mathcal{C}) = 0$, where \mathcal{C} is once again the sheaf of local conformal Killing fields of $[g]$.

Now Y can be obtained from S^4 by replacing k pairs of balls with k tubes modeled on $S^3 \times \mathbb{R}$. This allows us to express Y as the union

$$Y = U \cup V$$

of open sets

$$U = S^4 - \{p_1, \dots, p_{2k}\}$$

and

$$V \approx \underbrace{(S^3 \times \mathbb{R}) \sqcup \dots \sqcup (S^3 \times \mathbb{R})}_k$$

such that

$$U \cap V \approx \underbrace{(S^3 \times \mathbb{R}) \sqcup \dots \sqcup (S^3 \times \mathbb{R})}_{2k}.$$

We may thus proceed by examining the Mayer-Vietoris sequence

$$(12) \quad \rightarrow H^1(U \cap V, \mathcal{C}) \rightarrow H^2(U \cup V, \mathcal{C}) \rightarrow H^2(U, \mathcal{C}) \oplus H^2(V, \mathcal{C}) \rightarrow \dots$$

Indeed, notice that V and $U \cap V$ are homotopy equivalent to disjoint unions of 3-spheres, while U is homotopy equivalent to a bouquet of 3-spheres. In particular, each of these sets is a disjoint union of simply connected spaces. Since \mathcal{C} is the sheaf of covariantly constant sections of a flat rank-15 vector bundle (F, ∇) , the restriction of \mathcal{C} to any of these open sets may be identified with the constant sheaf \mathbb{R}^{15} , and the relevant sheaf cohomology therefore amounts to singular cohomology with coefficients in the Abelian group \mathbb{R}^{15} . By the homotopy invariance of singular cohomology, we thus have

$$\begin{aligned} H^1(U \cap V, \mathcal{C}) &\cong H^1(\underbrace{S^3 \sqcup \dots \sqcup S^3}_{2k}, \mathbb{R}^{15}) = 0 \\ H^2(U, \mathcal{C}) &\cong H^2(\underbrace{S^3 \vee \dots \vee S^3}_{2k-1}, \mathbb{R}^{15}) = 0 \\ H^2(V, \mathcal{C}) &\cong H^2(\underbrace{S^3 \sqcup \dots \sqcup S^3}_k, \mathbb{R}^{15}) = 0, \end{aligned}$$

and (12) therefore tells us that

$$H^2(Y, \mathcal{C}) = H^2(U \cup V, \mathcal{C}) = 0,$$

as claimed. \square

It is perhaps worth remarking that, for *any* compact oriented locally conformally flat 4-manifold (Y, g) , one may use the index theorem to show that $\ker(DW_+)^*$ and $\ker(DW_-)^*$ have the same dimension. Proposition 8.1 and the Penrose transform therefore imply that

$$\dim_{\mathbb{R}} H^2(Y, \mathcal{C}) = 2 \dim_{\mathbb{C}} H^2(Z, \mathcal{O}(TZ)).$$

Thus the vanishing of $H^2(Y, \mathcal{C})$ is actually necessary, as well as sufficient, for the deformation theory of Z to be unobstructed.

9. Existence Results

We will now assemble the results of the last several sections into a proof of Theorem A.

PROPOSITION 9.1. *For any integer $k \geq 6$, the connected sum*

$$k\overline{\mathbb{C}\mathbb{P}}_2 = \underbrace{\overline{\mathbb{C}\mathbb{P}}_2 \# \cdots \# \overline{\mathbb{C}\mathbb{P}}_2}_k$$

admits a real-analytic 1-parameter family of anti-self-dual conformal metrics $[g_t]$, $t \in [a, b]$, such that $[g_a]$ contains a metric with $s > 0$ everywhere, while $[g_b]$ contains a metric with $s < 0$ everywhere.

PROOF. We once again let $Y = (S^1 \times S^3) \# (S^1 \times S^3)$, and let $X = Y/\mathbb{Z}_2$. Equip X with a conformally-flat scalar-flat orbifold metric g_0 which belongs to a real-analytic 1-parameter family of conformally flat metrics g_t , $t \in (-\varepsilon, \varepsilon)$ such that each g_t has $s > 0$ when $t < 0$, $s < 0$ when $t > 0$, and $\ker(\Delta + s/6) = 0$ for all $t \neq 0$; for example, Proposition 7.1 constructs such a family, after replacing t with $t - t_0$ for some t_0 . Since Theorem 8.2 guarantees that the twistor space Z of (Y, g_0) has $H^2(Z, \mathcal{O}(TZ)) = 0$, Theorem 4.5 therefore tells us that, for any integer $\ell \geq 0$, there exists a connected 2-parameter family of anti-self-dual conformal metrics $[g_{(\mathbf{u}_1, \mathbf{u}_2)}]$, $(\mathbf{u}_1, \mathbf{u}_2) \in (0, \epsilon) \times (-\epsilon, \epsilon)$ on $\tilde{X} \# \ell \overline{\mathbb{C}\mathbb{P}}_2$ which arises from a 2-parameter standard deformation of the singular space $Z_0 = [\tilde{Z}/\mathbb{Z}_2] \cup \tilde{Z}_{EH} \cup \tilde{Z}_{FS}$; here \tilde{X} is once again the oriented 4-manifold obtained from the orbifold X by replacing each singular point of X with a 2-sphere of self-intersection -2 . Moreover this 2-parameter standard deformation can be chosen so that its restriction to $\mathbf{u}_2 = t$ is a 1-parameter standard deformation of the complex 3-fold with normal crossings arising from $(X, [g_t])$, for every real number t in a neighborhood of 0. Let $a < 0$ and $b > 0$ be choices of t in this neighborhood. Theorems 6.3 and 6.4 then tell us that for any sufficiently small $w > 0$, the conformal class $[g_{(w, a)}]$ contains a metric with $s > 0$, while the conformal class $[g_{(w, b)}]$ contains a metric with $s < 0$. Thus $[g_t] := [g_{(w, t)}]$, $a \leq t \leq b$, is a family of ASD conformal metrics on $\tilde{X} \# \ell \overline{\mathbb{C}\mathbb{P}}_2$ with the desired scalar-curvature behavior .

It remains only to unmask the identity of the manifold $\tilde{X} \# \ell \overline{\mathbb{C}\mathbb{P}}_2$. To do this, first notice we may cut up Y into three punctured 4-spheres



in a manner which is compatible with the involution. Thus X can be expressed as a connected sum

$$X = V \# V \# V$$

of three copies of the orbifold S^4/\mathbb{Z}_2 , where the connect sum is carried out in the vicinity of *non-singular* points of V , and where the \mathbb{Z}_2 acts on $S^4 \subset \mathbb{R}^5$ by reflection through an axis. Hence

$$\tilde{X} = \tilde{V} \# \tilde{V} \# \tilde{V},$$

where \tilde{V} is obtained from V by replacing the two isolated singularities of $V = S^4/\mathbb{Z}_2$ by 2-spheres of self-intersection -2 . However, $\overline{\mathbb{C}\mathbb{P}_2\#\mathbb{C}\mathbb{P}_2}$ is diffeomorphic to \tilde{V} . Indeed, if E_1 and E_2 are the standard 2-spheres of self-intersection -1 in $\overline{\mathbb{C}\mathbb{P}_2\#\mathbb{C}\mathbb{P}_2}$, then $E_1 + E_2$ and $E_1 - E_2$ are represented by disjoint embedded 2-spheres of self-intersection -2 , and $\overline{\mathbb{C}\mathbb{P}_2\#\mathbb{C}\mathbb{P}_2}$ is obtained by gluing tubular neighborhoods of these two 2-spheres along their boundaries. We therefore have $X \approx 6\overline{\mathbb{C}\mathbb{P}_2}$, and hence $M \approx k\overline{\mathbb{C}\mathbb{P}_2}$, where $k = 6 + \ell$. \square

As a corollary, we now obtain one of the central results of this paper:

THEOREM 9.2. *For any integer $k \geq 6$, the connected sum $k\overline{\mathbb{C}\mathbb{P}_2}$ admits scalar-flat anti-self-dual metrics.*

PROOF. Consider the smooth family of conformal classes $[g_t]$ constructed in Proposition 9.1, and let $h_t \in [g_t]$ be any smooth family of metrics representing these conformal classes. Let λ_t denote the smallest eigenvalue of the Yamabe Laplacian $(\Delta + s/6)$ for the metric h_t . Then λ_t is a continuous function of t . But Proposition 9.1 tells us that $\lambda_a > 0$, whereas $\lambda_b < 0$. By continuity, there is thus some $c \in [a, b]$ for which $\lambda_c = 0$. Let u be a unit-integral eigenfunction of the Yamabe Laplacian $(\Delta + s/6)$ of h_c with eigenvalue $\lambda_c = 0$. By the minimum principle, u is a positive function. Thus $g = u^2 h_c$ is a scalar-flat anti-self-dual metric on $k\overline{\mathbb{C}\mathbb{P}_2}$ for the given value of $k \geq 6$. \square

Now this by no means represents the first construction ever of SFASD metrics on simply connected compact 4-manifolds. However, all the previous results depended on an essentially different idea: namely, that any Kähler metric on a complex surface with $s \equiv 0$ is SFASD. Through this observation, Yau's existence theorem for Ricci-flat Kähler metrics on K3 surfaces [60] provided a crucial early family of examples which largely drove the subsequent development of the entire subject. Much later, the present author and his collaborators showed [40] that $\mathbb{C}\mathbb{P}_2\#k\overline{\mathbb{C}\mathbb{P}_2}$ admits scalar-flat anti-self-dual metrics if $k \geq 14$. The proof of this last result depends on a refinement of Theorem 4.4, set up so that the constructed twistor spaces carries a special divisor whose existence implies that the ASD conformal class contains a Kähler metric. For a related re-proof of the existence of Calabi-Yau metrics on K3, see [48].

Putting these previous results together with Corollary 9.2, we have thus proved Theorem A:

THEOREM 9.3. *The following smooth 4-manifolds admit scalar-flat anti-self-dual metrics:*

- (i) $k\overline{\mathbb{C}\mathbb{P}_2}$, for every $k \geq 6$;
- (ii) $\mathbb{C}\mathbb{P}_2\#k\overline{\mathbb{C}\mathbb{P}_2}$, for every $k \geq 14$; and
- (iii) K3.

In particular, each of these simply connected compact 4-manifolds admits optimal metrics; and any optimal metric on any one of them is SFASD.

10. Non-Existence Results

We have now seen that many simply connected 4-manifolds admit non-Einstein optimal metrics. However, related ideas will now allow us to show there are also many simply connected 4-manifolds which do *not* admit optimal metrics. To see this, we begin by introducing a new concept:

DEFINITION 10.1. *Let M be a smooth compact oriented 4-dimensional manifold (respectively, orbifold). We will say that M admits an anorexic sequence if there is a sequence g_j of smooth Riemannian metrics (respectively, orbifold metrics) on M for which $\int s^2 d\mu \rightarrow 0$ and $\int |W_+|^2 d\mu \rightarrow 0$.*

When a manifold admits such a sequence, we then know the value of $\mathcal{I}_{\mathcal{R}}(M)$, and stand a very good chance of determining whether it admits an optimal metric:

LEMMA 10.2. *Let M be a smooth compact oriented 4-manifold which admits an anorexic sequence. Then any optimal metric on M is SFASD. Moreover,*

$$\mathcal{I}_{\mathcal{R}}(M) = -8\pi^2(\chi + 3\tau)(M).$$

PROOF. Recall that equation (8) tells us that

$$\mathcal{K}(g) = -8\pi^2(\chi + 3\tau)(M) + 2 \int_M \left(\frac{s^2}{24} + 2|W_+|^2 \right) d\mu_g .$$

If there is an anorexic sequence, the infimum of the right-hand side is thus obtained by dropping the curvature integral. Moreover, a metric minimizing \mathcal{K} would necessarily have $s \equiv 0$ and $W_+ \equiv 0$. \square

Now imagine a curvaceous young 4-manifold who, bedazzled by the glamorous starlets with optimal metrics she has been reading about in the tabloids, suddenly decides to go on a starvation diet to get rid of all that unwanted curvature. If she has the wrong body type, this misguided procedure will be dangerous to her health, and she will merely succeed in putting herself in the hospital:

PROPOSITION 10.3. *Let M be a smooth compact oriented 4-manifold which admits an anorexic sequence. Then M does not admit an optimal metric if*

- $b_+(M) \geq 4$; or
- $b_+(M) = 2$; or
- $b_+(M) = 3$, $\pi_1(M) = 0$, and M is not diffeomorphic to $K3$; or
- $b_+(M) = 1$, $\pi_1(M) = 0$, and M is not diffeomorphic to $\mathbb{C}\mathbb{P}_2 \# k\overline{\mathbb{C}\mathbb{P}_2}$ for some $k \geq 10$.

PROOF. By Lemma 10.2, an optimal metric on such an M would necessarily be SFASD. However, Propositions 3.4 and 3.5 show that we would then obtain a contradiction in any of the scenarios considered above. \square

Now we come to our main method of construction [46]:

LEMMA 10.4. *Let X be an oriented compact 4-dimensional orbifold with only isolated singularities modeled on $\mathbb{R}^4/\mathbb{Z}_2$. Let \tilde{X} be the smooth oriented 4-manifold obtained by replacing each singular point by a 2-sphere of self-intersection -2 . If X admits an anorexic sequence, then so does \tilde{X} . Moreover, if there is an anorexic sequence on X with the property that $\int |r|^2 d\mu \rightarrow 0$, then \tilde{X} also admits an anorexic sequence with this property.*

PROOF. If h is an orbifold metric on X with $\int s^2 d\mu < \varepsilon$ and $\int |W_+|^2 d\mu < \varepsilon$, we will show that \tilde{X} has a metric g with $\int s^2 d\mu < 2\varepsilon$ and $\int |W_+|^2 d\mu < 2\varepsilon$. Moreover, if h also has $\int |\hat{r}|^2 d\mu < \varepsilon$, then we will be able to arrange for g to also satisfy $\int |\hat{r}|^2 d\mu < 2\varepsilon$.

To do this, we choose geodesic normal coordinates around a given orbifold point, so that we have

$$h = \left[\sum_j (dx^j)^2 \right] + \alpha$$

in these coordinates, where α is a (\mathbb{Z}_2 -invariant) smooth symmetric tensor field on a neighborhood of the origin in \mathbb{R}^4 with $|\alpha| < C|\bar{x}|^2$. We would like to delete a ball of small radius ρ around the origin, and glue in a copy of the Eguchi-Hanson metric on T^*S^2 , with very small length scale. Recall that the restriction of the Eguchi-Hanson metric to the complement of the zero section in T^*S^2 is isometric to the metric

$$g_{EH,\epsilon} = \frac{d\varrho^2}{1 - \left(\frac{\epsilon}{\varrho}\right)^4} + \varrho^2 \left(\sigma_1^2 + \sigma_2^2 + \left[1 - \left(\frac{\epsilon}{\varrho}\right)^4 \right] \sigma_3^2 \right)$$

on $(\epsilon, \infty) \times S^3/\mathbb{Z}_2$, where $\{\sigma_j\}$ is the standard left-invariant co-frame on $S^3/\mathbb{Z}_2 = SO(3)$; the constant $\epsilon > 0$ is herein referred to as the *length scale*. Now, for any fixed $\rho > 0$, this family of metrics converges uniformly in the C^2 topology to the Euclidean metric on the annulus $\varrho \in [\rho/2, \rho]$ as $\epsilon \rightarrow 0$. If $\varphi : (0, \infty) \rightarrow [0, 1]$ is a bump function which is $\equiv 0$ on $(0, 1/2]$ and $\equiv 1$ on $[1, \infty)$, then, for any fixed ρ , the metrics

$$g_{\epsilon,\rho} = \varphi\left(\frac{\varrho}{\rho}\right) h + \left[1 - \varphi\left(\frac{\varrho}{\rho}\right) \right] g_{EH,\epsilon}$$

therefore converge in the C^2 norm to

$$g_{0,\rho} = \left[\sum_j (dx^j)^2 \right] + \varphi\left(\frac{\varrho}{\rho}\right) \alpha$$

on the annulus $\varrho \in [\rho/2, \rho]$, and in particular the curvature tensors of these metrics converge uniformly in the annulus to the curvature of $g_{0,\rho}$. On the other hand, since α is of magnitude $O(\varrho^2)$, the first and second coordinate partial derivatives of $g_{0,\rho}$ are uniformly bounded as $\rho \rightarrow 0$. Thus we can choose a sequence of $(\epsilon_j, \rho_j) \rightarrow (0, 0)$ such that the sectional curvatures of the metrics $g_j = g_{\epsilon_j, \rho_j}$ are uniformly bounded on the transition annuli $\varrho \in [\rho_j/2, \rho_j]$, while the volumes of these annuli simultaneously tend to zero. For j far out in the sequence, the transition annulus therefore makes a contribution to $\int s^2 d\mu$, $\int |\hat{r}|^2 d\mu$, or $\int |W_+|^2 d\mu$ which is as small as we like — for example, smaller than the given ε divided by the number of orbifold singularities of X . We now take g to be given by such a choice of g_j in each glued region, h on the complement X minus a collection of balls of radius ρ_j about its orbifold singularities, and equal to the Eguchi-Hanson metric with length scale ϵ_j near the added 2-spheres. Since the Eguchi-Hanson metric has $r \equiv 0$ and $W_+ \equiv 0$, the only possible source of increase of $\int s^2 d\mu$, $\int |\hat{r}|^2 d\mu$, or $\int |W_+|^2 d\mu$ comes from the transition annuli, which already have under control, and so we have succeeded in producing a metric g on \tilde{X} with all the claimed properties. \square

Here is a simple application of this Lemma:

LEMMA 10.5. *The 4-manifold $4\overline{\mathbb{C}\mathbb{P}}_2$ admits an anorexic sequence.*

PROOF. Consider the involution of $S^3 \times S^1 \subset \mathbb{H} \times \mathbb{C}$ given by $(q, z) \mapsto (\bar{q}, \bar{z})$. Now equip $S^3 \times S^1$ with the product of the unit-sphere metric on S^3 and the radius- ϵ metric on S^1 . These metrics descend to orbifold metrics on $(S^3 \times S^1)/\mathbb{Z}_2$ with

bounded sectional curvature, but with arbitrarily small volume; thus we obtain an anorexic sequence of such metrics by taking any sequence $\epsilon_j \rightarrow 0$. The 4-manifold \tilde{X} obtained from X by replacing its orbifold singularities with 2-spheres of self-intersection -2 therefore also admits anorexic sequences by Lemma 10.4. But $X = V \# V$, where $V = S^4/\mathbb{Z}_2$, and so $\tilde{X} = \tilde{V} \# \tilde{V}$. However, as we already noted in the proof of Proposition 9.1, $\tilde{V} = 2\overline{\mathbb{C}\mathbb{P}_2}$, and so $\tilde{X} = 4\overline{\mathbb{C}\mathbb{P}_2}$. \square

We thus obtain our first non-existence result:

PROPOSITION 10.6. *The 4-manifold $4\overline{\mathbb{C}\mathbb{P}_2}$ does not admit optimal metrics.*

PROOF. By Lemmata 10.2 and 10.5, an optimal metric on $4\overline{\mathbb{C}\mathbb{P}_2}$ would have to be SFASD. However, $(2\chi + 3\tau)(4\overline{\mathbb{C}\mathbb{P}_2}) = 0$, so Proposition 3.3 would imply that any SFASD metric on the simply connected 4-manifold $4\overline{\mathbb{C}\mathbb{P}_2}$ would be hyper-Kähler. But such a metric would entail the existence of non-trivial self-dual harmonic 2-forms, which is excluded here, since $b_+(4\overline{\mathbb{C}\mathbb{P}_2}) = 0$. \square

A rather more important application of 10.4 is the following:

LEMMA 10.7. *The 4-manifold $\mathbb{C}\mathbb{P}_2 \# 9\overline{\mathbb{C}\mathbb{P}_2}$ admits an anorexic sequence.*

PROOF. Consider the involution of $S^2 \times T^2$ which is obtained as the product of a 180° rotation of S^2 around an axis and the Weierstrass involution of an elliptic curve:

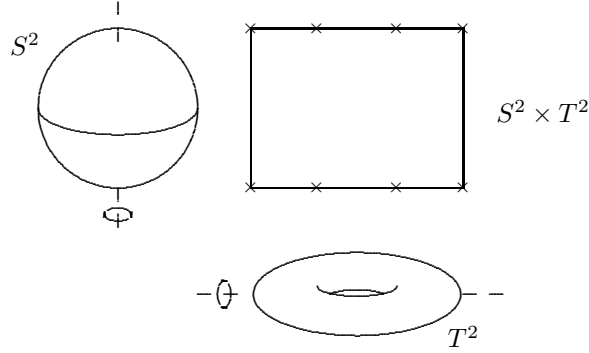

This involution has exactly 8 fixed points. Let \tilde{X} be the manifold which desingularizes the orbifold $X = [S^2 \times T^2]/\mathbb{Z}_2$ by replacing each of the resulting eight singular points with an S^2 of self-intersection -2 .

Now it is easy to see that $S^2 \times T^2$ admits sequences of metrics with bounded sectional curvature, but with volume tending to zero: namely, equip T^2 with a sequence of flat metrics of smaller and smaller area, and take the Riemannian product of these metrics with the standard round metric on S^2 . Moreover, the metrics given by this explicit recipe are all \mathbb{Z}_2 -invariant, and so give rise to a sequence of orbifold metrics on $[S^2 \times T^2]/\mathbb{Z}_2$ with bounded sectional curvature for which the total volume tends to zero. Such a sequence is anorexic, and also has the special property that $\int |r|^2 d\mu \rightarrow 0$. By Lemma 10.4, \tilde{X} therefore also admits such a special anorexic sequence.

It only remains to show that \tilde{X} is diffeomorphic to $\mathbb{C}P_2 \# 9\overline{\mathbb{C}P}_2$. To see this, think of $S^2 \times T^2$ as $\mathbb{C}P_1 \times E$, where E is an elliptic curve. Then \tilde{X} becomes a complex surface which has a branched double cover biholomorphic to $\mathbb{C}P_1 \times E$ blown up at eight points. This complex surface is simply connected, and it has Kodaira dimension $-\infty$ because it contains a $\mathbb{C}P_1$ with trivial normal bundle. By the Enriques-Kodaira classification [7], any such complex surface is rational, and hence must be diffeomorphic to either $S^2 \times S^2$ or a connected sum $\mathbb{C}P_2 \# k\overline{\mathbb{C}P}_2$. However,

$$(2\chi + 3\tau)(\tilde{X}) = \frac{1}{4\pi^2} \int \left(\frac{s^2}{24} + 2|W_+|^2 - \frac{|\hat{r}|^2}{2} \right) d\mu$$

must vanish, since the right-hand side will certainly tend to zero for our special anorexic sequence. Since

$$\begin{aligned} (2\chi + 3\tau)(S^2 \times S^2) &= 8 \\ (2\chi + 3\tau)(\mathbb{C}P_2 \# k\overline{\mathbb{C}P}_2) &= 9 - k, \end{aligned}$$

it thus follows that \tilde{X} must be diffeomorphic to $\mathbb{C}P_2 \# 9\overline{\mathbb{C}P}_2$. □

In fact, one does not need to appeal to any classification machinery to check that $\tilde{X} \approx \mathbb{C}P_2 \# 9\overline{\mathbb{C}P}_2$. Working with one's bare hands [46], it is not difficult to show that, with the fixed complex structure used above, \tilde{X} is precisely the complex surface obtained by iteratively blowing up $\mathbb{C}P_2$ at a configuration of points arranged as in the following diagram, in which a pair of adjacent points on a line means that one is to blow up the first point, and then blow up the resulting exceptional divisor at the point corresponding to the direction of the line, while the adjacent triple of points on a line has an analogous interpretation:

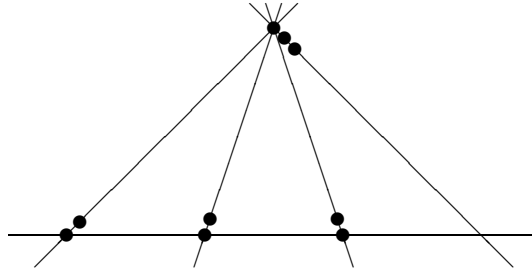

If we think of the right-hand line as the line at infinity, the horizontal line as the x -axis, and the three other lines as $x = 0$, $x = 1$ and $x = t$, then the elliptic curves $y^2 = Ax(x - 1)(x - t)$ foliate an open dense set of the blow-up, and arise from the E factor of $[\mathbb{C}P_1 \times E]/\mathbb{Z}_2$.

COROLLARY 10.8. *The simply connected 4-manifold $\mathbb{C}P_2 \# 9\overline{\mathbb{C}P}_2$ does not admit optimal metrics.*

PROOF. Lemma 10.7 allows us to apply the last clause of Proposition 10.3. □

To build more complicated examples, first consider the *wormhole space* obtained by equipping $\mathbb{R}^4 - \{0\}$ with the metric

$$g_{wh} = \left(1 + \frac{\epsilon}{|\vec{x}|^2} \right)^2 \sum_j (dx^j)^2.$$

Because $1 + \epsilon/|\bar{x}|^2$ is a harmonic function, this conformally flat metric is scalar-flat. However, rewriting this metric in polar coordinates as

$$g_{wh} = \left(\varrho + \frac{\epsilon}{\varrho} \right)^2 \left[\frac{d\varrho^2}{\varrho^2} + h_{S^3} \right],$$

where h_{S^3} is the standard metric on the unit 3-sphere S^3 , we immediately see that there is an isometry $\varrho \mapsto \epsilon/\varrho$ of the wormhole which interchanges the two ends of $\mathbb{R}^4 - \{0\} \approx \mathbb{R} \times S^3$. Thus our wormhole connects two asymptotically Euclidean ends, but has $s \equiv 0$ and $W_+ \equiv 0$. Now, on any fixed annulus $\varrho \in [\rho/2, \rho]$, the wormhole metric uniformly converges in C^2 to the Euclidean metric, and so exactly the same argument used to glue in Eguchi-Hanson metrics allows us to join two manifolds with $\int s^2 d\mu < \epsilon$ and $\int |W_+|^2 d\mu < \epsilon$ by a wormhole neck so as to obtain a new manifold with $\int s^2 d\mu < 3\epsilon$ and $\int |W_+|^2 d\mu < 3\epsilon$. Thus:

LEMMA 10.9. *Suppose that M_1 and M_2 are two smooth compact oriented 4-manifolds which admit anorexic sequences. Then their connected sum $M_1 \# M_2$ admits anorexic sequences, too.*

The final basic building block we will need is the Burns metric [44]. This is an asymptotically flat metric on $\overline{\mathbb{C}\mathbb{P}_2} - \{p\}$ with $s \equiv 0$ and $W_+ \equiv 0$. Rescaled versions of this metric, restricted to the complement of a $\mathbb{C}\mathbb{P}_1$, are explicitly given by

$$g_{B,\epsilon} = \frac{d\varrho^2}{1 - \left(\frac{\epsilon}{\varrho}\right)^2} + \varrho^2 \left(\sigma_1^2 + \sigma_2^2 + \left[1 - \left(\frac{\epsilon}{\varrho}\right)^2 \right] \sigma_3^2 \right)$$

as a metric on $(\epsilon, \infty) \times S^3$. As the length-scale parameter ϵ tends to zero, we once again get uniform C^2 convergence to the Euclidean metric on any fixed annulus $\varrho \in [\rho/2, \rho]$, and the same gluing argument as before therefore gives us the following result:

LEMMA 10.10. *Suppose that M is a smooth compact oriented 4-manifold which admits an anorexic sequence. Then $M \# \overline{\mathbb{C}\mathbb{P}_2}$ admits anorexic sequences, too.*

We now prove the first part of Theorem C:

THEOREM 10.11. *Let j and k be integers such that $j \geq 2$ and $k \geq 9j$. Then the simply connected 4-manifold $j\mathbb{C}\mathbb{P}_2 \# k\overline{\mathbb{C}\mathbb{P}_2}$ does not admit optimal metrics.*

PROOF. By induction on j , Lemmata 10.7 and 10.9 imply that the connected sum $j\mathbb{C}\mathbb{P}_2 \# 9j\overline{\mathbb{C}\mathbb{P}_2}$ of j copies of $\mathbb{C}\mathbb{P}_2 \# 9\overline{\mathbb{C}\mathbb{P}_2}$ admits an anorexic sequence. Lemma 10.10 and induction on $k - 9j$ then gives us the existence of an anorexic sequence on $j\mathbb{C}\mathbb{P}_2 \# k\overline{\mathbb{C}\mathbb{P}_2}$ for any $k \geq 9j$, $j \geq 2$. Proposition 10.3 therefore tells us that there is no optimal metric on any of these non-spin simply connected 4-manifolds with $b_+ = j \geq 2$. \square

Now let us next consider some ‘exotic’ smooth structures on $\mathbb{C}\mathbb{P}_2 \# 9\overline{\mathbb{C}\mathbb{P}_2}$. Let X denote the complex orbifold $[\mathbb{C}\mathbb{P}_1 \times E]/\mathbb{Z}_2$ used in the proof of Lemma 10.7, and let us observe that we have a holomorphic orbifold submersion $X \rightarrow \mathbb{C}\mathbb{P}_1/\mathbb{Z}_2$ given by projection to the first factor. Near any non-singular point of $\mathbb{C}\mathbb{P}_1/\mathbb{Z}_2$, this is a locally trivial holomorphic E -bundle. Let p and q be two relatively prime integers ≥ 2 , and choose two nonsingular points $a, b \in \mathbb{C}\mathbb{P}_1/\mathbb{Z}_2$. Note that $\mathbb{C}\mathbb{P}_1/\mathbb{Z}_2$ is really just a copy of $\mathbb{C}\mathbb{P}_1$ with two marked points which are considered to be orbifold points of order 2. Let us now also mark the points a and b , and consider them

to be orbifold points of order p and q . At the same time, we modify V to obtain a new orbifold $V_{p,q}^0$ by replacing the fiber over a with E/\mathbb{Z}_p and the fiber over b with E/\mathbb{Z}_q , where the two actions are generated by translation of E of order p and order q , respectively. This can be done via a *logarithmic transformation* in the sense of Kodaira; for example, in a neighborhood of a biholomorphic to the open unit disk $D \subset \mathbb{C}$, we $E \times D$ with $[E \times D]/\mathbb{Z}_p$, where \mathbb{Z}_p acts on E as before, and simultaneously acts on D via the action generated by $z \mapsto e^{2\pi i/p}z$. We then have a holomorphic orbifold submersion from $V_{p,q}^0$ to our orbifold $\mathbb{C}\mathbb{P}_1$ with four orbifold points. Now choose the compatible flat metric on E with unit area and use a partition of unity to patch the a product metric on V with local product metrics on $[E \times D]/\mathbb{Z}_p$ and $[E \times D]/\mathbb{Z}_q$. The result is a Riemannian submersion orbifold metric on V . If we now scale down the fiber E with keeping the metric on our orbifold $\mathbb{C}\mathbb{P}_1$ fixed, the result is therefore a family of metrics on $V_{p,q}^0$ with volume tending to zero while the curvature remains uniformly bounded [14, 46]. In particular, this is an anorexic sequence on $V_{p,q}^0$, and Lemma 10.4 tells us that the complex surface $M_{p,q}^0$ obtain by replacing each of the 8 orbifold singularities of $V_{p,q}^0$ by (-2) -curves also admits anorexic sequences; moreover, the manifolds $M_{p,q}^0 \# \ell \mathbb{C}\mathbb{P}_2$ all admit anorexic sequences, too, as a consequence of Lemma 10.10. However, the manifolds $M_{p,q}$ are the so-called *Dolgachev surfaces*. These Dolgachev surfaces are all homeomorphic to $\mathbb{C}\mathbb{P}_2 \# 9 \mathbb{C}\mathbb{P}_2$, but Donaldson or Seiberg-Witten invariants can be used [22] to show that no two of them are diffeomorphic. Moreover, the corresponding smooth structures on the blow-ups remain distinct, no matter how many times we blow up, and these smooth structures are moreover all distinct from the standard one on $\mathbb{C}\mathbb{P}_2 \# k \mathbb{C}\mathbb{P}_2$. By Proposition 10.3, it follows that none of these smooth manifolds admits an optimal metric, even though $\mathbb{C}\mathbb{P}_2 \# k \mathbb{C}\mathbb{P}_2$ *does* admit optimal metrics for $k \geq 14$.

The story is similar for homotopy $K3$ surfaces. Namely, we can view T^4/\mathbb{Z}_2 as an orbifold elliptic fibration over $\mathbb{C}\mathbb{P}_1/\mathbb{Z}_2$, and so modify it by logarithmic transforms of odd order at one fiber. The resulting orbifolds V_q^1 then admit anorexic sequences as before, as do the 4-manifolds M_q^1 obtained by replacing their singular points by 2-spheres of self-intersection -2 . These manifolds are homeomorphic to $K3$ surfaces, but as smooth manifolds they are distinct, not only from $K3$, but also from each other. Proposition 10.3 thus tells us that none of them admits optimal metrics, even though they are homeomorphic to $K3$, which *does* admit optimal metrics. We have thus proved Theorem B:

THEOREM 10.12. *The existence or non-existence of optimal metrics depends on the choice of smooth structure. In particular, the topological 4-manifolds $K3$ and $\mathbb{C}\mathbb{P}_2 \# k \mathbb{C}\mathbb{P}_2$, $k \geq 14$, admit infinitely many exotic smooth structures for which no optimal metric exists, even though each also admits a “standard” smooth structure for which optimal metrics do exist.*

A similar construction [46] yields anorexic sequences on many exotic manifolds homeomorphic to $j \mathbb{C}\mathbb{P}_2 \# k \mathbb{C}\mathbb{P}_2$. Consider the complex orbifold $[\Sigma \times E]/\mathbb{Z}_2$, where Σ is a hyperelliptic Riemann surface of genus \mathbf{g} :

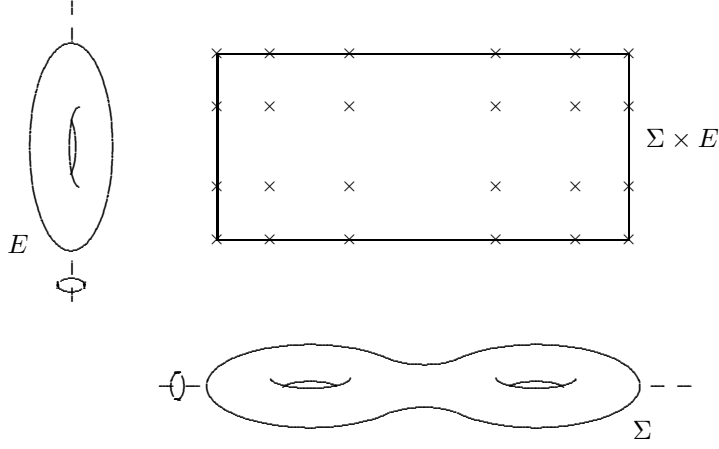

Giving E its compatible flat metric of various areas, products with a fixed metric on Σ give us anorexic sequences on the orbifold $V^{\mathbf{g}} = [\Sigma \times E]/\mathbb{Z}_2$, and we also get anorexic sequences on the orbifold $V_q^{\mathbf{g}}$ obtained by performing a logarithmic transform to one fiber by the previous gluing argument. If $M_q^{\mathbf{g}}$ denotes the complex surface obtained by replacing the singularities of $V_q^{\mathbf{g}}$ by (-2) -curves, then Lemma 10.4 guarantees that $M_q^{\mathbf{g}}$ also admits anorexic sequences, and Lemma 10.10 then tells us that $M_q^{\mathbf{g}} \# \ell \overline{\mathbb{C}\mathbb{P}_2}$ admits anorexic sequences, too. Now $M_q^{\mathbf{g}}$ is a simply connected complex surface with $p_g = \mathbf{g}$ and $c_1^2 = 0$; and it is non-spin if either \mathbf{g} or q is even. For any $\ell > 0$, Theorem 2.3 tells us that $M_q^{\mathbf{g}} \# \ell \overline{\mathbb{C}\mathbb{P}_2}$ is homeomorphic to $(2\mathbf{g} + 1)\mathbb{C}\mathbb{P}_2 \# (10\mathbf{g} + 9 + \ell)\overline{\mathbb{C}\mathbb{P}_2}$; and we also get the analogous statement for $\ell = 0$ if q is even. However, by varying q , gauge theory can be used to show [23, 27] that we obtain infinitely many distinct smooth structures in this way for any fixed \mathbf{g} and ℓ . By Proposition 10.3, we therefore have the following result:

THEOREM 10.13. *For any odd $j \geq 1$ and any $k \geq 5j + 4$, the topological manifold $j\mathbb{C}\mathbb{P}_2 \# k\overline{\mathbb{C}\mathbb{P}_2}$ admits infinitely distinct smooth structures for which no optimal metric exists.*

Lemma 10.9 now allows us to produce more examples of smooth 4-manifolds with anorexic sequences by taking connected sums of our previous examples. Determining whether we obtain distinct differentiable structures in this way is a cutting-edge problem in gauge-theory, however, and it is only by applying the sophisticated new machinery of Bauer and Furuta [9, 8] that a result of this type can be obtained. Specifically, if \mathbf{g} is odd, then the bandwidth argument of [35] shows that the $M^{\mathbf{g}} \# M_q^1 \# \ell \overline{\mathbb{C}\mathbb{P}_2}$ run through infinitely many differentiable structures on $(2\mathbf{g} + 4)\mathbb{C}\mathbb{P}_2 \# (10\mathbf{g} + 28 + \ell)\overline{\mathbb{C}\mathbb{P}_2}$ as we vary the even integer $q \geq 2$, and that $2M^{\mathbf{g}} \# 2M_q^1 \# \ell \overline{\mathbb{C}\mathbb{P}_2}$ runs through infinitely many differentiable structures on $(4\mathbf{g} + 8)\mathbb{C}\mathbb{P}_2 \# (20\mathbf{g} + 56 + \ell)\overline{\mathbb{C}\mathbb{P}_2}$. Since Proposition 10.3 tells us that none of these spaces can admit optimal metrics, we thus obtain the second part of of Theorem C:

THEOREM 10.14. *If j and k are integers, with $j \geq 5$, $j \not\equiv 0 \pmod{8}$, and $k \geq 9j$, then the topological manifold $j\mathbb{C}\mathbb{P}_2 \# k\overline{\mathbb{C}\mathbb{P}_2}$ admits infinitely distinct smooth structures for which no optimal metric exists.*

11. Concluding Remarks

While we have seen that many topological 4-manifolds fail to admit optimal metrics for many choices of smooth structure, the techniques developed here do not by any means allow us to determine whether or not an optimal metric exists for an *arbitrary* smooth structure. The reason is that the arguments deployed in §10 are heavily dependent on the existence of anorexic sequences of metrics, whereas such sequences simply do not exist for many smooth structures. For example, if X is a minimal complex surface of general type, and if $M = X \# \ell \overline{\mathbb{C}\mathbb{P}_2}$ is the complex surface obtained from it by blowing up ℓ points, then Seiberg-Witten theory can be used to show [47] that any metric on M satisfies

$$(13) \quad \int_M \left(\frac{s^2}{24} + 2|W_+|^2 \right) d\mu \geq \frac{8\pi^2}{3} c_1^2(X),$$

so there are certainly no anorexic metrics on such an M . If X is simply connected and ℓ is sufficiently large, however, this 4-manifold is homeomorphic to one of the manifolds treated by Theorem C, and so represents an exotic smooth structure on this topological 4-manifold which is simply not amenable to treatment with the current technology.

The main obstacle to progress on this front is that the estimate (13) does not appear to be sharp; if we compare it with known minimizing sequences for $\int s^2 d\mu$ on a complex surface M of general type with minimal model X , we only obtain upper and lower bounds

$$\frac{16\pi^2}{3} c_1^2(X) - 8\pi^2(\chi + 3\tau)(M) \leq \mathcal{I}_{\mathcal{R}}(M) \leq 8\pi^2 c_1^2(X) - 8\pi^2(\chi + 3\tau)(M)$$

for $\mathcal{I}_{\mathcal{R}}(M)$. These bounds certainly do not allow one to compute $\mathcal{I}_{\mathcal{R}}$, but they do allow us to estimate with sufficient accuracy to be able to know that at least several different values of $\mathcal{I}_{\mathcal{R}}$ must occur for many fixed homeotypes. An exact computation of $\mathcal{I}_{\mathcal{R}}$ for such examples would have many interesting ramifications, and should be considered as an outstanding open problem in the subject.

While current technology does not suffice to compute $\mathcal{I}_{\mathcal{R}}$ for many of the most interesting 4-manifolds, the analogous invariants

$$\begin{aligned} \mathcal{I}_s(M) &= \inf_g \int_M |s_g|^{n/2} d\mu_g \\ \mathcal{I}_r(M) &= \inf_g \int_M |r_g|^{n/2} d\mu_g \end{aligned}$$

arising from the scalar and Ricci curvatures *do* turn out to be exactly computable for complex surfaces of general type and many of their connect sums [47, 36]. It may therefore come as a surprise that one key trick used in computations of \mathcal{I}_r is closely related to the techniques developed here. Indeed, the Gauss-Bonnet and signature formulæ tell one that

$$\int_M |r|^2 d\mu = -8\pi^2(2\chi + 3\tau)(M) + 8 \int_M \left(\frac{s^2}{24} + \frac{1}{2}|W_+|^2 \right) d\mu$$

so that the existence of an anorexic sequence is certainly quite sufficient to allow one to calculate \mathcal{I}_r . However, the curious difference is that the available Seiberg-Witten estimate analogous to (13) for this particular combination of s and W_+ turns out to typically be sharp. For example, if $M = X \# \ell \overline{\mathbb{C}P}_2$ is a complex surface of general type with minimal model X , one obtains the estimate

$$\int_M \left(\frac{s^2}{24} + \frac{1}{2} |W_+|^2 \right) d\mu \geq 2\pi^2 c_1^2(X),$$

and one can actually find sequences of metrics for which the left-hand side approaches the expression on the right; thus, an exact formula

$$\mathcal{I}_r(M) = 8\pi^2 [c_1^2(X) + \ell]$$

emerges from the discussion. Moreover, related arguments show that this infimum is unattained whenever $\ell > 0$. For details and further applications, see [47, 36].

While Theorem A may shed a fair amount of light on the existence of SFASD metrics on compact 4-manifolds, it by no means closes the book on the subject. For example, we still do not know whether such metrics exist on $5\overline{\mathbb{C}P}_2$. The existence of SFASD metrics on $\mathbb{C}P_2 \# k\overline{\mathbb{C}P}_2$ for $10 \leq k \leq 13$ is also not covered by Theorem A, although Yann Rollin and Michael Singer seem to have recently made considerable progress concerning these manifolds. The global structure of the moduli space of SFASD metrics still remains a mystery. And it would obviously be of the greatest interest to sharpen Proposition 3.5 so as to say something about diffeotype when $b_+ = 0$, or to definitively handle the non-simply connected case.

We now have many examples of optimal metrics on compact 4-manifolds, essentially falling into two classes: the Einstein metrics, and the scalar-flat anti-self-dual metrics. Of course, we can cheaply obtain further examples by reversing the orientation of SFASD manifolds to make them self-dual instead of anti-self-dual. But, such trickery aside, there do not really seem to be any other known examples of optimal metrics on compact 4-manifolds. In particular, it seems that all known examples of optimal metrics are critical points of $\int s^2 d\mu$, and so, by optimality, also of $\int |W_+|^2 d\mu$. Now a metric on a 4-manifold is a critical point of $\int |W_+|^2 d\mu$ iff it has vanishing Bach tensor [11]. Are there any optimal metrics on compact 4-manifolds that aren't Bach-flat? Are there scalar-flat optimal metrics which are Bach-flat, but neither self-dual nor anti-self-dual? Both of these questions should illustrate the degree to which we still remain fundamentally ignorant as to the true nature of general optimal metrics, even in dimension four.

Acknowledgments. I would like to express my profound gratitude to Dominic Joyce, who originally convinced me, by an entirely different line of reasoning, that Theorems 6.3 and 6.4 ought to be true. I would also like to warmly thank Mike Eastwood and Michael Singer for granting me permission to present some of their unpublished results in §8. Finally, I would like to thank Chris Bishop, Mark de Cataldo, Sorin Popescu, and Michael Taylor for helpful suggestions concerning a number of important technical details.

References

- [1] C. ALLENDOERFER AND A. WEIL, *The Gauss-Bonnet theorem for Riemannian polyhedra*, Trans. Am. Math. Soc., 53 (1943), pp. 101–129.
- [2] A. ALTMAN AND S. KLEIMAN, *Introduction to Grothendieck Duality Theory*, Lecture Notes in Mathematics, Vol. 146, Springer-Verlag, Berlin, 1970.

- [3] M. F. ATIYAH, *Green's functions for self-dual four-manifolds*, in *Mathematical Analysis and Applications, Part A*, vol. 7 of *Adv. in Math. Suppl. Stud.*, Academic Press, New York, 1981, pp. 129–158.
- [4] M. F. ATIYAH, N. J. HITCHIN, AND I. M. SINGER, *Self-duality in four-dimensional Riemannian geometry*, *Proc. Roy. Soc. London Ser. A*, 362 (1978), pp. 425–461.
- [5] T. N. BAILEY AND M. A. SINGER, *Twistors, massless fields and the Penrose transform*, in *Twistors in mathematics and physics*, vol. 156 of *London Math. Soc. Lecture Note Ser.*, Cambridge Univ. Press, Cambridge, 1990, pp. 299–338.
- [6] S. BĂNICĂ AND O. STĂNĂȘILĂ, *Algebraic Methods in the Global Theory of Complex Spaces*, Editura Academiei, Bucharest, 1976.
- [7] W. BARTH, C. PETERS, AND A. V. DE VEN, *Compact Complex Surfaces*, Springer-Verlag, 1984.
- [8] S. BAUER, *A stable cohomotopy refinement of Seiberg-Witten invariants. II*, *Invent. Math.*, 155 (2004), pp. 21–40.
- [9] S. BAUER AND M. FURUTA, *A stable cohomotopy refinement of Seiberg-Witten invariants. I*, *Invent. Math.*, 155 (2004), pp. 1–19.
- [10] M. BERGER, *Riemannian Geometry During the Second Half of the Twentieth Century*, American Mathematical Society, Providence, RI, 2000. Reprint of the 1998 original.
- [11] A. BESSE, *Einstein Manifolds*, Springer-Verlag, 1987.
- [12] C. J. BISHOP AND P. W. JONES, *Hausdorff dimension and Kleinian groups*, *Acta Math.*, 179 (1997), pp. 1–39.
- [13] J.-P. BOURGUIGNON, *Les variétés de dimension 4 à signature non nulle dont la courbure est harmonique sont d'Einstein*, *Invent. Math.*, 63 (1981), pp. 263–286.
- [14] J. CHEEGER AND M. GROMOV, *Collapsing Riemannian manifolds while keeping their curvature bounded. I*, *J. Differential Geom.*, 23 (1986), pp. 309–346.
- [15] S. DONALDSON AND R. FRIEDMAN, *Connected sums of self-dual manifolds and deformations of singular spaces*, *Nonlinearity*, 2 (1989), pp. 197–239.
- [16] S. K. DONALDSON, *An application of gauge theory to four-dimensional topology*, *J. Differential Geom.*, 18 (1983), pp. 279–315.
- [17] M. G. EASTWOOD AND J. W. RICE, *Conformally invariant differential operators on Minkowski space and their curved analogues*, *Comm. Math. Phys.*, 109 (1987), pp. 207–228.
- [18] M. G. EASTWOOD AND M. A. SINGER, *On the geometry of twistor spaces*. unpublished manuscript, 1991.
- [19] T. EGUCHI AND A. J. HANSON, *Self-dual solutions to Euclidean gravity*, *Ann. Physics*, 120 (1979), pp. 82–106.
- [20] M. FREEDMAN, *On the topology of 4-manifolds*, *J. Differential Geom.*, 17 (1982), pp. 357–454.
- [21] R. FRIEDMAN, *Global smoothings of varieties with normal crossings*, *Ann. of Math. (2)*, 118 (1983), pp. 75–114.
- [22] ———, *Vector bundles and SO(3)-invariants for elliptic surfaces*, *J. Amer. Math. Soc.*, 8 (1995), pp. 29–139.
- [23] R. FRIEDMAN AND J. W. MORGAN, *On the diffeomorphism types of certain algebraic surfaces. I*, *J. Differential Geom.*, 27 (1988), pp. 297–369.
- [24] J. GASQUI AND H. GOLDSCHMIDT, *Théorèmes de dualité en géométrie conforme*, *C. R. Acad. Sci. Paris Sér. I Math.*, 294 (1982), pp. 99–102.
- [25] ———, *Déformations Infinitésimales des Structures Conformes Plates*, vol. 52 of *Progress in Mathematics*, Birkhäuser Boston Inc., Boston, MA, 1984.
- [26] D. GILBARG AND N. S. TRUDINGER, *Elliptic Partial Differential Equations of Second Order*, Springer-Verlag, Berlin, second ed., 1983.
- [27] R. E. GOMPF AND A. I. STIPSICZ, *4-Manifolds and Kirby Calculus*, American Mathematical Society, Providence, RI, 1999.
- [28] P. GRIFFITHS AND J. HARRIS, *Principles of Algebraic Geometry*, Wiley-Interscience [John Wiley & Sons], New York, 1978. Pure and Applied Mathematics.
- [29] M. GROMOV, *Structures métriques pour les variétés riemanniennes*, CEDIC, Paris, 1981. Edited by J. Lafontaine and P. Pansu.
- [30] R. C. GUNNING AND H. ROSSI, *Analytic Functions of Several Complex Variables*, Prentice-Hall Inc., Englewood Cliffs, N.J., 1965.
- [31] F. HIRZEBRUCH, *Topological Methods in Algebraic Geometry*, Springer-Verlag, 1966.

- [32] N. J. HITCHIN, *On compact four-dimensional Einstein manifolds*, J. Differential Geom., 9 (1974), pp. 435–442.
- [33] ———, *Kählerian twistor spaces*, Proc. London Math. Soc. (3), 43 (1981), pp. 133–150.
- [34] G. HORROCKS, *A construction for locally free sheaves*, Topology, 7 (1968), pp. 117–120.
- [35] M. ISHIDA AND C. LEBRUN, *Spin manifolds, Einstein metrics, and differential topology*, Math. Res. Lett., 9 (2002), pp. 229–240.
- [36] ———, *Curvature, connected sums, and Seiberg-Witten theory*, Comm. Anal. Geom., 11 (2003), pp. 809–836.
- [37] D. JOYCE, *Constant scalar curvature metrics on connected sums*, Int. J. Math. Math. Sci., (2003), pp. 405–450.
- [38] T. KATO, *Perturbation theory for linear operators*, Springer-Verlag New York, Inc., New York, 1966.
- [39] J. KIM, *On the scalar curvature of self-dual manifolds*, Math. Ann., 297 (1993), pp. 235–251.
- [40] J. KIM, C. LEBRUN, AND M. PONTECORVO, *Scalar-flat Kähler surfaces of all genera*, J. Reine Angew. Math., 486 (1997), pp. 69–95.
- [41] N. H. KUIPER, *On conformally-flat spaces in the large*, Ann. of Math. (2), 50 (1949), pp. 916–924.
- [42] J. LAFONTAINE, *Remarques sur les variétés conformément plates*, Math. Ann., 259 (1982), pp. 313–319.
- [43] C. LEBRUN, *On the topology of self-dual 4-manifolds*, Proc. Amer. Math. Soc., 98 (1986), pp. 637–640.
- [44] ———, *Counter-examples to the generalized positive action conjecture*, Comm. Math. Phys., 118 (1988), pp. 591–596.
- [45] ———, *Anti-self-dual metrics and Kähler geometry*, in Proceedings of the International Congress of Mathematicians, Vol. 1, 2 (Zürich, 1994), Basel, 1995, Birkhäuser, pp. 498–507.
- [46] ———, *Kodaira dimension and the Yamabe problem*, Comm. Anal. Geom., 7 (1999), pp. 133–156.
- [47] ———, *Ricci curvature, minimal volumes, and Seiberg-Witten theory*, Inv. Math., 145 (2001), pp. 279–316.
- [48] C. LEBRUN AND M. SINGER, *A Kummer-type construction of self-dual 4-manifolds*, Math. Ann., 300 (1994), pp. 165–180.
- [49] J. LEE AND T. PARKER, *The Yamabe problem*, Bull. Am. Math. Soc., 17 (1987), pp. 37–91.
- [50] B. MASKIT, *Kleinian Groups*, Springer-Verlag, Berlin, 1988.
- [51] S. NAYATANI, *Patterson-Sullivan measure and conformally flat metrics*, Math. Z., 225 (1997), pp. 115–131.
- [52] A. NEULANDER AND L. NIRENBERG, *Complex analytic coordinates in almost complex manifolds*, Ann. of Math. (2), 65 (1957), pp. 391–404.
- [53] R. PENROSE, *Nonlinear gravitons and curved twistor theory*, General Relativity and Gravitation, 7 (1976), pp. 31–52.
- [54] M. H. PROTTER AND H. F. WEINBERGER, *Maximum principles in differential equations*, Prentice-Hall Inc., Englewood Cliffs, N.J., 1967.
- [55] R. SCHOEN AND S.-T. YAU, *Conformally flat manifolds, Kleinian groups and scalar curvature*, Invent. Math., 92 (1988), pp. 47–71.
- [56] J.-P. SERRE, *Modules projectifs et espaces fibrés à fibre vectorielle*, in Séminaire P. Dubreil, M.-L. Dubreil-Jacotin et C. Pisot, 1957/58, Fasc. 2, Exposé 23, Secrétariat mathématique, Paris, 1958, p. 18.
- [57] J. A. THORPE, *Some remarks on the Gauss-Bonnet formula*, J. Math. Mech., 18 (1969), pp. 779–786.
- [58] R. O. WELLS, JR., *Differential Analysis on Complex Manifolds*, Springer-Verlag, New York, second ed., 1980.
- [59] S. T. YAU, *On the curvature of compact Hermitian manifolds*, Invent. Math., 25 (1974), pp. 213–239.
- [60] ———, *On the Ricci curvature of a compact Kähler manifold and the complex Monge-Ampère equation. I*, Comm. Pure Appl. Math., 31 (1978), pp. 339–411.
- [61] ———, *Open problems in geometry*, in Differential Geometry: Partial Differential Equations on Manifolds (Los Angeles, CA, 1990), vol. 54 of Proc. Sympos. Pure Math., Amer. Math. Soc., Providence, RI, 1993, pp. 1–28.

DEPARTMENT OF MATHEMATICS, SUNY AT STONY BROOK, STONY BROOK, NY 11794-3651
E-mail address: `claude@math.sunysb.edu`