

# Flat Spacetimes with Compact Hyperbolic Cauchy Surfaces

Francesco Bonsante

August 23, 2018

## 1 Introduction

We study the flat  $(n + 1)$ -spacetimes  $Y$  admitting a Cauchy surface diffeomorphic to a compact hyperbolic  $n$ -manifold  $M$ . Roughly speaking, we show how to construct a canonical future complete one,  $Y_\rho$ , among all such spacetimes sharing a same holonomy  $\rho$ . We study the geometry of  $Y_\rho$  in terms of its *canonical cosmological time* (CT). In particular we study the asymptotic behaviour of the level surfaces of the cosmological time.

The present work generalizes the case  $n = 2$  treated in [11] taking from [4] the emphasis on the fundamental rôle played by the canonical cosmological time. In particular Mess showed that if  $F$  is a closed surface of genus  $g \geq 2$  then the linear holonomies of the Lorentzian flat structures on  $\mathbb{R} \times F$  such that  $\{0\} \times F$  is a spacelike surface are faithful and discrete representations of  $\pi_1(F)$  in  $\mathrm{SO}^+(2, 1)$ .

Moreover he proved that every representation  $\varphi : \pi_1(F) \rightarrow \mathrm{Iso}(\mathbb{M}^3)$  whose linear part is faithful and discrete is a holonomy for some Lorentzian structure on  $\mathbb{R} \times F$  such that  $\{0\} \times F$  is a spacelike surface. In particular he showed that there exists a unique maximal future complete convex domain of  $\mathbb{M}^3$ , called *domain of dependence*, which is  $\varphi(\pi_1(F))$ -invariant such that the quotient is a globally hyperbolic manifold homeomorphic to  $\mathbb{R} \times F$  with regular cosmological time.

If we fix the linear holonomy  $f : \pi_1(F) \rightarrow \mathrm{SO}^+(2, 1)$  these domains (and so the affine deformations of the representation  $f$ ) are parametrized by the measured geodesic laminations on  $\mathbb{H}^2/f(\pi_1(F))$ . The link between domains of dependence and measured geodesic laminations is the *Gauss map* of the CT-level surfaces.

On the other hand Benedetti and Guadagnini noticed in [4] the *singularity in the past* of a domain of dependence is a real tree which is dual to the lamination. Moreover they argued that the action of  $\pi_1(F)$  on the CT-level surface  $\tilde{S}_a = T^{-1}(a)$  converges in the Gromov sense to the action of  $\pi_1(F)$  on the singularity for  $a \rightarrow 0$  and to the action of  $\pi_1(F)$  on the hyperbolic plane  $\mathbb{H}^2$  for  $a \rightarrow \infty$ . Thus the asymptotic states of the cosmological time materialize the duality between geometric real trees (realized by the singularity in the past) and the measured geodesic laminations in the hyperbolic surface  $F$ , according to Skora's theorem [14].

In this paper we try to generalize this approach in higher dimension. By extending Mess' method to any dimension  $n$  we associate to each  $Y_\rho$  a  $\Gamma$ -invariant *geodesic stratification* of  $\mathbb{H}^n$  (see section 4 for the definition), and we discuss the duality between geodesic stratifications and singularities in the past. In particular we recover this duality at least for an interesting class of so called spacetimes with *simplicial singularity in the past*.

We briefly describe the contents of the paper in section 2. We first remind some basic facts about Lorentzian spacetimes and hyperbolic manifolds, then we give a quite articulated statement of the main results. Some assertions will be fully described and proved in the following sections. In the last section we shall discuss some related questions and open problems.

## 2 Preliminaries and Statement of the Main Theorem

In this section we recall few basic facts about Lorentzian geometry, the geometry of the Minkowski space, and hyperbolic space. An exhaustive treatment about Lorentzian geometry, including a careful analysis of global causality questions, can be found in [9] or in [3]. For an introduction to hyperbolic space, see [5]. In the last part of the section we state the main theorem which we shall prove in the following sections.

**Spacetimes.** A Lorentzian  $(n+1)$ -manifold  $(M, \eta)$  is given by a smooth  $(n+1)$ -manifold  $M$  (this includes the topological assumption that  $M$  is metrizable and with countable basis) and a symmetric non-degenerate 2-form  $\eta$  with signature equal to  $(n, 1)$ . A basis  $(e_0, \dots, e_n)$  of a tangent space  $T_p M$  is *orthonormal* if the matrix of  $\eta_p$  with respect to this basis is  $\text{diag}(-1, 1, \dots, 1)$ . A tangent vector  $v$  is *spacelike* (resp. *timelike*, *null*, *non-spacelike*) if  $\eta(v, v)$  is positive (resp. negative, null, non-positive). A  $C^1$ -curve in  $M$  is *chronological* (resp. *causal*) if the speed vector is timelike (resp. non-spacelike).

Let  $M$  be a Lorentzian connected  $(n+1)$ -manifold. Consider the subset  $\mathcal{C}$  of the tangent bundle  $TM$  formed by the timelike tangent vectors: it turns out that either  $\mathcal{C}$  is connected or it has two connected components. We say that  $M$  is *time-orientable* if  $\mathcal{C}$  has two connected components. A time-orientation is a choice of one of these components. A **spacetime** is a Lorentzian connected time-orientable manifold provided with a time-orientation. Let  $M$  be a space-time and  $\mathcal{C}_+$  be the chosen component. A non-spacelike tangent vector is *future-directed* (resp. *past directed*) if it is not the null vector and it lies (resp. it does not lie) in the closure of  $\mathcal{C}_+$ . A causal curve is *future-directed* if its speed vector is future directed. Let  $p \in M$ , the *future of  $p$*  (resp. *the past*) is the subset  $I^+(p)$  (resp.  $I^-(p)$ ) of  $M$  formed by the points of  $M$  which are terminal end-points of future-directed (resp. past-directed) chronological curves which start in  $p$ . If we replace the chronological curves by causal curves we obtain the *causal future*  $J^+(p)$  (resp. *causal past*  $J^-(p)$ ) of  $p$ . Let  $\gamma : I \rightarrow M$  be a causal curve. The Lorentzian length of  $\gamma$  is

$$\ell(\gamma) := \int_I \sqrt{-\eta(\gamma'(t), \gamma'(t))} dt.$$

Given  $p \in M$  and  $q \in J^-(p)$  the Lorentzian distance between  $p$  and  $q$  is

$$d(p, q) := \{\sup \ell(\gamma) \mid \gamma \text{ is a causal curve whose endpoints are } p \text{ and } q\}.$$

For every  $p \in M$  we can take

$$\tau(p) := \sup \{d(p, q) \mid q \in J^-(p)\}.$$

This define a function

$$\tau : M \rightarrow \mathbb{R} \cup \{+\infty\}$$

which can be very degenerate (for instance  $\tau \equiv +\infty$  on the Minkowski space  $\mathbb{M}^{n+1}$ ). We are interested in the spacetimes such that the function  $\tau$  is a **canonical cosmological time** (CT): this means that  $\tau$  is finite and increasing on every directed causal curves (i.e.  $\tau$  is a *time*) and

it is *regular*, that is  $\tau$  tends to 0 over every inextendable past directed causal curve. Spacetimes with regular cosmological time have been pointed out and studied in [1]. We recall the following general result.

**Theorem 2.1** *Suppose that  $M$  is a spacetime with a regular cosmological time  $\tau$ . Then  $\tau$  is twice differentiable almost everywhere. Moreover for every  $p \in M$  there is an inextendable in the past timelike geodesic  $\gamma : (0, \tau(p)] \rightarrow M$  which has terminal point in  $p$  and such that  $\tau(\gamma(t)) = t$ . The level surfaces  $S_a = \tau^{-1}(a)$  are future Cauchy surfaces.*

We recall that a **Cauchy surface** is an embedded hypersurface  $S$  of  $M$  such that every inextendable causal curve in  $M$  intersects  $S$  in a unique point.

Finally we recall that a spacetime  $M$  is **globally hyperbolic** if for every  $p, q \in M$  the set  $J^+(p) \cap J^-(q)$  is compact. It is the strongest global causality assumption and implies strict constraints on the topology of  $M$ . In particular in [8] it is shown that  $M$  is globally hyperbolic if and only if there is a Cauchy surface  $S$  in  $M$ , and in this case  $M$  is homeomorphic to  $\mathbb{R} \times S$ .

**Minkowski space.** The *Minkowski*  $(n + 1)$ -space-time  $\mathbb{M}^{n+1}$  is the flat simply connected complete Lorentzian  $(n + 1)$ -manifold (it is unique up to isometry). Let  $(x_0, \dots, x_n)$  be the natural coordinates on  $\mathbb{R}^{n+1}$ , then a concrete model for  $\mathbb{M}^{n+1}$  is  $\mathbb{R}^{n+1}$  provided with the Lorentz form

$$\eta = -dx_0^2 + dx_1^2 + \dots + dx_n^2.$$

In what follows we shall always use this model. Notice that the frame  $(e_i = \frac{\partial}{\partial x_i})_{i=0, \dots, n}$  is parallel and orthonormal. Thus we can identify in a standard way the tangent space  $(T_x \mathbb{M}^{n+1}, \eta_x)$  with  $\mathbb{R}^{n+1}$  provided with the scalar product  $\langle \cdot, \cdot \rangle$  defined by the rule  $\langle v, w \rangle = -v_0 w_0 + v_1 w_1 + \dots + v_n w_n$ .

Minkowski space is an orientable and time-orientable Lorentz manifold. Let us put on it the standard orientation (such that the canonical basis  $(e_0, \dots, e_n)$  is positive) and the standard time-orientation (a timelike tangent vector  $v$  is future directed if  $\langle v, e_0 \rangle < 0$ ). By *orthonormal affine coordinates* we mean a set  $(y_0, \dots, y_n)$  of affine coordinates on  $\mathbb{M}^{n+1}$  such that the frame  $\{\frac{\partial}{\partial y_i}\}$  is *orthonormal and positive* and the vector  $\frac{\partial}{\partial y_0}$  is *future directed*.

Consider the isometry group of  $\mathbb{M}^{n+1}$ . It is easy to see that  $f$  is an isometry of  $\mathbb{M}^{n+1}$  if and only if it is affine and  $df(0)$  belongs to the group  $O(n, 1)$  of the linear transformations of  $\mathbb{R}^{n+1}$  which preserve the scalar product  $\langle \cdot, \cdot \rangle$ . It follows that the group of isometries of  $\mathbb{M}^{n+1}$  is generated by  $O(n, 1)$  and the group of translations  $\mathbb{R}^{n+1}$ . Furthermore  $\mathbb{R}^{n+1}$  is a normal subgroup of  $\text{Iso}(\mathbb{M}^{n+1})$  (in fact it is the kernel of the map  $\text{Iso}(\mathbb{M}^{n+1}) \ni f \mapsto df(0) \in O(n, 1)$ ) so that  $\text{Iso}(\mathbb{M}^{n+1})$  is isomorphic to  $\mathbb{R}^{n+1} \rtimes O(n, 1)$ .

Notice that  $O(n, 1)$  is the isotropy group of 0 in  $\text{Iso}(\mathbb{M}^{n+1})$ . It is a semisimple Lie group and it has four connected components. The connected component of the identity  $SO^+(n, 1)$  is the group of linear transformations which preserve orientation and time-orientation. It is the *Lorentz group*. There are two proper subgroups which contain  $SO^+(n, 1)$ : the group  $SO(n, 1)$  of linear isometries which preserve orientation of  $\mathbb{M}^{n+1}$  and the group  $O^+(n, 1)$  of linear isometries which preserve time-orientation of  $\mathbb{M}^{n+1}$ . In each of these groups the index of  $SO^+(n, 1)$  is 2.

Geodesics in  $\mathbb{M}^{n+1}$  are straight lines. There are three types of geodesics up to isometry: spacelike, timelike and null. Notice that they are classified by the restriction of the form  $\eta$  on them. The totally geodesic  $k$ -planes are the affine  $k$ -planes in  $\mathbb{M}^{n+1}$ . Also the  $k$ -planes are classified up to isometry by the restriction of the Lorentz form on them. Hence we say that a  $k$ -plane  $P$  is *spacelike* if  $\eta|_P$  is a flat Riemannian form, we say that it is *timelike* if  $\eta|_P$  is a flat Lorentz form, finally we say that  $P$  is *null* if  $\eta|_P$  is a degenerated form.

**Hyperbolic space.** Let  $\mathbb{H}^n$  be the set of the points in the future of 0 which have Lorentzian distance from 0 equal to 1. If we identify  $\mathbb{M}^{n+1}$  with the tangent space  $T_0\mathbb{M}^{n+1}$  via the exponential map we get

$$\mathbb{H}^n = \{x \in \mathbb{M}^{n+1} \mid \langle x, x \rangle = -1, \quad x_0 > 0\}.$$

It follows that the tangent space  $T_x\mathbb{H}^n$  is the space  $x^\perp$ . Since  $x$  is timelike  $T_x\mathbb{H}^n$  is spacelike so that  $\mathbb{H}^n$  has a natural Riemannian structure. An easy calculation shows that  $\mathbb{H}^n$  is the simply connected complete Riemannian manifold with constant sectional curvature equal to  $-1$ .

A geodesic in  $\mathbb{H}^n$  is the intersection of  $\mathbb{H}^n$  with a timelike 2-plane which passes through 0. More generally a totally geodesic  $k$ -submanifold ( $k$ -plane) of  $\mathbb{H}^n$  is the intersection of  $\mathbb{H}^n$  with a timelike  $(k+1)$ -plane which passes through 0 (notice that such intersection is transverse). Thus it follows that a subset  $C$  of  $\mathbb{H}^n$  is convex if and only if it is the intersection of  $\mathbb{H}^n$  with a convex cone with apex in 0.

Clearly  $\mathbb{H}^n$  is invariant for the group  $O^+(n, 1)$  and furthermore this group acts by isometries on  $\mathbb{H}^n$ . It can be shown that  $O^+(n, 1)$  is in fact the isometry group of  $\mathbb{H}^n$ . The group of orientation-preserving isometries of  $\mathbb{H}^n$  is identified with  $SO^+(n, 1)$ .

Let  $\mathbb{P}^n$  be the set of the lines which passes through 0 and  $\pi : \mathbb{M}^{n+1} \rightarrow \mathbb{P}^n$  the natural projection. Then  $\pi|_{\mathbb{H}^n}$  is a diffeomorphism of  $\mathbb{H}^n$  onto the set of time-like lines. The closure of this set is a closed ball and its boundary is formed by the set of the null lines. Let  $\partial\mathbb{H}^n$  be the set of null lines and put on  $\overline{\mathbb{H}^n} := \mathbb{H}^n \cup \partial\mathbb{H}^n$  the topology which makes the natural map  $\pi : \overline{\mathbb{H}^n} \rightarrow \mathbb{P}^n$  a homeomorphism onto its image. Notice that every  $g \in O^+(n, 1)$  extends uniquely to a homeomorphism of  $\overline{\mathbb{H}^n}$ .

Now we can classify the elements of  $O^+(n, 1)$ . We say that  $g \in O^+(n, 1)$  is *elliptic* if  $g$  has a timelike eigenvector (and in this case the respective eigenvalue is 1). We say that  $g$  is *parabolic* if it is not elliptic and it has a unique null eigenvector (and in this case the relative eigenvalue is 1). Finally we say that  $g$  is *hyperbolic* if it is not elliptic and it has two null eigenvectors (in this case there exists  $\lambda > 1$  such that the respective eigenvalues are  $\lambda$  and  $\lambda^{-1}$ ). Notice that if  $g$  is hyperbolic there exists a unique geodesic  $\gamma$  in  $\mathbb{H}^n$  which is invariant for  $g$ . In this case  $\gamma$  is called the *axis* of  $g$ .

**Geometric structures.** We shall consider only *oriented* manifolds or spacetimes. We shall be concerned with *hyperbolic  $n$ -manifolds* (i.e. Riemannian  $n$ -manifolds locally isometric to  $\mathbb{H}^n$ ) and with *flat  $(n+1)$ -spacetimes* (i.e. spacetimes locally isometric to  $\mathbb{M}^{n+1}$ ). By using the convenient setting of  $(X, G)$ -manifolds (see for instance chap. B of [5]) we can say that hyperbolic manifolds and flat spacetimes are, by definition,  $(X, G)$ -manifolds where  $(X, G)$  is respectively  $(\mathbb{H}^n, SO^+(n, 1))$  and  $(\mathbb{M}^{n+1}, \text{Iso}(\mathbb{M}^{n+1}))$ .

We summarize few basic facts about such  $(X, G)$ -manifolds. Let  $N$  be a  $(X, G)$ -manifold and fix an universal covering  $\pi : \tilde{N} \rightarrow N$ . Then the  $(X, G)$ -structure on  $N$  lifts to a  $(X, G)$ -structure on  $\tilde{N}$  such that:

1. the covering map  $\pi$  is a local isometry;
2. the group  $\pi_1(N, x_0)$  acts by isometries on  $\tilde{N}$  in such way that  $N = \tilde{N}/\pi_1(N, x_0)$  and  $\pi$  is identified with the quotient map.

Let us summarize by saying that  $\pi : \tilde{N} \rightarrow N$  is a  $(X, G)$ -*universal covering*.

**Proposition 2.2** *Given a  $(X, G)$ -universal covering  $\pi : \tilde{N} \rightarrow N$  there exists a pair  $(D, \rho)$  such that:*

1.  $D : \tilde{N} \rightarrow X$  is a local isometry;

2.  $\rho : \pi_1(N, x_0) \rightarrow G$  is a representation;

3. the map  $D$  is  $\pi_1(N, x_0)$ -equivariant in the following sense

$$D(\gamma(x)) = \rho(\gamma)D(x) \quad \text{for all } \gamma \in \pi_1(N, x_0) \text{ and } x \in \tilde{N}.$$

Moreover given two such pairs  $(D, \rho)$  and  $(D', \rho')$  there exists a unique  $g \in G$  such that

$$D' = gD \quad \text{and} \quad \rho' = g\rho g^{-1}.$$

■

**Def. 2.1** With the notation of the proposition  $D$  is called a **developing map** of  $N$  and  $h$  is the holonomy representative compatible with  $D$ . The conjugacy class of  $h$  is called the **holonomy** of the  $(X, G)$ -manifold  $N$ .

**Remark 2.3** 1. Generally  $D$  is only a local isometry neither injective nor surjective.

2. If  $D$  is a global isometry between  $\tilde{N}$  and  $X$ , we say that the  $(X, G)$ -manifold  $N$  is *complete*. A hyperbolic manifold is *complete* as a Riemannian manifold iff it is  $(\mathbb{H}^n, \text{SO}^+(n, 1))$ -complete. If  $N$  is complete then  $\rho$  is a faithful representation and the image  $\Gamma$  acts freely and properly discontinuously on  $X$ . The isometry  $D$  induces an isometry  $\hat{D} : \tilde{N}/\pi_1(N, x_0) \rightarrow X/\Gamma$ .

Let  $M := \mathbb{H}^n/\Gamma$  be a complete hyperbolic  $n$ -manifold. Notice that  $\Gamma$  acts freely and properly discontinuously on the whole  $I^+(0)$ . The *future complete Minkowskian cone* on  $M$  is the flat Lorentz spacetime  $\mathcal{C}^+(M) := I^+(0)/\Gamma$ . Notice that  $I^+(0)$  has regular cosmological time  $\tilde{T} : I^+(0) \rightarrow \mathbb{R}_+$  which is in fact a real analytic submersion with level surfaces  $\mathbb{H}_a = \{x \in I^+(0) \mid -x_0^2 + x_1^2 + \dots + x_n^2 = -a^2\}$ . For every  $p \in I^+(0)$  we have  $\tilde{T}(p) = d(p, 0)$  and the origin is the unique point with this property. Every  $\mathbb{H}_a$  is a Cauchy surface of  $I^+(0)$  so that it is globally hyperbolic.

Since  $\tilde{T}$  is  $\Gamma$ -invariant it induces the cosmological time  $T : \mathcal{C}^+(M) \rightarrow \mathbb{R}_+$  with level surface  $\tilde{S}_a = \mathbb{H}_a/\Gamma$ . Notice that  $M = \tilde{S}_1$  so that  $\mathcal{C}^+(M)$  is diffeomorphic to  $\mathbb{R}_+ \times M$ .

We are interested in studying the globally hyperbolic flat spacetimes  $Y$  which admit a Cauchy surface diffeomorphic to  $M$  (hence  $Y$  is diffeomorphic to  $\mathbb{R}_+ \times M$ ). We shall provide a complete discussion of this problem under the assumption that  $M$  is *compact*. So from now on  $M := \mathbb{H}^n/\Gamma$  is a compact hyperbolic manifold.

The set of globally hyperbolic flat spacetime structures on  $\mathbb{R}_+ \times M$  has a natural topology (induced by the  $C^\infty$ -topology on symmetric forms). Let us denote by  $Lor(M)$  this space. We know that  $\text{Diffeo}(\mathbb{R}_+ \times M)$  acts continuously on  $Lor(M)$ . The quotient  $\mathcal{M}_{Lor}(M)$  is called the *moduli space*, whereas the *Teichmüller space*  $\mathcal{T}_{Lor}(M)$  is the quotient of the group by the action of  $Lor(M)$  of homotopically trivial diffeomorphisms. Notice that two structures which differ by a homotopically trivial diffeomorphism give the same holonomy (up to conjugacy), so that the holonomy depends only on the class of the structure in the Teichmüller space.

For every group  $G$  denote by  $\mathcal{R}_G$  the set of representations

$$\pi_1(M, x_0) \rightarrow G$$

up to conjugacy. As  $\pi_1(M, x_0) \cong \pi_1(\mathbb{R}_+ \times M, x_0)$  we have a continuous holonomy map

$$\rho : \mathcal{T}_{Lor}(M) \rightarrow \mathcal{R}_{\text{Iso}(\mathbb{M}^{n+1})}$$

with linear part

$$d\rho : \mathcal{T}_{Lor}(M) \rightarrow \mathcal{R}_{SO^+(n,1)}$$

In a recent paper [2] it is shown that every linear holonomy is faithful with discrete image (for  $n = 2$  this was deduced in [11] as a corollary of a theorem of Goldman). So we shall often confuse the linear holonomy with its image subgroup of  $SO^+(n, 1)$  (up to conjugacy). If  $n \geq 3$  Mostow rigidity theorem implies that the linear holonomy group coincides with  $\Gamma$  (up to conjugacy). Thus if  $n \geq 3$  the image of the holonomy map  $h : \mathcal{T}_{Lor}(M) \rightarrow \mathcal{R}_{Iso(\mathbb{M}^{n+1})}$  is contained in

$$\mathcal{R}(\Gamma) = \{[\rho] \in \mathcal{R}_{Iso(\mathbb{M}^{n+1})} \mid d(\rho(\gamma))(0) = \gamma \text{ for all } \gamma \in \Gamma\}.$$

When  $n = 2$  we have to vary the hyperbolic structure on  $M$  (i.e. the group  $\Gamma$ ) which is now a closed surface of genus  $g \geq 2$ . Anyway  $\mathcal{R}(\Gamma)$  is the key object to be understood.

Let  $\rho$  a representation of  $\Gamma$  into  $Iso(\mathbb{M}^{n+1})$  whose linear part is the identity. Thus  $\rho(\gamma) = \gamma + t_\gamma$  where  $t_\gamma = \rho(\gamma)(0)$  is the traslation part. By imposing the homomorphism condition we obtain

$$t_{\alpha\beta} = t_\alpha + \alpha t_\beta \quad \forall \alpha, \beta \in \Gamma.$$

So that  $(t_\gamma)_{\gamma \in \Gamma}$  is a cocycle in  $Z^1(\Gamma, \mathbb{R}^{n+1})$ . Conversely if  $(t_\gamma)_{\gamma \in \Gamma}$  is a cocycle then the map  $\Gamma \ni \gamma \mapsto \gamma + t_\gamma \in Iso(\mathbb{M}^{n+1})$  is a homomorphism. Hence the homomorphisms of  $\Gamma$  into  $Iso(\mathbb{M}^{n+1})$  whose linear part is the identity are parametrized by the cocycles in  $Z^1(\Gamma, \mathbb{R}^{n+1})$ .

Take two such representations  $\rho$  and  $\rho'$  and let  $(t_\gamma)_{\gamma \in \Gamma}$  and  $(t'_\gamma)_{\gamma \in \Gamma}$  be the respective traslation parts. Suppose now that  $\rho$  and  $\rho'$  are conjugated by some element  $f \in Iso(\mathbb{M}^{n+1})$ . Then we have that the linear part of  $f$  commutes with the elements of  $\Gamma$ . Since the centralizer of  $\Gamma$  in  $SO^+(n, 1)$  is trivial  $f$  is a pure traslation of a vector  $v = f(0)$ . Now by imposing the condition  $\rho'(\gamma) = f\rho(\gamma)f^{-1}$  we obtain that  $t_\gamma - t'_\gamma = \gamma v - v$  so that  $t_\gamma$  and  $t'_\gamma$  differ by a coboundary. Conversely if  $(t_\gamma)_{\gamma \in \Gamma}$  and  $(t'_\gamma)_{\gamma \in \Gamma}$  are cocycles which differ by a coboundary then they induce representations which are conjugated. Hence there is a natural identification between  $\mathcal{R}(\Gamma)$  and the cohomology group  $H^1(\Gamma, \mathbb{R}^{n+1})$ . In what follows we use this identification without mentioning it. In particular for a cocycle  $\tau$  we denote by  $\rho_\tau$  and  $\Gamma_\tau$  respectively the homomorphism corresponding to  $\tau$  and its image.

**Main results.** We can state now the main results of this paper.

**Theorem 2.4** *For every  $[\tau] \in H^1(\Gamma, \mathbb{R}^{n+1})$  there is a unique  $[Y_\tau] \in \mathcal{T}_{Lor}(M)$  represented by a maximal globally hyperbolic future complete spacetime  $Y_\tau$  that admits a pair  $(D, \rho)$  of compatible developing map*

$$D : \tilde{Y}_\tau \rightarrow \mathbb{M}^{n+1}$$

*and holonomy representative*

$$\rho : \pi_1(Y_\tau) \cong \pi_1(M) \rightarrow Iso(\mathbb{M}^{n+1})$$

*such that*

1.  $\rho = \rho_\tau$ .
2.  $D$  is injective and so it is an isometry onto its image  $\mathcal{D}_\tau$  which is a proper convex domain of  $\mathbb{M}^{n+1}$ . Moreover it is a future set (i.e.  $\mathcal{D}_\tau = I^+(\mathcal{D}_\tau)$ ).
3. The action of  $\pi_1(M)$  on  $\mathcal{D}_\tau$  via  $\rho$  is free and properly discontinuous so that the developing map  $D$  induces an isometry between  $Y_\tau$  and  $\mathcal{D}_\tau/\pi_1(M)$ .

4. The spacetime  $\mathcal{D}_\tau$  has a **canonical cosmological time**  $\tilde{T} : \mathcal{D}_\tau \rightarrow \mathbb{R}_+$  which is a  $C^1$ -submersion. Every level surface  $\tilde{S}_a$  is the graph of a proper  $C^1$ -convex function defined over the horizontal hyperplane  $\{x_0 = 0\}$ .
5. The map  $\tilde{T}$  is  $\pi_1(M)$ -equivariant and induces the canonical cosmological time  $T : Y_\tau \rightarrow \mathbb{R}_+$ ; this is a proper  $C^1$ -submersion and every level surface  $S_a = \tilde{S}_a/\pi_1(M)$  is  $C^1$ -diffeomorphic to  $M$ .
6. For every  $p \in \mathcal{D}_\tau$  there exists a unique  $r(p) \in I^-(p) \cap \partial\mathcal{D}_\tau$  such that  $\tilde{T}(p) = d(p, r(p))$ . The map  $r : \mathcal{D}_\tau \rightarrow \partial\mathcal{D}_\tau$  is continuous. The image  $\Sigma_\tau := r(\mathcal{D}_\tau)$  is said the **singularity in the past**.  $\Sigma_\tau$  is spacelike-arc connected and contractile and  $\pi_1(M)$ -invariant. Moreover the map  $r$  is  $\pi_1(M)$ -equivariant.

The map

$$\mathcal{R}(\Gamma) \ni [\rho_\tau] \mapsto [Y_\tau] \in \mathcal{T}_{Lor}(M)$$

is continuous section of the holonomy map.

The same statement holds by replacing “future” with “past”. Let us call  $Y_\tau^-$  and  $\mathcal{D}_\tau^-$  the corresponding spaces.

Every globally hyperbolic flat spacetime with compact spacelike Cauchy surface and holonomy group equal to  $\rho_\tau(\pi_1(M))$  is diffeomorphic to  $M \times \mathbb{R}_+$  and embeds isometrically either into  $Y_\tau$  or into  $Y_\tau^-$ .

In the section 7 we shall study the metric properties of the surfaces  $\tilde{S}_a$ . We look at the asymptotic behaviour of the metrics properties of the action of  $\Gamma$  on  $\tilde{S}_a$  for  $a \rightarrow +\infty$  and for  $a \rightarrow 0$ . In particular we focus on the **Gromov convergence** when  $a \rightarrow +\infty$  and on the convergence of the **marked length spectrum** when  $a \rightarrow 0$  (the definition of these concepts are given in section 7). The principal result that we get is the following.

**Theorem 2.5** *Let  $\tau \in Z^1(\Gamma, \mathbb{R}^{n+1})$  and  $\mathcal{D}_\tau \subset \mathbb{M}^{n+1}$  be the universal cover of  $Y_\tau$ . Let  $\tilde{S}_a$  be the  $CT$  level surface  $\tilde{T}^{-1}(a)$  of  $\mathcal{D}_\tau$  and let  $d_a$  be the natural distance on  $\tilde{S}_a$ . We have that  $\tilde{S}_a$  is a  $\pi_1(M)$ -invariant spacelike surface and  $\pi_1(M)$  acts by isometries on it.*

*When  $a \rightarrow +\infty$  the  $\pi_1(M)$ -action on the rescaled surface  $(\tilde{S}_a, \frac{d_a}{a})$  converges in the Gromov sense to the action of  $\pi_1(M)$  on  $\mathbb{H}^n$ .*

*When  $a \rightarrow 0$  the marked length spectrum of the  $\pi_1(M)$ -action on  $(\tilde{S}_a, d_a)$  converges to the spectrum of the  $\pi_1(M)$ -action on the singularity in the past  $\Sigma$ .*

Now we point out some comments and corollaries.

The following statement is an immediate consequence of theorem 2.4.

**Corollary 2.6** *Let  $F$  be a  $n$ -manifold and suppose that there exists a Lorentzian flat structure on  $\mathbb{R} \times F$  such that  $\{0\} \times F$  is a spacelike surface. Suppose that the holonomy group for such structure is  $\Gamma_\tau$  for some  $\tau \in Z^1(\Gamma, \mathbb{R}^{n+1})$ . Then  $F$  is diffeomorphic to  $M = \mathbb{H}^n/\Gamma$ .*

By studying the action of  $\Gamma_\tau = \rho_\tau(\pi_1(M))$  on the boundary  $\partial\mathcal{D}_\tau$  we shall show that  $\Gamma_\tau$  does not act freely and properly discontinuously on the whole  $\mathbb{M}^{n+1}$ .

On the domain  $\mathcal{D}_\tau$  there is a natural field  $-N$  which is the Lorentzian gradient of the cosmological time  $\tilde{T}$ . We have that  $N$  is a timelike vector, furthermore  $N$  is future directed by

the choice of the sign. Notice that  $N(x)$  is the normal vector to  $\tilde{S}_{\tilde{T}(x)}$  at  $x$ , so that we call it the **normal field**. Under the identification of  $T_x\mathbb{M}^{n+1}$  with  $\mathbb{M}^{n+1}$  it results that  $N(x) \in \mathbb{H}^n$  (in fact it is also called the **Gauss map** of the surfaces  $\tilde{S}_a$ ). The restriction  $N|_{\tilde{S}_a}$  is a surjective and proper map. The map  $N$  is  $\pi_1(M)$ -equivariant so that it induces a map  $\bar{N} : \mathcal{D}_\tau/\Gamma_\tau \rightarrow \mathbb{H}^n/\Gamma$ . For all  $a > 0$  the restriction the of the map  $\bar{N}|_{\tilde{S}_a}$  has degree 1.

When  $n = 2$  it turns out that the singularity  $\Sigma_\tau$  is a *real tree*. Moreover Mess showed that the  $N$ -images of the fibers of the retraction  $r$  produce a  $\Gamma$ -invariant *geodesic lamination*  $L$  of  $\mathbb{H}^2$ . According to Skora's theorem [14]  $L$  is the geodesic lamination dual to the real tree  $\Sigma_\tau$ . More precisely, the complete duality is realized by suitably equipped  $L$  with a transverse measure  $\mu$ . Finally the triple  $(M, L, \mu)$  determines the spacetime  $Y_\tau$ .

In section 4 we shall see that for  $n \geq 2$  the  $N$ -images of the fibers of the retraction  $r$  determine a *geodesic stratification* of  $\mathbb{H}^n$  (we introduce this notion in section 4 and we prove that in dimension  $n = 2$  the geodesic stratifications are the geodesic laminations). Moreover in section 8 we introduce the notion of *measured geodesic stratification* and we show that every measured geodesic stratification enables us to construct a spacetime  $Y_\tau$ . For some technical reasons we are not able, for the moment, to show that this correspondence is bijective. However we present an interesting class of spacetimes: the spacetimes with *simplicial singularity*. In dimension  $n = 2$  these spacetimes have singularity which is a *simplicial tree* and the corresponding geodesic lamination is a multicurve. We shall show that for spacetimes with simplicial singularity the complete duality between singularity and geodesic stratification is realized in very explicit way.

### 3 Construction of $\mathcal{D}_\tau$

Let  $\Gamma$  be a free-torsion co-compact discrete subgroup of  $\text{SO}^+(n, 1)$  and  $M := \mathbb{H}^n/\Gamma$ . Fix  $[\tau] \in \mathbb{H}^1(\Gamma, \mathbb{R}^{n+1})$  and let  $\Gamma_\tau$  be the image of the homomorphism associated with  $\tau$ . Moreover for every  $\gamma \in \Gamma$  we shall denote by  $\gamma_\tau$  the affine transformation  $x \mapsto \gamma(x) + \tau_\gamma$ . In this section we construct a  $\Gamma_\tau$ -invariant future complete convex domain of  $\mathbb{M}^{n+1}$ . Moreover we show that the action of  $\Gamma_\tau$  on this domain is free and properly discontinuous and the quotient is diffeomorphic to  $\mathbb{R}_+ \times M$ .

First let us show that there is a  $C^\infty$ -embedded hypersurface  $\tilde{F}_\tau$  of  $\mathbb{M}^{n+1}$  which is spacelike (i.e.  $T_p\tilde{F}_\tau$  is a spacelike subspace of  $T_p\mathbb{M}^{n+1}$ ) and  $\Gamma_\tau$ -invariant such that the quotient  $\tilde{F}_\tau/\Gamma_\tau$  is diffeomorphic to  $M$ . We start with an easy and useful lemma (see [11]).

**Lemma 3.1** *Let  $S$  be a manifold and  $f : S \rightarrow \mathbb{M}^{n+1}$  be an  $C^r$ -immersion ( $r \geq 1$ ) such that  $f^*\eta$  is a complete Riemannian metric on  $S$ . Then  $f$  is an embedding. Moreover fix orthonormal affine coordinates  $(y_0, \dots, y_n)$ . Then  $f(S)$  is a graph over the horizontal plane  $\{y_0 = 0\}$ .*

*Proof :* In coordinates put  $f(s) = (i_0(s), \dots, i_n(s))$ . Let  $\pi : S \rightarrow \{y_0 = 0\}$  be the canonical projection ( $\pi(s) = (0, i_1(s), \dots, i_n(s))$ ) We have to show that  $\pi$  is a  $C^r$ -diffeomorphism.

Notice that  $\pi$  is a  $C^r$ -map between Riemannian manifold. We claim that  $\pi$  is distance increasing i.e.

$$\langle d\pi(x)[v], d\pi(x)[v] \rangle \geq (f^*\eta)(v, v). \quad (1)$$

The lemma follows easily from the claim: in fact the equation (1) implies that  $\pi$  is a local  $C^r$ -diffeomorphism. Furthermore a classical argument shows that  $\pi$  is path-lifting and so  $\pi$



is a covering map. Since the horizontal plane is simply connected it follows that  $\pi$  is a  $C^r$ -diffeomorphism.

Let us prove the claim. Let  $v \in T_s S$  and let  $df(s)[v] = (v_0, \dots, v_n)$  then we have  $d\pi(s)[v] = (0, v_1, \dots, v_n)$ . Thus

$$f^* \eta(v, v) = \langle d\pi(x)[v], d\pi(x)[v] \rangle - v_0^2.$$

■

**Remark 3.2** Let  $S$  be a  $\Gamma_\tau$ -invariant spacelike hypersurface in  $\mathbb{M}^{n+1}$  such that the action of  $\Gamma_\tau$  on it is free and properly discontinuous. Suppose that  $S/\Gamma_\tau$  is compact. By the Hopf-Rinow theorem we know that  $S$  is complete and so the previous lemma applies.

Now we want to construct a  $\Gamma_\tau$ -invariant spacelike hypersurface  $\tilde{F}_\tau$ . In fact we shall construct  $\tilde{F}_\tau$  in a particular class of spacelike hypersurfaces.

**Def. 3.1** A closed connected spacelike hypersurface  $S$  divides  $\mathbb{M}^{n+1}$  in two components, the future and the past of  $S$ . We say that  $S$  is future convex (resp. past convex) if  $I^+(S)$  (resp.  $I^-(S)$ ) is a convex set and  $S = \partial I^+(S)$  (resp.  $S = \partial I^-(S)$ ). Moreover  $S$  is future strictly convex (resp. past strictly convex) if  $I^+(S)$  (resp.  $I^-(S)$ ) is strictly convex.

**Remark 3.3** The hyperbolic space  $\mathbb{H}^n \subset \mathbb{M}^{n+1}$  is an example of spacelike future strictly convex hypersurface in  $\mathbb{M}^{n+1}$ .

Let  $N_0$  be the flat Lorentz structure on  $[1/2, 3/2] \times M$  given by the standard inclusion  $[1/2, 3/2] \times M \subset \mathcal{C}(M)$  (where  $\mathcal{C}(M)$  is the Minkowskian cone on  $M$ ). Let  $\tilde{N}_0 = \{x \in \mathbb{M}^{n+1} | x \in I^+(0) \text{ and } d(0, x) \in [1/2, 3/2]\}$  be the universal covering of  $N_0$ . The following theorem was stated by Mess ([11]) for the case  $n = 2$ . However his proof runs in all dimensions. We relate it here for sake of completeness.

**Theorem 3.4** If  $U$  is a bounded neighborhood of 0 in  $Z^1(\Gamma, \mathbb{R}^{n+1})$  there exists  $K > 0$  and a  $C^\infty$ -map

$$dev : U \times \tilde{N}_0 \rightarrow \mathbb{M}^{n+1}$$

such that

1. for every  $\sigma \in U$  the map

$$dev_\sigma : \tilde{N}_0 \ni x \mapsto dev(\sigma, x) \in \mathbb{M}^{n+1}$$

is a developing map whose holonomy is the representation associated with  $\sigma$ ;

2.  $dev_0$  is the multiplication by  $K$ ;

3.  $dev_\sigma(\mathbb{H}^n)$  is a strictly convex spacelike hypersurface.

*Proof* : For a Thurston theorem (see [7]) there exists a neighborhood  $U_0$  of 0 in  $Z^1(\Gamma, \mathbb{R}^{n+1})$  and a  $C^\infty$ -map

$$dev' : U_0 \times \tilde{N}_0 \rightarrow \mathbb{M}^{n+1}$$

such that

1. for every  $\sigma \in U_0$  the map  $dev'_\sigma : \tilde{N}_0 \rightarrow \mathbb{M}^{n+1}$  is a developing map whose holonomy is the representation associated with  $\sigma$ ;

2.  $dev'_0$  is the identity.

By using the compactness of  $M$  it is easy to show that if  $U_0$  is chosen sufficiently small then  $dev_\sigma(\mathbb{H}^n)$  is a spacelike future convex hypersurface.

Now fix  $K > 0$  so that  $K \cdot U_0 \supset U$ . Let us define  $dev : U \times \tilde{N}_0 \rightarrow \mathbb{M}^{n+1}$  by the rule

$$dev(\sigma, x) := K dev'(\sigma/K, x) \quad (2)$$

It is straightforward to see that  $dev_\sigma$  is a developing map whose holonomy is the representation associated with  $\sigma$ . Clearly  $dev_0$  is the multiplication by  $K$  and  $dev_\sigma(\mathbb{H}^n) = K \cdot dev'_{\sigma/K}(\mathbb{H}^n)$  is a future convex spacelike surface invariant for  $\Gamma_\sigma$ . ■

Now fix a bounded neighborhood of 0 in  $Z^1(\Gamma, \mathbb{R}^{n+1})$  which contains the cocycle  $\tau$ . Consider the map  $dev$  of the previous theorem and let  $\tilde{F}_\tau$  be the hypersurface  $dev_\tau(\mathbb{H}^n)$ . Then  $\tilde{F}_\tau$  is a  $\Gamma_\tau$ -invariant future strictly convex spacelike hypersurface such that the  $\Gamma_\tau$ -action on it is *free and properly discontinuous* and  $\tilde{F}_\tau/\Gamma_\tau \cong M$ . Clearly in the same way we can obtain a  $\Gamma_\tau$ -invariant spacelike hypersurface  $\tilde{F}_\tau^-$  which is *past* strictly convex such that  $\tilde{F}_\tau^-/\Gamma_\tau \cong M$ .

Now given a hypersurface  $\tilde{F}$  we construct a natural domain  $D(\tilde{F})$  which includes it. Furthermore we show that if  $\tilde{F}$  is  $\Gamma_\tau$ -invariant and the action on  $\tilde{F}$  is free and properly discontinuous then the same holds for  $D(\tilde{F})$ .

**Def. 3.2** *Given a spacelike hypersurface  $\tilde{F}$  the **domain of dependence** of  $\tilde{F}$  is the set  $D(\tilde{F})$  of the points  $p \in \mathbb{M}^{n+1}$  such that all inextendable causal curves which pass through  $p$  intersect  $\tilde{F}$ .*

The following is a well known result (for instance see [8]).

**Proposition 3.5** *The domain of dependence  $D(\tilde{F})$  is open. Moreover if  $\tilde{F}$  is complete (i.e. the natural Riemannian structure on it is complete) then a point  $p \in \mathbb{M}^{n+1}$  lies in  $D(\tilde{F})$  if and only if each null line which passes through  $p$  intersects  $\tilde{F}$ .* ■

**Proposition 3.6** *Let  $\tilde{F}$  be a complete spacelike  $C^1$ -hypersurface. Let  $p \notin D(\tilde{F})$  and  $v$  be a null vector such that the line  $p + \mathbb{R}v$  does not intersect  $\tilde{F}$ . Then the null plane  $P = p + v^\perp$  does not intersect  $\tilde{F}$ .*

*Proof :* Suppose that  $S := \tilde{F} \cap P$  is not empty. Since this intersection is transverse it follows that it is a closed  $(n-1)$ -submanifold of  $\tilde{F}$  and so it is complete.

Fix a set of orthonormal affine coordinates  $(y_0, \dots, y_n)$  such that  $p$  is the origin and  $P = \{y_0 = y_1\}$  (i.e.  $v = (1, 1, 0, \dots, 0)$ ). Consider the map

$$\pi : S \ni (y_0, y_1, \dots, y_n) \rightarrow (0, 0, y_2, \dots, y_n) \in \{y_0 = y_1 = 0\}.$$

As well as in the proof of lemma 3.1 we argue that  $\pi$  is a diffeomorphism. Thus there exists  $s \in \mathbb{R}$  such that  $q = (s, s, 0, \dots, 0) \in \tilde{F}$ . But  $q$  lies on the line  $p + \mathbb{R}v$  and this is a contradiction. ■

**Corollary 3.7** *Let  $\tilde{F}$  be a complete spacelike hypersurface. The domain of dependence  $D(\tilde{F})$  is a convex set. Moreover for every  $p \notin D(\tilde{F})$  there exists a null plane through  $p$  which is a support plane for  $D(\tilde{F})$ .*

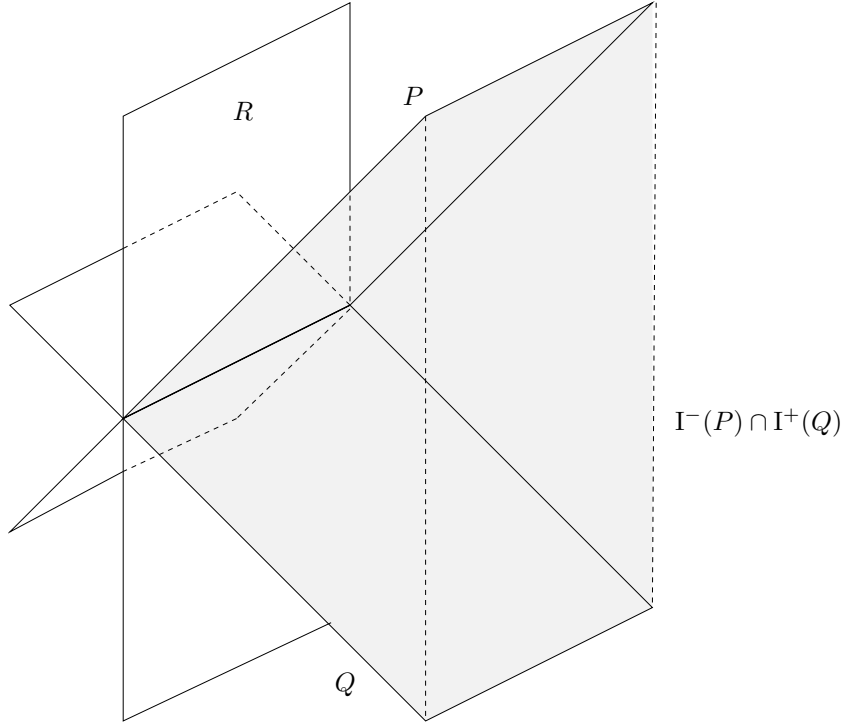

Figure 1: If  $P$  and  $Q$  are not parallel there exists a timelike support plane

Suppose that  $\tilde{F}$  is  $\Gamma_\tau$ -invariant and  $D(\tilde{F})$  is not the whole  $\mathbb{M}^{n+1}$  then either

$$D(\tilde{F}) = \bigcap_{\substack{P \text{ null plane} \\ P \cap \tilde{F} = \emptyset}} I^+(P) \quad \text{or}$$

$$D(\tilde{F}) = \bigcap_{\substack{P \text{ null plane} \\ P \cap \tilde{F} = \emptyset}} I^-(P).$$

Thus  $D(\tilde{F})$  is a future or past set (i.e.  $D(\tilde{F}) = I^+(D(\tilde{F}))$  or  $D(\tilde{F}) = I^-(D(\tilde{F}))$ ).

*Proof* : The proposition 3.6 implies that for every  $p \notin D(\tilde{F})$  there exists a null plane  $P$  which passes through  $p$  and does not intersect  $D(\tilde{F})$ . Thus  $D(\tilde{F})$  is a convex set.

Suppose now that  $\tilde{F}$  is  $\Gamma_\tau$ -invariant and suppose that  $D(\tilde{F})$  is not the whole  $\mathbb{M}^{n+1}$ . We have to show that either  $D(\tilde{F})$  is contained in the future of the null support planes or it is contained in the past of the null support planes. Suppose by contradiction that there exist null support planes  $P$  and  $Q$  such that  $D(\tilde{F}_\tau) \subset I^-(P) \cap I^+(Q)$ . First suppose that  $P$  and  $Q$  are not parallel. Then there exists a timelike support plane  $R$  (see fig.1). Fix now an affine coordinates system  $(y_0, \dots, y_n)$  such that  $R = \{y_n = 0\}$ . By lemma 3.1 we know that  $\tilde{F}$  is a graph of a function defined on the horizontal plane  $\{y_0 = 0\}$ . Then  $\tilde{F} \cap R \neq \emptyset$  and this is a contradiction.

Suppose now that we cannot choose non-parallel  $P$  and  $Q$ . Then it follows that null tangent planes are all parallel. Thus let  $v$  be the null vector orthogonal to all null tangent planes and  $[v]$  the corresponding point on  $\partial\mathbb{H}^n$ . Since we have that  $\Gamma_\tau$  acts on  $\tilde{F}$  we have that  $\Gamma_\tau$  permutes

the null support planes of  $D(\tilde{F})$ . It follows that  $\Gamma \cdot [v] = [v]$ . But  $\Gamma$  is a discrete co-compact group and so it does not fix any point in  $\mathbb{H}^n$ . ■

**Remark 3.8** The completeness of  $\tilde{F}$  is an essential hypothesis. For instance the domain of dependence of  $\tilde{F} - p$  is not convex.

**Remark 3.9** If  $\tilde{F}$  is future (past) convex then  $D(\tilde{F})$  is future (past) complete.

**Proposition 3.10** *Let  $\tilde{F}$  be a  $\Gamma_\tau$ -invariant spacelike hypersurface such that the  $\Gamma_\tau$ -action on it is free and properly discontinuous. Then  $\Gamma_\tau$  acts freely and properly discontinuously on the whole  $D(\tilde{F})$ . Moreover  $D(\tilde{F})/\Gamma_\tau$  is diffeomorphic to  $\mathbb{R}_+ \times \tilde{F}/\Gamma_\tau$ .*

*Proof :* Since  $\Gamma_\tau$  is torsion free it is sufficient to show that the action is properly discontinuous.

Let  $K, H \subset D(\tilde{F})$  be compact sets. We have to show that the set  $\Gamma(K, H) = \{\gamma \in \Gamma \mid \gamma_\tau(K) \cap H \neq \emptyset\}$  is finite. By using proposition 3.5 we get that the sets  $C = (J^+(K) \cup J^-(K)) \cap \tilde{F}$  and  $D = (J^+(H) \cup J^-(H)) \cap \tilde{F}$  are compact. Furthermore  $\gamma_\tau(C) = (J^+(\gamma_\tau(K)) \cup J^-(\gamma_\tau(K))) \cap \tilde{F}$ . Thus  $\Gamma(K, H)$  is contained in  $\Gamma(C, D)$ . Since the action of  $\Gamma_\tau$  on  $\tilde{F}$  is properly discontinuous we have that  $\Gamma(C, D)$  is finite.

Notice that  $\tilde{F}/\Gamma_\tau$  is a Cauchy surface in  $D(\tilde{F})/\Gamma_\tau$  and thus  $D(\tilde{F})/\Gamma_\tau \cong \mathbb{R}_+ \times \tilde{F}/\Gamma_\tau$ . ■

We have constructed a  $\Gamma_\tau$ -invariant future convex hypersurface  $\tilde{F}_\tau$  such that  $\tilde{F}_\tau/\Gamma_\tau \cong M$ . Now consider  $D(\tilde{F}_\tau)$ . We know that it is a  $\Gamma_\tau$ -invariant future complete convex set and  $D(\tilde{F}_\tau)/\Gamma_\tau \cong \mathbb{R}_+ \times M$ . From now on we denote  $D(\tilde{F}_\tau)$  by  $\mathcal{D}_\tau$ .

Notice we can also consider the domain of dependence of  $\tilde{F}_\tau^-$ . In the same way we can show that  $D(\tilde{F}_\tau^-)$  is  $\Gamma_\tau$ -invariant, past complete convex domain of  $\mathbb{M}^{n+1}$  and  $D(\tilde{F}_\tau^-)/\Gamma_\tau \cong \mathbb{R}_+ \times M$ . We shall denote it by  $\mathcal{D}_\tau^-$ .

In the remaining part of this section we prove that  $\mathcal{D}_\tau$  is not the whole  $\mathbb{M}^{n+1}$ . This is a necessary condition for  $\mathcal{D}_\tau$  to have regular cosmological time. In the next section we shall see that this condition is in fact sufficient. In order to prove that  $\mathcal{D}_\tau$  is a proper subset we need some geometric properties of the  $\Gamma_\tau$ -invariant future convex sets.

**Lemma 3.11** *Let  $\Omega$  be a proper convex set of  $\mathbb{M}^{n+1}$ . Fix a set of orthonormal affine coordinates  $(y_0, \dots, y_n)$  then  $\Omega$  is a future convex set if and only if  $\partial\Omega$  is the graph on the horizontal plane  $\{y_0 = 0\}$  of a 1-Lipschitz convex function.*

*Proof :* The *if* part is quite evident. Hence suppose that  $\Omega$  is a proper future convex set. First let us show that the projection on the horizontal plane  $\pi : \partial\Omega \rightarrow \{y_0 = 0\}$  is a homeomorphism. Since  $\partial\Omega$  is a topological manifold it is sufficient to show that the projection is bijective. Since  $\Omega$  is a future set we have that two points on  $\partial\Omega$  are not chronological related and so the projection is injective.

It remains to show that given  $(a_1, \dots, a_n)$  there exists  $a_0$  such that  $(a_0, a_1, \dots, a_n) \in \partial\Omega$ . Fix  $p \in \partial\Omega$ . It is easy to see that there exist  $a_+$  and  $a_-$  such that  $(a_+, a_1, \dots, a_n) \in I^+(p)$  and  $(a_-, a_1, \dots, a_n) \in I^-(p)$ . Since  $I^+(p) \subset \Omega$  and  $I^-(p) \cap \Omega = \emptyset$  there exists  $a_0$  such that  $(a_0, \dots, a_n) \in \partial\Omega$ .

It follows that  $\partial\Omega$  is the graph of a function  $f$ . Since  $\Omega$  is future convex we have that  $f$  is convex. Since two points on  $\partial\Omega$  are not chronological related we have that  $f$  is 1-Lipschitz. ■

**Lemma 3.12** *Let  $\Omega$  be a  $\Gamma_\tau$ -invariant proper future convex set. Then for every  $u \in \mathbb{H}^n$  there exists a plane  $P = p + u^\perp$  such that  $\Omega \subset I^+(P)$ .*

*Proof* : Consider the set  $K$  of the vectors  $v$  in  $\mathbb{M}^{n+1}$  which are orthogonal to some support plane of  $\Omega$ . Clearly  $K$  is a convex cone with apex in 0. Since  $\Omega$  is future complete it is easy to see that the vectors in  $K$  are not spacelike. So that the projection  $\mathbb{P}K$  of  $K$  in  $\mathbb{P}^n$  is a convex subset of  $\overline{\mathbb{H}^n}$ . Since  $\Omega$  is  $\Gamma_\tau$ -invariant  $K$  is  $\Gamma$ -invariant. Then  $\mathbb{P}K$  is a  $\Gamma$ -invariant convex set of  $\overline{\mathbb{H}^n}$ . Since it is not empty (there exists at least a support plane) and  $\Gamma$  is co-compact then  $K$  contains the whole  $\mathbb{H}^n$  and the lemma follows. ■

**Lemma 3.13** *Let  $\Omega$  be as in the last lemma. For each timelike vector  $v$  the function*

$$\partial\Omega \ni x \mapsto \langle x, v \rangle \in \mathbb{R}$$

*is proper. If  $v$  is future directed  $\lim_{x \in \partial\Omega, x \rightarrow \infty} \langle x, v \rangle = -\infty$  (we mean by  $\infty$  the point of the Alexandroff compactification of  $\partial\Omega$ ).*

*Moreover there exists a unique support plane  $P_v$  of  $\Omega$  such that it is orthogonal to  $v$  and  $P_v \cap \partial\Omega \neq \emptyset$ .*

*Proof* : Fix a timelike vector  $v$ . Clearly we can suppose that  $v$  is future directed and  $\langle v, v \rangle = -1$ . Fix a set of orthonormal affine coordinates  $(y_0, \dots, y_n)$  with the origin in 0 and such that  $\frac{\partial}{\partial y_0} = v$ . Notice that  $\langle x, v \rangle = -y_0(x)$ . Now since  $\Omega$  is future complete then the boundary  $\partial\Omega$  is graph of a convex function  $f : \{y_0 = 0\} \rightarrow \mathbb{R}$ .

We have to show that  $f$  is proper and  $\lim_{x \rightarrow \infty} f(x) = +\infty$ . Thus it is sufficient to show that the set  $K_C = \{x | f(x) \leq C\}$  is compact for every  $C \in \mathbb{R}$ . Since  $f$  is convex  $K_C$  is a closed convex subset of  $\{y_0 = 0\}$ . Suppose by contradiction that it is not compact. It is easy to see that there exists  $\bar{x} \in \{y_0 = 0\}$  and a horizontal vector  $w$  such that the ray  $\{\bar{x} + tw | t \geq 0\}$  is contained in  $K_C$ .

We can suppose  $\langle w, w \rangle = 1$  so that the vector  $u = \sqrt{2}v + w$  is timelike  $\langle u, u \rangle = -1$ . Lemma 3.12 implies that there exists  $M \in \mathbb{R}$  such that  $\langle p, u \rangle \leq M$  for all  $p \in \partial\Omega$ . On the other hand let  $p_t = (\bar{x} + tw) + f(\bar{x} + tw)v$ . We have  $p_t \in \partial\Omega$  and

$$\langle p_t, u \rangle = -\sqrt{2}f(q + tw) + \langle q + tw, q + tw \rangle \geq -\sqrt{2}C + \langle q + tw, q + tw \rangle.$$

Since  $\langle q + tw, q + tw \rangle \rightarrow +\infty$  we get a contradiction. ■

**Proposition 3.14** *Let  $\Omega$  be a  $\Gamma_\tau$ -invariant future complete convex proper subset of  $\mathbb{M}^{n+1}$ . Then there exists a null support plane of  $\Omega$ .*

*Proof* : Take  $q \in \partial\Omega$  and  $v \in \mathbb{H}^n$  such that  $P = q + v^\perp$  is a support plane in  $x$ . Fix  $\gamma \in \Gamma$  and consider the sequence of support planes  $P_k := \gamma_\tau^k(P)$ . If this sequence does not escape to the infinity there is a subsequence which converges to a support plane  $Q$ . The normal direction of  $Q$  is the limit of the normal directions of  $P_k$ . On the other hand the normal direction of  $P_k$  is the direction of  $\gamma^k(v)$ . Since in the projective space  $[\gamma^k(v)]$  tends to a null direction we have that  $Q$  is a null support plane.

Thus we have to prove that  $P_k$  does not escape to the infinity. Let  $v_k = |\langle v, \gamma^k v \rangle|^{-1} \gamma^k v$ . We know that  $v_k$  converges to an attractor eigenvector of  $\gamma$  in  $\mathbb{M}^{n+1}$ . On the other hand we have

$$P_k = \{x \in \mathbb{M}^{n+1} | \langle x, v_k \rangle \leq \langle \gamma_\tau^k q, v_k \rangle\}.$$

Thus the sequence  $P_k$  does not escape to the infinity if and only if the coefficients  $C_k = \langle \gamma_\tau^k q, v_k \rangle$  are bounded. Since  $\{v_k\}$  is relatively compact in  $\mathbb{M}^{n+1}$  it is sufficient to show that the coefficients

$$C'_k := \langle \gamma_\tau^k q - q, v_k \rangle$$

are bounded. For  $\alpha \in \Gamma$  let  $z(\alpha) = \alpha_\tau(q) - q$ . It is easy to see that  $z$  is a cocycle (and in fact the difference  $z(\alpha) - \tau_\alpha = \alpha q - q$  is a coboundary). Thus we have

$$\begin{aligned} C'_k &= \left| \frac{\langle z(\gamma^k), \gamma^k v \rangle}{\langle \gamma^k v, v \rangle} \right| = \left| \frac{\langle \gamma^{-k} z(\gamma^k), v \rangle}{\langle \gamma^k v, v \rangle} \right| = \\ &= \left| \frac{\langle z(\gamma^{-k}), v \rangle}{\langle \gamma^k v, v \rangle} \right|. \end{aligned} \quad (3)$$

Now let  $\lambda > 1$  by the maximum eigenvalue of  $\gamma$ . Denote by  $\|\cdot\|$  the euclidean norm of  $\mathbb{R}^{n+1}$ . Then we have that  $\|\gamma^{-1}(x)\| \leq \lambda\|x\|$  for every  $x \in \mathbb{R}^{n+1}$ . Since  $z(\gamma^{-k}) = -\sum_{i=1}^k \gamma^{-i}(z(\gamma))$  it follows that  $\|z(\gamma^{-k})\| \leq K\lambda^k$  for some  $K > 0$ . Thus we have that  $|\langle z(\gamma^{-k}), v \rangle| \leq K'\lambda^k$  (in fact we have  $|\langle x, y \rangle| \leq \|x\|\|y\|$ ).

On the other hand let  $v = x^+ + x^- + x^0$  where  $x^+$  is eigenvector for  $\lambda$  and  $x^-$  is eigenvector for  $\lambda^{-1}$  and  $x^0$  is in the orthogonal of  $\text{Span}(x^+, x^-)$ . Since  $v$  is future directed timelike vector it turns out that  $x^+$  and  $x^-$  are future directed. Thus we have

$$\langle \gamma^k v, v \rangle = (\lambda^k + \lambda^{-k}) \langle x^+, x^- \rangle + \langle x^0, \gamma^k x^0 \rangle.$$

Now notice that  $\text{Span}(x^+, x^-)^\perp$  is spacelike and  $\gamma$ -invariant. We deduce that  $\langle x^0, \gamma^k x^0 \rangle \leq \langle x_0, x_0 \rangle$  so that there exists  $M > 0$  such that  $|\langle \gamma^k v, v \rangle| > M\lambda^k$ . Thus  $|C'_k| \leq K'/M$  and this concludes the proof. ■

Now we can easily prove that  $\mathcal{D}_\tau$  is not the whole  $\mathbb{M}^{n+1}$ .

**Corollary 3.15** *Let  $\tilde{F}$  be a  $\Gamma_\tau$ -invariant future convex spacelike hypersurface. Then there is a null support plane which does not intersect  $\tilde{F}$ . Hence  $D(\tilde{F}) \neq \mathbb{M}^{n+1}$ .*

*Proof :* Take  $\Omega = I^+(\tilde{F})$  and use proposition 3.14. ■

In dimension  $n + 1 = 4$  there is an easier argument to prove that  $\mathcal{D}_\tau \neq \mathbb{M}^{n+1}$ . Notice that if 1 is not an eigenvalue for some  $\gamma \in \Gamma$  then the transformation  $\gamma_\tau$  has a fixed point, namely  $z := (\gamma - 1)^{-1}(\tau_\gamma)$ . Generally we say that  $\gamma \in \text{SO}^+(3, 1)$  is *loxodromic* if  $\gamma - 1$  is invertible. So that if  $\Gamma$  contains a loxodromic element then  $\Gamma_\tau$  does not acts freely on  $\mathbb{M}^{3+1}$  (and in particular  $\mathbb{M}^{3+1}$  does not coincides with  $\mathcal{D}_\tau$ ).

**Lemma 3.16** *Let  $\Gamma$  be a discrete cocompact subgroup of  $\text{SO}^+(3, 1)$ . There exists a loxodromic element  $\gamma \in \Gamma$ .*

*Proof :* We use the identification  $\text{SO}^+(3, 1) \cong \text{Iso}(\mathbb{H}^3) \cong \text{PSL}(2, \mathbb{C})$ . A hyperbolic element  $\gamma \in \text{PSL}(2, \mathbb{C})$  is not loxodromic if and only if  $\text{tr}\gamma \in \mathbb{R}$ . Hence suppose by contradiction that every hyperbolic  $\gamma \in \Gamma$  has real trace.

Fix a hyperbolic element  $\gamma_0 \in \Gamma$ . Up to coniugacy we can suppose

$$\gamma_0 = \begin{bmatrix} \lambda & 0 \\ 0 & \lambda^{-1} \end{bmatrix}$$

with  $\lambda \in \mathbb{R}_+$ . Moreover we can suppose that  $\gamma_0$  is a generator of the stabilizer of the axis  $l_0$  with endpoints 0 and  $\infty$ . Now let  $\alpha$  be a generic element of  $\Gamma$

$$\alpha = \begin{bmatrix} a & b \\ c & d \end{bmatrix}.$$

By general facts on Kleinian groups we know that either  $\alpha$  fix the geodesic  $l_0$  or it does not fix 0 nor  $\infty$ . We deduce that either  $b = c = 0$  or  $bc \neq 0$ . Suppose  $\alpha \notin \text{stab}(l_0)$ . By imposing  $\text{tr} \alpha \in \mathbb{R}$  and  $\text{tr}(\gamma_0 \alpha) \in \mathbb{R}$  we obtain

$$\begin{aligned} a + d &\in \mathbb{R}; \\ \lambda a + \lambda^{-1} d &\in \mathbb{R}. \end{aligned}$$

Thus  $a, d \in \mathbb{R}$ . Since  $ad - bc = 1$  we can write

$$\alpha = \begin{bmatrix} A & B e^{i\theta} \\ C e^{-i\theta} & D \end{bmatrix}$$

with  $A, B \in \mathbb{R}$ ,  $C, D \in \mathbb{R} - \{0\}$  and  $\theta \in [0, \pi)$ .

Now let  $\beta \in \Gamma - \text{stab}(l_0)$

$$\beta = \begin{bmatrix} A' & B' e^{i\theta'} \\ C' e^{-i\theta'} & D' \end{bmatrix}.$$

The first entry of  $\alpha\beta$  is  $AA' + BC'e^{i(\theta-\theta')}$ . If we impose that it is real we deduce that  $\theta = \theta'$  (notice that  $BC' \neq 0$ ). So there exists a  $\theta_0$  such that for every  $\gamma \in \Gamma - \text{stab}(l_0)$

$$\gamma = \begin{bmatrix} A & B e^{i\theta_0} \\ C e^{-i\theta_0} & D \end{bmatrix}$$

with  $A, B, C, D \in \mathbb{R}$ . Hence the rotation  $R_{-\theta_0}$  conjugates  $\Gamma$  in  $PSL(2, \mathbb{R})$  and so  $\Gamma$  is Fuchsian. But this is a contradiction. ■

## 4 The Cosmological Time and the Singularity in the Past

In this section we shall see that the cosmological time on  $\mathcal{D}_\tau/\Gamma_\tau$  is regular and the level surfaces are homeomorphic to  $M$ . Furthermore we study the boundary of  $\mathcal{D}_\tau$  and we shall see that it determines a *geodesic stratification* in  $M$ . If  $n = 2$  this stratification is in fact the geodesic lamination which Mess associated with  $\tau$ .

We study the geometry of a general class of domain of  $\mathbb{M}^{n+1}$ , the **regular convex domain**. We shall see that  $\mathcal{D}_\tau$  is  $\Gamma_\tau$ -invariant regular convex domain. The most results of this section are quite general and we do not use the action of the group  $\Gamma_\tau$ . We shall see that every regular domain  $\Omega$  is provided with a regular **cosmological time**  $T$ , a **retraction**  $r$  on the **singularity in the past**, and a **normal field**  $N : \Omega \rightarrow \mathbb{H}^n$  which is (up to the sign) the Lorentzian gradient of  $T$ . Moreover if the domain is  $\Gamma_\tau$ -invariant then all these objects are  $\Gamma_\tau$ -invariant. Finally we see that if the normal field is surjective (this is the case for instance if the domain is  $\Gamma_\tau$ -invariant) then the images in  $\mathbb{H}^n$  of the fibers of the retraction give a *geodesic stratification*. This stratification is  $\Gamma$ -invariant if  $\Omega$  is  $\Gamma_\tau$ -invariant.

**Def. 4.1** Let  $\Omega \subset \mathbb{M}^{n+1}$  be a nonempty convex open set. We say that  $\Omega$  is a future complete (resp. past complete) regular convex domain if there exists a family of null support planes  $\mathcal{F}$  which contains at least 2 non-parallel planes and such that

$$\Omega = \bigcap_{P \in \mathcal{F}} I^+(P) \quad (\text{resp. } \Omega = \bigcap_{P \in \mathcal{F}} I^-(P)).$$

**Remark 4.1** The condition that there exists at least 2 non-parallel planes escludes that  $\Omega$  is the whole  $\mathbb{M}^{n+1}$  or that  $\Omega$  is the future of a null plane. These domains have not regular cosmological times. On the other hand if there exists at least 2 non-parallel null support planes there exists a spacelike support plane and we shall see that this condition assure the existence of a regular cosmological time.

**Remark 4.2** Let  $\tilde{F}$  be a  $\Gamma_\tau$ -invariant future convex complete spacelike hypersurface. By corollary 3.7 we know that  $D(\tilde{F})$  is the intersection of either the future or the past of its null support planes. By 3.14 it results that  $D(\tilde{F})$  is not the whole  $\mathbb{M}^{n+1}$ . Finally proposition 3.12 assure us that there exist spacelike support planes. It follows that  $D(\tilde{F})$  is a future complete regular domain. In particular  $\mathcal{D}_\tau$  is a future complete regular domain

On the other hand we shall see that if  $\Omega$  is a  $\Gamma_\tau$ -invariant regular domain, then the cosmological time  $T_\Omega$  is regular and  $\Omega = D(\tilde{S}_a)$  where  $\tilde{S}_a$  is the level surface  $T_\Omega^{-1}(a)$ . Moreover we shall prove that  $\tilde{S}_a$  is a  $\Gamma_\tau$ -invariant spacelike complete hypersurface. Thus we have that  $\Gamma_\tau$ -invariant regular domains are domains of dependence of some  $\Gamma_\tau$ -invariant future convex complete spacelike hypersurface.

We want to describe the cosmological time on  $\mathcal{D}_\tau$  and in general on a future complete regular domain. First we show that every future complete convex set *which has at least a spacelike support plane* has a regular cosmological time which is a  $C^1$ -function.

**Proposition 4.3** Let  $A$  be a future complete convex subset of  $\mathbb{M}^{n+1}$  and  $S = \partial A$ . Suppose that there exists a spacelike support plane. Then for every  $p \in A$  there exists a unique  $r(p) \in S$  which maximizes the Lorentzian distance in  $\overline{A} \cap J^-(p)$ . Moreover the map  $p \mapsto r(p)$  is continuous.

The point  $r = r(p)$  is the unique point in  $S$  such that the plane  $r + (p - r)^\perp$  is a support plane for  $A$ .

The cosmological time of  $A$  is expressed by the formula

$$T(p) = \sqrt{-\langle p - r(p), p - r(p) \rangle}.$$

It is  $C^1$  and  $-T$  is convex. The Lorentzian gradient of  $T$  is given by the formula

$$\nabla_L T(p) = -\frac{1}{T(p)} (p - r(p)).$$

*Proof* : Since  $A$  is convex the Lorentzian distance in  $A$  is the restriction of the Lorentzian distance in  $\mathbb{M}^{n+1}$ , that is

$$d(p, q) = \sqrt{-\langle p - q, p - q \rangle} \quad \text{for every } q \in A \text{ and } p \in I^+(A).$$

Fix  $p \in A$  and let  $P$  be a spacelike support plane of  $A$ . Notice that  $J^-(p) \cap J^+(P)$  is compact and  $J^-(p) \cap A \subset J^-(p) \cap J^+(P)$ . Thus there exists a point  $r \in \overline{A} \cap J^-(p)$  which maximize the Lorentzian distance from  $p$ . Clearly  $r$  lies into the boundary  $S$ .



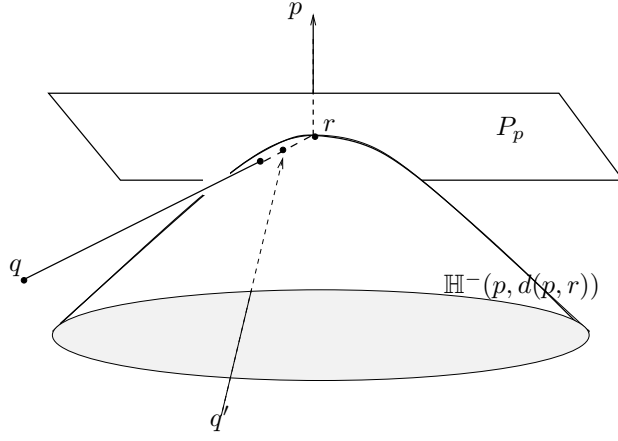

Figure 2:  $P_p$  is a support plane for  $A$ .

Now we have to show that  $r$  is unique. Let us define

$$\mathbb{H}^-(p, \alpha) = \{x \in I^-(p) \mid d(p, x) = \alpha\}.$$

We know that  $\mathbb{H}^-(p, d(p, r))$  is a past convex spacelike surface. Let  $r' \in \mathbb{H}^-(p, d(p, r)) \cap S - \{r\}$ , the segment  $(r, r')$  is contained in  $I^-(\mathbb{H}^-(p, d(p, r)))$  so that for every  $s \in (r, r')$  it turns out that  $d(p, s) > d(p, r)$ . On the other hand we have that  $(r, r') \in \bar{A}$  and this contradicts the choice of  $r$ .

We have to see that the map  $p \mapsto r(p)$  is continuous. Let  $p_k \in A$  such that  $p_k \rightarrow p \in A$  and let  $r_k = r(p_k)$ . First let us show that  $\{r_k\}_{k \in \mathbb{N}}$  is bounded. Let  $q \in I^+(p)$ , notice that there exists  $k_0$  such that  $p_k \in J^-(q)$  for every  $k \geq k_0$ , so that  $r_k \in J^-(q) \cap S$  for  $k \geq k_0$ . Since  $J^-(q) \cap S$  is compact we deduce that  $\{r_k\}$  is contained in a compact subset of  $S$ . Hence it is sufficient to prove that if  $r_k \rightarrow r$  then  $r = r(p)$ . Let  $q \in A$  then we have  $\langle p_k - r_k, p_k - r_k \rangle \leq \langle p_k - q, p_k - q \rangle$ . By passing to the limit we obtain that  $r$  maximizes the Lorentz distance.

Let  $p \in A$  and  $P_p$  be the plane  $r(p) + (p - r(p))^\perp$ . We claim that  $P_p$  is a support plane for  $A$ . In fact notice that  $P_p$  is the tangent plane of the set  $\mathbb{H}^-(p, d(p, r))$  at the point  $r(p)$ . Suppose that there exists  $q \in A \cap I^-(P_p)$ : we have  $(q, r) \subset A$ . On the other hand we have that there exists  $q' \in (q, r) \cap I^-(\mathbb{H}^-(p, d(p, r)))$  (see fig.2). Then  $d(p, q') > d(p, r)$  and this is a contradiction. Conversely let  $s \in A$  such that  $s + (p - s)^\perp$  is a support plane for  $A$ . An analogous argument shows that  $s$  is in the past of  $p$  and maximizes the Lorentzian distance.

Now we can prove that the cosmological time  $T$  is  $C^1$ . We shall use the following elementary fact:

Let  $\Omega \subset \mathbb{R}^N$  be an open set, and  $f : \Omega \rightarrow \mathbb{R}$ . Suppose that there exists  $f_1, f_2 : \Omega \rightarrow \mathbb{R}$  such that:

1.  $f_1 \leq f \leq f_2$ ;
2.  $f_1(x_0) = f_2(x_0) = f(x_0)$ ;
2.  $f_1$  and  $f_2$  are  $C^1$  and  $df_1(x_0) = df_2(x_0)$ .

Then  $f$  is differentiable in  $x_0$  and  $df(x_0) = df_1(x_0)$ .

Let  $p \in A$  and  $r = r(p)$ ; fix a set of orthonormal affine coordinates  $(y_0, \dots, y_n)$  such that the origin is  $r(p)$  and  $P_p$  is the plane  $\{y_0 = 0\}$  (so that the point  $p$  has coordinates  $(\mu, 0, \dots, 0)$ ).

Consider the functions  $f_1 : A \ni y \mapsto +y_0^2 - \sum_{i=1}^n y_i^2 \in \mathbb{R}$  and  $f_2 : A \ni y \mapsto y_0^2 \in \mathbb{R}$ . It is straightforward to recognize that  $f_1 \leq T^2 \leq f_2$  and  $f_1(p) = T^2(p) = f_2(p)$ . Moreover we have  $\nabla_L f_1(p) = -2\frac{\partial}{\partial y_0} = \nabla_L f_2(p)$ . It turns out that  $T^2$  is differentiable in  $p$  and  $\nabla_L(T^2) = -2(p-r)$ . Thus  $T$  is differentiable in  $p$  and  $\nabla_L T(p) = -\frac{1}{T(p)}(p-r)$ .

Finally let us show that  $-T$  is convex. Let  $\varphi(p) := -T^2(p) = \langle p-r(p), p-r(p) \rangle$ . We have to show that

$$-\varphi(tp + (1-t)q) \geq \left( t\sqrt{-\varphi(p)} + (1-t)\sqrt{-\varphi(q)} \right)^2 \quad \text{for all } p, q \in A \text{ and } t \in [0, 1]. \quad (4)$$

Since  $tr(p) + (1-t)r(q) \in A$  we have by the definition of  $r$  that

$$\begin{aligned} -\varphi(tp + (1-t)q) &\geq \\ &\geq -\langle (tp + (1-t)q) - (tr(p) + (1-t)r(q)), (tp + (1-t)q) - (tr(p) + (1-t)r(q)) \rangle = \\ &= -\langle t(p-r(p)) + (1-t)(q-r(q)), t(p-r(p)) + (1-t)(q-r(q)) \rangle = \\ &= -\left( t^2\varphi(p) + (1-t)^2\varphi(q) + 2t(1-t)\langle p-r(p), q-r(q) \rangle \right). \end{aligned}$$

Since  $p-r(p)$  and  $q-r(q)$  are future directed timelike vectors we have that  $\langle p-r(p), q-r(q) \rangle \leq -\sqrt{\varphi(p)\varphi(q)}$  so that we have

$$\begin{aligned} -\varphi(tp + (1-t)q) &\geq \left( t^2(-\varphi(p)) + (1-t)^2(-\varphi(q)) + 2t(1-t)\sqrt{\varphi(p)\varphi(q)} \right) = \\ &= \left( t\sqrt{-\varphi(p)} - (1-t)\sqrt{-\varphi(q)} \right)^2. \end{aligned}$$

■

**Corollary 4.4** *We use the notation of proposition 4.3. For all  $(p_k)_{k \in \mathbb{N}} \subset A$  such that  $p_k \rightarrow \bar{p} \in \partial A$  we have*

$$\lim_{k \rightarrow +\infty} T(p_k) = 0.$$

*Proof :* Let  $q \in I^+(\bar{p})$ , it is easy to see that  $p_k \in I^+(q)$  for all  $k \gg 0$ . By arguing as in proposition 4.3 we see that  $\{r(p_k)\}$  is a bounded set. Up to passing to a subsequence we can suppose that  $r(p_k) \rightarrow \bar{r}$ . Since  $p_k - r(p_k)$  is a timelike vector,  $\bar{p} - \bar{r}$  is a non-spacelike vector. On the other hand since  $S$  is achronal set we get that  $\bar{p} - \bar{r}$  is null vector. Since  $T^2(p_k) = -\langle p_k - r(p_k), p_k - r(p_k) \rangle$  we get  $\lim_{k \rightarrow +\infty} T^2(p_k) = -\langle \bar{p} - \bar{r}, \bar{p} - \bar{r} \rangle = 0$ .

■

**Corollary 4.5** *With the above notation let  $\tilde{S}_a = T^{-1}(a)$  for  $a > 0$ . Then we have that  $\tilde{S}_a$  is a future convex spacelike hypersurface and  $T_p \tilde{S}_a = (p-r(p))^\perp$  for all  $p \in \tilde{S}_a$ .*

*We have that  $I^+(\tilde{S}_a) = \bigcup_{b>a} \tilde{S}_b$ . Moreover let  $r_a : I^+(\tilde{S}_a) \rightarrow \tilde{S}_a$  be the projection and  $T_a$  the CT of  $I^+(\tilde{S}_a)$  then we have:*

$$\begin{aligned} r_a(p) &= \tilde{S}_a \cap [p, r(p)] \\ T_a(p) &= T(p) - a. \end{aligned}$$

■

Let  $A$  be as in proposition 4.3,  $T$  the CT of  $A$  and  $r : A \rightarrow \partial A$  the retraction. The **normal field** on  $A$  is the map  $N : A \rightarrow \mathbb{H}^n$  defined by the rule  $N(p) := \frac{1}{T(p)}(p-r(p))$ , it coincides

up to the sign with the lorentzian gradient of  $T$  on  $A$  (we have defined  $N = -\nabla_L T$  instead of  $N = \nabla_L T$  because we want that  $N$  is future directed). Let  $\tilde{S}_a = T^{-1}(a)$  then  $N|_{\tilde{S}_a}$  is the normal field on  $\tilde{S}_a$ . Notice that the following identity holds

$$p = r(p) + T(p)N(p) \quad \text{for all } p \in A.$$

Thus every point in  $A$  is decomposed in *singularity part*  $r(p)$  and a *hyperbolic part*  $T(p)N(p)$ . We shall see that such decomposition plays an important rôle to recover the announced duality. The following inequalities are consequence of the fact that  $r(p) + N(p)^\perp$  is a support plane of  $A$ .

**Corollary 4.6** *With the above notation we have that*

$$\begin{aligned} \langle q, p - r(p) \rangle &< \langle r(p), p - r(p) \rangle \\ \langle T(p)N(p) - T(q)N(q), r(p) - r(q) \rangle &\geq 0 \quad \text{for all } p, q \in A. \end{aligned} \quad (5)$$

We denote by  $\Sigma_A$  the image of the retraction  $r : A \rightarrow \partial A$  and we refer to it as the **singularity in the past**. Notice that if  $r_0 = r(p)$  then by (5) the plane  $r_0 + (p - r_0)^\perp$  is a *spacelike* support plane for  $A$ . Conversely let  $r_0 \in \partial A$  and suppose that there exists a future directed timelike vector  $v$  such that the spacelike plane  $r_0 + v^\perp$  is a support plane. We have that  $p_\lambda = r_0 + \lambda v \in A$  for  $\lambda > 0$  and by proposition 4.3 we have  $r(r_0 + \lambda v) = r_0$ .

**Corollary 4.7** *Let  $A$  a future convex set wich has a spacelike support plane. Then  $r_0 \in \Sigma_A$  if and only if there exists a timelike vector  $v$  such that the plane  $r_0 + v^\perp$  is a support plane. Moreover*

$$r^{-1}(r_0) = \{r_0 + v \mid r_0 + v^\perp \text{ is a support plane}\}.$$

**Remark 4.8** Notice that the map  $r : A \rightarrow \Sigma_A$  continuously extends to a retraction  $r : A \cup \Sigma_A \rightarrow \Sigma_A$ . This map is a deformation retraction (in fact the maps  $r_t(p) = t(p - r(p)) + r(p)$  give the homotopy). Therefore  $\Sigma_A$  is *contractile*.

Now let  $\Omega$  be a **future complete regular domain**. Let us use this notation:

- $T$  is the cosmological time on  $\Omega$  and  $\tilde{S}_a = T^{-1}(a)$ ;
- $r : \Omega \rightarrow \partial\Omega$  is the retraction and  $N : \Omega \rightarrow \mathbb{H}^n$  the normal field;
- $\Sigma = r(\Omega)$  is the singularity in the past.

**Lemma 4.9**  *$\tilde{S}_a$  is a Cauchy surface for  $\Omega$ . Moreover  $\Omega$  is the domain of dependence of  $\tilde{S}_a$ .*

*Proof :* Since  $\Omega$  is a regular domain we have that  $D(\tilde{S}_a) \subset \Omega$ . Now let  $p \in \Omega$  and let  $v$  be a future directed non-spacelike vector. There exists  $\lambda > 0$  such that  $p + \lambda v \in I^+(\tilde{S}_a)$  so that  $T(p + \lambda v) > a$ . On the other hand there exists  $\mu < 0$  such that  $p + \mu v \in \partial\Omega$ , and by corollary 4.4 we have that  $\lim_{t \rightarrow \mu} T(p + tv) = 0$ . So that there exists a  $\lambda' \in \mathbb{R}$  such that  $T(p + \lambda'v) = a$ . Thus  $\Omega \subset D(\tilde{S}_a)$  and the proof is complete.

**Remark 4.10** If  $\Omega$  is a  $\Gamma_\tau$ -invariant regular domain then  $T$  is a  $\Gamma_\tau$ -invariant function. It follows that the CT level surface  $\tilde{S}_a$  are  $\Gamma_\tau$ -invariant future convex spacelike hypersurface. Moreover we have  $r \circ \gamma_\tau = \gamma_\tau \circ r$  and  $N \circ \gamma_\tau = \gamma_\tau \circ N$ . Thus  $\Sigma$  is  $\Gamma_\tau$ -invariant subset of  $\partial\Omega$ .

From the last lemma it follows that  $\tilde{S}_a/\Gamma_\tau$  is a Cauchy surface of  $\Omega/\Gamma_\tau$ . In particular if we take  $\Omega = \mathcal{D}_\tau = D(\tilde{F}_\tau)$  (see section 3) we have that  $\tilde{S}_a/\Gamma_\tau$  is homeomorphic to  $\tilde{F}_\tau/\Gamma_\tau \cong M$  (in fact two Cauchy surface are always homeomorphic).

We want to give a more precise description of the map  $r$  for a regular domain  $\Omega$ . In particular we want to describe the singularity and the fiber of a point on the singularity in terms of geometric properties of the boundary  $\partial\Omega$ . Let us start with a simple remark.

**Lemma 4.11** *For every  $p \in \Omega$  there exists a future directed null vector  $v$  such that the ray  $p + \mathbb{R}_+v$  is contained in  $\partial\Omega$ . Furthermore we have*

$$\Omega = \bigcap \{I^+(p + v^\perp) \mid p \in \partial\Omega \text{ and } v \text{ is a null vector such that } p + \mathbb{R}_+v \subset \partial\Omega\}.$$

*Proof :* Let  $p \in \partial\Omega$ , then there exists a null future directed vector  $v$  such that the ray  $p + v^\perp$  is a support plane for  $\Omega$ . Since  $I^+(p) \subset \Omega$  we have that the ray  $p + \mathbb{R}_+v$  is contained in  $\partial\Omega$ .

Conversely suppose that a ray  $R = p + \mathbb{R}_+v$  is contained in  $\partial\Omega$ . By Hahn-Banach theorem there exists a hyperplane  $P$  such that  $\Omega$  and  $R$  are contained in the opposite (closed) semispaces bounded by  $P$ . Since  $\Omega$  is future complete and  $P$  is a support plane of  $\Omega$  it results that  $P$  is not timelike. Since  $P$  does not intersect  $R$  transversally it follows that  $v$  is parallel to  $P$  so that  $P = p + v^\perp$ . ■

**Proposition 4.12** *A point  $p \in \partial\Omega$  lies in  $\Sigma$  if and only if there exist at least 2 future directed null rays which are contained in  $\partial\Omega$  and pass through  $p$ .*

*Moreover let  $p \in \Sigma$  then  $r^{-1}(p)$  is the intersection of  $\Omega$  with the convex hull of the null rays which are contained in  $\partial\Omega$  and pass through  $p$ .*

*Proof :* We use the following elementary fact about convex sets:

*Let  $V$  be a vector space and  $G \subset V^*$ . Consider the convex  $K = \{v \in V \mid g(v) \leq C_g \text{ for } g \in G\}$ . Suppose that the following property holds: if  $g_n \rightarrow g$  and  $C_{g_n} \rightarrow C$  then  $g \in G$  and  $C_g \leq C$ . Then for all  $v \in \partial K$  the set  $G_v = \{g \in G \mid C_g = g(v)\}$  is non empty. Moreover the plane  $v + P$  is a support plane of  $K$  if and only if there exists  $h$  in the convex hull of  $G_v$  such that  $P = \ker h$ .*

Consider the family  $L$  of the null future directed vectors which are orthogonal to some null support plane. For every  $v \in L$  let  $C_v = \sup_{r \in \Omega} \langle v, r \rangle$ . By lemma 4.11 we get

$$\Omega = \{x \in \mathbb{M}^{n+1} \mid \langle x, v \rangle \leq C_v \forall v \in L\}.$$

Now fix  $p \in \partial\Omega$  and let  $L(p)$  be the set of the null future directed vectors  $v$  such that  $p + v^\perp$  is a support plane of  $\Omega$ . We can apply the remark on convex sets stated above to the family  $L$  (in fact the scalar product  $\langle \cdot, \cdot \rangle$  gives an identification of  $\mathbb{R}^{n+1}$  with its dual) and we obtain that  $L(p)$  is non-empty. Moreover fix a future directed non-spacelike vector  $v$ , then  $p + v^\perp$  is a support plane if and only if  $v$  belongs to the convex hull of  $L(p)$ . By corollary 4.7 we get that  $r^{-1}(p)$  is the intersection of  $\Omega$  with the convex hull of  $p + L(p)$ .

Notice that a null future directed vector  $v$  lies in  $L(p)$  if and only if  $p + \mathbb{R}_+v$  is contained in  $\partial\Omega$ . ■

Now for  $p \in \Sigma$  let us define a subset of  $\mathbb{H}^n$

$$\mathcal{F}(p) := N(r^{-1}(p)).$$

In the following corollary we point out that  $\mathcal{F}(p)$  is an ideal convex set of  $\mathbb{H}^n$ . We recall that a convex set  $C$  of  $\mathbb{H}^n$  is *ideal* if it is the convex hull of boundary points.

**Corollary 4.13** *Fix  $p \in \Sigma$  and let  $L(p)$  as in the last proposition. Denote by  $\hat{L}(p)$  the set of the points on  $\partial\mathbb{H}^n$  which correspond to points in  $L(p)$ . Then  $\mathcal{F}(p) = N(r^{-1}(p))$  is the convex hull in  $\mathbb{H}^n$  of  $\hat{L}(p)$*

Thus we see that each point  $p$  in the singularity  $\Sigma$  corresponds to an ideal convex set  $\mathcal{F}(p)$ . Now we study as the convex sets  $\{\mathcal{F}(p)\}_{p \in \Sigma}$  stay in  $\mathbb{H}^n$ . We recall that given two convex sets  $C, C' \subset \mathbb{H}^n$  we say that a hyperplane  $P$  *separates*  $C$  from  $C'$  if  $C$  and  $C'$  are contained in the opposite closed semispaces bounded by  $P$ .

**Proposition 4.14** *Let  $\Omega$  be a future complete regular domain. For every  $p, q \in \Sigma$  the plane  $(p-q)^\perp$  separates  $\mathcal{F}(p)$  from  $\mathcal{F}(q)$ . The segment  $[p, q]$  is contained in  $\Sigma$  if and only if  $\mathcal{F}(p) \cap \mathcal{F}(q) \neq \emptyset$ . In this case for all  $r \in (p, q)$  we have*

$$\mathcal{F}(r) = \mathcal{F}(p) \cap (p-q)^\perp = \mathcal{F}(q) \cap (p-q)^\perp = \mathcal{F}(p) \cap \mathcal{F}(q).$$

*Proof :* The inequality (5) implies that  $\langle tv, p-q \rangle \leq \langle sw, p-q \rangle$  for every  $v \in \mathcal{F}(q)$ ,  $w \in \mathcal{F}(p)$  and  $t, s \in \mathbb{R}_+$ . This inequality can be satisfied if and only if  $\langle v, p-q \rangle \leq 0$  and  $\langle w, p-q \rangle \geq 0$  for all  $v \in \mathcal{F}(q)$  and  $w \in \mathcal{F}(p)$ . This show that  $(p-q)^\perp$  separates  $\mathcal{F}(p)$  from  $\mathcal{F}(q)$ .

Suppose now that  $\mathcal{F}(p) \cap \mathcal{F}(q) \neq \emptyset$ . We have that  $\mathcal{F}(p) \cap \mathcal{F}(q)$  is contained in  $(p-q)^\perp$ . Let  $v \in \mathcal{F}(p) \cap \mathcal{F}(q)$  and let  $P_v$  be the unique support plane which is orthogonal to  $v$  and intersects  $\partial\Omega$ . We know that  $P_v$  passes through  $p$  and  $q$  so that the segment  $[p, q]$  is contained in  $\partial\Omega$ . Finally since  $P_v$  is a spacelike support plane which passes through every  $r \in (p, q)$  we have  $[p, q] \subset \Sigma$  and moreover  $\mathcal{F}(p) \cap \mathcal{F}(q) \subset \mathcal{F}(r)$ .

Conversely suppose that  $[p, q]$  is contained in  $\Sigma$ . Let  $r \in (p, q)$  and  $v \in \mathcal{F}(r)$ . Then we have that  $\langle v, p-r \rangle \leq 0$  and  $\langle v, r-q \rangle \geq 0$ . Since  $p-r$  and  $r-q$  have the same direction we argue that  $\langle v, r-q \rangle = 0$  and  $\langle v, r-p \rangle = 0$  so that  $v \in \mathcal{F}(p) \cap \mathcal{F}(q)$ .

In order to conclude the proof we have to show that  $\mathcal{F}(r) \supset \mathcal{F}(p) \cap (p-q)^\perp$ . We know that  $\mathcal{F}(p) \cap (p-q)^\perp$  is the convex hull of  $\hat{L}(p) \cap (p-q)^\perp$ . Thus it is sufficient to show that  $L(r) \supset L(p) \cap (p-q)^\perp$ . Now fix  $v \in L(p) \cap (p-q)^\perp$  and consider the plane  $P = p + v^\perp$ . The intersection of this plane with  $\bar{\Omega}$  includes the ray  $p + \mathbb{R}_+v$  and the segment  $[p, q]$ . Since this intersection is a convex we have that  $r + \mathbb{R}_+v$  is a subset of  $P \cap \bar{\Omega}$  and thus  $v \in L(r)$ .

Let us give a general definition.

**Def. 4.2** *A **geodesic stratification** of  $\mathbb{H}^n$  is a family  $\mathcal{C} = \{C_i\}_{i \in I}$  such that*

1.  $C_i$  is an ideal convex set of  $\mathbb{H}^n$ ;
2.  $\mathbb{H}^n = \bigcup_{i \in I} C_i$ ;
3. For every  $i, j \in I$  (with  $i \neq j$ ) there exists a support plane  $P_{i,j}$  which separates  $C_i$  from  $C_j$ . Furthermore if  $C_i \cap C_j \neq \emptyset$  then  $C_i \cap C_j = C_i \cap P_{i,j} = C_j \cap P_{i,j}$ .

Every  $C_i$  is called *piece of the stratification*.

We say that the stratification is  $\Gamma$ -invariant if  $\gamma(C_i) \in \mathcal{C}$  for all  $\gamma \in \Gamma$  and for all  $C_i \in \mathcal{C}$

If  $\Omega$  is a future complete regular domain of  $\mathbb{M}^{n+1}$  such that *the normal field  $N$  is surjective* we have that  $\{\mathcal{F}(p)\}_{p \in \Sigma}$  is a geodesic stratification.

If  $\Omega$  is a  $\Gamma_\tau$ -invariant future complete regular domain by lemma 3.12 the normal field  $N$  is surjective. In this case it is evident that the stratification  $\{\mathcal{F}(p)\}_{p \in \Sigma}$  is  $\Gamma$ -invariant.

Let  $C$  be a convex set, we say that a point  $p$  is *internal* if all support planes which pass through  $p$  contains  $C$ . Let us denote by  $bC$  the set of the point of  $C$  which are not internal. Notice that  $bC$  is not the topological boundary. If  $\dim C = k$  then  $bC$  have a natural decomposition in convex pieces which ideal convexes  $C_i$  with  $\dim C_i < k$  (see [7]).

Now if  $\mathcal{C}$  is a geodesic stratification of  $\mathbb{H}^n$  we can add to it the convexes  $C$  which are pieces of the decomposition of  $bC_i$  for some  $C_i \in \mathcal{C}$ . It is easy to see that so we obtain a new geodesic stratification  $\bar{\mathcal{C}}$  which we call the *completeness* of  $\mathcal{C}$ . Notice that  $\overline{\bar{\mathcal{C}}} = \bar{\mathcal{C}}$ . A geodesic stratification which coincides with its completeness is called *complete*.

Now we can define the  $k$ -stratum of  $\mathcal{C}$  (for  $1 \leq k \leq n-1$ ) as the set

$$X_{(k)} = \bigcup \{F \in \bar{\mathcal{C}} \mid \dim F \leq k\}.$$

Notice that if  $\mathcal{C}$  is  $\Gamma$ -invariant then also  $\bar{\mathcal{C}}$  is so. Moreover in this case the strata are  $\Gamma$ -invariant subsets.

It is easy to see that  $X_{(n-1)}$  is a closed set (in fact  $\mathbb{H}^n - X_{(n-1)}$  is the union of the interior of the  $n$ -dimensional convex of  $\mathcal{C}$ ). Notice that if  $n = 2$  we have only the 1-stratum which in fact is a geodesic lamination of  $\mathbb{H}^2$ . Conversely if  $L$  is a  $\Gamma$ -invariant geodesic lamination there is a unique complete geodesic stratification  $\mathcal{C}$  such that  $L$  is the 1-stratum of  $\mathcal{C}$ . For  $n = 2$  we know that the stratification is continuous in the sense that if  $r_k \in C_k$  and  $r_k \rightarrow r \in \mathbb{H}^n$  then there exists a piece  $C \in \bar{\mathcal{C}}$  such that  $C_k \rightarrow C$  with respect of the Hausdorff topology.

Unfortunately in dimension  $n > 2$  the geodesic stratification are more complicated: the strata  $X_{(k)}$  are not closed for  $k \neq n-1$  and we have not the continuity. However, as we are going to see, the stratifications which arise from a particular class of future complete regular domains are weakly continuous in the following sense:

**Def. 4.3** *A geodesic stratification  $\mathcal{C}$  is weakly continuous if the following property holds. Suppose  $x_k$  be a convergent sequence of  $\mathbb{H}^n$  and put  $x = \lim x_k$ . Let  $F_k$  be a pieces which contains  $x_k$  and suppose that  $F_k \rightarrow F$  in the Hausdorff topology. Then there exists a piece  $G \in \bar{\mathcal{C}}$  such that  $F \subset G$ .*

**Proposition 4.15** *Let  $\Omega$  be a future complete regular domain such that the normal field  $N$  is surjective and the restriction  $N|_{\tilde{S}_1}$  is a proper map (where  $\tilde{S}_1$  is the CT-level surface  $T^{-1}(1)$ ). Then the geodesic stratification  $\mathcal{C}$  associated with it is weakly continuous.*

*Proof :* Let  $(x_k) \subset \mathbb{H}^n$  be a convergent sequence  $x_k \rightarrow x$ . Let  $F_k$  be a piece which contains  $x_k$  and suppose that  $F_k \rightarrow F$ . We have to see that  $F$  is contained in a piece  $G$ .

Let  $r_k \in \Sigma$  such that  $F_k = \mathcal{F}(r_k)$  and let  $p_k = r_k + x_k \in \tilde{S}_1$ . Since  $N|_{\tilde{S}_1}$  is a proper map there exists a convergent subsequence  $p_{k(j)}$ . Let  $p = \lim p_{k(j)}$  and  $r = r(p)$ . We want to show that  $F$  is contained in  $\mathcal{F}(r)$ . Since  $F$  is the convex hull of  $\hat{L}_F = F \cap \partial\mathbb{H}^n$  it is sufficient to show that  $\hat{L}_F \subset \hat{L}(r)$ . Now let  $[v] \in \hat{L}_F$ , we know that there exist a sequence  $[v_n] \in \hat{L}(r_n)$  such that  $[v_n] \rightarrow [v]$  in  $\partial\mathbb{H}^n$ . We have that  $r_n + \mathbb{R}_+ v_n \subset \partial\Omega$ . Since  $\partial\Omega$  is closed this implies that  $r + \mathbb{R}_+ v \subset \partial\Omega$ . Thus we conclude  $[v] \in F_r$ . ■

Consider the regular domain  $\mathcal{D}_\tau$ . Notice that the map  $N : \tilde{S}_1 \rightarrow \mathbb{H}^n$  induces to the quotient a map  $\bar{N} : \tilde{S}_1/\Gamma_\tau \rightarrow \mathbb{H}^n/\Gamma = M$ . Since  $\tilde{S}_1/\Gamma_\tau$  is compact (in fact it is homeomorphic to  $M$ ) it is easy to see that  $N$  is a proper map. Thus the last proposition applies.

**Corollary 4.16** *Let  $\mathcal{C}_\tau$  be the stratification associated with  $\mathcal{D}_\tau$ . Then it is weakly continuous.* ■

We postpone a more careful discussion about  $\Gamma$ -invariant geodesic stratification to the last sections. In the last part of this section we consider the future complete regular domain  $\mathcal{D}_\tau$  which we have constructed in section 3. We prove that  $\Gamma_\tau$  does not act freely and properly discontinuously on  $\partial\mathcal{D}_\tau$ . By this result we deduce that *the action of  $\Gamma_\tau$  on  $\mathbb{M}^{n+1}$  is not free and properly discontinuous*. In particular we deduce that the domain of dependence of a  $\Gamma_\tau$ -invariant spacelike hypersurface is a regular domain (either future or past complete).

**Lemma 4.17** *Let  $\Omega$  be a future complete regular domain. Suppose that  $\Sigma$  is closed in  $\partial\Omega$ . Then the retraction  $\Omega \rightarrow \Sigma$  extends uniquely to a deformation retraction  $r : \overline{\Omega} \rightarrow \Sigma$*

*Proof :* Since  $\Sigma$  is closed it is easy to see that for every point  $p$  outside  $\Sigma$  there exists a unique null ray  $R$  in  $\partial\Omega$  such that  $p$  is contained in the interior of  $R$ . Thus we can define the retraction on  $\partial\Omega$  by taking  $r(p)$  the starting point of the ray  $R$ . It is easy to show that this is a continuous extension of  $r$ . ■

Let  $\Omega$  be a future complete regular domain and suppose that  $\Sigma$  is closed. Let  $X := \partial\Omega$ , we want to construct a boundary of  $X$ . We know that  $X - \Sigma$  is a  $C^1$ -manifold foliated by rays with starting points in  $\Sigma$ . Let  $p \in X - \Sigma$ , we denote by  $R(p)$  the ray of the foliation which passes through  $p$ . The retraction on  $X$  is so defined:  $r(p) = p$  if  $p \in \Sigma$  whereas  $r(p)$  is the starting point of  $R(p)$  if  $p \in X - \Sigma$ .

*The boundary of  $X$  is the leaves space of the foliation:*

$$\partial X := \{R | R \text{ is a ray of the foliation}\}.$$

We want to define a topology on  $\overline{X} := X \cup \partial X$  such that agrees with the natural topology on  $X$  and makes  $\overline{X}$  a  $n$ -manifold with boundary equal to  $\partial X$ . Thus we have to define a fundamental family of neighborhoods of a point  $R \in \partial X$ . Fix a  $C^1$ -embedded closed  $(n - 1)$ -ball  $D$  which intersects transversally the foliation and passes through  $R$  and define

$$U(R, D) = \{p \in X - \Sigma | R(p) \cap \text{int}D \neq \emptyset \text{ and } \text{int}D \cap R(p) \text{ separates } p \text{ from } r(p)\} \cup \{S \in \partial X | S \cap \text{int}D \neq \emptyset\}.$$

Then we can consider the topology on  $\overline{X}$  which agrees with the natural topology on  $X$  and such that for each  $R \in \partial X$  the sets  $U(R, D)$  are a fundamental family of neighborhoods of  $R$ . It is easy to see that  $\overline{X}$  is a Hausdorff space. In order to construct an atlas on  $\overline{X}$  for  $p \in X - \Sigma$  put  $v(p)$  the future directed null vector tangent to  $R(p)$  such that  $x_0(v(p)) = 1$ . For all  $(n - 1)$ -ball  $D$  as above, consider the maps  $\mu_D : D \times (0, +\infty] \rightarrow U(R, D)$  defined by the rule

$$\mu_D(x, t) = \begin{cases} x + tv(x) & \text{if } t < +\infty \\ R(x) & \text{if } t = +\infty \end{cases}$$

It is easy to see that these maps are local charts, so that  $\overline{X}$  is a manifold with boundary. Finally notice that the retraction  $r$  extends uniquely to a retraction  $r : \overline{X} \rightarrow \Sigma$ . Notice that this *retraction is a proper map*.

Now suppose that  $\Gamma_\tau$  acts freely and properly discontinuously on  $\overline{\Omega}$ . It is easy to see that the action of  $\Gamma_\tau$  on  $X$  extends uniquely to an action on  $\overline{X}$ . Moreover the map  $r : \overline{X} \rightarrow \Sigma$  is  $\Gamma_\tau$ -equivariant. By using this remark it follows that the action of  $\Gamma_\tau$  on  $\overline{X}$  is free and properly discontinuous. Thus  $\overline{X}/\Gamma_\tau$  is a manifold with boundary. Now we can state the announced proposition.

**Proposition 4.18** *The action of  $\Gamma_\tau$  on  $\partial\mathcal{D}_\tau$  is not free and properly discontinuous.*

*Proof :* By contradiction suppose that the action is free and properly discontinuous. Let  $X := \partial\mathcal{D}_\tau$ , and put  $M' := X/\Gamma_\tau$  and  $K := \Sigma/\Gamma_\tau$ . Let  $\hat{r} : \mathcal{D}_\tau/\Gamma_\tau \rightarrow K$  be the map which arises from the retraction  $r : \mathcal{D}_\tau \rightarrow \Sigma$ . Notice that  $K = \hat{r}(\tilde{S}_1/\Gamma_\tau)$ . Since  $\tilde{S}_1/\Gamma_\tau$  is compact (in fact we have seen that it is homeomorphic to  $M$ ) we get that  $K$  is compact. Since  $M'$  is a Hausdorff space we have that  $K$  is closed in  $M'$  and so  $\Sigma$  is closed in  $X = \partial\mathcal{D}_\tau$ .

Thus we can construct as above the boundary  $\partial X$  of  $X$ . Let  $\overline{M'} = \overline{X}/\Gamma_\tau$ , we know that  $\overline{M'}$  is a manifold with boundary and  $M'$  is the interior of  $\overline{M'}$ .

Consider the retraction  $r : \overline{X} \rightarrow \Sigma$ : since this map is  $\Gamma_\tau$ -equivariant and proper it induces to the quotient a proper map  $\overline{r} : \overline{M'} \rightarrow K$ . Since  $K$  is compact it follows that  $\overline{M'}$  is a compact manifold with boundary.

Since  $\overline{r} : \overline{M'} \rightarrow K$  is a deformation retraction we have that  $H_n(K) = H_n(M')$  and by the Poincaré duality it follows that

$$H_n(K) = H_n(M') = H^0(\overline{M'}, \partial\overline{M'}) = 0.$$

On the other hand let  $Y_\tau = \mathcal{D}_\tau/\Gamma_\tau$  and  $\overline{Y}_\tau = \overline{\mathcal{D}_\tau}/\Gamma_\tau$ . We know that the map  $r : \overline{\mathcal{D}_\tau} \rightarrow \Sigma$  induces to the quotient a deformation retraction  $\overline{Y}_\tau \rightarrow K$ . So that

$$H_n(K) = H_n(\overline{Y}_\tau) = H_n(Y_\tau).$$

We have  $Y_\tau \cong \mathbb{R} \times M$ . So  $H_n(Y_\tau) = H_n(M) = \mathbb{Z}$  and this is a contradiction. ■

**Corollary 4.19**  *$\Gamma_\tau$  does not act freely and properly discontinuously on the whole  $\mathbb{M}^{n+1}$ . Moreover let  $\tilde{F}$  be a  $\Gamma_\tau$ -invariant complete spacelike hypersurface such that  $\Gamma_\tau$  acts freely and properly discontinuously on it. Then  $D(\tilde{F})$  is a regular domain (either future or complete).*

*Proof :* The first statement follows from the last proposition. In particular we have that  $D(\tilde{F})$  is not the whole  $\mathbb{M}^{n+1}$ . By corollary 3.7 we know that  $D(\tilde{F})$  is either future or past complete and it is the intersection of the future (resp. past) of null planes. By lemma 3.12 we know that  $D(\tilde{F})$  has spacelike support planes and so it is a regular domain. ■

## 5 Uniqueness of the Domain of Dependence

Let us summarize what we have seen until now. We have fixed  $\Gamma$  a free-torsion co-compact discrete subgroup of  $SO^+(n, 1)$  and  $M = \mathbb{H}^n/\Gamma$ . Then we have fixed a cocycle  $\tau \in Z^1(\Gamma, \mathbb{R}^{n+1})$  and we have studied the  $\Gamma_\tau$ -invariant domains of  $\mathbb{M}^{n+1}$ . In particular we have constructed a  $\Gamma_\tau$ -invariant future complete (resp. past complete) regular domain  $\mathcal{D}_\tau$  (resp.  $\mathcal{D}_\tau^-$ ) such that the action on  $\Gamma_\tau$  on it is free and properly discontinuous and the quotient  $Y_\tau = \mathcal{D}_\tau/\Gamma_\tau$  is a globally hyperbolic manifold homeomorphic to  $\mathbb{R}_+ \times M$  with regular CT. Moreover we have seen that if  $\tilde{F}$  is a  $\Gamma_\tau$ -invariant complete spacelike hypersurface such that the action on it is free and properly discontinuous then  $D(\tilde{F})$  is a regular domain either future or past complete.

In this section we want to show that  $\mathcal{D}_\tau$  (resp.  $\mathcal{D}_\tau^-$ ) is the unique  $\Gamma_\tau$ -invariant future complete (resp. past complete) regular domain. In particular we deduce that every  $\tilde{F}$  as above is contained in  $\mathcal{D}_\tau$  or in  $\mathcal{D}_\tau^-$  and it is in fact a Cauchy surface of it.

**Theorem 5.1**  *$\mathcal{D}_\tau$  is the unique  $\Gamma_\tau$ -invariant future complete regular domain.*



Let us give a scheme of the proof. Let  $\Omega$  be a  $\Gamma_\tau$ -invariant future complete regular domain we have to show that  $\Omega = \mathcal{D}_\tau$ .

Let  $T_\Omega$  be the cosmological time on  $\Omega$  (whereas  $T$  is the cosmological time on  $\mathcal{D}_\tau$ ). For every  $a > 0$  let  $\tilde{S}_a^\Omega := T_\Omega^{-1}(a)$  (whereas  $\tilde{S}_a = T^{-1}(a)$  is the level surface of  $\mathcal{D}_\tau$ ). Since  $\tilde{S}_a^\Omega$  (resp.  $\tilde{S}_a$ ) is Cauchy surface in  $\Omega$  (resp.  $\mathcal{D}_\tau$ ) we have that  $\Omega = D(\tilde{S}_a^\Omega)$  (resp.  $\mathcal{D}_\tau = D(\tilde{S}_a)$ ). Thus it is sufficient to prove that  $\tilde{S}_a \subset \Omega$  and  $\tilde{S}_a^\Omega \subset \mathcal{D}_\tau$  for  $a \gg 0$ . Let us split the proof in some steps.

*Step 1.*  $\Omega \cap \mathcal{D}_\tau \neq \emptyset$ .

*Step 2.* Fix  $p \in \Omega \cap \mathcal{D}_\tau$  and let  $C$  be the convex hull of the  $\Gamma_\tau$ -orbit of  $p$ . Then  $C$  is a future complete convex set.

*Step 3.* Let  $\Delta = \partial C$  be the boundary of  $C$  then  $\Delta/\Gamma_\tau$  is compact.

*Step 4.* Let  $a > \sup_{q \in \Delta} T_\Omega(q) \vee \sup_{q \in \Delta} T(q)$  then  $\tilde{S}_a^\Omega \subset \mathcal{D}_\tau$  and  $\tilde{S}_a \subset \Omega$ .

The *first step* is quite evident. In fact let  $p \in \Omega$  and  $q \in \mathcal{D}_\tau$ . Since  $\Omega$  and  $\mathcal{D}_\tau$  are future complete then  $I^+(p) \cap I^+(q) \subset \Omega \cap \mathcal{D}_\tau$ . On the other hand the future sets of two points in  $\mathbb{M}^{n+1}$  are not disjoint.

The *second step* is more difficult. We start with a lemma.

**Lemma 5.2** *Let  $C$  be a closed convex set of  $\mathbb{M}^{n+1}$  whose interior part is nonempty. Then one of the following statement holds:*

- (1) *there exists a non spacelike direction  $v$  such that  $C = \{x \in \mathbb{M}^{n+1} | \alpha_1 \leq \langle x, v \rangle \leq \alpha_2\}$ ;*
- (2) *there exists a timelike support plane for  $C$ ;*
- (3) *every support plane is non-timelike and  $C$  is a future or past convex set.*

*Proof :* Suppose there exists  $p, q \in \partial C$  such that  $q \in I^+(p)$ . Let us prove that  $C$  verifies (1) or (2). More exactly suppose that  $C$  has not timelike support plane we want to show that  $C$  satisfies (1).

Let  $P_p$  and  $P_q$  be non-timelike support planes respectively in  $p$  and in  $q$ . Since  $q \in I^+(p)$  we argue that  $C \subset I^+(P_p) \cap I^-(P_q)$ . As in the proof of corollary 3.12 if  $P_p$  and  $P_q$  are not parallel then we get that there exists a timelike support plane. Thus  $P_p$  and  $P_q$  are parallel.

Since  $p$  and  $q$  are generic it follows that for all  $p', q' \in \partial C$  such that  $p' \in I^+(q')$  support planes in  $p'$  and in  $q'$  are parallel. In particular there exists a nonspacelike direction  $v$  such that the unique support plane in  $p'$  and the unique support plane in  $q'$  are orthogonal to  $v$ .

We want to show that  $\partial C = P_p \cup P_q$ . In fact it is sufficient to prove the inclusion  $P_p \cup P_q \subset \partial C$ . Now let  $e = q - p$  and define the set

$$A = \{z \in P_q | z \in \partial C \text{ and } z - e \in \partial C\}.$$

We have to show that  $A = P_q$ . Clearly  $A$  is closed and nonempty (in fact  $q \in A$ ). Thus it is sufficient to show that  $A$  is open. Now let  $z \in A$  and  $z' = z - e$ : the set  $U := I^+(z') \cap \partial C$  is a neighborhood of  $z$  and for every  $x \in U$  there is a unique support plane  $P_x$  parallel to  $P_q$  which passes through  $x$ . Since  $P_q$  is a support plane and  $P_q \cap \partial C \neq \emptyset$  it follows that  $P_q = P_x$  so that  $U \subset P_q$ . In the same way we deduce that  $V = I^-(z) \cap \partial C$  is contained in  $P_p$ . Thus  $U \cap (V + e)$  is a neighborhood of  $z$  in  $\partial C$  which is contained in  $A$ . Thus we have that  $\partial C = P_p \cup P_q$  and it follows that  $C$  verifies (1).

We have proved that if there exists  $p, q \in \partial C$  such that  $p - q$  is timelike then  $C$  verifies (1) or (2). Suppose now that for all  $p, q \in \partial C$  the vector  $p - q$  is non-timelike, we want to show that  $C$  verifies (3).

Suppose that there exists a timelike support plane. Then there exists a vector  $u$  and  $K \in \mathbb{R}$  such that  $\langle u, u \rangle = 1$  and

$$\langle u, p \rangle \leq K \quad \text{for all } p \in C.$$

Take  $p_0 \in \text{int}C$  and  $v_+, v_- \in \mathbb{H}^n$  such that

$$\langle u, v_+ \rangle > 0 \quad \langle u, v_- \rangle < 0.$$

Consider for  $t > 0$

$$p_t = p_0 + tv_+ \quad p_{-t} = p_0 - tv_-.$$

We have

$$\begin{aligned} \langle p_t, u \rangle &= \langle p_0, u \rangle + t \langle v_+, u \rangle \rightarrow +\infty \quad \text{for } t \rightarrow +\infty; \\ \langle p_{-t}, u \rangle &= \langle p_0, u \rangle - t \langle v_-, u \rangle \rightarrow +\infty \quad \text{for } t \rightarrow +\infty. \end{aligned}$$

Thus there exists  $\alpha > 0$  and  $\beta < 0$  such that  $p_\alpha, p_\beta \notin C$ . Let  $t_+ = \sup\{t > 0 | x_t \in C\}$  and  $t_- = \inf\{t < 0 | x_t \in C\}$ . Notice that  $p_{t_+}$  and  $p_{t_-}$  lies in  $\partial C$ . Furthermore since  $p_0$  is an interior point of  $C$  we have that  $t_+ > 0$  and  $t_- < 0$ . Thus  $p_{t_+}$  is in the future of  $p_0$  which is in the future of  $p_{t_-}$ . But then we have  $p_{t_+}$  in the future of  $p_{t_-}$  and this contradicts the our assumption on  $C$ .

Hence all the support planes of  $C$  are non-timelike. Let  $P$  be a support plane. We can suppose that  $C \subset \overline{\mathbb{I}^+(P)}$  (the other case is analogous). I claim that for every support plane  $Q$  we have that  $C \subset \overline{\mathbb{I}^+(Q)}$ . Otherwise there should exist  $v_1, v_2$  future directed non-spacelike vectors and  $K \in \mathbb{R}$  such that

$$\langle p, v_1 \rangle \leq K \quad \langle p, v_2 \rangle \geq K \quad \text{for all } p \in C.$$

Fix  $p_0 \in \text{int}C$  and put  $p_t = p_0 + te$  where  $e$  is a timelike vector. Then it is easy to show that there exist  $t_1 < 0 < t_2$  such that  $p_{t_1}, p_{t_2} \in \partial C$  and this contradicts the our assumption on  $C$ . Thus we have

$$C = \bigcap_{P \text{ support plane}} \overline{\mathbb{I}^+(P)}.$$

It follows that  $C$  is future complete. ■

Now let us go back to the step 2. We have taken  $p \in \Omega \cap \mathcal{D}_\tau$  and we have to show that the convex hull  $C$  of the  $\Gamma_\tau$ -orbit of  $p$  is future complete. By last lemma it is sufficient to prove:

- a)  $\text{int}C \neq \emptyset$ ;
- b)  $C$  is not of the form  $\{x \in \mathbb{M}^{n+1} | \alpha_1 \leq \langle x, v \rangle \leq \alpha_2\}$ ;
- c)  $C$  has not timelike support plane.

a) is quite evident. In fact if the interior of  $C$  is empty then there exists a unique  $k$ -plane  $P$  with  $0 < k < n + 1$  such that  $C \subset P$  and  $\text{int}_P(C) \neq \emptyset$ . But then since  $C$  is  $\Gamma_\tau$ -invariant it follows that  $P$  is  $\Gamma_\tau$ -invariant and so the tangent plane to  $P$  is  $\Gamma$ -invariant. But we know that a  $\Gamma$  is co-compact and so it is irreducible. In analogous way one can prove b).

*It remains to prove that  $C$  has not timelike support plane.* For this purpose we introduce some notation. Fix a set of orthonormal affine coordinates  $(y_0, \dots, y_n)$ . For every  $\gamma \in \Gamma$  we denote by  $x^+(\gamma)$  (resp.  $x^-(\gamma)$ ) the attractor null eigenvector of  $\gamma$  (resp.  $\gamma^{-1}$ ) such that  $y_0(x^+(\gamma)) = 1$  (resp.  $y_0(x^-(\gamma)) = 1$ ). For every  $z \in \mathbb{M}^{n+1}$  we can write

$$z = a_+(\gamma, z)x^+(\gamma) + a_-(\gamma, z)x^-(\gamma) + x^0(\gamma, z) + x^1(\gamma, z)$$

with  $a_+, a_- \in \mathbb{R}$ ,  $x^0 \in \ker(\gamma - 1)$  and  $x^1 \in \ker(\gamma - 1)^\perp \cap \langle x^+(\gamma), x^-(\gamma) \rangle^\perp$ . In order to prove c) we now have to show the following lemma.

**Lemma 5.3** *Fix  $r \in \overline{\mathcal{D}_\tau}$ . For every  $\gamma \in \Gamma$  put  $z(\gamma) = \gamma_\tau r - r$ . Then we have*

$$\begin{aligned} a_+(\gamma, z(\gamma)) &\geq 0 \\ a_-(\gamma, z(\gamma)) &\leq 0. \end{aligned}$$

Furthermore if  $a_+(\gamma, z(\gamma))a_-(\gamma, z(\gamma)) = 0$  then  $x^0(\gamma, z(\gamma)) = 0$ .

*Proof* : We have seen in 3.14 that  $z$  is a cocycle. Thus it is easy to see that

$$\begin{aligned} z(\gamma^k) &= \sum_{i=0}^{k-1} \gamma^i z(\gamma) \\ z(\gamma^{-k}) &= - \sum_{i=1}^k \gamma^{-i} z(\gamma). \end{aligned}$$

Let  $\lambda > 1$  such that  $\gamma x^+(\gamma) = \lambda x^+(\gamma)$  and put  $a_+ = a_+(\gamma, z(\gamma))$ ,  $a_- = a_-(\gamma, z(\gamma))$ ,  $x^0 = x^0(\gamma, z(\gamma))$  and  $x^1 = x^1(\gamma, z(\gamma))$ . By using last formulas we obtain

$$\begin{aligned} z(\gamma^k) &= \frac{\lambda^k - 1}{\lambda - 1} a_+ x^+(\gamma) + \frac{1}{\lambda^k} \frac{\lambda^k - 1}{\lambda - 1} a_- x^-(\gamma) + kx^0 + (\gamma^{k-1} + \dots + \gamma + 1)x^1; \\ z(\gamma^{-k}) &= -\frac{1}{\lambda^k} \frac{\lambda^k - 1}{\lambda - 1} a_+ x^+(\gamma) - \frac{\lambda^k - 1}{\lambda - 1} a_- x^-(\gamma) - kx^0 - \gamma^{-k}(\gamma^{k-1} + \dots + \gamma + 1)x^1. \end{aligned} \quad (6)$$

Now notice that  $W = \ker(1 - \gamma)^\perp \cap \langle x^+(\gamma), x^-(\gamma) \rangle^\perp$  is a spacelike  $\gamma$ -invariant subspace and the application  $(1 - \gamma)|_W$  is invertible. Let us denote by  $B_\gamma$  the map  $(1 - \gamma)|_W^{-1}$ . Now it is easy to see that  $(\gamma^{k-1} + \dots + \gamma + 1)x^1 = (\gamma^k - 1)B_\gamma x^1$  and so we have that the set  $\{(\gamma^{k-1} + \dots + \gamma + 1)x^1\}_{k \in \mathbb{N}}$  is contained in a compact of  $W$ .

Fix a timelike future directed vector  $e$ . Since  $r \in \overline{\mathcal{D}_\tau}$  there exists  $K \in \mathbb{R}$  such that  $\langle \alpha r, e \rangle \leq K$  for all  $\alpha \in \Gamma$  and thus  $\langle z(\alpha), e \rangle \leq 2K$  for all  $\alpha \in \Gamma$ . Now let us impose  $\langle z(\gamma^k), e \rangle \leq 2K$  for every  $k \in \mathbb{N}$ . Since  $\{(\gamma^{k-1} + \dots + \gamma + 1)x^1\}_{k \in \mathbb{N}}$  is contained in a compact set so that there exists  $K'$  such that

$$\frac{\lambda^k - 1}{\lambda - 1} a_+ \langle x^+(\gamma), e \rangle + \frac{1}{\lambda^k} \frac{\lambda^k - 1}{\lambda - 1} a_- \langle x^-(\gamma), e \rangle + k \langle x^0, e \rangle \leq K'. \quad (7)$$

Suppose  $a_+ < 0$ : by passing to the limit we have that the left expression in (7) tends to  $+\infty$  (in fact notice that  $\langle x^+(\gamma), e \rangle < 0$ ). But this contradicts (7) and so we have  $a_+ \geq 0$ . An analogous argument shows that  $a_- \leq 0$ .

Now suppose that  $a_+ = 0$  (the case  $a_- = 0$  is analogous). Suppose  $x^0 \neq 0$ . Since  $x^0$  is spacelike then we can choose the vector  $e$  so that  $\langle x^0, e \rangle > 0$  but then the expression on the left in (7) tends to  $+\infty$  and this contradicts (7). ■

Now we can prove that  $C$  has not any timelike support plane. By contradiction suppose that there exists a spacelike vector  $v$  and  $K \in \mathbb{R}$  such that

$$\langle \gamma_\tau p, v \rangle \leq K \quad \text{for all } \gamma \in \Gamma.$$

Let  $z(\gamma) = \gamma_\tau p - p$ , so we have  $\langle z(\gamma), v \rangle \leq 2K$  for all  $\gamma \in \Gamma$ .

We can fix  $\gamma \in \Gamma$  such that  $\langle x^+(\gamma), v \rangle \geq 0$  and  $\langle x^-(\gamma), v \rangle \geq 0$  (a such  $\gamma$  exists because the limit set of  $\Gamma$  is the whole  $\partial\mathbb{H}^n$ ). Now put  $a_+ = a_+(\gamma, z(\gamma))$ . Notice that  $a_+ \neq 0$ : in fact if  $a_+ = 0$  we have that  $x^0(\gamma, z(\gamma)) = 0$ . Then from (6) it follows that  $z(\gamma^k)$  runs in a compact set for  $k \geq 0$ . But we know that the action of  $\Gamma_\tau$  on  $C$  is properly discontinuous (in fact  $C \subset \mathcal{D}_\tau$ ) and this is a contradiction. Thus  $a_+$  is positive. By using (6) we easily see that  $\langle z(\gamma^k), v \rangle \rightarrow +\infty$  and this is a contradiction.

Finally we have that  $C$  is a future ore past convex set. Since  $C \subset \mathcal{D}_\tau \cap \Omega$  and these are future convex then  $C$  is future convex set. This concludes th proof of the step 2.

Now *we prove the step 3*. Let  $\Delta = \partial C$ : since  $C$  is  $\Gamma_\tau$ -invariant it follows that  $\Delta$  is  $\Gamma_\tau$ -invariant. Furthermore since  $C$  is a convex set with interior non empty then  $\Delta$  is a topological  $n$ -manifold.

We have to show that  $\Delta/\Gamma_\tau$  is compact. Let  $r : \mathcal{D}_\tau \rightarrow \partial\mathcal{D}_\tau$  be the retraction, since  $\Delta \subset \mathcal{D}_\tau$  we can define

$$f : \Delta \ni p \mapsto r(p) + \frac{1}{T(p)}(p - r(p)) \in \tilde{S}_1.$$

Notice that  $f(p)$  is the intersection of the timelike line  $p + \mathbb{R}(p - r(p))$  with the surface  $\tilde{S}_1$ . Clearly we have that  $f$  is  $\Gamma_\tau$ -equivariant so induces a map  $\bar{f} : \Delta/\Gamma_\tau \rightarrow \tilde{S}_a/\Gamma_\tau$ . We have seen that  $\tilde{S}_a/\Gamma_\tau$  is homeomorphic to  $M$  so that it is sufficient to show that  $\bar{f}$  is a homeomorphism.

Since  $C$  is future convex it is easy to see that  $f$  is injective. On the other hand fix  $q \in \tilde{S}_1$ , we have that  $q + \lambda(q - r(q)) \in C$  for  $\lambda \gg 1$  (in fact fix  $p_0 \in C$  then  $q + \lambda(q - r(q)) \in I^+(p_0) \subset C$  for  $\lambda \gg 1$ ) and  $q + \lambda(q - r(q)) \notin C$  for  $\lambda \ll 0$ . Thus there exists  $\lambda_0$  such that  $p = q + \lambda_0(q - r(q)) \in \Delta$ . Since  $r(q + \lambda(q - r(q))) = r(q)$  for all  $\lambda \in (-1, +\infty)$ , we get  $r(p) = r(q)$  so that the lines  $p + \mathbb{R}(p - r(p))$  and  $q + \mathbb{R}(q - r(q))$  coincide. Thus  $q$  is the intersection of the line  $p + \mathbb{R}(p - r(p))$  with  $\tilde{S}_1$  so that  $f(p) = q$ . It follows that the map  $f$  is surjective. By theorem of the the invariance of domain we get that  $f$  is a homemorphism and so  $\bar{f}$ . This concludes the step 3.

Now *we prove the step 4*. Notice that the function  $T : \Delta \rightarrow \mathbb{R}$  and  $T_\Omega : \Delta \rightarrow \mathbb{R}$  are  $\Gamma_\tau$ -invariant. Since  $\Delta/\Gamma_\tau$  is compact these functions are bounded on  $\Delta$  so that there exists  $a > 0$  such that  $T(x) < a$  and  $T_\Omega(x) < a$  for every  $x \in \Delta$ . We have to show that  $\tilde{S}_a$  and  $\tilde{S}_a^\Omega$  are contained in  $C$ . Let  $y \in \mathcal{D}_\tau$  and suppose  $y \notin C$ . We have that  $y \in I^-(\Delta)$ : in fact if  $e$  is a timelike future directed vector the ray  $y + \mathbb{R}_+e$  intersects  $C$  and so it intersects  $\Delta$ . Thus there exists  $y' \in \Delta \cap I^+(y)$  so that we have  $T(y) < T(y') < a$ . Thus  $\tilde{S}_a \subset C$ . An analogous argument shows that  $\tilde{S}_a^\Omega \subset C$ . This concludes the proof of step 4 and the proof of theorem 5.1. ■

Clearly an analogous theorem holds for  $\Gamma_\tau$ -invariant past complete regular domain. So that  $\mathcal{D}_\tau^-$  is the unique  $\Gamma_\tau$ -invariant past complete regular domain.

**Corollary 5.4** *If  $\tau$  and  $\sigma$  differs by a traslation then  $\mathcal{D}_\tau$  and  $\mathcal{D}_\sigma$  differs by a traslation. Moreover we have that  $\mathcal{D}_{-\tau}$  coincides with  $-(\mathcal{D}_\tau^-)$ .*

*Proof* : Suppose that  $\sigma_\gamma - \tau_\gamma = \gamma(x) - x$  it is easy to see that  $\mathcal{D}_\tau + x$  is a  $\Gamma_\sigma$ -invariant future complete regular domain.

On the other hand notice that  $-(\mathcal{D}_\tau^-)$  is a future complete regular domain and it is invariant by the action of  $\Gamma_{-\tau}$ . ■

Let  $Y_\tau := \mathcal{D}_\tau/\Gamma_\tau$  (resp.  $Y_\tau^- := \mathcal{D}_\tau^-/\Gamma_\tau$ ). We get that  $Y_\tau$  and  $Y_\sigma$  are isometric if and only if  $\tau$  and  $\sigma$  differs by a coboundary (i.e. the isometric class of  $Y_\tau$  depends only on the cohomology

class of  $\tau$ ). Notice that for  $\tau = 0$  the domain  $\mathcal{D}_0$  (resp.  $\mathcal{D}_0^-$ ) coincides with  $I^+(0)$  (resp.  $I^-(0)$ ) so that  $Y_0$  is the Minkowskian cone  $\mathcal{C}^+(M)$ .

On the other hand notice that there exists a time-orientation reversing isometry between  $Y_{-\tau}$  and  $Y_\tau^-$ .

**Corollary 5.5** *Let  $\tilde{F}$  be a  $\Gamma_\tau$ -invariant complete spacelike hypersurface such that the action of  $\Gamma_\tau$  is free and properly discontinuous. Then  $\tilde{F}$  is contained in  $\mathcal{D}_\tau$  or in  $\mathcal{D}_\tau^-$ . In particular every timelike coordinate is proper on  $\tilde{F}$  and the Gauss map has degree 1. Furthermore  $\tilde{F}/\Gamma_\tau$  is homeomorphic to  $M$ .*

*Proof* : We know that  $D(\tilde{F})$  is a  $\Gamma_\tau$ -invariant future or past complete regular domain. By theorem 5.1 we get that either  $D(\tilde{F}) = \mathcal{D}_\tau$  or  $D(\tilde{F}) = \mathcal{D}_\tau^-$ . Thus  $\tilde{F}$  is contained either in  $\mathcal{D}_\tau$  or in  $\mathcal{D}_\tau^-$ . Notice that this implies that every timelike coordinate on  $\tilde{F}$  is proper.

Suppose  $\tilde{F} \subset \mathcal{D}_\tau$ . Consider the map

$$\varphi : \tilde{F} \ni x \mapsto r(x) + \frac{1}{T(x)}(x - r(x)) \in \tilde{S}_1.$$

It is easy to see that this map is  $\Gamma_\tau$ -equivariant and injective. Furthermore since  $\tilde{F}$  is a Cauchy surface for  $\mathcal{D}_\tau$  (in fact  $\mathcal{D}_\tau = D(\tilde{F})$ ) one easily see that  $\varphi$  is surjective. Thus it is an homeomorphism  $\Gamma_\tau$ -equivariant. It follows that it induces an homeomorphism  $\bar{\varphi} : \tilde{F}/\Gamma_\tau \rightarrow \tilde{S}_1/\Gamma_\tau \cong M$ .

Finally consider the Gauss map of  $\tilde{F}$ . It is a  $\Gamma$ -equivariant map  $G : \tilde{F} \rightarrow \mathbb{H}^n$  (i.e.  $G(\gamma_\tau p) = \gamma G(p)$ ). It is easy to see that this map induces to the quotient a map  $\bar{G} : \tilde{F}/\Gamma_\tau \rightarrow M$  which is a homotopical equivalence. Thus it has degree 1. ■

Now we want to prove that  $Y_\tau$  and  $Y_\tau^-$  are the unique maximal globally hyperbolic spacetimes with a compact spacelike Cauchy surface such that the holonomy group is  $\Gamma_\tau$ . We need the following remark which was stated by Mess in [11] for the case  $n = 2$ . However his proof runs in every dimension.

**Corollary 5.6** *For every  $\tau \in Z^1(\Gamma, \mathbb{R}^{n+1})$  the intersection  $\mathcal{D}_\tau \cap \mathcal{D}_\tau^-$  is empty.*

*Proof* : It is easy to see that  $\mathcal{D}_\tau \cap \mathcal{D}_\tau^-$  is a  $\Gamma_\tau$  invariant compact set. Thus if it is not empty its barycenter  $p$  is a fix point of  $\Gamma_\tau$ . It is straightforward to recognize that  $I^+(p)$  and  $I^-(p)$  are respectively a  $\Gamma_\tau$ -invariant future and past complete domain of dependence (notice that the cohomology class of  $\tau$  vanishes). Hence  $\mathcal{D}_\tau = I^+(p)$  and  $\mathcal{D}_\tau^- = I^-(p)$  so that their intersection is empty. ■

**Corollary 5.7** *There exists only two maximal globally hyperbolic flat spacetimes with compact spacelike Cauchy surface such that the holonomy group is  $\Gamma_\tau$ .*

*Proof* : Let  $Y$  be a maximal globally hyperbolic flat spacetime with compact spacelike Cauchy surface  $N$  and holonomy group equal to  $\Gamma_\tau$ . We have to show that  $Y$  isometrically embeds in  $Y_\tau$  or in  $Y_\tau^-$ . It is sufficient to show that the developing map  $D : \tilde{Y} \rightarrow \mathbb{M}^{n+1}$  is an embedding such that the image is contained either in  $\mathcal{D}_\tau$  or in  $\mathcal{D}_\tau^-$ .

Let  $N$  be the spacelike Cauchy surface of  $Y$ . We know that  $D : \tilde{N} \rightarrow \mathbb{M}^{n+1}$  is an embedding and the image  $D(\tilde{N})$  is a  $\Gamma_\tau$ -invariant surface such that the  $\Gamma_\tau$ -action on it is free and properly discontinuous. Thus  $D(\tilde{N})$  is a Cauchy surface of  $\mathcal{D}_\tau$  or  $\mathcal{D}_\tau^-$ . It follows that  $N$  is homeomorphic to  $M$ . In [2] it is shown that  $Y$  is foliated by spacelike hypersurfaces so that  $D(Y) \subset \mathcal{D}_\tau \cup \mathcal{D}_\tau^-$ .

Since these domain are disjoint it follows that  $D(Y)$  is contained in one of them, say  $\mathcal{D}_\tau$  (the other case is analogous).

Consider the map  $T_D := T \circ D$  where  $T$  is the CT of  $\mathcal{D}_\tau$ : we have that  $T_D$  is a  $\pi_1(Y)$ -invariant regular map such that the level surface  $\tilde{N}_a$  are  $\pi_1(Y)$ -invariant spacelike Cauchy surface. Thus  $\tilde{N}_a/\pi_1(Y) \cong N$  is compact. It follows that  $D|_{\tilde{N}_a}$  is an embedding. Moreover let  $p \in \tilde{N}_a$  and  $q \in \tilde{N}_b$  with  $a \neq b$ , since we have that  $T(D(p)) = a$  and  $T(D(q)) = b$  it follows  $D(p) \neq D(q)$ . Thus the map  $D$  is an embedding of  $Y$  in  $\mathcal{D}_\tau$ . This map induces to the quotient the embedding  $Y \rightarrow Y_\tau$ . ■

## 6 Continuous family of Domains of Dependence

We use the notation introduced in the previous sections. In particular  $\Gamma$  is a free-torsion cocompact and discrete subgroup of  $\text{SO}^+(n, 1)$  and  $M = \mathbb{H}^n/\Gamma$ . We have seen that there exists a well defined correspondence

$$\mathbb{H}^1(\Gamma, \mathbb{R}^{n+1}) \ni [\tau] \mapsto [Y_\tau] \in \mathcal{T}_{Lor}(M)$$

where  $Y_\tau$  is the quotient of the unique  $\Gamma_\tau$ -invariant future complete regular domain  $\mathcal{D}_\tau$  by the action of the deformed group  $\Gamma_\tau$  (we recall that  $\mathcal{T}_{Lor}(M)$  is the Teichmüller space of the globally hyperbolic flat Lorentzian structure on  $\mathbb{R} \times M$  with a spacelike Cauchy surface). In this section we shall show that this correspondence is continuous.

More precisely, we shall prove that for every boundend neighborhood  $U$  of 0 in  $Z^1(\Gamma, \mathbb{R}^{n+1})$  there is a continuous map

$$dev : U \times (\mathbb{R}_+ \times \tilde{M}) \rightarrow \mathbb{M}^{n+1}$$

such that for every  $\sigma \in U$  the map  $dev_\sigma = dev(\sigma, \cdot)$  is a developing map with holonomy equal to  $\rho_\sigma$  (notice that  $\pi_1(\mathbb{R}_+ \times M) = \pi_1(M) = \Gamma$ ) and it is a homeomorphism onto  $\mathcal{D}_\sigma$ .

We start with the map

$$dev^0 : U \times \tilde{M} \rightarrow \mathbb{M}^{n+1} \tag{8}$$

constructed in theorem 3.4. We know that  $dev_\sigma^0$  is an embedding onto a  $\Gamma_\sigma$ -invariant strictly convex spacelike hypersurface and the map  $dev_\sigma^0$  is  $\Gamma$ -equivariant in the following sense

$$dev_\sigma^0(\gamma x) = \gamma_\sigma dev_\sigma^0(x).$$

For every  $\sigma \in U$  let  $\tilde{F}_\sigma = dev_\sigma^0(\tilde{M})$ . Now fix an orthonormal affine coordinates system  $(y_0, \dots, y_n)$ . We know that for every  $\sigma \in U$  there exists a convex function  $\varphi_\sigma : \{y_0 = 0\} \rightarrow \mathbb{R}$  such that  $\tilde{F}_\sigma$  is the graph of  $\varphi_\sigma$ . The first remark is that  $\varphi_\sigma$  is a continuous function of  $\sigma$ . More exactly let  $(\sigma_k)_{k \in \mathbb{N}}$  be a sequence in  $U$  which converges to  $\sigma$  in  $U$  then  $\varphi_{\sigma_k}$  converges to  $\varphi_\sigma$  in compact open topology of the plane  $\{y_0 = 0\}$ .

We know that for every  $\sigma \in U$  the domain  $\mathcal{D}_\sigma$  is the domain of dependence of  $\tilde{F}_\sigma$ . Now let  $\psi_\sigma : \{y_0 = 0\} \rightarrow \mathbb{R}$  such that  $\partial \mathcal{D}_\sigma$  is the graph of  $\psi_\sigma$ . We want to prove that  $\psi_\sigma$  is a continuous function of  $\sigma$

**Proposition 6.1** *Let  $(\tau_k)_{k \in \mathbb{N}}$  be a sequence in  $U$  which converges to  $\tau \in U$ . Then the maps  $\psi_{\tau_k}$  converge to  $\psi_\tau$  in compact open topology.*

*Proof :* First let us show that the family  $\{\psi_{\tau_k} : \{y_0 = 0\} \rightarrow \mathbb{R}\}_{k \in \mathbb{N}}$  is locally bounded and equicontinuous. Since two points on  $\partial \mathcal{D}_{\tau_k}$  are not chronological related it follows that the maps

$\psi_{\tau_k}$  are 1-Lipschitzian so that they form an equicontinuous family. We have to prove that they are locally bounded. Now we know that  $\varphi_{\tau_k} \rightarrow \varphi_\tau$  and since  $\tilde{F}_\tau$  is contained in  $\mathcal{D}_\tau$  we have  $\psi_{\tau_k} \leq \varphi_{\tau_k}$ . On the other hand we can construct a family of future strictly convex  $\Gamma_\tau$ -invariant spacelike hypersurfaces  $\left\{ \tilde{F}_\sigma^- \right\}_{\sigma \in U}$  which “vary” continuously. So let  $\varphi_\sigma^- : \{y_0 = 0\} \rightarrow \mathbb{R}$  such that  $\tilde{F}_\sigma^-$  is the graph of  $\varphi_\sigma^-$ . We have that  $\varphi_{\tau_k}^- \rightarrow \varphi_\tau^-$ . But the domain of dependence of  $F_{\tau_k}^-$  is  $\mathcal{D}_{\tau_k}^-$  and since it is disjoint from  $\mathcal{D}_{\tau_k}$  we deduce that

$$\varphi_{\tau_k}^- \leq \psi_{\tau_k} \leq \varphi_{\tau_k}.$$

Thus  $\{\varphi_{\tau_k}^-\}_{k \in \mathbb{N}}$  and  $\{\varphi_{\tau_k}\}_{k \in \mathbb{N}}$  are convergent and hence locally bounded. It follows that  $\psi_{\tau_k}$  is locally bounded too.

Now it remains to prove that  $\psi_{\tau_k} \rightarrow \psi_\infty$  then  $\psi_\infty = \psi_\tau$ . We have that  $\psi_\infty$  is a convex function and the graph  $S$  of  $\psi_\infty$  is  $\Gamma_\tau$ -invariant. Furthermore since  $\psi_\infty$  is 1-Lipshitz function then  $S$  has only non-timelike support plane. Hence  $I^+(S)$  is the future of the graph of  $\psi_\infty$  and it is a future convex set. It is easy to see that  $I^+(S)$  is a future complete regular domain. Since it is  $\Gamma_\tau$ -invariant by theorem 5.1 we get  $I^+(S) = \mathcal{D}_\tau$ . Thus  $\text{graph}\psi_\infty = \partial\mathcal{D}_\tau$  and so  $\psi_\infty = \psi_\tau$ . ■

Fix  $K$  a compact subset of  $\mathcal{D}_\tau$ . The last proposition implies that there exists a neighborhood  $V$  of  $\tau$  (which depends on  $K$ ) such that if  $\tau \in V$  then  $K \subset \mathcal{D}_\tau$ . Thus for every  $\tau \in V$  the cosmological time  $T_\tau$ , the normal field  $N_\tau$  and the retraction  $r_\tau$  of the domain  $\mathcal{D}_\tau$  are maps defined over  $K$ . The following propositions show that these maps change continuously on  $K$  when  $\tau$  varies in  $V$ .

**Proposition 6.2** *Let  $\{\tau_k\}$  be a sequence of cocycles which belongs to the neighborhood  $V$  of  $\tau$ . Then the sequences of function  $\{T_{\tau_k}|_K\}$  converges uniformly to  $T_\tau|_K$  on  $K$ .*

In order to prove the proposition we need the following technical lemma.

**Lemma 6.3** *For  $C \in \mathbb{R}$  and for every cocycle  $\sigma$  let*

$$K_C(\sigma) = \{x \in \{y_0 = 0\} | \psi_\sigma(x) \leq C\}$$

*( $\psi_\sigma$  is the function defined over the horizontal plane such that  $\partial\mathcal{D}_\sigma$  is the graph of such function) Then for every  $C \in \mathbb{R}$  and  $\varepsilon > 0$  there exists  $k_0 \in \mathbb{N}$  such that*

$$K_{C-\varepsilon}(\tau) \subset K_C(\tau_k) \subset K_{C+\varepsilon}(\tau) \quad \text{for all } k \geq k_0.$$

*For every cocycles  $\sigma$  put  $M(\sigma)$  the minimum of the function  $\psi_\sigma : \{y_0 = 0\} \rightarrow \mathbb{R}$ . Then the sequence  $M(\tau_k)$  converges to  $M(\tau)$ .*

*Proof :* Notice that  $K_C(\sigma)$  is a convex compact set, moreover if  $C > M(\sigma)$  then  $K_C(\sigma)$  has non-empty interior part and  $\partial K_C(\sigma)$  is the level set  $\{x | \psi_\sigma(x) = C\}$ .

Now let  $M = M(\tau)$ . First let us show the first statement for  $C > M$ . Fix  $\varepsilon > 0$  and let  $k_0 \in \mathbb{N}$  such that  $\|\psi_\tau - \psi_{\tau_k}\|_{\infty, K_{C+\varepsilon}(\tau)} < \frac{\varepsilon}{2}$  for all  $k \geq k_0$ . Clearly  $K_{C-\varepsilon}(\tau) \subset K_C(\tau_k)$  for all  $k \geq k_0$ . Now let  $x \notin K_{C+\varepsilon}(\tau)$ . I claim that  $\psi_{\tau_k}(x) \geq C + \frac{\varepsilon}{2}$  for all  $k \geq k_0$  and this proves the other inclusion.

Let  $k > k_0$  and fix  $x_0$  such that  $\psi_\tau(x_0) = M$ . Consider the map  $c(t) = \psi_{\tau_k}(x_0 + t(x - x_0))$  for  $t \in [0, 1]$ . Let  $t_0$  such that  $y_0 + t_0(x - x_0) \in \partial K_{C+\varepsilon}(\tau)$ . We have that  $c(0) \leq M + \frac{\varepsilon}{2}$  and  $c(t_0) \geq C + \frac{\varepsilon}{2}$ . By imposing that  $c(t_0) \leq (1 - t_0)c(0) + t_0c(1)$  we get that  $\psi_{\tau_k}(x) = c(1) \geq C + \frac{\varepsilon}{2}$ .

Now suppose  $C < M$ . Fix  $k_0$  such that  $K_{M+1}(\tau_k)$  is contained in  $K_{M+2}(\tau)$  and  $\|\psi_\tau - \psi_{\tau_k}\|_{\infty, K_{M+2}(\tau)} < \frac{M-C}{2}$  for all  $k > k_0$ . Then it turns out that  $K_C(\tau_k) = \emptyset$  for all  $k > k_0$ .

By this fact it turns out that  $M(\tau) \leq \underline{\lim}_{k \rightarrow +\infty} M(\tau_k)$ . On the other hand since  $\psi_{\tau_k}$  converges to  $\psi_\tau$  one easily see that  $M(\tau) \geq \overline{\lim}_{k \rightarrow +\infty} M(\tau_k)$ . ■

Now we can prove the proposition 6.2.

*Proof :* Let  $M$  be the minimum of  $\psi_\tau$ . By lemma 6.3 there exists  $k_0$  such that  $\psi_{\tau_k} > M - 1$  for all  $k \geq k_0$ . Now notice that the set  $J^-(K) \cap \{y_0 \geq M - 1\}$  is compact set and let  $H$  be the projection of it on the horizontal plane  $\{y_0 = 0\}$ . Fix  $\varepsilon > 0$  and let  $k(\varepsilon)$  such that  $\|\psi_\tau - \psi_{\tau_k}\|_{\infty, H} < \frac{\varepsilon}{2}$  for  $k \geq k(\varepsilon)$ .

Let  $p \in K$  and  $r$  be the projection of  $p$  on  $\partial\mathcal{D}_\tau$ : notice that  $r \in J^-(K) \cap \{y_0 \geq M - 1\}$ . Now if  $k \geq k(\varepsilon)$  then  $r + \varepsilon \frac{\partial}{\partial y_0}$  belongs to  $\mathcal{D}_{\tau_k}$  so that

$$T_{\tau_k}(p) > \sqrt{-\left\langle p - r + \varepsilon \frac{\partial}{\partial y_0}, p - r + \varepsilon \frac{\partial}{\partial y_0} \right\rangle}.$$

Now notice that  $-\left\langle p - r + \varepsilon \frac{\partial}{\partial y_0}, p - r + \varepsilon \frac{\partial}{\partial y_0} \right\rangle = -T_\tau(p)^2 - \varepsilon^2 + 2\varepsilon(p-r)_0$ . By the compactness of  $J^-(K) \cap \{y_0 \geq M\}$  there exists a constant  $C$  such that

$$T_{\tau_k}(p) > \sqrt{T_\tau(p)^2 + \varepsilon^2 - 2C\varepsilon}$$

Now fix  $\eta > 0$ , we can choose  $\varepsilon > 0$  so that  $2\varepsilon C - \varepsilon^2 \leq \eta^2$ . So we have that  $T_{\tau_k}(p) > T_\tau(p) - \eta$  for all  $k \geq k(\varepsilon)$  and  $p \in K$ .

On the other hand we have that the projection  $r_k(p)$  of  $x$  on  $\partial\mathcal{D}_{\tau_k}$  lies in  $J^-(K) \cap \{y_0 \geq M - 1\}$  and so the same argument shows that  $T_\tau(p) > T_{\tau_k}(p) - \eta$  for all  $k > k(\varepsilon)$  and  $p \in K$ . ■

Let  $\psi_\tau^a : \{y_0 = 0\} \rightarrow \mathbb{R}$  such that  $\text{graph}(\psi_\tau^a)$  is the CT level surface  $\tilde{S}_a(\tau) := T_\tau^{-1}(a)$ . The proposition 6.2 implies that these maps are continuous functions of  $\tau$ .

**Corollary 6.4** *If  $\tau_k \rightarrow \tau$  then  $\psi_{\tau_k}^a \rightarrow \psi_\tau^a$  in the compact-open topology of  $\{y_0 = 0\}$ .*

*Proof :* Since the maps  $\psi_{\tau_k}^a$  are 1-Lipschitz  $\{\psi_{\tau_k}^a\}_{k \in \mathbb{N}}$  is an equicontinuous family. On the other hand notice that

$$\psi_{\tau_k} < \psi_{\tau_k}^a < \psi_{\tau_k} + a.$$

Since  $\{\psi_{\tau_k}\}$  is locally bounded it follows that  $\{\psi_{\tau_k}^a\}_{k \in \mathbb{N}}$  is bounded. From proposition 6.2 it follows that if  $\psi_{\tau_k}^a$  converges then the limit is  $\psi_\tau^a$ . ■

Now let us prove the retraction  $r_\tau$  and the normal field  $N_\tau$  are continuous functions of  $\tau$ .

**Proposition 6.5** *Let  $\tau_k \rightarrow \tau$  be as above. Let  $r_k$  and  $N_k$  be respectively the retraction and the normal field of  $\mathcal{D}_{\tau_k}$ . Now fix a compact subset  $K$  of  $\mathcal{D}_\tau$ . The maps  $r_k|_K$  and  $N_k|_K$  converge in the compact open topology of  $K$  respectively to the retraction  $r$  and to the normal field  $N$  of the domain  $\mathcal{D}_\tau$ .*

*Proof :* Let  $M$  be the minimum of the map  $\psi_\tau$  and fix  $k_0$  such that  $\psi_{\tau_k} \geq M + 1$  for all  $k \geq k_0$ . In particular  $r_k(p) \in J^-(K) \cap \{y_0 \geq M - 1\}$  for all  $p \in K$  and  $k > k_0$ . Since  $J^-(K) \cap \{y_0 \geq M - 1\}$  is compact we can choose  $C$  such that  $\|p - r_k(p)\| \leq C$  for all  $p \in K$  and  $k \geq k_1$  ( $\|\cdot\|$  is the euclidean norm). On the other hand because of the proposition 6.2 we can choose  $k_1 > k_0$  such that

$$T_{\tau_k}(p) \geq \alpha > 0 \quad \text{for all } p \in K \text{ and } k \geq k_1.$$



Thus the image  $N_k(K)$  is contained in the set  $H = \{x \in \mathbb{H}^n \mid \|x\| \leq \frac{C}{\alpha}\}$  for all  $k \geq k_1$ . This is a compact set of  $\mathbb{H}^n$  so that the family of functions  $\{N_k|_K\}$  is bounded.

In order to show that  $N_k|_K \rightarrow N|_K$  it is sufficient to prove that  $N_k(p_k) \rightarrow N(p)$  for all convergent sequences  $p_k \rightarrow p$ . Since  $N_k(p_k)$  runs in a compact set of  $\mathbb{H}^n$  we can suppose that  $N_k(p_k)$  converges to a timelike vector  $v$ . Let  $a = T(p)$ , in order to show that  $N(p) = v$  it is sufficient to prove that  $p + v^\perp$  is a support plane for the surface  $\tilde{S}_a = T^{-1}(a)$  i.e. we have to prove the following inequality

$$\langle q, v \rangle \leq \langle p, v \rangle \quad \text{for all } q \in \tilde{S}_a. \quad (9)$$

Fix  $q \in \tilde{S}_a$  and let  $q = (\psi_\tau^a(y), y)$ . Let  $a_k = T_k(p_k)$  and we consider the sequences

$$\begin{aligned} q_k &:= (\psi_{\tau_k}^{a_k}(y), y); \\ q'_k &:= (\psi_{\tau_k}^a(y), y). \end{aligned}$$

By corollary 6.4 we have that  $q'_k \rightarrow q$ . On the other hand it turns out that  $\|q_k - q'_k\| \leq |a_k - a|$  so that  $q_k \rightarrow q$ . We know that  $\langle q_k, N_k(p) \rangle \leq \langle p_k, N_k(p) \rangle$ : by passing to the limit the inequality (9) follows.

Since  $r_k + T_k N_k = id$  we get that  $r_k|_K \rightarrow r|_K$  uniformly. ■

**Corollary 6.6** *Let  $K$  as above. Then the cosmological times  $T_{\tau_k}$  converge to  $T_\tau$  in the  $C^1$ -topology of  $C^1(K)$ .* ■

Now let us go back to the original problem.

**Theorem 6.7** *For every boundend neighborhood  $U$  of 0 in  $Z^1(\Gamma, \mathbb{R}^{n+1})$  there exists a continuous map*

$$dev : U \times (\mathbb{R}_+ \times \tilde{M}) \rightarrow \mathbb{M}^{n+1}$$

such that for every  $\sigma \in U$

1.  $dev_\sigma$  is a developing map whose holonomy is  $\rho_\sigma$ ;
2.  $dev_\sigma$  is a homeomorphism with  $\mathcal{D}_\sigma$ .

*Proof :* Let  $dev^0 : U \times \mathbb{H}^n \rightarrow \mathbb{M}^{n+1}$  be the map defined in (8). Now fix  $\sigma \in U$ ,  $x \in \mathbb{H}^n$  and  $t > 0$ . Consider the timelike geodesic  $\gamma$  in  $\mathcal{D}_\sigma$  which passes through  $dev_\sigma^0(x)$  and has the direction of the normal field in  $dev_\sigma^0(x)$ . Now put  $dev(\sigma, t, x)$  the point on  $\gamma$  with CT equal to  $t$ :

$$dev(\sigma, t, x) = r_\sigma(dev_\sigma^0(x)) + tN_\sigma(dev_\sigma^0(x)).$$

Clearly  $dev$  satisfies the three properties required. On the other hand by propositions 6.2 and 6.5 one easily see that it is continuous. ■

**Remark 6.8** With the proof of theorem 6.7 the proof of theorem 2.4 is complete. In the following section we shall prove theorem 2.5.

**Remark 6.9** Notice that the coordinate  $t$  on  $\mathbb{R}_+ \times \widetilde{M}$  coincides with the pull back of the cosmological times by the map  $dev_\sigma$ , i.e.

$$T_\sigma(dev_\sigma(t, x)) = t$$

On the other hand notice that  $r_\sigma(dev_\sigma(t, x))$  and  $N_\sigma(dev_\sigma(t, x))$  depend only on the  $x$  coordinate. Thus there are well defined functions

$$\begin{aligned} \mathbf{r}_\sigma &: \widetilde{M} \rightarrow \Sigma_\tau \\ \mathbf{N}_\sigma &: \widetilde{M} \rightarrow \mathbb{H}^n \end{aligned}$$

such that  $r_\sigma(dev_\sigma(t, x)) = \mathbf{r}_\sigma(x)$  and  $N_\sigma(dev_\sigma(t, x)) = \mathbf{N}_\sigma(x)$ .

The map  $dev$  is only continuous. But we can smooth this map to obtain a  $C^\infty$  map  $dev'$  which verifies the properties required in the above theorem. In fact it is easy to see that we can perturb the normal field  $N_\sigma$  on  $\mathcal{D}_\sigma$  to obtain a  $\Gamma_\tau$ -invariant  $C^\infty$  timelike vector field  $V_\sigma$ . By considering the restriction of the flow of this vector field on the Cauchy surface  $\widetilde{F}_\sigma$  we obtain a  $C^\infty$  developing map  $dev'_\sigma$  which verifies the properties 1. and 2. of theorem 6.7.

We can construct the field  $V_\sigma$  such that  $V_0$  coincides with  $N_0$  and  $V_\sigma$  “varies continuously” with  $\sigma$  in the following sense: for every convergent sequence  $\tau_k \rightarrow \tau$  and for every open set  $K \subset \mathcal{D}_\tau$  the fields  $V_{\tau_k}|_K$  converge to  $V_\tau|_K$  in the  $C^\infty$  topology of  $K$ . In this way it is easy to see that the map  $dev'(\sigma, x) = dev'_\sigma(x)$  is  $C^\infty$  map which verifies the properties required in the theorem.

## 7 Gromov Convergence of the CT-Level Surfaces

Let us summarize what we have seen until now. We have fixed a closed hyperbolic  $n$ -manifold  $M$  and we have identified  $\pi_1(M)$  with a free-torsion co-compact discrete subgroup of  $SO^+(n, 1)$ , say  $\Gamma$ , such that  $M = \mathbb{H}^n/\Gamma$ . Given a cocycle  $\tau \in Z^1(\Gamma, \mathbb{R}^{n+1})$  we have considered the deformation  $\Gamma_\tau$  of  $\Gamma$ . We have proved that there exists a unique  $\Gamma_\tau$ -invariant future complete regular domain  $\mathcal{D}_\tau$  such that the action is free and properly discontinuous and the quotient is a globally hyperbolic spacetime diffeomorphic to  $\mathbb{R}_+ \times M$ . The domain  $\mathcal{D}_\tau$  is provided with a  $\Gamma_\tau$ -invariant regular cosmological time  $T$  which is a  $C^1$ -submersion. Moreover there exists a retraction map  $r : \mathcal{D}_\tau \rightarrow \Sigma$  onto the singularity in the past and a normal field  $N : \mathcal{D}_\tau \rightarrow \mathbb{H}^n$  which is up to the sign the Lorentzian gradient of the cosmological time  $T$ . The level surfaces  $\widetilde{S}_a = T^{-1}(a)$  are  $C^1$  spacelike hypersurfaces, so that there is a natural path distance  $d_a$  on it. Since  $\widetilde{S}_a$  is  $\Gamma_\tau$ -invariant and  $\widetilde{S}_a/\Gamma_\tau \cong M$  is compact by Hopf-Rinow theorem we get that  $d_a$  is a complete distance. In this section we study the metric properties of the surface  $\widetilde{S}_a$  and in particular the asymptotic behaviour for  $a \rightarrow +\infty$  and for  $a \rightarrow 0$ .

In the previous section we have constructed a developing map

$$dev_\tau : \mathbb{R}_+ \times \widetilde{M} \rightarrow \mathbb{M}^n$$

such that  $dev_\tau(\{a\} \times \widetilde{M}) = \widetilde{S}_a$  and there exist well defined maps

$$\begin{aligned} \mathbf{r} &: \widetilde{M} \rightarrow \Sigma \\ \mathbf{N} &: \widetilde{M} \rightarrow \mathbb{H}^n \end{aligned}$$

such that  $r(dev_\tau(t, x)) = \mathbf{r}(x)$  and  $N(dev_\tau(t, x)) = \mathbf{N}(x)$ . By taking the pull-back of the distance  $d_a$  on  $\widetilde{S}_a$  we get a family of distance  $\delta_a$  on  $\widetilde{M}$  such that  $\pi_1(M)(= \Gamma)$  acts by isometry on  $(\widetilde{M}, \delta_a)$ .

The principal results of this section are the following propositions.

**Proposition 7.1** For all  $x, y \in \widetilde{M}$

$$\lim_{a \rightarrow +\infty} \frac{\delta_a(x, y)}{a} = d_{\mathbb{H}}(\mathbf{N}(x), \mathbf{N}(y))$$

where  $d_{\mathbb{H}}$  is the distance of  $\mathbb{H}^n$ . Moreover the maps  $a^{-1}\delta_a$  converge in the compact open topology of  $C(\widetilde{M} \times \widetilde{M})$  to the map  $(x, y) \mapsto d_{\mathbb{H}}(\mathbf{N}(x), \mathbf{N}(y))$ . ■

**Proposition 7.2** There exists a natural distance  $d_{\Sigma}$  on  $\Sigma$  such that

$$\lim_{a \rightarrow 0} \delta_a(x, y) = d_{\Sigma}(\mathbf{r}(x), \mathbf{r}(y)) \quad \text{for all } x \in \widetilde{M}.$$

Moreover the maps  $\delta_a$  converge in the compact open topology of  $C(\widetilde{M} \times \widetilde{M})$  to the map  $(x, y) \mapsto d_{\Sigma}(\mathbf{r}(x), \mathbf{r}(y))$ . ■

We shall see that proposition 7.1 implies that the action of  $\Gamma_{\tau}$  on  $\widetilde{S}_a$  converge for  $a \rightarrow +\infty$  in the Gromov sense to the action of  $\Gamma_{\tau}$  on  $\mathbb{H}^n$ . For the  $a \rightarrow 0$  we can deduce by proposition 7.2 only the convergence of the spectrum of the action of  $\Gamma_{\tau}$  on  $\widetilde{S}_a$  to the spectrum of the action of  $\Gamma_{\tau}$  on  $\Sigma$ .

We start showing that  $\{\delta_a\}_{a>0}$  and  $\{a^{-1}\delta_a\}_{a>0}$  are respectively increasing and decreasing functions of  $a$ .

**Lemma 7.3** Fix a Lipschitz path  $c : [0, 1] \rightarrow \widetilde{S}_a$ , then the paths  $N(t) = N(c(t))$  and  $r(t) = r(c(t))$  are differentiable almost everywhere and we have

$$\begin{aligned} N(t) &= N(0) + \int_0^t \dot{N}(s) ds; \\ r(c(t)) &= r(c(0)) + \int_0^t \dot{r}(s) ds. \end{aligned}$$

Moreover we have that  $\dot{N}(t)$  and  $\dot{r}(t)$  lie into  $T_{c(t)}\widetilde{S}_a$  (so they are spacelike) and  $\langle \dot{N}(t), \dot{r}(t) \rangle > 0$  almost everywhere.

*Proof :* In order to prove the first statement it is sufficient to show that the maps  $N : \widetilde{S}_a \rightarrow \mathbb{H}^n \subset \mathbb{M}^{n+1}$  and  $r : \widetilde{S}_a \rightarrow \Sigma \subset \mathbb{M}^{n+1}$  are locally Lipschitz with respect to the euclidean distance  $d_E$  of  $\mathbb{M}^{n+1}$ . Since  $p = r(p) + aN(p)$  it is sufficient to show that  $N$  is locally Lipschitz.

Fix a compact  $K \subset \widetilde{S}_a$  and let  $H = N(K)$ : since  $H$  is compact there exists a constant  $C$  such that

$$d_E(x, y) = \|x - y\| \leq C(\langle x - y, x - y \rangle)^{1/2}.$$

On the other hand by inequalities (5) we have that

$$(\langle N(p) - N(q), N(p) - N(q) \rangle)^{1/2} \leq \frac{1}{a}(\langle p - q, p - q \rangle)^{1/2}.$$

Since  $\langle p - q, p - q \rangle \leq \|p - q\|^2$  we deduce that  $\|N(p) - N(q)\| \leq \frac{C}{a}\|p - q\|$  for all  $p, q \in K$ .

Now notice that  $N(t)$  is a path in  $\mathbb{H}^n$  so that  $\dot{N}(t) \in T_{N(t)}\mathbb{H}^n = T_{c(t)}\widetilde{S}_a$ . Since  $\dot{r}(t) = \dot{c}(t) - a\dot{N}(t)$  we have that  $\dot{r}(t) \in T_{c(t)}\widetilde{S}_a$  almost everywhere. Finally by inequalities (5) we have that  $\langle N(t+h) - N(t), r(t+h) - r(t) \rangle \geq 0$ . Thus we easily deduce that  $\langle \dot{N}(t), \dot{r}(t) \rangle \geq 0$ . ■

**Lemma 7.4** For all  $x, y \in \widetilde{M}$  and for all  $a < b$  we have

$$\begin{aligned} \delta_a(x, y) &\leq \delta_b(x, y) \\ d_{\mathbb{H}}(\mathbf{N}(x), \mathbf{N}(y)) &\leq \frac{1}{b} \delta_b(x, y) \leq \frac{1}{a} \delta_a(x, y). \end{aligned}$$

*Proof* : For  $t > 0$  let  $p_t = dev_\tau(t, x)$  and  $q_t = dev_\tau(t, y)$ . Let  $c_b : [0, 1] \rightarrow \widetilde{S}_b$  be a minimizing-length geodesic path between  $p_b$  and  $q_b$ . Consider  $r(t) = r(c_b(t))$  and  $N(t) = N(c_b(t))$  and let  $c : [0, 1] \rightarrow \widetilde{S}_a$  be the path defined by the rule  $c(t) := r(t) + aN(t)$ . We have that  $c$  is a rectifiable arc between  $p_a$  and  $q_a$  so that the length of  $c$  is greater than the distance  $\delta_a(x, y)$ . Now notice that  $\dot{c}_b(t) = \dot{c}(t) + (b-a)\dot{N}(t)$ . By lemma 7.3 we get that  $\langle \dot{c}_b(t), \dot{c}_b(t) \rangle \geq \langle \dot{c}(t), \dot{c}(t) \rangle$ . This proves that the length of  $c_b$  is greater than the length of  $c$  and so the first inequality follows. Now we shall prove the second one.

Let  $c : [0, 1] \rightarrow \widetilde{S}_a$  be a Lipschitz path and let  $N(t) = N(c(t))$ . By lemma 7.3 we have that  $a^2 \langle \dot{N}(t), \dot{N}(t) \rangle \leq \langle \dot{c}(t), \dot{c}(t) \rangle$ . By this inequality it follows that  $d_{\mathbb{H}}(N(p), N(q)) \leq \frac{1}{a} d_a(p, q)$  for all  $p, q \in \widetilde{S}_a$ . On the other hand let  $x, y \in \widetilde{M}$  and  $c_a : [0, 1] \rightarrow \widetilde{S}_a$  the  $d_a$ -minimizing geodesic between  $p_a = dev_\tau(a, x)$  and  $q_a = dev_\tau(a, y)$ . Let  $c(t) = c_a(t) + (b-a)N(t)$  (where  $N(t) = N(c_a(t))$ ): the endpoints of this path are  $p_b$  and  $q_b$  so that

$$\frac{\delta_b(x, y)}{b} = \frac{d_b(p_b, q_b)}{b} \leq \frac{1}{b} \int_0^1 \langle \dot{c}(t), \dot{c}(t) \rangle^{1/2} dt.$$

By lemma 7.3 we know that  $a^2 \langle \dot{N}(t), \dot{N}(t) \rangle \leq \langle \dot{c}_a(t), \dot{c}_a(t) \rangle$  so that

$$\begin{aligned} \langle \dot{c}(t), \dot{c}(t) \rangle^{1/2} &\leq \langle \dot{c}_a(t), \dot{c}_a(t) \rangle^{1/2} + (b-a) \langle \dot{N}(t), \dot{N}(t) \rangle^{1/2} \leq \\ &\langle \dot{c}_a(t), \dot{c}_a(t) \rangle^{1/2} + \frac{(b-a)}{a} \langle \dot{c}_a(t), \dot{c}_a(t) \rangle^{1/2} = \frac{b}{a} \langle \dot{c}_a(t), \dot{c}_a(t) \rangle^{1/2}. \end{aligned}$$

Thus we have

$$\frac{\delta_b(x, y)}{b} \leq \frac{1}{a} \int_0^1 (\langle \dot{c}_a(t), \dot{c}_a(t) \rangle)^{1/2} dt = \frac{\delta_a(x, y)}{a}.$$

■

Now we can prove proposition 7.1.

*Proof of proposition 7.1*: Let  $x, y \in \widetilde{M}$ : by lemma 7.4 we have that  $\frac{1}{a} \delta_a(x, y)$  is decreasing with respect  $a$  so that there exists

$$\delta_\infty(x, y) = \lim_{a \rightarrow +\infty} \frac{1}{a} \delta_a(x, y).$$

Let us show that  $a^{-1} \delta_a$  converges to  $\delta_\infty$  in the compact open topology of  $\widetilde{M}$ . Since  $a^{-1} \delta_a \leq \delta_1$  the family  $\{a^{-1} \delta_a|_K\}_{a>1}$  is locally bounded. On the other hand by triangular inequality we have for  $a > 1$

$$|a^{-1} \delta_a(x, y) - a^{-1} \delta_a(x', y')| \leq a^{-1} \delta_a(x, x') + a^{-1} \delta_a(y, y') \leq \delta_1(x, x') + \delta_1(y, y').$$

Thus the family  $\{a^{-1} \delta_a|_K\}_{a>1}$  is equicontinuous. By these remarks we easily get that  $a^{-1} \delta_a \rightarrow \delta_\infty$  in the compact open topology of  $\widetilde{M} \times \widetilde{M}$ .

Clearly  $\delta_\infty$  is a pseudo-distance on  $\widetilde{M}$ . We claim that  $\delta_\infty(x, y) = 0$  if and only if  $\mathbf{N}(x) = \mathbf{N}(y)$ . In fact from lemma 7.4 it follows that

$$d_{\mathbb{H}}(\mathbf{N}(x), \mathbf{N}(y)) \leq \frac{\delta_a(x, y)}{a}$$

so that  $d_{\mathbb{H}}(\mathbf{N}(x), \mathbf{N}(y)) \leq \delta_\infty(x, y)$ . Thus if  $d_\infty(x, y) = 0$  then  $\mathbf{N}(x) = \mathbf{N}(y)$ . On the other hand if  $\mathbf{N}(x) = \mathbf{N}(y)$  the segment  $[\mathbf{r}(x), \mathbf{r}(y)]$  is contained in  $\Sigma$  and one easily see that  $\frac{\delta_a(x, y)}{a} = \frac{1}{a}(\langle \mathbf{r}(y) - \mathbf{r}(x), \mathbf{r}(y) - \mathbf{r}(x) \rangle)^{1/2}$ . By passing to the limit we obtain that  $\delta_\infty(x, y) = 0$ .

It follows that there exists a distance  $d$  on  $\mathbb{H}^n$  such that

$$\delta_\infty(x, y) = d(\mathbf{N}(x), \mathbf{N}(y))$$

In the last part of this proof we shall show that  $d = d_{\mathbb{H}}$ . We already know that  $d_{\mathbb{H}} \leq d$ .

By using theorem 5.1 it is easy to see that  $\mathcal{D}_{\frac{\tau}{a}} = \frac{1}{a}\mathcal{D}_\tau$ . Consider the map

$$f : \mathcal{D}_\tau \ni p \mapsto \frac{p}{a} \in \mathcal{D}_{\frac{\tau}{a}}.$$

Let  $p \in \mathcal{D}_\tau$  and  $c_p$  be the Lorentz-length maximizing timelike geodesic of  $\mathcal{D}_\tau$  with future-endpoint equal to  $p$ . Then  $f(c_p)$  is a Lorentz-length maximizing timelike geodesic of  $\mathcal{D}_{\frac{\tau}{a}}$ . Since the length of  $f(c_p)$  is  $a^{-1}T_\tau(p)$  we get

$$T_{\frac{\tau}{a}}\left(\frac{p}{a}\right) = \frac{T_\tau(p)}{a}.$$

Thus  $\frac{1}{a}\widetilde{S}_a$  is the CT-level surface  $\widetilde{S}_1(\frac{\tau}{a}) = T_{\frac{\tau}{a}}^{-1}(1)$ . Moreover the distance  $a^{-1}\delta_a$  is the pull-back of the natural path-distance on  $\widetilde{S}_1(\frac{\tau}{a})$ .

First we claim that  $\lim_{a \rightarrow +\infty} \frac{p_a}{a} = N(x)$  and  $\lim_{a \rightarrow +\infty} \frac{q_a}{a} = N(y)$  (recall that  $p_a = dev_\tau(a, x)$  and  $q_a = dev_\tau(a, y)$ ). Fix a set of orthonormal affine coordinates  $(y_0, \dots, y_n)$  on  $\mathbb{M}^{n+1}$  such that  $\mathbf{N}(x) = \frac{\partial}{\partial y_0}$  and let

$$\psi_a : \{y_0 = 0\} \rightarrow \mathbb{R}$$

such that  $\widetilde{S}_1(\frac{\tau}{a}) = \text{graph}\psi_a$  and let  $N_a$  the normal field of  $\mathcal{D}_{a^{-1}\tau}$ . Since  $N_a(a^{-1}p_a) = N(p_a) = \mathbf{N}(x)$  by using lemma 6.3 we have that  $\{a^{-1}p_a\}_{a>1}$  is a bounded set. Suppose that  $a^{-1}p_a \rightarrow p$  we have to show that  $p = \mathbf{N}(x)$ . By corollary 6.4 we have that  $p \in \mathbb{H}^n$  and  $N_0(p) = \lim_{a \rightarrow +\infty} N_a(a^{-1}p_a) = \mathbf{N}(x)$ . Since the normal field on  $\mathbb{H}^n$  is the identity we get that  $p = \mathbf{N}(x)$ .

Now let  $c : [0, 1] \rightarrow \mathbb{H}^n$  be a geodesic path between  $\mathbf{N}(x)$  and  $\mathbf{N}(y)$

$$c(t) = (\psi_0(u(t)), u(t))$$

where  $\psi_0 : \{y_0 = 0\} \rightarrow \mathbb{R}$  is the function such that  $\mathbb{H}^n = \text{graph}\psi_0$ . Let  $c_a(t) = (\psi_a(u(t)), u(t))$  be the corresponding path on the surface  $\widetilde{S}_1(\frac{\tau}{a})$  and let  $p'_a = c_a(0)$  and  $q'_a = c_a(1)$ . Since  $\psi_a \rightarrow \psi_0$  in  $C^1$ -topology we have that

$$\int_0^1 (\langle \dot{c}_a(t), \dot{c}_a(t) \rangle)^{1/2} dt \rightarrow \int_0^1 (\langle \dot{c}(t), \dot{c}(t) \rangle)^{1/2} dt = d_{\mathbb{H}}(\mathbf{N}(x), \mathbf{N}(y)).$$

Let  $a^{-1}p_a = (\psi_a(v_a), v_a)$  and  $a^{-1}q_a = (\psi_a(w_a), w_a)$ : it is easy to see that

$$\frac{\delta_a(x, y)}{a} \leq \|v_a - u(0)\| + \|w_a - u(1)\| + \int_0^1 (\langle \dot{c}_a(t), \dot{c}_a(t) \rangle)^{1/2} dt$$

Since  $v_a \rightarrow u(0)$  and  $w_a \rightarrow u(1)$  by passing to the limit we get  $d(\mathbf{N}(x), \mathbf{N}(y)) \leq d_{\mathbb{H}}(\mathbf{N}(x), \mathbf{N}(y))$ . ■

We want to show that the action of  $\Gamma_\tau$  on  $(\tilde{S}_a, a^{-1}d_a)$  converges in the Gromov sense to the action of  $\Gamma$  on  $\mathbb{H}^n$  for  $a \rightarrow +\infty$ . For a complete definition of convergence in the Gromov sense of a sequence of isometric actions on metric spaces see for instance [12]. However we need only the following statement which is an immediate corollary of the definition.

*Suppose that  $\Gamma$  acts by isometries on a sequence of metric spaces  $(X_i, d_i)$  and on a metric space  $(X_\infty, d_\infty)$ . Suppose that there exists a sequence of  $\Gamma$ -equivariant maps  $\pi_i : X_i \rightarrow X_\infty$  which verifies the following property: for every  $K_\infty$  compact subset of  $X_\infty$  and  $\varepsilon > 0$  for  $i \gg 0$  there exists a compact  $K_i$  such that  $\pi_i(K_i) = K_\infty$  and  $|d_\infty(\pi_i(x), \pi_i(y)) - d_i(x, y)| < \varepsilon$  for all  $x, y \in K_i$ . Then the action of  $\Gamma$  on  $X_i$  converge in the sense of Gromov to the action of  $\Gamma$  on  $X_\infty$ .*

**Corollary 7.5** *The action of  $\Gamma_\tau$  on the rescaled surface  $(\tilde{S}_a, a^{-1}d_a)$  converges in the Gromov sense to the action of  $\Gamma$  on  $\mathbb{H}^n$ .*

*Proof :* We want to see that the maps  $N : \tilde{S}_a \rightarrow \mathbb{H}^n$  satisfy the condition above. Fix a compact  $K \subset \mathbb{H}^n$  and let  $H = \tilde{\mathbf{N}}^{-1}(K) \subset \tilde{M}$ . Since  $\mathbf{N}$  is a proper map we have that  $H$  is compact. Let  $K_a = \text{dev}_\tau(a, H) \subset \tilde{S}_a$ . By proposition 7.1 we have that for all  $\varepsilon > 0$  there exists  $a_0$  such that for all  $a > a_0$

$$\left| \frac{d_a(x, y)}{a} - d_{\mathbb{H}}(N(x), N(y)) \right| \leq \varepsilon \quad \text{for all } x, y \in K_a$$

Now we are interested in the asymptotic behaviour of the metrics  $\delta_a$  when  $a \rightarrow 0$ . The results are very similar to those that we have proved in the previous case. However in this case we shall see that there exist some technical problems in the proofs. In particular since  $\partial\mathcal{D}_\tau$  is an achronal set it is defined a notion of length of a curve: however the length of a curve can be 0. By taking the infimum of the lengths of the curves with fixed endpoints we get a *pseudo-distance* on  $\partial\mathcal{D}_\tau$ . The first problem arises when one tries to prove that this pseudo-distance restricted to  $\Sigma$  is in fact a distance. It seems to be more convenient to change viewpoint. First we show that the distances  $\delta_a$  converges to a pseudo-distance  $\delta_0$  on  $\tilde{M}$  such that

$$\delta_0(x, y) = 0 \quad \Leftrightarrow \quad \mathbf{r}(x) = \mathbf{r}(y).$$

By this implication it follows that there exists a distance  $d_\Sigma$  on  $\Sigma$  such that  $\delta_0(x, y) = d_\Sigma(\mathbf{r}(x), \mathbf{r}(y))$ . After we shall prove that this distance coincides with the natural path-distance on  $\Sigma$ .

**Proposition 7.6** *There exists a pseudo-distance  $\delta_0$  on  $\tilde{M}$  such that  $\delta_a \rightarrow \delta_0$  in the compact-open topology of  $\tilde{M} \times \tilde{M}$ . Moreover  $\delta_0(x, y) = 0$  if and only if  $\mathbf{r}(x) = \mathbf{r}(y)$ .*

*Proof :* By using lemma 7.4 one easily argues the first statement as in the proof of proposition 7.1.

The proof of the second statement is more difficult. We need the following technical lemma.

**Lemma 7.7** *Let  $\varphi : \mathbb{R}^n \rightarrow \mathbb{R}$  be a  $C^1$  convex function such that  $\|\nabla\varphi(x)\| < 1$  for all  $x \in \mathbb{R}^n$ . Let  $S = \{(x_0, \dots, x_n) \in \mathbb{M}^{n+1} | x_0 = \varphi(x_1, \dots, x_n)\}$  be the corresponding spacelike surface in the Minkowski space and suppose  $S$  complete. Let  $0$  be a minimum point of  $\varphi$ , then for every  $y \in \mathbb{R}^n$  there exists a distance-minimizing geodesic arc  $c(t) = (\varphi(x(t)), x(t))$  with starting point equal to  $(\varphi(0), 0)$  and ending point equal to  $(\varphi(y), y)$  such that the functions  $t \mapsto \|x(t)\|$  and  $t \mapsto \varphi(x(t))$  are increasing ( $\|\cdot\|$  is the euclidean norm of  $\mathbb{R}^n$ ).*

*Proof of lemma:* First suppose that  $\varphi$  is  $C^\infty$ . By imposing that  $c$  is a geodesic we deduce that the path  $x(t)$  satisfies the following equation

$$\ddot{x}(t) = \frac{\dot{x}H\varphi(x)\dot{x}}{(1 - \|\nabla\varphi(x)\|^2)^{3/2}}\nabla\varphi(x)$$

where  $H\varphi(x)$  is the Hessian matrix of  $\varphi$  in  $x$ .

Let  $f(t) = \|x(t)\|^2$ , we have that

$$\begin{aligned} \dot{f}(t) &= 2x(t) \cdot \dot{x}(t); \\ \ddot{f}(t) &= 2\left(\dot{x}(t) \cdot \dot{x}(t) + x(t) \cdot \ddot{x}(t)\right). \end{aligned}$$

Now we have that  $x(0) = 0$  so that  $\dot{f}(0) = 0$ . Hence it is sufficient to prove that  $\ddot{f}(t) \geq 0$  for  $t \geq 0$ . By looking at the last expression it follows that it is sufficient to show that  $x(t) \cdot \ddot{x}(t) \geq 0$ . Since  $\varphi$  is convex function we have that  $\dot{x}H\varphi(x)\dot{x} \geq 0$  so that  $x(t) \cdot \ddot{x}(t) \geq 0$  if and only if  $x \cdot \nabla\varphi(x) \geq 0$ . On the other hand by using that  $\varphi(0)$  is the minimum of  $\varphi$  and by imposing the convexity on the rays starting from  $0$  one easily deduces that this inequality holds for all  $x \in \mathbb{R}^n$ . An analogous calculation shows that  $t \mapsto \varphi(x(t))$  is increasing.

Now suppose that  $\varphi$  is only  $C^1$ . Let  $\{\rho_\varepsilon\}$  be a family of  $C^\infty$  positive functions on  $\mathbb{R}^n$  such that:

1.  $\text{supp}\rho_\varepsilon = \{x \in \mathbb{R}^n | \|x\| \leq \varepsilon\}$ ;
2.  $\int_{\mathbb{R}^n} \rho_\varepsilon = 1$ .

Let  $\varphi_\varepsilon$  the convolution  $\varphi * \rho_\varepsilon$

$$\varphi_\varepsilon(x) = \int_{\mathbb{R}^n} \varphi(x-y)\rho_\varepsilon(y)dy.$$

We know that  $\varphi_\varepsilon$  is  $C^\infty$  and  $\varphi_\varepsilon \rightarrow \varphi$  in  $C^1$ -topology. Moreover it is easy to see that  $\varphi_\varepsilon$  is a convex function so that  $S_\varepsilon := \text{graph}\varphi_\varepsilon$  is a  $C^\infty$  future convex spacelike surface.

Fix  $y \in \mathbb{R}^n$ . By using the completeness of  $S$  we have that for  $\varepsilon \ll 1$  there exists a path

$$x_\varepsilon : [0, L_\varepsilon] \rightarrow \mathbb{R}^n$$

such that

1.  $c_\varepsilon(t) = (\varphi_\varepsilon(x_\varepsilon(t)), x_\varepsilon(t))$  is a parametrization of a distance-minimizing geodesic arc of the surface  $S_\varepsilon$ ;
2.  $x_\varepsilon(0) = x$  and  $x_\varepsilon(L_\varepsilon) = y$ ;
3.  $\|\dot{x}_\varepsilon(t)\| = 1$  and  $L_\varepsilon$  is bounded.

Thus  $x_\varepsilon$  converges to a Lipschitz arc  $x(t)$  and it is easy to see that the path  $t \mapsto (\varphi(x(t)), x(t))$  is a distance-minimizing geodesic between  $(\varphi(0), 0)$  and  $(\varphi(y), y)$ .

Let  $p_\varepsilon(t)$  be the orthogonal projection of  $c_\varepsilon(t)$  onto  $T_{(\varphi_\varepsilon(x), x)}S_\varepsilon$

$$p_\varepsilon(t) = c_\varepsilon(t) + \frac{\langle c_\varepsilon(t), (1, \nabla\varphi_\varepsilon(x)) \rangle}{1 - \|\nabla\varphi_\varepsilon(x)\|^2} (1, \nabla\varphi_\varepsilon(x)).$$

We know that  $\langle p_\varepsilon(t), p_\varepsilon(t) \rangle$  is an increasing function of  $t$ . On the other hand since  $\nabla\varphi_\varepsilon(x) \rightarrow 0$  for  $\varepsilon \rightarrow 0$  we get that  $p_\varepsilon(t) \rightarrow x(t)$ . Thus  $\|x(t)\|$  is an increasing function of  $t$ . ■

Let us go back to the proof of proposition. We have to show that for all  $x, y \in \widetilde{M}$  such that  $\delta_0(x, y) = 0$  we have  $\mathbf{r}(x) = \mathbf{r}(y)$ . By contradiction suppose that there exist  $x, y \in \widetilde{M}$  such that  $\delta_0(x, y) = 0$  and  $\mathbf{r}(x) \neq \mathbf{r}(y)$ . Fix a set of affine coordinates  $(y_0, \dots, y_n)$  in such way that  $\frac{\partial}{\partial y_0} = \mathbf{N}(x)$  and  $\mathbf{r}(x) = 0$ . Let  $\widetilde{S}_a = \text{graph}\varphi_a$  and  $\partial\mathcal{D}_\tau = \text{graph}\varphi$ . Moreover let  $p_a = \text{dev}(a, x) = (a, 0)$  and  $q_a = \text{dev}(a, y) = (\varphi(z_a), z_a)$ . Now for all  $a > 0$  fix a distance-minimizing geodesic path

$$c_a(t) = (\varphi_a(x_a(t)), x_a(t)) \quad \text{for } t \in [0, L_a]$$

between  $p_a$  and  $q_a$  such that  $\|x_a(t)\|$  is increasing. Since  $z_a \rightarrow z_0$  for  $a \rightarrow 0$  there exists a constant  $K$  such that

$$\|x_a(t)\| \leq K \quad \text{for all } a \leq 1.$$

First suppose that there exists a sequence  $a_k$  such that  $L_{a_k}$  is bounded. Then up to passing to a subsequence we have that  $x_{a_k}$  converges to a 1-Lipschitz path  $x : [0, L] \rightarrow \mathbb{R}^n$  such that  $x(0) = 0$  and  $x(L) = z_0$ . Let  $\varphi_a(t) := \varphi_a(x(t))$  then by the hypothesis on  $\delta_0$  we have that

$$\lim_{k \rightarrow +\infty} \int_0^{L_{a_k}} \sqrt{1 - \dot{\varphi}_{a_k}(t)^2} dt = 0$$

Thus  $|\dot{\varphi}_{a_k}(t)| \rightarrow 1$  for almost all  $t \in [0, L]$ . By lemma 7.7 we know that  $\varphi_{a_k}(x_a(t))$  are increasing functions of  $t$  so that  $\dot{\varphi}_{a_k}(t) \rightarrow 1$ . Thus we have that  $\varphi_{a_k}(t) - \varphi_{a_k}(s) \rightarrow t - s$ . On the other hand we have that  $\varphi_{a_k}(t) - \varphi_{a_k}(s) \rightarrow \varphi(x(t)) - \varphi(x(s))$ . So we obtain  $\varphi(x(t)) = t$ . Thus we have that the path  $t \mapsto (\varphi(x(t)), x(t))$  is a null path contained in  $\partial\mathcal{D}_\tau$  between  $\mathbf{r}(x)$  and  $\mathbf{r}(y)$ . But this is a contradiction (in fact we know that no point in  $\Sigma$  lies in the interior of any null ray contained in  $\partial\mathcal{D}_\tau$ ).

Hence suppose that  $L_a \rightarrow +\infty$ . Then we have that there exists a sequence  $a_k \rightarrow 0$  and a Lipschitz path

$$x : [0, +\infty) \rightarrow \mathbb{R}^n$$

such that  $x_{a_k} \rightarrow x$  in the compact open topology of  $\mathbb{R}^{n+1}$ . Since  $\|x_{a_k}(t)\| \leq K$  we have that  $\|x(t)\| \leq K$ . On the other hand the same argument used above shows that  $\varphi(x(t)) = t$ . Since  $\varphi$  is 1-Lipschitz we get  $\|x(t)\| \geq t$  and this gives a contradiction. ■

From this proposition it follows that there exists a distance  $d$  on  $\Sigma$  such that

$$d(\mathbf{r}(x), \mathbf{r}(y)) = \lim_{a \rightarrow 0} \delta_a(x, y) \quad \text{for all } x, y \in \widetilde{M}.$$

We have to see that  $d$  coincides with the natural path-distance  $d_\Sigma$ . Fix  $r, s \in \Sigma$  and let  $C(r, s)$  be the set of Lipschitzian path (with respect the euclidean distance on  $\mathbb{M}^{n+1}$ ) in  $\partial\mathcal{D}_\tau$  between  $r$  and  $s$  then  $d_\Sigma(r, s)$  is defined by the rule

$$d_\Sigma(r, s) := \inf_{c \in C(r, s)} \int \sqrt{\langle \dot{c}(s), \dot{c}(s) \rangle} ds.$$



**Proposition 7.8** For all  $r, s \in \Sigma$  we have  $d_\Sigma(r, s) = d(r, s)$ .

*Proof* : It is easy to see that if  $c : [0, 1] \rightarrow \widetilde{S}_a$  is a rectifiable path then  $r \circ c$  is a rectifiable path with length lesser than the length of  $c$ . It follows that  $d_\Sigma(\mathbf{r}(x), \mathbf{r}(y)) \leq \delta_a(x, y)$ . Thus  $d_\Sigma(r, s) \leq d(r, s)$ .

Let us show the other inequality. Let  $r, s \in \Sigma$  and  $x, y \in \widetilde{M}$  such that  $\mathbf{r}(x) = r$  and  $\mathbf{r}(y) = s$ . Moreover let  $p_a = dev(a, x)$  and  $q_a = dev(a, y)$ . Fix a set of affine orthonormal coordinates  $(y_0, \dots, y_n)$  and let  $\varphi : \mathbb{R}^n \rightarrow \mathbb{R}$  (resp.  $\varphi_a : \mathbb{R}^n \rightarrow \mathbb{R}$ ) such that  $\partial\mathcal{D}_\tau = \text{graph}\varphi$  (resp.  $\widetilde{S}_a = \text{graph}\varphi_a$ ). Now we have  $r = (\varphi(u), u)$ ,  $s = (\varphi(v), v)$ ,  $p_a = (\varphi_a(u_a), u_a)$  and  $q_a = (\varphi_a(v_a), v_a)$ . Finally let  $q'_a = (\varphi_a(u), u)$  and  $p'_a = (\varphi_a(v), v)$ .

Now let  $E \subset \mathbb{R}^n$  the set of points where  $\varphi$  is not differentiable. There exists a sequence of 1-Lipshitz path  $x_k : [0, L_k] \rightarrow \mathbb{R}^n$  between  $u$  and  $v$  such that  $x_k^{-1}(E)$  has null Lebesgue measure on  $[0, L_k]$  and

$$\lim_{k \rightarrow +\infty} \int_0^{L_k} \sqrt{1 - (\nabla\varphi(x_k(t)) \cdot \dot{x}_k(t))^2} dt = d_\Sigma(r, s).$$

Consider the path  $c_a^k(t) = (\varphi_a(x_k(t)), x_k(t))$ . It is a path in  $\widetilde{S}_a$  between  $q'_a$  and  $p'_a$  so that

$$d_a(p_a, q_a) \leq d_a(p_a, p'_a) + \int_0^{L_k} \sqrt{1 - (\nabla\varphi_a(x_k(t)) \cdot \dot{x}_k(t))^2} dt + d_a(q_a, q'_a)$$

Notice  $(\varphi_a(x), x) + (1, \nabla\varphi_a(x))^\perp$  is a support plane for  $\widetilde{S}_a$  at  $(\varphi_a(x), x)$ . So that the sequence of plane  $(\varphi_a(x), x) + (1, \nabla\varphi_a(x))^\perp$  converges to a support plane for  $\partial\mathcal{D}_\tau$  in  $(\varphi(x), x)$ . Thus it is easy to see that  $\nabla\varphi_a(x) \rightarrow \nabla\varphi(x)$  for  $a \rightarrow 0$  and for all  $x \in \mathbb{R}^n - E$ . It follows that

$$\lim_{a \rightarrow 0} \int_0^{L_k} \sqrt{1 - (\nabla\varphi_a(x_k(t)) \cdot \dot{x}_k(t))^2} dt = \int_0^{L_k} \sqrt{1 - (\nabla\varphi(x_k(t)) \cdot \dot{x}_k(t))^2} dt.$$

Now we have that  $d_a(p_a, p'_a) \leq \|u - u_a\|$  (resp.  $d_a(q_a, q'_a) \leq \|v - v_a\|$ ) so that by passing to the limit for  $a \rightarrow 0$  we get

$$d(r, s) \leq \int_0^{L_k} \sqrt{1 - (\nabla\varphi(x_k(t)) \cdot \dot{x}_k(t))^2} dt \quad \text{for all } k.$$

Now by passing to the limit for  $k \rightarrow +\infty$  we get  $d(r, s) \leq d_\Sigma(r, s)$ . ■

In order to show the Gromov convergence of  $\widetilde{S}_a$  to  $\Sigma$  notice that we cannot use the argument of corollary 7.5. In fact there exists compact sets of  $(\Sigma, d_\Sigma)$  such that for all  $a > 0$  there exists no compact in  $\widetilde{S}_a$  which projects on them. For instance consider the case  $n = 2$  and let  $\tau \in Z^1(\Gamma, \mathbb{R}^{2+1})$  such that the lamination associated with  $\mathcal{D}_\tau$  is simplicial. In this case the singularity is a simplicial tree such that every vertex is the endpoints of a numerable set of edges. Fix a vertex  $r_0$  and consider a numeration  $(e_k)_{k \in \mathbb{N}}$  of the edges with a endpoint equal to  $r_0$ . Let

$$K = \bigcup_{k \in \mathbb{N}} \{r \in e_k \mid d_\Sigma(r, r_0) \leq C/k\}$$

where  $C$  is the minimum of the lengths of the edges of  $\Sigma$ . It is easy to see that  $K$  is compact. By contradiction suppose that for some  $a > 0$  there exists a compact  $K_a$  such that  $r(K_a) = K$ . Now let  $\mathcal{F}(r_0) = N(r^{-1}(r_0))$ : it is a complementary region of the lamination and  $\mathcal{F}(r)$  is a component of the boundary of  $\mathcal{F}(r_0)$  for all  $r \in K$ . Moreover  $\mathcal{F}(r)$  depends only on the edge which contains  $r$ . Let  $F_k$  be the leaf corresponding to  $e_k$ . Now fix  $p_0 \in K_a$  such that  $r(p_0) = r_0$

and for all  $k$  let  $p_k \in K_a$  such that  $r(p_k) \in e_k$ . We have that  $d_a(p_k, p_0) \geq ad_{\mathbb{H}}(F_k, N(p_0))$ . On the other hand  $d_{\mathbb{H}}(F_k, N(p_0)) \rightarrow +\infty$  for  $k \rightarrow +\infty$  and this contradicts the compactness of  $K_a$ .

In what follows we shall prove the convergence of the spectra of the  $\Gamma_\tau$ -action on  $\tilde{S}_a$  to the spectrum of the  $\Gamma_\tau$ -action on  $\Sigma$ . Generally let  $(X, d)$  be a metric space provided with an action of  $\Gamma$ . For every  $\gamma \in \Gamma$  we can define the *traslation lenght* of  $\gamma$  as  $\ell_X(\gamma) = \inf_{x \in X} d(x, \gamma x)$ . Clearly  $\ell_X(\gamma)$  depends only on the conjugation class of  $\Gamma$  and so it is defined a function  $\ell_X : \mathcal{C} \rightarrow [0, +\infty)$  where  $\mathcal{C}$  be the set of conjugation classes of  $\Gamma - \{1\}$ . This function is called *the marked lenght spectrum* of the action. For semplicity we denote by  $\ell_a$  ( $a > 0$ ) the marked lenght spectrum of the  $\Gamma_\tau$ -action on the CT level surface  $\tilde{S}_a$ , by  $\ell_0$  the marked lenght spectrum of the  $\Gamma_\tau$ -action on  $\Sigma$  and by  $\ell_{\mathbb{H}}$  the spectrum of the action on  $\mathbb{H}^n$ .

**Corollary 7.9** *With the above notation we have that for all  $\gamma \in \Gamma$ :*

$$\begin{aligned} \lim_{a \rightarrow +\infty} \ell_a(\gamma_\tau)/a &= \ell_{\mathbb{H}}(\gamma); \\ \lim_{a \rightarrow 0} \ell_a(\gamma_\tau) &= \ell_0(\gamma_\tau). \end{aligned}$$

*Proof :* The first limit is consequence of the Gromov convergence. For the second limit notice that  $\ell_a(\gamma_\tau) \geq \ell_0(\gamma_\tau)$ . On the other hand let  $x \in \tilde{M}$ : then we have

$$\ell_a(\gamma) \leq \delta_a(x, \gamma x)$$

so that we get  $\limsup_{a \rightarrow 0} \ell_a(\gamma) \leq d_\Sigma(\mathbf{r}(x), \gamma_\tau \mathbf{r}(x))$ . Thus  $\limsup_{a \rightarrow 0} \ell_a(\gamma_\tau) \leq \ell_0(\gamma_\tau)$ . ■

## 8 Measured Geodesic Stratification

In section 4 we have associated a geodesic stratification of  $\mathbb{H}^n$  with every future complete regular domain with surjective normal field. In this section we define the *transverse measure* on a stratification. We have seen that in dimension  $n = 2$  the geodesic stratifications are in fact geodesic laminations. We see that for  $n = 2$  transverse measures on geodesic stratifications are equivalent to transverse measures on the corresponding geodesic laminations (in the classical sense). Since the behaviour of a stratification is quite more complicated than the behaviour of a lamination, the general definition of transverse measure on a stratification is more involved.

We see that every measured geodesic stratification gives a future complete regular domain. In his work Mess exposed a technique to associate a future complete regular domain of  $\mathbb{M}^{2+1}$  to a measured geodesic lamination. This construction is a generalization of that technique to any dimension,  $n \geq 2$ .

Fix a *complete weakly continuous geodesic stratification*  $\mathcal{C}$ . For  $p \in \mathbb{H}^n$  let us indicate with  $C(p)$  the piece in  $\mathcal{C}$  which contains  $p$  and has minimum dimension.

The first notion that we need is the *transverse measure* on a piece-wise geodesic path. Let  $c : [0, 1] \rightarrow \mathbb{H}^n$  be a *piece-wise geodesic path*. A *transverse measure* on it is a  $\mathbb{R}^{n+1}$ -valued *measure*  $\mu_c$  on  $[0, 1]$  such that

1. there exists a finite positive measure  $|\mu_c|$  such that  $\mu_c$  is  $|\mu_c|$ -absolutely continuous and  $\text{supp}|\mu_c|$  it the topological closure of the set  $\{t \in (0, 1) \mid \dot{c}(t) \notin T_{c(t)}C(c(t))\}$ ;

2. let  $v_c = \frac{d\mu_c}{d|\mu_c|}$  be the  $|\mu_c|$ -density of  $\mu_c$ , then

$$\begin{aligned} v_c(t) &\in T_{c(t)}\mathbb{H}^n \cap T_{c(t)}C(c(t))^\perp, \\ \langle v_c(t), v_c(t) \rangle &= 1, \\ \langle v_c(t), \dot{c}(t) \rangle &> 0 \end{aligned} \quad |\mu_c| - \text{ a.e.} \quad (10)$$

3. the endpoints of  $c$  are not atoms of the measure  $|\mu_c|$ .

Let us point out an useful property of a transverse measure on a geodesic path.

**Lemma 8.1** *Let  $c : [0, 1] \rightarrow \mathbb{H}^n$  be a geodesic path and  $\mu_c$  be a transverse measure on it. Then for  $|\mu_c|$ -almost all  $t$  we have*

$$\langle c(0), v_c(t) \rangle < 0 \quad \langle c(1), v_c(t) \rangle > 0.$$

Thus  $v_c(t)^\perp$  separates  $c(0)$  from  $c(1)$ .

*Proof :* Since  $c$  is a geodesic path there exists  $v \in T_{c(0)}\mathbb{H}^n$  such that

$$c(t) = \cosh(s(t))c(0) + \sinh(s(t))v$$

with  $s(t)$  an increasing function. By (10) we have  $|\mu_c|$ -almost everywhere

$$\begin{aligned} 0 &= \langle c(t), v_c(t) \rangle = \cosh(s(t)) \langle c(0), v_c(t) \rangle + \sinh(s(t)) \langle v, v_c(t) \rangle; \\ 0 &< \langle \dot{c}(t), v_c(t) \rangle = \dot{s}(t) ( \sinh(s(t)) \langle c(0), v_c(t) \rangle + \cosh(s(t)) \langle v, v_c(t) \rangle ). \end{aligned}$$

Looking at this expressions we easily get that  $\langle c(0), v_c(t) \rangle < 0$ . An analogous calculation shows the other inequality. ■

A first consequence of this lemma is that the measure  $\mu_c$  determines the positive measure  $|\mu_c|$ .

**Corollary 8.2** *Let  $c$  be a piece-wise geodesic path and  $\mu_c$  be a transverse measure on it. Suppose that  $\lambda$  is a positive measure such that  $\mu_c$  is  $\lambda$ -absolutely continuous and the density  $u = \frac{d\mu_c}{d\lambda}$  verifies (10). Then  $\lambda = |\mu_c|$ .*

*Proof :* First let us show that  $\lambda$  is  $|\mu_c|$ -absolutely continuous. Let  $E \subset [0, 1]$  such that  $|\mu_c|(E) = 0$ . We can suppose that  $E$  is contained in an interval  $I = [t_0, t_1]$  such that  $c|_I$  is a geodesic path. Since  $\mu_c(E) = 0$  we deduce that

$$0 = \left\langle c(t_0), \int_E u(t) d\lambda \right\rangle = \int_E \langle c(t_0), u(t) \rangle d\lambda.$$

The same argument of lemma 8.1 shows that  $\langle c(t_0), u(t) \rangle < 0$  for  $\lambda$ -almost all points in  $I$ . Thus  $\lambda(E) = 0$ .

Now let  $a = \frac{d\lambda}{d|\mu_c|}$ . We recall that

$$v_c(t) = \frac{d\mu_c}{d|\mu_c|} = \frac{d\mu_c}{d\lambda} \frac{d\lambda}{d|\mu_c|} = a(t)u(t) \quad |\mu_c| - \text{ a.e.}$$

Since  $\langle v_c(t), v_c(t) \rangle = \langle u(t), u(t) \rangle = 1$  we deduce that  $a(t) = 1$ . ■

In order to define a transverse measure on a geodesic stratification we need the following definition.

**Def. 8.1** Let  $\varphi_s : [0, 1] \rightarrow \mathbb{H}^n$  be a homotopy between  $\varphi_0$  and  $\varphi_1$ . We say that  $\varphi$  is  $\mathcal{C}$ -preserving if  $C(\varphi_s(t)) = C(\varphi_0(t))$  for all  $(t, s) \in [0, 1] \times [0, 1]$  (recall that  $C(x)$  is the piece of  $\mathcal{C}$  which contains  $x$  and has minimum dimension).

Now we can give the definition of trasverse measure on a geodesic stratification.

**Def. 8.2** Let  $\mathcal{C}$  be a complete weakly continuous stratification and fix a subset  $Y \subset \mathbb{H}^n$  which is union of pieces of  $\mathcal{C}$  such that the Lebesgue measure of  $Y$  is 0. We mean by  $(\mathcal{C}, Y)$ -admissible path (or simply admissible path) any piece-wise geodesic path  $c : [0, 1] \rightarrow \mathbb{H}^n$  such that every maximal geodesic subsegment has no endpoint in  $Y$ .

A **transverse measure** on  $(\mathcal{C}, Y)$  is the assignment of a transverse measure  $\mu_c$  to every admissible path  $c : [0, 1] \rightarrow \mathbb{H}^n$  such that

1. if there exists a  $\mathcal{C}$ -preserving homotopy between two paths  $c$  and  $d$  then  $\mu_c = \mu_d$ ;
2. for every admissible path  $c$  and every parametrization  $s : [0, 1] \rightarrow [0, 1]$  of an admissible subarc of  $c$  we have that  $\mu_{c \circ s} = s^*(\mu_c)$ ;
3. the atoms of  $|\mu_c|$  are contained in  $c^{-1}(Y)$ , and for every  $y \in Y$  there exists an admissible path  $c$  such that  $|\mu_c|$  has some atoms on  $c^{-1}(y)$ ;
4.  $\mu_c(c) = 0$  for every closed admissible path  $c$ ;
5. for all sequences  $(x_k)_{k \in \mathbb{N}}$  such that  $x_k \in \mathbb{H}^n - Y$  and  $x = \lim_{k \rightarrow +\infty} x_k \in \mathbb{H}^n - Y$  we have that  $\mu_{c_k}(c_k) \rightarrow 0$  where  $c_k$  is the admissible arc  $[x_k, x]$ .

A **measured geodesic stratification** is given by a weakly continuous geodesic stratification, a subset  $Y$  as above and a measure on  $\mu$  on  $(\mathcal{C}, Y)$ .

A measured geodesic stratification  $(\mathcal{C}, Y, \mu)$  is  $\Gamma$ -invariant if  $\mathcal{C}$  is  $\Gamma$ -invariant,  $Y$  is  $\Gamma$ -invariant and for all  $c : [0, 1] \rightarrow \mathbb{H}^n$  admissible path,  $E \subset [0, 1]$  borelian set, and  $\gamma \in \Gamma$  we have

$$\mu_{\gamma \circ c}(E) = \gamma(\mu_c(E)).$$

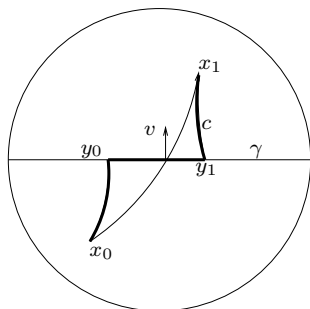

Figure 3: The figure shows a non-admissible arc.

**Remark 8.3** The restriction to admissible subarcs is necessary for the foundation of definition. For instance consider the stratification of  $\mathbb{H}^2$  with one geodesic  $\gamma$ . Fix a geodesic arc  $c$ : if  $c$  intersects transversally  $\gamma$  in a point  $t_0$  put  $\mu_c = v\delta_{t_0}$  where  $v$  is the normal to  $\gamma$  such that  $\langle v, \dot{c}(t_0) \rangle > 0$ . If  $c$  is contained in  $\gamma$  or does not intersect it put  $\mu_c = 0$ . It is not possible to extend this definition to all piece-wise geodesic paths: in fact consider the segment  $c$  as in fig.3.

Applying property 4. of definition of measure to the closed admissible arc  $c * [x_1, x_0]$  we get  $\mu_c(c) = v$ . On the other hand we have that  $\mu_c([x_0, y_0]) = 0$ ,  $\mu_c([y_0, y_1]) = 0$  and  $\mu_c([y_1, x_1]) = 0$  and this is a contradiction.

Consider a measured geodesic stratification  $(\mathcal{C}, Y, \mu)$ , notice that condition 3. in definition 8.2 impose a minimality property of  $Y$ .

**Remark 8.4** Consider the case  $n = 2$ . Let  $\Gamma$  be a co-compact Fuchsian group. Let  $\mathcal{C}$  be a  $\Gamma$ -invariant geodesic stratification. The 1-stratum  $L$  of  $\mathcal{C}$  is a  $\Gamma$ -invariant geodesic lamination of  $\mathbb{H}^2$ . We know that  $L = S \cup L_1$  where  $S$  is a simplicial lamination and  $L_1$  is a lamination with no closed leaf (see [6] for further details about geodesic laminations).

We want to see that maximal measured geodesic stratification  $(\mathcal{C}, Y, \mu)$  are naturally identified with the transverse measures (in the classical sense) on the lamination  $L = X_{(1)}$  (notice that these concepts are quite different, in fact one is a  $\mathbb{R}^{n+1}$  valued measure and the other is a positive measure).

Fix a transverse measure  $\mu$  of  $(\mathcal{C}, Y)$ : we want to see that there exists a unique transverse measure  $\lambda$  on  $L$  such that  $\lambda_c = |\mu_c|$  for all admissible paths  $c$ . First notice that  $Y$  is union of geodesics of  $L$  (in fact the interior of  $L$  is empty). It follows that every transverse path  $d$  is composition of paths  $d_i$  such that there exists a  $\mathcal{C}$ -preserving homotopy between  $d_i$  and a suitable parametrization  $c_i$  of the admissible geodesic segment  $[d_i(0), d_i(1)]$ . Thus one define  $\lambda_d$  such that the restriction on  $d_i$  is  $|\mu_{c_i}|$ . By using property 1. and 2. of definition 8.2 it is easy to see that this definition does not depend on the choice of the decomposition and in fact it is the only possible one. Finally since  $\mu_c$  is  $\Gamma$ -invariant we have that  $\lambda$  is  $\Gamma$ -invariant too.

By general facts about measured geodesic laminations (see [6]) it follows that for every admissible path  $c$  the atoms of  $\mu_c$  are exactly  $c^{-1}(S)$ . It follows that  $S = Y$ .

Conversely let  $\lambda$  be a  $\Gamma$ -invariant transverse measure on  $L$ . Put  $Y = S$ . We want to construct a  $(\mathcal{C}, Y)$ -measure on  $\mathbb{H}^n$ . Fix an admissible path  $c$  and let  $v_c : [0, 1] \rightarrow \mathbb{R}^{n+1}$  the function so defined:  $v_c(t) = 0$  if  $c(t) \notin L$ , otherwise  $v_c(t)$  is the normal vector to the leaf  $C(c(t))$  such that  $\langle v_c(t), \dot{c}(t) \rangle > 0$ . Then we can define  $\mu_c$  the  $\mathbb{R}^{n+1}$ -measure on  $[0, 1]$  which is  $\lambda_c$  absolutely continuous and has  $\lambda_c$  density equal to  $v_c$ . It is easy to see that in this way  $\mu_c$  is a transverse measure on  $c$ . Furthermore by definition of the assignment  $c \mapsto \mu_c$  verifies condition 1. and 2. of definition 8.2. An easy analysis of the geometry of a lamination show that the condition 4. and 5. are satisfied.

It is easy to see that this correspondence gives an identification between  $\Gamma$ -invariant transverse measure on  $\mathcal{C}$  and  $\Gamma$ -invariant transverse measure on  $L$ .

Notice that in dimension  $n = 2$  the condition 4. of definition 8.2 is assured by the geometry of the stratification. Furthermore in this case the set  $Y$  is determined by the lamination (i.e. it does not depend on the measure).

Before constructing a future complete regular domain with a given geodesic stratification, let us point out an easy property of measured geodesic stratifications.

**Lemma 8.5** *Let  $\mu$  be a transverse measure on  $(\mathcal{C}, Y)$ . Then for all  $x \in \mathbb{H}^n - Y$  we have that there exists a unique maximal piece of  $\mathcal{C}$  which contains  $x$  (maximal with respect the inclusion).*

*Proof :* Suppose that there exist two pieces  $C_1, C_2$  which contain  $x$ . We want to show that there exists a piece  $C$  which contains  $C_1 \cup C_2$ .

Let  $x_i$  be a point on  $C_i$  such that  $C(x_i) = C_i$ . Notice that  $x_i$  does not lie into  $Y$  (in fact  $Y$  is union of pieces so that if  $y \in Y$  then  $C(y) \subset Y$ ). Consider the piece-wise geodesic arc  $c = [x_1, x] \cup [x, x_2] \cup [x_2, x_1]$ . It is closed and admissible so that

$$\mu_c([x_2, x_1]) = -\mu_c([x_1, x]) - \mu_c([x, x_2])$$

(notice that we are using that  $x, x_1$  and  $x_2$  are not atoms). Since  $(x_1, x)$  and  $(x, x_2)$  are contained in  $C$  one easily see that  $\mu_c([x_1, x_2]) = 0$ . On the other hand by lemma 8.1 we have that  $\langle v_c(t), x_2 - x_1 \rangle > 0$  for  $|\mu_c|$ -almost all  $t$ . Since  $\langle \mu_c([x_1, x_2]), x_2 - x_1 \rangle = \int_{[x_1, x_2]} \langle v_c(t), x_2 - x_1 \rangle$  we have that  $|\mu_c|([x_1, x_2]) = 0$ . Thus the segment  $[x_1, x_2]$  is contained in a piece  $C$ . It follows that  $C \supset C(x_i) = C_i$ . ■

Now given a measured geodesic stratification  $(\mathcal{C}, Y, \mu)$  we construct a regular domain with stratification equal to  $\mathcal{C}$ . Fix a base point  $x_0 \in \mathbb{H}^n - Y$  and define for  $x \notin Y$

$$\rho(x) = \mu_{c_x}(c_x)$$

where  $c_x$  is a admissible path between  $x_0$  and  $x$ . It is quite evident that this definition does not depend on the choice of the path. Furthermore notice that

$$\rho(y) = \rho(x) + \mu_{c_{x,y}}(c_{x,y})$$

where  $c_{x,y}$  is the geodesic arc between  $x$  and  $y$ . By using property 5. it follows that the map  $\rho : \mathbb{H}^n - Y \rightarrow \mathbb{M}^{n+1}$  is continuous.

Let us denote  $M(x)$  the maximal piece of  $\mathcal{C}$  which contains  $x$  for  $x \notin Y$ . By lemma 8.5 this piece is unique. By using lemma 8.1 it is easy to see that

$$\langle \rho(y) - \rho(x), y \rangle \geq 0 \quad \langle \rho(y) - \rho(x), x \rangle \leq 0. \quad (11)$$

Furthermore arguing as in lemma 8.5 one easily see that the equality holds if and only if  $M(x) = M(y)$ . Thus  $\rho(x) = \rho(y)$  if and only if  $M(x) = M(y)$ .

Let us define a convex set

$$\Omega = \bigcap_{x \in \mathbb{H}^n - Y} \mathbb{I}^+(\rho(x) + x^\perp).$$

**Theorem 8.6** *We have that  $\Omega$  is a future complete regular domain. Furthermore  $\rho(x) \in \Sigma$  for all  $x \in \mathbb{H}^n - Y$  and  $\Omega$  is the convex hull of the points  $\{\rho(x) | x \in \mathbb{H}^n - Y\}$ .*

*Proof :* First let us show that  $\rho(x) \in \partial\Omega$ . Clearly  $\rho(x) \notin \Omega$ . Now let  $v \in \mathbb{I}^+(0)$ : we have to show that  $\rho(x) + v \in \Omega$  i.e.  $\langle \rho(x) + v - \rho(y), y \rangle < 0$  for all  $y \in \mathbb{H}^n$ . By inequalities (11)  $\langle \rho(x) - \rho(y), y \rangle \leq 0$  and since  $v$  is future directed  $\langle v, y \rangle < 0$  so that  $\mathbb{I}^+(\rho(x)) \subset \Omega$ .

Now notice that  $\rho(x) = \rho(y)$  for every  $y \in M(x)$  so that the plane  $\rho(x) + y^\perp$  is a support plane for  $\Omega$  for all  $y \in M(x)$ . Let  $v$  be a null direction such that  $[v]$  is in the boundary of  $M(x)$ . By taking a sequence  $(y_k) \in M(x)$  such that  $y_k \rightarrow [v]$  it is easy to see that the plane  $\rho(x) + v^\perp$  is a support plane for  $\Omega$ . So that we have shown

$$\Omega \subset \bigcap_{\substack{x \in \mathbb{H}^n - Y \text{ and} \\ [v] \in M(x) \cap \partial\mathbb{H}^n}} \mathbb{I}^+(\rho(x) + v^\perp).$$

If we prove the other inclusion we obtain that  $\Omega$  is a future complete regular domain. Fix  $p \in \mathbb{M}^{n+1}$  and suppose that  $\langle p - \rho(x), v \rangle < 0$  for all  $x \in \mathbb{H}^n$  and  $[v] \in M(x) \cap \partial\mathbb{H}^n$ . We have to show that  $p \in \Omega$ . Notice that every  $x \in \mathbb{H}^n - Y$  is a convex combination of a collection  $v_1, \dots, v_n$  such that  $[v_i] \in M(x) \cap \partial\mathbb{H}^n$ . It follows that  $\langle p - \rho(x), x \rangle < 0$  and so that  $p \in \Omega$ . Since  $\rho(x) + x^\perp$  is a spacelike support plane, we argue that  $\rho(x) \in \Sigma$  and  $\mathcal{F}(\rho(x)) \supset M(x)$ .

Now let us prove that  $\Omega$  is the convex hull of the points  $\rho(x)$ . Notice that it is sufficient to show that the future  $I^+(\tilde{S}_a)$  of the CT level surface  $\tilde{S}_a$  is the convex hull of the set  $\mathcal{S}_a = \{ax + \rho(x) | x \in \mathbb{H}^n - Y\}$ . Since  $\rho(x) + x^\perp$  is a support plane of  $\Omega$  we have that  $ax + \rho(x) \in \tilde{S}_a$  so that the future of  $\tilde{S}_a$  contains the convex hull of  $\mathcal{S}_a$ . On the other hand it is easy to see that the spacelike support planes of the convex hull of  $\mathcal{S}_a$  are support planes of  $I^+(\tilde{S}_a)$ . Thus in order to prove the statement it is sufficient to show that the convex hull of  $\mathcal{S}_a$  has not timelike support plane. By contradiction suppose that there exists a vector  $v$  such that  $\langle v, v \rangle = 1$  and  $\langle ax + \rho(x), v \rangle < C$ . Up to translating  $\Omega$  we can suppose that the base point  $x_0$  is orthogonal to  $v$ . Consider the geodesic  $\gamma$  such that  $\gamma(0) = x_0$  and  $\dot{\gamma}(0) = v$ . We can suppose that there exists a sequence  $t_k \rightarrow +\infty$  such that  $\gamma(t_k) \notin Y$ . Now let  $x_k = \gamma(t_k)$ , by using that  $\langle \rho(x_k), x_k \rangle \geq 0$  and  $\langle \rho(x_k), x_0 \rangle \leq 0$  we deduce that  $\langle \rho(x_k), v \rangle \geq 0$ . Since  $\langle x_k, v \rangle \rightarrow +\infty$  we have that  $\langle ax_k + \rho(x_k), v \rangle \rightarrow +\infty$  and this gives a contradiction.  $\blacksquare$

Now we want to show that the stratification associated with  $\Omega$  coincides with  $\mathcal{C}$  at least on  $\mathbb{H}^n - Y$ . First we give a technical result.

**Lemma 8.7** *Let  $\Omega$  be the regular domain constructed in theorem 8.6 and suppose that the map  $N : \tilde{S}_1 \rightarrow \mathbb{H}^n$  is proper. Then for all  $x \in \mathbb{H}^n$  we have that  $N^{-1}(x) \cap \tilde{S}_1$  is the convex hull of the limit points of the sequences  $(x_k + \rho(x_k))_{k \in \mathbb{N}}$  such that  $x_k \in \mathbb{H}^n - Y$  and  $Nx_k \rightarrow x$ .*

*Proof :* Let  $p \in \tilde{S}_1$  and suppose that  $N(p) = x$ . We have to show that for all  $v \in N(p)^\perp$  there exists a sequence  $x_k \in \mathbb{H}^n - Y$ , such that  $x_k + \rho(x_k) \rightarrow p_\infty$  with  $N(p_\infty) = x$  and  $\langle p_\infty - p, v \rangle \geq 0$ . We know that there exists a sequence  $x_k \in \mathbb{H}^n - Y$  such that  $x_k = \cosh d_k x + \sinh d_k v_k$  such that  $d_k \rightarrow 0$  and  $v_k \rightarrow v$ . Let  $p_k = x_k + \rho(x_k)$ . Since  $N$  is a proper map, up to passing to a subsequence we get that  $p_k \rightarrow p_\infty$  such that  $N(p_\infty) = x$ . Since  $\langle p_k - p, x \rangle \leq 0$  and  $\langle p_k - p, x_k \rangle \geq 0$  we have that  $\langle p_k - p, v_k \rangle \geq 0$  and passing to the limit we get  $\langle p_\infty - p, v \rangle \geq 0$ .  $\blacksquare$

**Proposition 8.8** *Let  $\Omega$  be the regular domain associated with the measured stratification  $(\mathcal{C}, Y, \mu)$ , and suppose that the restriction of the normal field  $N|_{\tilde{S}_1}$  is a proper map. Then for all  $x \in \mathbb{H}^n - Y$  we have that  $rN^{-1}(x) = \{\rho(x)\}$ . Moreover  $\mathcal{F}(\rho(x))$  is the maximal piece  $M(x)$ . (We recall that  $\mathcal{F}(r_0) = N(r^{-1}(r_0))$  where  $r_0 \in \Sigma$  and  $r$  is the retraction onto the singularity  $\Sigma$ ).*

*Proof :* Let  $x \in \mathbb{H}^n - Y$ . Since  $\rho : \mathbb{H}^n - Y \rightarrow \mathbb{M}^{n+1}$  is a continuous map lemma 8.7 implies that  $N^{-1}(x) \cap \tilde{S}_1 = \{x + \rho(x)\}$ . Thus  $rN^{-1}(x) = \{\rho(x)\}$ . Now let us prove that  $\mathcal{F}(\rho(x)) = M(x)$ . Clearly  $M(y) \subset \mathcal{F}(\rho(x))$ , thus we have to prove the other inclusion. Let  $y \in \mathcal{F}(\rho(x))$ , first suppose that  $y \notin Y$ . We have  $\langle y, \rho(y) - \rho(x) \rangle \leq 0$ . On the other hand by the (11) we know that the other inequality holds so that  $\langle y, \rho(y) - \rho(x) \rangle = 0$ , but then  $\rho(x) = \rho(y)$  and so  $M(x) = M(y)$ .

Suppose now that  $y \in Y \cap \mathcal{F}(\rho(x))$ . Let us prove that  $y$  lies in the boundary  $b\mathcal{F}(\rho(x))$  (see section 4 for the definition of the boundary  $bK$  of a convex  $K$ ). Since  $y \in Y$  we have that  $N^{-1}(y) \cap \tilde{S}_1$  is not a point. So that there exists a spacelike vector  $v$  orthogonal to  $y$  such that the segment  $[\rho(x), \rho(x) + \varepsilon v] \subset \Sigma$ . We have that  $v^\perp$  is a support plane of  $\mathcal{F}(\rho(x))$  and contains  $y$ . So that if  $y \notin b\mathcal{F}(\rho(x))$  we get  $x \in \mathcal{F}(\rho(x) + \varepsilon v)$  i.e.  $\rho(x) + \varepsilon v \in rN^{-1}(x)$ . Since  $x \notin Y$  we get a contradiction. Thus  $\mathcal{F}(\rho(x)) - b\mathcal{F}(\rho(x)) \subset \mathbb{H}^n - Y$  so that  $\mathcal{F}(\rho(x)) - b\mathcal{F}(\rho(x)) \subset M(x)$ . It follows that  $\mathcal{F}(\rho(x)) \subset M(x)$ .  $\blacksquare$

**Remark 8.9** Notice that the stratification induced by the domain  $\Omega$  coincides with  $\mathcal{C}$  on  $\mathbb{H}^n - Y$ , so that  $Y$  is the union of pieces of the stratification associated with  $\Omega$ . Moreover by property 3. in definition 8.2 it turns out that  $Y = \{y \in \mathbb{H}^n | \#N^{-1}(y) > 1\}$ .

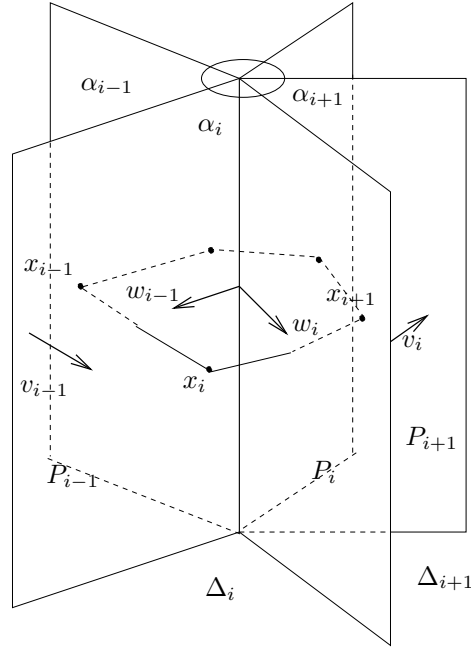

Figure 4: A neighborhood of a point on a 1- piece of a simplicial stratification of  $\mathbb{H}^3$

**Corollary 8.10** *Let  $(\mathcal{C}, Y, \mu)$  be a  $\Gamma$ -invariant measured geodesic stratification of  $\mathbb{H}^n$  (where  $\Gamma$  is a co-compact free-torsion discrete subgroup of  $SO^+(n, 1)$ ). Fix a base point  $x_0 \notin Y$  and let  $\tau_\gamma = \rho(\gamma(x_0))$  then we have that  $\tau \in Z^1(\Gamma, \mathbb{R}^{n+1})$ . Let  $\Omega$  be a domain associated with  $(\mathcal{C}, Y, \mu)$ . Then  $\Omega = \mathcal{D}_\tau$  and  $\mathcal{F}(\rho(x)) = M(x)$  for all  $x \notin Y$ .*

*Proof* : Since  $\mu$  is  $\Gamma$ -invariant we have

$$\rho(\gamma(x)) = \gamma\rho(x) + \rho(\gamma(x_0))$$

Thus  $\tau_{\alpha\beta} = \alpha\tau_\beta + \tau_\alpha$ , so that  $\tau$  is a cocycle. The same equality shows that  $\Omega$  is a  $\Gamma_\tau$ -invariant regular domain. Thus theorem 5.1 implies that it is equal to  $\mathcal{D}_\tau$ . Since in this case we know that  $N : \tilde{S}_1 \rightarrow \mathbb{H}^n$  is a proper map proposition 8.8 implies that  $\mathcal{F}(\rho(x)) = M(x)$  for all  $x \notin Y$ . ■

## 9 Simplicial Stratifications

In this section we restrict to the case  $n + 1 = 4$ . In particular we study the future complete regular domain of  $\mathbb{M}^{3+1}$  with simplicial geodesic stratification.

**Def. 9.1** *We say that a geodesic stratification  $\mathcal{C}$  is simplicial if for every  $p \in \mathbb{H}^n$  there exists a neighborhood  $U$  which intersects only a finite number of pieces of  $\mathcal{C}$ .*

We shall see that the correspondence between measured geodesic stratifications and regular domains induce an identification between measured simplicial stratifications and regular domain **with simplicial singularity**. Finally we shall recover the duality between stratification and singularity.

Notice that in dimension  $n = 2$  simplicial stratifications correspond to simplicial laminations. Moreover in all the dimensions a simplicial stratification has closed strata: it is in fact a



tassellation of  $\mathbb{H}^n$  by locally finite ideal convex polyhedra. In fig.4 we show the local behaviour of a simplicial stratification of  $\mathbb{H}^3$ .

First we describe the measures on a simplicial stratification. Let  $(\mathcal{C}, Y, \mu)$  be a measured geodesic lamination with simplicial support  $\mathcal{C}$ . Let  $X$  be the 2-stratum of  $\mathcal{C}$ . We want to show that  $X = Y$ . Since  $Y$  has not interior we have  $Y \subset X$ . On the other hand let  $c$  be a geodesic path with no endpoint in  $X$  (a such path is admissible). Notice that  $\text{supp}|\mu_c|$  is  $c^{-1}(X)$ , but this set is finite so that the measure  $|\mu_c|$  has an atom on every point of  $c^{-1}(X)$ . Thus  $X \subset Y$ .

Fix a 2-piece  $P$  and let  $\Delta_1$  and  $\Delta_2$  be the 3-pieces which incide on  $P$ . Let  $c$  an admissible geodesic path which start in  $\Delta_1$  and termines in  $\Delta_2$ . Clearly  $\mu_c = av_{1,2}\delta_{c^{-1}(P)}$  where  $a$  is positive constant  $v_{1,2}$  is the normal vector to  $P$  which points toward  $\Delta_2$  and  $\delta_x$  is the Dirac measure centered in  $x$ . By using property 1. and 2. of definition 8.2 one easily see that the constant  $a$  does not depends on the path. By imposing that  $\mu_c(c) + \mu_{c^{-1}}(c^{-1}) = 0$  one deduce that the measure of a geodesic path  $c'$  which starts in  $\Delta_2$  and termines in  $\Delta_1$  is  $\mu_{c'} = av_{2,1}\delta_{c^{-1}(P)}$ . It follows that the constant  $a$  depends only on the piece  $P$ : we call it the *weight* of  $P$  and we denote it by  $a_\mu(P)$ .

We want to show that the set of the weight  $\{a_\mu(P)|P \text{ is a 2 piece}\}$  satisfies a certain set of equations and determines the measure  $\mu$ .

Fix a geodesic  $l$  in  $\mathcal{C}$  and let  $P_1, \dots, P_k$  and  $\Delta_1, \dots, \Delta_k$  be respectively the 2-pieces and the 3-pieces which incide on  $l$ . We can suppose that the numeration is such that  $\Delta_i$  incides on  $P_{i-1}$  and  $P_i$  (the index  $i-1$  and  $i$  are considered mod  $k$ , see fig.4). Fix  $x_i$  in  $\text{int}(\Delta_i)$  and consider the admissible closed path  $c = [x_1, x_2] \cup [x_2, x_3] \cup \dots \cup [x_{k-1}, x_k] \cup [x_k, x_1]$ . By imposing that  $\mu_c(c) = 0$  we deduce

$$\sum_{i=1}^k a_\mu(P_i)v_i = 0 \quad (12)$$

where  $v_i$  is the normal vector to  $P_i$  which points outward  $\Delta_i$ . Notice that  $v_i$  lies in the linear subspace of  $\mathbb{M}^{3+1}$  which is orthogonal to the space generated by  $l$  (which we denote  $l^\perp$ ). Fix a point  $x \in l$ , notice that  $l^\perp$  is identified with the subspace of  $T_x\mathbb{H}^3$  which is orthogonal to  $l$ . By performing a  $\frac{\pi}{2}$ -rotation on  $l^\perp$  one see that equation (12) is equivalent to the equation

$$p_l(a_\mu) = \sum_{l \subset P} a_\mu(P)w(P) = 0 \quad (13)$$

where  $w$  is the unitary vector of  $l^\perp$  which is tangent to  $P$  and points inward (see fig.4).

**Def. 9.2** *A family of positive constants  $a = \{a(P)\}$  parametrized by the set of the 2-pieces of  $\mathcal{C}$  is called a family of weights for the stratification if the equation  $p_l(a) = 0$  is satisfied for every 1-piece  $l$ .*

We have shown that there is a family of weights associated with every transverse measure  $\mu$  on  $\mathcal{C}$ . Now we want to prove that this correspondence is bijective.

**Proposition 9.1** *For every family of weights  $\{a(P)\}$  there exists a unique transverse measure  $\mu$  such that  $a(P) = a_\mu(P)$ .*

*Proof* : First let us prove the uniqueness. Let  $\mu$  and  $\nu$  measure such that  $a_\mu(P) = a_\nu(P)$  for all 2-pieces  $P$ . If  $c$  is an admissible arc which intersects only 2-pieces it follows that  $\mu(c) = \nu(c)$ . Suppose now that  $c \cap X$  is a point  $p$  which lies on the 1-piece  $l$ . Consider an arc  $c'$  which has the same endpoints of  $c$  and does not intersect the 1-stratum. We have  $\mu_c(c) = \mu_{c'}(c') = \nu_{c'}(c') =$

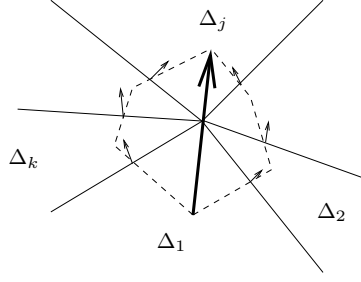

Figure 5: Definition of the measure on a geodesic which pass through the 1-stratum.

$\nu_c(c)$ . Since  $\text{supp}\mu_c = \text{supp}\nu_c = c^{-1}(p)$  we have  $\mu_c = \nu_c$ . Notice that every admissible path is a composition of paths  $c_1 * \dots * c_n$  such that every  $c_i$  either does not intersect the 1-stratum or intersects only one geodesic. It follows that  $\mu_c = \nu_c$ .

Now let us prove the existence. Let  $c$  be an admissible geodesic path: notice that  $c^{-1}(P)$  is at most a point for every 2-piece  $P$ . Suppose that  $c$  does not intersect any geodesics of the stratification. Then we can define  $\mu_c = \sum_P a(P)v(P)\delta_{c^{-1}(P)}$  where  $v(P)$  is the normal vector to  $P$  such that  $\langle v(P), \dot{c}(c^{-1}P) \rangle > 0$  (notice that this sum is finite). Suppose now that  $c$  intersects only a geodesic  $l$ . Let  $P_1, \dots, P_k$  and  $\Delta_1, \dots, \Delta_k$  be respectively the 2-pieces and the 3-pieces which incide on  $l$ . We choose the numeration as above and suppose that  $c$  come from  $\Delta_1$  and goes into  $\Delta_j$ . Thus we can define

$$\mu_c = \left( \sum_{i=1}^{j-1} a(P_i)u(P_i) \right) \delta_{c^{-1}(l)}$$

where  $u(P_i)$  is the normal vector to  $P_i$  which points towards  $\Delta_j$ . Since  $\sum_{i=1}^{j-1} a(P_i)u(P_i) = \sum_{i=j}^k a(P_i)u(P_i)$  we have that this definition does not depend on the numeration (see fig. 5). Now let  $c$  an admissible path. Consider a decomposition of  $c$  in geodesic admissible paths  $c_1 * \dots * c_k$  such that every  $c_i$  intersects only a geodesic of the stratification or a 2-piece. Thus we can define  $\mu_c$  such that  $\mu_c|_{c_i} = \mu_{c_i}$ . Notice that this definition does not depends on the decomposition of  $c$ .

Clearly this measure satisfies the property 1. 2. and 3. of definition 8.2. Let us show that if  $c$  is a closed admissible path then  $\mu_c(c) = 0$ . First notice that we can assume that  $c$  does not intersect any geodesic of  $\mathcal{C}$ . In fact if  $c$  intersect  $l$  we can perform the moss in figure 6. Notice that we obtain a closed admissible arc  $c'$  such that  $\mu_{c'}(c') = \mu_c(c)$  and  $\text{card}(c' \cap X_{(1)}) < \text{card}(c \cap X_{(1)})$  (here  $X_{(1)}$  is the 1-statum). Since these intersections are finite we can reduce to the case  $c \cap X_{(1)} = \emptyset$ .

Now  $c - X$  is union of component  $m_1, \dots, m_N$ , where  $m_i$  is an oriented arc with endpoints on the faces  $P_i^-$  and  $P_i^+$ . Notice that we can suppose that the faces  $P_i^-$  and  $P_i^+$  are different. In fact otherwise we can perform the moss in figure 7. We call a such path *tight*.

Now let  $n(P, c)$  the cardinality of the intersection of  $c$  with the face  $P$ . It is clear that if  $n(P, c) = n(P, c')$  for every  $P$  then  $\mu_c(c) = \mu_{c'}(c')$ . On the other hand let  $c$  and  $c'$  be tight paths such that there exists a homotopy between them in  $\mathbb{H}^n - X_{(1)}$ : it is easy to see that  $n(P, c) = n(P, c')$  for every  $P$  (in fact for every tight path  $c$  there exists  $\varepsilon > 0$  such that if  $c'$  is in a  $\varepsilon$ -neighborhood of  $c$  then  $n(P, c) = n(P, c')$ ).

Thus we have that  $\mu_c(c)$  depends only on the homotopy class of  $c$  in  $\mathbb{H}^n - X_{(1)}$ . Now fix a base point  $x_0 \in \mathbb{H}^n - X$ . Since every  $\alpha \in \pi_1(\mathbb{H}^n - X^1, x_0)$  is represented by an admissible

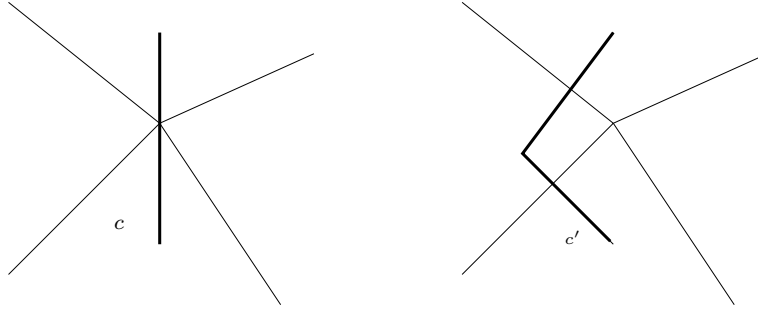

Figure 6: Performing the moss in the figure we obtain an arc which does not intersect  $X_{(1)}$ .

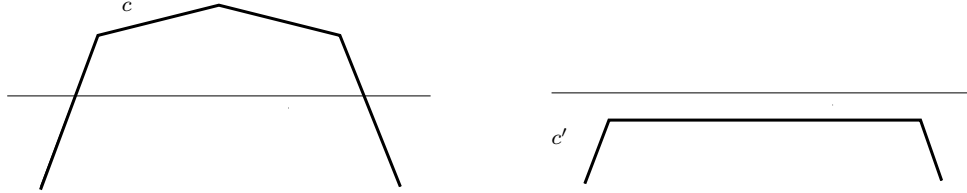

Figure 7: Performing the moss in the figure we obtain an arc tight.

path we have a map  $\pi_1(\mathbb{H}^n - X^1) \ni [c] \rightarrow \mu_c(c) \in \mathbb{M}^{3+1}$ . It is quite evident that this map is an homomorphism.

For every geodesic  $l \subset X_{(1)}$  consider an admissible path  $s_l$  which winds around  $l$ . Now we can join  $s_l$  to  $x_0$  with an admissible arc  $d$ . Consider the loop  $c_l = d * s_l * d^{-1}$ . Notice that the family  $\{c_l\}$  generates  $\pi_1(\mathbb{H}^n - X_{(1)}, x_0)$ . On the other hand we have  $\mu_{c_l}(c_l) = \mu_{s_l}(s_l)$  and since the weights verify the equation  $p_l$  we get  $\mu_{c_l}(c_l) = 0$ . It follows that  $\mu_c(c) = 0$ . Thus  $\mu$  is a measure on  $(\mathcal{C}, X)$ . ■

Now consider a family of weights  $a = \{a(P)\}$ . We have seen that this family induces a measure  $\mu$  on  $\mathcal{C}$ . By theorem 8.6 we know that there is a domain which corresponds to  $\mu$ . Let us denote this domain by  $\Omega$ : we want to describe the CT-level surface  $S = T^{-1}(1)$  and the singularity  $\Sigma$ .

**Proposition 9.2** *Consider the decomposition of  $S$ :  $S_{(i)} := \{x \in S \mid \dim N^{-1}N(x) \cap S = i\}$  (for  $i=0,1,2$ ). Then we have*

$$\overline{S}_{(i)} = \sqcup \{N^{-1}(C) \cap S \mid C \text{ is a } 3 - i \text{ piece}\}.$$

If  $\Delta$  is a 3-piece  $N^{-1}(\Delta)$  is obtained from  $\Delta$  by a traslation and in particular the normal field  $N$  restricted to every component of  $S_0$  is an isometry.

If  $P$  is a 2-piece then  $N^{-1}(P)$  is isometric to  $P \times [0, a(P)]$  and the normal field coincides with the projection on the first factor.

Finally if  $l$  is a geodesic piece then  $N^{-1}(l)$  is isometric to  $l \times F_l$  where  $F_l$  is an euclidean  $k$ -gon. More precisely, let  $P_1, \dots, P_k$  and  $\Delta_1, \dots, \Delta_k$  be respectively the 2-piece and 3-piece which incide on  $l$  ( the numeration is choosen as above). Then there is a numeration of the  $F_l$  edges  $e_1, \dots, e_k$  such that the lenght of  $e_i$  is  $a(P_i)$  and the angle between  $e_{i-1}$  and  $e_i$  is  $\pi - \alpha_i$  where  $\alpha_i$  is the dihedral angle of  $\Delta_i$  along  $l$ .

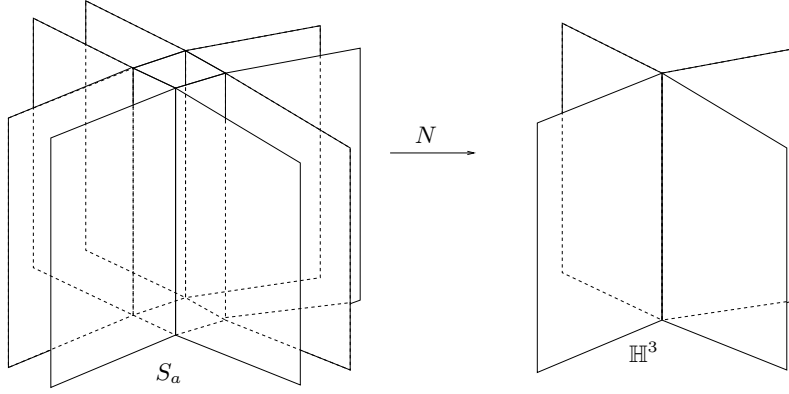

Figure 8: The inverse image of a neighborhood of a point in  $\mathbb{H}^3$  on the CT-level-surface of a regular domain with simplicial singularity.

*Proof* : Fix a base point  $x_0$  and for every 3-piece  $\Delta$  let  $\rho_\Delta = \mu_c(c)$  where  $c$  is an admissible path which join  $x_0$  to  $\Delta$ . Clearly  $\rho_\Delta$  does not depend on the path  $c$  and so it is well defined. Moreover we have

$$\Omega = \bigcap_{\Delta} \bigcap_{x \in \Delta} \{p \in \mathbb{M}^{3+1} \mid \langle p - \rho_\Delta, x \rangle < 0\}.$$

Now for every  $x \in \mathbb{H}^n$  there exists a unique support plane  $P_x$  of  $\Omega$  which is orthogonal to  $x$  and such that  $P_x \cap \overline{\Omega} \neq \emptyset$ . On the other hand we have that  $r(N^{-1}(x)) = P_x \cap \overline{\Omega}$ .

Suppose now that  $x \in \Delta$ : by definition of  $\Omega$  we have that  $P_x$  is the plane which passes through  $\rho_\Delta$  and is orthogonal to  $x$ .

By using inequality (11) one can see that  $\Omega \cap P_x = \{\rho_\Delta\}$  if  $x \in \text{int}\Delta$ . Let now  $x \in P$  where  $P$  is a 2-piece. The same inequality gives that  $\Omega \cap P_x = [\rho_{\Delta_-}, \rho_{\Delta_+}]$  where  $\Delta_-$  and  $\Delta_+$  are the 3-pieces which incide on  $P$ . Finally suppose that  $x \in l$  for some geodesic pieces  $l$ . We have that  $\Omega \cap P_x$  is the convex hull of  $\rho(\Delta_i)$  where  $\Delta_1, \dots, \Delta_k$  are the 3-pieces which incide on  $l$ . Let  $P_i$  the 2-piece which separates  $\Delta_i$  from  $\Delta_{i+1}$ . Notice that  $P_x \cap \overline{\Omega}$  is a  $k$ -gon with vertices  $p_i = \rho_{\Delta_i}$ . Moreover we have  $\rho_{\Delta_{i+1}} - \rho_{\Delta_i} = a(P_i)v_i$  (where  $v_i$  is the normal vector to  $P_i$  which point towards  $\Delta_{i+1}$ ). It is easy to see that the edges of  $P_x \cap \overline{\Omega}$  are  $e_i = [p_i, p_{i+1}]$  so that the length of  $e_i$  is  $a(P_i)$ . Moreover the angle between  $e_{i-1}$  and  $e_i$  is equal to the angle between  $-v_{i-1}$  and  $v_i$ . Since the angle between  $v_{i-1}$  and  $v_i$  is equal to the dihedral angle of  $\Delta_i$  along  $l$  we get that  $P_x \cap \overline{\Omega}$  is isometric to the  $k$ -gon  $F_l$  defined in the proposition.

From this analysis it follows that  $N^{-1}(\Delta) \cap S = \Delta + \rho_\Delta$  and so the normal field is an isometry on  $N^{-1}(\Delta)$ .

Consider now a 2-piece  $P$ . We have seen that  $r(N^{-1}(x)) = [\rho_{\Delta_-}, \rho_{\Delta_+}]$  for all  $x \in P$ . Thus  $[\rho_{\Delta_-}, \rho_{\Delta_+}] \times P \ni (p, x) \rightarrow p + x \in N^{-1}(P) \cap S$  is a parametrization: notice that this map is an isometry (in fact the segment  $[\rho_{\Delta_-}, \rho_{\Delta_+}]$  is orthogonal to  $P$ ), and the normal map coincides with the projection on the second factor.

An analogous argumentation shows the last statement of the proposition. ■

For  $i = 0, 1, 2$  let  $\Sigma_i = \{p \in \Sigma \mid \dim \mathcal{F}(p) = 3 - i\}$  (recall that  $\mathcal{F}(p) = N(r^{-1}(p))$ ). From the last proposition we immediately get the following corollary:

**Corollary 9.3** *If  $\Omega$  is as above then  $\Sigma$  is naturally a cellular complex in the following sense.  $\Sigma_0$  is a numerable set; every component  $s$  of  $\Sigma_1$  is an open segment moreover the closure of  $s$  is*

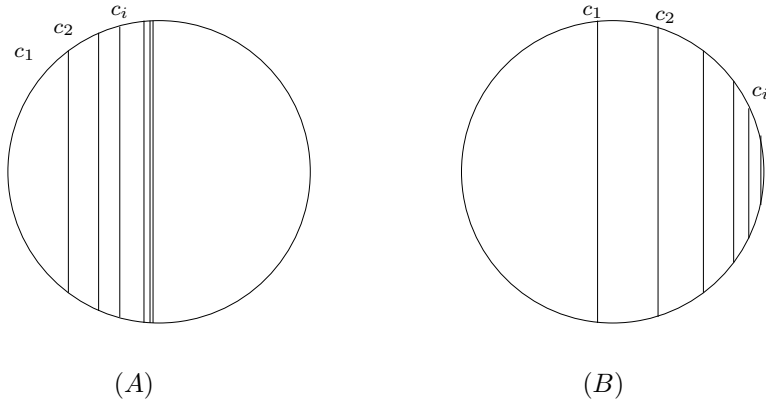

Figure 9: On the left a non-simplicial stratification and on the right a simplicial stratification.

a closed segment and  $\partial s = \bar{s} - s$  is contained in  $\Sigma_0$ ; every component  $\sigma$  of  $\Sigma_2$  is an open 2-cell, moreover the closure of  $\sigma$  is a closed 2-cell and in fact it is a finite union of  $\sigma$  with segments in  $\Sigma_1$  and points in  $\Sigma_0$ .

■

**Remark 9.4** Notice that we have not done any hypothesis of local finiteness of the cells.

**Remark 9.5** If  $\mathcal{C}$  is a simplicial stratification of  $\mathbb{H}^3$  we can construct the dual complex. For every 3-piece  $\Delta$  there is a vertex  $v_\Delta$ , for every 2-piece  $P$  there is the segment  $[v_\Delta, v'_{\Delta'}]$  where  $\Delta$  and  $\Delta'$  are the 3-pieces which incide on  $P$ , and for every 1-piece  $l$  there is the polygon with vertices  $v_{\Delta_1}, \dots, v_{\Delta_n}$  where  $\Delta_1, \dots, \Delta_n$  are the pieces which incide on  $l$ .

Notice that  $\Sigma$  is combinatorially equivalent to the dual complex of  $\mathcal{C}$ . Thus the combinatorial structure of  $\Sigma$  depends only on the combinatorial structure of  $\mathcal{C}$ . This remark points out the duality between stratifications and singularities.

We want to describe a class of regular domains whose stratification is simplicial. As we are going to see, there are regular domains with simplicial stratification which do not belong to this class. However the domain  $\mathcal{D}_\tau$  has simplicial stratification if and only if it belongs to this class.

**Def. 9.3** The singularity  $\Sigma$  of a future complete regular domain is simplicial if there exists a cellularization  $\Sigma_0 \subset \Sigma_1 \subset \Sigma_2$  such that  $\Sigma_0$  is a discrete set, every component of  $\Sigma_1 - \Sigma_0$  is a straight segment and every component of  $\Sigma_2 - \Sigma_1$  is a finite-sided spacelike polygon with vertices in  $\Sigma_0$  and edges in  $\Sigma_1$ .

**Remark 9.6** We shall prove that a regular domain with simplicial singularity has simplicial stratification. If we do not require that  $\Sigma_0$  is discrete this result is no more true. Consider for instance the stratification of  $\mathbb{H}^2$  given in fig.9 (A) (here the example is given for  $n = 2$ , but a very analogous example holds for  $n = 3$ ). It is easy to construct a regular domain with a such stratification and singularity with a cell decomposition.

On the other han there exists regular domain with simplicial stratification which has not simplicial singularity. For instance consider the stratification of  $\mathbb{H}^2$  given in fig.9 (B). It is easy to construct a regular domain with a such stratification whose singularity  $\Sigma$  is compact in  $\mathbb{M}^{2+1}$ . It follows that  $\Sigma_0$  is not discrete.

**Remark 9.7** Let  $\Sigma$  be a simplicial singularity of a future complete regular domain  $\Omega$ . Notice that we can consider on  $\Sigma$  a weak topology induced by the cellularization ( $A \subset \Sigma$  is open in this topology if and only if the intersection of  $A$  with every open cell is open). Since we do not require the local finiteness of the cells, generally this topology is finer than the topology induced by  $\mathbb{M}^{3+1}$ .

Notice that every open cell has a natural distance. Thus if  $c$  is a path in  $\Sigma$  we can define the length of  $c$  as the sum of the lengths of the intersections of  $c$  with the cells of  $\Sigma$ . Finally we can define a path-distance on  $\Sigma$  such that  $d_\Sigma(r, r')$  is the infimum of the lengths of the paths from  $r$  to  $r'$ . It is easy to see that this distance agrees with the natural distance on  $\Sigma$  described in section 7. Thus the topology induced by  $\mathbb{M}^{3+1}$  on  $\Sigma$  generally is finer than the topology induced by  $d_\Sigma$ .

Now we can prove that at least the regular domains with a proper and surjective normal field and simplicial singularity are given by a measured simplicial stratification of  $\mathbb{H}^3$ . We start with a technical lemma.

**Lemma 9.8** *Let  $\Omega$  be a regular domain with proper normal field  $N$  and simplicial singularity. We have  $\Sigma_i = \{p \in \Sigma \mid \dim \mathcal{F}(p) \geq 3 - i\}$ .*

*Proof :* By proposition 4.14 we have that if  $p$  and  $q$  lie in the same component of  $\Sigma_1 - \Sigma_0$  or  $\Sigma_2 - \Sigma_1$  then  $\mathcal{F}(p) = \mathcal{F}(q)$ . Let  $p \in \Sigma_1 - \Sigma_0$  and let  $[r_0, r_1]$  be a component of  $p$  in  $\Sigma_1 - \Sigma_0$ . Take  $q \in (r_0, r_1)$ , since  $p - q^\perp$  separates  $\mathcal{F}(p)$  from  $\mathcal{F}(q)$  it follows that this plane contains  $\mathcal{F}(p)$ , then  $\dim \mathcal{F}(p) < 3$ . In analogous way we can prove that if  $p \in \Sigma_2 - \Sigma_1$  then  $\dim \mathcal{F}(p) < 2$ . This proves an inclusion.

Fix now a component  $[r_0, r_1]$  of  $\Sigma_1 - \Sigma_0$ . We want to prove that  $\dim \mathcal{F}(p) > 1$  for  $p \in [r_0, r_1]$ . First suppose that there not exists any cell in  $\Sigma_2 - \Sigma_1$  which incides on  $p$ . Since  $\Sigma$  is contractile it follows that  $\Sigma - (r_0, r_1)$  is not connected. Thus  $\Omega - r^{-1}(r_0, r_1)$  is not connected and one easily see that it is possible only if  $\mathcal{F}(p)$  is a plane for  $p \in (r_0, r_1)$ . Suppose now that there exists a component  $T$  of  $\Sigma_2 - \Sigma_1$  which incides on  $[r_0, r_1]$ . We want to see that this component is not unique. Let  $l$  be the geodesic which corresponds to  $T$  (i.e. the plane which contains  $T$  is orthogonal to  $l$ ). Since  $[r_0, r_1]$  is an edge of  $l$  there is a vector  $v \in l^\perp$  such that  $v$  is orthogonal to  $[r_0, r_1]$  and  $\langle x - q, v \rangle < 0$  for all  $x \in T - [r_0, r_1]$  and all  $q \in [r_0, r_1]$ . Fix now a point  $x \in l$  and consider a geodesic segment  $c$  starting from  $x$  with direction  $v$ . Since  $N$  is a proper map we have that  $N^{-1}(c)$  is compact. So that there exists a sequence  $p_k \in N^{-1}(c)$  such that  $p_k \rightarrow p$  with  $N(p) = x$ . Put  $\rho_k = r(p_k)$  we have  $\langle \rho_k - r_0, N(p_k) - x \rangle \geq 0$ . On the other hand the direction of  $N(p_k) - x$  converges to  $v$  so that we have  $\langle r(p) - r_0, v \rangle = 0$ . Since  $N(p) \in l$  we have  $\rho_\infty = r(p) \in [r_0, r_1]$ . Since  $rN^{-1}(c)$  is compact and since  $\Sigma_0$  is discrete it is easy to see that there is only a finite number of cells which intersects  $rN^{-1}(c)$ . So that there exists a cell  $T'$  such that  $\rho_k \in \overline{T'}$  for  $k \gg 0$  so that  $\rho_\infty \in T \cap T'$ . Since there exists only a finite number of pieces which correspond to the points in  $T'$  it follows that we can suppose that  $\mathcal{F}(\rho_k)$  does not depend on  $k$ . We know that  $N(p_k) \in c$  so that the segment  $c$  is contained in  $\mathcal{F}(\rho_k)$ . On the other hand it is easy to see that  $\mathcal{F}(\rho_k) \subset \mathcal{F}(\rho_\infty)$  so that  $C = \mathcal{F}(\rho_\infty) \cap (r_1 - r_0)^\perp$  is a face of  $\mathcal{F}(\rho_\infty)$  with dimension equal to 2 (in fact it contains  $l$  and the segment  $c$ ). Since  $\rho_\infty \in [r_0, r_1]$  we have that  $C \subset \mathcal{F}(r)$  for all  $r \in [r_0, r_1]$ . An analogous argument shows that  $\dim \mathcal{F}(p) = 3$  for all vertices  $p$ . ■

**Proposition 9.9** *Let  $\Omega$  be a future complete regular domain with simplicial singularity. Suppose that the normal field  $N$  is a proper map. Then the stratification associated with  $\Omega$  is*

*simplicial. Moreover there exists a unique measure  $\mu$  on  $\mathcal{C}$  such that  $\Omega$  is equal (up to traslations) to the domain associated with  $\mu$ .*

*Proof :* Let  $\mathcal{C}$  be the stratification associated with  $\mathcal{D}_\tau$ . We show that  $\mathcal{C}$  is simplicial. Fix a point  $x$  in  $\mathbb{H}^3$  we have to construct a neighborhood of  $x$  which intersects only a finite number of pieces. If  $x$  does not lie in the 2-stratum  $X$  then it is in the interior of a 3-piece  $\Delta$  and this neighborhood intersects only  $\Delta$ . Suppose now that  $x \in X - X_{(1)}$  where  $X_{(1)}$  is the 1-stratum. There is a 2-piece  $P$  such that  $x \in P - \partial P$ . Now by the hypothesis  $rN^{-1}(P)$  is a segment  $[r_0, r_1]$  and moreover there exists 3-pieces  $\Delta_0$  and  $\Delta_1$  such that  $\{r_i\} = rN^{-1}(\Delta_i)$ . By lemma 4.14 we have that  $P$  is a face of  $\Delta_i$  and moreover  $P = \Delta_0 \cap \Delta_1$ . Thus  $x \in \text{int}(\Delta_0 \cup \Delta_1)$ . Moreover  $\text{int}(\Delta_0 \cup \Delta_1)$  intersects only  $P, \Delta_0$  and  $\Delta_1$ .

Finally suppose  $x \in l$  where  $l$  is 1-piece of  $\mathcal{C}$ . Let  $F = rN^{-1}(l)$ : it is a compact polygon with vertices  $p_1, \dots, p_k$ . For every  $p_i$  let  $\Delta_i$  be the piece such that  $\{p_i\} = rN^{-1}(\Delta_i)$ . We have that  $l$  is equal to the intesection of  $\Delta_i$ . Furthermore  $\Delta_i \cap \Delta_{i+1}$  is a face  $P_i$  and  $\Delta_i \cap \Delta_j = \{l\}$  if the vertices  $p_i, p_j$  are not adjacent. Notice that the dihedral angle of  $\Delta_i$  along  $l$  is equal to  $\pi - \alpha_i$  where  $\alpha_i$  is the angle of  $F$  at  $p_i$ : in fact  $p_{i+1} - p_i$  is a orthogonal vector to  $P_i$  which points toward  $\Delta_{i+1}$ . It follows that the sum of dihedral angle of  $\Delta_i$  along  $l$  is  $2\pi$  and so  $\text{int}(\bigcup \Delta_i)$  is a neighborhood of  $x$ . Notice that this neighborhood intersects only  $l, \Delta_1, \dots, \Delta_n$  and  $P_1, \dots, P_n$ . Thus  $\mathcal{C}$  is a simplicial stratification.

Now we can define a family of weights  $\{a(P)\}$ . In fact if  $P$  is a 2-piece we know that  $rN^{-1}(P)$  is a spacelike segment  $[r_0, r_1]$ , thus we can define  $a(P) = (\langle r_1 - r_0, r_1 - r_0 \rangle)^{1/2}$ . Let us show that this is a family of weights on  $\mathcal{C}$ . Fix a geodesic  $l$  and consider the 2-pieces  $P_1, \dots, P_k$  and the 3-pieces  $\Delta_1, \dots, \Delta_k$  which incides on  $l$ . We suppose  $P_i = \Delta_{i-1} \cap \Delta_i$  and take  $i \bmod k$ . Let  $\{p_i\} = rN^{-1}(\Delta_i)$  we know that  $p_{i+1} - p_i$  is an orthogonal vector to  $P_i$  which points toward  $\Delta_{i+1}$ . So that if  $v_i$  is the normal vector to  $P_i$  which points toward  $\Delta_{i+1}$  we have  $p_{i+1} - p_i = a(P_i)v_i$ . Thus

$$\sum_i a(P_i)v_i = \sum_i p_{i+1} - p_i = 0.$$

Let  $\mu$  be the measure which corresponds to the family  $\{a(P)\}$ , we have to show that up to traslation  $\Omega$  is the domain which corresponds to the measure  $\mu$ .

Fix a base point  $x_0 \in \mathbb{H}^n - X^2$ . Up to traslation we can suppose that  $rN^{-1}(x_0) = 0$ . Now let  $p$  a vertex of  $\Sigma$ , by construction is evident that  $p = \mu_c(c)$  where  $c$  is an admissible path which starts in  $x_0$  and termines in the piece which corresponds to  $p$ . It follows that  $\Omega$  is the regular domain which corresponds to the measure  $\mu$ . ■

In the last part of this section we want to study the  $\Gamma$ -invariant simplicial geodesic laminations where  $\Gamma$  is a free-torsion discrete co-compact subgroup of  $\text{SO}^+(3, 1)$ . We see that for a  $\Gamma$ -invariant simplicial lamination the set of measures on it is parametrized by a finite number of positive number which satisfies a finite set of linear equations.

We start with some remarks about  $\Gamma$ -invariant simplicial stratifications.

**Proposition 9.10** *Let  $\mathcal{C}$  be a  $\Gamma$ -invariant simplicial stratification of  $\mathbb{H}^3$ . Then  $\pi(\mathcal{C})$  is compact for all  $C \in \mathcal{C}$ . In particular the projection of a 1-piece is a simple geodesic whereas the projection of a 2-piece is either a closed hyperbolic surface or a hyperbolic surface with geodesic boundary. Finally there are only a finite number of pieces up to the action of  $\Gamma$ .*

*Proof :* Since  $\mathcal{C}$  is simplicial one easily see that  $\Gamma \cdot \mathcal{C}$  is closed and the projection of  $\mathcal{C}$  is compact. Thus the projection of a 1-pieces  $l$  is a compact complete geodesic and so it is closed. Since the

orbit of  $l$  is formed by the disjoint union of geodesics it follows that the projection is a simple geodesic.

An analogous argument shows that the projection of a 2-piece  $P$  is a hyperbolic surface. Notice that it is closed if  $P$  is a plane otherwise it has totally geodesic boundary.

Let  $K$  be a compact fundamental region for  $\Gamma$ : since  $K$  intersects only a finite number of pieces we get the last statement. ■

Fix a  $\Gamma$ -invariant simplicial stratification  $\mathcal{C}$ . We denote by  $T_{\mathcal{C}}$  the projection of the 2-stratum  $X$  onto the quotient  $M = \mathbb{H}^3/\Gamma$ . Notice that there exists a finite set of simple geodesics  $\{c_1, \dots, c_N\}$  of  $M$  such that  $c_i \subset T_{\mathcal{C}}$  and  $T_{\mathcal{C}} - \bigcup c_i$  is a finite union of totally geodesic submanifold  $F_1, \dots, F_L$  such that  $\overline{F}_i = F_i \cup c_{i_1} \cup \dots \cup c_{i_k}$ . The geodesics  $c_i$  are called the *edges* of the surface whereas the surfaces  $F_i$  are the *faces*. A subset  $X \subset M$  which has a such decomposition is called *piece-wise geodesic surface*. Notice that piece-wise geodesic surfaces correspond bijectively with  $\Gamma$ -invariant geodesic stratification.

No let  $\mu$  be a  $\Gamma$ -invariant measure on  $\mathcal{C}$ . Notice that the family of weights  $\{a(P)\}$  associated with it satisfies  $a(\gamma P) = a(P)$  for all 2-pieces  $P$  and all  $\gamma \in \Gamma$ . Thus there exists a family of positive constants  $\{\alpha(F)\}$  parametrized by the face of  $T_{\mathcal{C}}$  such that  $a(P) = \alpha(\pi P)$ .

This remark suggests the following definition. Let  $T$  be a piece-wise geodesic surface in  $M$  and let  $\mathcal{C}$  be the stratification associated. A *family of weights* on  $T$  is a family  $\{\alpha(F)\}$  parametrized by the faces of  $T$  such that  $\{a(P) := \alpha(\pi(P))\}$  is a family of weights on  $\mathcal{C}$ . Notice that for every 1-piece  $l$  we have that the equation associated with  $l$  and equation associated with  $\gamma(l)$  are related by the identity

$$p_{\gamma(l)}(a) = \gamma p_l(a)$$

so that the solutions of the equation  $p_l$  coincide with the solutions of  $p_{\gamma l}$ . Thus the conditions we have to impose to ensure  $\{\alpha(F)\}$  is a family of weights can be parametrized by the edges of  $T$ .

Finally we have that the families of weights on  $T$  correspond bijectively with  $\Gamma$ -invariant measures on  $\mathcal{C}$ . Notice that  $T$  is a piece-wise geodesic surface with  $f$  faces and  $e$  edges then the weights on  $T$  corresponds to a subset of  $\mathbb{R}_+^f$  defined by  $2e$  linear equations (in fact every  $p_l$  is equivalent to 2 linear equations). Thus if there exists positive solutions they forms a convex cone of dimension greater than  $f - 2e$ .

**Example 9.1** Now we exhibit some examples of piece-wise geodesic surfaces. Fix an hyperbolic 3-manifolds with totally geodesic boundary  $N$  and consider the canonical decomposition of  $N$  in truncated polyedra (see [10] for the definition). Let  $M$  be the double of  $N$ , notice that the double of the 2-skeleton of the decomposition of  $N$  give a piece-wise geodesic surface  $T$ .

Suppose that every polyedron of the decomposition is a tetrahedron. We want to estimate the number of the edges and the faces of  $T$ . On the boundary of  $N$  the decomposition gives a triangulation. Let  $v, l, t$  be respectively the number of vertices, edges and faces of this triangulation. We have that  $v - l + t = 2 - 2g$  where  $g$  is the genus of  $\partial N$  ( $g \geq 2$ ). On the other hand we have that  $t = 2/3l$  so that we get that  $v - 1/3l = 2 - 2g$ . On the other hand let  $e, f$  be respectively the number of edges and faces of  $T$ . We have that  $v = 2e$  (in fact every edge of  $T$  intersects in two vertices  $\partial N$ ) and  $l = 3e$ . It follows that  $2e - f = 2 - 2g < 0$ .

We conclude this section proving that regular domains which are invariant for some affine deformation of  $\Gamma$  correspond bijectively to  $\Gamma$ -invariant measured simplicial stratifications.



**Corollary 9.11** *There exists a bijective correspondence between  $\Gamma$ -invariant measured simplicial stratifications of  $\mathbb{H}^3$  and future complete regular domains which are invariant for some affine deformation  $\Gamma_\tau$  of  $\Gamma$  and has simplicial singularity.*

*Proof* : It is sufficient to show that  $\Gamma$ -invariant measured simplicial stratifications give domains with simplicial singularity. Now fix a  $\Gamma$ -invariant measured simplicial stratification  $(\mathcal{C}, X, \mu)$  and let  $\{a(P)\}$  be the family of weights associated with it. By proposition 9.10 we get that there exists  $a > 0$  such that  $a \leq a(P)$  for all 2-faces  $P$ . Now for a 3-piece  $\Delta$  let  $\rho_\Delta$  be the corresponding point on  $\Sigma$ . We have that  $\Sigma_0 = \{\rho_\Delta | \Delta \text{ is a 3-piece}\}$ . On the other hand we know that  $d_\Sigma(\rho_\Delta, \rho'_\Delta) \geq a$  so that  $\Sigma_0$  is a discrete set. ■

## 10 Conclusions

Let  $\Gamma$  be a free-torsion co-compact discrete subgroup of  $\text{SO}^+(n, 1)$ . We have seen that for every cocycle  $\tau \in Z^1(\Gamma, \mathbb{R}^{n+1})$  there exists a unique future complete regular domain  $\mathcal{D}_\tau$  which is  $\Gamma_\tau$ -invariant. So the future complete regular domains arise naturally in the study of the Lorentz flat structures on  $\mathbb{R} \times M$ .

In section 4 we have seen that every future complete regular domain is associated with a  $\Gamma$ -invariant geodesic stratification of  $\mathbb{H}^n$ . On the other hand in section 8 we have seen that given a  $\Gamma$ -invariant measured geodesic stratification, we get a future complete regular domain which is invariant for an affine deformation of  $\Gamma$ . Moreover in dimension  $n = 2$  this correspondence agree with the Mess identification between measured geodesic lamination and future complete regular domain.

We can ask if this correspondence is in fact an identification in all dimensions. We have seen in section 9 that this correspondence induces an identification between simplicial stratification and future complete regular domain with simplicial singularity.

The general case seems more difficult. Given a future complete regular domain  $\Omega$  we should construct a **measured geodesic stratification**  $(\mathcal{C}, Y, \mu)$  which gives  $\Omega$ . By looking at the construction of a domain  $\Omega$  we have  $Y = \{x | \#(N^{-1}(x)) > 1\}$  and in fact it is easy to see that this set has null Lebesgue measure in  $\mathbb{H}^n$ . Now suppose that for all admissible paths  $c : [0, 1] \rightarrow \mathbb{H}^n$  there exists a *Lipschitz path*  $\tilde{c} : [0, 1] \rightarrow \tilde{S}_1$  such that  $N(\tilde{c}([0, 1])) = c([0, 1])$ . Under this assumption we could define a measure  $\mu$  on an admissible path in this way. Since the retraction is locally Lipschitz, the map  $r(t) = r(\tilde{c}(t))$  is Lipschitz so that it is differentiable almost everywhere. Consider the  $\mathbb{R}^{n+1}$ -valued measure  $\tilde{\mu}$  on  $[0, 1]$  defined by the identity

$$\tilde{\mu}(E) = \int_E r'(t) dt.$$

Then we could define the transverse measure  $\mu_c$  as the image of the measure  $\tilde{\mu}$ :

$$\mu_c = N_*(\tilde{\mu}).$$

Notice that the assumption is always verified for the regular domains  $\Omega$  which arise from a measured geodesic stratifications. In fact given an admissible path  $c$  the Lipschitz path  $\tilde{c}$  always exists. In fact we can define

$$\tilde{c}(t) = c(t) + \int_0^t \mu_c.$$

Thus the problem is: given an admissible path  $c : [0, 1] \rightarrow \mathbb{H}^n$  we have to find a rectifiable curve  $\tilde{c} \subset \tilde{S}_1$  such that  $N(\tilde{c})$  is the curve  $c$  (notice that if  $\tilde{S}_a$  is strictly convex there exists a unique curve such that  $N(\tilde{c}) = c$  but we do not know if such arc is rectifiable).

In dimension  $n = 2$  one easily see that this problem has always solution because if  $v_1$  and  $v_2$  are the orthogonal vector to two leaves of the lamination then they generate a timelike vector space so that

$$|\langle v_1, v_2 \rangle| \geq \langle v_1, v_1 \rangle^{1/2} \langle v_2, v_2 \rangle^{1/2}.$$

By using this inequality one can see that the lenght of  $\tilde{c}$  is lesser than

$$\ell(c) + \langle r(\tilde{c}(1)) - r(\tilde{c}(0)), r(\tilde{c}(1)) - r(\tilde{c}(0)) \rangle$$

where  $\ell(c)$  is the lenght of  $\mathbb{H}^n$ . Unfortunately in dimension  $n \geq 3$  this argument fails.

## Acknowledgements

The author gratefully thanks Riccardo Benedetti for many helpful conversations.

## References

- [1] L. Andersson, G. Galloway, R. Howard. *The Cosmological Time Function*, Class. Quantum Gravity **15** (1998), 309-322.
- [2] L. Andersson. *Constant Mean Curvature Foliations of Flat Space-times*, Comm. Anal. Geom. **10** (2002), 1125-1150.
- [3] J. Beem, P. Ehrlich. *Global Lorentzian Geometry*, Marcel Dekker, New York (1981).
- [4] R. Benedetti, E. Guadagnini. *Cosmological time in (2 + 1)-gravity*, Nuclear Phys. B **613** (2001), 330-352.
- [5] R. Benedetti, C. Petronio. *Lectures on Hyperbolic Geometry*, Springer-Verlag, Berlin-Heidelberg-New York (1992).
- [6] A. J. Casson, S. Bleiler. *Automorphisms of Surfaces after Nielsen and Thurston*, London Mathematical Society Student Texts. 9 (1998).
- [7] D. B. A. Epstein. *Analytical and Geometric Aspects of Hyperbolic Space*, London Mathematical Society Lecture Note Series 111 (1984).
- [8] R. Geroch. *Domain of Dependence*, Journ. Math. Phys., **11**(1970) 437-449.
- [9] S. W. Hawking, F. R. Ellis. *The Large Scale Structures of Space-time*, Cambridge University Press, Cambridge (1973).
- [10] S. Kojima. *Polyedral decomposition of hyperbolic 3-manifolds with totally geodesic boundary*, in ‘Aspects on Low-Dimensional Manifolds, Kinokuniya, Tokyo’, Adv. Stud. Pure Math., **20** (1992), 93-112.
- [11] G. Mess. *Lorentz Spacetime of Constant Curvature*, Preprint (1990).
- [12] F. Paulin. *Topologie de Gromov equivariante, structures hyperboliques et arbres réels*. Invent. Math. **94**(1988), 53-80.

- [13] K. Scannell. *3-manifolds which are spacelike slices of flat spacetimes* (1999).
- [14] R. K. Skora. *Splittings of surfaces*, Bull. Amer. Math. Soc., **23** (1990), 85-90.