

HOLOMORPHIC DISKS AND KNOT INVARIANTS

PETER OZSVÁTH AND ZOLTÁN SZABÓ

ABSTRACT. We define a Floer-homology invariant for knots in an oriented three-manifold, closely related to the Heegaard Floer homologies for three-manifolds defined in an earlier paper. We set up basic properties of these invariants, including an Euler characteristic calculation, and a description of the behaviour under connected sums. Then, we establish a relationship with HF^+ for surgeries along the knot. Applications include calculation of HF^+ of three-manifolds obtained by surgeries on some special knots in S^3 , and also calculation of HF^+ for certain simple three-manifolds which fiber over the circle.

1. INTRODUCTION

The purpose of this paper is to define and study an invariant for null-homologous knots K in an oriented three-manifold Y . These naturally give rise to invariants for oriented, null-homologous links in Y , since oriented, null-homologous links in Y correspond to certain oriented, null-homologous knots in $Y \#^{n-1}(S^2 \times S^1)$ (where n denotes the number of components of the original link). In the interest of exposition, we describe first some special cases of the construction in the case where the ambient three-manifold is S^3 – the case of “classical links.”

1.1. **Classical links.** Suppose $Y \cong S^3$, and suppose L is an oriented link. In its simplest form, our construction gives a sequence of graded Abelian groups $\widehat{HFK}(L, i)$, where here $i \in \mathbb{Z}$. If L has an odd number of components, the grading is a \mathbb{Z} -grading, while if it has an even number of components, the grading function takes values in $\frac{1}{2} + \mathbb{Z}$.

These homology groups satisfy a number of basic properties, which we outline presently. Sometimes, it is simplest to state these properties for $\widehat{HFK}(L, i, \mathbb{Q})$, the homology with rational coefficients: $\widehat{HFK}(L, i, \mathbb{Q}) \cong \widehat{HFK}(L, i) \otimes_{\mathbb{Z}} \mathbb{Q}$.

First, the Euler characteristic is related to the Alexander-Conway polynomial of L , $\Delta_L(T)$ by the following formula:

$$(1) \quad \sum \chi(\widehat{HFK}(L, i, \mathbb{Q})) \cdot T^i = (T^{-1/2} - T^{1/2})^{n-1} \cdot \Delta_L(T),$$

where n denotes the number of components of L (it is interesting to compare this with [1], [15], and [6]). The sign conventions on the Euler characteristic here are given

PSO was supported by NSF grant number DMS 9971950 and a Sloan Research Fellowship.

ZSz was supported by NSF grant number DMS 0107792 and a Packard Fellowship.

by

$$\chi(\widehat{HFK}(L, i, \mathbb{Q})) = \sum_{d \in \left(\frac{n-1}{2}\right) + \mathbb{Z}} (-1)^{d + \frac{n}{2} - \frac{1}{2} \text{rk}} \left(\widehat{HFK}_d(L, i, \mathbb{Q}) \right).$$

Our grading conventions are justified by the following property. If \bar{L} denotes the mirror of L (i.e. switch over- and under-crossings in a projection for L), then

$$(2) \quad \widehat{HFK}_d(L, i, \mathbb{Q}) \cong \widehat{HFK}_{-d}(\bar{L}, -i, \mathbb{Q}).$$

Another symmetry these invariants enjoy is the following conjugation symmetry:

$$(3) \quad \widehat{HFK}_d(L, i, \mathbb{Q}) \cong \widehat{HFK}_{d-2i}(L, -i, \mathbb{Q}),$$

refining the symmetry of the Alexander polynomial. Finally, the invariants remain unchanged after an overall orientation reversal of the link,

$$(4) \quad \widehat{HFK}_d(L, i, \mathbb{Q}) \cong \widehat{HFK}_d(-L, i, \mathbb{Q}).$$

These groups also satisfy a Künneth principle for connected sums. Specifically, let L_1 and L_2 be a pair of disjoint, oriented links which can be separated from one another by a two-sphere. Choose a component of L_1 and L_2 , and let $L_1 \# L_2$ denote the connected sum performed at these components. Then,

$$(5) \quad \widehat{HFK}(L_1 \# L_2, i, \mathbb{Q}) \cong \bigoplus_{i_1 + i_2 = i} \widehat{HFK}(L_1, i_1, \mathbb{Q}) \otimes_{\mathbb{Q}} \widehat{HFK}(L_2, i_2, \mathbb{Q})$$

(see Corollary 7.2 for a more general statement). Of course, this can be seen as a refinement of the fact that the Alexander polynomial of links is multiplicative under connected sums.

Let L_1 and L_2 be two links as above. Then, we can also form their disjoint union $L_1 \amalg L_2$. We have that

$$(6) \quad \widehat{HFK}(L_1 \amalg L_2, i, \mathbb{Q}) \cong \widehat{HFK}(L_1 \# L_2, i, \mathbb{Q}) \otimes W$$

where W is a two-dimensional graded vector space splitting into two one-dimensional pieces

$$W \cong W_{-1/2} \oplus W_{1/2},$$

where $W_{\pm 1/2}$ has grading $\pm 1/2$. The above is a manifestation of the advantage of \widehat{HFK} over the Alexander polynomial: the Alexander polynomial of any split link vanishes.

These invariants also satisfy a “skein exact sequence” (compare [7], [4], [22], [12]). Suppose that L is a link, and suppose that p is a positive crossing of some projection of L . Following the usual conventions from skein theory, there are two other associated links, L_0 and L_- , where here L_- agrees with L_+ , except that the crossing at p is changed, while L_0 agrees with L_+ , except that here the crossing p is resolved. These three cases are illustrated in Figure 1. There are two cases of the skein exact sequence, according to

whether or not the two strands of L_+ which project to p belong to the same component of L_+ .

Suppose first that the two strands which project to p belong to the same component of L_+ . In this case, the skein exact sequence reads:

$$(7) \quad \dots \longrightarrow \widehat{HFK}(L_-) \longrightarrow \widehat{HFK}(L_0) \longrightarrow \widehat{HFK}(L_+) \longrightarrow \dots,$$

where all the maps above respect the splitting of $\widehat{HFK}(L)$ into summands (e.g. $\widehat{HFK}(L_-, i)$ is mapped to $\widehat{HFK}(L_0, i)$). Furthermore, the maps to and from $\widehat{HFK}(L_0)$ drop degree by $\frac{1}{2}$. The remaining map from $\widehat{HFK}(L_+)$ to $\widehat{HFK}(L_-)$ does not necessarily respect the absolute grading; however, it can be expressed as a sum of homogeneous maps¹, none of which increases absolute grading. When the two strands belong to different components, we obtain the following:

$$(8) \quad \dots \longrightarrow \widehat{HFK}(L_-) \longrightarrow \widehat{HFK}(L_0) \otimes V \longrightarrow \widehat{HFK}(L_+) \longrightarrow \dots,$$

where V denotes the four-dimensional vector space

$$V = V_{-1} \oplus V_0 \oplus V_1,$$

where here $V_{\pm 1}$ are one-dimensional pieces supported in degree ± 1 , while V_0 is a two-dimensional piece supported in degree 0. Moreover, the maps respect the decomposition into summands, where the i^{th} summand of the middle piece $\widehat{HFK}(L_0) \otimes V$ is given by

$$\left(\widehat{HFK}(L_0, i - 1) \otimes V_1\right) \oplus \left(\widehat{HFK}(L_0, i) \otimes V_0\right) \oplus \left(\widehat{HFK}(L_0, i + 1) \otimes V_{-1}\right).$$

The shifts in the absolute gradings work just as they did in the previous case.

In addition to establishing the above properties, we calculate this invariant for some examples. For a more detailed discussion of the link invariants in the classical case, we refer the reader to the sequel, [23]. In particular, in that article, we determine the invariants for alternating links. In a different direction, if L is a fibered link and

¹A graded group is one which splits as $A = \bigoplus_{k \in \mathbb{Q}} A_k$. A homogeneous element is one which is supported in A_k for some k . A map between graded groups $\phi: A \rightarrow B$ is said to be *homogeneous of degree d* if ϕ maps all the A_k into B_{k+d} . The map ϕ is said to be homogeneous if it is homogeneous of degree d , for some d .

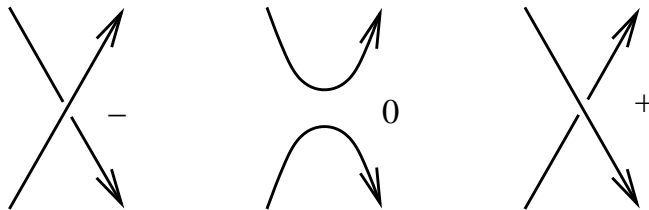

FIGURE 1. Skein moves at a double-point.

d denotes the degree of $\Delta_L(T)$, then we have that $\widehat{HFK}(L, d + (\frac{n-1}{2})) \cong \mathbb{Z}$. This statement is a generalization of the fact that the Alexander-Conway polynomial of a fibered link is monic. We do not prove this fact in the present paper, but rather give the proof in [21].

Suppose now that our link consists of a single component, i.e. it is a knot K . In this case, the homology groups also give bounds on the genus g of the knot K : if $\widehat{HFK}(K, s) \neq 0$, then

$$|s| \leq g.$$

Since the knot homology groups can be viewed as a refinement of the Alexander polynomial, it is natural to ask whether they contain more information (as they did in the case of links). In fact, it is easy to see that they do – as graded Abelian groups, \widehat{HFK} distinguishes the right-handed from the left-handed trefoil. More interestingly, building on the material in [23], we show in [24] that \widehat{HFK} distinguishes all non-trivial pretzel knots of the form $P(2a+1, 2b+1, 2c+1)$ from the unknot (note that these include knots with trivial Alexander polynomial). Indeed, in that paper, it is also shown that \widehat{HFK} can distinguish knots which differ by a Conway mutation.

Moreover, we conjecture that the genus bounds stated earlier are sharp:

Conjecture 1.1. *If $K \subset S^3$ is a knot with genus g , then*

$$\widehat{HFK}(K, g) \neq 0.$$

Our evidence for this conjecture is based on three ingredients. The first is a relationship between the knot Floer homology groups and Heegaard Floer homology, which is established in Section 4. Next, we appeal to the conjectured relationship between Heegaard Floer homology and Seiberg-Witten Floer homology (c.f. [20]). And finally, non-triviality of the corresponding Seiberg-Witten objects is established by work of Kronheimer-Mrowka [13], which in turn rests on work of Gabai [8] and Eliashberg-Thurston [5].

1.2. General case. In the above discussion, we restricted attention to a rather special case of our constructions, in the interest of exposition. As we mentioned, the constructions we give here actually generalize to the case where the ambient three-manifold Y is an arbitrary closed, oriented three-manifold and K is a null-homologous knot; and indeed, the algebra also gives more information than simply the knot homology groups. In their more general form, the constructions give a $\mathbb{Z} \oplus \mathbb{Z}$ -filtration on the chain complex $CF^\infty(Y, \mathfrak{s})$ used for calculating the Heegaard homology $HF^\infty(Y, \mathfrak{s})$ defined in [20] (where here \mathfrak{s} is any Spin^c structure over Y). This filtration also induces a \mathbb{Z} filtration on $\widehat{CF}(Y, \mathfrak{s})$; and the knot homology groups we described above are the homology groups of the associated graded complex (in the case where $Y \cong S^3$).

The paper is organized as follows. In Section 2, we set up the relevant topological preliminaries: the passage from links to knots, Heegaard diagrams and knots, and some

of the algebra of filtered chain complexes. In Section 3 we give the definition of the knot filtration, and prove its topological invariance. In that section, we also establish some of the symmetries of the invariants. In Section 4, we explain how the filtration can be used to calculate the Floer homology groups of three-manifolds obtained by “large surgeries” along the knot K . In Section 5, we derive an “adjunction inequality” which relates \widehat{HFK} and the genus of the knot. In Section 6, we give some sample calculations for the knot homology groups of some special classes of classical knots. With this done, we return to some general properties: the Künneth principle for connected sums, and the surgery long exact sequences in Sections 7 and 8 respectively. As an application of these general results, we conclude with some calculations of $HF^+(Y, \mathfrak{s})$ for certain simple three-manifolds which fiber over the circle (in the case where the first Chern class of the Spin^c structure \mathfrak{s} evaluates non-trivially on the fibers). The three-manifolds considered here include $Y \cong S^1 \times \Sigma_g$ for arbitrary g , and also mapping tori of a single, non-separating Dehn twist. Finally in Section 10 we point out how the results from the paper specialize to the properties and formulae stated in Subsection 1.1.

We will return to other applications of these constructions in future papers. For example, the constructions play a central role in [21], where they are used to define invariants of contact structures for three-manifolds.

1.3. Further remarks. The fact that a knot in Y induces a filtration on $CF^\infty(Y)$ has been discovered independently by Rasmussen in [25], where he uses the induced filtration to compute the Floer homologies of three-manifolds obtained as surgeries on two-bridge knots. In fact, we have learned that many of the constructions presented here have been independently discovered by Rasmussen in his thesis [26].

In another direction, it worth pointing out the striking similarity between the knot homology groups described here and Khovanov’s homology groups [12] (see also [2]). Although our constructions here are quite different in spirit from Khovanov’s, the final result is analogous: we have here a homology theory whose Euler characteristic is the Alexander polynomial, while Khovanov constructs a homology theory whose Euler characteristic is the Jones polynomial. It is natural to ask whether there is a simultaneous generalization of these two homology theories.

1.4. Acknowledgments. The authors wish to warmly thank Paolo Lisca, Tomasz Mrowka, Jacob Rasmussen, and András Stipsicz for some interesting discussions. We would also like to thank the referee for some helpful comments.

2. TOPOLOGICAL PRELIMINARIES

2.1. From knots to links. Although we discussed links in the introduction, we will focus mainly on the case of knots in the paper. Our justification for the apparent loss of generality is the observation that oriented n -component links in Y correspond to oriented knots in $Y \#^{n-1}(S^2 \times S^1)$. For related constructions, see [10]; compare also [4] and [6].

More precisely, suppose that L is an n -component oriented three-manifold Y . Then, we can construct an oriented knot in $Y \#^{n-1}(S^2 \times S^1)$ as follows. Fix $2n - 2$ points $\{p_i, q_i\}_{i=1}^{n-1}$ in L , which are then pairwise grouped together (i.e., $n - 1$ embedded zero-spheres in L), in such a manner that if we formally identify each p_i with q_i in L , we obtain a connected graph. We view p_i, q_i as the feet of a one-handle to attach to Y . Let $\kappa(Y, \{p_i, q_i\})$ denote the new three-manifold. Of course, $\kappa(Y, \{p_i, q_i\}) \cong Y \#^{n-1}(S^2 \times S^1)$. Now, inside each one-handle, we can find a band along which to perform a connected sum of the component of L containing p_i with the component containing q_i . We choose the band so that the induced orientation of its boundary is compatible with the orientation of L_1 and L_2 . Our hypotheses on the number and distribution of the distinguished points ensures that the newly-constructed link (after performing all $n - 1$ of the connected sums) is a single-component knot, which we denote $\kappa(L, \{p_i, q_i\})$, inside $\kappa(Y, \{p_i, q_i\})$.

Proposition 2.1. *The above construction induces a well-defined map from the set of isotopy classes of oriented, n -component links in Y to the set of isotopy classes of oriented knots in $Y \#^{n-1}(S^2 \times S^1)$. More precisely, if L and L' are isotopic links, an $\{p_i, q_i\}_{i=1}^{n-1}$ and $\{p'_i, q'_i\}_{i=1}^{n-1}$ are auxiliary choices of points as above, then there is an orientation-preserving diffeomorphism*

$$\kappa(Y, \{p_i, q_i\}) \longrightarrow \kappa(Y, \{p'_i, q'_i\})$$

which carries the oriented knot $\kappa(L, \{p_i, q_i\})$ to a knot which is isotopic to $\kappa(L, \{p'_i, q'_i\})$.

Proof. First, we argue that for a fixed set of points $\{p_i, q_i\}_{i=1}^{n-1}$ in L as above, the isotopy class of the induced knot in $Y \#^{n-1}(S^2 \times S^1)$ is independent of the choices of bands connecting the p_i to q_i (inside the one-handles). This can be seen using an isotopy supported inside the one-handle.

Next, we argue that the isotopy class of $\kappa(L)$ is independent of the choice of points $\{p_i, q_i\}_{i=1}^{n-1}$.

The key observation is that if we have three components K_1, K_2, K_3 , and distinguished points $p_1 \in K_1$ with $q_1 \in K_2$, and $p_2 \in K_1$ and $q_2 \in K_3$, then we can handleslide the one-handle specified by $\{p_2, q_2\}$ over $\{p_1, q_1\}$ to obtain a new one-handle $\{p_3, q_3\}$, where $p_3 \in K_2, q_3 \in K_3$ (c.f. Figure 2).

We say that the points are arranged in a linear chain if for some ordering on the components of L , $\{K_i\}_{i=1}^n$, if for each $i = 1, \dots, n - 1$, we have that $p_i \in K_i$ and $q_i \in K_{i+1}$. First, we claim that given any initial collection of points $\{p'_i, q'_i\}_{i=1}^n$, we can

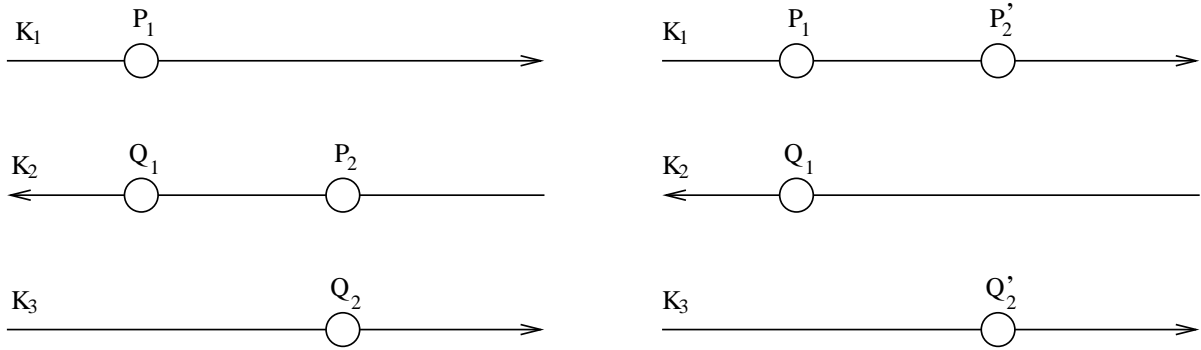

FIGURE 2. **Handleslides.** An illustration of the handleslide used in Proposition 2.1. We slide the handle specified by $\{p_2, q_2\}$ over that specified by $\{p_1, q_1\}$ to obtain the new one-handle specified by $\{p'_1, q'_1\}$

pass to a linear chain. To see this, we let K_1 denote a circle with the minimal number of distinguished points on it. Clearly K_1 has only one distinguished point, which we denote p_1 . By induction, we can find a sequence K_1, \dots, K_i so that K_1 contains only one distinguished point, K_2, \dots, K_{i-1} all contain only two distinguished points; indeed, $p_i \in K_i$ and $q_i \in K_{i+1}$ for $i = 1, \dots, i - 1$. If K_i contains no other distinguished p_i , then it follows from the connectivity hypothesis that $i = n$, and we have arranged all our points in a linear chain. Otherwise, we fix some $p_i \in K_i$. Its corresponding point q_i lies on some other component of L which, according to the hypothesis, is not among K_1, \dots, K_i . We denote that circle by K_{i+1} . Again, by a sequence of handleslides over this one-handle, we can push all other marked points from on K_i to K_{i+1} .

Finally, any two linear chains can be connected by handleslides as above. Specifically, choose any linear ordering of the components of L , and consider the induced linear chain. In the case where K_1, K_2, K_3 are the first three components in this linear ordering, the handleslide described illustrated in Figure 2 induces the permutation of K_1 and K_2 . More generally, it is easy to realize a permutation of two consecutive components as a composition of two such handleslides. \square

The above construction is more than a curiosity: it plays a central role in the “skein exact sequence” described in Section 8 below.

2.2. Heegaard diagrams and knots.

Definition 2.2. For us, a knot will consist of a pair (Y, K) , where Y is an oriented three-manifold, and $K \subset Y$ is an embedded, oriented, null-homologous circle.

A knot (Y, K) has a Heegaard diagram

$$(\Sigma, \alpha, \beta_0, \mu),$$

where here α is an unordered g -tuple of pairwise disjoint attaching circles $\alpha = \{\alpha_1, \dots, \alpha_g\}$, β_0 is a $(g - 1)$ -tuple of pairwise disjoint attaching circles $\{\beta_2, \dots, \beta_g\}$, μ is an embedded, oriented circle in Σ which is disjoint from the β_0 , and, of course g is the genus of Σ . This data is chosen so that $(\Sigma, \alpha, \beta_0)$ specifies the knot-complement $Y - \text{nd}(K)$, i.e. if we attach disks along the α and β_0 , and then add a three-ball, we obtain the knot-complement. Moreover, μ represents the “meridian” for the knot in Y ; thus, $(\Sigma, \alpha, \{\mu\} \cup \beta_0)$ is a Heegaard diagram for Y .

Definition 2.3. *A marked Heegaard diagram for a knot (Y, K) is a quintuple $(\Sigma, \alpha, \beta_0, \mu, m)$, where here $m \in \mu \cap (\Sigma - \alpha_1 - \dots - \alpha_g)$.*

The distinction between pointed Heegaard diagrams (in the sense of [20]) and marked Heegaard diagrams is that in the former, the distinguished point lies in the complement of all the g -tuples, while in the latter, the distinguished point lies on one of the curves.

A marked Heegaard diagram for a knot K can also be used to construct a doubly-pointed Heegaard diagram for Y :

Definition 2.4. *A doubly-pointed Heegaard diagram for a three-manifold Y is a tuple $(\Sigma, \alpha, \beta, w, z)$, where (Σ, α, β) is a Heegaard diagram for Y , and w and z are a pair of distinct basepoints in Σ which do not lie on any of the α or β .*

We extract a doubly-pointed Heegaard diagram for Y from a Heegaard diagram for (Y, K) as follows. Let $(\Sigma, \alpha, \beta_0, \mu, m)$ be a marked Heegaard diagram for a knot complement (Y, K) . We write $\beta = \beta_0 \cup \mu$. Fix an arc δ which meets μ transversely in a single intersection point, which is the basepoint m , and which is disjoint from all the α and β_0 . Then, let z be the initial point of δ , and w be its final point.

Note that the ordering of the two points w and z is specified by the orientation of K . Specifically, choose a longitude λ for K , which we think of this as a curve in the Heegaard surface. Clearly, the orientation on K gives an orientation for λ . Now choose w so that if δ is oriented as a path from z to w , then we have an equality of algebraic intersection numbers: $\#(\delta \cap \mu) = \#(\lambda \cap \mu)$ (for either orientation of μ).

Let $(\Sigma, \alpha, \beta, w, z)$ be a doubly-pointed Heegaard diagram of genus g . As in [20], we consider the g -fold symmetric product $\text{Sym}^g(\Sigma)$, equipped with the pair of tori

$$\mathbb{T}_\alpha = \alpha_1 \times \dots \times \alpha_g \quad \text{and} \quad \mathbb{T}_\beta = \beta_1 \times \dots \times \beta_g.$$

Following notation from [20], if $\mathbf{x}, \mathbf{y} \in \mathbb{T}_\alpha \cap \mathbb{T}_\beta$, we consider spaces of homotopy classes of Whitney disks $\pi_2(\mathbf{x}, \mathbf{y})$. Letting $v \in \Sigma - \alpha_1 - \dots - \alpha_g - \beta_1 - \dots - \beta_g$, and choosing $\phi \in \pi_2(\mathbf{x}, \mathbf{y})$, we let $n_v(\phi)$ denote the oriented intersection number

$$n_v(\phi) = \#\phi^{-1}(\{v\} \times \text{Sym}^{g-1}(\Sigma)).$$

A complex structure on Σ induces a complex structure on $\text{Sym}^g(\Sigma)$ with the property that any Whitney disks ϕ which admits a holomorphic representative has $n_v(\phi) \geq 0$. For a suitable small perturbation of the holomorphic curve condition (which can be encoded as a one-parameter family J of almost-complex structures over $\text{Sym}^g(\Sigma)$), we obtain

a notion of pseudo-holomorphic disks, which form moduli spaces satisfying suitably transverse Fredholm theory (along with the above non-negativity hypothesis). We refer the reader to [20] for a detailed discussion.

2.3. Intersection points and Spin^c structures. Recall that in [20], for a Heegaard diagram for Y , $(\Sigma, \boldsymbol{\alpha}, \boldsymbol{\beta}, w)$, we give a map

$$\mathfrak{s}_w : \mathbb{T}_\alpha \cap \mathbb{T}_\beta \longrightarrow \text{Spin}^c(Y).$$

When Y is equipped with an oriented, null-homologous knot K , and corresponding marked Heegaard diagram, this map has a refinement as follows. Note first that there is a canonical zero-surgery $Y_0(K)$. We define a map

$$\underline{\mathfrak{s}}_m : \mathbb{T}_\alpha \cap \mathbb{T}_\beta \longrightarrow \text{Spin}^c(Y_0(K))$$

where here in the definition of \mathbb{T}_β we use $\boldsymbol{\beta} = \mu \cup \boldsymbol{\beta}_0$. Sometimes, we denote the set $\text{Spin}^c(Y_0(K))$ by $\underline{\text{Spin}}^c(Y, K)$, and call it a set of *relative* Spin^c structures for (Y, K) . Note that

$$\underline{\text{Spin}}^c(Y, K) \cong \text{Spin}^c(Y) \times \mathbb{Z}.$$

The map from $\underline{\text{Spin}}^c(Y, K) \longrightarrow \text{Spin}^c(Y)$ is obtained by first restricting $\underline{\mathfrak{t}}$ to $Y - K$, and then uniquely extending it to Y (note that the composition of these two maps is the map \mathfrak{s}_w described earlier). Projection to the second factor comes from evaluation $\frac{1}{2}\langle c_1(\underline{\mathfrak{t}}, [\widehat{F}]) \rangle$, where here \widehat{F} denotes a surface in $Y_0(K)$ obtained by capping off some fixed Seifert surface F for K . If $\underline{\mathfrak{t}} \in \underline{\text{Spin}}^c(Y, K)$ projects to $\mathfrak{s} \in \text{Spin}^c(Y)$, we say that $\underline{\mathfrak{t}}$ *extends* \mathfrak{s} .

To define $\underline{\mathfrak{s}}_m$, we replace the meridian with a longitude λ for the knot, chosen to wind once along the meridian, never crossing the marked point m , so that each intersection point \mathbf{x} has a pair of closest points \mathbf{x}' and \mathbf{x}'' . Let $(\Sigma, \boldsymbol{\alpha}, \boldsymbol{\gamma}, w)$ denote the corresponding Heegaard diagram for $Y_0(K)$ (i.e. $\boldsymbol{\gamma} = \lambda \cup \boldsymbol{\beta}_0$). We then define $\underline{\mathfrak{s}}_m(\mathbf{x})$ to be the Spin^c structure over $Y_0(K)$ given by $\mathfrak{s}'_w(\mathbf{x}') = \mathfrak{s}'_w(\mathbf{x}'')$, where here $\mathfrak{s}'_w : \mathbb{T}_\alpha \cap \mathbb{T}_\gamma \longrightarrow \text{Spin}^c(Y_0(K))$ denotes the usual map from intersection points to Spin^c structures (which we distinguish here from the analogous map \mathfrak{s}_w for Y). Of course, the points w and z lie in the same component of $\Sigma - \alpha_1 - \dots - \alpha_g - \gamma_1 - \dots - \gamma_g$, so $\mathfrak{s}'_w = \mathfrak{s}'_z$. See Figure 3 for an illustration.

Recall (c.f. [20]) that we can express the evaluation of $\langle c_1(\underline{\mathfrak{s}}_m(\mathbf{x}), [\widehat{F}]) \rangle$ in terms of data on the Heegaard diagram. More precisely, each two-dimensional homology class for Y_0 has a corresponding “periodic domain” P in Σ , i.e. a chain in Σ whose local multiplicity at w is zero, and which bounds curves among the $\boldsymbol{\alpha}$ and $\boldsymbol{\gamma}$. Let $\mathbf{y} \in \mathbb{T}_\alpha \cap \mathbb{T}_\gamma$ be an intersection point, let $\chi(P)$ denote the “Euler measure” of P (which is simply the Euler characteristic of P , if all its local multiplicities are zero or one), and let $\bar{n}_{\mathbf{y}}(P)$ denote the sum of the local multiplicities of P at the points y_i comprising the g -tuple \mathbf{y} (taken with a suitable fraction if it lies on the boundary of P , as defined in Section 7 of [18]; compare also Equation (15) below). Then, it is shown in Proposition 7.5 of [18] that

$$(9) \quad \langle c_1(\mathfrak{s}'_w(\mathbf{y}), [\widehat{F}]) \rangle = \chi(P) + 2\bar{n}_{\mathbf{y}}(P),$$

provided that P is the periodic domain representing \widehat{F} .

Lemma 2.5. *Let $(\Sigma, \alpha, \beta_0, \mu, m)$ be a marked Heegaard diagram for an oriented knot. Given $\mathbf{x}, \mathbf{y} \in \mathbb{T}_\alpha \cap \mathbb{T}_\beta$, for any $\phi \in \pi_2(\mathbf{x}, \mathbf{y})$, we have that*

$$\underline{\mathfrak{s}}_m(\mathbf{x}) - \underline{\mathfrak{s}}_m(\mathbf{y}) = (n_z(\phi) - n_w(\phi)) \cdot \text{PD}[\mu],$$

where here $[\mu] \in H_1(Y_0(K); \mathbb{Z})$ is the homology class obtained by thinking of the meridian of K as a loop in $Y - \text{nd}(K) \subset Y_0(K)$, and oriented so that $\#(\mu \cap F) = 1$.

Proof. We begin with some preliminary observations. Consider the natural Heegaard triple for the the cobordism from Y to Y_0 $(\Sigma, \alpha, \beta, \gamma, w)$, where γ is obtained as before by replacing the meridian μ in the β by the longitude λ . Note also that there is a second basepoint $z \in \Sigma$, which lies in the same component of $\Sigma - \alpha_1 - \dots - \alpha_g - \gamma_1 - \dots - \gamma_g$ as w .

We claim that more generally if $\psi \in \pi_2(\mathbf{x}, \Theta, \mathbf{y})$ is a Whitney triangle (where, as usual, Θ is an intersection point to $\mathbb{T}_\beta \cap \mathbb{T}_\gamma$ representing the canonical top-dimensional homology generator for $HF^{\leq 0}(\#^{g-1}(S^2 \# S^1))$), then we have that

$$(10) \quad \mathfrak{s}'_w(\mathbf{y}) = \underline{\mathfrak{s}}_m(\mathbf{x}) + (n_w(\psi) - n_z(\psi)) \cdot [\text{PD}(\mu)].$$

We see this as follows. First, fix $\mathbf{x} \in \mathbb{T}_\alpha \cap \mathbb{T}_\beta$ and an integer $k \in \mathbb{Z}$, and consider the set $S(\mathbf{x}, k)$ of all $\mathbf{y} \in \mathbb{T}_\alpha \cap \mathbb{T}_\gamma$ for which there is a Whitney triangle $\psi \in \pi_2(\mathbf{x}, \Theta, \mathbf{y})$ with $n_w(\psi) - n_z(\psi) = k$. Clearly, this set is a single Spin^c -equivalence class of intersection points on $Y_0(K)$. Now it is an easy consequence of the definition of $\underline{\mathfrak{s}}$ that Equation (10) holds in the case where $k = 0$.

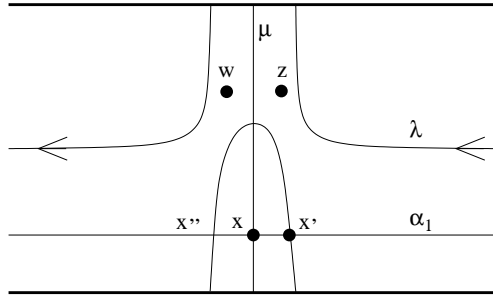

FIGURE 3. Winding once along the meridian. We have pictured the winding procedure to illustrate the relative Spin^c structure corresponding to an intersection point. Note that the pictured region (all of which takes place in a cylinder – i.e. the two dark curves are to be identified) is only a portion of the Heegaard diagram: the tuples \mathbf{x} and \mathbf{x}' in principle contain additional intersection points not pictured here. The orientation of λ induced from K is illustrated by the arrow.

In view of the above remarks, to verify Equation (10), it suffices to verify it in the case where the triangle is supported in the winding region. More precisely, fix an integer k , and consider the “small” triangle ψ_k supported in the winding region (after winding λ sufficiently many times in a neighborhood of μ). For example, when $k \leq 0$, after winding sufficiently many times, we can find a triangle ψ_k which lies on one side of μ , so that $n_w(\psi) = 0$ and $n_z(\psi) = k$. Now $\psi_k \in \pi_2(\mathbf{x}, \Theta, \mathbf{x}'_k)$, where the \mathbf{x}'_i are the various points for $\mathbb{T}_\alpha \cap \mathbb{T}_\gamma$ closest to \mathbf{x} representing various Spin^c structures $[S(\mathbf{x}, k)]$. It is an easy consequence now of Equation (9) and our orientation conventions that

$$\langle c_1(\mathfrak{s}'_w(\mathbf{x}_i)), [\widehat{F}] \rangle - \langle c_1(\mathfrak{s}'_w(\mathbf{x}_j)), [\widehat{F}] \rangle = 2(i - j).$$

This completes the verification of Equation (10).

The equation stated in the lemma now follows from Equation (10) at once: let $\psi \in \pi_2(\mathbf{y}, \Theta, \mathbf{y}')$ be a triangle with $n_z = n_w = 0$, and then apply the formula for the juxtaposed triangle $\psi' = \phi * \psi \in \pi_2(\mathbf{x}, \Theta, \mathbf{y}')$ with $n_w(\psi') - n_z(\psi') = n_w(\phi) - n_z(\phi)$. \square

2.4. Filtered complexes. Fix a partially ordered set S . An S -filtered group is a free Abelian group C generated freely by a distinguished set of generators \mathfrak{S} which admit a map

$$\mathcal{F}: \mathfrak{S} \longrightarrow S.$$

We write elements of C as sums

$$\sum_{\sigma \in \mathfrak{S}} a_\sigma \cdot \sigma,$$

where $a_\sigma \in \mathbb{Z}$. If

$$a = \sum_{\sigma \in \mathfrak{S}} a_\sigma \cdot \sigma \quad \text{and} \quad b = \sum_{\sigma \in \mathfrak{S}'} b_\sigma \cdot \sigma$$

are elements of S -filtered groups $(C, \mathcal{F}, \mathfrak{S})$ and $(C', \mathcal{F}', \mathfrak{S}')$ respectively, then we write $a \leq b$ if

$$\max_{\{\sigma \in \mathfrak{S} \mid a_\sigma \neq 0\}} \mathcal{F}(\sigma) \leq \min_{\{\sigma \in \mathfrak{S}' \mid b_\sigma \neq 0\}} \mathcal{F}'(\sigma).$$

A morphism of S -filtered groups

$$\phi: (C, \mathcal{F}, \mathfrak{S}) \longrightarrow (C', \mathcal{F}', \mathfrak{S}')$$

is a group homomorphism with the property that

$$\phi(a) \leq a$$

for all $a \in C$.

An S -filtered chain complex is an S -filtered group equipped with a differential which is an S -filtered morphism; a morphism of S -filtered chain complexes is a chain map which is also an S -filtered morphism. Let $T \subset S$ be a subset of S with the property that if

$b \in T$, then all elements $a \in S$ with $a \leq b$ also are contained in T . If $T \subset S$ is such a subset, and if $(C_*, \partial, \mathcal{F})$ is an S -filtered complex, then T gives rise to a subcomplex of C_* , which transforms naturally under morphisms.

For example, recall that $CF^\infty(Y, \mathfrak{t})$ defined in [20] is generated by pairs

$$[\mathbf{x}, i] \in (\mathbb{T}_\alpha \cap \mathbb{T}_\beta) \times \mathbb{Z}$$

(where the tori \mathbb{T}_α and \mathbb{T}_β lie in the g -fold symmetric product of a genus g Heegaard surface for Y). Indeed, the map

$$\mathcal{F}[\mathbf{x}, i] = i$$

induces a natural filtration on this complex, and hence endows it with a canonical subcomplex corresponding to the negative integers, $CF^-(Y, \mathfrak{t})$, and a quotient complex $CF^+(Y, \mathfrak{t})$.

In the present paper, we will typically encounter complexes filtered by $\mathbb{Z} \times \mathbb{Z}$, with the partial ordering $(i, j) \leq (i', j')$ if $i \leq i'$ and $j \leq j'$. These complexes have a number of naturally associated subcomplexes. For instance, there is a subcomplex corresponding to the quadrant $\{(i, j) | i \leq 0 \text{ and } j \leq 0\}$; and there is also a subcomplex corresponding to the union of three quadrants $\{(i, j) | i \leq 0 \text{ or } j \leq 0\}$.

3. THE KNOT FILTRATION: DEFINITIONS AND BASIC PROPERTIES

In this section, we begin by giving the definition of the knot filtration. In Subsection 3.2 we prove its topological invariance. In Subsection 3.3, we describe an absolute grading used on the knot filtration. In Subsection 3.5 we describe several symmetries of the filtration: first under orientation reversal of the ambient space, then under orientation reversal of the knot, and finally under conjugation invariance of the underlying relative Spin^c structures.

3.1. Definition of the knot filtration. Let $(\Sigma, \boldsymbol{\alpha}, \boldsymbol{\beta}, w, z)$ be a doubly-pointed Heegaard diagram, and J be an allowed one-parameter family of almost-complex structures over $\text{Sym}^g(\Sigma)$. We can associate to this data a \mathbb{Z}^2 -filtered chain complex, following the constructions of [20]. Specifically, we let $CF^\infty(\Sigma, \boldsymbol{\alpha}, \boldsymbol{\beta}, w, z)$ be the free Abelian group generated by triples $[\mathbf{x}, i, j]$ with $\mathbf{x} \in \mathbb{T}_\alpha \cap \mathbb{T}_\beta$, $i, j \in \mathbb{Z}$. We endow this with the differential:

$$\partial^\infty[\mathbf{x}, i, j] = \sum_{\mathbf{y} \in \mathbb{T}_\alpha \cap \mathbb{T}_\beta} \sum_{\{\phi \in \pi_2(\mathbf{x}, \mathbf{y}) \mid \mu(\phi)=1\}} \# \left(\widehat{\mathcal{M}}(\phi) \right) [\mathbf{y}, i - n_w(\phi), j - n_z(\phi)],$$

where here $\widehat{\mathcal{M}}(\phi)$ denotes the quotient of the moduli space of J -holomorphic disks representing the homotopy type of ϕ , $\mathcal{M}(\phi)$, divided out by the natural action of \mathbb{R} on this moduli space, and $\mu(\phi)$ denotes the formal dimension of $\mathcal{M}(\phi)$. The signed count here uses a coherent choice of orientations, as described in [20]. Moreover, we can endow the chain complex with the structure of a $\mathbb{Z}[U]$ -module, by defining:

$$U \cdot [\mathbf{x}, i, j] = [\mathbf{x}, i - 1, j - 1].$$

Of course, the filtration on the chain complex

$$\mathcal{F}: (\mathbb{T}_\alpha \cap \mathbb{T}_\beta) \times \mathbb{Z}^2 \longrightarrow \mathbb{Z}^2$$

is given by

$$\mathcal{F}[\mathbf{x}, i, j] = (i, j),$$

where $\mathbb{Z} \times \mathbb{Z}$ is given the partial ordering $(i, j) \leq (i', j')$ when $i \leq i'$ and $j \leq j'$.

The complex CFK^∞ naturally splits into a sum of complexes. Specifically, generators $[\mathbf{x}, i, j]$ and $[\mathbf{y}, \ell, m]$ lie in the same summand precisely when there is a homotopy class $\phi \in \pi_2(\mathbf{x}, \mathbf{y})$ with

$$n_w(\phi) = i - \ell \quad \text{and} \quad n_z(\phi) = j - m.$$

In the case studied here – where the doubly-pointed Heegaard diagram comes from from the marked Heegaard diagram of an oriented, null-homologous knot K – this splitting can be interpreted in terms of Spin^c structures over $Y_0(K)$. Specifically, fix a Spin^c structure \mathfrak{s} over Y and let $\underline{\mathfrak{t}} \in \underline{\text{Spin}}^c(Y, K) = \text{Spin}^c(Y_0(K))$ be a Spin^c structure which extends it (c.f. Subsection 2.3). consider the subset $CFK^\infty(Y, K, \underline{\mathfrak{t}}) \subset$

$CF^\infty(\Sigma, \boldsymbol{\alpha}, \boldsymbol{\beta}_0 \cup \mu, w, z)$ generated by triples $[\mathbf{x}, i, j]$ with $\mathfrak{s}_w(\mathbf{x}) = \mathfrak{s}$ and

$$(11) \quad \underline{\mathfrak{s}}_m(\mathbf{x}) + (i - j)PD[\mu] = \underline{\mathfrak{t}},$$

where $[\mu] \in H_1(Y_0(K))$ is the homology class gotten by thinking of the median μ as a closed curve in $Y_0(K)$. According to Lemma 2.5, this is a subcomplex. Note that if $\underline{\mathfrak{t}}_1$ and $\underline{\mathfrak{t}}_2$ represent the same Spin^c structure over Y , then the complexes $CFK^\infty(Y, \underline{\mathfrak{t}}_1)$ and $CFK^\infty(Y, \underline{\mathfrak{t}}_2)$ are isomorphic as chain complexes, and indeed, the only difference is a shift in the $\mathbb{Z} \oplus \mathbb{Z}$ -filtration.

Fix $\underline{\mathfrak{t}}_0 \in \text{Spin}^c(Y, K)$ and let $\mathfrak{s} \in \text{Spin}^c(Y)$ be the compatible element. We can view $CFK^\infty(Y, \overline{K}, \underline{\mathfrak{t}}_0)$ as an extra \mathbb{Z} filtration on $CF^\infty(Y, \mathfrak{s})$, by using the isomorphism

$$\Pi_1 : CFK^\infty(Y, K, \underline{\mathfrak{t}}_0) \longrightarrow CF^\infty(Y, \mathfrak{s})$$

given by

$$\Pi_1[\mathbf{x}, i, j] = [\mathbf{x}, i],$$

and declaring the extra \mathbb{Z} filtration to be induced from the projection of $[\mathbf{x}, i, j]$ to j .

There is also a corresponding filtration structure on $\widehat{CF}(Y, \mathfrak{s})$. Specifically, let

$$CFK^{-,*}(Y, K, \underline{\mathfrak{t}}_0) \subset CFK^\infty(Y, K, \underline{\mathfrak{t}}_0)$$

denote the subcomplex corresponding to (i, j) with $i < 0$, which in turn has a quotient complex $CFK^{+,*}(Y, K, \underline{\mathfrak{t}}_0)$. Of course these complexes can be thought of as induced filtrations on $CF^-(Y, \mathfrak{s})$ and $CF^+(Y, \mathfrak{s})$ respectively. Consider the subcomplex $CFK^{0,*}(Y, K, \underline{\mathfrak{t}}_0) \subset CFK^{+,*}(Y, K, \underline{\mathfrak{t}}_0)$ generated by elements in the kernel of the induced U -action; i.e. these generators all have $i = 0$. This can be thought of as a filtration on $\widehat{CF}(Y, \mathfrak{s})$. The associated graded complex for $CFK^{0,*}(Y, K, \underline{\mathfrak{t}}_0)$ admits an extra \mathbb{Z} -grading which, of course, depended on our initial choice of $\underline{\mathfrak{t}}_0$. However, we can think of this object more invariantly as graded by $\underline{\text{Spin}}^c(Y, K)$. Specifically, for each $\underline{\mathfrak{t}} \in \text{Spin}^c(Y_0(K))$, we have a complex $\widehat{CFK}(Y, K, \underline{\mathfrak{t}})$ which is generated by intersection points \mathbf{x} with $\underline{\mathfrak{s}}_m(\mathbf{x}) = \underline{\mathfrak{t}}$, and its boundary operator counts only homotopy classes $\phi \in \pi_2(\mathbf{x}, \mathbf{y})$ with $n_w(\phi) = n_z(\phi) = 0$. Then the associated graded complex for $CFK^{0,*}(Y, K, \underline{\mathfrak{t}}_0)$ is identified with

$$\bigoplus_{\{\underline{\mathfrak{t}} \in \underline{\text{Spin}}^c(Y, K) \mid \underline{\mathfrak{t}} \text{ extends } \mathfrak{s}\}} \widehat{CFK}(Y, K, \underline{\mathfrak{t}}),$$

where the summand of the associated graded object for $CFK^{0,*}(Y, K, \underline{\mathfrak{t}}_0)$ belonging to the integer j corresponds to the summand of the above complex belonging to $\underline{\mathfrak{t}} = \underline{\mathfrak{t}}_0 - j \cdot PD[\mu]$.

When considering the complex $CFK^\infty(Y, K, \underline{\mathfrak{t}})$ we always work with a Heegaard diagram for the knot which is strongly \mathfrak{s} -admissible as a Heegaard diagram for Y equipped with the Spin^c structure \mathfrak{s} which is extended by $\underline{\mathfrak{t}}$, while when we consider its quotient

complexes which are bounded below (such as $CFK^{+,*}$ and \widehat{CFK}), it suffices to consider only weakly \mathfrak{s} -admissible Heegaard diagrams.

Theorem 3.1. *Let (Y, K) be an oriented knot, and fix a Spin^c structure $\underline{\mathfrak{t}} \in \underline{\text{Spin}}^c(Y, K)$. Then the filtered chain homotopy type of the chain complex $CFK^\infty(Y, K, \underline{\mathfrak{t}})$ is a topological invariant of the oriented knot K and the Spin^c structure $\underline{\mathfrak{t}} \in \underline{\text{Spin}}^c(Y, K)$; i.e. it is independent of the choice of admissible, marked Heegaard diagram $(\Sigma, \alpha, \beta_0, \mu, m)$ used in its definition.*

Indeed, we shall see that when the first Chern class of the corresponding Spin^c structure \mathfrak{s} over Y is torsion, then the above chain complex inherits in a natural way an absolute grading from the absolute grading on $CF^\infty(Y, \mathfrak{s})$ (c.f. Lemma 3.6 below). We postpone the proof of the above theorem till the next subsection, first stating some of its immediate consequences.

Corollary 3.2. *The “knot homology groups” $\widehat{HFK}(Y, K, \underline{\mathfrak{t}}) = H_*(\widehat{CFK}(Y, K, \underline{\mathfrak{t}}))$ are topological invariants of the knot $K \subset Y$ and $\underline{\mathfrak{t}} \in \underline{\text{Spin}}^c(Y, K)$.*

Theorem 3.1 \Rightarrow **Corollary 3.2.** It is clear from the above construction that the chain homotopy type of $\widehat{CFK}(Y, K, \underline{\mathfrak{t}})$ is uniquely determined by the filtered chain homotopy type of $CFK^\infty(Y, K, \underline{\mathfrak{t}})$. \square

In view of Proposition 2.1, passage from knot invariants to link invariants is straightforward.

Definition 3.3. *Let $L \subset Y$ be an n -component oriented link in Y , and let $\kappa(L)$ denote the induced knot inside $\kappa(Y) \cong Y \#^{n-1}(S^2 \times S^1)$ as in Proposition 2.1. Then, given $\underline{\mathfrak{t}} \in \text{Spin}^c(\kappa(Y), \kappa(L))$ we define*

$$CFK^\infty(Y, L, \underline{\mathfrak{t}}) = CFK^\infty(\kappa(Y), \kappa(L), \underline{\mathfrak{t}}).$$

Corollary 3.4. *Let (Y, L) be an oriented link, and fix $\underline{\mathfrak{t}} \in \text{Spin}^c(\kappa(Y), \kappa(L))$. Then, $CFK^\infty(Y, L, \underline{\mathfrak{t}})$ is an invariant of the link $L \subset Y$.*

Theorem 3.1 \Rightarrow **Corollary 3.4.** This implication is immediate, in view of Proposition 2.1. \square

As we see from above, the case of links is no more general than the case of knots. Thus, we focus on the case of knots for most of the present paper, returning to the disconnected case in Section 10.

3.2. Proof of topological invariance of the knot homologies. The proof of Theorem 3.1 is very closely modeled on the proof of the topological invariance of HF° proved in [20]. Thus, we highlight here the difference between the two results, leaving the reader to consult [20] for more details.

Verification of the topological invariance rests on the following description of how the invariant depends on the underlying Heegaard diagram:

Proposition 3.5. *If $(\Sigma, \boldsymbol{\alpha}, \boldsymbol{\beta}_0, \mu)$ and $(\Sigma', \boldsymbol{\alpha}', \boldsymbol{\beta}'_0, \mu')$ represent the same knot complement, then we can pass from one to the other by a sequence of the following types of moves (and their inverses):*

- *Handleslides and isotopies amongst the $\boldsymbol{\alpha}$ or the $\boldsymbol{\beta}_0$*
- *Isotopies of μ*
- *Handleslides of μ across some of the $\boldsymbol{\beta}_0$*
- *Stabilizations (introducing canceling pairs α_{g+1} and β_{g+1} and increasing the genus of Σ by one).*

Proof. This follows from standard Morse theory (c.f. Lemma 4.5 of [19]). □

For our proof, we adapt some of the Floer-homology constructions for (singly-) pointed Heegaard diagrams described in [20] to the doubly-pointed case.

Let $(\Sigma, \boldsymbol{\alpha}, \boldsymbol{\beta}, w, z)$, $(\Sigma, \boldsymbol{\beta}, \boldsymbol{\gamma}, w, z)$ be a pair of doubly-pointed Heegaard diagrams. Then, there is an induced (filtered) map:

$$F: CF^\infty(\Sigma, \boldsymbol{\alpha}, \boldsymbol{\beta}, w, z) \otimes CF^\infty(\Sigma, \boldsymbol{\beta}, \boldsymbol{\gamma}, w, z) \longrightarrow CF^\infty(\Sigma, \boldsymbol{\alpha}, \boldsymbol{\gamma}, w, z)$$

defined as follows:

$$F([\mathbf{x}, i, j] \otimes [\mathbf{y}, \ell, m]) = \sum_{\{\psi \in \pi_2(\mathbf{x}, \mathbf{y}, \mathbf{w}) \mid \mu(\psi) = 0\}} (\#\mathcal{M}(\psi)) \cdot [\mathbf{w}, i + \ell - n_w(\psi), j + m - n_z(\psi)],$$

where $\#\mathcal{M}(\psi)$ denotes a signed count of pseudo-holomorphic triangles.

Proof of Theorem 3.1. First we observe that the filtered chain homotopy type CFK^∞ is independent of the perturbation of complex structure J . This is a straightforward modification of the corresponding discussion in [20]. Similarly, independence of the complex under isotopies of the $\boldsymbol{\beta}_0$ is a straightforward modification of the corresponding invariance of HF° : for an isotopy consisting of a single pair creations, one considers the natural chain homotopy equivalence induced by an exact Hamiltonian isotopy realizing the isotopy.

For independence of the groups under handleslides amongst the $\boldsymbol{\beta}_0$, follow the arguments of handleslide invariance of HF^+ as well. Now, we observe that if $\boldsymbol{\beta}'_0$ is obtained from $\boldsymbol{\beta}_0$ by a handleslide, then the doubly-pointed Heegaard diagram $(\Sigma, \mu \cup \boldsymbol{\beta}_0, \mu' \cup \boldsymbol{\beta}'_0, w, z)$ (where μ' is a small exact Hamiltonian translate of μ) has the property that w and z lie in the same connected component of $\Sigma - \mu - \beta_2 - \dots - \beta_g - \mu' - \beta'_2 - \dots - \beta'_g$. We arrange for this Heegaard diagram to be strongly \mathfrak{s}_0 -admissible as a pointed Heegaard diagram for $\#^g(S^2 \times S^1)$ (using either basepoint), where here \mathfrak{s}_0 is the Spin^c structure with trivial first Chern class. We let CF_δ^∞ denote the “diagonal” summand

of $CF^\infty(\Sigma, \mu \cup \beta_0, \mu' \cup \beta'_0)$ generated by $[\mathbf{x}, i, i]$ (where $[\mathbf{x}, i]$ represents \mathfrak{s}_0). It is easy to see then that (c.f. Lemma 9.1 of [20]),

$$HF_\delta^{\leq 0}(\mu \cup \beta_0, \mu' \cup \beta'_0, w, z) \cong \mathbb{Z}[U] \otimes_{\mathbb{Z}} \Lambda^* H_1(T^g).$$

Letting Θ represent the top-dimensional non-zero generator, we use

$$\mathbf{x} \mapsto F(\mathbf{x} \otimes \Theta)$$

to define the map associated to handleslides. The proof that this is a filtered chain homotopy equivalence now follows from a direct application of the methods from Section 9 of [20]. The same remarks apply when one slides μ over one of the circles in β_0 . (Note that if one were to try to slide β_2 over μ , the arguments would break down in view of the fact that now w and z lie in different components of the complements of the curves. This move, however, is not required for proving the topological invariance of the knot homology, according to Proposition 3.5 above.)

The above argument shows that the chain homotopy type of the doubly-filtered chain complex is invariant under handleslides. It is not difficult to see that the map also preserves the splitting according to $\mathfrak{t} \in \underline{\text{Spin}}^c(Y, K)$ (This is shown in a somewhat more general context in Proposition 8.1 below.)

Constructing such an isomorphism for isotopies and handleslides along the α proceeds in an analogous manner: one shows that the filtered chain homotopy type remains invariant under isotopies and handleslides which do not cross the arc δ connecting w and z . Observe also that an isotopy of the α which does cross this arc can be realized by a sequence of isotopies and handleslides amongst the α which do not cross the arc (c.f. Proposition 7.1 of [20]).

Stabilization invariance, too, follows directly as in [20]. □

3.3. Absolute gradings. Fix a Spin^c structure $\mathfrak{s} \in \text{Spin}^c(Y)$, whose first Chern class is torsion. Recall (c.f. [19]) that in this case, we defined an absolute \mathbb{Q} -grading on $CF^\infty(Y, \mathfrak{s})$ which enjoys the following formula: if W is a cobordism from Y_1 to Y_2 , $\mathfrak{r} \in \text{Spin}^c(W)$ is a Spin^c structure whose restrictions \mathfrak{s}_1 and \mathfrak{s}_2 to Y_1 and Y_2 respectively are both torsion, then the induced map $F_{W, \mathfrak{r}}$ shifts degree by

$$(12) \quad \frac{c_1(\mathfrak{r})^2 - 2\chi(W) - 3\sigma(W)}{4},$$

where $\chi(W)$ and $\sigma(W)$ denote the Euler characteristic and signature of W respectively.

The torsion hypothesis also gives us a canonical $\mathfrak{t}_0 \in \underline{\text{Spin}}^c(Y, K)$ extending \mathfrak{s} which satisfies

$$(13) \quad \langle c_1(\mathfrak{t}_0), [\widehat{F}] \rangle = 0$$

for any choice of Seifert surface F for K (indeed, the condition that \mathfrak{t}_0 is independent of the choice of Seifert surface is equivalent to the condition that $c_1(\mathfrak{s})$ is torsion). We

can endow $CFK^\infty(Y, K, \mathfrak{t}_0)$ with the absolute grading induced from the map

$$\Pi_1: CFK^\infty(Y, K, \mathfrak{t}_0) \longrightarrow CF^\infty(Y, \mathfrak{s})$$

given by $\Pi_1[\mathbf{x}, i, j] = [\mathbf{x}, i]$.

Since $\mathfrak{t}_0 \in \underline{\text{Spin}}^c(Y, K)$ is uniquely determined by $\mathfrak{s} \in \text{Spin}^c(Y)$, we typically write $CFK^\infty(Y, K, \mathfrak{s})$ for $CFK^\infty(Y, K, \mathfrak{t}_0)$.

Lemma 3.6. *Let Y be an oriented three-manifold $K \subset Y$ be a knot, and fix a Spin^c structure $\mathfrak{s} \in \text{Spin}^c(Y)$. Then, there is a convergent spectral sequence of relatively graded groups whose E^1 term is*

$$\bigoplus_{\{\mathfrak{t} \in \underline{\text{Spin}}^c(Y, K) \mid \mathfrak{t} \text{ extends } \mathfrak{s}\}} \widehat{HFK}(Y, K, \mathfrak{t}),$$

and whose E^∞ -term is $\widehat{HF}(Y, \mathfrak{s})$. Moreover, when $c_1(\mathfrak{s})$ is torsion, the spectral sequence respects absolute gradings.

Proof. This is simply the Leray spectral sequence associated to the filtration of $\widehat{CF}(Y, \mathfrak{s})$ given by $CFK^{0,*}(Y, \mathfrak{t}_0)$ (where $\mathfrak{t} \in \underline{\text{Spin}}^c(Y, K)$ is any choice of Spin^c structure which extends $\mathfrak{s} \in \text{Spin}^c(Y)$). The statement in the absolutely graded case follows from our definition of the absolute grading on \widehat{HFK} . \square

Of course, we have analogous spectral sequences converging to $HF^+(Y, \mathfrak{s})$, $HF^-(Y, \mathfrak{s})$, and $HF^\infty(Y, \mathfrak{s})$ whose E_1 terms are derived from $CFK^\infty(Y, K)$ in a straightforward way.

3.4. Notational shorthand. We make several further simplifications when considering knots K in S^3 . We write simply $CFK^\infty(S^3, K)$ for the absolutely \mathbb{Z} -graded complex $CFK^\infty(S^3, K, \mathfrak{t}_0)$, where here $\mathfrak{t}_0 \in \underline{\text{Spin}}^c(S^3, K)$ is uniquely characterized by the property that $c_1(\mathfrak{t}_0) = 0$. Moreover, given an integer $n \in \mathbb{Z}$, write $\widehat{HFK}(S^3, K, n)$ for $\widehat{HFK}(S^3, K, \mathfrak{t}_n)$, where $\mathfrak{t}_n \in \underline{\text{Spin}}^c(S^3, K)$ is characterized by the property that $\langle c_1(\mathfrak{t}_n), [\widehat{F}] \rangle = 2n$, where F is a compatible Seifert surface for the oriented knot K .

In this setting, we also write $HF^+(S_0^3(K), n)$ to denote $HF^+(S_0^3(K), \mathfrak{s}_n)$ (where we think of \mathfrak{s}_n as a Spin^c structure over Y_0).

3.5. Symmetries.

Proposition 3.7. *The dependence on the orientation of Y is given by*

$$\widehat{HFK}_*(Y, K, \mathfrak{s}) \cong \widehat{HFK}^*(-Y, K, \mathfrak{s})$$

(where here the left-hand-side denotes homology, and the right-hand-side denotes cohomology). Moreover, if \mathfrak{s} extends a torsion Spin^c structure over Y , then

$$\widehat{HFK}_d(Y, K, \mathfrak{s}) \cong \widehat{HFK}^{-d}(-Y, K, \mathfrak{s}).$$

Proof. This follows from the behaviour of $\widehat{HF}(Y)$ under orientation reversal. Specifically, if $(\Sigma, \boldsymbol{\alpha}, \boldsymbol{\beta}, w, z)$ describes the knot K in Y , then $(-\Sigma, \boldsymbol{\alpha}, \boldsymbol{\beta}, w, z)$ describes the knot K in $-Y$. The identification of the complexes now follows as in [18]. \square

Proposition 3.8. *Fix a torsion Spin^c structure \mathfrak{s} over Y . For each extension $\underline{\mathfrak{s}} \in \underline{\text{Spin}}^c(Y, K)$ of \mathfrak{s} , we have that*

$$\widehat{HFK}_d(Y, K, \underline{\mathfrak{s}}) \cong \widehat{HFK}_{d-2m}(Y, -K, \underline{\mathfrak{s}}),$$

where

$$m = \frac{1}{2} \langle c_1(\underline{\mathfrak{s}}), [\widehat{F}] \rangle$$

is calculated using the surface \widehat{F} obtained by capping off a Seifert surface F for the oriented knot K .

Proof. Observe that for the chain complex underlying $CFK^\infty(Y, K, \mathfrak{t}_0)$, the roles of i and j can be interchanged; i.e. the same complex can be viewed at the same time as $CFK^\infty(Y, -K, \mathfrak{t}_0)$. (Recall that \mathfrak{t}_0 is chosen to satisfy Equation (13).) Correspondingly, we have a projection map

$$\Pi_2: CFK^\infty(Y, K, \mathfrak{t}_0) \cong CFK^\infty(Y, -K, \mathfrak{t}_0) \longrightarrow CF^\infty(Y, \mathfrak{s})$$

given by $\Pi_2[\mathbf{x}, i, j] = [\mathbf{x}, j]$. (By all rights, the complex $CF^\infty(Y, \mathfrak{s})$ ought to include the base point in its notation: in this case we use z rather than w). This projection, too induces an absolute grading on $CFK^\infty(Y, K, \mathfrak{t}_0)$, but in fact it coincides with the absolute grading induced from Π_1 , since there is there is a grading-preserving homotopy equivalence from $CF^\infty(Y, \mathfrak{s})$, as defined using the base point w , to the corresponding complex as defined using z .

Now, the stated isomorphism is induced by the map

$$U^m: \widehat{CFK}(Y, K, \underline{\mathfrak{s}}) \cong CFK^{0,m}(Y, K, \mathfrak{t}_0) \longrightarrow CFK^{-m,0}(Y, K, \mathfrak{t}_0) \cong \widehat{CFK}(Y, -K, \underline{\mathfrak{s}}).$$

\square

There is a conjugation symmetry

$$J: \underline{\text{Spin}}^c(Y, K) \longrightarrow \underline{\text{Spin}}^c(Y, K)$$

induced from the usual conjugation symmetry on $\text{Spin}^c(Y_0(K))$.

Proposition 3.9. *For each $\underline{\mathfrak{s}} \in \underline{\text{Spin}}^c(Y, K)$, there is an identification*

$$CFK^\infty(Y, K, \underline{\mathfrak{s}}) \cong CFK^\infty(Y, -K, J\underline{\mathfrak{s}}).$$

Proof. First notice that in our definition the Heegaard diagram for a knot, there is an asymmetry in the role of the α and the β ; specifically, our choice of meridian was chosen to be among the β . This was, of course, unnecessary. We could just as well have chosen our meridian to be an α -circle, repeated the above definition, and obtained another knot filtration which is also a knot invariant. In fact, these two filtrations coincide, provided that we switch the roles of w and z . Indeed, we can always choose a Heegaard diagram for the knot K for which there are representatives for K in both handlebodies, with both α_1 and β_1 representing meridians for the two representatives, reversing the roles of w and z . Such a diagram can be obtained by stabilizing a doubly-pointed Heegaard diagram for which the attaching circle β_1 is a meridian for K . Specifically, we stabilize our original Heegaard surface by attaching a handle with feet near w and z respectively, the circle α_1 is supported inside the newly attached handle, and we introduce a canceling circle β_2 which runs along a longitude for K except near β_1 , which it avoids by running through the one-handle. This is illustrated in Figure 4.

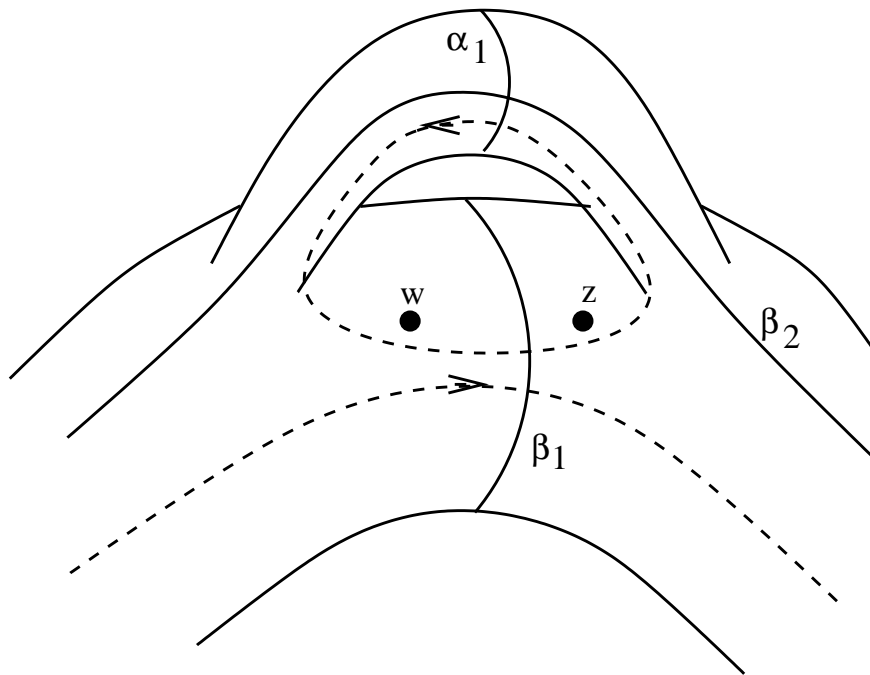

FIGURE 4. **Moving the meridian.** This illustrates the symmetry between the roles of α_1 and β_1 as meridians for a given knot K . This knot K is isotopic to either of the two (unlabeled) dotted circles in Σ , and hence can be pushed into either handlebody so that either α_1 or β_1 is a meridian. Note that there may be additional α and β -circles entering the picture, but it is important that they do not cross the dotted circles, and do not separate w and z from these dotted circles.

With these remarks in place, we realize the conjugation symmetry by the natural identification of the complexes $(\Sigma, \boldsymbol{\alpha}, \boldsymbol{\beta}, w, z)$ and $(-\Sigma, \boldsymbol{\beta}, \boldsymbol{\alpha}, z, w)$, following [20]. It is easy to see that this identification induces an isomorphism of $CFK^\infty(Y, K, \underline{\mathfrak{s}})$ with $CFK^\infty(Y, K, J\underline{\mathfrak{s}})$. \square

Fix a torsion Spin^c structure \mathfrak{s} over Y , and let $CFK^\infty(Y, K, \mathfrak{s})'$ denote the $\mathbb{Z} \oplus \mathbb{Z}$ -filtered chain complex $CFK^\infty(Y, K, \mathfrak{s})$, endowed with the filtration

$$\mathcal{F}[\mathbf{x}, i, j] = (j, i).$$

The above proposition gives a degree-preserving $\mathbb{Z} \oplus \mathbb{Z}$ -filtered chain homotopy equivalence

$$\Phi: CFK^\infty(Y, K, \mathfrak{s}) \longrightarrow CFK^\infty(Y, K, \mathfrak{s})'.$$

This gives the following corollary, which we state for the knot Floer homology:

Proposition 3.10. *Let Y be a three-manifold equipped with a torsion Spin^c structure, then*

$$\widehat{HFK}_d(Y, K, \underline{\mathfrak{s}}) \cong \widehat{HFK}_{d-2m}(Y, K, J\underline{\mathfrak{s}}),$$

where $2m = \langle c_1(\underline{\mathfrak{s}}), [\widehat{F}] \rangle$.

Proof. Combine the results of Propositions 3.8 and 3.9. \square

4. RELATIONSHIP WITH THREE-MANIFOLD INVARIANTS

We consider the following two $\mathbb{Z} \oplus \mathbb{Z}$ -filtered, $\mathbb{Z}[U]$ -subcomplexes of $CFK^\infty(Y, K)$:

- $CFK^-(Y, K)$, which denotes the subcomplex of $CFK(Y, K)$ generated by $[\mathbf{x}, i, j]$ with $\max(i, j) < 0$,
- ${}^bCFK^-(Y, K)$ (“big” CFK^-), which denotes the subcomplex generated by $[\mathbf{x}, i, j]$ with $\min(i, j) < 0$.

These have quotient complexes denoted

$$\begin{aligned} {}^bCFK^+(Y, K) &= CFK^\infty(Y, K)/CFK^-(Y, K) \\ CFK^+(Y, K) &= CFK^\infty(Y, K)/{}^bCFK^-(Y, K). \end{aligned}$$

Our aim is to identify the homologies of $CFK^+(Y, K)$ (resp. ${}^bCFK^+(Y, K)$) with $HF^+(Y_{-p}(K))$ (resp. $HF^+(Y_p(K))$) for sufficiently large integer surgery coefficients p , to be made precise shortly.

Fix a Seifert surface F for $K \subset Y$, compatible with the orientation of K . We can cap this off to obtain a surface $\widehat{F} \subset Y_0(K)$. For each $m \in \mathbb{Z}$, let

$$CFK^\infty(Y, K, F, m) = \bigoplus_{\{\mathfrak{t} \in \underline{\text{Spin}}^c(Y, K) \mid \langle c_1(\mathfrak{t}), [\widehat{F}] \rangle = 2m\}} CFK^\infty(Y, K, \mathfrak{t}),$$

Similarly, for each integer p , we let S denote the surface in $W_{-p}(K)$ obtained by closing off F , to obtain a surface of square $-p$. Now, given $[m] \in \mathbb{Z}/p\mathbb{Z}$, let $\mathfrak{T}(F, p, [m]) \subset \text{Spin}^c(Y_p(K))$ denote the set of Spin^c structures which can be extended over $\text{Spin}^c(W_{-p}(K))$ to give a Spin^c structure \mathfrak{t} with

$$\langle c_1(\mathfrak{t}), [S] \rangle + p \equiv 2m \pmod{2p}.$$

Correspondingly, we let

$$CF^\infty(Y_p(K), F, [m]) = \bigoplus_{\mathfrak{t} \in \mathfrak{T}(F, p, m)} CF^\infty(Y_p(K), F, \mathfrak{t}).$$

When F is understood from the context, then we drop it from the notation.

To relate these two complexes, we will use the following map. Fix a positive integer p , and let $(\Sigma, \boldsymbol{\alpha}, \boldsymbol{\beta}, \boldsymbol{\gamma}, m)$ be a marked Heegaard triple for the cobordism from Y to Y_{-p} . Consider the chain map

$$\Phi: CFK^\infty(Y, K) \longrightarrow CF^\infty(Y_{-p})$$

defined by

$$\Phi[\mathbf{x}, i, j] = \sum_{\mathbf{y} \in \mathbb{T}_\alpha \cap \mathbb{T}_\gamma} \sum_{\{\psi \in \pi_2(\mathbf{x}, \Theta, \mathbf{y}) \mid n_w(\psi) - n_z(\psi) = i - j, \mu(\psi) = 0\}} (\#\mathcal{M}(\psi)) \cdot [\mathbf{y}, i - n_w(\psi)].$$

Theorem 4.1. *Let (Y, K) be an oriented knot, and fix a compatible Seifert surface F for K . Then, for each integer $m \in \mathbb{Z}$, we have an integer $N = N(m)$ so that for all integers $p \geq N$, there is a Heegaard diagram for which the map Φ above induces isomorphisms of chain complexes which fit into the following commutative diagram:*

$$\begin{array}{ccccccc} 0 & \longrightarrow & {}^bCFK^-(Y, K, m) & \longrightarrow & CFK^\infty(Y, K, m) & \longrightarrow & CFK^+(Y, K, m) & \longrightarrow & 0 \\ & & \downarrow {}^b\Phi^- & & \downarrow \Phi^\infty & & \downarrow \Phi^+ & & \\ 0 & \longrightarrow & CF^-(Y_{-p}(K), [m]) & \longrightarrow & CF^\infty(Y_{-p}(K), [m]) & \longrightarrow & CF^+(Y_{-p}(K), [m]) & \longrightarrow & 0. \end{array}$$

Similarly, if we let $CFK^0(Y, K, m) \subset CFK^+(Y, K, m)$ be the subset generated by $[\mathbf{x}, i, j]$ with $\min(i, j) = 0$, then Φ also induces isomorphisms in the following diagram:

$$\begin{array}{ccccccc} 0 & \longrightarrow & CFK^0(Y, K, m) & \longrightarrow & CFK^+(Y, K, m) & \xrightarrow{U} & CFK^+(Y, K, m) & \longrightarrow & 0 \\ & & \downarrow \widehat{\Phi} & & \downarrow \Phi^+ & & \downarrow \Phi^+ & & \\ 0 & \longrightarrow & \widehat{CF}(Y_{-p}, [m]) & \longrightarrow & CF^+(Y_{-p}, [m]) & \xrightarrow{U} & CF^+(Y_{-p}, [m]) & \longrightarrow & 0. \end{array}$$

Proof. First, note that Φ maps ${}^bCFK^-(Y, K)$ into $CF^-(Y_{-p})$: if ψ has a holomorphic representative, then $n_w(\psi) \geq 0$ and $n_z(\psi) \geq 0$, so if $[\mathbf{x}, i, j] \in {}^bCFK^-(Y, K)$, then either $i < 0$, so clearly, $i - n_w(\psi) < 0$; or $i \geq 0$ and $j < 0$, so

$$i - n_w(\psi) = j - n_z(\psi) < 0.$$

Fix a marked Heegaard diagram $(\Sigma, \boldsymbol{\alpha}, \boldsymbol{\beta}, m)$ for (Y, K) , where $m \in \beta_1$, so that β_1 is the meridian. Fix an annular neighborhood of β_1 and a longitude λ for K . We will consider Heegaard triples $(\Sigma, \boldsymbol{\alpha}, \boldsymbol{\beta}, \boldsymbol{\gamma}, w)$ so that the γ_i for $i \geq 2$ are all exact Hamiltonian translates of the corresponding β_i , and γ_1 is a small (embedded) perturbation of the juxtaposition $p\beta_1 + \lambda$. We will situate γ_1 so that β_1 intersects it in one point towards the middle of this winding region (c.f. Figure 5).

We say that an intersection $\mathbf{x}' \in \mathbb{T}_\alpha \cap \mathbb{T}_\beta$ is supported in the winding region if the coordinate on \mathbf{x}' in γ_1 is supported there. In this case, there is a uniquely determined intersection point $\mathbf{x} \in \mathbb{T}_\alpha \cap \mathbb{T}_\beta$ which is closest to \mathbf{x}' . Moreover, there is a canonical ‘‘small triangle’’ $\psi_0 \in \pi_2(\mathbf{x}, \Theta, \mathbf{x}')$ supported in the winding region. Conversely, given any $\mathbf{x} \in \mathbb{T}_\alpha \cap \mathbb{T}_\beta$, there are p distinct intersection points for $\mathbb{T}_\alpha \cap \mathbb{T}_\gamma$, representing the p Spin^c structures over $Y_{-p}(K)$ which are cobordant to the Spin^c structure represented by \mathbf{x} .

We claim that

$$(14) \quad \langle c_1(\underline{\mathfrak{s}}(\mathbf{x})), [\widehat{F}] \rangle + 2(n_w(\psi) - n_z(\psi)) = \langle c_1(\underline{\mathfrak{s}}_w(\psi)), [S] \rangle - p.$$

Fix a Spin^c structure $\mathfrak{s} \in \text{Spin}^c(Y)$, and let \mathbf{x}_1 be some representative for \mathfrak{s} . For $\psi = \psi_0(\mathbf{x}_1, \Theta, \mathbf{x}'_1) \in \pi_2(\mathbf{x}, \Theta, \mathbf{x}')$ with $n_w(\psi) = n_z(\psi) = 0$, this is a straightforward application of the first Chern class formula from [19]. Now, any ψ which induces the

same Spin^c structure has the form $\psi = \phi * \psi_0 * \phi'$ with $\phi \in \pi_2(\mathbf{x}_2, \mathbf{x}_1)$ (for $\mathbb{T}_\alpha \cap \mathbb{T}_\beta$, $\phi' \in \pi_2(\mathbf{x}'_1, \mathbf{x}'_2)$). It follows from Lemma 2.5 Equation (14) is unaffected by the juxtaposition of ϕ , while it is clear that it is unaffected by the juxtaposition of ϕ' . Finally, it is straightforward to see that the equation is preserved by adding a triply-periodic domain belonging to S . This completes the verification of Equation (14) for all Whitney triangles ψ .

It follows from Equation (14), that the restriction of Φ to $CFK^\infty(Y, K, m)$ maps to $CF^+(Y_{-p}(K), [m])$.

Fix an integer $m \in \mathbb{Z}$. We claim that if p is sufficiently large, then that all the intersection points between \mathbb{T}_α and \mathbb{T}_γ which represent any Spin^c structure $\mathfrak{s} \in \mathfrak{T}(F, p, [m])$ are supported in the winding region. This can be seen, for example, from Equation (14). In this case, consider the map

$$\Phi_0: CFK^\infty(Y, K, m) \longrightarrow CF^\infty(Y_{-p}(K), [m])$$

which carries $[\mathbf{x}, i, j]$ to $[\mathbf{x}', i - n_w(\psi_0)]$. By the Riemann mapping theorem, we have that $\#\mathcal{M}(\psi_0) = 1$, so we can think of Φ_0 as the summand of Φ corresponding to the homotopy class ψ_0 . Moreover, it is easy to see that Φ_0 induces isomorphisms of groups

$$\begin{aligned} CFK^\infty(Y, K, m) &\cong CF^\infty(Y_{-p}(K), [m]) \\ {}^bCFK^-(Y, K, m) &\cong CF^-(Y_{-p}(K), [m]) \\ CFK^+(Y, K, m) &\cong CF^+(Y_{-p}(K), [m]) \\ CFK^0(Y, K, m) &\cong \widehat{CF}(Y_{-p}(K), [m]). \end{aligned}$$

Now, if the winding region has sufficiently small area relative to the areas of the regions in $\Sigma - \boldsymbol{\alpha} - \boldsymbol{\beta}$ (divided by n), then it is clear that

$$\Phi = \Phi_0 + \text{lower order},$$

with respect to the energy filtrations on $CFK(Y, K, s)$ and $CF(Y_n(K), [s])$ (induced by areas of domains). Thus, by elementary algebra, the map Φ , which we know is a chain map, is also an isomorphism (carrying ${}^bCFK^-(Y, K, s)$ to $CF^-(Y, [s])$). \square

For convenience, we state a version of the above result in the case where we restrict to Spin^c structures over Y whose first Chern class is torsion. In this case, recall that we defined $CFK^\infty(Y, K, \mathfrak{s})$ to be $CFK^\infty(Y, K, \mathfrak{t}_0)$, where $\mathfrak{t}_0 \in \underline{\text{Spin}}^c(Y, K)$ restricts \mathfrak{s} and also satisfies $\langle c_1(\mathfrak{t}_0), [\widehat{F}] \rangle = 0$, a notion which now is independent of the choice of Seifert surface for K . We let

$$CFK^\infty(Y, K, \mathfrak{s})\{i \geq 0 \text{ or } j \geq -m\} \subset CFK^\infty(Y, K, \mathfrak{s})$$

denote the induced (quotient) complex generated by $[\mathbf{x}, i, j] \in CFK^\infty(Y, K, \mathfrak{s})$, subject to the stated constraint $i \geq 0$ or $j \geq -m$. Moreover, let $[\mathfrak{s}, m] \in \text{Spin}^c(Y_{-p})$ denote the

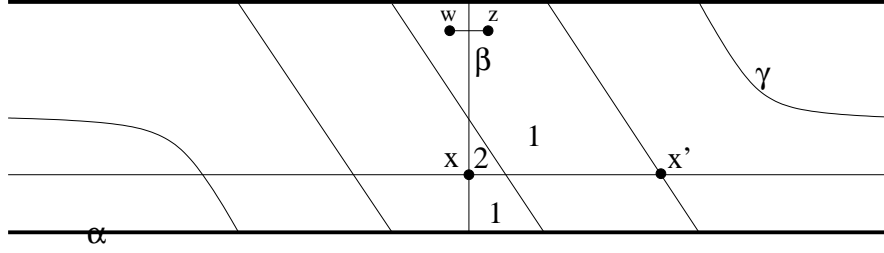

FIGURE 5. **Illustration of Theorem 4.1.** The integers denote (non-zero) local multiplicities of the “small triangle” Φ_0 connecting x and x' . This picture is taking place in a cylindrical region in Σ : the top dark line is identified with the bottom.

Spin^c structure over Y_{-p} which is cobordant to \mathfrak{s} , via a Spin^c structure $\mathfrak{r} \in \text{Spin}^c(W_{-p})$ with

$$\langle c_1(\mathfrak{r}), [S] \rangle = 2m + p.$$

Corollary 4.2. *Let $K \subset Y$ be a knot, and fix $\mathfrak{s} \in \text{Spin}^c(Y)$ with whose first Chern class is torsion. Then, there is an integer N with the property that for all $p \geq N$, we have that*

$$HF_\ell^+(Y_{-p}(K), [\mathfrak{s}, m]) \cong \begin{cases} H_k(CFK^\infty(Y, K, \mathfrak{s})\{i \geq 0 \text{ and } j \geq -m\}) & \text{if } |m| \leq g \\ HF_k^+(Y) & \text{otherwise,} \end{cases}$$

where

$$\ell = k + \left(\frac{p - (2m + p)^2}{4p} \right).$$

Proof. If $|m| > g$, this follows readily from the adjunction inequality for $HF^+(Y_0)$, together with long exact sequence for integral surgeries (c.f. [18]) (provided that $p > g$).

The cases where $|m| < g$, this follows from the above theorem. Specifically, observe that if $\mathfrak{t} \in \underline{\text{Spin}}^c(Y, K)$ extends \mathfrak{s} , then we have an isomorphism of chain complexes

$$CFK^\infty(Y, K, \mathfrak{t}) \cong CFK^\infty(Y, K, \mathfrak{t}_0)$$

defined by

$$[\mathbf{x}, i, j] \mapsto [\mathbf{x}, i, j + \frac{1}{2} \langle c_1(\mathfrak{t}), [\widehat{F}] \rangle].$$

This preserves the absolute \mathbb{Z} grading as defined in Subsection 3.3, shifting the filtration in the obvious way. Thus, the isomorphism in its relatively graded form is a direct consequence of Theorem 4.1. For the graded statement, we recall that the map Φ inducing the isomorphism is a filtered version of the map from $CF^\infty(Y)$ to $CF^\infty(Y_{-p})$ induced by counting holomorphic triangles (c.f. [19]), associated to the Spin^c structure over $W_{-p}(K)$ with

$$\langle c_1(\mathfrak{r}), [S] \rangle = 2m + p,$$

according to Equation (14). Thus, the shift in dimension follows from Equation (12). \square

Remark 4.3. *It follows from the adjunction inequality for $HF^+(Y_0)$, together with properties of the integer surgeries long exact sequence, that we can take $N = 2g - 1$, where g denotes the genus of the knot.*

In the same vein, for each $m \in \mathbb{Z}$, we define a map

$$\Psi: CF^\infty(Y_p, [m]) \longrightarrow CFK^\infty(Y, K, m)$$

by

$$\Psi[\mathbf{x}, i] = \sum_{\mathbf{y} \in \mathbb{T}_\alpha \cap \mathbb{T}_\gamma} \sum_{\{\psi \in \pi_2(\mathbf{x}, \Theta, \mathbf{y}) \mid \mu(\psi) = 0, n_w(\psi) - n_z(\psi) = m\}} \#\mathcal{M}(\psi)[\mathbf{y}, i - n_w(\psi), i - n_z(\psi)].$$

Note that the analogue of Equation (14) in this case guarantees that the right-hand-side is contained in $CFK^\infty(Y, K, m) \subset CFK^\infty(Y, K)$. We now have the following analogue of Theorem 4.1:

Theorem 4.4. *Let (Y, K) be an oriented knot, and fix a compatible Seifert surface F . For each integer m , we have an integer N so that for all integers $p \geq N(m)$, there is a Heegaard diagram for which the map Ψ above induces isomorphisms of chain complexes which fit into the following commutative diagram:*

$$\begin{array}{ccccccc} 0 & \longrightarrow & CF^-(Y_p(K), [m]) & \longrightarrow & CF^\infty(Y_p(K), [m]) & \longrightarrow & CF^+(Y_p(K), [m]) \longrightarrow 0, \\ & & \Psi^- \downarrow & & \Psi^\infty \downarrow & & \downarrow {}^b\Psi^+ \\ 0 & \longrightarrow & CFK^-(Y, K, m) & \longrightarrow & CFK^\infty(Y, K, m) & \longrightarrow & {}^bCFK^+(Y, K, m) \longrightarrow 0. \end{array}$$

Similarly, if we let ${}^bCFK^0(Y, K) \subset {}^bCFK^+(Y, K)$ be the subset generated by $[\mathbf{x}, i, j]$ with $\max(i, j) = 0$, then Ψ also induces isomorphisms in:

$$\begin{array}{ccccccc} 0 & \longrightarrow & \widehat{CF}(Y_p, [m]) & \longrightarrow & CF^+(Y_p, [m]) & \xrightarrow{U} & CF^+(Y_p, [m]) \longrightarrow 0 \\ & & {}^b\widehat{\Psi} \downarrow & & {}^b\Psi^+ \downarrow & & \downarrow {}^b\Psi^+ \\ 0 & \longrightarrow & {}^bCFK^0(Y, K, m) & \longrightarrow & {}^bCFK^+(Y, K, m) & \xrightarrow{U} & {}^bCFK^+(Y, K, m) \longrightarrow 0. \end{array}$$

Proof. This is a straightforward modification of the proof of Theorem 4.1. \square

It is worth pointing out the following result:

Corollary 4.5. *Suppose that K is a knot in S^3 , and let d be the largest integer for which $\widehat{HF}K(Y, K, d) \neq 0$, and suppose that $d > 1$. Then,*

$$HF^+(S_0^3(K), \mathfrak{s}) \cong \widehat{HF}K(S^3, K, d)$$

as $\mathbb{Z}/2\mathbb{Z}$ graded \mathbb{Z} -modules, where here $\mathfrak{s} \in \text{Spin}^c(S_0^3(K))$ is the Spin^c structure with $\langle c_1(\mathfrak{s}), [\widehat{F}] \rangle = 2d - 2$.

Proof. On the one hand, we have the short exact sequence

$$0 \longrightarrow C\{i < 0 \text{ and } j \geq d - 1\} \longrightarrow C\{i \geq 0 \text{ or } j \geq d - 1\} \xrightarrow{\Psi} C\{i \geq 0\} \longrightarrow 0.$$

Now, it is easy to see by taking filtrations that

$$H_*(C\{i < 0 \text{ and } j \geq d - 1\}) \cong \widehat{HFK}(S^3, K, d).$$

Of course, according to Theorem 4.4, for sufficiently large integers n ,

$$H_*(C\{i \geq 0 \text{ or } j \geq d\}) \cong HF^+(S_n^3(K), [d - 1]),$$

and indeed the map Ψ is modeled on the map induced by the cobordism from $S_n^3(K)$ to S^3 , endowed with the Spin^c structure \mathfrak{r} with

$$\langle c_1(\mathfrak{r}), [\widehat{F}] \rangle = 2d - 2 + n.$$

Note that the map ψ induced by Ψ on homology is surjective, since it is a $\mathbb{Z}[U]$ module map and

$$H_*(C\{i \geq 0\}) \cong HF^+(S^3),$$

and ψ induces an isomorphism in all sufficiently large degrees.

We compare this with the integral surgeries long exact sequence, according to which we have

$$\dots \longrightarrow HF^+(S_0^3(K), \mathfrak{s}) \longrightarrow HF^+(S_p^3(K), [d - 1]) \xrightarrow{F} HF^+(S^3) \longrightarrow \dots$$

Now, if we endow $HF^+(S_p^3(K), [d - 1])$ and $HF^+(S^3)$ with the filtrations given by the absolute grading, then F has the form $\Psi + L$, where L is a sum of homogeneous maps which map to lower order than Ψ (by at least $2d - 2$, c.f. Equation (12)). It then follows that the induced map on homology $\psi + \ell$ is surjective, and also that this kernel is identified with the kernel of ψ . \square

5. ADJUNCTION INEQUALITIES

In this section, we prove the following adjunction inequality for \widehat{HFK} .

Theorem 5.1. *Let $K \subset Y$ be an oriented knot, and suppose that $\widehat{HFK}(Y, K, \underline{s}) \neq 0$. Then, for each Seifert surface F for K of genus $g > 0$, we have that*

$$\left| \langle c_1(\underline{s}), [\widehat{F}] \rangle \right| \leq 2g(F).$$

Proof. Following Section 7 of [18] (see especially Lemma 7.3), we can construct a special Heegaard diagram $(\Sigma, \alpha, \beta_0 \cup \mu, w, z)$ for the knot K with the following properties. In the corresponding diagram for $Y_0(K)$ (where the meridian μ is exchanged for the longitude λ , but we have not yet wound the longitude along μ , as pictured in Figure 3), there is a periodic domain \mathcal{P} which bounds $\lambda \cup \alpha_1$, all its multiplicities are one and zero and its Euler characteristic is $-2g$. Moreover, the meridian μ meets the support of \mathcal{P} in an arc which meets none of the other attaching circles.

Let \mathbf{x} , now, be any intersection point generating $\widehat{CFK}(Y, K)$, and let \mathbf{x}' be the nearby intersection for the Y_0 Heegaard diagram, obtained now after winding. Observe that for this Heegaard diagram, there is a variant of \mathcal{P} , denoted \mathcal{P}' , where there are multiplicities -1 , as well, now along some neighborhood of the meridian μ . Indeed, if $x_1 \in \mathbf{x}$ denotes the intersection point on μ , then x'_1 is supported in this region. However, none of the other $x_i \in \mathbf{x}'$ are supported in the winding region. Note that there must be another $x_2 \in \mathbf{x}'$ which is supported on α_1 (i.e. it lies on the boundary of \mathcal{P}' , where the multiplicity on one side is $+1$). See Figure 6 for an illustration.

Now, according to Equation (9), we see that

$$\langle c_1(\mathbf{s}'(\mathbf{x}')), [\widehat{F}] \rangle = -2g + \#(x_i \text{ in the interior of } \mathcal{P}) \geq -2g.$$

The result now follows by conjugation invariance (Proposition 3.10). \square

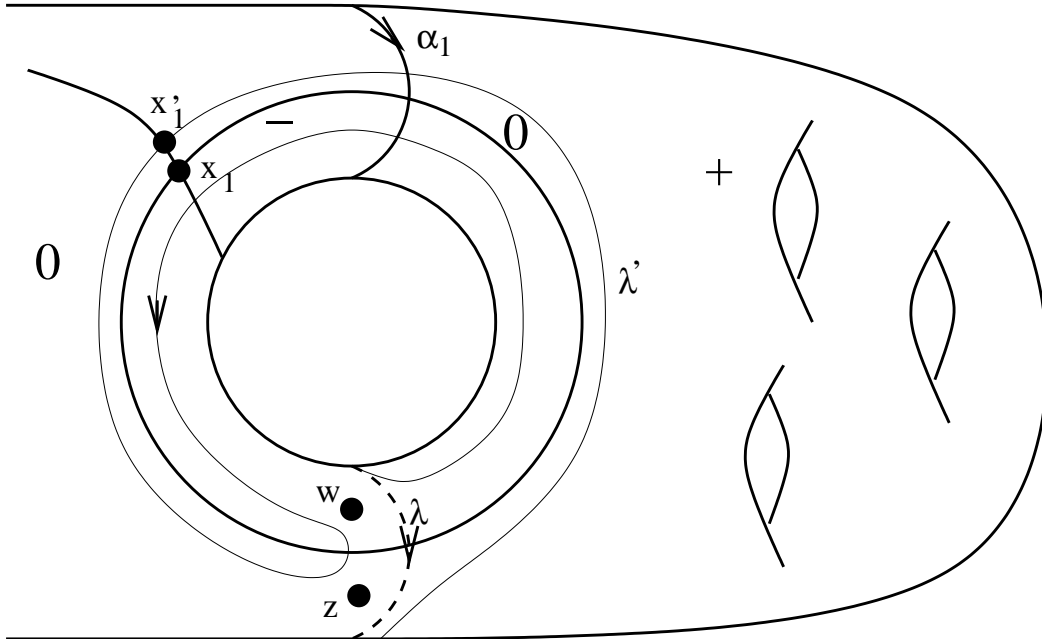

FIGURE 6. **Adjunction inequality.** An illustration for the proof of Theorem 5.1. Here, the dashed circle is the original longitude, while λ' is the one obtained after winding. We have indicated some of the local multiplicities of the periodic domain P' obtained after winding, by writing $+$ for the regions where its local multiplicity is $+1$, $-$ where it is -1 , and 0 where it vanishes. (These can be obtained by realizing that the boundary of P is $\alpha_1 \cup \lambda'$, with the orientations indicated by the arrows.)

6. EXAMPLES

Before turning to some general calculational devices for CFK^∞ , we give here a few Heegaard genus two examples where $CFK^\infty(Y, K)$ can be explicitly determined through more direct means.

The key trick which facilitates these calculations is the following:

Proposition 6.1. *Let $(\Sigma, \alpha, \beta, w, z)$ be a doubly-pointed Heegaard diagram of genus g . Suppose that the curves α_1 and β_1 intersect in a single point, and suppose that β_1 meets none of the other α_i for $i > 1$. Consider the doubly-pointed Heegaard diagram $(\Sigma', \alpha', \beta', w', z')$ of genus $g-1$, where Σ' is obtained from Σ by surgering out β_1 , and α' , β' , w' , and z' are obtained by viewing $\{\alpha_2, \dots, \alpha_g\}$, $\{\beta_2, \dots, \beta_g\}$, w , and z as supported in Σ' . Then,*

$$CF^\infty(\Sigma, \alpha, \beta, w, z) \cong CF^\infty(\Sigma', \alpha', \beta', w', z').$$

Proof. In the case where α_1 meets none of the curves in $\{\beta_2, \dots, \beta_g\}$, this is a statement of the stabilization invariance of the doubly-pointed complex. It is easy to reduce to this case by performing a series of handleslides of the β_i (for $i > 1$) which meet α_1 , over β_1 (along a subarc in α_1 which connects β_i with β_1). Note that these handleslides do not cross either basepoint. \square

6.1. The trefoil. Start with a genus two Heegaard diagram for the left-handed trefoil. This can be destabilized once (Proposition 6.1) to obtain the following picture shown in Figure 7, which takes place inside a torus. Note that we have destabilized out the meridian of the knot.

Proposition 6.2. *The filtered chain complex $CFK^\infty(Y, K)$ is freely generated as a \mathbb{Z} -module by generators $[x_1, i, i+1]$, $[x_{-1}, i+1, i]$, and $[x_0, i, i]$, where i is an arbitrary*

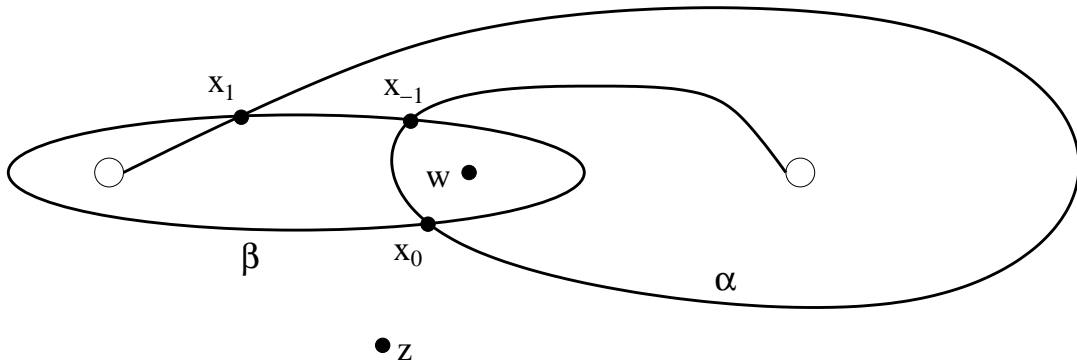

FIGURE 7. **Destabilized doubly-pointed Heegaard diagram for the trefoil.** This picture is meant to take place in a torus, where the two hollow circles are identified.

integer. The differential given by:

$$\begin{aligned}\partial[x_0, i, i] &= 0 \\ \partial[x_1, i, i+1] &= [x_0, i, i] \\ \partial[x_{-1}, i+1, i] &= [x_0, i, i].\end{aligned}$$

Moreover, the absolute grading of the generator $[\mathbf{x}_0, 0, 0]$ is 1.

Proof. That the chain complex has the stated form follows readily from the fact there are two orientation-preserving embedded Whitney disks in the torus: ϕ_{-1} , which connects x_{-1} to x_0 , and ϕ_1 , which connects x_1 to x_0 . So, by the Riemann mapping theorem, both admit unique holomorphic representatives (up to translation). Moreover, ϕ_{-1} contains the basepoint w (and not z), while ϕ_1 contains z (and not w).

Strictly speaking, this information suffices to identify the chain complex CF^∞ for the doubly-pointed Heegaard diagram (generated by $[x, i, j]$ for intersection points $x \in \{x_{-1}, x_0, x_1\}$, and $i, j \in \mathbb{Z}$), which splits as a direct sum of chain complexes isomorphic to $CFK^\infty(S^3, K)$. It is immediate from the symmetry property of \widehat{HFK} (c.f. Proposition 3.7) that the summand $CFK^\infty(S^3, K)$ is generated by $[x_0, i, i]$, $[x_1, i, i+1]$ and $[x_{-1}, i+1, i]$.

To calculate the absolute grading, we use Lemma 3.6, and the observation that the complex generated by $[x_1, 0, 1]$, $[x_0, 0, 0]$, and $[x_{-1}, 0, -1]$ (thought of as a quotient of a subcomplex of $CFK^\infty(Y, K)$) calculates $\widehat{HF}(S^3)$. In this complex, the generator $[x_{-1}, 0, -1]$ is the only one which persists in homology, so it must have degree zero. \square

As an easy application of the results from Section 4, one could give yet another calculation of HF^+ for three-manifolds which are surgeries along the trefoil. Moreover, the technique employed above can be readily generalized to give a combinatorial description of CFK for an arbitrary two-bridge knot. However, since HF^+ of three-manifolds obtained as integral surgeries along such knots has already been calculated by Rasmussen in [25], we do not pursue this any further here, turning instead to a related calculation.

6.2. Examples from two-bridge links. There is a class of knots admitting genus two Heegaard diagrams, but which are not two-bridge knots in the usual sense. Our aim here is to show how to reduce the calculation of the complex CFK for this class of knots to a purely combinatorial problem (c.f. Propositions 6.3 and 6.4 below).

Recall that a two-bridge link in S^3 is a link which is contained in a Euclidean neighborhood B on which there is function $f: B \rightarrow \mathbb{R}$ whose restriction to the link has exactly two local maxima. We consider links of this type which have two components. Such links can be described by certain (four-stranded) braids σ . Specifically, think of a braid as a mapping class σ of the plane with four marked points $\{a_1, b_1, a_2, b_2\}$ which permutes the points. Let I_1 and I_2 be a pair of disjoint arcs which connect a_1 to b_1 and a_2 to b_2 respectively. We construct (the projection of) a link by joining I_1 and I_2 to

$\sigma(I_1)$ and $\sigma(I_2)$ respectively along their boundaries, so that I_1 and I_2 pass “over” their images under σ . When the braid σ fixes the subsets $\{a_1, b_1\}$ and $\{a_2, b_2\}$, the link has two components. In fact, by introducing twists which leave the isotopy class of the link unchanged, we can assume the braid fixes the four points (and indeed that it fixes a small tubular neighborhood of these points).

Let $K_1 \cup K_2$ be a two-component two-bridge link. It is easy to see that the two components of the link are each individually unknotted. Thus, if we perform ± 1 surgery on K_1 (or, more generally, $1/n$ where n is an arbitrary integer), then the ambient three-manifold is still diffeomorphic to S^3 , and we let K denote the image of K_2 under this diffeomorphism. Thus, K is obtained from K_2 by introducing a “Rolfsen twist” along the linking circle K_1 (see for example [9] for a detailed description of this operation; see Figure 9 for a picture of the result of performing the operation on the link shown in Figure 8).

Let σ denote the braid associated to a two-component link $K_1 \cup K_2$. We construct a doubly-pointed genus one Heegaard diagram for K from σ as follows. Delete a pair of disks A_1 and B_1 centered at a_1 and b_1 . The Heegaard surface is formed by attaching a cylinder C_1 to $S^2 - A_1 - B_1$ along its two boundary circles. We let a_2 and b_2 serve as our two basepoints w and z respectively. We consider the curve β obtained from closing up the arc $I_1 \cap (S^2 - A_1 - B_1)$ by an arc inside the attached cylinder C_1 . Similarly, we consider the curve α obtained by closing up $\sigma(I_1)$ by an arc inside C_1 . Note that there is some freedom in how we close off α and β (inside C_1). In particular, by introducing Dehn

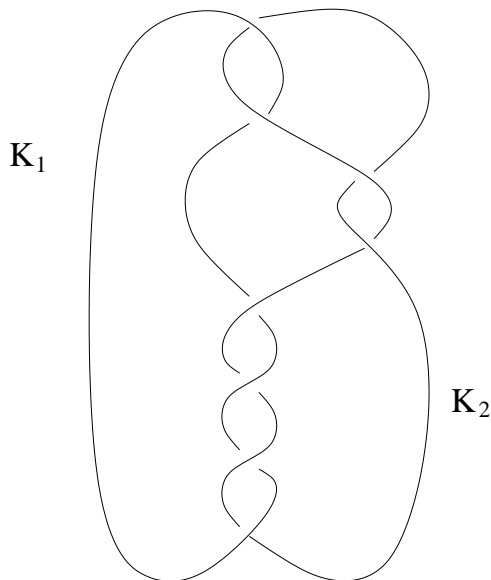

FIGURE 8. A two-bridge link.

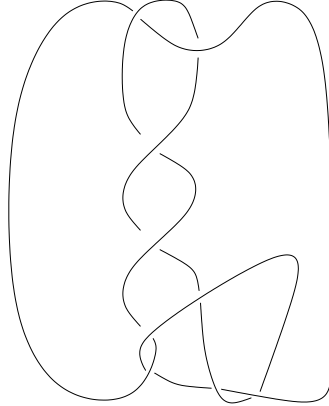

FIGURE 9. **A knot with Heegaard genus two.** This knot is obtained by “blowing down” (with sign -1) the component K_1 of the link from Figure 8.

twists supported in the cylinder on the α , we can arrange for the algebraic intersection number $\#\alpha \cap \beta$ to be an arbitrary integer.

Proposition 6.3. *Consider the doubly-pointed, genus one Heegaard diagram obtained as above, where we have arranged for the curves α and β to have $\#\alpha \cap \beta = \pm 1$. This Heegaard diagram is a destabilization of the Heegaard diagram for the knot K obtained from the two-bridge link $K_1 \cup K_2$ by “blowing down” K_1 (given framing ± 1).*

Proof. In the standard way (see, for example, [9]), a two-bridge link gives a genus two Heegaard diagram of S^3 . This is related to the automorphism σ as follows. We consider the sphere with four distinguished disks $A_1, B_1, A_2,$ and B_2 (neighborhoods of the $a_1, b_1, a_2,$ and b_2 respectively) each fixed by σ . The Heegaard surface Σ_2 is obtained by attaching cylinders C_1 and C_2 to $S^2 - A_1 - B_1 - A_2 - B_2$ which connect ∂A_1 to ∂B_1 and ∂A_2 to ∂B_2 respectively. Meridians μ_1 and μ_2 for the two components K_1 and K_2 are appropriately oriented, embedded, homologically non-trivial circles supported in C_1 and C_2 respectively. The remaining circles, γ_1 and γ_2 , are obtained by closing off the arcs $\sigma(I_1)$ and $\sigma(I_2)$ inside C_1 and C_2 respectively. Longitudes λ_1 and λ_2 for K_1 and K_2 are obtained by closing off I_1 and I_2 in C_1 and C_2 respectively. Thus, $(\Sigma_2, \{\gamma_1, \gamma_2\}, \{\mu_1, \mu_2\})$ describes S^3 . The Heegaard diagram for a three-manifold obtained by integral surgery along K_1 is obtained from the above by replacing μ_1 by the curve δ obtaining by juxtaposing λ_1 and some number of copies of μ_1 . Thus, when δ is chosen so that $\#(\gamma_1 \cap \delta) = \pm 1$, then $(\Sigma_2, \{\gamma_1, \gamma_2\}, \{\delta, \mu_2\})$ is a Heegaard diagram for the knot induced from K_2 inside $S^3_{\pm 1}(K_1)$. The corresponding doubly-pointed Heegaard diagram $(\Sigma_2, \{\gamma_1, \gamma_2\}, \{\delta, \mu_2\}, w, z)$ clearly has the property that μ_2 meets γ_2 in a single point (inside C_2). Thus, we can destabilize as in Proposition 6.1, to obtain the doubly-pointed Heegaard diagram described in the statement of the present proposition. \square

Thus, CFK for knots obtained from two-bridge links is reduced to a calculation of the doubly-pointed chain complex for the torus. Such a calculation is purely combinatorial, i.e. independent of the choice of complex structure on the torus, as we shall see in the following results (see especially Proposition 6.4 below).

When analyzing Floer homology taking place in the torus T , we find it convenient to pass to the universal covering space $\pi: \mathbb{C} \rightarrow T$. To this end, we will assume that α and β are a pair of homotopically non-trivial, embedded curves in the torus T . In this case, $\pi^{-1}(\alpha)$ (and also $\pi^{-1}(\beta)$) is a properly embedded submanifold of \mathbb{C} homeomorphic to $\mathbb{R} \times \mathbb{Z}$. Let $\tilde{\alpha}$ be one connected component of $\pi^{-1}(\alpha)$ and $\tilde{\beta}$ be a connected component of $\pi^{-1}(\beta)$. Given reference points w and z in the torus, $\pi^{-1}(w)$ and $\pi^{-1}(z)$ lift to lattices W and Z respectively. Moreover, $CFK^\infty(S^3, K)$ is generated by triples $[\tilde{x}, i, j]$ subject to the relation in Equation (11) where here the \tilde{x} are intersection points of $\tilde{\alpha}$ and $\tilde{\beta}$. Indeed, by path lifting, given $x, y \in \alpha \cap \beta$, the space of homotopy classes of disks $\pi_2(x, y)$ is identified with the space of homotopy classes of Whitney disks in \mathbb{C} interpolating connecting the corresponding lifts $\tilde{x}, \tilde{y} \in \tilde{\alpha} \cap \tilde{\beta}$ (a space denoted $\tilde{\phi} \in \pi_2(\tilde{x}, \tilde{y})$). Clearly, if $\phi \in \pi_2(x, y)$ and $\tilde{\phi} \in \pi_2(\tilde{x}, \tilde{y})$ is its lift, then $n_w(\phi)$ is obtained as a sum over all $\tilde{w} \in W$ of $n_{\tilde{w}}(\tilde{\phi})$. It is also not difficult to see an identification of moduli spaces $\mathcal{M}(\phi) \cong \mathcal{M}(\tilde{\phi})$.

Proposition 6.4. *Suppose that α and β are two homotopically non-trivial, embedded curves in the torus T , and let $\tilde{\alpha}$ and $\tilde{\beta}$ be corresponding curves in the universal cover \mathbb{C} . Let $\tilde{x}, \tilde{y} \in \tilde{\alpha} \cap \tilde{\beta}$ be a pair of intersection points, and let $\tilde{\phi} \in \pi_2(\tilde{x}, \tilde{y})$ be the homotopy class of Whitney disk connecting \tilde{x} and \tilde{y} . Then if $\mu(\tilde{\phi}) = 1$, we have that $\#\widehat{\mathcal{M}}(\tilde{\phi}) = 1$ if and only if $\mathcal{D}(\tilde{\phi}) \geq 0$.*

Before proving this proposition, it is useful to have the following formula for the Maslov index. To state it, we define the local multiplicity of $\tilde{\phi}$ at \tilde{x} as follows. Given $\tilde{\phi} \in \pi_2(\tilde{x}, \tilde{y})$, there are four regions in $\mathbb{C} - \tilde{\alpha} - \tilde{\beta}$ which contain \tilde{x} as a corner point. Choosing interior points z_1, \dots, z_4 in these four regions, define

$$(15) \quad \bar{n}_{\tilde{x}}(\tilde{\phi}) = \frac{n_{z_1}(\tilde{\phi}) + n_{z_2}(\tilde{\phi}) + n_{z_3}(\tilde{\phi}) + n_{z_4}(\tilde{\phi})}{4}.$$

We define $\bar{n}_{\tilde{y}}(\tilde{\phi})$ similarly, only now choosing the four points in the region containing \tilde{y} as a boundary.

Lemma 6.5. *Suppose that α and β are two homotopically non-trivial, embedded curves in the torus T , and let $\tilde{\alpha}$ and $\tilde{\beta}$ be corresponding curves in the universal cover \mathbb{C} . Given $\tilde{x}, \tilde{y} \in \tilde{\alpha} \cap \tilde{\beta}$,*

$$\mu(\tilde{\phi}) = 2(\bar{n}_{\tilde{x}}(\tilde{\phi}) + \bar{n}_{\tilde{y}}(\tilde{\phi})).$$

Proof. As we go from \tilde{x} to \tilde{y} in $\tilde{\alpha}$, we encounter finitely many intersection points $\tilde{\alpha} \cap \tilde{\beta}$. Let $\{\tilde{x}_1, \dots, \tilde{x}_n\}$ denote this sequence of points, arranged in the order they are

encountered, so that $\tilde{x}_1 = \tilde{x}$ and $\tilde{x}_n = \tilde{y}$. There is a canonical Whitney disks $\tilde{\phi}_i \in \tilde{\pi}_2(\tilde{x}_i, \tilde{x}_{i+1})$: the domain is bounded by the Jordan curve obtained by juxtaposing the two subarcs of $\tilde{\alpha}$ and $\tilde{\beta}$ which connect \tilde{x}_i and \tilde{x}_{i+1} (oriented so that we go from \tilde{x}_i to \tilde{x}_{i+1} in the $\tilde{\alpha}$ -arc). Thus, the support of $\mathcal{D}(\phi_i)$ is an embedded disk whose local multiplicity is either $+1$ or -1 . Clearly, the homotopy class $\tilde{\phi}$ can be decomposed as juxtapositions of these canonical Whitney disks, i.e. $\tilde{\phi} = \tilde{\phi}_1 * \dots * \tilde{\phi}_{n-1}$.

We prove the lemma by induction on the length n . Clearly, when $n = 1$, both quantities are zero.

For the inductive step decompose $\tilde{\phi} = \tilde{\phi}_1 * \tilde{\phi}'$, where $\tilde{\phi}' \in \tilde{\pi}_2(\tilde{x}_2, \tilde{x}_n)$ has length $n - 1$. Let ϵ denote the local multiplicity inside $\mathcal{D}(\phi_1)$. A case-by-case analysis shows that

$$(16) \quad 2(n_{\tilde{x}_1}(\tilde{\phi}) + n_{\tilde{x}_2}(\tilde{\phi})) = 2(n_{\tilde{x}_2}(\tilde{\phi}') + n_{\tilde{x}_n}(\tilde{\phi}')) + \epsilon;$$

while it is easy to see that $\mu(\tilde{\phi}_1) = \epsilon$. Thus, the result follows from Equation (16), using the inductive hypothesis, and the additivity of the Maslov index under juxtaposition.

The cases required for establishing Equation (16) are divided according to the order in which \tilde{x}_1 , \tilde{x}_2 , and \tilde{x}_n are encountered as we traverse $\tilde{\beta}$. Observe that for this ordering, $\tilde{x}_n < \tilde{x}_1$.

For example, suppose that $\tilde{x}_n < \tilde{x}_1 < \tilde{x}_2$. In this case, the local multiplicities of the four regions containing \tilde{x}_1 have the form $m + \epsilon$, occurring three times, and m , occurring once, for some integer m . Now, traversing the arc in $\tilde{\alpha}$ from \tilde{x}_1 to \tilde{x}_2 , we see that the four neighboring multiplicities are: m (with multiplicity two) and $m + \epsilon$ (also with multiplicity two). It follows readily that

$$n_{\tilde{x}_2}(\tilde{\phi}') = n_{\tilde{x}_1}(\tilde{\phi}) - \frac{1}{2}\epsilon, \quad n_{\tilde{x}_n}(\tilde{\phi}') = n_{\tilde{x}_n}(\tilde{\phi}),$$

verifying Equation (16). The case where $\tilde{x}_2 < \tilde{x}_n < \tilde{x}_1$ works the same way.

Finally, when $\tilde{x}_n < \tilde{x}_2 < \tilde{x}_1$, we have instead that

$$n_{\tilde{x}_2}(\tilde{\phi}') = n_{\tilde{x}_1}(\tilde{\phi}), \quad n_{\tilde{x}_n}(\tilde{\phi}') = n_{\tilde{x}_2}(\tilde{\phi}) - \frac{1}{2}\epsilon,$$

also giving Equation (16). □

We now turn to a proof of Proposition 6.4.

Proof of Proposition 6.4. Clearly, if $\tilde{\phi}$ has a holomorphic representative, then $\mathcal{D}(\tilde{\phi}) \geq 0$.

In the more interesting direction, suppose that $\tilde{\phi} \in \pi_2(\tilde{x}, \tilde{y})$ is a homotopy class with $\mu(\tilde{\phi}) = 1$ and $\mathcal{D}(\tilde{\phi}) \geq 0$. Clearly, $\tilde{\phi}$ is determined by the restriction of $\tilde{\phi}$ to its boundary. Moreover, its boundary curve C is formed from an arc a in $\tilde{\alpha}$ from \tilde{x} to \tilde{y} and an arc b in $\tilde{\beta}$ from \tilde{y} to \tilde{x} . Of course, C is null-homotopic. Our goal is to construct a covering space of the plane with two disks removed, in which the lift C' of C is a null-homotopic, embedded circle.

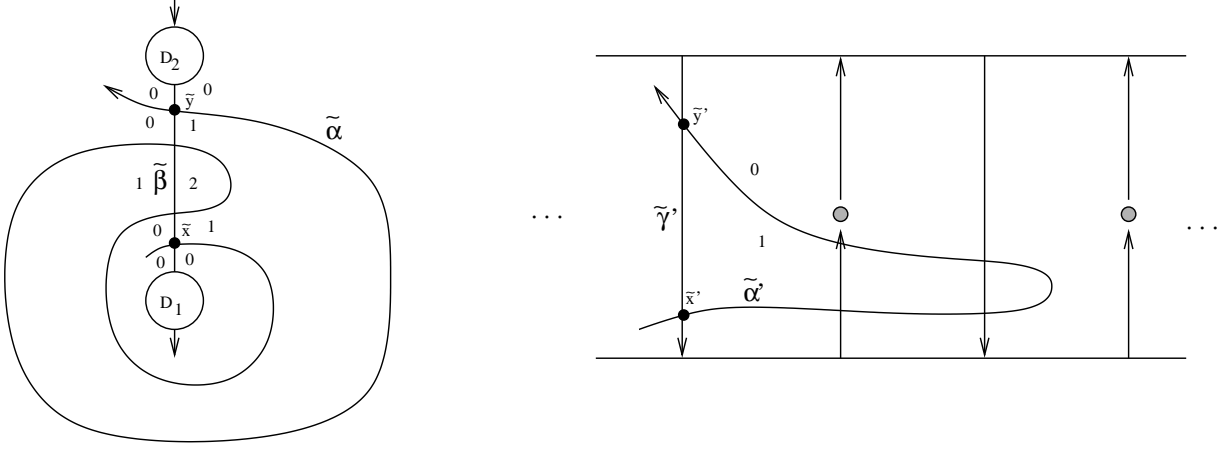

FIGURE 10. **Lifting a domain.** On the left-hand-side, we have illustrated a domain connecting \tilde{x} and \tilde{y} , corresponding to a map $\tilde{\phi}$ with $\mu(\tilde{\phi}) = 1$. The ambient space is \mathbb{C} , with the disks D_1 and D_2 deleted. On the right, we have illustrated an induced domain in X . Here, the picture is an infinite strip with an infinite sequence of puncture points, indicated here by the grey circles. The top boundary corresponding to the universal cover of ∂D_2 , and the bottom corresponding to the universal cover of ∂D_1 .

To this end, Lemma 6.5, together with the hypothesis that $\mathcal{D}(\tilde{\phi}) \geq 0$, shows that three out of the four local multiplicities around each of \tilde{x} and \tilde{y} vanish, and the remaining ones are $+1$. We choose a pair of disks, D_1 and D_2 , centered at points on $\tilde{\beta}$ with D_1 just after \tilde{x} , and the other just before \tilde{y} in $\tilde{\beta}$ (with respect to the orientation induced on $\tilde{\beta}$ from $\partial\mathcal{D}(\tilde{\phi})$), choosing the disks small enough to be disjoint from the support of $\mathcal{D}(\tilde{\phi})$, and so that they are disjoint from $\tilde{\alpha}$. Clearly, $(D_1 \cup D_2) \cap \tilde{\beta}$ separates $\tilde{\beta}$ into three components, one of which is compact (containing both \tilde{x} and \tilde{y}) and two of which are non-compact. Let γ denote the compact subarc. Intersection number with γ induces a homomorphism of $\pi_1(\mathbb{C} - D_1 - D_2)$ to \mathbb{Z} , and hence a covering space X of $\mathbb{C} - D_1 - D_2$. This covering space is easily seen to be an infinite strip with a discrete, countable set of points Λ removed (corresponding to the point at infinity in $\mathbb{C} - D_1 - D_2$). In X , the pre-image of γ is an infinite collection of separating arcs (connecting the two boundaries), of which we choose one, denoted γ' . Similarly, the pre-image of $\tilde{\alpha}$ is an infinite collection of arcs (which begin and end in the puncture points), of which we choose one, $\tilde{\alpha}'$. Let \tilde{x}' and \tilde{y}' be the lifts in $\tilde{\alpha}' \cap \gamma'$ of \tilde{x} and \tilde{y} respectively. (c.f. Figure 10 for an illustration).

The lift C' of C to X , of course, is obtained by adjoining the subarc a' in $\tilde{\alpha}'$ from \tilde{x}' to \tilde{y}' to the subarc b' in $\tilde{\beta}'$ from \tilde{y}' to \tilde{x}' . We claim that a' and b' meet only along their boundary, and hence that C' is an embedded curve. To this end, observe that γ' separates X into two halves. Call the “right” half the one which the curve a' points

towards, at \tilde{x}' . Let \tilde{q}' be the first crossing (with respect to the a' orientation) after \tilde{x}' encountered as we traverse a' . With respect to the induced orientation on γ , \tilde{x}' and \tilde{y}' are extremal. It is an easy consequence now that one of the four local multiplicities near \tilde{q}' is -1 . Indeed, by following parallel to a' , we can find a curve δ supported on the “right”, connecting one of the regions near \tilde{x}' with zero multiplicity to one of the four neighboring regions near \tilde{q}' , so that δ is supported near $\tilde{\alpha}'$, its projection to \mathbb{C} is disjoint from $\tilde{\alpha}$, and, since its endpoints are both near γ' but to the right, the intersection number of the projection of δ with $\tilde{\beta}$ is zero. This shows that in $\mathbb{R}^2 - D_1 - D_2$ there is a region containing \tilde{q} (the projection to $\mathbb{R}^2 - D_1 - D_2$ of \tilde{q}') to the right of γ , which has multiplicity zero. Since \tilde{q}' falls between \tilde{x}' and \tilde{y}' , it follows that the facing region on the other side of γ has multiplicity -1 . (See the illustration in Figure 11.) This contradicts the hypothesis that $\mathcal{D}(\tilde{\phi}) \geq 0$.

We have established that C' is an embedded curve in X . Thus, by the Jordan curve theorem, C' separates the strip into two regions, a disk D , and another region which contains the boundary of the strip. Since $\mathcal{D}(\tilde{\phi})$ is compact it follows readily that none of the points in Λ is contained in the disk; i.e. C' bounds a disk in X . (More precisely, the disk has two corner points at the two points in C' where a' and b' meet.) It follows now by the Riemann mapping theorem that there is a unique holomorphic Whitney

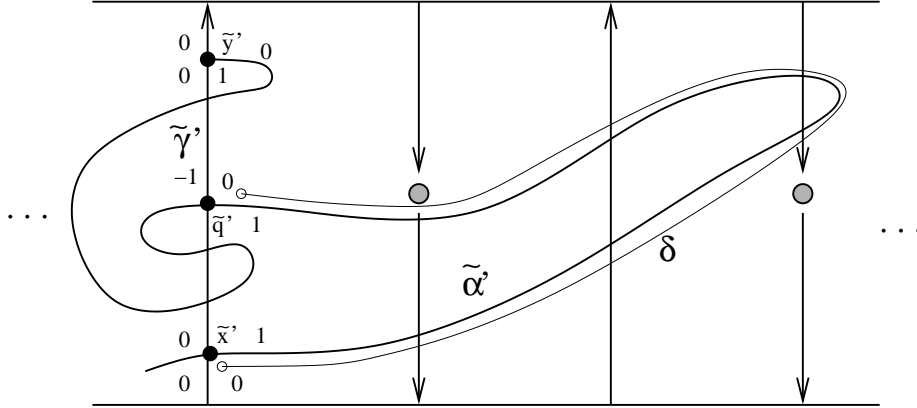

FIGURE 11. **Proof of Proposition 6.4.** In the case where the arc in a' meets the arc b' in than two points, as we have illustrated, $\mathcal{D}(\tilde{\phi})$ is forced to be non-positive, provided $\mu(\tilde{\phi}) = 1$. The light curve δ illustrated here has projection to $\mathbb{R}^2 - D_1 - D_2$ which is disjoint from $\tilde{\alpha}$, and intersection number zero with $\tilde{\beta}$. Thus, the multiplicities of $\mathcal{D}(\tilde{\phi})$ at the two endpoints must coincide (indeed, they must vanish). It follows that just on the other side of $\tilde{\beta}'$ from the endpoint near \tilde{q}' , the local multiplicity of the domain $\mathcal{D}(\tilde{\phi})$ is -1 .

disk representing this disk; and hence by path-lifting, it follows that $\#\mathcal{M}(\tilde{\phi}) = 1$, as well. \square

As an illustration of these techniques, consider the link pictured in Figure 8. Label the generators of the braid group on four elements by τ_1, τ_2, τ_3 (so that τ_i transposes the i^{th} and $(i+1)^{\text{st}}$ strands). The braid element σ corresponding to the link, then can be written as a product $\tau_2^2 \cdot \tau_3^2 \cdot \tau_2^{-4}$. The Heegaard diagram, then, is obtained by corresponding Dehn twists in the sphere with four marked points. Blowing down the other component (with sign -1), we obtain the diagram illustrated in Figure 12. Note that this gives us the knot pictured in Figure 9 (which appears in knot tables as the knot 9_{42}). Moreover, lifting this doubly-pointed Heegaard diagram to the universal covering space \mathbb{C} for the torus, we obtain the picture shown in Figure 13.

In this case, $\tilde{\alpha} \cap \tilde{\beta}$ consists of $n = 9$ points. Thus, $\mathbb{C} - \tilde{\alpha} - \tilde{\beta}$ has eight compact, connected components (and, more generally, $n - 1$ compact connected components), which we label D_1, \dots, D_8 , under the numbering convention as follows. Let C_i denote the Jordan curve obtained by juxtaposing the segment of $\tilde{\alpha}$ connecting \tilde{x}_i to \tilde{x}_{i+1} with the corresponding segment in $\tilde{\beta}$. Then, D_i is the component of $\mathbb{C} - \tilde{\alpha} - \tilde{\beta}$ which is

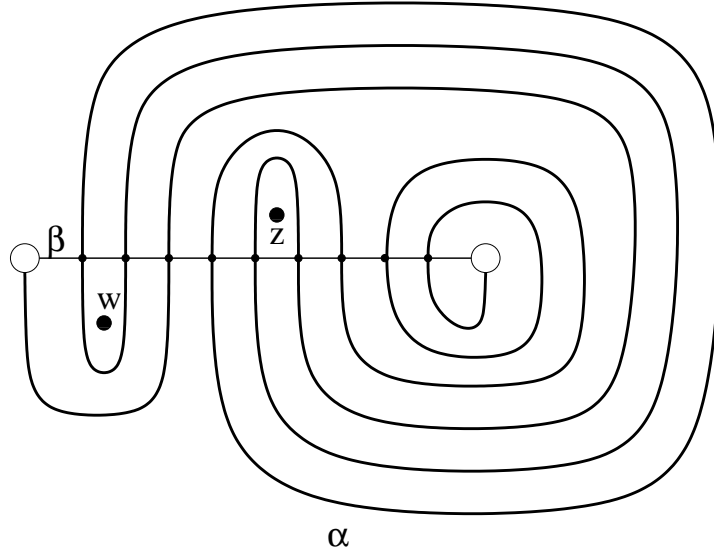

FIGURE 12. **A doubly-pointed Heegaard diagram.** This is the Heegaard diagram for the knot from Figure 9, as constructed in Proposition 6.3. The two empty circles are glued along a cylinder, so that no new intersection points are introduced between the curve α (the darker curve) and β (the lighter, horizontal curve). Note that there are nine intersection points between α and β , which, when counted with sign, give an intersection number of $+1$.

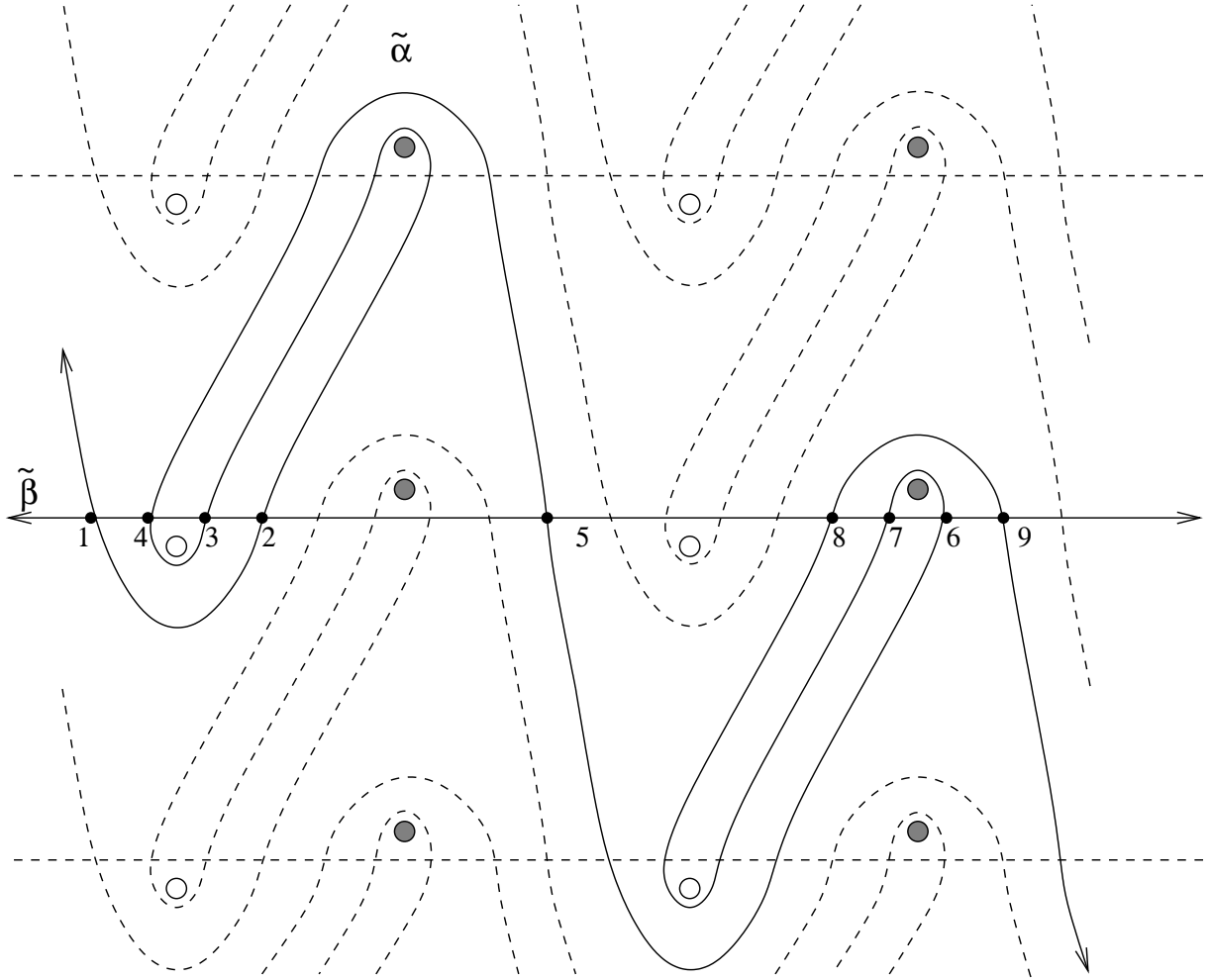

FIGURE 13. **Lift of Figure 12 to the universal cover.** Two of the lifts of α and β , $\tilde{\alpha}$ and $\tilde{\beta}$, are pictured here as dark curves, while other lifts are shown with dashed lines. The lattice $\pi^{-1}(\{w\})$ is represented by the lightly-filled circles, while the lattice of $\pi^{-1}(\{z\})$ is represented by the darkly-filled circles, while. The nine intersection points of $\tilde{\alpha}$ and $\tilde{\beta}$ are labeled in the order in which they are encountered along $\tilde{\alpha}$.

inside C_i , and whose boundary contains \tilde{x}_i . For example, as we see from the figure, C_1 , whose interior represents a flow from \tilde{x}_1 to \tilde{x}_2 , can be decomposed as a sum $D_1 + D_3$; C_2 , which gives a flow from \tilde{x}_3 to \tilde{x}_2 , bounds simply D_2 ; while C_3 bounds D_3 , giving a flow from \tilde{x}_3 to \tilde{x}_4 . It follows that the domain of the Whitney disk from \tilde{x}_4 to \tilde{x}_1 is given by $D_1 + D_2$. This disk has $\mu = 1$, and it clearly supports a single flowline (indeed, it is represented by an embedded disk in the plane). Moreover, the domain contains no

points point from the W lattice and one from the Z lattice, so we have determined that the \tilde{x}_4 coefficient of $\partial[\tilde{x}_1, i, j]$ is $\pm[\tilde{x}_4, i, j - 1]$.

Proceeding in the like manner, one verifies that $CFK^\infty(S^3, K)$ (with the notational shorthand from Subsection 3.4) is generated as a \mathbb{Z} -module by generators indexed by $i \in \mathbb{Z}$ of the form:

$$(17) \quad \begin{array}{lll} [\tilde{x}_1, i + 1, i], & [\tilde{x}_2, i, i], & [\tilde{x}_3, i, i - 1], \\ [\tilde{x}_4, i + 1, i - 1], & [\tilde{x}_5, i + 1, i + 1], & [\tilde{x}_6, i - 1, i + 1], \\ [\tilde{x}_7, i - 1, i], & [\tilde{x}_8, i, i], & [\tilde{x}_9, i, i + 1]; \end{array}$$

and the boundary operator on $CFK^\infty(S^3, K)$ (up to some signs) is given by:

$$\begin{aligned} \partial[\tilde{x}_1, i + 1, j] &= [\tilde{x}_2, i, i] + [\tilde{x}_4, i + 1, i - 1] \\ \partial[\tilde{x}_2, i, i] &= [\tilde{x}_3, i, i - 1] \\ \partial[\tilde{x}_3, i, i - 1] &= 0 \\ \partial[\tilde{x}_4, i + 1, i - 1] &= [\tilde{x}_3, i, i - 1] \\ \partial[\tilde{x}_5, i + 1, i + 1] &= [\tilde{x}_2, i, i] + [\tilde{x}_4, i + 1, i - 1] + [\tilde{x}_6, i - 1, i + 1] + [\tilde{x}_8, i, i] \\ \partial[\tilde{x}_6, i - 1, i + 1] &= [\tilde{x}_7, i - 1, i] \\ \partial[\tilde{x}_7, i - 1, i] &= 0 \\ \partial[\tilde{x}_8, i, i] &= [\tilde{x}_7, i - 1, i] \\ \partial[\tilde{x}_9, i, i + 1] &= [\tilde{x}_6, i - 1, i + 1] + [\tilde{x}_8, i, i] \end{aligned}$$

In calculations, it is often useful to depict this schematically, as pictured in Figure 14.

Consider the complex $CFK^{0,*}(Y, K)$, which is generated by the nine generators as enumerated in Equation (17), but with $i = 0$. We obtain a complex whose homology is \mathbb{Z} , supported in a single dimension. In fact, this homology is represented by the cycle $[\tilde{x}_1, 0, -1] \pm [\tilde{x}_5, 0, 0]$. Indeed (as in to Lemma 3.6) this generator represents the Floer homology class of $\widehat{HF}(S^3) \cong \mathbb{Z}$, so its absolute grading is zero.

In particular, we have the following:

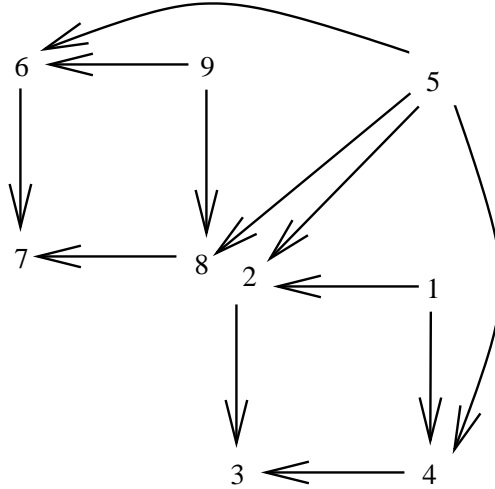

FIGURE 14. **The chain complex.** This depicts the differential for $CFK^\infty(S^3, K)$. The integers here correspond to intersection points with the labeling conventions from the text: i.e. the integer k corresponds to \tilde{x}_k . An arrow denotes a non-trivial differential, and (rough) coordinates in the plane correspond to the indices i, j . Of course, the complex $CFK^\infty(S^3, K)$ consists of infinitely many copies of this complex; more precisely it is the tensor product of this complex with $\mathbb{Z}[U, U^{-1}]$.

Proposition 6.6. *Let K denote the knot 9_{A2} (illustrated in Figure 9). Various invariants for the knot K are given by :*

$$\widehat{HFK}(S^3, K, i) \cong \begin{cases} \mathbb{Z}_{(3)} & \text{if } i = 2 \\ \mathbb{Z}_{(2)}^2 & \text{if } i = 1 \\ \mathbb{Z}_{(1)}^2 \oplus \mathbb{Z}_{(0)} & \text{if } i = 0 \\ \mathbb{Z}_{(0)}^2 & \text{if } i = -1 \\ \mathbb{Z}_{(-1)} & \text{if } i = -2 \\ 0 & \text{otherwise.} \end{cases}$$

$$HF^+(S_0^3(K), i) \cong \begin{cases} \mathcal{T}_{-1/2} \oplus \mathcal{T}_{1/2} & \text{if } i = 0 \\ \mathbb{Z} & \text{if } i = \pm 1 \\ 0 & \text{otherwise} \end{cases}$$

In particular, $d_{\pm 1/2}(S_0^3(K)) = \pm 1/2$.

Proof. The calculation of $HFK(S^3, K)$ follows from inspection of the chain complex.

For instance, observe that $\widehat{CFK}(S^3, K, 2)$ is generated by a single element $[\tilde{x}_6, 0, 2]$, while $\widehat{CF}(S^3, K, 0)$ is generated by three elements $[\tilde{x}_2, 0, 0]$, $[\tilde{x}_5, 0, 0]$, and $[\tilde{x}_8, 0, 0]$.

To calculate $HF^+(S_0^3(K))$, we first use Theorem 4.1 to identify $HF^+(S_{-p}^3(K), [s])$ for large p with $H_*({}^bCFK^+(Y, K, s))$ (with the grading shift). The graded long exact sequence for integral surgeries then shows that $HF^+(S_0^3(K))$ has the claimed form. \square

7. CONNECTED SUMS OF KNOTS

Recall that there are multiplication maps

$$\begin{aligned} \widehat{CF}(Y_1) \otimes_{\mathbb{Z}} \widehat{CF}(Y_2) &\longrightarrow \widehat{CF}(Y_1 \# Y_2), \\ CF^-(Y_1) \otimes_{\mathbb{Z}[U]} CF^-(Y_2) &\longrightarrow CF^-(Y_1 \# Y_2), \\ CF^\infty(Y_1) \otimes_{\mathbb{Z}[U, U^{-1}]} CF^\infty(Y_2) &\longrightarrow CF^\infty(Y_1 \# Y_2), \end{aligned}$$

which induce homotopy equivalences.

To state the generalization for knot invariants, we use the following convention: the tensor product of two \mathbb{Z} -filtered (resp. $\mathbb{Z} \oplus \mathbb{Z}$ -filtered) filtered complexes (C_1, \mathcal{F}_1) and (C_2, \mathcal{F}_2) is naturally a \mathbb{Z} -filtered (resp. $\mathbb{Z} \oplus \mathbb{Z}$ -filtered) complex $(C_1 \otimes C_2, \mathcal{F}_\otimes)$, where the tensor product filtration is defined by

$$\mathcal{F}_\otimes(x_1 \otimes x_2) = \mathcal{F}_1(x_1) + \mathcal{F}_2(x_2)$$

for arbitrary homogeneous generators $x_1 \in C_1$ and $x_2 \in C_2$.

Given $\mathfrak{t}_1 \in \underline{\text{Spin}}^c(Y_1, K_1)$ and $\mathfrak{t}_2 \in \underline{\text{Spin}}^c(Y_2, K_2)$, let $\mathfrak{t}_3 = \mathfrak{t}_1 \# \mathfrak{t}_2 \in \underline{\text{Spin}}^c(Y_1 \# Y_2, K_1 \# K_2)$ be characterized by the properties that

- if $\mathfrak{s}_i \in \text{Spin}^c(Y_i)$ denote the Spin^c structures underlying \mathfrak{t}_i for $i = 1, \dots, 3$, where $Y_3 = Y_1 \# Y_2$, then \mathfrak{s}_3 is cobordant to $\mathfrak{s}_1 \cup \mathfrak{s}_2$ under the natural cobordism from Y_3 to $Y_1 \cup Y_2$
- if F_1 and F_2 are Seifert surfaces for K_1 and K_2 , and F_3 is the corresponding Seifert surface for $K_1 \# K_2$ obtained by boundary connected sum, then

$$\langle c_1(\mathfrak{t}_3), [F_3] \rangle = \langle c_1(\mathfrak{t}_1), [F_1] \rangle + \langle c_1(\mathfrak{t}_2), [F_2] \rangle.$$

Theorem 7.1. *There are filtered chain homotopy equivalences*

$$\begin{aligned} CFK^{0,*}(Y_1, K_1) \otimes_{\mathbb{Z}} CFK^{0,*}(Y_1, K_1) &\longrightarrow CFK^{0,*}(Y_1 \# Y_2, K_1 \# K_2) \\ CFK^{<,*}(Y_1, K_1) \otimes_{\mathbb{Z}[U]} CFK^{<,*}(Y_1, K_1) &\longrightarrow CFK^{<,*}(Y_1 \# Y_2, K_1 \# K_2) \\ CFK^\infty(Y_1, K_1) \otimes_{\mathbb{Z}[U, U^{-1}]} CFK^\infty(Y_1, K_1) &\longrightarrow CFK^\infty(Y_1 \# Y_2, K_1 \# K_2) \end{aligned}$$

which respect the splittings of the complexes according to their summands; in particular,

$$CFK^\infty(Y_1 \# Y_2, \mathfrak{t}_3) \cong \bigoplus_{\{\mathfrak{t}_1, \mathfrak{t}_2 \in \underline{\text{Spin}}^c(Y_1, K_1) \times \underline{\text{Spin}}^c(Y_2, K_2) \mid \mathfrak{t}_1 \# \mathfrak{t}_2 = \mathfrak{t}_3\}} CFK^\infty(Y_1, \mathfrak{t}_1) \otimes CFK^\infty(Y_2, \mathfrak{t}_2).$$

Proof. We sketch here the definition of the usual connected sum map (see Section 6 of [18]). Let $(\Sigma_1, \boldsymbol{\alpha}_1, \boldsymbol{\beta}_1, w_1)$ and $(\Sigma_2, \boldsymbol{\alpha}_2, \boldsymbol{\beta}_2, w_2)$ be pointed Heegaard diagrams representing Y_1 and Y_2 . There are maps

$$\begin{aligned} CF^\infty(Y_1) &\longrightarrow CF^\infty(Y_1 \#^{g_2}(S^2 \times S^1)) \\ CF^\infty(Y_2) &\longrightarrow \widehat{CF}(\#^{g_1}(S^2 \times S^1) \# Y_2) \end{aligned}$$

sending \mathbf{x}_1 and \mathbf{x}_2 to $\mathbf{x}_1 \times \Theta_1$ and $\Theta_2 \times \mathbf{x}_2$ respectively, where Θ_1 and Θ_2 are intersection points representing the canonical (top-dimensional) $HF^{\leq 0}$ class for the connected sum

of $S^2 \times S^1$. We then compose this with a count f of holomorphic triangles in the Heegaard triple $(\Sigma_1 \# \Sigma_2, \boldsymbol{\alpha}_1 \times \boldsymbol{\alpha}_2, \boldsymbol{\beta}_1 \times \boldsymbol{\alpha}_2, \boldsymbol{\beta}_1 \times \boldsymbol{\beta}_2)$. In the above expression, any time some g -tuple of circles is repeated, it is to be understood that one takes a small exact Hamiltonian translate to make the intersections transverse.

The refinement

$$f^\infty : CFK^\infty(Y_1, K_1) \otimes_{\mathbb{Z}[U, U^{-1}]} CFK^\infty(Y_2, K_2) \longrightarrow CFK^\infty(Y_1 \# Y_2, K_1 \# K_2)$$

is defined as follows. Consider the map

$$\begin{aligned} & f([\mathbf{x}_1, i_1, j_1] \otimes [\mathbf{x}_2, i_2, j_2]) \\ &= \sum_{\mathbf{y} \in \mathbb{T}_{\boldsymbol{\alpha}_1 \times \boldsymbol{\alpha}_2} \cap \mathbb{T}_{\boldsymbol{\beta}_1 \times \boldsymbol{\beta}_2}} \sum_{\{\psi \in \pi_2(\mathbf{x}_1 \times \Theta_2, \Theta_1 \times \mathbf{x}_2, \mathbf{y})\}} \# \mathcal{M}(\psi) \cdot [\mathbf{y}, i_1 + i_2 - n_{w_1}(\psi), j_1 + j_2 - n_{z_2}(\psi)], \end{aligned}$$

where we continue with the notation from above, with the understanding that the meridians μ_1 and μ_2 appear in the g -tuples $\boldsymbol{\beta}_1$ and $\boldsymbol{\beta}_2$ respectively. Of course, the above map is a perturbation of the map sending $[\mathbf{x}_1, i_1, j_1] \otimes [\mathbf{x}_2, i_2, j_2]$ to $[\mathbf{x}_1 \times \mathbf{x}_2, i_1 + i_2, j_1 + j_2]$. The map clearly respects filtrations, since $n_{z_2}(\psi) \geq 0$ whenever ψ has a holomorphic representative. We go from this Heegaard diagram to a Heegaard diagram for the following Heegaard diagram for the knot $(Y_1 \# Y_2, K_1 \# K_2)$,

$$(\Sigma, \boldsymbol{\alpha}_1 \cup \boldsymbol{\alpha}_2, \boldsymbol{\beta}_3 \cup (\boldsymbol{\beta}_1 - \mu_1)' \cup (\boldsymbol{\beta}_2 - \mu_2)', \mu_3),$$

where here the primes denote small exact Hamiltonian translates, μ_3 is a curve obtained from μ_1 by a small exact Hamiltonian translate, and $\boldsymbol{\beta}_3$ is obtained as a handleslide of μ_2 over μ_1 – in particular, the new Heegaard diagram for $Y_1 \# Y_2$ differs from the $(\Sigma_1 \# \Sigma_2, \boldsymbol{\alpha}_1 \times \boldsymbol{\alpha}_2, \boldsymbol{\beta}_1 \times \boldsymbol{\beta}_2)$ by a single handleslide. Moreover, it is easy to see that the composite map here respects relative filtrations.

We verify that this map respects the splitting according to $\text{Spin}^c(Y_i, K_i)$. This is clear on the level of $\text{Spin}^c(Y_i)$; thus, it remains to show that if F_1 and F_2 are compatible Seifert surfaces for K_1 and K_2 , then

$$(18) \quad \langle c_1(\mathbf{t}(\mathbf{x}_1)), [\widehat{F}_1] \rangle + \langle c_1(\mathbf{t}(\mathbf{x}_2)), [\widehat{F}_2] \rangle = \langle c_1(\widehat{\mathbf{t}}(\mathbf{x}_1 \times \mathbf{x}_2)), [\widehat{F}_1 \#_b \widehat{F}_2] \rangle,$$

where $F_1 \#_b F_2$ is the Seifert surface for $K_1 \# K_2$ inside $Y_1 \# Y_2$ obtained by boundary connected sum. To this end, observe that if λ_1 and λ_2 are curves in the Heegaard diagrams for Y_1 and Y_2 representing longitudes for the knots K_1 and K_2 respectively, then $\lambda_1 \# \lambda_2$ represents a longitude for $K_1 \# K_2$. Correspondingly, if P_1 and P_2 are the periodic domains (corresponding to \widehat{F}_1 and \widehat{F}_2) in $(Y_1)_0(K_1)$ and $(Y_2)_0(K_2)$ respectively, then the periodic domain for $F_1 \#_b F_2$ in $(Y_1 \# Y_2)_0(K_1 \# K_2)$ is obtained from P_1 and P_2 by a boundary connected sum (see Figure 15). Under this operation, the Euler measure satisfies

$$\chi(P_1 \#_b P_2) = \chi(P_1) + \chi(P_2) - 1,$$

and it is easy to see that if \mathbf{x}_3 denotes the intersection point corresponding to $\mathbf{x}_1 \times \mathbf{x}_2$, then

$$\bar{n}_{\mathbf{x}_3}(P_1 \#_b P_2) = \bar{n}_{\mathbf{x}_1}(P_1) + \bar{n}_{\mathbf{x}_2}(P_2) + \frac{1}{2}.$$

(Again, the reader is asked to consult Figure 15.) Equation (18) now follows immediately from these observations and Equation (9).

Having defined f^∞ , it is now easy to adapt the arguments for three-manifolds to verify that f^∞ is a chain homotopy equivalence of filtered complexes. (Moreover, the corresponding constructions for $CFK^{<,*}$ and $CFK^{0,*}$ proceed in the same way.) \square

Note that the above theorem has the following immediate corollary (which can be thought of as a refinement of the multiplicativity of the Alexander polynomial under connected sums):

Corollary 7.2. *Let $\mathfrak{t}_1 \in \underline{\text{Spin}}^c(Y_1, K_1)$ and $\mathfrak{t}_2 \in \underline{\text{Spin}}^c(Y_2, K_2)$ be Spin^c structures, and let $\mathfrak{t}_1 \# \mathfrak{t}_2 \in \underline{\text{Spin}}^c(Y_1 \# Y_2, K_1 \# K_2)$ denote the Spin^c structure whose underlying Spin^c structure is cobordant to $\mathfrak{s}_1 \cup \mathfrak{s}_2$ over $Y_1 \cup Y_2$ (under the natural cobordism to $Y_1 \# Y_2$), and*

$$\langle c_1(\mathfrak{t}_1 \# \mathfrak{t}_2), [\widehat{F_1 \#_b F_2}] \rangle = \langle c_1(\mathfrak{t}_1), [\widehat{F_1}] \rangle + \langle c_1(\mathfrak{t}_2), [\widehat{F_2}] \rangle.$$

Then, for each $\mathfrak{t}_3 \in \underline{\text{Spin}}^c(Y_1 \# Y_2, K_1 \# K_2)$, we have

$$\widehat{HFK}(Y_1 \# Y_2, K_1 \# K_2, \mathfrak{t}_3) \cong \bigoplus_{\mathfrak{t}_1 \# \mathfrak{t}_2 = \mathfrak{t}_3} H_*(\widehat{CFK}(Y_1, K_1, \mathfrak{t}_1) \otimes \widehat{CFK}(Y_2, K_2, \mathfrak{t}_2)).$$

Proof. This follows immediately from the theorem. \square

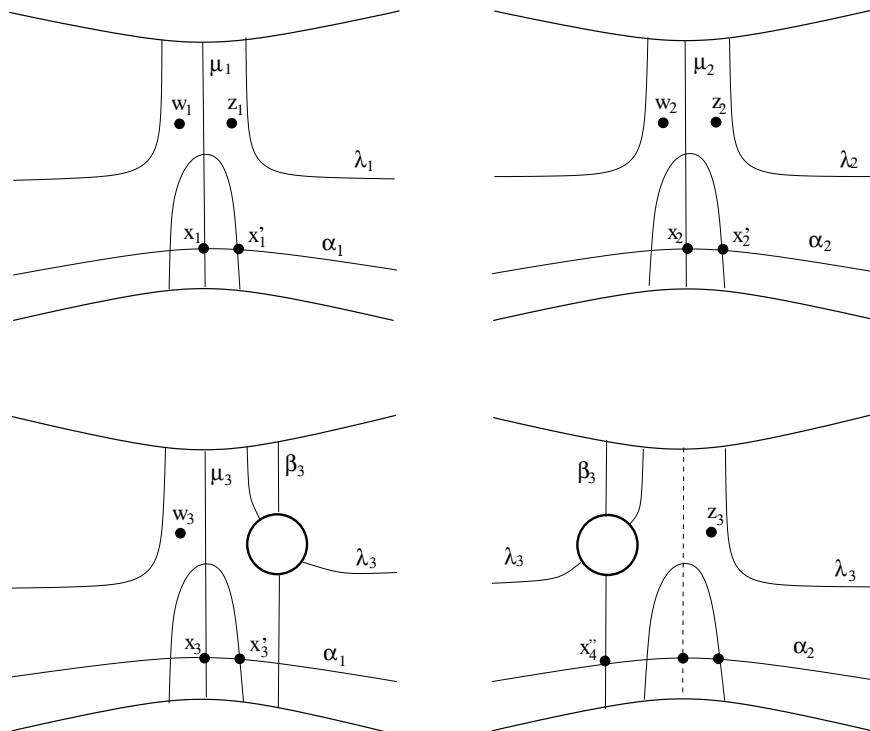

FIGURE 15. **Connected sum of knots: before and after.** The top picture represents the (disconnected) union of two original manifolds (Y_1, K_1) and (Y_2, K_2) , while the second represents their connected sum (in particular, in the second picture, the two open circles are identified). The curve μ_3 (corresponding to μ_1 in the previous diagram) represents a meridian for $K_1 \# K_2$ while the curve β_2 which is obtained by handlesliding μ_2 over μ_1 (after forming the connected sum) is a new attaching circle for $Y_3 = Y_1 \# Y_2$. The circle λ_3 is the longitude for $K_1 \# K_2$. Note that β_3 and λ_3 are the only curves which go through the connected sum neck. The curve β_3 is easily seen not to appear in the boundary of the periodic domain for $K_1 \# K_2$, while the curve λ_3 appears in it with multiplicity one. The pair $x'_3 \times x''_4$ corresponds under the tensor product map to $x_1 \times x_2$.

8. LONG EXACT SEQUENCES

One can readily adapt the surgery long exact sequences from [18] to the context of knot invariants, in several ways. We give here a discussion whose level of generality is suitable for the applications to follow.

Recall that if γ is a framed knot in a three-manifold Y , and \mathfrak{s} is a Spin^c structure on the four manifold $W = W_\gamma(Y)$, then there are maps induced by counting holomorphic triangles

$$\begin{aligned} \widehat{f}_{W,\mathfrak{s}}: \widehat{CF}(Y) &\longrightarrow \widehat{CF}(Y_\gamma), \\ f_{\overline{W},\mathfrak{s}}: CF^-(Y) &\longrightarrow CF^-(Y_\gamma), \\ f_{\overline{W},\mathfrak{s}}^\infty: CF^\infty(Y) &\longrightarrow CF^\infty(Y_\gamma). \end{aligned}$$

In the presence of a Seifert surface F for a knot, for each $\mathfrak{s} \in \text{Spin}^c(Y)$, there is a $\mathfrak{t}_0 \in \underline{\text{Spin}}^c(Y, K)$ extending \mathfrak{s} , which is uniquely characterized by the property that

$$\langle c_1(\mathfrak{t}_0), [\widehat{F}] \rangle = 0.$$

Thus, we can identify,

$$CF^\infty(Y, \mathfrak{s}) \cong CFK^\infty(Y, \mathfrak{t}_0),$$

as \mathbb{Z} -filtered complexes; and this isomorphism endows $CF^\infty(Y, \mathfrak{s})$ with an extra \mathbb{Z} grading (i.e. our representatives for CFK^∞ are triples $[\mathbf{x}, i, j]$, and the \mathbb{Z} filtration is given by the value of j). We sometimes suppress \mathfrak{t}_0 from the notation, writing $CFK^\infty(Y, K, \mathfrak{s})$ when F is understood from the context. (Note that this shorthand coincides with the corresponding shorthand we used in the case where $c_1(\mathfrak{s})$ is torsion.)

Suppose now that K is an oriented knot in Y which is disjoint from γ , and whose linking number with γ is zero. In this case, we can choose a Seifert surface F for Y which is disjoint from γ ; thus, this can be closed up in Y or Y_γ to obtain surfaces \widehat{F} and \widehat{F}' .

Proposition 8.1. *Let Y be a three-manifold with a null-homologous knot K , and let γ be a framed knot which is disjoint from K , and whose linking number with K is zero, and let Y' be the three-manifold induced from Y by surgery along γ and K' be the induced knot. Then, for each Spin^c structure \mathfrak{s} , the map $f_{W,\mathfrak{s}}$ induced by counting holomorphic triangles respects the above induced \mathbb{Z} -filtrations.*

Proof. We describe here the case of $CF^\infty(Y)$; the other two cases follow similarly. Let $(\Sigma, \boldsymbol{\alpha}, \boldsymbol{\beta}, \boldsymbol{\gamma}, w, z)$ be a Heegaard triple, where for $i = 2, \dots, g$, β_i is a small exact Hamiltonian translate of γ_i , with $\mu = \beta_2$, while the β_1 and γ_1 are different (the γ_1 here corresponds to the longitude of γ , and β_1 to its meridian) Following [19], the map

$$f_{\overline{W},\mathfrak{s}}^\infty: CFK^\infty(Y, K) \longrightarrow CFK^\infty(Y', K')$$

induced by the cobordism is defined by

$$f_{W,s}^\infty([\mathbf{x}, i, j]) = \sum_{\{\mathbf{y} \in \mathbb{T}_\alpha \cap \mathbb{T}_\gamma\}} \sum_{\{\psi \in \pi_2(\mathbf{x}, \Theta, \beta, \gamma, \mathbf{y}) \mid \mu(\psi) = 0\}} \#\mathcal{M}(\psi) \cdot [\mathbf{y}, i - n_w(\psi), j - n_z(\psi)].$$

We must verify that the range of this map is $CFK^\infty(Y', K')$ as claimed, i.e. that if

$$(19) \quad \langle c_1(\underline{\mathfrak{s}}_m(\mathbf{x}), [F]) \rangle + (i - j) = 0,$$

then if $\psi \in \pi_2(\mathbf{x}, \Theta, \mathbf{y})$, we also have that

$$\langle c_1(\underline{\mathfrak{s}}_m(\mathbf{y}), [\widehat{F}']) \rangle + (i - n_w(\psi) - j + n_z(\psi)) = 0,$$

as well.

As a preliminary remark, we claim that if P is a triply-periodic domain for the Heegard triple describing the cobordism from Y to Y' , then $n_w(P) = n_z(P)$. The reason for this is that P can be viewed as a null-homology of γ in Y (as the only curve which appears in ∂P which is not isotopic to an attaching circle for Y is a longitude for γ). Thus, the multiplicity with which β_2 appears in ∂P can be interpreted as the linking number of γ with μ , which we assumed to vanish. But this multiplicity is given by $n_w(P) - n_z(P)$.

In view of these remarks, it suffices to verify that

$$(20) \quad \langle c_1(\underline{\mathfrak{s}}_m(\mathbf{x}), [F]) \rangle = \langle c_1(\underline{\mathfrak{s}}_m(\mathbf{y}), [F']) \rangle,$$

for two particular intersection points \mathbf{x}, \mathbf{y} , which can be connected by a triangle $\psi \in \pi_2(\mathbf{x}, \Theta, \mathbf{y})$ with $n_w(\psi) = n_z(\psi) = 0$ (by appealing to Lemma 2.5). Indeed, it suffices to consider the case where the the point in \mathbf{x} lying on β_2 is a small perturbation of the point on \mathbf{y} lying on γ_2 (recall here that γ_2 is a small perturbation of β_2). It is easy to see that ψ induces a triangle $\psi' \in \pi_2(\mathbf{x}', \Theta, \mathbf{y}')$, and hence a Spin^c structure on the cobordism from $Y_0(K)$ to $Y_0'(K')$ whose restrictions to $Y_0(K)$ and $Y_0'(K')$ are $\mathfrak{s}_w(\mathbf{x}')$ and $\mathfrak{s}_w(\mathbf{y}')$ respectively. Since $[\widehat{F}]$ and $[\widehat{F}']$ are homologous in this cobordism (again, we are using the fact that the linking number of γ with K vanishes), Equation (20) follows at once, and hence also Equation (19).

As defined, the map clearly respects filtrations. \square

We have now the following easy consequence of these observations, as combined with the long exact sequences of [18]. Note that in the following statement, we let

$$\widehat{HFK}(Y, K, m) = \bigoplus_{\{\mathfrak{t} \in \text{Spin}^c(Y, K) \mid \langle c_1(\mathfrak{t}), [\widehat{F}] \rangle = 2m\}} \widehat{HFK}(Y, K, \mathfrak{t}).$$

Theorem 8.2. *Let (Y, K) be a knot, and γ be a framed knot in $Y - K$. Then, by choosing all Seifert surfaces compatibly, the counts of holomorphic triangles give a long exact sequence for each integer m :*

$$\dots \longrightarrow \widehat{HFK}(Y_{-1}(\gamma), K, m) \xrightarrow{f_1} \widehat{HFK}(Y_0(\gamma), K, m) \xrightarrow{f_2} \widehat{HFK}(Y, K, m) \xrightarrow{f_3} \dots$$

In cases where the groups are graded (e.g. when Y is a homology sphere), the maps f_1 and f_2 are homogeneous maps which lower the absolute gradings by $\frac{1}{2}$, while f_3 is a sum of homogeneous maps, which are non-increasing in the absolute grading.

Proof. This follows easily from inspecting the proof of the surgery long exact sequence for \widehat{CFK} (see Theorem 9.12 of [18]), and observing that the homotopy equivalences also respect the filtrations, following arguments from Proposition 8.1 above.

Recall that the maps f_1 , f_2 , and f_3 are sums of maps induced by Spin^c structures over the corresponding cobordisms. The statements about gradings now follow immediately from the dimension formula of [19], stated in Equation (12) above. \square

It is not difficult to see that the above theorem generalizes the skein exact sequence stated in the introduction. We return to this point in Section 10.

9. SOME FIBERED EXAMPLES

As an illustration of some of the above techniques, we give some calculations of knot homology groups for some simple (genus one) fibered knots. These calculations, together with basic properties of the knot invariants, allow us to calculate $HF^+(S^1 \times \Sigma_g, \mathfrak{t})$ (and also some other three-manifolds which fiber over the circle), where \mathfrak{t} is some non-torsion Spin^c structure. It is interesting to compare these with Seiberg-Witten results, c.f. [16] and [17], with the quantum cohomology calculations of [3], and also with the “periodic Floer homology” of Hutchings, see [11].

Consider the three-component Borromean rings in S^3 , and fix $m, n \in \mathbb{Z} \cup \{\infty\}$ (indeed, we will typically consider $m, n \in \{0, 1, \infty\}$). Perform m -surgery on one component, n -surgery on another, and let $B(m, n)$ denote the remaining component, thought of as knot in the surgered three-manifold. Thus, $B(m, n)$ is a null-homologous knot inside $L(m, 1) \# L(n, 1)$ (with the understanding that $L(0, 1) \cong S^2 \times S^1$ and $L(1, 1) \cong S^3$). By Kirby calculus, one can see that $B(1, 1) \subset S^3$ is diffeomorphic to the right-handed trefoil knot, and $B(m, \infty) \subset L(m, 1)$ is an unknot.

In general, $L(m, 1) \# L(n, 1) - B(m, n)$ is diffeomorphic to the mapping torus of an automorphism of the torus with a disk removed $T^2 - D$. In particular, the complement $(S^2 \times S^1) - B(0, 0)$ is diffeomorphic to the product of a circle with $T^2 - D$, and $(S^2 \times S^1) - B(1, 0)$ is the mapping torus of a non-separating Dehn twist acting on $T^2 - D$.

Remark 9.1. *In the following three-manifolds Y , there is a unique $\mathfrak{t} \in \text{Spin}^c(Y)$ with trivial first Chern class (and indeed, it is clear that $\widehat{HF}(Y, \mathfrak{s}) = 0$ for all other Spin^c structures). Thus, there is no ambiguity in writing $\widehat{HFK}(Y, K, j)$ to denote $\widehat{HFK}(Y, K, \mathfrak{t}_j)$, where $\mathfrak{t}_j \in \text{Spin}^c(Y, K)$ is characterized by the fact that it extends \mathfrak{t} , and satisfies $\langle c_1(\mathfrak{t}_j), [\widehat{F}] \rangle = 2j$.*

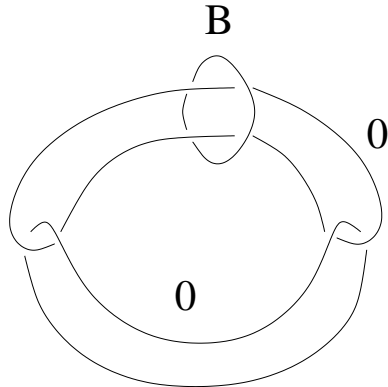

FIGURE 16. A Kirby calculus picture of the “Borromean knot” $B \subset \#^2(S^2 \times S^1)$.

Proposition 9.2. *The knot homology groups \widehat{HFK} of Borromean knots are given by:*

$$\begin{aligned} \widehat{HFK}(S^3, B(1, 1), j) &\cong \begin{cases} \mathbb{Z}_{(0)} & \text{if } j = 1 \\ \mathbb{Z}_{(-1)} & \text{if } j = 0 \\ \mathbb{Z}_{(-2)} & \text{if } j = -1 \\ 0 & \text{otherwise} \end{cases} \\ \widehat{HFK}(S^2 \times S^1, B(0, 1), j) &\cong \begin{cases} \mathbb{Z}_{(\frac{1}{2})} & \text{if } j = 1 \\ \mathbb{Z}_{(-\frac{1}{2})}^2 & \text{if } j = 0 \\ \mathbb{Z}_{(-3/2)} & \text{if } j = -1 \\ 0 & \text{otherwise} \end{cases} \\ \widehat{HFK}(\#^2(S^2 \times S^1), B(0, 0), j) &\cong \begin{cases} \mathbb{Z}_{(1)} & \text{if } j = 1 \\ \mathbb{Z}_{(0)}^2 & \text{if } j = 0 \\ \mathbb{Z}_{(-1)} & \text{if } j = -1 \\ 0 & \text{otherwise} \end{cases} \end{aligned}$$

Proof. The first isomorphism follows immediately from the trefoil calculation from Subsection 6.1.

The calculation of \widehat{HFK} for $B(0, 1)$ could be made in the same spirit – by reducing to a genus one Heegaard diagram for $S^2 \times S^1$. Alternatively, one can use the long exact sequence of Theorem 8.2:

$$\widehat{HFK}(S^3, B(1, \infty), j) \xrightarrow{f_1} \widehat{HFK}(S^2 \times S^1, B(1, 0), j) \xrightarrow{f_2} \widehat{HFK}(S^3, B(1, 1), j) \xrightarrow{f_3} \dots$$

Since $B(1, \infty) \subset S^3$ is an unknot, $\widehat{HFK}(S^3, B(1, \infty), j) = 0$ when $j \neq 0$. Moreover the map f_2 lowers degree by $1/2$ (c.f. Equation (12)). Thus, the calculation of $\widehat{HFK}(S^2 \times S^1, B(1, 0), j)$ for $j \neq 0$ is complete.

In the case where $j = 0$, of course,

$$\widehat{HFK}(S^3, B(1, \infty), 0) \cong \mathbb{Z}_{(0)} \quad \text{and} \quad \widehat{HFK}(S^3, B(1, 1), 0) \cong \mathbb{Z}_{(-1)},$$

while the map f_3 is non-increasing in grading. Thus, it must vanish identically, and, since f_1 also lowers degree by $\frac{1}{2}$, the computation of $\widehat{HFK}(S^3, B(1, 0), j)$ for all j is complete.

For $B(0, 0)$, we now have

$$(21) \quad \widehat{HFK}(S^2 \times S^1, B(0, \infty), j) \xrightarrow{f_1} \widehat{HFK}(\#^2(S^2 \times S^1), B(0, 0), j) \xrightarrow{f_2} \widehat{HFK}(S^2 \times S^1, B(0, 1), j) \xrightarrow{f_3} \dots$$

Thus, the case where $j \neq 0$ follows exactly as before.

Before continuing the calculation when $j = 0$, it is useful to make some observations. Specifically, recall that

$$\bigoplus_j \widehat{HFK}(\#^2(S^2 \times S^1), B(0, 0), j)$$

is the homology of the graded object associated to a filtration of $\widehat{HF}(\#^2(S^2 \times S^1))$. Thus, since $\widehat{HFK}(\#^2(S^2 \times S^1), B(0, 0), j) = 0$ for $j < -2$, we obtain a natural map

$$\mathbb{Z}_{(-1)} \cong \widehat{HFK}(\#^2(S^2 \times S^1), B(0, 0), -1) \longrightarrow \widehat{HF}(\#^2(S^2 \times S^1)) \cong \mathbb{Z}_{(-1)} \oplus \mathbb{Z}_{(0)}^2 \oplus \mathbb{Z}_{(1)}.$$

We claim that this map actually induces an isomorphism onto the $\mathbb{Z}_{(-1)}$ factor on the right-hand-side. This follows immediately from the following commutative diagram:

$$\begin{array}{ccc} \widehat{HFK}(S^3, B(-1, -1), -1) & \xrightarrow{\cong} & \widehat{HF}(S^3) \cong \mathbb{Z}_{(0)} \\ f \downarrow & & g \downarrow \\ \widehat{HFK}(\#^2(S^2 \times S^1), B(0, 0), -1) & \xrightarrow{i} & \widehat{HF}(\#^2(S^2 \times S^1)), \end{array}$$

where here the two horizontal maps are induced by inclusions, the fact that the first is an isomorphism follows readily from the calculation of $B(1, 1)$, while the vertical maps f and g are induced by the obvious cobordisms (here g is induced by the two-handle additions, and f is the induced map on the knot complex). In particular, it is a straightforward calculation that (c.f. [19]) that g induces an isomorphism to $\widehat{HF}_{(-1)}(\#^2(S^2 \times S^1)) \cong \mathbb{Z}$. It follows that i is an isomorphism for degree -1 , as claimed.

We return now to the calculation of $\widehat{HFK}(\#^2(S^2 \times S^1), j)$ when $j = 0$. Recall that $\widehat{HFK}(S^2 \times S^1, B(0, \infty), 0) \cong \mathbb{Z}_{(-1/2)} \oplus \mathbb{Z}_{(1/2)}$, and of course $\widehat{HFK}(S^2 \times S^1, B(0, 1), j) \cong \mathbb{Z}_{(-1/2)}^2$. Verifying the calculation thus reduces to showing that f_3 (from Long Exact Sequence (21)) surjects onto the $\mathbb{Z}_{(-1/2)}$ summand of $\widehat{HFK}(S^2 \times S^1, B(0, \infty), 0)$. If it did not, the map would have to have cokernel, and hence the rank (over possibly some finite field) of

$$G = \bigoplus_j \widehat{HFK}_{-1}(\#^2(S^2 \times S^1), B(0, 0), j)$$

would be two. But this is impossible: we have already shown that $\widehat{HFK}(\#(S^2 \times S^1), B(0, 0), -1)$ represents a generator for $\widehat{HF}_{-1}(\#^2(S^2 \times S^1))$. It also follows from the previous calculation that $\widehat{HFK}(\#^2(S^2 \times S^1))$ is supported in dimension 1, so the remaining generator must come from $\widehat{HFK}_{-1}(\#^2(S^2 \times S^1), 0)$. Indeed, by dimension reasons, this generator cannot be killed by any higher differential (in the spectral sequence connecting $\widehat{HFK}(\#^2(S^2 \times S^1), B(0, 0))$ to $\widehat{HF}(\#^2(S^2 \times S^1))$), and hence contradicting the fact that $\widehat{HF}_{-1}(\#^2(S^2 \times S^1)) \cong \mathbb{Z}$. \square

We would like to use the above calculations to calculate HF^+ of a number of three-manifolds. Indeed, the manifolds we will consider have positive first Betti number, and in this case, it is interesting to obtain information of Floer homology as a module over the ring $\mathbb{Z}[U] \otimes_{\mathbb{Z}} \Lambda^* H_1(Y; \mathbb{Z}) / \text{Tors}$ (c.f. Subsection 4.2.5 of [20]). We pause now to recall the construction of this action.

Given a curve γ in a Heegaard surface for Y which is disjoint from all the $\alpha_i \cap \beta_j$, the action of the corresponding class $[\gamma] \in H_1(Y; \mathbb{Z})$ is induced by the chain map

$$A_\gamma: CF^\infty(Y) \longrightarrow CF^\infty(Y)$$

which decreases absolute degree by one, and is defined by

$$A_\gamma[\mathbf{x}, i] = \sum_{\mathbf{y}} \sum_{\{\phi \in \pi_2(\mathbf{x}, \mathbf{y}) \mid \mu(\phi)=1\}} \#\widehat{\mathcal{M}}(\phi) \cdot \langle \gamma, \phi \rangle \cdot [\mathbf{y}, i - n_w(\phi)],$$

where here $\langle \gamma, \phi \rangle$ is the intersection number of the restriction of

$$\phi: [0, 1] \times \mathbb{R} \longrightarrow \text{Sym}^g(\Sigma)$$

to $\{1\} \times \mathbb{R}$ (where it maps into \mathbb{T}_α) with the subset of $(\gamma \times \text{Sym}^{g-1}(\Sigma)) \cap \mathbb{T}_\alpha$ (c.f. Section 4.2.5 of [20]). We can obviously extend this to $CFK^\infty(Y, K)$ by defining

$$A_\gamma[\mathbf{x}, i, j] = \sum_{\mathbf{y}} \sum_{\{\phi \in \pi_2(\mathbf{x}, \mathbf{y}) \mid \mu(\phi)=1\}} \#\widehat{\mathcal{M}}(\phi) \cdot \langle \gamma, \phi \rangle \cdot [\mathbf{y}, j - n_w(\phi), j - n_z(\phi)],$$

so that it respects the filtration (and indeed, it is not hard to see that the filtered chain homotopy type of the induced map A_γ is an invariant of the knot K , as well). In particular, this induces also an action, which we denote by A_γ^0 on $\widehat{HF\overline{K}}(Y, K)$. In both examples $(Y, K) = (S^2 \times S^1, B(0, 1))$ and $(\#^2(S^2 \times S^1), B(0, 0))$ calculated above, for each fixed integer j , $\widehat{HF\overline{K}}(Y, K, j)$ is concentrated in a single degree, so it follows at once that the action A_γ^0 is trivial. In these cases, there are higher maps, for example

$$A_\gamma^1: \widehat{HF\overline{K}}(K, j) \longrightarrow \widehat{HF\overline{K}}(K, j - 1),$$

which count ϕ with $n_w(\phi) = 0$ and $n_z(\phi) = 1$ (weighted, once again, by $\langle \gamma, \phi \rangle$).

We can use Proposition 9.2 to obtain information about HF^+ for some simple three-manifolds which fiber over the circle. We begin with the case where the monodromy is trivial. The key point for these calculations is that if we perform zero-surgery on the knot $\#^g B(0, 0) \subset \#^{2g}(S^2 \times S^1)$, then we get the three-manifold $\Sigma_g \times S^1$.

We now explain the notation required to state the following result. Fix an integer k , and let $HF^+(\Sigma_g \times S^1, k)$ denote the summand of $HF^+(\Sigma \times S^1)$ corresponding to the Spin^c structure \mathfrak{s} with

$$\langle c_1(\mathfrak{s}), [\Sigma_g] \rangle = 2k, \quad \text{and} \quad \langle c_1(\mathfrak{s}), \gamma \times S^1 \rangle = 0$$

for all curves $\gamma \subset \Sigma_g$ (of course, HF^+ is trivial on Spin^c structures which do not satisfy this latter condition, by the adjunction inequality).

Next, for integers g and d , consider the group

$$(22) \quad X(g, d) = \bigoplus_{i=0}^d \Lambda^{2g-i} H^1(\Sigma_g) \otimes_{\mathbb{Z}} (\mathbb{Z}[U]/U^{d-i+1}).$$

This can be viewed as a module over the ring $\mathbb{Z}[U] \otimes_{\mathbb{Z}} \Lambda^* H_1(\Sigma_g)$, where the action of $\gamma \in H_1(\Sigma_g)$ is given by

$$(23) \quad D_\gamma(\omega \otimes U^j) = (\iota_\gamma \omega) \otimes U^j + \text{PD}(\gamma) \wedge \omega \otimes U^{j+1},$$

where here

$$\iota_\gamma: \Lambda^i H^1(\Sigma_g) \longrightarrow \Lambda^{i-1} H^1(\Sigma_g)$$

denotes the contraction homomorphism (and U acts in the obvious way). In fact, we can endow $X(g, d)$ with a relative grading so that multiplication by U lowers degree by two, and D_γ lowers degree by one. It is interesting to note that if $\text{Sym}^d(\Sigma)$ denotes the d -fold symmetric product of Σ , then

$$(24) \quad X(g, d) \cong H_*(\text{Sym}^d(\Sigma_g))$$

as relatively graded groups, according to MacDonald, c.f. [14]. Indeed, $H_*(\text{Sym}^d(\Sigma_g))$ is naturally a module over $\mathbb{Z}[U] \otimes_{\mathbb{Z}} \Lambda^* H_1(\Sigma_g)$, where U acts as cap product with the Poincaré dual of $\{x\} \times \text{Sym}^{d-1}(\Sigma)$, and also $H_1(\Sigma_g) \cong H^1(\text{Sym}^d(\Sigma_g))$ acts by cap product with one-dimensional cohomology. With this action, the isomorphism of Equation (24) is given as $\mathbb{Z}[U] \otimes_{\mathbb{Z}} \Lambda^* H_1(\Sigma_g)$ -modules, again following [14].

Of course, $HF^+(\Sigma \times S^1)$ is also a module over $\mathbb{Z}[U] \otimes_{\mathbb{Z}} \Lambda^* H_1(\Sigma \times S^1)$ and hence, under the natural inclusion $H_1(\Sigma)$ in $H_1(\Sigma \times S^1)$, it can be viewed as a module over $\mathbb{Z}[U] \otimes_{\mathbb{Z}} \Lambda^* H_1(\Sigma_g)$ (in fact, the following proof also shows that the circle factor in $\Sigma \times S^1$ annihilates $HF^+(\Sigma \times S^1, \mathfrak{s})$, provided $c_1(\mathfrak{s}) \neq 0$).

It is very suggestive to compare the results on the module structure with the quantum cohomology ring calculations of the d -fold symmetric product of Σ obtained by Bertram and Thaddeus [3].

Theorem 9.3. *Fix an integer $k \neq 0$. Then, there is an identification of \mathbb{Z} -modules*

$$(25) \quad HF^+(\Sigma \times S^1, k) \cong X(g, d),$$

where

$$d = g - 1 - |k|.$$

(Of course, the group is trivial if $|k| > g - 1$). Indeed, there is a filtration on $HF^+(\Sigma \times S^1, k)$ as a $\mathbb{Z}[U] \otimes_{\mathbb{Z}} \Lambda^* H_1(\Sigma)$ -module with the property that the identification of Equation (25) is an isomorphism between the associated graded modules. Indeed, when $3d < 2g - 1$, there is an isomorphism as in Equation (25) on the level of $\mathbb{Z}[U] \otimes_{\mathbb{Z}} \Lambda^* H_1(\Sigma)$ -modules.

Proof. In view of the conjugation symmetry, it suffices to consider the case where $k > 0$.

First, note that it follows from the calculation of $\widehat{HF\widehat{K}}$ for $B(0, 0)$ given in Proposition 9.2 and Corollary 7.2 that $\widehat{HF\widehat{K}}(\#^{2g}(S^2 \times S^1), \#^g B(0, 0), j)$ is a free \mathbb{Z} -module of

rank $\binom{2g}{g+j}$ supported entirely in grading j . More invariantly, we can write

$$(26) \quad \widehat{HFK}(\#^{2g}(S^2 \times S^1), \#^g B(0, 0), j) \cong \Lambda^{g+j} H^1(\Sigma_g; \mathbb{Z})_{(j)}$$

(where as usual the subscript (j) denotes the absolute grading of the corresponding group).

Now we can view $CFK^\infty(Y)$ as a \mathbb{Z} -filtered subcomplex, by defining the filtration level of $[\mathbf{x}, i, j] = i + j$. And hence, we obtain a spectral sequence whose E_1 term is $\mathbb{Z}[U, U^{-1}] \otimes_{\mathbb{Z}} \widehat{HFK}(Y, K)$, converging to $HFK^\infty(Y)$. Moreover, as the above calculations show, the filtration (on the E_1 term) is proportional to the absolute degree of each group, so the spectral sequence collapses after the E_2 stage. The same remarks apply to the complexes $CFK^{0,*}$ and $CFK^{*,0}$, as well. Indeed, we argue that the d_2 differentials vanish, as well. This follows immediately from the observations that $CFK^{0,*}$ and $CFK^{*,0}$ must both calculate $\widehat{HF}(\#^{2g}(S^2 \times S^1))$, so for dimension reasons, all higher differentials must vanish. It also follows readily that

$$H_*(C\{i \geq 0 \text{ or } j \geq k\}) \cong H\{i \geq 0 \text{ or } j \geq k\},$$

where we have adopted the convention that $H\{i \geq 0 \text{ or } j \geq k\}$ denotes the quotient module of $H_*(C)$ by the submodule of $H_*(C\{i \leq 0 \text{ and } j \leq k\})$. (We use this notation later in this proof, as well.)

We claim that with respect to the induced identification

$$HF^\infty(\#^{2g}(S^2 \times S^1), \#^g B(0, 0)) \cong \Lambda^* H^1(\Sigma_g; \mathbb{Z}) \otimes_{\mathbb{Z}} \mathbb{Z}[U, U^{-1}],$$

the action of

$$\mathbb{Z}[U] \otimes_{\mathbb{Z}} \Lambda^* H_1(\#^{2g}(S^2 \times S^1)) \cong \mathbb{Z}[U] \otimes_{\mathbb{Z}} \Lambda^* H_1(\Sigma)$$

is the action D_γ defined above. (Note that the induced action A_γ^0 is trivial, A_γ^1 is given by the map D_γ above, and all higher actions vanish for dimension reasons.)

To see why this is true, we proceed as follows. We restrict to a ‘‘vertical slice’’

$$\widehat{HFK}(\#^{2g}(S^2 \times S^1), \#^g B(0, 0)) \cong \Lambda^* H^1(\Sigma_g; \mathbb{Z}) \cong \widehat{HF}(\#^{2g}(S^2 \times S^1)),$$

where here as usual we view $CFK^{0,*}(\#^{2g}(S^2 \times S^1), \#^g B(0, 0))$ as a filtration for $\widehat{CF}(\#^{2g}(S^2 \times S^1))$, by forgetting about z . In the model for $\widehat{HF}(\#^{2g}(S^2 \times S^1)) \cong \Lambda^* H^1(\Sigma_g; \mathbb{Z})$, the action by γ is given by ι_γ (compare Section 3 of [18]). This verifies that if

$$\omega \otimes U^j \in \Lambda^{2g-i} H^1(\Sigma_g) \otimes_{\mathbb{Z}} (\mathbb{Z}[U]/U^{d-i+1}),$$

then the component of $A_\gamma(\omega \otimes U^j)$ in $\Lambda^{2g-i-1} H^1(\Sigma_g) \otimes_{\mathbb{Z}} (\mathbb{Z}[U]/U^{d-i+1})$ – the ‘‘vertical component’’ – is given by $D_\gamma(\omega \otimes U^j)$. For the component in $\Lambda^{2g-i+1} \otimes_{\mathbb{Z}} (\mathbb{Z}[U]/U^{d-i+1})$, we consider now $\widehat{CFK}^{*,0}(\#^{2g}(S^2 \times S^1), \#^g B(0, 0))$ as a filtration of $\widehat{CF}(\#^{2g}(S^2 \times S^1))$,

by forgetting about w . In this model,

$$\widehat{HF}(\#^{2g}(S^2 \times S^1)) \cong \bigoplus_j \Lambda^{g+j} H^1(\Sigma_g; \mathbb{Z}) \otimes U^j.$$

Now, the the action of γ is forced to be given by the map

$$(\omega \otimes U^j) \mapsto \text{PD}(\gamma) \wedge \omega \otimes U^{j+1},$$

verifying that the D_γ describes the horizontal component of A_γ . Since A_γ decreases dimension by one, there are no other components to be verified.

Let Y_n denote the three-manifold obtained by performing $+n$ surgery along B . This manifold is, in fact, the total space of a circle bundle over Σ with Euler number n . It follows from the above remarks, together with Theorem 4.4 that for large enough n , $HF_{\text{red}}^+(Y_n) = 0$. Indeed, if we consider the cobordism W obtained by the natural two-handle addition, and let $f_1: HF^+(Y_n, \mathfrak{s}_k) \rightarrow HF^+(\#^{2g}(S^2 \times S^1))$ denote the map associated to the Spin^c structure \mathfrak{r} with

$$\langle c_1(\mathfrak{r}), [S] \rangle = 2k + n$$

(where S is obtained by completing the Seifert surface for B inside W), then we see that the kernel of f_1 is given by

$$H\{i < 0, j \geq k\} \cong X(g, d),$$

where $d = g - 1 + |k|$. We claim in fact that the homology of this kernel of f_1 is identified with $HF^+(S^1 \times \Sigma, k)$.

To this end, recall the integer surgeries long exact sequence, according to which we have

$$\dots \xrightarrow{F} HF^+(\#^{2g}(S^1 \times S^2)) \longrightarrow HF^+(S^1 \times \Sigma, k) \xrightarrow{G} HF^+(Y_n, [k]) \longrightarrow \dots,$$

where here the map F is the sum of the maps associated to all the Spin^c structures over the cobordism W . Note also that since $HF_{\text{red}}^+(\#^{2g}(S^1 \times S^2)) = 0$, and $HF_{\text{red}}^+(S^1 \times \Sigma, k) \cong HF^+(S^1 \times \Sigma, k)$ (since $k \neq 0$), it follows that $HF^+(S^1 \times \Sigma_g) \cong \text{Ker} F$. Now, we can write

$$F = f_1 + f_2,$$

where f_1 is the homogeneous map described earlier, and f_2 has lower order, in the sense that if ξ is a homogeneous element of dimension d , then $f_2(\xi)$ is a sum of elements of dimension less than $f_1(\xi)$. More concretely, according to Equation (12), if ξ supported in a single dimension, then so is $f_1(\xi)$, and $f_2(\xi)$ can be written as a sum of terms, all of which are supported in dimension at least $2k$ smaller than the dimension of $f_1(\xi)$.

In this setting, there is an identification $A = \text{Ker} f_1$ with $B = \text{Ker} F$, as \mathbb{Z} -modules. To see this, let

$$R_1: H\{i \geq 0\} \longrightarrow H\{i \geq 0 \text{ or } j \geq k\}$$

denote the natural inclusion. Since f_2 has lower order than f_1 , it is easy to see that there is an injective \mathbb{Z} -linear map

$$\Pi: \text{Ker}(f_1 + f_2) \longrightarrow \text{Ker}(f_1),$$

given by taking the an element $\xi \in A$ to its homogeneous term in the highest degree, and hence, $\text{rk}(B) \geq \text{rk}(A)$. In the other direction, consider the map

$$(27) \quad R = \sum_{i=0}^{\infty} (-R_1 \circ f_2)^i.$$

Since R is non-increasing in the filtration induced by the absolute grading, while f_2 is strictly decreasing in this filtration (and, of course, this filtration is bounded below), it follows that $R(\xi)$ is well-defined for any ξ . Indeed, it is easily seen that R defines an injection from A to B , and hence, their ranks agree.

To analyze the $\mathbb{Z}[U] \otimes_{\mathbb{Z}} \Lambda^* H_1(\Sigma)$ -module structure, we proceed as follows. Of course, the filtration mentioned in the statement of the theorem is induced by identifying $HF^+(S^1 \times \Sigma) = \text{Ker}F \subset HF^+(Y_n)$, and noting that the latter group has a filtration induced by absolute grading. The first assertion about the module structure is clear, now. For the second, observe that in general neither the maps Π nor R are module homomorphisms. However, the restriction of R_1 to $X = H\{i \geq 0 \text{ and } j < k\}$ does respect the module structure (as does f_2 , since it is induced by a cobordism). In fact, since in our case, the absolute degree of $H\{i, j\}$ is given by $i + j$, it follows that any element of $HF^+(\#^{2g}(S^2 \times S^1))$ with degree $< g - k$ is contained in X . Since the maximal dimension of any element of $H\{i < 0 \text{ and } j \geq k\}$ is $g - 2$, and f_2 decreases absolute degree by at least $2k$, the inequality $2g - 1 > 3d$ implies that f_2 maps $H\{i < 0 \text{ and } j \geq k\}$ into X , and hence R is a module homomorphism and hence also an isomorphism. \square

More generally, let ϕ be an automorphism of Σ_g , and let M_ϕ denote the mapping torus of ϕ ,

$$M_\phi \cong \frac{[0, 1] \times \Sigma_g}{(0, x) \sim (1, \phi(x))}.$$

When ϕ can be written as a product of disjoint non-separating Dehn twists, one can use the above techniques to calculate $HF^+(M_\phi, k)$ in many cases. We content ourselves here with a calculation in the case where ϕ is a single negative Dehn twist along a non-separating simple, closed curve $\gamma \subset \Sigma$.

To this end, we define another differential on $X(g, d)$. Write $\Sigma = T \# \Sigma'$, where T is a torus and $\gamma \subset T$ is a non-separating simple, closed curve in T . Let

$$\begin{aligned} \Lambda_+^* H^1(\Sigma) &= (\Lambda^0 H^1(T) \otimes_{\mathbb{Z}} \Lambda^*(\Sigma')) \oplus (\Lambda^2 H^1(T) \otimes_{\mathbb{Z}} \Lambda^*(\Sigma')) \\ \Lambda_-^* H^1(\Sigma) &= \Lambda^1 H^1(T) \otimes_{\mathbb{Z}} \Lambda^*(\Sigma'), \end{aligned}$$

so that $\Lambda^* H^1(\Sigma) = \Lambda_+^* H^1(\Sigma) \oplus \Lambda_-^* H^1(\Sigma)$. Let $X(g, d) = X_+(g, d) \oplus X_-(g, d)$ be the corresponding splitting. We define D'_γ so that

$$(28) \quad D'_\gamma|_{X_+(g, d)} \equiv 0 \quad \text{and} \quad D'_\gamma|_{X_-(g, d)} \equiv D_\gamma|_{X_-(g, d)}$$

Theorem 9.4. *Let ϕ denote a negative Dehn twist along a non-separating simple, closed curve $\gamma \subset \Sigma$, and let M_ϕ denote its mapping torus. For each integer k , let $HF^+(M_\phi, k)$ denote HF^+ of M_ϕ evaluated on the Spin^c structure \mathfrak{s} characterized by the properties that $\langle c_1(\mathfrak{s}), [F] \rangle = 2k$ and $c_1(\mathfrak{s})$ vanishes on all homology classes represented by tori. Suppose that $0 \neq k$ and also suppose that*

$$(29) \quad 3d < 2g - 1,$$

where $d = g - 1 - |k|$. Then, there is an isomorphism of $\mathbb{Z}[U] \otimes_{\mathbb{Z}} \Lambda^* H_1(\Sigma)$ -modules

$$(30) \quad HF^+(M_\phi, k) \cong H_*(X(g, d), D'_\gamma),$$

where D'_γ is the differential defined by Equation (28). When, Equation (29) does not hold, we still obtain an isomorphism of the form stated in Equation (30), as \mathbb{Z} -modules.

Proof. If ϕ is a negative Dehn twist along γ , then we can realize M_ϕ as zero-surgery along the connected sum $B(0, 1) \# (\#^{g-1} B(0, 0))$. We adopt the notation from the proof of Theorem 9.3 before. Note that \widehat{HFK} of $B(0, 0)$ and $B(0, 1)$ differ by only a shift in dimension, so it is still the case that the knot filtration is proportional to the absolute degree, so the spectral sequence collapses after the E_2 stage. There is one crucial difference now: it is no longer the case that the d_2 differential is trivial. Indeed, since $\widehat{HFK}(S^2 \times S^1, B(0, 1))$ is the homology of the graded object associated to a filtration of $\widehat{CF}(S^2 \times S^1)$, and

$$\widehat{HF}(S^2 \times S^1) \cong \mathbb{Z}_{(-\frac{1}{2})} \oplus \mathbb{Z}_{(\frac{1}{2})},$$

it follows that the d_2 differential is non-trivial; indeed, the map

$$d_2: \mathbb{Z}_{(-\frac{1}{2})}^2 \cong \widehat{HFK}(S^2 \times S^1, B(0, 1), 0) \longrightarrow \widehat{HFK}(S^2 \times S^1, B(0, 1), -1) \cong \mathbb{Z}_{(-3/2)}$$

surjects. In the notation from the theorem, we can write this as the map $H^1(T^2) \longrightarrow H^0(T^2)$ given by evaluation against $[\gamma]$ (i.e. this is the ‘‘horizontal component’’ of D'_γ).

We now proceed as before, now letting H denote the homology of C with respect to the d_1 differential. Thus, the group $H\{i < 0, j \geq k\} \cong X(g, d)$, which is the kernel of f_1 , is now endowed with the d_2 differential induced by D'_γ . (The fact that this differential is given by D'_γ follows the proof of Theorem 9.3, in the calculation of the module $\mathbb{Z}[U] \otimes_{\mathbb{Z}} \Lambda^* H_1(\Sigma_g)$ -module structure of $HF^+(\Sigma \times S^1, k)$. In particular, it follows from dimension reasons, followed by a consideration of the filtration $CFK^{*,0}(S^2 \times S^1, B(0, 1))$ of $\widehat{CF}(S^2 \times S^1)$.)

We once again consider the integral surgeries long exact sequence, and let Y_n denote the three-manifold obtained by large n surgery on the link $B(1, 0) \#^{g-1} B(0, 0)$, and

identify $HF^+(M_\phi, k) \cong H_*(\text{Ker}(f_1 + f_2), d_2)$. Proceeding as before, we construct the identification of $\text{Ker}(f_1 + f_2)$ with $\text{Ker}(f_1)$, by considering the map R defined as in Equation (27). The inequality $3d < 2g - 1$ now ensures that R is a chain map, using the d_2 differential (and hence also an isomorphism of chain complexes).

For the final remark, when Equation (29) is violated, we still observe that the map induced by f_1 is surjective on homology. We then appeal to the same argument as in Corollary 4.5. \square

It follows from the above result that when $g > 2$, $HF^+(M_\phi, g - 2)$ is isomorphic to the relative singular cohomology $H^*(\Sigma, \gamma)$, while $HF^+(M_{\phi^{-1}}, g - 2) \cong H_*(\Sigma - \gamma)$. This should be compared with a result of Seidel [27], see also [11].

10. LINKS

Throughout most of the paper, we assumed that our oriented knot K is connected. In view of Proposition 2.1, passing to the case of oriented links is quite straightforward. Our aim here is to highlight some issues in this generalization, with the aim of showing how the properties of the link invariant stated in the introduction follow from the other results proved above.

As a first point, recall that in some applications, especially to exact sequences (c.f. Section 8), we found it convenient to fix a Seifert surface F for the knot K . Correspondingly, when considering a link L , we also fix a Seifert surface F for L .

Lemma 10.1. *Fix a Seifert surface F for L in Y , and let F' be any extension of F to the zero-surgery of $\kappa(Y)$ along $\kappa(L)$. Then, the group*

$$\widehat{HFK}(Y, L, m) = \bigoplus_{\{\underline{t} \in \underline{\text{Spin}}^c(\kappa(Y), \kappa(L)) \mid \langle c_1(\underline{t}), [F'] \rangle = 2m \}} \widehat{HFK}(Y, L, \underline{t})$$

depends on F' only through the (relative homology class of the) induced Seifert surface F in Y (i.e. it is independent of the extension F').

Proof. The indeterminacy of F' comes from the attached one-handles – more precisely writing $\kappa(Y) = Y \# \#^{n-1}(S^2 \times S^1)$, the indeterminacy amounts to adding homology classes represented by spheres coming from $S^2 \times S^1$, which in turn can be represented by embedded tori in the complement of $\kappa(K)$ inside $\kappa(Y)$. However, it is straightforward to see that if the first Chern class of $\underline{t} \in \underline{\text{Spin}}^c(\kappa(Y))$ evaluates non-trivially on such a homology class, then we can find an admissible Heegaard diagram for the knot $\kappa(L)$ in $\kappa(Y)$ with the property that no intersection point represents \underline{t} . This follows from a straightforward adaptation of the proof of the adjunction inequality for HF^+ (Theorem 7 of [18], see also Theorem 5.1 above) that $\widehat{HFK}(\kappa(Y), \kappa(L), \underline{t}) = 0$. \square

Now, consider the case where Y is an oriented three-manifold, equipped with an oriented link L_+ , and let $\gamma \subset Y$ be an unknot which spans a disk D which meets L in two algebraically cancelling transverse points. Let L_- denote the new link induced from L_- after introducing a full twist, as pictured in Figure 1. In comparing with this picture, the disk D can be thought of as a horizontal disk. Let L_0 denote the new link obtained from L by resolving the link, so that it no longer meets D .

Recall that in Section 8, we chose a Seifert surface F for L , and use it to define the integral splitting of $HFK(Y, L)$ as in Lemma 10.1.

Theorem 10.2. *Let L_+ , L_0 , and L_- be the links related by a skein move as above. Then we have a long exact sequence of the form:*

$$(31) \quad \dots \longrightarrow \widehat{HFK}(Y, L_-) \longrightarrow \widehat{HFK}(Y, L_0) \longrightarrow \widehat{HFK}(Y, L_+) \longrightarrow \dots,$$

while if they belong to different components of L , we have a long exact sequence of the form

$$(32) \quad \dots \longrightarrow \widehat{HFK}(Y, L_-) \longrightarrow \widehat{HFK}(Y', L'_0) \longrightarrow \widehat{HFK}(Y, L_+) \longrightarrow \dots,$$

where here (Y', L'_0) denotes the link obtained by connected sum of (Y, L_0) with the “Borromean knot” $(\#^2(S^2 \times S^1), B(0, 0))$ from Figure 16. Moreover, the maps in the exact sequence respect the \mathbb{Z} -splittings of the homology groups induced from a Seifert surface F for L_+ in Y (and corresponding Seifert surface for L_- and L_0).

Proof. This result is a special case of Theorem 8.2, after some remarks.

First, observe that under the diffeomorphism $Y_{-1}(\gamma) \cong Y$, the image of the link obtained from viewing L_+ as a link in $Y - \gamma \subset Y_{-1}(\gamma)$ is L_- .

Suppose next that both strands of L meeting D belong to the same component of L . In this case, we can trade the zero-framed two-handle attached along γ for a one-handle, without changing the underlying three-manifold $Y_0(\gamma) \cong Y \#(S^2 \times S^1)$. In the case where L had two components, in fact, we see that the knot induced from K then coincides with the knot $\kappa(L_0)$. It is easy to see that in this case, Theorem 8.2 translates into Long Exact Sequence (31).

Suppose next that two strands of L meeting in D belong to different components of L . In fact, for simplicity, we assume that L has two components L_1 and L_2 (indeed, the case where L consists of more than two components can be reduced to this case, after attaching sufficiently many one-handles.) In this case, by definition, the link invariant of L inside $Y_0(\gamma)$ agrees with a knot invariant of the knot induced from $\kappa(L)$ inside $\kappa(Y)_0(\gamma)$. Recall that $\kappa(Y)$ is the three-manifold obtained from Y by attaching a one-handle. We can replace the one-handle in $\kappa(Y)$ by a zero-framed two-handle γ' , to obtain $Y' = Y \#^2(S^2 \times S^1)$ with a new knot K' . It is easy to see

$$(Y', K') = (Y, K) \#(\#^2(S^2 \times S^1), B(0, 0))$$

as claimed, with the knots γ and γ' playing the role of the two zero-framed circles in the Borromean knot, as illustrated in Figure 17. Strictly speaking, to see that the operation is local on the knot K , it is useful to trade the two-handle specified by γ for a three-handle (with the curve γ' running through it), and slide the one-handle freely along K .

With these remarks in hand, we see Long Exact Sequence (32) as a special case of Theorem 8.2. \square

In view of the calculation of $\widehat{HFK}(\#^2(S^2 \times S^1), B(0, 0))$ in Proposition 9.2, together with the Künneth principle for connected sums from Corollary 7.2, we see that the versions of the skein exact sequence given in the introduction coincide with those stated in Theorem 10.2.

The Euler characteristic calculation of \widehat{HFK} stated in Equation (1) is an easy application of the skein exact sequence (though an alternate proof could also be given in

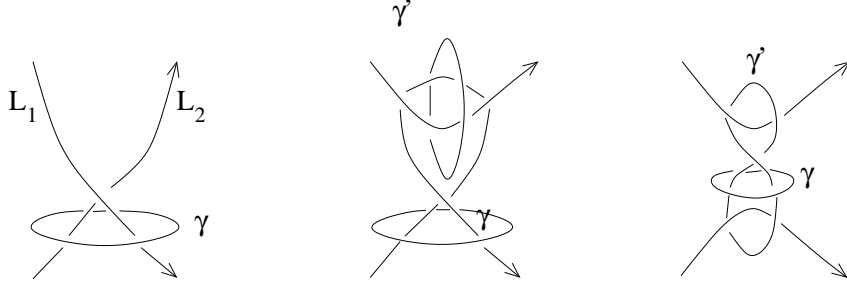

FIGURE 17. **Trading link crossings.** The identification of $(\kappa(Y)_0(\gamma), \kappa(L))$ with $(Y, L_0) \# (S^2 \times S^1, B(0, 0))$.

the spirit of Theorem 5.2 of [18]). More precisely, note that $\widehat{HFK}(S^3, L)$ inherits an absolute $\mathbb{Z}/2\mathbb{Z}$ grading from $\widehat{HF}(\#^{n-1}(S^2 \times S^1))$ (where here n is the number of components of L). As in [22], we see that this grading is preserved by both the map from $\widehat{HFK}(S^3, L_-)$ to $\widehat{HFK}(S^3, L_0)$ and the map from $\widehat{HFK}(S^3, L_+)$ to $\widehat{HFK}(S^3, L_-)$, while it is reversed by the remaining map. It follows from the two skein exact sequences then that if we write

$$\chi(\widehat{HFK}(S^3, L)) = \sum_{i \in \mathbb{Z}} \chi(\widehat{HFK}(S^3, L, i)) \cdot T^i$$

then

$$\chi(\widehat{HFK}(S^3, L_-)) - \chi(\widehat{HFK}(S^3, L_0)) - \chi(\widehat{HFK}(S^3, L_+)) = 0$$

if L_0 has more components than L_+ ; otherwise,

$$\chi(\widehat{HFK}(S^3, L_-)) - (T^{1/2} - T^{-1/2})^2 \cdot \chi(\widehat{HFK}(S^3, L_0)) - \chi(\widehat{HFK}(S^3, L_+)) = 0.$$

Since $\chi(\widehat{HFK}(S^3, u)) = 1$ (when u is the unknot), Equation (1) now follows from the usual skein relation characterization of the Alexander-Conway polynomial. The fact that this absolute $\mathbb{Z}/2\mathbb{Z}$ grading is related to the absolute \mathbb{Q} -grading in the classical case discussed in the introduction follows easily from [22].

Equation (2) follows immediately from Proposition 3.7, Equation (3) follows from Proposition 3.10, Equation (4) follows from Proposition 3.9 (noting that when we pass from K to $-K$, we also must reverse the orientation of the Seifert surface, so $\langle c_1(\mathfrak{s}), [\widehat{F}] \rangle = \langle c_1(J\mathfrak{s}), [-\widehat{F}] \rangle$), and Equation (5) follows from Corollary 7.2.

For the behavior of \widehat{HFK} under disjoint union, note that by definition of the link invariant,

$$\widehat{HFK}(S^3, L_1 \cup L_2) = \widehat{HFK}(S^2 \times S^1, L_1 \# L_2)$$

(where here we think of $L_1 \# L_2$ as supported in a ball in $S^2 \times S^1$). Now, Equation (6) from a straightforward adaptation of the proof that $\widehat{HF}(S^3 \# (S^2 \times S^1)) \cong \widehat{HF}(Y) \otimes H_*(S^1)$ given in [18].

REFERENCES

- [1] S. Akbulut and J. McCarthy. *Casson's invariant for oriented homology 3-spheres – an exposition*. Number 36 in Annals of Mathematics Studies. Princeton University Press, 1990.
- [2] D. Bar-Natan. On Khovanov's categorification of the Jones polynomial. *Algebraic and Geometric Topology*, 2:337–370, 2002.
- [3] A. Bertram and M. Thaddeus. On the quantum cohomology of a symmetric product of an algebraic curve. *Duke Math. J.*, 108(2):329–362, 2001.
- [4] P. Braam and S. K. Donaldson. Floer's work on instanton homology, knots, and surgery. In H. Hofer, C. H. Taubes, A. Weinstein, and E. Zehnder, editors, *The Floer Memorial Volume*, number 133 in Progress in Mathematics, pages 195–256. Birkhäuser, 1995.
- [5] Y. M. Eliashberg and W. P. Thurston. *Confoliations*. Number 13 in University Lecture Series. American Mathematical Society, 1998.
- [6] R. Fintushel and R. J. Stern. Knots, links, and 4-manifolds. *Invent. Math.*, 134(2):363–400, 1998.
- [7] A. Floer. Instanton homology, surgery, and knots. In *Geometry of Low-Dimensional Manifolds, 1 (Durham, 1989)*, volume 150 of *London Math. Soc. Lecture Note Ser.*, pages 97–114, 1990.
- [8] D. Gabai. Foliations and the topology of 3-manifolds. *J. Differential Geom.*, 18(3):445–503, 1983.
- [9] R. E. Gompf and A. I. Stipsicz. *4-manifolds and Kirby calculus*, volume 20 of *Graduate Studies in Mathematics*. American Mathematical Society, 1999.
- [10] J. Hoste. Sewn-up r -link exteriors. *Pacific J. Math.*, 112(2):347–382, 1984.
- [11] M. Hutchings and M. Sullivan. The periodic Floer homology of a Dehn twist. <http://math.berkeley.edu/hutching/pub/index.htm>, 2002.
- [12] M. Khovanov. A categorification of the Jones polynomial. math.QA/9908171, 1999.
- [13] P. B. Kronheimer and T. S. Mrowka. Scalar curvature and the Thurston norm. *Math. Res. Lett.*, 4(6):931–937, 1997.
- [14] I. G. MacDonald. Symmetric products of an algebraic curve. *Topology*, 1:319–343, 1962.
- [15] G. Meng and C. H. Taubes. \underline{SW} -Milnor torsion. *Math. Research Letters*, 3:661–674, 1996.
- [16] J. W. Morgan, Z. Szabó, and C. H. Taubes. A product formula for Seiberg-Witten invariants and the generalized Thom conjecture. *J. Differential Geometry*, 44:706–788, 1996.
- [17] V. Muñoz and B-L. Wang. Seiberg-Witten-Floer homology of a surface times a circle. math.DG/9905050.
- [18] P. S. Ozsváth and Z. Szabó. Holomorphic disks and three-manifold invariants: properties and applications. math.SG/0105202, To appear in *Annals of Math.*
- [19] P. S. Ozsváth and Z. Szabó. Holomorphic triangles and invariants for smooth four-manifolds. math.SG/0110169.
- [20] P. S. Ozsváth and Z. Szabó. Holomorphic disks and topological invariants for closed three-manifolds. math.SG/0101206. To appear in *Annals of Math.*, 2001.
- [21] P. S. Ozsváth and Z. Szabó. Heegaard Floer homologies and contact structures. math.SG/0210127, 2002.
- [22] P. S. Ozsváth and Z. Szabó. Absolutely graded Floer homologies and intersection forms for four-manifolds with boundary. *Advances in Mathematics*, 173(2):179–261, 2003.
- [23] P. S. Ozsváth and Z. Szabó. Heegaard Floer homology and alternating knots. *Geometry and Topology*, 7:225–254, 2003.
- [24] P. S. Ozsváth and Z. Szabó. Knot Floer homology, genus bounds, and mutation. math.GT/0303225, 2003.
- [25] J. Rasmussen. Floer homologies of surgeries on two-bridge knots. math.GT/0204056, 2002.
- [26] J. Rasmussen. *Floer homology and knot complements*. PhD thesis, Harvard University, 2003.
- [27] P. Seidel. The symplectic Floer homology of a Dehn twist. *Math. Res. Lett.*, 3(6):829–834, 1996.

DEPARTMENT OF MATHEMATICS, COLUMBIA UNIVERSITY, NEW YORK 10027
`petero@math.columbia.edu`

DEPARTMENT OF MATHEMATICS, PRINCETON UNIVERSITY, NEW JERSEY 08540
`szabo@math.princeton.edu`