

GEOMETRY OF THE TETRAHEDRON SPACE

ERIC BABSON, PAUL E. GUNNELLS, AND RICHARD SCOTT

ABSTRACT. Let X° be the space of all labeled tetrahedra in \mathbb{P}^3 . In [1] we constructed a smooth symmetric compactification \tilde{X} of X° . In this article we show that the complement $\tilde{X} \setminus X^\circ$ is a divisor with normal crossings, and we compute the cohomology ring $H^*(\tilde{X}; \mathbb{Q})$.

1. INTRODUCTION

In this article we describe the natural stratification and intersection theory of the space \tilde{X} of *complete tetrahedra*, a complex projective variety we constructed in [1] that provides a natural compactification of the variety X° of nondegenerate tetrahedra in \mathbb{P}^3 . The importance of \tilde{X} lies in both its connection to work of Schubert, who described an analogous space for triangles in \mathbb{P}^2 [15] (see also [3, 12, 13, 14]), and its relation to more recently constructed compactifications of configuration varieties [7, 10, 11]. In particular, \tilde{X} provides a natural setting for studying certain enumerative questions, and for studying generalized Schur modules for GL_4 (cf. [9]).

There are several desired properties that guide the construction of a compactification \tilde{V} of a configuration variety V° :

- \tilde{V} should be smooth;
- any group action on V° should extend to an action on \tilde{V} ;
- the complement $\tilde{V} \setminus V^\circ$ should have a natural stratification (ideally it should be a divisor with normal crossings); and
- the cohomology (or intersection) ring of \tilde{V} should have an explicit description in terms of the classes of closures of strata.

The first two properties were verified for the space \tilde{X} of complete tetrahedra in [1]. In the present paper, we show that the last two properties hold as well.

To provide some insight into the space \tilde{X} , we first describe the variety of nondegenerate tetrahedra X° , its canonical singular compactification X , and the divisor at infinity $X \setminus X^\circ$. Given 4 general points P_i ($1 \leq i \leq 4$) in \mathbb{P}^3 , each pair determines a line P_{ij} , and each triple determines a plane P_{ijk} . Thus, the P_i determine a point in

1991 *Mathematics Subject Classification.* 14M99, 14M15.

Key words and phrases. Compactifications of configuration spaces, space of tetrahedra.

Research partially supported by the NSF.

the product

$$(1) \quad (\mathbb{P}^3)^4 \times \mathbb{G}(2, 4)^6 \times (\hat{\mathbb{P}}^3)^4,$$

where $\mathbb{G}(2, 4)$ is the Grassmannian of lines in \mathbb{P}^3 , and $\hat{\mathbb{P}}^3$ is the projective space of hyperplanes in \mathbb{P}^3 . Any such point can be thought of as a nondegenerate tetrahedron, in the sense that it corresponds to a collection of subspaces in \mathbb{P}^3 arranged to form a tetrahedron (Figure 1). We let X° be the subvariety of (1) consisting of all such points.

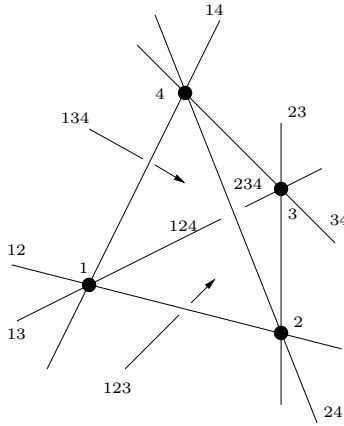

FIGURE 1. A nondegenerate tetrahedron.

By taking the closure of X° in (1), one obtains the *canonical space of tetrahedra* X . The points in $X \setminus X^\circ$ are *degenerate tetrahedra*; that is to say, they correspond to configurations of subspaces that can be obtained as limits of families of nondegenerate tetrahedra. It turns out that, up to symmetry, there are 7 maximal combinatorial types of degenerate tetrahedra parameterized by X (Figures 2 and 3). These types are maximal in the sense that any degenerate tetrahedron in $X \setminus X^\circ$ either has one of these types or can be obtained by a further degeneration of one of these types. If one labels these configurations with subsets of $\{1, 2, 3, 4\}$ as in Figure 1, one finds altogether 23 maximal combinatorial types (namely, $A, B, A^*, C_i, C_i^*, D_{ij}, E_{ij}$). The closure of the locus of all points in X of a given type is an irreducible divisor in X , and the union of these divisors is precisely the complement of X° in X .

The variety X is singular, and the locus of degenerate tetrahedra is relatively complicated. In [1], we constructed a smooth symmetric compactification \tilde{X} of X° that dominates X ; one obtains \tilde{X} by taking the closure of X° in a larger ambient space than (1) (see 2.2). The variety \tilde{X} has the property that the fiber of the map $\tilde{X} \rightarrow X$ over a degenerate tetrahedron of one of the 23 types described above is a single point. Hence, we obtain a collection of irreducible divisors in \tilde{X} by taking proper transforms of the divisors described above. Our first result (Theorem 3.3.2) shows that in the

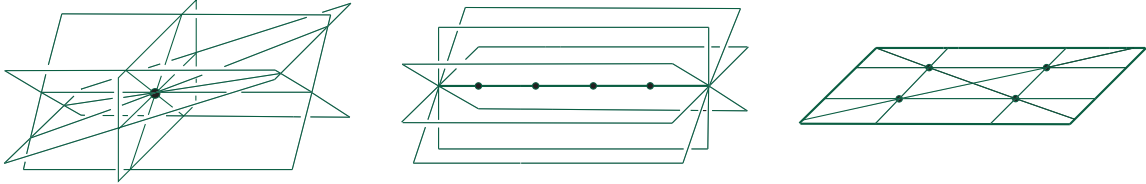

FIGURE 2. The shifting divisors A , B , A^* .

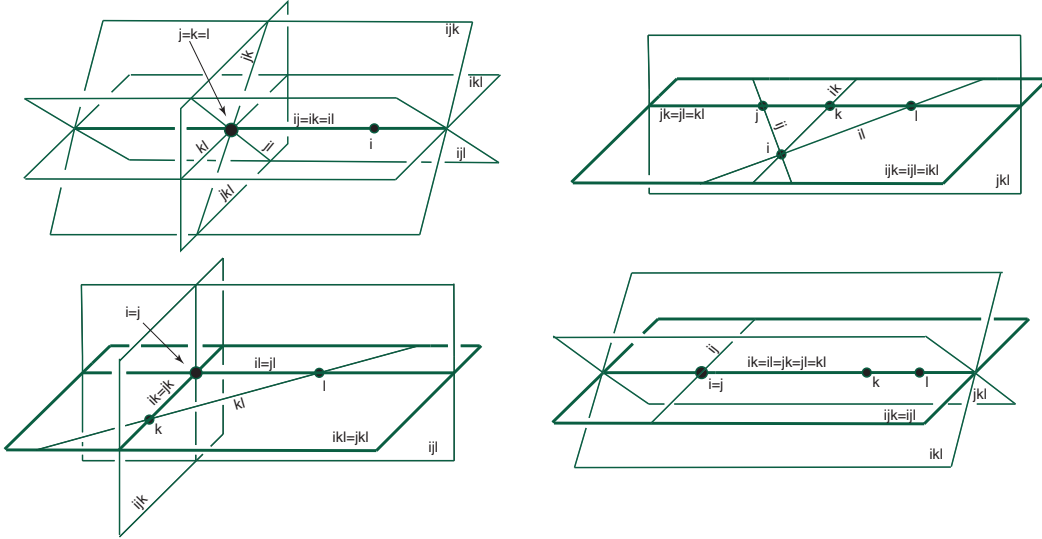

FIGURE 3. The split divisors C_i , C_i^* , D_{ij} , and E_{ij} .

resolution $\tilde{X} \rightarrow X$, no new divisors are introduced, and that furthermore one of our criteria for a good compactification of X° is met:

Theorem. *Let $Z \subset \tilde{X}$ be the union of the 23 irreducible divisors. Then $Z = \tilde{X} \setminus X^\circ$, and is a divisor with normal crossings.*

For each of the 4 points, 6 lines, and 4 planes in a tetrahedron, there is a projection from \tilde{X} to the corresponding Grassmannian; this is simply the composition of $\tilde{X} \rightarrow X$ with projection to the appropriate factor of (1). By pulling back the special Schubert varieties [6, p. 271] via these maps, we obtain additional divisors Y_I in \tilde{X} , where I ranges over all proper nonempty subsets of $\{1, 2, 3, 4\}$. For each I , the divisor Y_I consists of those points in \tilde{X} whose image tetrahedra have their subspace labeled I meeting a given codimension- $|I|$ subspace $W \subset \mathbb{P}^3$. We call these divisors *special position divisors*. Together with the 23 divisors mentioned above, they generate the cohomology ring of \tilde{X} . In fact, the complete ring structure is given by the following presentation (Theorem 5.0.2):

Theorem. *The cohomology ring $H^*(\tilde{X}; \mathbb{Q})$ is generated in degree 2 by the Poincaré duals of the 23 divisors from Figures 2 and 3, and the special position divisors Y_I . If we denote these dual classes by $a, b, a^*, c_i, c_i^*, d_{ij}, e_{ij}, y_i, y_{ij}, y_{ijk}$ (where the indices denote unordered subsets of $\{1, 2, 3, 4\}$), then the ideal of relations is generated by the following polynomials:*

- (i) $y_{ij} - y_i - y_j + a + c_k + c_l + d_{ij} + e_{ij},$
 $y_{ijk} - y_{ij} - y_{ik} + y_i + b + c_i + c_i^* + d_{jk} + e_{jk} + e_{il} + e_{jl} + e_{kl},$
 $y_{ij} - y_{ijk} - y_{ijl} + a^* + c_i^* + c_j^* + d_{kl} + e_{ij}.$
- (ii) $c_i c_j, c_i^* c_j^*, c_i d_{ij}, c_i^* d_{ij}, c_i e_{ij}, c_i^* e_{jk}, d_{ij} e_{ik}, e_{ij} e_{ik}, e_{ij} e_{kl}.$
- (iii) $a(y_i - y_j), b(y_{ij} - y_{ik}), a^*(y_{ijk} - y_{ijl}),$
 $c_i(y_j - y_k), c_i(y_{ij} - y_{ik}), c_i^*(y_{jk} - y_{jl}), c_i^*(y_{ijk} - y_{ijl}),$
 $d_{ij}(y_i - y_j), d_{ij}(y_{ik} - y_{jk}), d_{ij}(y_{ikl} - y_{jkl}),$
 $e_{ij}(y_i - y_j), e_{ij}(y_{kl} - y_{ik}), e_{ij}(y_{ijk} - y_{ijl}).$
- (iv) $y_i^2 + y_{ij}^2 + y_{ijk}^2 - y_i y_{ij} - y_{ij} y_{ijk},$
 $y_{ij}^3 - 2y_i y_{ij}^2 + 2y_i^2 y_{ij},$
 $y_i^4.$

The relations in this presentation all come from simple geometric considerations. Those in (ii), for example, arise because certain pairs of divisors are disjoint in \tilde{X} . The relations in (i) come from rational equivalences induced by rational functions on \tilde{X} corresponding to certain cross-ratios. More details appear in 5.1.

The structure of the paper is as follows. In Section 2, we recall the necessary constructions and results from [1], and state other results we need whose proofs are easy adaptations of results from [1]. The main tool we use throughout this paper is the local description of \tilde{X} given in Theorem 2.3.3. In Section 3, we describe the combinatorial diagrams we use to decompose \tilde{X} into strata, show that the union of the strata of codimension ≥ 1 is a divisor with normal crossings, and show that this decomposition into subvarieties is indeed a stratification. In Section 4 we compute the topological Betti numbers of \tilde{X} by computing the Hasse-Weil zeta function of \tilde{X} and using the Weil conjectures. Finally, in Section 5 we compute the cohomology ring $H^*(\tilde{X}; \mathbb{Q})$. A key step in this computation is the use of the Betti numbers from Section 4 to verify that the list of relations in the above presentation suffices.

2. BACKGROUND

We recall the setup and basic constructions from [1]. Proofs of all the statements in this section can be found in [1] or are straightforward generalizations of results in [1].

2.1. The singular space of tetrahedra. Let $\llbracket 4 \rrbracket$ be the set $\{1, 2, 3, 4\}$. For any proper nontrivial subset $I \subset \llbracket 4 \rrbracket$, we let \mathbf{G}_I denote the Grassmannian of $|I|$ -planes in \mathbb{C}^4 . Let \mathbf{G} be the product

$$\mathbf{G} := \prod_I \mathbf{G}_I,$$

and for any $x \in \mathbf{G}$, let $x_I \in \mathbf{G}_I$ be its image in the I th factor.

Let e_1, \dots, e_4 be the standard basis for \mathbb{C}^4 . For any proper nontrivial subset $I \subset \llbracket 4 \rrbracket$, let $e_I \in \mathbf{G}_I$ be the subspace spanned by $\{e_i \mid i \in I\}$, and let $e \in \mathbf{G}$ be the point $e = (e_I)_{I \subset \llbracket 4 \rrbracket}$. The group $G = \mathrm{SL}_4(\mathbb{C})$ acts diagonally on \mathbf{G} .

Definition 2.1.1. The *space of nondegenerate tetrahedra*, which we denote by X° , is the orbit $G \cdot e \subset \mathbf{G}$. The *(canonical) space of tetrahedra*, denoted by X , is its closure $\overline{G \cdot e} \subset \mathbf{G}$. A point in X° is a *nondegenerate tetrahedron*, a point in X is a *tetrahedron*, and a point in $X \setminus X^\circ$ is a *degenerate tetrahedron*.

Let \mathbf{F} be the variety of full flags in \mathbb{C}^4 .

Proposition 2.1.2.

- *The G -action on \mathbf{G} restricts to an action on X .*
- *The symmetric group S_4 acts on X via the action on \mathbf{G} induced from the natural S_4 action on $\llbracket 4 \rrbracket$.*
- *Each projection $X \rightarrow \mathbf{G}_I$ is a G -equivariant locally trivial fibration.*
- *The projection $X \rightarrow \mathbf{F} \subseteq \mathbf{G}_1 \times \mathbf{G}_{12} \times \mathbf{G}_{123}$ is a G -equivariant locally trivial fibration.*

2.2. The smooth space of tetrahedra. Let $\Delta_1, \Delta_2, \Delta_3$ be the 3-dimensional hypersimplices, with vertices indexed by proper nontrivial subsets $I \subset \llbracket 4 \rrbracket$ (Figure 4). For each such I , we let $F_I \rightarrow X$ be the pull-back of the tautological bundle on \mathbf{G}_I .

The edges of the hypersimplex Δ_i are indexed by pairs $\{I, J\}$ of i -element subsets of $\llbracket 4 \rrbracket$ satisfying $|I \cap J| = i - 1$ and $|I \cup J| = i + 1$. Let \mathcal{E} be the set of all edges of the hypersimplices. For each $\alpha = \{I, J\} \in \mathcal{E}$, we let $P_\alpha \rightarrow X$ be the \mathbb{P}^1 -bundle defined by $\mathbb{P}(F_{I \cup J}/F_{I \cap J})$. Each P_α has canonical sections s_I and s_J defined by $s_I(x) = x_I/x_{I \cap J}$ and $s_J(x) = x_J/x_{I \cap J}$. We let $E_\alpha \rightarrow X$ denote the $\mathbb{P}^1 \times \mathbb{P}^1$ -bundle $P_\alpha \times_X P_\alpha$ with diagonal subbundle $D_\alpha \rightarrow X$. The sections s_I and s_J determine a section $s_I \times s_J$ of E_α which we denote by s_α . The significance of the section s_α is that the preimage of the diagonal D_α is precisely the locus where the I th and J th face of a tetrahedron coincide, i.e., $s_\alpha(x) \in D_\alpha$ if and only if $x_I = x_J$.

Let \mathcal{H} be the set of all hypersimplex faces of dimension ≥ 2 . This set consists of the three 3-dimensional hypersimplices and their 16 triangular faces (Figure 5). For each $\beta \in \mathcal{H}$, we define $E_\beta \rightarrow X$ to be the product bundle $\prod E_\alpha$, where α ranges over edges of β . We let D_β be the corresponding product $\prod D_\alpha$ of diagonals, and we let s_β be the section $\prod s_\alpha$ of $E_\beta \rightarrow X$. As above, we have $s_\beta(x) \in D_\beta$ if and only if $x_I = x_J$ for all vertices $I, J \in \beta$.

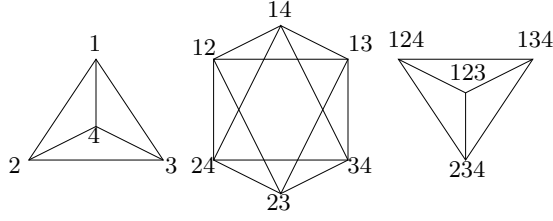
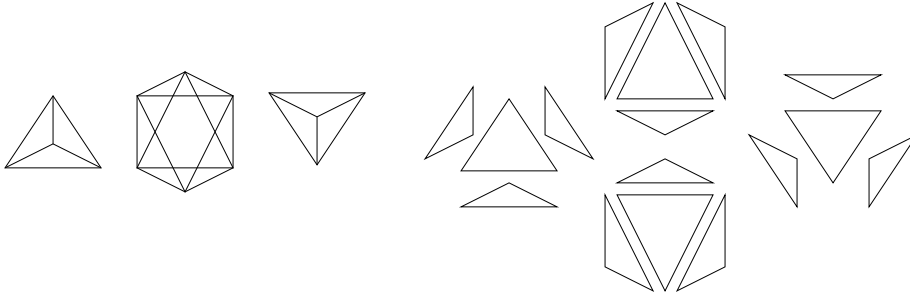

FIGURE 4. The three 3-dimensional hypersimplices.

FIGURE 5. The set \mathcal{H} .

For each $\beta \in \mathcal{H}$, let $(E_\beta)_\# \rightarrow X$ be the blow-up of E_β along the subbundle D_β , and let $E_\# \rightarrow X$ be the product

$$E_\# = \prod_{\beta \in \mathcal{H}} (E_\beta)_\#.$$

The product of the sections s_β induces a rational section $s : X \dashrightarrow E_\#$ whose restriction to the open set X° is regular. We can now define the variety of interest in this paper.

Definition 2.2.1. The *space of complete tetrahedra*, which we denote by \tilde{X} , is the closure of the image of the rational section s , i.e., $\tilde{X} = \overline{s(X^\circ)}$. A point $\tilde{x} \in \tilde{X}$ is a *complete tetrahedron*.

Proposition 2.2.2.

- \tilde{X} is a smooth projective variety.
- There is a natural surjective birational morphism $\tilde{X} \rightarrow X$ defined by restricting the bundle projection $E_\# \rightarrow X$.
- There are natural actions of G and the symmetric group S_4 on \tilde{X} , and the projection $\tilde{X} \rightarrow X$ is equivariant with respect to both.
- The compositions $\tilde{X} \rightarrow X \rightarrow \mathbf{G}_I$ and $\tilde{X} \rightarrow X \rightarrow \mathbf{F}$ are locally trivial G -equivariant fibrations.

2.3. Local equations for X and \tilde{X} . For any flag $V := (V_1 \subset V_2 \subset V_3) \in \mathbf{F}$, let $\mathbf{F}(V) \subset \mathbf{F}$ denote the open set consisting of flags in general position to V . Thus, $\mathbf{F}(V)$ is a 6-dimensional affine space. For any $x \in X$ (respectively, $\tilde{x} \in \tilde{X}$), we call its image $x_I \in \mathbf{G}_I$ the I th plane of x (resp., \tilde{x}). Let $U(V)$ (resp., $\tilde{U}(V)$) be the open subset of X (resp., \tilde{X}) consisting of those x (resp., \tilde{x}) such that x_I is in general position to V for each $I \subset \llbracket 4 \rrbracket$. By varying V we obtain open covers $\{U(V)\}_{V \in \mathbf{F}}$ and $\{\tilde{U}(V)\}_{V \in \mathbf{F}}$ for X and \tilde{X} , respectively [1, Lemma 4.3]. In [1, 5.11], we defined closed embeddings

$$U(V) \subset \mathbf{F}(V) \times \mathbb{C}^{24}$$

and

$$\tilde{U}(V) \subset \mathbf{F}(V) \times \mathbb{C}^{24} \times (\mathbb{P}^5)^2 \times \mathbb{P}^{11} \times (\mathbb{P}^2)^{16},$$

and determined defining equations for their images. We recall these equations in this subsection.

Let $\mathbb{A}_{\mathcal{E}}$ be the affine space with coordinates $\{u_{\alpha} \mid \alpha \in \mathcal{E}\}$, and for each $\beta \in \mathcal{H}$, let \mathbb{P}_{β} denote the projective space with coordinates $\{u_{\alpha, \beta} \mid \alpha \in \mathcal{E}, \alpha \subset \beta\}$. We let $\mathcal{E}_{\#}$ denote the set of all pairs (α, β) such that $\alpha \in \mathcal{E}$ and $\alpha \subset \beta$. Since the elements of \mathcal{E} appear as the edges in Figure 4 and the elements of $\mathcal{E}_{\#}$ appear as the edges in Figure 5, we shall often refer to any elements of \mathcal{E} or $\mathcal{E}_{\#}$ as an *edge*. For any edge α or (α, β) , we call $\alpha \in \mathcal{E}$ its *original edge*. We note that each edge corresponds to exactly one of the coordinates defined above, with the original edges corresponding to the affine coordinates. To describe the necessary equations among these coordinates, we appeal to the geometry of the specific planar representations of the hypersimplices and their faces appearing in Figures 4 and 5.

Definition 2.3.1. Let $C = (c_1, \dots, c_k)$ be a sequence of edges that forms a circuit in Figure 4 or Figure 5. We shall call C a *triangle* if it has length 3; a *quadrilateral* if it has length 4 and its original edges are in Δ_1 or Δ_3 ; and a *hexagon* if it has length 6, its original edges are in Δ_2 , and its opposite edges are parallel. (See Figure 6.)

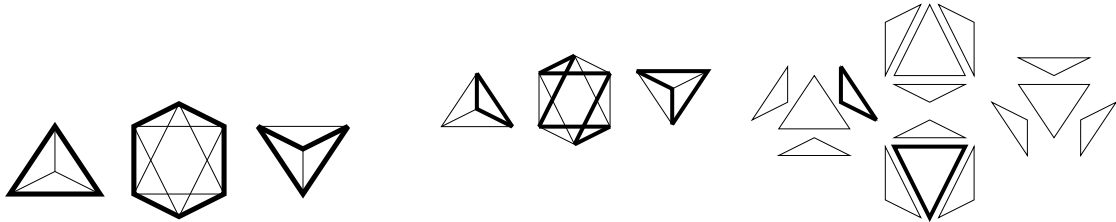

FIGURE 6. Examples of triangles, quadrilaterals, and hexagons.

Definition 2.3.2. Two triangles are *related* if either (1) they have the same set of original edges or (2) their original edges occur in consecutive Δ_i 's and their images

in Figure 4 differ by a 180° rotation. (See Figure 7.) Corresponding pairs of edges in related triangles will be called *related angles*. Two quadrilaterals are *related* if their original edges are in Δ_1 and Δ_3 and their images differ by a 180° rotation. (See Figure 8.)

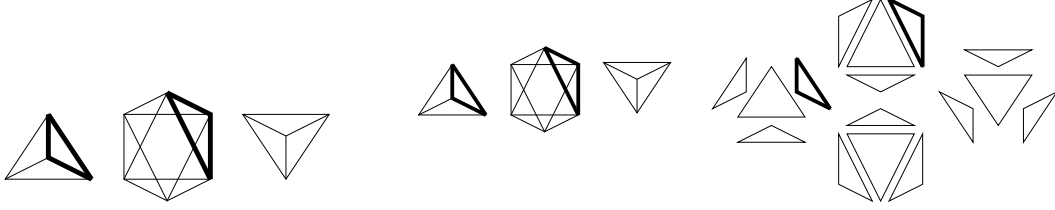

FIGURE 7. Six triangles determining $\binom{6}{2} = 15$ pairs of related triangles.

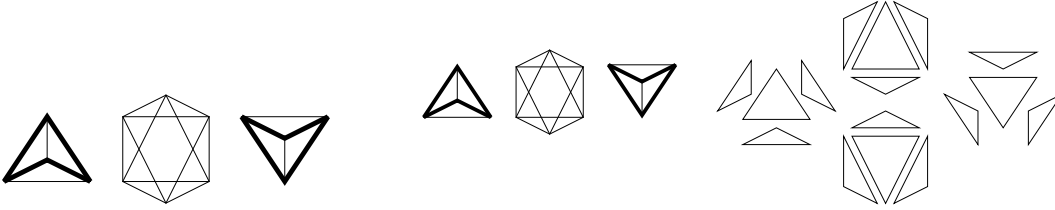

FIGURE 8. Four quadrilaterals determining 4 pairs of related quadrilaterals.

Theorem 2.3.3. ([1, 4.10 and 5.11]) *For any flag $V \in \mathbf{F}$, let $U = U(V)$ and $\tilde{U} = \tilde{U}(V)$ be as above. Then there exist closed embeddings*

$$U \subset \mathbf{F}(V) \times \mathbb{A}_{\mathcal{E}} \quad \text{and} \quad \tilde{U} \subset \mathbf{F}(V) \times \mathbb{A}_{\mathcal{E}} \times \prod_{\beta \in \mathcal{H}} \mathbb{P}_{\beta}$$

whose images are defined set-theoretically by the following equations:

- (1) $u_a - u_b + u_c = 0$ for any triangle (a, b, c) .¹
- (2) $u_a u_{a'} = u_b u_{b'}$ for any related angles (a, b) and (a', b') .
- (3) $u_a u_b u_c = u_{a'} u_{b'} u_{c'}$ for any hexagon (a, a', b, b', c, c') .
- (4) $u_a u_b u_c u_{d'} = u_{a'} u_{b'} u_{c'} u_d$ for any related quadrilaterals (a, b, c, d) and (a', b', c', d') .

Moreover, with respect to these embeddings, the fibrations $X \rightarrow \mathbf{F}$ and $\tilde{X} \rightarrow \mathbf{F}$ are given by projection to $\mathbf{F}(V)$, and the map $\tilde{X} \rightarrow X$ is given by projection to $\mathbf{F}(V) \times \mathbb{A}_{\mathcal{E}}$.

¹There is a sign convention for our coordinates that depends on an ordering of the subsets of $[4]$. We refer to [1] for details.

For later computations, it will be convenient to write the ambient variety for \tilde{U} in Theorem 2.3.3 as

$$\mathbf{F}(V) \times \mathbb{A}_{\mathcal{E}_1} \times \mathbb{A}_{\mathcal{E}_2} \times \mathbb{A}_{\mathcal{E}_3} \times \mathbb{P}_{\Delta_1} \times \mathbb{P}_{\Delta_2} \times \mathbb{P}_{\Delta_3} \times \prod_{\beta \in \mathcal{T}} \mathbb{P}_\beta,$$

where \mathcal{E}_i is the set of edges in Δ_i , and where \mathcal{T} is the set of triangular faces of the Δ_i . Thus, each factor (except $\mathbf{F}(V)$) corresponds to a connected component in Figure 6.

3. STRATIFICATIONS AND NORMAL CROSSINGS

Recall that a stratification of a variety X is a collection $\{X_S\}_{S \in \mathcal{S}}$ of locally closed subvarieties indexed by a poset \mathcal{S} such that

- $X = \coprod X_S$ (disjoint union), and
- $\overline{X_S} = \coprod_{T \leq S} X_T$.

In this section we describe a natural stratification of \tilde{X} , and prove that the closures of the codimension one strata form a divisor with normal crossings.

3.1. Diagrams. We begin by describing the combinatorial data we use to index the strata. Let x be an element of the canonical space of tetrahedra X . Recall from 2.2 that for any edge $\alpha = \{I, J\} \in \mathcal{E}$, the image $s_\alpha(x)$ will be in the diagonal D_α if and only if the planes x_I and x_J coincide. This leads us to consider the subset $S(x) \subset \mathcal{E}$ defined by

$$S(x) = \{\alpha \mid s_\alpha(x) \in D_\alpha\}.$$

We represent the subset $S(x)$ graphically by marking in bold the edges in Figure 4 corresponding to its elements. These bold edges encode exactly the projections of x to factors of \mathbf{G} that coincide. For example, if x is a degenerate tetrahedron whose points x_2, x_3, x_4 all coincide, and whose lines x_{12}, x_{13}, x_{14} all coincide, and with no other collapsing among the x_I 's, then we have

$$S(x) = \{\{2, 3\}, \{2, 4\}, \{3, 4\}, \{12, 13\}, \{12, 14\}, \{13, 14\}\}$$

(see Figure 9).

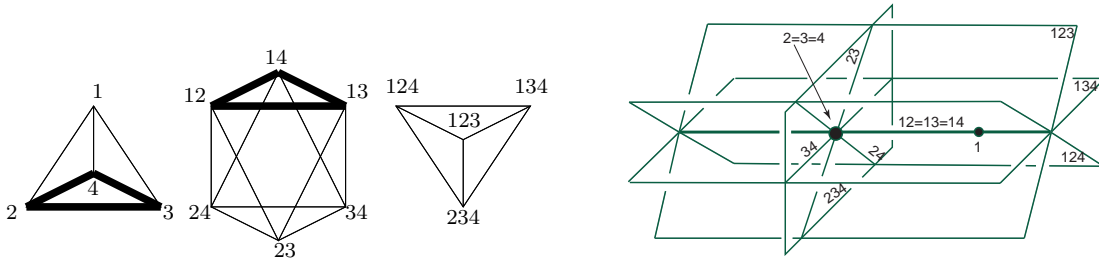

FIGURE 9.

Next we shall describe similar marked diagrams for elements of \tilde{X} . First we give the formal description, which requires some additional notation. For any edge $(\alpha, \beta) \in \mathcal{E}_\#$, we let $E_{\alpha, \beta} \subset E_\beta$ be the subbundle

$$E_{\alpha, \beta} = D_\alpha \times \prod_{\alpha' \neq \alpha, \alpha' \subset \beta} E_{\alpha'}.$$

We let $(E_{\alpha, \beta})_\# \rightarrow E_{\alpha, \beta}$ be its blow-up along

$$D_\beta = D_\alpha \times \prod_{\alpha' \neq \alpha, \alpha' \subset \beta} D_{\alpha'},$$

and we let $D_{\alpha, \beta}$ be the exceptional divisor of this blow-up. By functoriality of blow-ups, $(E_{\alpha, \beta})_\#$, and hence $D_{\alpha, \beta}$, are both subvarieties of $(E_\beta)_\#$.

Now suppose \tilde{x} is a point in \tilde{X} . For any $\beta \in \mathcal{H}$, we let \tilde{x}_β denote the image of \tilde{x} under the projection $E_\# \rightarrow (E_\beta)_\#$, and we define $S_\#(\tilde{x}) \subset \mathcal{E}_\#$ to be the subset

$$S_\#(\tilde{x}) = \{(\alpha, \beta) \mid \tilde{x}_\beta \in D_{\alpha, \beta}\}.$$

Definition 3.1.1. A *diagram* Γ is a pair $(S, S_\#)$ where $S \subset \mathcal{E}$ and $S_\# \subset \mathcal{E}_\#$. If $\tilde{x} \in \tilde{X}$ and x is its image in X , then the *diagram for* \tilde{x} , which we denote by $\Gamma(\tilde{x})$, is the diagram $(S(x), S_\#(\tilde{x}))$.

We represent a diagram graphically by marking in bold the edges in Figure 4 corresponding to elements of S , and the edges in Figure 5 corresponding to elements of $S_\#$.

To understand the information that a diagram encodes for a point \tilde{x} , consider a curve $\tilde{x}(t)$ in \tilde{X} with $\tilde{x}(0) = \tilde{x}$ and $x(t) \in X^\circ$ for $t \neq 0$ (equivalently, $\tilde{x}(t) = s(x(t))$ for $t \neq 0$). Then an edge $\alpha = \{I, J\}$ will be in $S(x)$ if and only if the I th and J th planes of $x(t)$ approach each other as $t \rightarrow 0$, i.e.,

$$\lim_{t \rightarrow 0} x(t)_I = \lim_{t \rightarrow 0} x(t)_J.$$

An edge (α, β) with $\alpha = \{I, J\}$ will be in $S_\#(\tilde{x})$ if and only if the I th and J th planes of $x(t)$ come together and come together *faster* than any other pair $\alpha' = \{I', J'\}$ where α' is an edge of β and $(\alpha', \beta) \notin S_\#(\tilde{x})$.

The following proposition implies that diagrams are compatible with the local embeddings of Theorem 2.3.3. The proof follows from the discussion in [1, Section 5].

Proposition 3.1.2. *Let $\tilde{U} \subset \tilde{X}$ be one of the open subvarieties described in 2.3, and let $\tilde{x} \in \tilde{U}$. Then the diagram $\Gamma(\tilde{x}) = (S, S_\#)$ is defined in terms of coordinates by*

$$S = \{\alpha \in \mathcal{E} \mid u_\alpha = 0\} \quad \text{and} \quad S_\# = \{(\alpha, \beta) \in \mathcal{E}_\# \mid u_{\alpha, \beta} = 0\}.$$

3.2. Classification of diagrams. For most subsets $S \subset \mathcal{E}$ and $S_{\#} \subset \mathcal{E}_{\#}$, there are no points \tilde{x} having diagram $(S, S_{\#})$. Here we determine exactly which diagrams can arise.

Proposition 3.2.1. *Let Γ be the diagram of a point $\tilde{x} \in \tilde{X}$. Then the following conditions must hold for Γ .*

- (i) *For each of the connected components in Figure 5 at least one edge must be unmarked (i.e., not bold).*
- (ii) *Up to symmetry, the set of bold edges in any pair of related triangles must be one of the 5 options in Figure 10.*

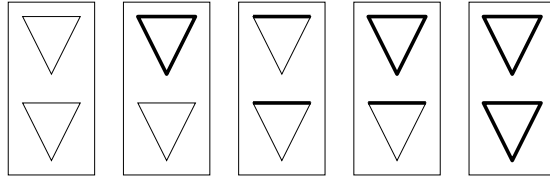

FIGURE 10.

Proof. These are all consequences of Proposition 3.1.2 and the linear and quadric equations in Theorem 2.3.3. □

Definition 3.2.2.

- A diagram $(S, S_{\#})$ with $S \subset \mathcal{E}$ and $S_{\#} \subset \mathcal{E}_{\#}$ is *admissible* if it satisfies (i) and (ii) in the statement of Proposition 3.2.1.
- An admissible diagram $(S, S_{\#})$ is a *shifting* diagram if $S_{\#} = \emptyset$ and the number of vertices in each hypersimplex Δ_k is either 1 or $\binom{4}{k}$ after collapsing all of the edges in S .
- An admissible diagram $(S, S_{\#})$ is *split* if the number of vertices in each hypersimplex Δ_k is ≥ 2 after collapsing all of the edges in S .

The classification of shifting diagrams and split diagrams is a pleasant combinatorial exercise using Proposition 3.2.1. The results are given Tables 1 and 2, listed by combinatorial type. In the shifting diagrams, we also use the shorthand \bullet (respectively \circ) to indicate that an affine hypersimplex component is collapsed (resp., not collapsed). Note that one diagram, X_{\emptyset} , is both shifting and split; this is the only diagram having this property.

TABLE 1. The shifting diagrams.











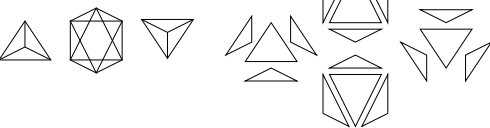

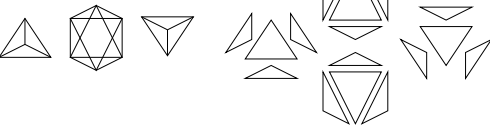

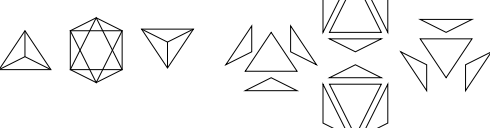

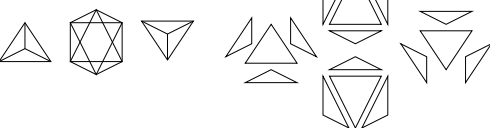

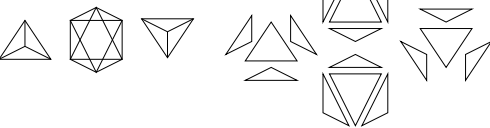

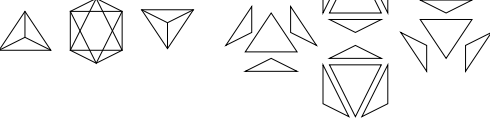

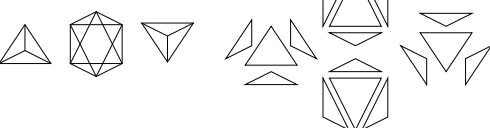

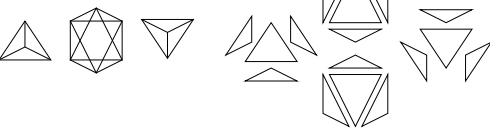

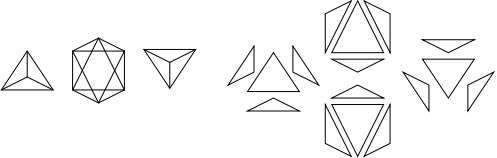

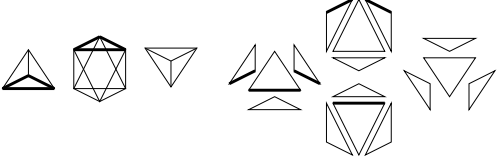

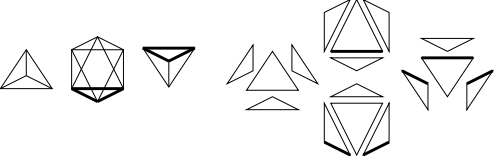
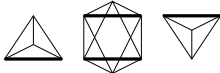
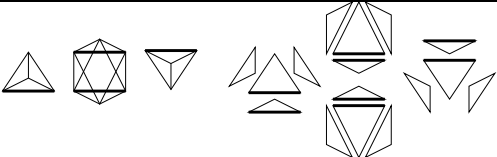

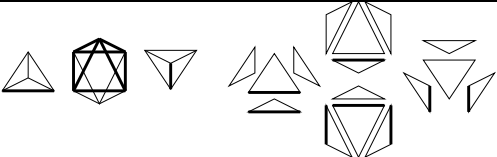

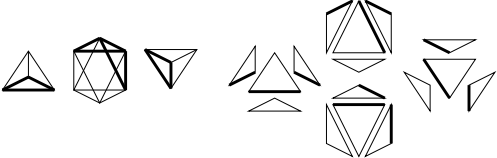

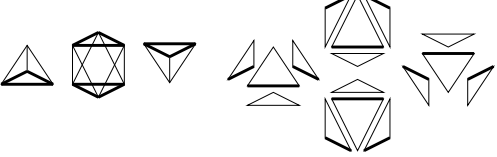

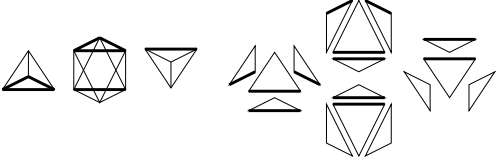

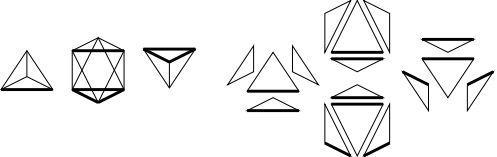

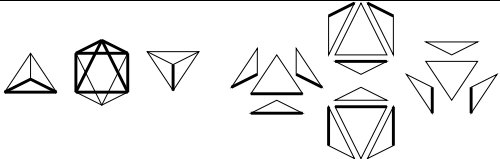

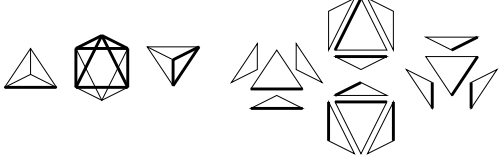

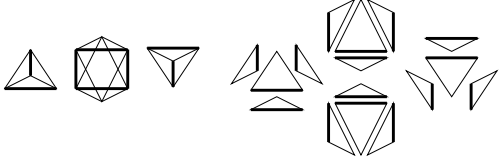

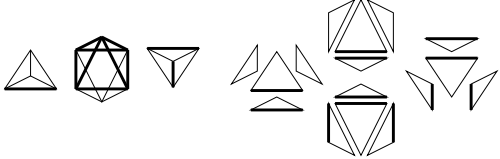

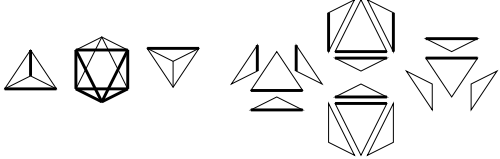

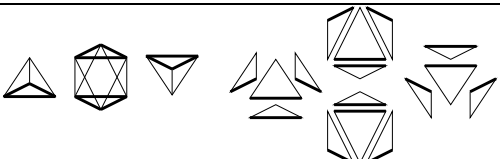
Type	S	$S_{\#}$	codim	#
X_{\emptyset} (○○○)			0	1
A (●○○)			1	1
B (○●○)			1	1
A^* (○○●)			1	1
AB (●●○)			2	1
AA^* (●○●)			2	1
BA^* (○●●)			2	1
ABA^* (●●●)			3	1

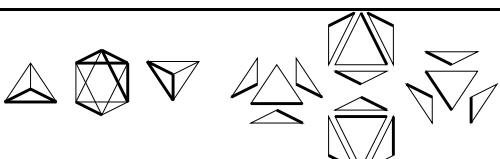
TABLE 2. The split diagrams.

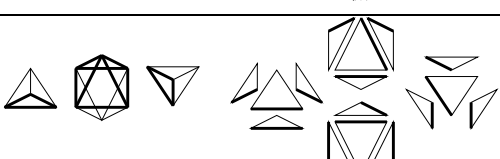
Type	S	$S_{\#}$	codim	#
X_{\emptyset}			0	1
C			1	4
C^*			1	4
D			1	6
E			1	6
CC_{nop}^*			2	12
CC_{op}^*			2	4
CD			2	12
C^*D			2	12

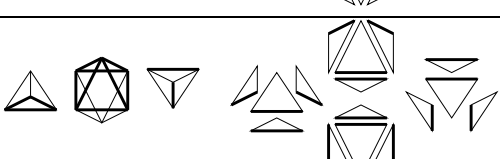
Type	S	$S_{\#}$	codim	#
CE			2	12
C^*E			2	12
DD_{op}			2	3
DE			2	6
DE^*			2	6
$CC^*_{op}D$			3	12
$CC^*_{nop}D$			3	12
CC^*E			3	24
CDE			3	12

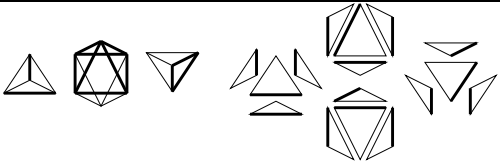
Type	S	$S_{\#}$	codim	#
C^*DE			3	12
$DD_{op}E$			3	6

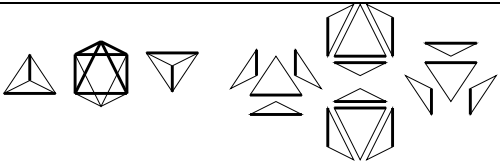
The classification of admissible diagrams can be formulated in terms of shifting and split diagram as follows:

Proposition 3.2.3. *A diagram Γ is admissible if and only if it can be written in the form $\Gamma = (S_{\text{split}} \cup S_{\text{shift}}, S_{\#})$ where $(S_{\text{shift}}, \emptyset)$ is a shifting diagram (called the “shifting part” of Γ) and $(S_{\text{split}}, S_{\#})$ is a split diagram (called the “split part” of Γ). Moreover, this representation is unique.*

Proof. The diagram $(S_{\text{split}} \cup S_{\text{shift}}, S_{\#})$ is obtained from the split diagram $(S_{\text{split}}, S_{\#})$ by placing the fully marked hypersimplices in S_{shift} into the corresponding location in the diagram for S_{split} , and leaving the remaining components of S_{split} and $S_{\#}$ unchanged. The resulting marked diagram satisfies (i) and (ii) of Proposition 3.2.1, and hence is admissible.

Conversely, suppose $\Gamma = (S, S_{\#})$ is admissible. The rules (i) and (ii) imply that the only possibilities for $S_{\#}$ are those appearing in Table 2, and each such $S_{\#}$ appears exactly once. Letting $(S_{\text{split}}, S_{\#})$ be the unique corresponding split diagram, we see that the same rules imply that S must contain all of the edges in S_{split} , and that adding any other edge to S_{split} from the hypersimplex Δ_i forces us to add all of the edges in Δ_i . Thus, $S = S_{\text{split}} \cup S_{\text{shift}}$ for exactly one of the 8 shifting diagrams $(S_{\text{shift}}, \emptyset)$.

The uniqueness of the decomposition into split and shifting parts is clear, and this completes the proof. \square

3.3. The stratification. We now want to use admissible diagrams to construct our stratification. First we put a partial order on the set of all diagrams, by putting $(S, S_{\#}) < (S', S'_{\#})$ if and only if $S \supset S'$ and $S_{\#} \supset S'_{\#}$. Next for any diagram Γ , let \tilde{X}_{Γ} be the subvariety

$$\tilde{X}_{\Gamma} = \{\tilde{x} \in \tilde{X} \mid \Gamma(\tilde{x}) = \Gamma\}.$$

We will also be interested in the image X_{Γ} of this subvariety under the projection $\tilde{X} \rightarrow X$. It follows immediately from the definition of $\Gamma(\tilde{x})$ that X_{Γ} is the locus

$$X_{\Gamma} = \{x \in X \mid S(x) = S\}$$

where $\Gamma = (S, S_{\#})$. The set of \tilde{X}_{Γ} , as Γ ranges over the poset of admissible diagrams \mathcal{S} equipped with the above partial order, will be our stratification. We will abuse language and call the \tilde{X}_{Γ} “strata,” even though we have not yet verified that they form the strata of a stratification.

To understand the meaning of the construction of \tilde{X}_{Γ} , recall that in 2.3 we defined an open cover $\{\tilde{U}(V)\}_{V \in \mathbf{F}}$ of \tilde{X} . Moreover, any $\tilde{U}(V)$ is embedded in a product of \mathbf{F} with certain affine and projective spaces, and the coordinates of the latter spaces are indexed by elements of \mathcal{E} . By Proposition 3.1.2, \tilde{X}_{Γ} is the locus cut out by the vanishing of the coordinates indexed by Γ in *any* of the $\tilde{U}(V)$. It also follows from Theorem 2.3.3 and Proposition 3.1.2, that the locally trivial fibrations $\tilde{X} \rightarrow \mathbf{F}$ and $X \rightarrow \mathbf{F}$ restrict to locally trivial fibrations on each \tilde{X}_{Γ} and X_{Γ} .

The following proposition gives the first properties of the strata in \tilde{X} .

Proposition 3.3.1.

- (i) If Γ is a shifting diagram or a split diagram, then \tilde{X}_Γ is an irreducible locally closed variety with codimension as in Tables 1 and 2, respectively.
- (ii) More generally, if Γ is any admissible diagram with split part Γ_{split} and shifting part Γ_{shift} , then \tilde{X}_Γ is an irreducible locally closed variety and

$$\text{codim}(\tilde{X}_\Gamma) = \text{codim}(\tilde{X}_{\Gamma_{\text{shift}}}) + \text{codim}(\tilde{X}_{\Gamma_{\text{split}}}).$$

- (iii) The variety \tilde{X}_Γ is non-empty if and only if the diagram Γ is admissible.

Proof. (i) follows from explicit computations using the equations of Theorem 2.3.3 together with the diagrams in Tables 1 and 2. (ii) follows from the observation that a general point in \tilde{X}_Γ can be described by specifying coordinates for a general “split point” in $\tilde{X}_{\Gamma_{\text{split}}}$ together with any nonzero scaling factor for each unmarked component of S_{shift} . For (iii), the fact that $\tilde{X}_\Gamma \neq \emptyset$ implies Γ is admissible is a restatement of Proposition 3.2.1. The converse follows from (i) and (ii). \square

Theorem 3.3.2. *Let $Z \subset \tilde{X}$ be the closure of the union of all $\tilde{X}_\Gamma, \Gamma \in \mathcal{S}$ of codimension one. Then Z is a divisor with normal crossings.*

Proof. It suffices to prove that Z is a divisor with normal crossings in any open set \tilde{U} . To do this, we first consider the subvariety $Y \subset \tilde{U}$ defined by setting all of the affine coordinates $u_\alpha = 0, \alpha \in \mathcal{E}$. It follows from [1, Lemma 6.5] that \tilde{U} can be identified with a sum of line bundles $L_1 \oplus L_2 \oplus L_3$ on Y , and that our decomposition of \tilde{U} coincides with the decomposition of this bundle constructed by restricting the coordinate subbundles to the strata in Y . For example, the stratum of type AA^*CD (i.e., the one corresponding to the diagram with shifting part of type AA^* and split part of type CD) is the restriction of the subbundle L_2 (minus its zero section) to the stratum of type ABA^*CD in Y .

Since the coordinate subbundles of $L_1 \oplus L_2 \oplus L_3$ have normal crossings in each fiber, Z will be a divisor with normal crossings provided $Z \cap Y$ is a divisor with normal crossings in Y . This can be verified by direct computation using the techniques and rules for differentials used to verify nonsingularity of \tilde{X} [1, Theorem 7.6]. There we showed that Y was a smooth variety, and singled out coordinates whose differentials along the minimal strata formed a basis for the cotangent space. In fact, it is easy to show that subsets of these differentials span bases for the cotangent spaces to the divisors meeting along this stratum, proving that along the minimal strata, the irreducible components of $Z \cap Y$ are smooth and have normal crossings. Similar computations work for the higher dimensional strata in Y . \square

Corollary 3.3.3. *The decomposition $\{\tilde{X}_\Gamma \mid \Gamma \in \mathcal{S}\}$ is a stratification.*

Proof. Any divisor with normal crossings determines a stratification in which the closures of the strata are precisely the multiple intersections of the irreducible divisors. One only needs to observe that the decomposition of \tilde{X} indexed by admissible diagrams coincides with the stratification induced by Z . \square

4. BETTI NUMBERS

4.1. Zeta function and Betti numbers. In this section we use the Hasse-Weil zeta function $Z(\tilde{X}, s)$ of \tilde{X} to compute the Poincaré polynomial

$$P_{\tilde{X}}(t) = \sum_{i=0}^{24} \dim(H^i(\tilde{X}(\mathbb{C}), \mathbb{C})) \cdot t^i.$$

In other words, we count points on $\tilde{X}(\mathbb{F}_q)$ as a function of q , and then use the relation between $Z(\tilde{X}, s)$ and the ranks of the complex cohomology groups $H^*(\tilde{X}(\mathbb{C}); \mathbb{C})$ to compute the latter. For more information about Z and for the proof of Weil's conjectures, we refer to [4].

Let $q = p^l$ for some prime p and positive integer l , and let \mathbb{F}_q be the finite field with q elements. Let Y be an n -dimensional nonsingular projective variety defined over \mathbb{F}_q , and for $r \geq 1$ let $\#Y(\mathbb{F}_{q^r})$ be the number of \mathbb{F}_{q^r} -rational points of Y . Then the *zeta function* $Z(Y, s)$ is the formal power series defined by

$$Z(Y, s) = \exp\left(\sum_{r \geq 1} \#Y(\mathbb{F}_{q^r}) s^r / r\right).$$

Theorem 4.1.1. (cf. [4]) *The zeta function is a rational function of s , with a factorization*

$$Z(Y, s) = \frac{P_1(s) \cdots P_{2n-1}(s)}{P_0(s) \cdots P_{2n}(s)}.$$

If Y is the reduction modulo \mathbb{F}_q of a nonsingular projective variety defined over \mathbb{C} , then the degree of P_i is the i th topological Betti number of Y .

The following fact is well known, but we were unable to locate a reference; thus we provide a proof.

Lemma 4.1.2. *Suppose that $\#Y(\mathbb{F}_{q^r})$ is given by the polynomial $\sum_{i=0}^n a_i q^{ri}$ for all \mathbb{F}_{q^r} . Then the rank of $H^k(Y(\mathbb{C}); \mathbb{C})$ is 0 if k is odd, and is a_i if $k = 2i$.*

Proof. The proof is a simple manipulation with power series:

$$\begin{aligned}
 Z(Y, s) &= \exp\left(\sum_r \#Y(\mathbb{F}_{q^r})s^r/r\right) \\
 &= \exp\left(\sum_r \sum_i a_i q^{ri} s^r/r\right) \\
 &= \exp\left(\sum_i a_i \sum_r q^{ri} s^r/r\right) \\
 &= \prod_i \exp\left(a_i \sum_r (q^i s)^r/r\right) \\
 &= \prod_i \frac{1}{(1 - q^i s)^{a_i}}.
 \end{aligned}$$

In the last step we used $-\log(1 - x) = \sum x^r/r$. □

Poincaré polynomial for the flag variety. To illustrate how to use Lemma 4.1.2, and to warm up for later calculations, we compute the (well known) Poincaré polynomial of the flag variety \mathbf{F} . In order to count points in $\mathbf{F}(\mathbb{F}_q)$, $q = p^l$, we must count flags $V_1 \subset V_2 \subset V_3$ in $(\mathbb{F}_q)^4$. There are $(q^4 - 1)/(q - 1) = 1 + q + q^2 + q^3$ choices for V_1 , $(q^3 - 1)/(q - 1) = 1 + q + q^2$ choices for V_2 containing V_1 , and $(q^2 - 1)/(q - 1) = 1 + q$ choices for V_3 containing V_2 . Thus

$$\#\mathbf{F}(\mathbb{F}_q) = (1 + q + q^2 + q^3)(1 + q + q^2)(1 + q) = 1 + 3q + 5q^2 + 6q^3 + 5q^4 + 3q^5 + q^6.$$

In fact, the same arguments work for any extension \mathbb{F}_{q^r} of \mathbb{F}_q , so by Lemma 4.1.2,

$$P_{\mathbf{F}}(t) = 1 + 3t^2 + 5t^4 + 6t^6 + 5t^8 + 3t^{10} + t^{12}.$$

4.2. Counting points in \tilde{X} . We fix a prime power $q = p^l$ for some large p , and we want to count points in $\tilde{X}(\mathbb{F}_{q^r})$. As above, it will suffice to determine $\#\tilde{X}(\mathbb{F}_q)$, since our arguments will be the same for all extensions of \mathbb{F}_q . (The reason is that the strata are very simple varieties, usually projective spaces). We will count the points in the (disjoint) sets $\tilde{X}_{\Gamma}(\mathbb{F}_q)$ separately. A further reduction is that since $\tilde{X} \rightarrow \mathbf{F}$ is a locally trivial fibration, the cardinality of each $\tilde{X}_{\Gamma}(\mathbb{F}_q)$ is the product of $\#(\tilde{X}_{\Gamma} \cap X^{fib})(\mathbb{F}_q)$ with $\#\mathbf{F}(\mathbb{F}_q)$. Hence we fix the flag $x_1 \subset x_{12} \subset x_{123}$ and count the former factor.

The counts $\#(\tilde{X}_{\Gamma} \cap X^{fib})(\mathbb{F}_q)$ are given in Table 3. In this table we group the point counts by split diagrams, following the decomposition of Proposition 3.2.3. For each split diagram, we indicate the corresponding shifting diagrams using \bullet and \circ as in Table 1. To construct the table we use the following facts:

- For $\tilde{X}_{\Gamma} \rightarrow X_{\Gamma}$ to have a nontrivial fiber, the diagram $\Gamma = (S, S_{\#})$ must contain either all the edges in a hypersimplex, or at least one pair of related triangles. Indeed, otherwise the coordinates corresponding to every pair of

related triangles are determined, and this suffices to determine the coordinates for all components of the graph. This also implies that for many strata the fiber consists of a single point; in these cases we only need to count points in X_Γ .

- According to Theorem 2.3.3, any point in \tilde{X}_Γ has a neighborhood that embeds in the product

$$\mathbf{F}(V) \times \mathbb{A}_{\mathcal{E}_1} \times \mathbb{A}_{\mathcal{E}_2} \times \mathbb{A}_{\mathcal{E}_3} \times \mathbb{P}_{\Delta_1} \times \mathbb{P}_{\Delta_2} \times \mathbb{P}_{\Delta_3} \times \prod_{\beta \in \mathcal{T}} \mathbb{P}_\beta,$$

where \mathcal{T} is the set of triangular faces of the Δ_i . A simple computation in coordinates proves the following:

- Let β be the triangle (a, b, c) . Then the subvariety of \mathbb{P}_β cut out by the linear relation $x_a - x_b + x_c = 0$ is isomorphic to \mathbb{P}^1 , and the subvariety cut out by $x_a x_b x_c = 0$ is a set of three distinct points.
- Let a, b, c, d, e, f be the edges of the tetrahedron Δ_1 . Then the subvariety of \mathbb{P}_{Δ_1} cut out by the 4 linear relations in x_a, \dots, x_f is isomorphic to \mathbb{P}^2 , and the subvariety of this cut out by $x_a x_b x_c x_d x_e x_f = 0$ is the projective hyperplane arrangement of type \mathbf{A}_3 (Figure 11). The same is true for \mathbb{P}_{Δ_3} .

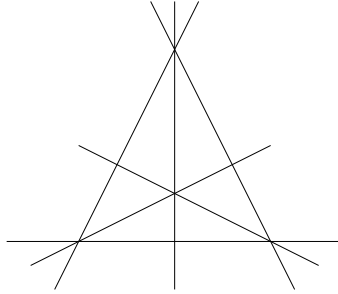

FIGURE 11. The hyperplane arrangement of type \mathbf{A}_3 .

Point counts for shifting strata. Most of the point counts are straightforward. The most difficult computations are for the shifting strata, so we describe these in some detail.

Type X_\emptyset ($\circ \circ \circ$). The map $\tilde{X}_\Gamma \rightarrow X_\Gamma$ is one-to-one, so it suffices to count the points in $X_\Gamma = X^\circ$ (nondegenerate tetrahedra). It is easy to see that any nondegenerate tetrahedron can be constructed by choosing a flag in general position to the fixed flag $x_1 \subset x_{12} \subset x_{123}$. This means the number of nondegenerate tetrahedra is the same as the number of points in the open set of the flag variety, which is q^6 .

*Types A and A** ($\bullet\circ\circ$ and $\circ\circ\bullet$). These are dual, and so have the same number of points. We count points for A^* . We claim that the fiber of $\tilde{X}_\Gamma \rightarrow X_\Gamma$ is a single point. Indeed, the coordinates of any point in \tilde{X}_Γ are determined by the projections to $\mathbb{A}_{\mathcal{E}_1}$, $\mathbb{A}_{\mathcal{E}_2}$, and \mathbb{P}_{Δ_3} , and the projection to \mathbb{P}_{Δ_3} is determined (via the quadric and quartic relations from Theorem 2.3.3) by those to $\mathbb{A}_{\mathcal{E}_1}$ and $\mathbb{A}_{\mathcal{E}_2}$. Since for this stratum $\tilde{X}_\Gamma \rightarrow X_\Gamma$ is given by projection to $\mathbb{A}_{\mathcal{E}_1} \times \mathbb{A}_{\mathcal{E}_2}$, the fiber of $\tilde{X}_\Gamma \rightarrow X_\Gamma$ is a single point. In fact, a similar argument shows that the projection $\tilde{X}_\Gamma \rightarrow X_\Gamma$ is one-to-one for any codimension-1 stratum.

To count points in X_Γ , note that a point of type A^* is a degenerate tetrahedron obtained by collapsing all of the planes to the single fixed plane x_{123} , but is as general as possible otherwise (see Figure 2). Having fixed the flag x_1, x_{12}, x_{123} , we then have q choices for x_2 (a point on x_{12} not equal to x_1), q choices for x_{13} (a line containing x_1 and contained in x_{123} , but different from x_{12}), q choices for x_3 (a point on x_{13} not equal to x_1), $q - 1$ choices for x_{14} (a line containing x_1 and contained in $x_{123} = x_{124}$, but different from x_{12} and x_{13}), and $q - 1$ choices for x_4 (a point on x_{14} different from x_1 , and not lying on the line x_{23}). The remaining lines are then completely determined, so there are $q^3(q - 1)^2 = q^5 - 2q^4 + q^3$ points altogether.

Type B ($\circ\bullet\circ$). Again, $\tilde{X}_\Gamma \rightarrow X_\Gamma$ is one-to-one over the image of this stratum, so we count points $x \in X_\Gamma$. Such an x is a degenerate tetrahedron obtained by collapsing all of the lines to the single fixed line x_{12} (see Figure 2). There are q choices for the point x_2 , $q - 1$ choices for x_3 , $q - 2$ choices for x_4 , q choices for the plane x_{124} , $q - 1$ choices for x_{134} . The final plane x_{234} is then determined by equation (4) of Theorem 2.3.3 (this equation says that the cross-ratio of the 4 points on the line x_{12} must be the same as the cross-ratio of the 4 planes containing the line x_{12}). Thus, $\#\tilde{X}_\Gamma(\mathbb{F}_q) = q^2(q - 1)^2(q - 2) = q^5 - 4q^4 + 5q^3 - 2q^2$.

*Types AB and BA** ($\bullet\bullet\circ$ and $\circ\bullet\bullet$). Again, these are dual, so it suffices to consider BA^* . This time the map $\tilde{X}_\Gamma \rightarrow X_\Gamma$ is not one-to-one, so we must be more careful. If we know the values of all coordinates on $\mathbb{A}_{\mathcal{E}_1}$ and \mathbb{P}_{Δ_3} , then Theorem 2.3.3 implies that we will know all of the coordinate values. The points in \mathbb{P}_{Δ_3} from this stratum are exactly the points in \mathbb{P}^2 not on the \mathbf{A}_3 hyperplane arrangement, and this gives $(q^2 + q + 1) - 6(q + 1) + (1 \cdot 3 + 2 \cdot 4) = q^2 - 5q + 6$ points. After these values are fixed, we can specify two points in the configuration arbitrarily, but then the remaining two points are determined (one because it is x_1 and is globally fixed, and one by the cross-ratio condition). This gives a factor of $q(q - 1)$ more choices, which makes the total number of points in this stratum $q^4 - 6q^3 + 11q^2 - 6q$.

*Type AA** ($\bullet \circ \bullet$). To count points in this stratum, we use a degeneration trick. Consider the configuration C of 6 lines in the affine plane \mathbb{A}^2 shown in Figure 12. If we linearly collapse all the points into the fixed point x_1 , then we will obtain a configuration of 6 lines contained in the fixed plane, and all containing the fixed point. It is easy to show that any point in this stratum can be obtained in this way, and that the points obtained from two non-homothetic configurations in \mathbb{A}^2 are distinct.

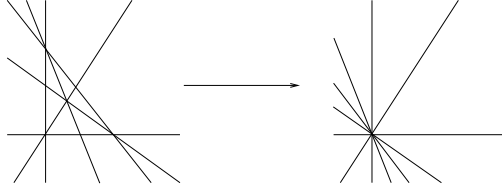

FIGURE 12.

To build the configuration C , first choose the lines x_{13} and x_{23} through the point x_1 , and then move them slightly away from x_1 to form a small triangle T . Then x_4 can be placed on any point in $\mathbb{A}^2 \setminus T$, and this determines the remaining three lines. Altogether we have $q(q-1)$ choices for x_{13} and x_{23} , and then $q^2 - 3q + 3$ choices for x_4 , so this gives $q^4 - 4q^3 + 6q^2 - 3q$ points for this stratum.

*Type ABA** ($\bullet \bullet \bullet$). Just as for the stratum BA^* , all values of coordinates are known if we know the projections to \mathbb{P}_{Δ_1} and \mathbb{P}_{Δ_3} . For the latter projection we know from the argument for type BA^* that we have $q^2 - 5q + 6$ points in the image. Moreover, the projection map $\mathbb{P}_{\Delta_1} \times \mathbb{P}_{\Delta_3} \rightarrow \mathbb{P}_{\Delta_3}$ induces a fibration of this stratum over $\mathbb{P}^2 \setminus \mathbf{A}_3$; the quartic relations imply that the fiber F is contained in a smooth quadric Q in \mathbb{P}^2 . Any such quadric has $q+1$ points. We want to count the points in Q that miss the \mathbf{A}_3 hyperplane arrangement in $\mathbb{P}^2 \subset \mathbb{P}_{\Delta_1}$, and a computation shows that each quadric meets the arrangement exactly in the four triple points. Hence the number of points in F is $(q+1) - 4$, which makes the total number of points $q^3 - 8q^2 + 21q - 18$.

The remaining strata. Counting points for the rest of the strata is not difficult once one determines the fibers of the maps $\tilde{X}_\Gamma \rightarrow X_\Gamma$. Then $\#\tilde{X}_\Gamma(\mathbb{F}_q)$ is given by multiplying $\#X_\Gamma(\mathbb{F}_q)$, which can be determined by straightforward geometric arguments, by the number of points in the appropriate fiber. In Table 3 we indicate which strata have nontrivial fibers, and we leave the details to the reader. There are three types of fibers that occur:

- (I) $\mathbb{P}^2 \setminus \mathbf{A}_3$, (II) $\mathbb{P}^1 \setminus \{\text{three points}\}$, (III) $\mathbb{P}^1 \setminus \{\text{two points}\}$.

In some cases the fiber is a product of two of these basic types; we indicate this with an exponent.

TABLE 3. Point counts.

type	shift	points over \mathbb{F}_q	shift	points over \mathbb{F}_q
X_\emptyset	○○○	q^6	●●○	$q^4 - 6q^3 + 11q^2 - 6q$
	●○○	$q^5 - 2q^4 + q^3$	●○○	$q^4 - 4q^3 + 6q^2 - 3q$
	○●○	$q^5 - 4q^4 + 5q^3 - 2q^2$	○●●	$q^4 - 6q^3 + 11q^2 - 6q$
	○○●	$q^5 - 2q^4 + q^3$	●●●	$q^3 - 8q^2 + 21q - 18$
C	○○○	$q^5 - q^4$	●●○	$q^3 - 3q^2 + 2q$
	●○○	$q^4 - q^3$	●○○	$q^3 - 3q^2 + 2q$
	○●○	$q^4 - 3q^3 + 2q^2$	○●●	$q^3 - 5q^2 + 6q$ I
	○○●	$q^4 - 3q^3 + 2q^2$	●●●	$q^2 - 5q + 6$ I
C^*	○○○	$q^5 - q^4$	●●○	$q^3 - 5q^2 + 6q$ I
	●○○	$q^4 - 3q^3 + 2q^2$	●○○	$q^3 - 3q^2 + 2q$
	○●○	$q^4 - 3q^3 + 2q^2$	○●●	$q^3 - 3q^2 + 2q$
	○○●	$q^4 - q^3$	●●●	$q^2 - 5q + 6$ I
D	○○○	q^5	●●○	$q^3 - 3q^2 + 2q$ II
	●○○	$q^4 - q^3$	●○○	$q^3 - 2q^2 + q$
	○●○	$q^4 - 2q^3 + q^2$	○●●	$q^3 - 3q^2 + 2q$ II
	○○●	$q^4 - q^3$	●●●	$q^2 - 4q + 4$ II ²
E	○○○	$q^5 - 2q^4 + q^3$	●●○	$q^3 - 3q^2 + 2q$ II
	●○○	$q^4 - 3q^3 + 2q^2$ II	●○○	$q^3 - 4q^2 + 4q$ II ²
	○●○	$q^4 - 2q^3 + q^2$	○●●	$q^3 - 3q^2 + 2q$ II
	○○●	$q^4 - 3q^3 + 2q^2$ II	●●●	$q^2 - 4q + 4$ II ²
CC_{nop}^*	○○○	$q^4 - q^3$	●●○	$q^2 - 2q$ II
	●○○	$q^3 - q^2$	●○○	$q^2 - q$
	○●○	$q^3 - 2q^2$ II	○●●	$q^2 - 2q$ II
	○○●	$q^3 - q^2$	●●●	$q - 2$ II
CC_{op}^*	○○○	$q^4 - 2q^3$ II	●●○	$q^2 - 2q$ II
	●○○	$q^3 - 2q^2$ II	●○○	$q^2 - 2q$ II
	○●○	$q^3 - 2q^2$ II	○●●	$q^2 - 2q$ II
	○○●	$q^3 - 2q^2$ II	●●●	$q - 2$ II
CD	○○○	q^4	●●○	$q^2 - q$
	●○○	q^3	●○○	$q^2 - q$
	○●○	$q^3 - q^2$	○●●	$q^2 - 2q$ II
	○○●	$q^3 - q^2$	●●●	$q - 2$ II
C^*D	○○○	q^4	●●○	$q^2 - 2q$ II
	●○○	$q^3 - q^2$	●○○	$q^2 - q$
	○●○	$q^3 - q^2$	○●●	$q^2 - q$
	○○●	q^3	●●●	$q - 2$ II
CE	○○○	$q^4 - q^3$	●●○	$q^2 - q$
	●○○	$q^3 - q^2$	●○○	$q^2 - 2q$ II
	○●○	$q^3 - q^2$	○●●	$q^2 - 2q$ II
	○○●	$q^3 - 2q^2$ II	●●●	$q - 2$ II

type	shift	points over \mathbb{F}_q	shift	points over \mathbb{F}_q
C^*E (12)	○○○	$q^4 - q^3$	●●○	$q^2 - 2q$ II
	●○○	$q^3 - 2q^2$ II	●○○	$q^2 - 2q$ II
	○●○	$q^3 - q^2$	○●●	$q^2 - q$
	○○●	$q^3 - q^2$	●●●	$q - 2$ II
DD_{op} (3)	○○○	q^4	●●○	$q^2 - q$ III
	●○○	q^3	●○○	q^2
	○●○	$q^3 - q^2$ III	○●●	$q^2 - q$ III
	○○●	q^3	●●●	$q - 1$ III
DE (6)	○○○	$q^4 - q^3$	●●○	$q^2 - 2q$ II
	●○○	$q^3 - 2q^2$ II	●○○	$q^2 - 2q$ II
	○●○	$q^3 - q^2$	○●●	$q^2 - q$
	○○●	$q^3 - q^2$	●●●	$q - 2$ II
DE^* (6)	○○○	$q^4 - q^3$	●●○	$q^2 - q$
	●○○	$q^3 - q^2$	●○○	$q^2 - 2q$ II
	○●○	$q^3 - q^2$	○●●	$q^2 - 2q$ II
	○○●	$q^3 - 2q^2$ II	●●●	$q - 2$ II
$CC^*_{op}D$ (12)	○○○	q^3	●●○	q
	●○○	q^2	●○○	q
	○●○	q^2	○●●	q
	○○●	q^2	●●●	1
$CC^*_{nop}D$ (12)	○○○	q^3	●●○	q
	●○○	q^2	●○○	q
	○●○	q^2	○●●	q
	○○●	q^2	●●●	1
CC^*E (24)	○○○	q^3	●●○	q
	●○○	q^2	●○○	q
	○●○	q^2	○●●	q
	○○●	q^2	●●●	1
CDE (12)	○○○	q^3	●●○	q
	●○○	q^2	●○○	q
	○●○	q^2	○●●	q
	○○●	q^2	●●●	1
C^*DE (12)	○○○	q^3	●●○	q
	●○○	q^2	●○○	q
	○●○	q^2	○●●	q
	○○●	q^2	●●●	1
$DD_{op}E$ (6)	○○○	q^3	●●○	q
	●○○	q^2	●○○	q
	○●○	q^2	○●●	q
	○○●	q^2	●●●	1

Theorem 4.2.1. *The Poincaré polynomial for \tilde{X} is $P_{\tilde{X}}(t) = P_{fib}(t) \cdot P_{\mathbf{F}}(t)$ where*

$$P_{fib}(t) = 1 + 23t^2 + 114t^4 + 189t^6 + 114t^8 + 23t^{10} + t^{12}$$

and

$$P_{\mathbf{F}}(t) = 1 + 3t^2 + 5t^4 + 6t^6 + 5t^8 + 3t^{10} + t^{12}.$$

Proof. Adding up the total numbers of points in each stratum (of the fiber) gives

$$(2) \quad 1 + 23q + 114q^2 + 189q^3 + 114q^4 + 23q^5 + q^6.$$

The result then follows from Lemma 4.1.2 and the remark that counting points over \mathbb{F}_{q^r} for $r > 1$ yields (2) with q replaced with q^r . \square

5. COHOMOLOGY

In this section we compute the rational cohomology ring $H^*(\tilde{X}; \mathbb{Q})$. By Theorem 4.2.1, this ring is trivial in odd degrees. In degree 2, there are 23 classes obtained by taking the Poincaré duals of the irreducible divisors coming from our stratification. These correspond to the diagrams of type A , B , A^* , C_i , C_i^* , D_{ij} , and E_{ij} (and the degenerate tetrahedra shown in Figures 2 and 3). There are additional degree 2 classes obtained by taking Poincaré duals of the special position divisors. Recall that each of these 14 divisors corresponds to a proper nonempty subset $I \subset \llbracket 4 \rrbracket$, and is obtained by fixing a codimension $|I|$ subspace $V \subset \mathbb{C}^4$ and requiring the I th face of a tetrahedron to have nonempty intersection with $\mathbb{P}(V)$ in \mathbb{P}^3 . We denote this divisor by $Y_I = Y_I(V)$, and note that its class is independent of the choice of V . We now prove that the cohomology ring has the following description:

Theorem 5.0.2. *The cohomology ring $H^*(\tilde{X}; \mathbb{Q})$ is generated in degree 2 by the Poincaré duals of the 23 divisors from Figures 2 and 3, and the special position divisors Y_I . If we denote these dual classes by a , b , a^* , c_i , c_i^* , d_{ij} , e_{ij} , and y_i , y_{ij} , y_{ijk} (where the indices are regarded as unordered subsets of $\llbracket 4 \rrbracket$), then the ideal of relations is generated by the following polynomials:*

- (i) $y_{ij} - y_i - y_j + a + c_k + c_l + d_{ij} + e_{ij}$,
 $y_{ijk} - y_{ij} - y_{ik} + y_i + b + c_i + c_l^* + d_{jk} + e_{jk} + e_{il} + e_{jl} + e_{kl}$,
 $y_{ij} - y_{ijk} - y_{ijl} + a^* + c_i^* + c_j^* + d_{kl} + e_{ij}$.
- (ii) $c_i c_j$, $c_i^* c_j^*$, $c_i d_{ij}$, $c_i^* d_{ij}$, $c_i e_{ij}$, $c_i^* e_{jk}$, $d_{ij} e_{ik}$, $e_{ij} e_{ik}$, $e_{ij} e_{kl}$.
- (iii) $a(y_i - y_j)$, $b(y_{ij} - y_{ik})$, $a^*(y_{ijk} - y_{ijl})$,
 $c_i(y_j - y_k)$, $c_i(y_{ij} - y_{ik})$, $c_i^*(y_{jk} - y_{jl})$, $c_i^*(y_{ijk} - y_{ijl})$,
 $d_{ij}(y_i - y_j)$, $d_{ij}(y_{ik} - y_{jk})$, $d_{ij}(y_{ikl} - y_{jkl})$,
 $e_{ij}(y_i - y_j)$, $e_{ij}(y_{kl} - y_{ik})$, $e_{ij}(y_{ijk} - y_{ijl})$.

$$\begin{aligned}
\text{(iv)} \quad & y_i^2 + y_{ij}^2 + y_{ijk}^2 - y_i y_{ij} - y_{ij} y_{ijk}, \\
& y_{ij}^3 - 2y_i y_{ij}^2 + 2y_i^2 y_{ij}, \\
& y_i^4.
\end{aligned}$$

5.1. Relations. To prove Theorem 5.0.2, we first need to show that the relations (i)-(iv) all hold in $H^*(\tilde{X}; \mathbb{Q})$.

The linear relations (i) follow from rational equivalences corresponding to certain cross-ratios. Let $\tilde{x} \in \tilde{X}$, and recall that the images of \tilde{x} in X and \mathbf{G}_I are denoted by x and x_I , respectively. Let $V, V' \subset \mathbb{C}^4$ be hyperplanes such that V, V' , and x_{ij} are all in general position (in \mathbb{P}^3). Since the four points $\alpha = x_i, \beta = x_j, \gamma = x_{ij} \cap V, \delta = x_{ij} \cap V'$ in \mathbb{P}^3 all lie on the line x_{ij} , the cross-ratio

$$\frac{\alpha\beta : \gamma\delta}{\alpha\gamma : \beta\delta}$$

defines a rational function on \tilde{X} . The numerator vanishes on the divisors $A, C_k, C_l, D_{ij}, E_{ij}$, and $Y_{ij}(V \cap V')$. The denominator vanishes on $Y_i(V)$ and $Y_j(V')$. A calculation in local coordinates shows that the order of vanishing on these divisors is always 1, giving the relation

$$y_{ij} - y_i - y_j + a + c_k + c_l + d_{ij} + e_{ij}.$$

For the second relation in (i), let $V, V' \subset \mathbb{C}^4$ be 2-dimensional subspaces such that $V \cap V'$ is 1-dimensional (equivalently, $V + V'$ is 3-dimensional). For suitably general V and V' one obtains four points $\alpha = x_{ij} \cap (V + V'), \beta = x_{ik} \cap (V + V'), \gamma = x_{ijk} \cap V, \delta = x_{ijk} \cap V'$ in \mathbb{P}^3 , which all lie on the line $x_{ijk} \cap (V + V')$. The resulting cross-ratio defines a rational function on \tilde{X} that gives the second linear relation. The third relation in (i) is the dual of the first.

The monomial relations (ii) follow from the fact that the corresponding pairs of divisors are all disjoint in \tilde{X} . This can be verified using the rules of Proposition 3.2.1 and the diagrams in Table 2. For example, if a point \tilde{x} were in both of the divisors C_i and C_j , then all of the edges in the first component of the $S_{\#}(\tilde{x})$ diagram would have to be bold (using the second rule of 3.2.1), which would violate the first rule of 3.2.1. Thus the product $c_i c_j$ must be zero. The remaining products are similar.

The relations (iii) follow from the observation that if the I th and J th planes of a complete tetrahedron \tilde{x} coincide along a split divisor or a shifting divisor, and one of these planes is in special position, then so is the other. For example, if \tilde{x} is in the divisor A and also in $Y_i(V)$, then all of the points of x coincide, and the i th point x_i lies on the hyperplane $\mathbb{P}(V) \subset \mathbb{P}^3$. It follows that the j th point x_j must also lie on this hyperplane, hence $\tilde{x} \in Y_j(V)$. Since the divisor A meets both $Y_i(V)$ and $Y_j(V)$ transversally, we have $ay_i = ay_j$ in $H^*(\tilde{X}; \mathbb{Q})$. The other relations in (iii) are similar.

The relations (iv) are induced from relations in the flag variety \mathbf{F} . The fibration $f : \tilde{X} \rightarrow \mathbf{F}$ induces a homomorphism

$$H^*(\mathbf{F}; \mathbb{Q}) \xrightarrow{f^*} H^*(\tilde{X}; \mathbb{Q}),$$

and the classes y_1, y_{12}, y_{123} are the images of the (Poincaré duals of the) usual complex codimension-one Schubert cycles in $H_{10}(\mathbf{F}; \mathbb{Q})$. The relations among these Schubert cycles are well-known (see, e.g., [2] or [5]), and the relations in (iv) are the induced relations in $H^*(\tilde{X}; \mathbb{Q})$, together with their images under the symmetric group action. (In fact, one gets the same ideal using only the three relations involving just y_1, y_{12}, y_{123} .)

5.2. Sufficiency of the relations. Let R^* denote the graded quotient ring

$$\mathbb{Z}[a, a^*, b, c_i, c_i^*, d_{ij}, e_{ij}, y_i, y_{ij}, y_{ijk}]/I$$

where I is the ideal generated by the relations (i)-(iv) of Theorem 5.0.2. Since all of these relations hold in $H^*(\tilde{X}; \mathbb{Q})$, there exists a graded ring homomorphism $\phi : R^* \otimes \mathbb{Q} \rightarrow H^{2*}(\tilde{X}; \mathbb{Q})$. To complete the proof of Theorem 5.0.2, we need to show that ϕ is an isomorphism. Using the software package Macaulay2 [8], it can be shown that:

- (a) *The Hilbert series for $R^* \otimes \mathbb{Q}$ (and for $R^* \otimes \mathbb{F}_2$) is the same as the Poincaré polynomial for \tilde{X} given in Theorem 4.2.1. In other words,*

$$\dim_{\mathbb{Q}} R^i \otimes \mathbb{Q} = \dim_{\mathbb{F}_2} R^i \otimes \mathbb{F}_2 = \dim_{\mathbb{Q}} H^{2i}(\tilde{X}; \mathbb{Q})$$

for all i . The Hilbert series for R^* can be computed both over \mathbb{F}_2 and over \mathbb{Q} using Macaulay, and is the same in both cases. The former calculation can be done directly with the given presentation (removing the obvious redundancies among the relations); but over \mathbb{Q} , in order to speed up the computation we had to first reduce the number of variables by using the linear relations to eliminate the classes y_i for $i \neq 1$, y_{ij} for $ij \neq 12$, and y_{ijk} for $ijk \neq 123$.

- (b) *The multiplication pairing*

$$R^i \otimes R^{12-i} \rightarrow R^{12} \cong \mathbb{Z} \oplus \{\text{odd torsion}\}$$

is nondegenerate over \mathbb{F}_2 and \mathbb{Q} for $0 \leq i \leq 12$. We used Macaulay to show this over \mathbb{F}_2 . The result over \mathbb{Q} then follows from the Hilbert series calculation.

- (c) *The element $\phi(y_1^3 y_{12}^2 y_{123} a b a^* c_1 c_1^* d_{23})$ is nonzero in $H^{24}(\tilde{X}; \mathbb{Q})$. The intersection of the special position divisors corresponds to fixing the flag (x_1, x_{12}, x_{123}) , and the intersection of the remaining divisors determines a point in the fiber of $\tilde{X} \rightarrow \mathbf{F}$ over this fixed flag. Thus, the indicated element is the (dual of) the class of a point in \tilde{X} .*

The homomorphism ϕ is injective by (b) and (c) and hence, an isomorphism by (a).

REFERENCES

1. E. Babson, P. E. Gunnells, and R. Scott, *A smooth space of tetrahedra*, Adv. Math. **165** (2002), no. 2, 285–312.
2. I. N. Bernšteĭn, I. M. Gel'fand, and S. I. Gel'fand, *Schubert cells, and the cohomology of the spaces G/P* , Uspehi Mat. Nauk **28** (1973), no. 3(171), 3–26.
3. A. Collino and W. Fulton, *Intersection rings of spaces of triangles*, Mém. Soc. Math. France (N.S.) (1989), no. 38, 75–117, Colloque en l'honneur de Pierre Samuel (Orsay, 1987).
4. P. Deligne, *La conjecture de Weil. I*, Inst. Hautes Études Sci. Publ. Math. (1974), no. 43, 273–307.
5. M. Demazure, *Invariants symétriques entiers des groupes de Weyl et torsion*, Invent. Math. **21** (1973), 287–301.
6. W. Fulton, *Intersection theory*, Springer-Verlag, Berlin, 1984.
7. W. Fulton and R. MacPherson, *A compactification of configuration spaces*, Ann. of Math. (2) **139** (1994), no. 1, 183–225.
8. D. Grayson and M. Stillman, *Macaulay 2: A computer program designed to support computations in algebraic geometry and computer algebra.*, Source and object code available from <http://www.math.uiuc.edu/Macaulay2/>.
9. W. van der Kallen and P. Magyar, *The space of triangles, vanishing theorems, and combinatorics*, J. Algebra **222** (1999), no. 1, 17–50.
10. S. Keel, *Intersection theory of incidence varieties and polygon spaces*, Comm. Algebra **18** (1990), no. 11, 3647–3670.
11. P. Magyar, *Borel-Weil theorem for configuration varieties and Schur modules*, Adv. Math. **134** (1998), no. 2, 328–366.
12. J. Roberts and R. Speiser, *Enumerative geometry of triangles. I*, Comm. Algebra **12** (1984), no. 9-10, 1213–1255.
13. ———, *Enumerative geometry of triangles. II*, Comm. Algebra **14** (1986), no. 1, 155–191.
14. ———, *Enumerative geometry of triangles. III*, Comm. Algebra **15** (1987), no. 9, 1929–1966.
15. H. Schubert, *Anzahlgeometrische Behandlung des Dreiecks*, Math. Ann. (1880), 153–212.

DEPARTMENT OF MATHEMATICS, UNIVERSITY OF WASHINGTON, SEATTLE, WA 98195
E-mail address: babson@math.washington.edu

DEPARTMENT OF MATHEMATICS AND STATISTICS, UNIVERSITY OF MASSACHUSETTS, AMHERST, MA 01003
E-mail address: gunnells@math.umass.edu

DEPARTMENT OF MATHEMATICS AND COMPUTER SCIENCE, SANTA CLARA UNIVERSITY, SANTA CLARA, CA 95053
E-mail address: rscott@math.scu.edu