

The Eckmann-Hilton argument and higher operads

M.A. Batanin*

Macquarie University, NSW 2109, Australia
e-mail: mbatanin@math.mq.edu.au

March 15, 2006

To the memory of my father.

Abstract

The classical Eckmann-Hilton argument shows that two monoid structures on a set, such that one is a homomorphism for the other, coincide and, moreover, the resulting monoid is commutative. This argument immediately gives a proof of the commutativity of the higher homotopy groups. A reformulation of this argument in the language of higher categories is: suppose we have a one object, one arrow 2-category, then its *Hom*-set is a commutative monoid. A similar argument due to A.Joyal and R.Street shows that a one object, one arrow tricategory is ‘the same’ as a braided monoidal category.

In this paper we begin to investigate how one can extend this argument to arbitrary dimension. We provide a simple categorical scheme which allows us to formalise the Eckmann-Hilton type argument in terms of the calculation of left Kan extensions in an appropriate 2-category. Then we apply this scheme to the case of n -operads in the author’s sense and classical symmetric operads. We demonstrate that there exists a functor of symmetrisation Sym_n from a certain subcategory of n -operads to the category of symmetric operads such that the category of one object, one arrow, . . . , one $(n - 1)$ -arrow algebras of A is isomorphic to the category of algebras of $Sym_n(A)$. Under some mild conditions, we present an explicit formula for $Sym_n(A)$ which involves taking the colimit over a remarkable categorical symmetric operad.

We will consider some applications of the methods developed to the theory of n -fold loop spaces in the second paper of this series.

1991 Math. Subj. Class. 18D05 , 18D50, 55P48

*The author holds the Scott Russell Johnson Fellowship in the Centre of Australian Category Theory at Macquarie University.

Contents

1	How can symmetry emerge from nonsymmetry ?	2
2	General symmetrisation problem	5
3	Symmetric operads	8
4	Trees and their morphisms	15
5	n -Operads in symmetric monoidal categories	19
6	Desymmetrisation of symmetric operads	22
7	Internal algebras of cartesian monads	26
8	Symmetrisation of n -operads	32
9	Internal operads	35
10	Combinatorial aspects of internal operads	39
11	Example: iterated monoidal category operad	43
12	Free internal operads	47
13	Colimit formula for symmetrisation	49

1 How can symmetry emerge from nonsymmetry ?

Hopf and Alexandrov pointed out to Čech that his higher homotopy groups were commutative. The proof follows from the following statement which is known since [19] as the Eckmann-Hilton argument: two monoid structures on a set such that one is a homomorphism for the other coincide and, moreover, the resulting monoid is commutative. A reformulation of this argument in the language of higher categories is: suppose we have a one object, one arrow 2-category, then its *Hom*-set is a commutative monoid. A higher dimensional generalization of this argument was provided by Joyal and Street in [23]. Essentially they proved that a 1-object, 1-arrow tricategory is a braided monoidal category and a one object, one arrow, one 2-arrow tetracategory is a symmetric monoidal category.

Obviously we have here a pattern of some general higher categorical principle. Almost nothing, however, is known precisely except for the above low dimensional examples and some higher dimensional cases which can be reduced to the classical Eckmann-Hilton argument [15]. Yet, there are plenty of important conjectures which can be seen as different manifestations of this principle. First of all there is a bunch of hypotheses from Baez and Dolan [2] about the

so called ‘ k -tuply monoidal’ n -categories, which are $(n + k)$ -categories with one object, one arrow etc. up to $(k - 1)$. Basically these hypotheses state that these ‘ k -tuply monoidal’ n -categories are n -categorical analogues of k -fold loop spaces i.e. n -categories equipped with an additional monoidal structure together with some sort of higher symmetry structures similar to the structure of a k -fold loop space. In particular, ‘ k -tuply monoidal’ weak ω -groupoids should model k -fold loop spaces. Many other hypotheses from [2] are based on this analogy.

Another problem, which involves the passage to k -tuply monoidal n -categories, is the definition of higher centers [2, 14, 38]. Closely related to this problem is the Deligne conjecture from deformation theory [26, 27] which tells us that there is an action of an E_2 -operad on the Hochschild complex of an associative algebra. This conjecture is now proved by several people. In higher dimensions the generalised Deligne conjecture was understood by Kontsevich [26] as a problem of existence of some sort of homotopy centre of any d -algebra. This homotopy centre must have a structure of $(d + 1)$ -algebra. Here a d -algebra is an algebra of the little d -cubes operad [32]. To the best of our knowledge this hypothesis is not proved yet in full generality, but there is progress on it [39].

In this paper we consider a categorical basis for the Eckman-Hilton argument in higher dimensions using the apparatus of higher-dimensional nonsymmetric operads [5]. They were introduced in [5] for the purpose of defining weak n -categories for higher n . A weak n -category in our sense is an algebra of a contractible (in a suitable combinatorial sense) n -operad.

Now consider the algebras of an n -operad A which have only one object, one arrow, ... , one $(k - 1)$ -arrow. The underlying n -globular object of such an algebra can be identified with an $(n - k)$ -globular object and we can ask ourselves what sort of algebraic structure the action of A induces on this $(n - k)$ -globular object. Here we restrict ourselves by considering only $k = n$. This provides a great simplification of the theory, yet clearly shows how higher symmetries can appear. We must say that we do not know the answer for arbitrary k . For this, perhaps, we need to develop the theory of symmetric higher operads, and some steps in this direction have already been taken in [40].

Returning to the case $k = n$ we show that for an n -operad A one can construct a symmetric operad $Sym_n(A)$ (which in this case is just a classical symmetric operad in the sense of May [32] in a symmetric monoidal category), called symmetrisation of A , such that the category of one object, one arrow , ... , one $(n - 1)$ -arrow algebras of A is isomorphic to the category of algebras of $Sym_n(A)$. Moreover, under mild conditions we present an explicit formula for $Sym_n(A)$ involving the colimit over a remarkable categorical symmetric operad.

Fortunately, the restriction $n = k$ not only simplifies our techniques, but also makes almost unnecessary the use of variable category theory from [34, 37] which our paper [5] used. We can reformulate our theory of higher operads in a way that makes it very similar to the theory of classical symmetric operads. So the reader who does not need to understand the full structure of a higher operad may read the present paper without looking at [5, 36, 37, 8]. In several places we do refer to some constructions from [5, 8] but these references are not essential for understanding the main results.

We now provide a brief description of each section.

In section 2 we introduce the notion of the symmetrisation of an n -operad. This is the only section where we seriously refer to the notion of monoidal globular category from [5]. Nevertheless, we hope that the main notion of symmetrisation will be clear even without understanding all the details of the definition of n -operad in a general monoidal globular category because Proposition 2.1 shows that the problem of finding a symmetrisation of an n -operad A can be reduced to the case where A is of a special form, which we call $(n - 1)$ -terminal. The latter is roughly speaking an operad which has strict $(n - 1)$ -categories as the algebras for its $(n - 1)$ -skeleton. The reader, therefore, can start to read our paper from section 3.

In section 3 we fix our terminology concerning symmetric operads and obtain a useful combinatorial formula needed later.

In Section 4 we recall the definition of the ω -category of trees and of the category Ω_n [5, 8, 24] which is an n -dimensional analogue of the category Δ_{alg} of all finite ordinals and plays an important role here. More generally, we believe that the categories Ω_n must be one of the central objects of study in higher dimensional category theory, at least on the combinatorial side of the theory. It appears that Ω_n contains all the information on the coherence laws available in weak n -categories.

In Section 5 we give a definition of n -operad in a symmetric monoidal category V , which is just an n -operad in the monoidal globular category $\Sigma^n V$. This definition is much simpler than the definition of general n -operad and is reminiscent of the classical definition of nonsymmetric operad.

Section 6 is devoted to the construction of a desymmetrisation functor Des_n from symmetric operads to n -operads which incorporates the action of the symmetric groups. We also show that the desymmetrisation functor does not alter the endomorphism operads. Here we again refer to our paper [5] for a construction of the endomorphism n -operad. However, the reader, can accept our construction here as a definition of endomorphism n -operad, so again does not need to understand the technical construction from [5]. Our main activity for the rest of the paper will be an explicit construction of the symmetrisation functor Sym_n left adjoint to Des_n .

In section 7 we develop a general 2-categorical method, which in the next sections will allow us to express the Eckmann-Hilton style arguments in terms of left Kan extensions in an appropriate 2-category. These techniques will be very useful in the sequel of this paper [9].

In Section 8 we reap the first fruits of the theory developed in Section 7 by applying it to n -operads and symmetric operads. The results of this section show that the symmetrisation functor Sym_n exists.

In Section 9 we consider internal n -operads inside categorical symmetric operads and categorical n -operads and prove that these theories can be represented by some categorical operads \mathbf{h}^n and \mathbf{H}^n . We provide unpacked definitions of internal symmetric operads and internal n -operads and give some examples.

We continue to study internal operads in Section 10 and describe the operad \mathbf{h}^n in terms of generators and relations. We show that our theorem 9.1 is equiv-

alent to the classical tree formalism for nonsymmetric and symmetric operads if $n = 1$ or $n = \infty$ respectively [30].

In section 11 we consider an example of a categorical symmetric operad containing an internal operad, namely, the operad of n -fold monoidal categories of [3]. This example will be an important ingredient in one of the proofs of a theorem which will relate our categorical constructions to the theory of n -fold loop spaces [9].

Section 12 has a technical character. We establish a useful formula for the free n -operad functor using the techniques developed in Section 7.

Finally, in Section 13 we provide our symmetrisation formula for the $(n-1)$ -terminal n -operad A in a cocomplete symmetric monoidal category V . The formula is

$$Sym_n(A)_k \simeq \operatorname{colim}_{\mathbf{h}_k^n} \tilde{A}_k$$

where \tilde{A} is an operadic functor on \mathbf{h}^n which appears from the universal property of \mathbf{h}^n .

We also show that in one important case the symmetrisation functor commutes with the nerve functor, namely

$$N(\mathbf{h}^n) \simeq Sym_n(N(\mathbf{H}^n)).$$

Results like this will play an important role in the homotopy theory of n -operads which we develop in the second part of this paper [9]. We also will connect our symmetrisation formula with the geometry of the Fulton-Macpherson operad [26] and coherence laws for n -fold loop spaces in [9].

Acknowledgements. I would like to thank Ross Street for his constant encouragement and stimulating discussions during my work on this paper. His intellectual and human contribution to this work cannot be overestimated. I am grateful to Alexei Davydov from the discussions with whom I formed many ideas which constituted the foundation of this work. I wish to express my gratitude to C.Berger, S.Crans, J.Dolan, E.Getzler, A.Joyal, S.Lack, M.Markl, P.May, J.McLure, J.Stasheff, D.Tamarkin and M.Weber, each of whom provided me with an important detail of the mosaic which finally led to the whole picture presented in this paper. I am also grateful to my anonymous referee whose advice helped to improve considerably the presentation of this paper.

Finally, I gratefully acknowledge the financial support of the Scott Russell Johnson Memorial Foundation, Macquarie University Research Committee and Australian Research Council (grant # DP0558372).

2 General symmetrisation problem

We introduce here the general notion of symmetrisation of an n -operad in an augmented monoidal n -globular category.

Let M be an augmented monoidal n -globular category [5]. Recall that part of the structure on M are functors s_k, t_k, z which make M a reflexive graph in Cat .

Let I be the unit object of M_0 . Fix an integer $k > 0$. Then we can construct the following augmented monoidal n -globular category $M^{(k)}$. The category $M_l^{(k)}$ is the terminal category when $l < k$. If $l \geq k$ then $M_l^{(k)}$ is the full subcategory of M_l consisting of objects x with

$$s_{k-1}x = t_{k-1}x = z^{k-1}I.$$

There is an obvious inclusion

$$j : M^{(k)} \rightarrow M.$$

We also can form an augmented monoidal $(n - k)$ -globular category $\Sigma^{-k}M^{(k)}$ with

$$(\Sigma^{-k}M^{(k)})_l = M_{(l+k)}^{(k)}$$

and obvious augmented monoidal $(n - k)$ -globular structure.

Recall [5] that a globular object of M is a globular functor from the terminal n -globular category 1 to M . We will call a globular object

$$x : 1 \rightarrow M$$

$(k - 1)$ -terminal if x can be factorised through j . Analogously, a morphism between two $(k - 1)$ -terminal globular objects is a natural transformation which can be factorised through j .

Let us denote by $gl_n(M)$ and $gl_n^{(k)}(M)$ the categories of globular objects in M and $(k - 1)$ -terminal globular objects in M respectively. Then we have isomorphisms of categories

$$gl_n^{(k)}(M) \simeq gl_n(M^{(k)}) \simeq gl_{n-k}(\Sigma^{-k}M^{(k)}).$$

In the same way we can define $(k - 1)$ -terminal collections in M [5] and $(k - 1)$ -terminal n -operads in M . Again the category of $(k - 1)$ -terminal n -operads in M is isomorphic to the category of n -operads in $M^{(k)}$ but is different from the category of $(n - k)$ -operads in $\Sigma^{-k}M^{(k)}$.

Suppose now A is an n -operad in M and colimits in M commute with the augmented monoidal structure [5]. Then A generates a monad \mathcal{A} on the category of n -globular objects $gl_n(M)$. The algebras of A are, by definition, the algebras of the monad \mathcal{A} .

More generally, let \mathcal{A} be an arbitrary monad on $gl_n(M)$. An algebra x of \mathcal{A} is called $(k - 1)$ -terminal provided its underlying globular object is $(k - 1)$ -terminal. A morphism of $(k - 1)$ -terminal algebras is a morphism of underlying $(k - 1)$ -terminal objects which is also a morphism of \mathcal{A} -algebras.

Now let $Alg_{\mathcal{A}}^{(k)}$ be the category of $(k - 1)$ -terminal algebras of \mathcal{A} . We have a forgetful functor

$$U^{(k)} : Alg_{\mathcal{A}}^{(k)} \longrightarrow gl_n(M^{(k)}) \simeq gl_{n-k}(\Sigma^{-k}M^{(k)}).$$

Definition 2.1 If $U^{(k)}$ is monadic then we call the corresponding monad on $gl_{n-k}(\Sigma^{-k}M^{(k)})$ the k -fold suspension of \mathcal{A} .

In the special case $M = Span(Set)$ this definition was given by M.Weber in his PhD thesis [40]. He also proved that in this case the suspension exists for a large class of monads on globular sets. Observe that $gl_{\infty}(Span(Set)^{(k)})$ is equivalent to the category of globular sets again.

Suppose now that \mathcal{A} is obtained from an n -operad A in M . Even if the k -fold suspension of \mathcal{A} exists it is often not true that the suspension comes from an operad in $\Sigma^{-k}M^{(k)}$. To handle this situation we need a more general notion of operad which is not available at this time. M.Weber has a notion of symmetric globular operad in the special case $M = Span(Set)$ which seems to be a good candidate in this situation [40].

However, there is one case where such a notion already exists. Indeed, if $k = n$ the globular category $M^{(n)}$ has only one nontrivial category $M_n^{(n)} = \Sigma^{-n}M^{(n)} = V$. This category has to be braided monoidal if $n = 1$ and symmetric monoidal if $n > 1$; but we assume that V is symmetric monoidal even if $n = 1$.

The n -fold suspension of a monad \mathcal{A} on $gl_n(M)$ generates, therefore, a monad on V . It is now natural to ask whether this monad comes from a symmetric operad in V .

Definition 2.2 Let A be an n -operad in M such that the n -fold suspension of \mathcal{A} exists and comes from a symmetric operad B on V . Then we call B the symmetrisation of A . The notation is $B = Sym_n(A)$.

Remark 2.1 If $n = 1$ and V is a braided monoidal category we can give a similar definition with B being a nonsymmetric operad in V . If the braiding in V is actually a symmetry we can show that $Sym_1(A)$ is a symmetrisation of the nonsymmetric operad B in the classical sense.

Now we will show that the problem of finding a symmetrisation of an n -operad in M^n can often be subdivided into two steps.

Let

$$t : gl_n(M^{(n)}) \rightarrow gl_n(M)$$

be the natural inclusion functor. Let τ be the other obvious inclusion

$$\tau : O_n(M^{(n)}) \rightarrow O_n(M^n)$$

where $O_n(C)$ means the category of n -operads in C . Let x be a globular object of $M^{(n)}$. And suppose there exist endooperads $End(x)$ and $End(t(x))$ in $M^{(n)}$ and M respectively [5]. Then it is not hard to check that $\tau(End(x)) \simeq End(t(x))$.

If now x is an algebra of some n -operad A in M then we have an operadic morphism

$$k : A \rightarrow End(t(x)) \simeq \tau(End(x))$$

Suppose in addition that τ has a left adjoint λ . This is true in the most interesting cases. Then we have that k is uniquely determined and determines an operadic map

$$k' : \lambda(A) \rightarrow \text{End}(x).$$

Thus we have

Proposition 2.1 *The category of $(n - 1)$ -terminal algebras of an n -operad A in M is isomorphic to the category of algebras of the n -operad $\lambda(A)$ in $M^{(n)}$.*

Therefore, to define a symmetrisation of an n -operad A we first find an $(n - 1)$ -terminal n -operad $\lambda(A)$ and then calculate the symmetrisation of $\lambda(A)$.

If V is a symmetric monoidal category, we can form the augmented monoidal n -globular category $L = \Sigma^n V$ where L has V in dimension n and terminal categories in other dimensions. The monoidal structure is given by $\otimes_i = \otimes$ where \otimes is tensor product in V . For example, $M^{(n)} = \Sigma^n(M_n^{(n)})$. In the rest of the paper we will study the case $M = \Sigma^n V$. We will show that many interesting phenomena appear already in this situation. The passage from A to $\lambda(A)$ will be studied elsewhere by a method similar to the method developed in this paper.

3 Symmetric operads

For a natural number n we will denote by $[n]$ the ordinal

$$1 < 2 < \dots < n.$$

In particular $[0]$ will denote the empty ordinal. Notice, that our notation is not classical. We find it, however, more convenient for this exposition.

A morphism from $[n] \rightarrow [k]$ is any function between underlying sets. It can be order preserving or not. It is clear that we then have a category. We denote this category by Ω^s . Of course, Ω^s is equivalent to the category of finite sets. In particular, the symmetric group Σ_n is the group of automorphisms of $[n]$.

Let $\sigma : [n] \rightarrow [k]$ be a morphism in Ω^s and let $1 \leq i \leq k$. Then the preimage $\sigma^{-1}(i)$ has a linear order induced from $[n]$. Hence, there exists a unique object $[n_i] \in \Omega^s$ and a unique order preserving bijection $[n_i] \rightarrow \sigma^{-1}(i)$. We will call $[n_i]$ the *fiber* of σ over i and will denote it $\sigma^{-1}(i)$ or $[n_i]$.

Analogously, given a composite of morphisms in Ω^s :

$$[n] \xrightarrow{\sigma} [l] \xrightarrow{\omega} [k] \tag{3.1}$$

we will denote σ_i the *i -th fiber* of σ ; i.e. the pullback

$$\begin{array}{ccccc} \sigma^{-1}(\omega^{-1}(i)) & \xrightarrow{\sigma_i} & \omega^{-1}(i) & \longrightarrow & [1] \\ \downarrow & & \downarrow & & \downarrow \xi_i \\ [n] & \xrightarrow{\sigma} & [l] & \xrightarrow{\omega} & [k] . \end{array}$$

The following is a slightly more functorial version of a classical definition of a symmetric operad [32].

Let P be the subcategory of bijections in Ω^s . A *right symmetric collection* in a symmetric monoidal category V is a functor $A : P^{op} \rightarrow V$. The value of A on an object $[n]$ will be denoted A_n .

Definition 3.1 *A right symmetric operad in V is a right symmetric collection A equipped with the following additional structure:*

- a morphism $e : I \rightarrow A_1$
- for every order preserving map $\sigma : [n] \rightarrow [k]$ in Ω^s a morphism :

$$\mu_\sigma : A_k \otimes (A_{n_1} \otimes \dots \otimes A_{n_k}) \longrightarrow A_n,$$

where $[n_i] = \sigma^{-1}(i)$.

They must satisfy the following identities:

- for any composite of order preserving morphisms in Ω^s

$$[n] \xrightarrow{\sigma} [l] \xrightarrow{\omega} [k],$$

the following diagram commutes

$$\begin{array}{ccc}
 A_k \otimes A_{l_\bullet} \otimes A_{n_1^\bullet} \otimes \dots \otimes A_{n_i^\bullet} \otimes \dots \otimes A_{n_k^\bullet} & \xrightarrow{\cong} & A_k \otimes A_{l_1} \otimes A_{n_1^\bullet} \otimes \dots \otimes A_{l_i} \otimes A_{n_i^\bullet} \otimes \dots \otimes A_{l_k} \otimes A_{n_k^\bullet} \\
 \downarrow & & \downarrow \\
 A_l \otimes A_{n_1^\bullet} \otimes \dots \otimes A_{n_i^\bullet} \otimes \dots \otimes A_{n_k^\bullet} & & A_k \otimes A_{n_\bullet} \\
 & \searrow & \swarrow \\
 & A_n &
 \end{array}$$

Here

$$A_{l_\bullet} = A_{l_1} \otimes \dots \otimes A_{l_k},$$

$$A_{n_i^\bullet} = A_{n_i^1} \otimes \dots \otimes A_{n_i^{m_i}}$$

and

$$A_{n_\bullet} = A_{n_1} \otimes \dots \otimes A_{n_k};$$

- for an identity $\sigma = id : [n] \rightarrow [n]$ the diagram

$$\begin{array}{ccc}
 A_n \otimes A_1 \otimes \dots \otimes A_1 & \longleftarrow & A_n \otimes I \otimes \dots \otimes I \\
 \downarrow & & \swarrow \\
 A_n & & id
 \end{array}$$

commutes;

- for the unique morphism $[n] \rightarrow [1]$ the diagram

$$\begin{array}{ccc}
A_1 \otimes A_n & \xleftarrow{\quad} & I \otimes A_T \\
\downarrow & \swarrow id & \\
A_n & &
\end{array}$$

commutes.

In addition the following two equivariancy conditions must be satisfied:

1. For every commutative diagram in Ω^s

$$\begin{array}{ccc}
[n'] & \xrightarrow{\sigma'} & [k'] \\
\pi \downarrow & & \downarrow \rho \\
[n] & \xrightarrow{\sigma} & [k]
\end{array}$$

whose vertical maps are bijections and whose horizontal maps are order preserving the following diagram commutes:

$$\begin{array}{ccc}
A_{k'} \otimes (A_{n'_{\rho(1)}} \otimes \dots \otimes A_{n'_{\rho(k)}}) & \xrightarrow{\mu_{\sigma'}} & A_{n'} \\
A(\rho) \otimes \tau(\rho) \uparrow & & \uparrow A(\pi) \\
A_k \otimes (A_{n_1} \otimes \dots \otimes A_{n_k}) & \xrightarrow{\mu_{\sigma}} & A_n
\end{array} ,$$

where $\tau(\rho)$ is the symmetry in V which corresponds to permutation ρ .

2. For every commutative diagram in Ω^s

$$\begin{array}{ccc}
[n''] & \xrightarrow{\sigma'} & [n'] \\
\sigma \downarrow & & \downarrow \eta' \\
[n] & \xrightarrow{\eta} & [k]
\end{array}$$

where σ, σ' are bijections and η, η' are order preserving maps, the following diagram commutes

$$\begin{array}{ccc}
A_k \otimes (A_{n'_1} \otimes \dots \otimes A_{n'_k}) & \xrightarrow{\mu_{\eta'}} & A_{n'} \\
\downarrow 1 \otimes A(\sigma'_1) \otimes \dots \otimes A(\sigma'_k) & & \downarrow A(\sigma') \\
A_k \otimes (A_{n''_1} \otimes \dots \otimes A_{n''_k}) & & A_{n''} \\
\uparrow 1 \otimes A(\sigma_1) \otimes \dots \otimes A(\sigma_k) & & \uparrow A(\sigma) \\
A_k \otimes (A_{n_1} \otimes \dots \otimes A_{n_k}) & \xrightarrow{\mu_\eta} & A_n
\end{array}$$

Let us denote the category of operads in this sense by $SO_r(V)$. Analogously, we can construct the category of *left symmetric operads* $SO_l(V)$ by asking a *left symmetric collection* to be a covariant functor on P and inverting the corresponding arrows in equivariancy diagrams. Clearly, these two categories of operads are isomorphic.

We will define yet another category of symmetric operads $O^s(V)$.

Definition 3.2 *An S-operad is a collection of objects $\{A_n\}$, $[n] \in \Omega^s$, equipped with :*

- a morphism $e : I \rightarrow A_1$
- for every map $\sigma : [n] \rightarrow [k]$ in Ω^s a morphism

$$\mu_\sigma : A_k \otimes (A_{n_1} \otimes \dots \otimes A_{n_k}) \longrightarrow A_n,$$

where $[n_i] = \sigma^{-1}(i)$.

This structure must satisfy the associativity axiom from the Definition 3.1 with respect to all maps in Ω^s and two other axioms concerning identity and trivial maps in Ω^s , but no equivariance condition is imposed on A .

Proposition 3.1 *The categories $SO_r(V)$, $SO_l(V)$ and $O^s(V)$ are isomorphic.*

Proof We will construct a functor

$$S : O^s(V) \rightarrow SO_r(V)$$

first. Let A be an object of $O^s(V)$. We construct a symmetric collection $S(A)_n = A_n$. Now we have to define the action of the symmetric groups on $S(A)$. Let $\sigma : [n] \rightarrow [n]$ be a permutation. Then the composite

$$S(A)_n = A_n \longrightarrow A_n \otimes I \otimes \dots \otimes I \longrightarrow A_n \otimes A_1 \otimes \dots \otimes A_1 \xrightarrow{\mu_\sigma} A_n = S(A)_n$$

determines an endomorphism $S(A)(\sigma)$. The reader may check as an exercise that $S(A)$ is a contravariant functor on P .

The effect of an order preserving map on $S(A)$ is determined by the effect of this map on A . The equivariance conditions follows easily from these definitions.

Let us construct an inverse functor

$$(-)^s : SO_r(V) \rightarrow O^s(V)$$

On the level of collections, $(A)_n^s = A_n$. To define $(A)^s$ on an arbitrary map from Ω^s we recall the following combinatorial fact. Every morphism $\sigma : [n] \rightarrow [k]$ in Ω^s has a unique factorisation

$$\begin{array}{ccc} [n] & \xrightarrow{\sigma} & [k] \\ & \searrow \pi(\sigma) & \nearrow \nu(\sigma) \\ & [n'] & \end{array}$$

where $\nu(\sigma)$ is order preserving, while $\pi(\sigma)$ is bijective and preserves order on the fibers of σ_n . We use this factorisation to define the effect on σ of $(A)^s$ by requiring the commutativity of the following diagram

$$\begin{array}{ccc} A_k \otimes (A_{n_1} \otimes \dots \otimes A_{n_k}) & \xrightarrow{A^s(\sigma)} & A_n \\ \downarrow & & \uparrow A(\pi(\sigma)) \\ A_k \otimes (A_{n'_1} \otimes \dots \otimes A_{n'_k}) & \xrightarrow{A(\nu(\sigma))} & A_{n'} \end{array}$$

where actually $[n'] = [n]$, $[n'_i] = [n_i]$ and the left vertical map is the identity since $\pi(\omega)$ is the identity on the fibers of σ and $\nu(\sigma)$.

Now consider the composite (3.1) of morphisms in Ω^s . It induces the following factorisation diagram

$$\begin{array}{ccccc} & & [n'''] & & \\ & \nearrow \pi(\sigma \cdot \omega) & & \searrow \nu(\sigma \cdot \omega) & \\ [n] & \xrightarrow{\sigma} & [l] & \xrightarrow{\omega} & [k] \\ \pi(\sigma) \searrow & \nu(\sigma) \nearrow & & \pi(\omega) \searrow & \nu(\omega) \nearrow \\ & [n'] & & [l'] & \\ \pi(\nu(\sigma) \cdot \pi(\omega)) \searrow & & \nearrow \nu(\nu(\sigma) \cdot \pi(\omega)) & & \\ & & [n''] & & \end{array}$$

which in its turn generates the following huge diagram.

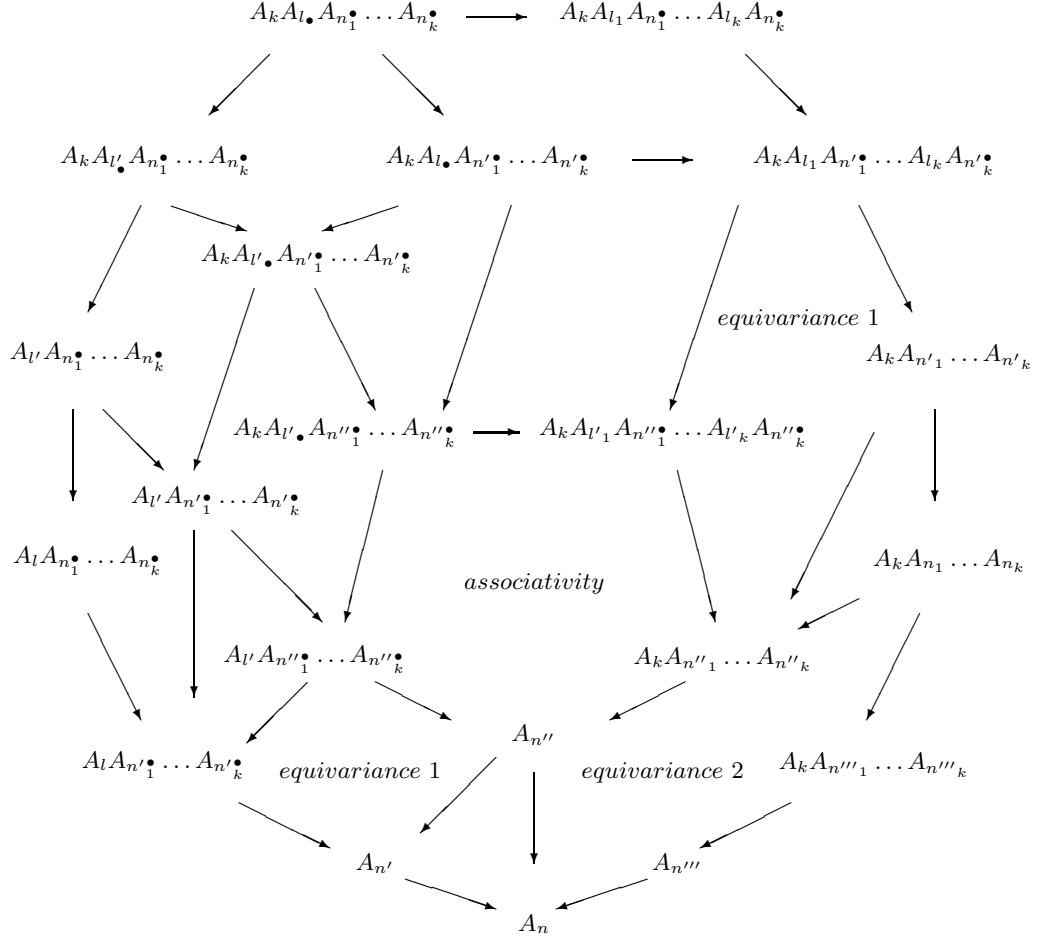

In this diagram the central region commutes because of associativity of A with respect to order preserving maps. Other regions commute by one of the equivariance conditions, by naturality or functoriality. The commutativity of this diagram means associativity of A^s with respect to arbitrary maps in Ω^s .

It is also obvious that the functor $(-)^s$ is inverse to $S(-)$.

♣

Recall that the symmetric groups form a symmetric operad Σ in Set sometimes called the permutation operad in the literature. Let us describe this operad explicitly as a right symmetric operad.

The collection Σ_n consists of the bijections from $[n]$ to $[n]$. Let Γ be multiplication in Σ . One can give the following explicit formula for Γ :

$$\Gamma(\sigma_k; \sigma_{n_1}, \dots, \sigma_{n_k}) = \Gamma(1_{[k]}; \sigma_{n_1}, \dots, \sigma_{n_k}) \cdot \Gamma(\sigma_k; 1_{[n_1]}, \dots, 1_{[n_k]})$$

where 1_n means the identity bijection of $[n]$,

$$\Gamma(1_k; \sigma_{n_1}, \dots, \sigma_{n_k}) = \sigma_{n_1} \oplus \dots \oplus \sigma_{n_k}$$

and

$$\Gamma(\sigma; 1_{n_1}, \dots, 1_{n_k})(p) = \sum_{\sigma(k) < \sigma(i+1)} n_k + p - \sum_{0 \leq l \leq i} n_l,$$

when $n_0 + \dots + n_i < p \leq n_0 + \dots + n_{i+1}$ and we assume that $n_0 = 0$. In other words $\Gamma(\sigma; 1_{n_1}, \dots, 1_{n_k})$ permutes blocks $[n_1], \dots, [n_k]$ in accord with the permutation σ .

We can illustrate the multiplication

$$\Gamma((132); (21), (12), (1)) = \Gamma((132); (21), 1_2, 1_1)$$

by the following picture to be read from top to bottom:

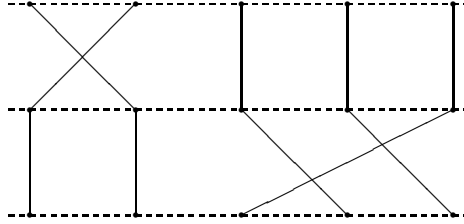

Lemma 3.1 For the composite (3.1) in Ω^s the following formula holds

$$\pi(\sigma \cdot \omega) \cdot \Gamma(1; \pi(\sigma_1), \dots, \pi(\sigma_k)) = \pi(\sigma) \cdot \Gamma(\pi(\omega); 1_{\sigma^{-1}(1)}, \dots, 1_{\sigma^{-1}(l)}).$$

The idea of the lemma is presented in the diagram

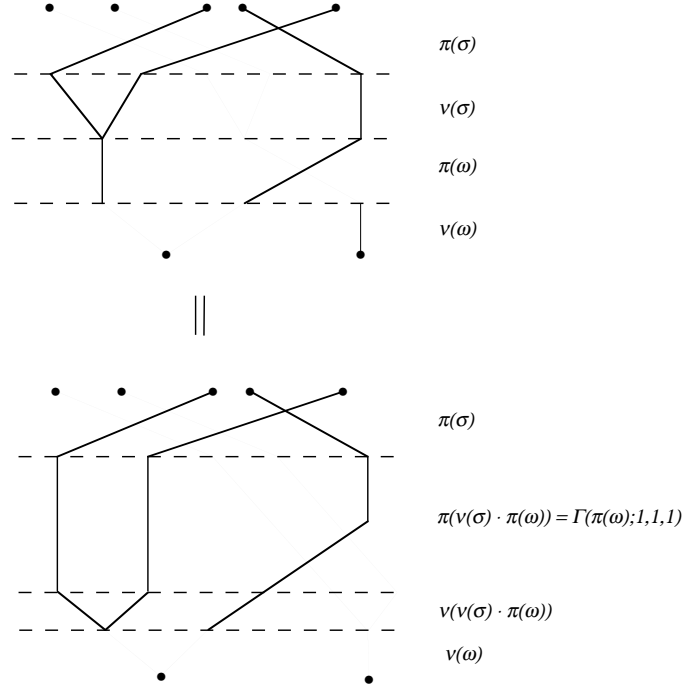

where the bottom diagram is just an appropriate deformation of the top one.

Proof. For a proof it is sufficient to consider the commutative diagram for associativity generated by (3.1) for the S -operad Σ^s and then to calculate both sides of this diagram on identity permutations.

♣

From now on we accept as agreed that the term *symmetric operad* will mean the *left symmetric operad* unless a different understanding is not required explicitly. The reason for this agreement is practical: many classical operads are described as left symmetric operads. Also the description of multiplication in a left symmetric operad is often easier.

4 Trees and their morphisms

Definition 4.1 A tree of height n (or simply n -tree) is a chain of order preserving maps of ordinals

$$T = [k_n] \xrightarrow{\rho_{n-1}} [k_{n-1}] \xrightarrow{\rho_{n-2}} \dots \xrightarrow{\rho_0} [1]$$

If $i \in [k_m]$ and there is no $j \in [k_{m+1}]$ such that $\rho_m(j) = i$ then we call i a leaf of T of height i . We will call the leaves of T of height n the tips of T . If for an n -tree T all its leaves are tips we call such a tree *pruned*.

We illustrate the definition in a picture

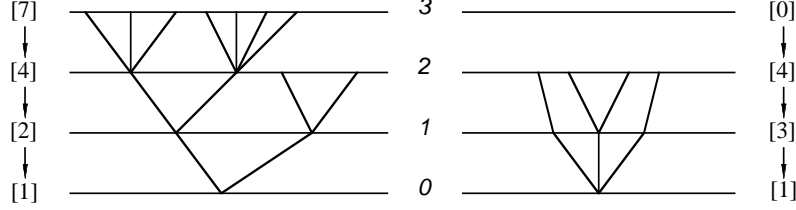

The tree on the right side of the picture has the empty ordinal at the highest level. We will call such trees *degenerate*. There is actually an operation on trees which we denote by $z(-)$ which assigns to the n -tree $[k_n] \rightarrow [k_{n-1}] \rightarrow \dots \rightarrow [1]$ the $(n + 1)$ -tree

$$[0] \longrightarrow [k_n] \longrightarrow [k_{n-1}] \longrightarrow \dots \longrightarrow [1].$$

Two other operations on trees are *truncation*

$$\partial([k_n] \rightarrow [k_{n-1}] \rightarrow \dots \rightarrow [1]) = [k_{n-1}] \rightarrow \dots \rightarrow [1]$$

and *suspension*

$$S([k_n] \rightarrow [k_{n-1}] \rightarrow \dots \rightarrow [1]) = [k_n] \rightarrow [k_{n-1}] \rightarrow \dots \rightarrow [1] \rightarrow [1].$$

Definition 4.2 A tree T is called a k -fold suspension if it can be obtained from another tree by applying the operation of suspension k -times. The suspension index $\text{susp}(T)$ is the maximum integer k such that T is a k -fold suspension.

The only n -tree with suspension index equal to n is the linear tree

$$U_n = [1] \rightarrow \dots \rightarrow [1].$$

We now define the source and target of a tree T to be equal to $\partial(T)$. So we have a globular structure on the set of all trees. We actually have more. The trees form an ω -category Tr with the set of n -cells being equal to the set of the trees of height n . If two n -trees S and T have the same k -sources and k -targets (i.e. $\partial^{n-k}T = \partial^{n-k}S$) then they can be composed, and the composite will be denoted by $S \otimes_k T$. Then $z(T)$ is the identity of the n -cell T . Here are examples of the 2-categorical operations on trees

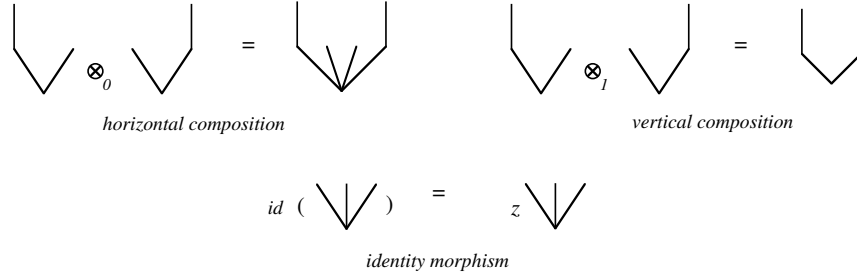

The ω -category Tr is actually the free ω -category generated by the terminal globular set. Every n -tree can be considered as a special sort of n -pasting diagram called *globular*. This construction was called the \star -construction in [5]. Here are a couple of examples.

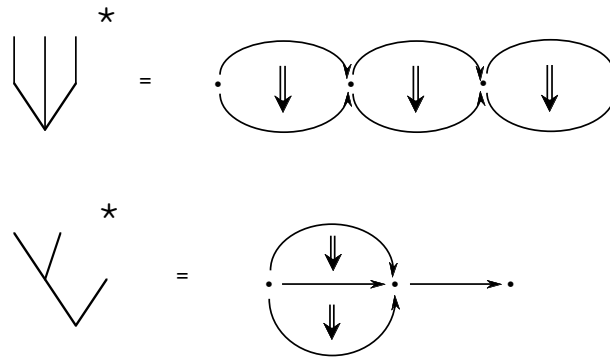

For a globular set X one can then form the set $D(X)$ of all globular pasting diagrams labelled in X . This is the free ω -category generated by X . In this way we have a monad (D, μ, ϵ) on the category of globular sets, which plays a central role in our work [5].

In particular, $D(1) = Tr$. We also can consider $D(Tr) = D^2(1)$. It was observed in [5, p.80-81] that the n -cells of $D(Tr)$ which were called in [5, p.80] diagrams of n -stage trees, can be identified with the morphisms of another category of n -planar trees (or the same as open maps of n -disks) introduced by A.Joyal in [24]. This category was called Ω_n in [8, p.10]. It was found that the collection of categories $\Omega_n, n \geq 0$, forms an ω -category in Cat and, moreover, it is freely generated by an internal ω -category (called globular monoid in [8]). So it is a higher dimensional analogue of the category $\Delta_{atg} = \Omega_1$ (which is of course the free monoidal category generated by a monoid [29]). A general theory of such universal objects is developed in section 7 of our paper. We also would like to mention that C.Berger also describes maps in Ω_n in [11, 1.8-1.9] as dual to his *cover* maps of trees.

The definition below is taken from [24] but also presented in [8][p.11].

Definition 4.3 *The category Ω_n has as objects the trees of height n . The morphisms of Ω_n are commutative diagrams*

$$\begin{array}{ccccccc}
 [k_n] & \xrightarrow{\rho_{n-1}} & [k_{n-1}] & \xrightarrow{\rho_{n-2}} & \cdots & \xrightarrow{\rho_0} & [1] \\
 \sigma_n \downarrow & & \sigma_{n-1} \downarrow & & & & \sigma_0 \downarrow \\
 [s_n] & \xrightarrow{\xi_{n-1}} & [s_{n-1}] & \xrightarrow{\xi_{n-2}} & \cdots & \xrightarrow{\xi_0} & [1]
 \end{array}$$

of sets and functions such that for all i and all $j \in [k_{i-1}]$ the restriction of σ_i to $\rho_{i-1}^{-1}(j)$ preserves the natural order on it.

Let T be an n -tree and let i be a leaf of height m of T . Then i determines a unique morphism $\xi_i : z^{n-m}U_m \rightarrow T$ in Ω_n such that $\xi_i(1) = i$. We will often identify the leaf with this morphism.

Let $\sigma : T \rightarrow S$ be a morphism in Ω_n and let i be a leaf of T . Then *the fiber of σ over i* is the following pullback in Ω_n

$$\begin{array}{ccc}
 \sigma^{-1}(i) & \longrightarrow & z^{n-m}U_m \\
 \downarrow & & \downarrow \xi_i \\
 T & \xrightarrow{\sigma} & S
 \end{array}$$

which can be calculated as a levelwise pullback in *Set*.

Now, for a morphism $\sigma : T \rightarrow S$ one can construct a labelling of the pasting scheme S^* in the ω -category Tr by associating to a vertex i from S the fiber of σ over i . The result of the pasting operation will be exactly T . We will use extensively this correspondence between morphisms in Ω_n and pasting schemes in Tr .

Some trees will play a special role in our paper. We will denote by M_l^j the tree

$$\underbrace{U_n \otimes_l \cdots \otimes_l U_n}_{j\text{-times}}.$$

A picture for M_l^j is as follows

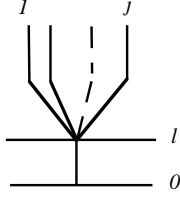

Now let T be a tree with $\text{susp}(T) = l$. Then it is easy to see that we have a unique representation

$$T = T_1 \otimes_l \dots \otimes_l T_j$$

where $\text{susp}(T_i) > l$. In [5] we called this representation the *canonical decomposition* of T . We also will refer to the canonical decomposition when talking about the morphism

$$T \longrightarrow M_l^j$$

it generates.

5 n-Operads in symmetric monoidal categories

It is clear from the definitions of the previous section that the assignment to an n -tree

$$S = [k_n] \rightarrow [k_{n-1}] \rightarrow \dots \rightarrow [1]$$

of its ordinal of tips $[k_n]$ gives us a functor

$$[-] : \Omega_n \rightarrow \Omega^s. \quad (5.1)$$

We also introduce the notation $|S|$ for the number of tips of the n -tree S .

Here and in all subsequent sections a fiber of a morphism $\sigma : T \rightarrow S$ in Ω_n will mean only a fiber over a tip of S . So every $\sigma : T \rightarrow S$ with $|S| = k$ determines a list of trees T_1, \dots, T_k being fibers over tips of S ordered according to the order in $[S]$. From now on we will always relate to σ this list of trees in this order.

The definition below is a specialisation of a general definition of n -operad in an augmented monoidal n -globular category M given in [5]. Let (V, \otimes, I) be a (strict) symmetric monoidal category. Put $M = \Sigma^n V$, which means that M has terminal categories up to dimension $n - 1$ and V in dimension n . The augmented monoidal structure is given by $\otimes_i = \otimes$ for all i . Then an n -operad in V will mean an n -operad in $\Sigma^n V$. Explicitly it means the following.

Definition 5.1 *An n -operad in V is a collection A_T , $T \in \Omega_n$, of objects of V equipped with the following structure :*

- a morphism $e : I \rightarrow A_{U_n}$ (the unit);
- for every morphism $\sigma : T \rightarrow S$ in Ω_n , a morphism

$$m_\sigma : A_S \otimes A_{T_1} \otimes \dots \otimes A_{T_k} \rightarrow A_T \quad (\text{the multiplication}).$$

They must satisfy the following identities:
- for any composite $T \xrightarrow{\sigma} S \xrightarrow{\omega} R$, the associativity diagram

$$\begin{array}{ccc}
A_R \otimes A_{S_\bullet} \otimes A_{T_1^\bullet} \otimes \dots \otimes A_{T_i^\bullet} \otimes \dots \otimes A_{T_k^\bullet} & \simeq & A_R \otimes A_{S_1} \otimes A_{T_1^\bullet} \otimes \dots \otimes A_{S_i} \otimes A_{T_i^\bullet} \otimes \dots \otimes A_{S_k} \otimes A_{T_k^\bullet} \\
\downarrow & & \downarrow \\
A_S \otimes A_{T_1^\bullet} \otimes \dots \otimes A_{T_i^\bullet} \otimes \dots \otimes A_{T_k^\bullet} & & A_R \otimes A_{T_\bullet} \\
& \searrow & \swarrow \\
& A_T &
\end{array}$$

commutes, where

$$A_{S_\bullet} = A_{S_1} \otimes \dots \otimes A_{S_k},$$

$$A_{T_i^\bullet} = A_{T_i^1} \otimes \dots \otimes A_{T_i^{m_i}}$$

and

$$A_{T_\bullet} = A_{T_1} \otimes \dots \otimes A_{T_k};$$

- for an identity $\sigma = id : T \rightarrow T$ the diagram

$$\begin{array}{ccc}
A_T \otimes A_{U_n} \otimes \dots \otimes A_{U_n} & \longleftarrow & A_T \otimes I \otimes \dots \otimes I \\
\downarrow & \swarrow id & \\
A_T & &
\end{array}$$

commutes;

- for the unique morphism $T \rightarrow U_n$ the diagram

$$\begin{array}{ccc}
A_{U_n} \otimes A_T & \longleftarrow & I \otimes A_T \\
\downarrow & \swarrow id & \\
A_T & &
\end{array}$$

commutes.

The definition of morphism of n -operads is the obvious one, so we have a category of n -operads in V which we will denote by $O_n(V)$.

We give an example of a 2-operad to provide the reader with a feeling of how these operads look. Other examples will appear later in the course of the paper.

Example 5.1 One can construct a 2-operad G in Cat such that the algebras of G in Cat are braided strict monoidal categories. If we apply the functor τ to G (i.e. consider it as a 1-terminal operad in $Span(Cat)$) then the algebras of $\tau(G)$

are Gray-categories [22]. The categories G_T are chaotic groupoids with objects corresponding to so called T -shuffles. The nice geometrical pictures below show these groupoids in some low dimensions.

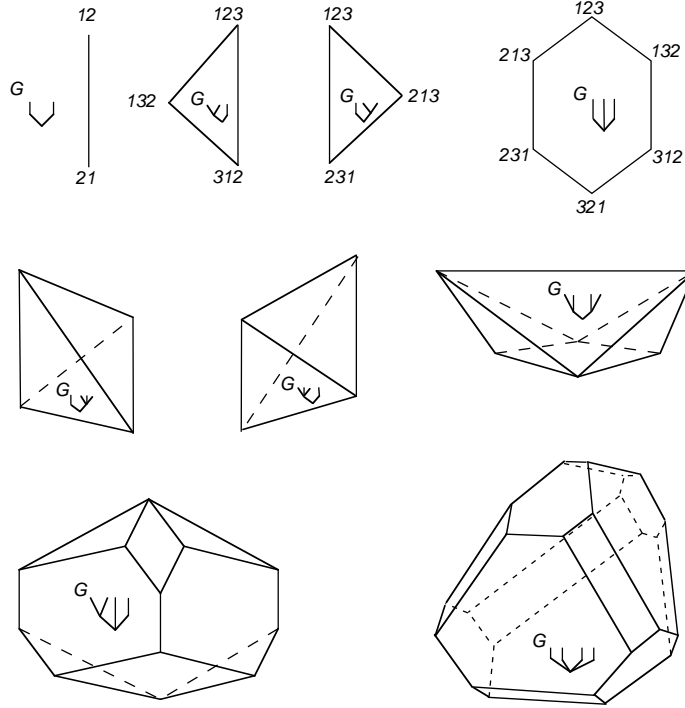

In general, the groupoid G_T is generated by the 1-faces of the so-called T -shuffle convex polytopes P_T [6] which themselves form a topological 2-operad. The polytope P_T is a point if T has only one tip. The polytope $P_{M_0^j}$ is the permutohedron P_j , and the polytope $P_{M_1^p \otimes_0 M_1^q}$ is the resultohedron N_{pq} [25, 20]. We finish this example by presenting a picture for multiplication in P (or G if you like). The reader might find this picture somewhat familiar.

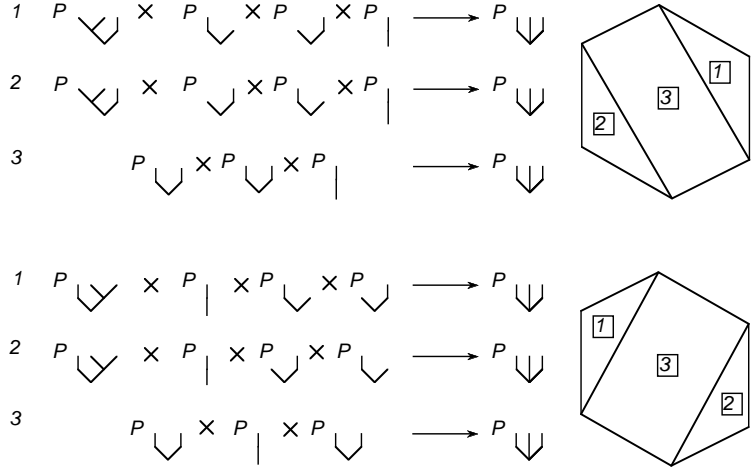

There are similar pictures for higher dimensions. In general the multiplication in P produces some subdivisions of P_T into products of shuffle polytopes of low dimensions. Some special cases of these subdivisions were discovered in [25]. Two new examples are presented below.

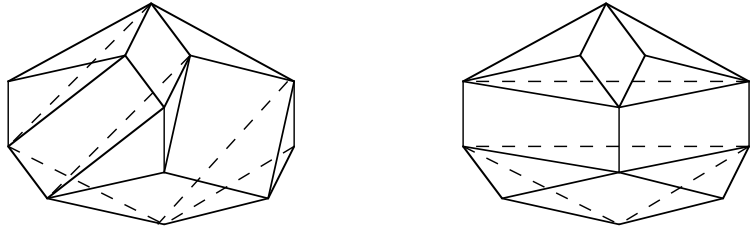

6 Desymmetrisation of symmetric operads

We define the desymmetrisation of an S -operad $A \in O^s(V)$ as a pullback along the functor (5.1).

However, since we prefer to work with left symmetric operads the following explicit definition of the desymmetrisation functor will be used in the rest of this paper.

Let A be a left symmetric operad in V with multiplication m and unit e .

Then an n -operad $Des_n(A)$ is defined by

$$Des_n(A)_T = A_{|T|},$$

with unit morphism

$$e : I \longrightarrow A_{U_n} = A_1$$

and multiplication

$$m_\sigma : A_{|S|} \otimes A_{|T_1|} \otimes \dots \otimes A_{|T_k|} \xrightarrow{m} A_{|T|} \xrightarrow{\pi(\sigma)^{-1}} A_{|T|}$$

for $\sigma : T \rightarrow S$. We, therefore, have a functor

$$Des_n : SO_t(V) \longrightarrow O_n(V).$$

Now we will consider how the desymmetrisation functor acts on endomorphism operads.

Let us recall a construction from [5]. If M is a monoidal globular category then a corollary of the coherence theorem for monoidal globular categories [5] says that M is a pseudo algebra of the monad D on the 2-category of globular categories. So we have an action $k : D(M) \rightarrow M$ and an isomorphism in the square

$$\begin{array}{ccc} D^2(M) & \xrightarrow{D(k)} & D(M) \\ \mu \downarrow & \swarrow \cong & \downarrow k \\ D(M) & \xrightarrow{k} & M \end{array}$$

If $x : 1 \rightarrow M$ is a globular object of M then the composite

$$t : D(1) \xrightarrow{D(x)} D(M) \xrightarrow{k} M$$

can be considered as a globular version of the tensor power functor. The value of this functor on a tree T is denoted by x^T . Moreover, the square above gives us an isomorphism χ :

$$\begin{array}{ccc} D^2(1) & \xrightarrow{D(t)} & D(M) \\ \mu \downarrow & \swarrow \chi \cong & \downarrow k \\ D(1) & \xrightarrow{t} & M \end{array}$$

This isomorphism χ gives a canonical isomorphism

$$\chi : x^{T \otimes_l S} \rightarrow x^T \otimes_l x^S,$$

for example.

In the special case of $M = \Sigma^n(V)$, we identify globular objects of $\Sigma^n(V)$ with objects of V and follow the constructions from [5] to get the following inductive description of the tensor power functor and isomorphism χ .

For the k -tree T , $k \leq n$, and an object x from V , let us define the object x^T in the following inductive way:

- if $k < n$, then $x^T = I$;
- if $k = n$ and $T = zT'$ then $x^T = I$;
- if $k = n$ and $T = U_n$, then $x^T = x$;
- now we use induction on $\text{susp}(T)$: suppose we already have defined x^S for S such that $\text{susp}(S) \geq k + 1$, and let $T = T_1 \otimes_k \dots \otimes_k T_j$ be a canonical decomposition of T . Then we define

$$x^T = x^{T_1} \otimes \dots \otimes x^{T_j}.$$

Clearly, x^T is isomorphic to $\underbrace{x \otimes \dots \otimes x}_{|T| \text{-times}}$. Now we want to provide an explicit description of χ .

Lemma 6.1 *For $\sigma : T \rightarrow S$, the isomorphism*

$$\chi_\sigma : x^{T_1} \otimes \dots \otimes x^{T_k} \rightarrow x^T$$

is induced by the permutation inverse of the permutation $\pi(\sigma)$.

Proof. We will prove the lemma by induction.

If $S = U_n$ then χ_σ is the identity morphism. Suppose we already have proved our lemma for all σ 's with codomain being an $(l + 1)$ -fold suspension. As a first step we study χ_σ in the special case $\sigma : T \rightarrow M_l^k$.

Now we start another induction on $\text{susp}(T)$. If $\text{susp}(T) > l$ then σ factorises through one of the tips, so the fibers are either T or degenerate trees and we get

$$\chi_\sigma = id : I \otimes \dots \otimes x^T \otimes \dots I \rightarrow x^T.$$

If $\text{susp}(T) = l$ then we get

$$\chi_\sigma = id : x^{T_1} \otimes \dots \otimes x^{T_k} \rightarrow x^T.$$

Suppose we already have proved our lemma for all T with $\text{susp}(T) > m$. Now suppose we have a σ with $\text{susp}(T) = m < l$. In this case we have the canonical decomposition

$$T_i = T_i^1 \otimes_m \dots \otimes_m T_i^j,$$

where j is the same for all $1 \leq i \leq k$. Then χ_σ is equal to the composite

$$x^{T_1} \otimes \dots \otimes x^{T_k} = (x^{T_1^1} \otimes \dots \otimes x^{T_1^j}) \otimes \dots \otimes (x^{T_k^1} \otimes \dots \otimes x^{T_k^j}) \xrightarrow{\pi^{-1}}$$

$$\begin{aligned} & \xrightarrow{\pi^{-1}} (x^{T_1^1} \otimes \dots \otimes x^{T_k^1}) \otimes \dots \otimes (x^{T_1^j} \otimes \dots \otimes x^{T_k^j}) \xrightarrow{x_1 \otimes \dots \otimes x_j} \\ & \xrightarrow{x_1 \otimes \dots \otimes x_j} x^{T_1^1 \otimes \dots \otimes T_k^1} \otimes \dots \otimes x^{T_1^j \otimes \dots \otimes T_k^j} = x^T \end{aligned}$$

where π is the corresponding permutation and χ_i is already constructed by the inductive hypothesis as $\text{susp}(T_1^i \otimes_l \dots \otimes_l T_k^i) > m$. Again by induction χ_i is induced by the permutation $\pi(\phi_i)^{-1}$, where

$$\phi_i : T_1^i \otimes_l \dots \otimes_l T_k^i \rightarrow M_l^k.$$

So χ_σ is induced by $\Gamma(\pi(\omega); \pi(\phi_1), \dots, \pi(\phi_j))^{-1}$.

From the point of view of morphisms in Ω_n what we have used here is a decomposition of σ into

$$T \xrightarrow{\xi} M_m^j \otimes_l \dots \otimes_l M_m^j \xrightarrow{\omega} M_l^k.$$

Then we have $\pi = \Gamma(\pi(\omega); 1, \dots, 1)$. By construction we have $\pi(\xi_i) = 1$ and by the inductive hypothesis, $\pi(\xi) = \Gamma(1; \pi(\phi_1), \dots, \pi(\phi_j))$. By Lemma 3.1

$$\begin{aligned} \pi(\sigma) &= \pi(\xi) \cdot \Gamma(\pi(\omega); 1, \dots, 1) = \Gamma(1; \pi(\phi_1), \dots, \pi(\phi_j)) \cdot \Gamma(\pi(\omega); 1, \dots, 1) = \\ &= \Gamma(\pi(\omega); \pi(\phi_1), \dots, \pi(\phi_j)). \end{aligned}$$

So we have completed our first induction.

To complete the proof it remains to show the lemma when S is an arbitrary tree with $\text{susp}(S) = l$. Then we have a canonical decomposition $\omega : S \rightarrow M_l^j$ and we can form the composite

$$T \xrightarrow{\sigma} S \xrightarrow{\omega} M_l^j.$$

Since ω is an order preserving map, by Lemma 3.1 again,

$$\pi(\omega) = \pi(\sigma \cdot \omega) \cdot \Gamma(1; \pi(\sigma_1), \dots, \pi(\sigma_j)).$$

By the inductive hypothesis again we can assume that we already have proved our lemma for the σ_i 's and, by the previous argument, for $\sigma \cdot \omega$ as well. So the result follows.

♣

We now recall the construction of endomorphism operad from [5] in the special case of an augmented monoidal globular category equal to $\Sigma^n V$, where V is a closed symmetric monoidal category.

Let x be an object of V . The endomorphism n -operad of a is the following n -operad $\text{End}_n(x)$ in V . For a tree T ,

$$\text{End}_n(x)_T = V(x^T, x);$$

the unit of this operad is given by the identity

$$I \rightarrow V(x^{U_n}, x) = V(x, x).$$

of x . For a morphism $\sigma : T \rightarrow S$, the multiplication is given by

$$V(x^S, x) \otimes V(x^{T_1}, x) \otimes \dots \otimes V(x^{T_k}, x) \rightarrow V(x^S, x) \otimes V(x^{T_1}, x) \otimes \dots \otimes V(x^{T_k}, x) \rightarrow \\ \xrightarrow{1 \otimes V(\chi_{\sigma^{-1}, x^k})} V(x^S, x) \otimes V(x^T, x) \rightarrow V(x^T, x).$$

We also can form the usual symmetric endooperad of x in the symmetric closed monoidal category V [32]. Let us denote this operad by $End(x)$. Now we want to compare $End_n(x)$ with the n -operad $Des_n(End(x))$. In $End(x)$ the action of a bijection $\pi : [n] \rightarrow [n]$ is defined to be

$$V(x^n, x) \xrightarrow{V(\pi, x)^{-1}} V(x^n, x).$$

So, for $\sigma : T \rightarrow S$, we have in $Des_n(End(x))$ the multiplication

$$V(x^{|S|}, x) \otimes V(x^{|T_1|}, x) \otimes \dots \otimes V(x^{|T_k|}, x) \rightarrow V(x^{|S|}, x) \otimes V(x^{|T_1| + \dots + |T_k|}, x) \rightarrow \\ \rightarrow V(x^{|T|}, x) \xrightarrow{V(\pi(\sigma), x)} V(x^{|T|}, x).$$

The following proposition follows now from Lemma 6.1 and associativity of composition in V .

Proposition 6.1 *For any object $x \in V$, there is a natural isomorphism of n -operads*

$$End_n(x) \simeq Des_n(End(x)).$$

7 Internal algebras of cartesian monads

Suppose C is a category with finite limits. Recall that a monad (T, μ, ϵ) on C is called cartesian if T preserves pullbacks and μ and ϵ are cartesian natural transformations in the sense that all naturality squares for these transformations are pullbacks.

If (T, μ, ϵ) is a cartesian monad then it can be extended to a 2-monad $\mathbf{T} = (\mathbf{T}, \mu, \epsilon)$ on the 2-category $\mathbf{Cat}(C)$ of internal categories in C . Slightly abusing notation we will speak about categorical T -algebras, having in mind \mathbf{T} -algebras, if it does not lead to confusion. So we can speak of pseudo- T -algebras, strict morphisms or simply morphisms between T -algebras as well as strong or pseudo morphisms and lax-morphisms [12, 28]. The last notion requires some clarification because of the choice of direction of the structure cells. So we give the following definition:

Definition 7.1 *Let A and B be two categorical T -algebras. Then a lax-morphism $(f, \phi) : A \rightarrow B$ is a functor $f : A \rightarrow B$ together with a natural transformation*

$$\begin{array}{ccc}
T(A) & \longrightarrow & T(B) \\
\downarrow & \swarrow \phi & \downarrow \\
A & \longrightarrow & B
\end{array}$$

which must satisfy the usual coherence conditions [12, 28].

Notice that our terminology is different from [12] but identical with [28] : we call pseudo morphism what in [12] is called morphism between T -algebras. We introduce the following notations: Alg_T is the category of algebras of T , while \mathbf{CAlg}_T is the 2-category of categorical T -algebras and strict categorical T -algebras morphisms. Notice also that \mathbf{CAlg}_T is isomorphic to the 2-category of internal categories in the category of T -algebras.

We first make the following observation about algebras and pseudoalgebras in our settings¹.

Theorem 7.1 *Every pseudo- T -algebra is equivalent to a T -algebra in the 2-category of categorical pseudo- T -algebras and their pseudo morphisms.*

Proof. We can easily adapt the proof of the general coherence result from [33] since our monad T has the property of preserving functors which are isomorphisms on objects. That is, if $f : A \rightarrow B$ is such that f is an isomorphism on the objects of objects then the same is true for Tf .

♣

In practice, the pseudo- T -algebras are as important for us as strict T -algebras but in virtue of this theorem we should not worry about this difference.

Now observe, that the terminal category 1 is always a categorical T -algebra.

Definition 7.2 *Let A be a categorical T -algebra. An internal T -algebra a in A is given by a lax-morphism of T -algebras*

$$a : 1 \rightarrow A.$$

We have a notion of a natural transformation between internal T -algebras and so a category of internal T -algebras $IAlg_T(A)$.

Obviously, $IAlg_T(A)$ can be extended to a 2-functor

$$IAlg_T : \mathbf{CAlg}_T \rightarrow \mathbf{Cat}.$$

¹ I would like to thank S.Lack for explaining to me that the proof of Power's general coherence result works in this situation.

Theorem 7.2 *The 2-functor $IAlg_T$ is representable. The representing categorical T -algebra \mathbf{H}^T has a characteristic property that its simplicial nerve coincides with May's two sided bar construction $B_*(T, T, 1)$ i.e. with the cotriple resolution of the terminal T -algebra.*

Proof.

Consider the following part of the cotriple resolution of the terminal T -algebra in Alg_T

$$T(1) \begin{array}{c} \longleftarrow \\ \rightleftarrows \\ \longrightarrow \end{array} T^2(1) \begin{array}{c} \longleftarrow \\ \rightleftarrows \\ \longrightarrow \end{array} T^3(1)$$

Since T is cartesian, the object above is a truncated nerve of a categorical object \mathbf{H}^T in Alg_T . The Segal's conditions follow from the naturality square for the multiplication of T being a pullback.

Let us prove that \mathbf{H}^T is a strict codescent object [28, 35] of the terminal categorical T -algebra that is an appropriate weighted colimit of the following diagram $\mathbf{T}^*(1)$:

$$\mathbf{T}(1) \begin{array}{c} \longleftarrow \\ \rightleftarrows \\ \longrightarrow \end{array} \mathbf{T}^2(1) \begin{array}{c} \longleftarrow \\ \rightleftarrows \\ \longrightarrow \end{array} \mathbf{T}^3(1)$$

Recall [28, 35] that for a truncated cosimplicial category E^*

$$E^0 \begin{array}{c} \xrightarrow{d_0} \\ \xleftarrow{s_0} \\ \xrightarrow{d_1} \end{array} E^1 \begin{array}{c} \xrightarrow{d_0} \\ \xleftarrow{d_1} \\ \xrightarrow{d_2} \end{array} E^2$$

one can construct the descent category $Desc(E^*)$ whose objects are pairs (a, f) where a is an object of E^0 and $f : d_0(a) \rightarrow d_1(a)$ is a morphism of E^1 satisfying the conditions that $s_0(f)$ is the identity morphism of a and $d_1(f)$ is the composite of $d_2(a)$ and $d_0(f)$. A morphism in $Desc(E^*)$ from (a, f) to (b, g) is a morphism $u : a \rightarrow b$ such that $d_0(u) \cdot f = g \cdot d_1(u)$.

Let A be a categorical T -algebra and let

$$E^* = \mathbf{CAlg}_T(\mathbf{T}^*(1), A).$$

A direct verification demonstrates that $Desc(E^*)$ is isomorphic to the category $\mathbf{CAlg}_T(\mathbf{H}^T, A)$ ². Therefore, \mathbf{H}^T is a codescent object of $\mathbf{T}^*(1)$.

On the other hand

$$\mathbf{CAlg}_T(\mathbf{T}^k(1), A) \simeq \mathbf{Cat}(C)(\mathbf{T}^{k-1}(1), A)$$

and the data for the objects and morphisms in $Desc(E^*)$ amount to the data for a lax-morphisms and their transformations from 1 to A (see [28] for general and detailed consideration).

Finally, the simplicial nerve of \mathbf{H}^T coincides with the bar construction due to the fact that T is cartesian and, hence, all Segal's maps are isomorphisms

² As observed in [35] this is a general fact about the descent category of a truncated cosimplicial category obtained as $Hom(Ner(X), A)$ where $Ner(X)$ is a nerve of a category considered as a discrete truncated simplicial category.

♣

Corollary 7.2.1 *The categorical T -algebra \mathbf{H}^T has a terminal object given by its canonical internal T -algebra. In particular, it is contractible.*

Proof. The terminality of the internal algebra of \mathbf{H}^T follows from the pullback of naturality for the unit of the monad T .

♣

Example 7.1 Let $C = \mathit{Set}$ and M be the free monoid monad. It is well known that M is finitary and cartesian. The categorical pseudoalgebras of M are equivalent to monoidal categories. Then an internal M -algebra in a monoidal category V is just a monoid in V . The category \mathbf{H}^M is the category $\Delta_{alg} = \Omega_1$ of all finite ordinals.

Example 7.2 Let $C = \mathit{Glob}_n$ be the category of n -globular sets [5] and let D_n be the free n -category monad on Glob_n [5]. D_n is cartesian and finitary [37]. The algebras of D_n are n -categories, the categorical algebras are strict globular monoidal categories and pseudoalgebras are equivalent to globular monoidal categories [5]. An internal D_n -algebra was called an n -globular monoid in a monoidal globular category. The category \mathbf{H}^{D_n} is the monoidal globular category of trees (see section 4):

$$1 = \Omega_0 \begin{array}{c} \longleftarrow \\ \frac{t}{s} \\ \longrightarrow \end{array} \Omega_1 \begin{array}{c} \longleftarrow \\ \frac{t}{s} \\ \longrightarrow \end{array} \dots \begin{array}{c} \longleftarrow \\ \frac{t}{s} \\ \longrightarrow \end{array} \Omega_n .$$

Now, suppose we have two finitary monads S and T on cocomplete categories C and E respectively. Suppose also that there is a right adjoint $w : C \rightarrow E$ and a functor $d : \mathit{Alg}_S \rightarrow \mathit{Alg}_T$ making the following square commutative:

$$\begin{array}{ccc} \mathit{Alg}_S & \xrightarrow{d} & \mathit{Alg}_T \\ \downarrow U^S & & \downarrow U^T \\ C & \xrightarrow{w} & E \end{array}$$

Proposition 7.1 *The square above induces a commutative square of left adjoints. All together these adjunction can be included in a square which we will refer to as a commutative square of adjunctions*

$$\begin{array}{ccc}
Alg_S & \begin{array}{c} \xrightarrow{d} \\ \xleftarrow{p} \end{array} & Alg_T \\
\mathcal{F}^S \updownarrow U^S & & \mathcal{F}^T \updownarrow U^T \\
C & \begin{array}{c} \xrightarrow{w} \\ \xleftarrow{c} \end{array} & E
\end{array} \tag{7.1}$$

Proof. This is the Adjoint Lifting Theorem 4.5.6 from [13] and it also follows from Dubuc's adjoint triangle theorem [18] but for the sake of completeness we provide a proof below.

The problem here is to construct a functor p left adjoint to d . Immediately from the requirement of commutativity of the left adjoint square we have $p \mathcal{F}^T \simeq \mathcal{F}^S c$ if p exists. We use this relation as a definition of p on free algebras of the monad T . Notice also that from our assumption of finitariness and cocompleteness we get cocompleteness of the category Alg_T .

Let X be an arbitrary algebra of T . Then X is a canonical coequaliser in Alg_T :

$$X \leftarrow T(X) \rightrightarrows T^2(X).$$

The left adjoint p must preserve coequalisers so we define p on X as the following coequaliser in Alg_S :

$$p(X) \leftarrow \mathcal{F}^S c U^T(X) \rightrightarrows \mathcal{F}^S c U^T \mathcal{F}^T U^T(X).$$

The first morphism in this coequaliser is induced by the T -algebra structure on X . The second morphism is a component of the natural transformation

$$\mathcal{F}^S c \leftarrow \mathcal{F}^S c U^T \mathcal{F}^T \tag{7.2}$$

which we construct as follows.

The existence of the functor d making the first square commutative implies the existence of a natural transformation

$$\Phi = w U^S \mathcal{F}^S c \leftarrow U^T \mathcal{F}^T \tag{7.3}$$

which actually can be completed to a map of monads $\Phi \leftarrow T$. This gives us an adjoint natural transformation (or mate) $U^S \mathcal{F}^S c \leftarrow c U^T \mathcal{F}^S$. One more adjoint transformation gives us the transformation we required.

It is trivial to check that we have thus constructed a left adjoint to d .

♣

Corollary 7.1.1 *There is a canonical map of monads*

$$T \rightarrow U^T d \mathcal{F}^S c .$$

If, in addition, T and S are cartesian monads, the above results can be extended to the categorical level. Abusing notation once again, we will denote the categorical versions of the corresponding functors by the same letters if it does not lead to a confusion.

Definition 7.3 *Under the conditions of Proposition 7.1, an internal T -algebra inside a categorical S -algebra A is an internal T -algebra in $d(A)$.*

Let A be a categorical S -algebra. The internal T -algebras in A form a category $IAlg_T^S(A)$. Moreover, we have a 2-functor

$$IAlg_T^S : \mathbf{CAlg}_S \rightarrow \mathbf{Cat}.$$

Let us denote by G the composite $\mathcal{F}^S c$. Then the transformation 7.2 equips G with the structure of a module over the monad T . We will require this natural transformation to be cartesian which implies that the map of monads 7.3 is also cartesian.

Theorem 7.3 *Let S and T be finitary cartesian monads and assume that the transformation 7.2 is cartesian. Then the 2-functor $IAlg_T^S$ is representable. The representing categorical S -algebra $h^T = p(H^T)$ has the characteristic property that its nerve coincides with May's two-sided bar-construction $B_*(G, T, 1)$ i.e. with the image under p of the cotriple resolution of the terminal categorical T -algebra.*

Proof. The proof is analogous to the proof of the theorem 7.2 but we use the cartesianess of T -action on G to check that the Segal maps in the simplicial object

$$G(1) \rightrightarrows GT(1) \rightleftarrows GT^2(1) \dots$$

are isomorphisms.

♣

Example 7.3 A trivial case of the adjunction square 7.1 is a map of monads $I \rightarrow T$. The functor d in this case is just the forgetful functor and $p = \mathcal{F}^T$. So one can speak about an internal I -algebra inside a categorical T -algebra. Such an internal algebra amounts just to a morphism of internal categories

$$1 \rightarrow A.$$

We will call them *internal objects of A* . The corresponding representing T -algebra h^T will be denoted by H_d^T since this is a discretisation of the categorical T -algebra H^T and is given by the constant simplicial object $T(1)$.

Observe, that we can extend the functor d from the square 7.1 to the lax-morphisms between categorical S -algebras. For this we first observe that the

map of monads 7.3 induces a functor between corresponding categories of algebras and their lax-morphism. Then we can construct a natural functor from S -algebras and their lax-morphisms to Φ -algebras and their lax-morphisms. We leave the details to the reader.

Because $d(1) = 1$, we can construct a 2-natural transformation between 2-functors which we denote by δ (but we think of it as an internal version of the functor d):

$$\delta : IAlg_S \rightarrow IAlg_T^S,$$

which induces a canonical map between representing objects:

$$\zeta : h^T \rightarrow H^S . \quad (7.4)$$

Another way to construct this map is the following. The algebra H^S has a canonical internal S -algebra $1 \rightarrow H^S$. If we apply d to this lax morphism we will get

$$1 = d(1) \rightarrow d(H^S).$$

The last internal T -algebra can be represented by a map $H^T \rightarrow d(H^S)$ and by definition this gives a map 7.4 .

Summarizing we have the following

Theorem 7.4 *The functor δ is naturally isomorphic to ζ^* , the restriction functor along ζ . The left adjoint to δ is isomorphic to the left Kan extension along ζ in the 2-category of categorical S -algebras.*

8 Symmetrisation of n -operads

Let $Coll_n(V)$ be the category of $(n - 1)$ -terminal n -collections [5, section 6] i.e. the category of n -globular functors $Tr^{(n)} \rightarrow \Sigma^n V$. We can identify the objects of $Coll_n(V)$ with families of objects of V indexed by trees of height n . The morphisms are levelwise morphisms. The category of 1-collection $Coll_1(V)$ is, of course, the same as the category of nonsymmetric collections in the usual sense.

Theorem 8.1 *If V is a cocomplete symmetric monoidal category then the forgetful functor $R_n : O_n(V) \rightarrow Coll_n(V)$ is monadic with left adjoint F_n . The free n -operad monad \mathcal{F}_n on the category $Coll_n(Set)$ of Set n -collections is finitary and cartesian.*

Proof. We first give an inductive construction of the free $(n - 1)$ -terminal n -operad on an n -collection in a cocomplete symmetric monoidal category V .

Let us call an expression, given by an n -tree T , an *admissible* expression of arity T . We also have an admissible expression e of arity U_n . If $\sigma : T \rightarrow S$ is a morphism of trees and the admissible expressions $x_S, x_{T_1}, \dots, x_{T_k}$ of arities S, T_1, \dots, T_k respectively are already constructed then the expression $\mu_\sigma(x_S; x_{T_1}, \dots, x_{T_k})$ is also an admissible expression of arity T . We also introduce an obvious equivalence relation on the set of admissible expressions

generated by pairs of composable morphisms of trees and by two equivalences $T \sim \mu(T; e, \dots, e) \sim \mu(e; T)$ generated by the identity morphism of T and a unique morphism $T \rightarrow U_n$. Notice however, that there are morphisms of trees all of whose fibers are equal to U_n . We can form an admissible expression $\mu_\sigma(S; e, \dots, e)$ corresponding to such a morphism but it is not equivalent to S , unless σ is equal to the identity.

Now if $C \in \text{Coll}_n(V)$ then, with every admissible expression τ of arity T , we can associate by induction an object $C(\tau)$. We start from $C(T) = C_T, C(e) = I$ and put

$$C(\mu(x_S; x_{T_1}, \dots, x_{T_k})) = C(x_S) \otimes C(x_{T_1}) \otimes \dots \otimes C(x_{T_k}).$$

By the Mac Lane coherence theorem, this object depends on the equivalence class of an admissible expression only up to isomorphism. So, we choose a representative of $C(\tau)$ for every equivalence class of admissible expressions.

Now, the coproduct $\coprod_\tau C(\tau)$ over all equivalence classes of admissible expressions of arity T gives us an n -collection in V . We also have a copy of the unit object I of arity U_n which corresponds to the admissible expression e .

It is now a trivial exercise to check that in this way we indeed get a free $(n-1)$ -terminal n -operad $F^n(C)$ on C .

It is also very obvious that the monad $\mathcal{F}_n = R_n F_n$ is finitary and cartesian if $V = \text{Set}$. Indeed, every admissible expression τ determines a non-planar tree decorated by n -trees (this tree actually has a canonical planar structure inherited from the planar structure of decorations). Such a decorated tree gives a collection $\alpha(\tau)$ which is empty in arities which are not equal to any tree which is presented in the decoration of τ and equal to a p element set $\{1, \dots, p\}$ in arity S if S is presented in the decoration of τ exactly p times. Then

$$\mathcal{F}_n(C) = \coprod_\tau \text{Coll}_n(\alpha(\tau), C)$$

so \mathcal{F}_n is finitary and preserves pullbacks [37].

It is an easy exercise to check that the multiplication and unit of \mathcal{F}^n are cartesian natural transformations

♣

We have a functor

$$W_n : \text{Coll}_1(V) \rightarrow \text{Coll}_n(V)$$

defined on a nonsymmetric collection A as follows:

$$W_n(A)_T = A_{|T|}.$$

If V has coproducts then W_n has a left adjoint C_n :

$$C_n(B)_k = \coprod_{T \in \text{Tr}_n, |T|=k} B_T. \quad (8.1)$$

Theorem 8.2 *If V is a cocomplete symmetric monoidal category then the forgetful functor $R_\infty : SO_l(V) \rightarrow Coll_1(V)$ is monadic. The following square of right adjoints commutes*

$$\begin{array}{ccc}
SO_l(V) & \xrightarrow{Des_n} & O_n(V) \\
F_\infty \updownarrow R_\infty & & F_n \updownarrow R_n \\
Coll_1(V) & \xrightleftharpoons[C_n]{W_n} & Coll_n(V)
\end{array}$$

Therefore, by Proposition 7.1 this square can be completed to the following commutative square of adjoints

$$\begin{array}{ccc}
SO_l(V) & \xrightleftharpoons[Sym_n]{Des_n} & O_n(V) \\
F_\infty \updownarrow R_\infty & & F_n \updownarrow R_n \\
Coll_1(V) & \xrightleftharpoons[C_n]{W_n} & Coll_n(V)
\end{array}$$

The free symmetric operad monad $\mathcal{F}_\infty = R_\infty F_\infty$ on the category of nonsymmetric Set-collections is finitary and cartesian and the canonical right \mathcal{F}_n -action on $F_\infty C_n$ is cartesian.

Proof. The construction of the left adjoint $F_\infty(C)$ is classical:

$$F_\infty(C)_n = \coprod_{\tau} C(\tau)$$

where τ run over the set of planar trees with n marked leaves labelled by the natural numbers from 1 to n . The object $C(\tau)$ is the tensor product of the $C_{|v|}$, where v runs over all unmarked vertices of τ and $|v|$ is the valency (number of input edges) of v . The symmetric groups act by permutation of labels and the substitution operation is grafting. The properties of \mathcal{F}_∞ are obvious.

Now, if $V = Set$, the composite $F_\infty C_n \mathcal{F}_n(C)$ is given by the set of labelled planar trees whose unmarked vertices are decorated by admissible expressions. The number of tips of the arity of the decoration should be equal to the valency of the vertex. As was observed before each admissible expression determines a canonical planar tree. So an element of $F_\infty C_n \mathcal{F}_n(C)$ is given by the following data:

- a labelled planar tree τ ;
- an assignment of a planar tree ρ_v decorated by n -trees to each internal vertices $v \in \tau$ such that the number of leaves of ρ_v is equal to $|v|$;
- an assignment of an element $c \in C_T$ for each T from the decoration of ρ_v .

Then the action $F_\infty C_n \mathcal{F}_n(C) \rightarrow F_\infty C_n$ consists of gluing together the planar trees ρ_v according to the scheme provided by τ and forgetting the decorating n -trees. The labeling of leaves and decorations by elements of C remain in their places. This is obviously a cartesian transformation.

♣

We finish this section by a theorem which will show that the functor Sym_n from the commutative square from Theorem 8.1 is indeed a solution of the symmetrisation problem raised in Section 2.

Theorem 8.3 *For an n -operad A in a closed symmetric monoidal category V , its symmetrisation $Sym_n(A)$ from Theorem 8.1 is a solution of symmetrisation problem in the sense of Definition 2.2.*

Proof. Indeed, for an object $x \in V$, an A -algebra structure is given by a morphism of operads

$$k : A \rightarrow End_n(x).$$

By Proposition 6.1,

$$End_n(x) \simeq Des_n(End(x)),$$

and so k determines, and is uniquely determined by, a map of symmetric operads

$$Sym_n(A) \rightarrow End(x).$$

♣

9 Internal operads

In virtue of Theorem 8.2 we can develop a theory of internal n -operads inside categorical n -operads as well as consider internal n -operads and internal symmetric operads inside symmetric categorical operads. We would like to unpack our definition of internal operads and see what they really are on practice.

Let A and B be two n -operads in Cat . A *lax-morphism*

$$f : A \rightarrow B$$

consists of a collection of functors

$$f_T : A_T \rightarrow B_T$$

together with natural transformations

$$\begin{array}{ccc} A_S \times A_{T_1} \times \dots \times A_{T_k} & \longrightarrow & B_S \times B_{T_1} \times \dots \times B_{T_k} \\ \downarrow & \mu \swarrow & \downarrow \\ A_T & \longrightarrow & B_T \end{array}$$

for every $\sigma : T \rightarrow S$ and a morphism $\epsilon : e_B \rightarrow e_A$, where e_A, e_B are unit objects of A and B , respectively. They must satisfy the usual coherence conditions. If, however, μ and ϵ are identities the lax-morphism will be called an operadic morphism (operadic functor).

In the particular case $B = 1$, the terminal *Cat*-operad, a lax-morphism $a : 1 \rightarrow A$ is an internal operad in A . Explicitly this gives the following

Definition 9.1 *Let A be a categorical n -operad with multiplication m and unit object $e \in A_{U_n}$. An internal n -operad in A consists of a collection of objects $a_T \in A_T$, $T \in Tr_n$, together with a morphism*

$$\mu_\sigma : m(a_S; a_{T_1}, \dots, a_{T_k}) \longrightarrow a_T$$

for every morphism of trees $\sigma : T \rightarrow S$ and a morphism

$$\epsilon : e \longrightarrow a_{U_n}$$

which satisfy obvious conditions analogous to the conditions in the definition of n -operad.

A morphism $f : a \rightarrow b$ of internal n -operads is a collection of morphisms $f_T : a_T \rightarrow b_T$ compatible with the operadic structures in the obvious sense.

Definition 9.2 *Let A be a left symmetric operad in *Cat*. Then an internal n -operad in A is an internal n -operad in $Des_n(A)$.*

So an internal n -operad in a symmetric categorical operad is given by a collection of objects $a_T \in A_{|T|}$, $T \in Tr_n$, together with a morphism

$$\mu_\sigma : m(a_S; a_{T_1}, \dots, a_{T_k}) \longrightarrow \pi(\sigma)a_T$$

for every $\sigma : T \rightarrow S$ and

$$\epsilon : e \longrightarrow a_{U_n},$$

which satisfy associativity and unitary conditions.

For a notion of internal symmetric operad in a categorical symmetric operad we have a choice of three different presentations of the category of symmetric operads. For technical reason it will be more convenient for us to use left categorical symmetric operads yet the S -version for internal symmetric operads. That is, we consider internal algebras for the following square of adjoints

$$\begin{array}{ccc} SO_l(Set) & \xrightleftharpoons{\quad} & O^s(Set) \\ \begin{array}{c} \uparrow \\ F_\infty \\ \downarrow \\ \text{Coll}_1(Set) \end{array} & \begin{array}{c} \leftarrow \\ R_\infty \\ \rightarrow \end{array} & \begin{array}{c} \uparrow \\ F^s \\ \downarrow \\ \text{Coll}_1(Set) \end{array} \\ & \begin{array}{c} \xrightarrow{W=id} \\ \xleftarrow{C=id} \end{array} & \end{array}$$

where horizontal functors are the isomorphisms of categories described in section 3 and the functors F^s and R^s are determined by commutativity of this square. The result of this mixture is the following definition:

Definition 9.3 Let A be a symmetric categorical operad. An internal symmetric operad in A consists of a collection of objects $a_n \in A_n$, $n \geq 0$, together with a morphism

$$\mu_\sigma : m(a_k; a_{n_1}, \dots, a_{n_k}) \longrightarrow \pi(\sigma)a_n$$

for every $\sigma : [n] \rightarrow [k]$ in Ω^s , and

$$\epsilon : e \longrightarrow a_1,$$

which satisfy associativity and unitary conditions.

Example 9.1 Let C be a category. We can consider the endomorphism operad $End(C)$ of C in Cat . An internal 1-operad a in C is what we call a *multitensor* in C [7]. This is a sequence of functors

$$a_k : C^k \rightarrow C$$

satisfying the usual associativity and unitarity conditions. If a_k , $k \geq 1$, are isomorphisms then a is just a tensor product on C . Conversely, every tensor product on C determines, in an obvious manner, a multitensor on C .

It makes sense to consider categories enriched in a multitensor. In [7] we show that the category of algebras of an arbitrary higher operad A in $Span(C)$ is equivalent to the category of categories enriched over an appropriate multitensor on the category of algebras of another operad $B(A)$ which is some sort of delooping of A .

Example 9.2 The internal symmetric operads in $End(C)$ were considered by J.McClure and J.Smith [31] under the name of functor operads. These operads generalise symmetric monoidal structures on C in the same way as multitensors generalise monoidal structures.

Let \mathbf{CO}_n be the 2-category whose objects are categorical n -operads, morphisms are their operadic morphisms, and the 2-morphisms are operadic natural transformations. We have the 2-functor

$$IO_n : \mathbf{CO}_n \rightarrow Cat$$

which assigns to an operad A the category of internal n -operads in A .

Analogously, let \mathbf{SCO} be the 2-category of left symmetric categorical operads, their operadic functors, and operadic natural transformations. There is the 2-functor

$$IO_n^{sym} : \mathbf{SCO} \rightarrow Cat$$

which assigns to an operad A the category of internal n -operads in A . For $n = \infty$, the functor IO_∞^{sym} assigns the category of internal symmetric operads in A .

Theorem 9.1

- For every $1 \leq n < \infty$, there exists a categorical n -operad \mathbf{H}^n representing the 2-functor $IO_n : \mathbf{CO}_n \rightarrow \mathbf{Cat}$;
- there exists a categorical symmetric operad \mathbf{H}^∞ representing the 2-functor $IO_\infty^{sym} : \mathbf{SCO} \rightarrow \mathbf{Cat}$;
- For every $1 \leq n \leq \infty$, there exists a symmetric \mathbf{Cat} -operad \mathbf{h}^n representing the 2-functor $IO_n^{sym} : \mathbf{SCO} \rightarrow \mathbf{Cat}$;
- For a categorical symmetric operad A if the left adjoint sym_n to the internal desymmetrisation functor

$$\delta_n : IO_\infty^{sym}(A) \rightarrow IO_n^{sym}(A)$$

exists then on an internal n -operad a it is isomorphic to the left Kan extension of the representing operadic functor \tilde{a} along the canonical morphism of categorical symmetric operads

$$\zeta : \mathbf{h}^n \rightarrow \mathbf{H}^\infty.$$

Example 9.3 Let V be a symmetric strict monoidal category. Consider the following symmetric categorical operad V^\bullet :

$$V_n^\bullet = V,$$

the multiplication is given by iterated tensor product, the unit of V^\bullet is the unit object of V and the action of the symmetric groups is trivial.

Lemma 9.1 *There are the following isomorphisms of categories*

$$IO_\infty^{sym}(V^\bullet) \rightarrow SO_l(V)$$

$$IO_n^{sym}(V^\bullet) \rightarrow O_n(V).$$

The existence of one of the functors sym_n or Sym_n implies the existence of the other and moreover the following diagram commutes:

$$\begin{array}{ccc} IO_\infty^{sym}(V^\bullet) & \begin{array}{c} \xrightarrow{\delta_n} \\ \xleftarrow{\text{sym}_n} \end{array} & IO_n^{sym}(V^\bullet) \\ \downarrow & & \downarrow \\ SO_l(V) & \begin{array}{c} \xrightarrow{\text{Des}_n} \\ \xleftarrow{\text{Sym}_n} \end{array} & O_n(V) \end{array}$$

Proof. The proof is an easy exercise in definitions. ♣

10 Combinatorial aspects of internal operads

We will now show how to construct the categorical operads \mathbf{h}^n and \mathbf{H}^n combinatorially using theorems 7.2, 7.3. We concentrate first on the construction of \mathbf{h}^n .

Let Tr_n be the result of application of the functor C_n (see (8.1)) to the collection $\mathcal{F}_n(1)$. This collection is the set of objects of Ω_n with the grading according to the number of tips. Now we can form a free symmetric operad $\mathcal{F}_\infty(Tr_n)$ on this collection. The elements of $\mathcal{F}_\infty(Tr_n)$ are the objects of \mathbf{h}^n .

Now we want to define morphisms. We will do this by providing generators and relations.

Suppose we have a morphism $\sigma : T \rightarrow S$ in Ω_n and T_1, \dots, T_k is its list of fibers. Then we will have a generator

$$\gamma(\sigma) : \mu(S; T_1, \dots, T_k) \rightarrow \pi(\sigma)T$$

where μ is the multiplication in $\mathcal{F}_\infty(Tr_n)$. By the equivariance requirement, we also have morphisms

$$\begin{aligned} \mu(\pi S; \xi_1 T_1, \dots, \xi_k T_k) &= \Gamma(\pi; \xi_1, \dots, \xi_k) \mu(S; T_1, \dots, T_k) \longrightarrow \\ &\xrightarrow{\Gamma(\pi; \xi_1, \dots, \xi_k) \gamma(\sigma)} \pi \cdot \Gamma(\pi; \xi_1, \dots, \xi_k) (\sigma) T. \end{aligned}$$

For every composite

$$T \xrightarrow{\sigma} S \xrightarrow{\omega} R,$$

we will have a relation given by the commutative diagram:

$$\begin{array}{ccc} \mu(\mu(R; S_\bullet); T_1^\bullet, \dots, T_i^\bullet, \dots, T_k^\bullet) & = & \mu(R; \mu(S_1; T_1^\bullet), \dots, \mu(S_i; T_i^\bullet), \dots, \mu(S_k; T_k^\bullet)) \\ \downarrow & & \downarrow \\ \mu(\pi(\omega)S; T_1^\bullet, \dots, T_i^\bullet, \dots, T_k^\bullet) & & \mu(R; \pi(\sigma_1)T_1, \dots, \pi(\sigma_k)T_k) \\ & \searrow & \swarrow \\ & \pi(\sigma) \cdot \Gamma(\pi(\omega); 1, \dots, 1)T & = \pi(\sigma \cdot \omega) \cdot \Gamma(1_k; \pi(\sigma_1), \dots, \pi(\sigma_k))T \end{array}$$

We also have a generator

$$\epsilon : e \rightarrow U_n$$

and two commutative diagrams:

$$\begin{array}{ccc} \mu(T; U_n, \dots, U_n) & \longleftarrow & \mu(T; e, \dots, e) \\ \downarrow & \swarrow id & \\ T & & \end{array}$$

and

$$\begin{array}{ccc}
 \mu(U_n; T) & \longleftarrow & \mu(e; T) \\
 \downarrow & \swarrow \text{id} & \\
 T & &
 \end{array}$$

as relations.

This operad contains an internal n -operad given by $a_T = T$.

We can construct \mathbf{H}^n for all n including $n = \infty$ in the same fashion.

To better understand the structure of \mathbf{h}^n , we can describe it in terms of decorated planar trees.

An object of \mathbf{h}^n is a labelled planar tree with vertices decorated by trees from Tr_n in the following sense: to every vertex v of valency k we associate an n -tree with k -tips. The following picture illustrates the concept for $n = 2$.

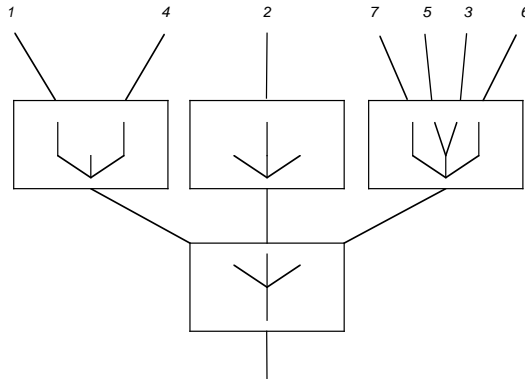

So, the objects of \mathbf{h}^n are labelled planar trees with some extra internal structure. The morphisms are contractions or growing of internal edges, yet not all contractions are possible. It depends on the extra internal structure. We can simultaneously contract the input edges of a vertex v only if the corresponding n -trees in the vertices above v can be pasted together in the n -category Tr_n according to the globular pasting scheme determined by the tree at the vertex v . In the above example we see that the trees on the highest level are fibers over a map of trees:

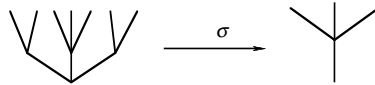

So in \mathbf{h}^2 we have a morphism corresponding to the σ from the object above to the object

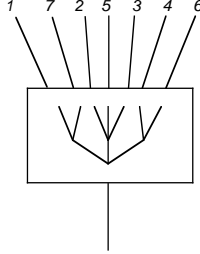

The case $n = 1$ is well known.

Indeed, with $n = 1$ all the decorations are meaningless. Yet, the morphisms in \mathbf{h}^1 correspond only to order-preserving maps between ordinals.

Therefore the operad \mathbf{h}^1 coincides with the symmetrisation of the nonsymmetric operad h described in [4], which is, indeed, \mathbf{H}^1 in our present terminology. For a discussion on it the reader may also look at [16]. The objects of \mathbf{H}_k^1 are bracketings of the strings consisting of several 0's and symbols $1, \dots, k$ in fixed order without repetition. Multiple bracketing like $((\dots))$ and also empty bracketing $()$ are allowable. The morphisms are throwing off 0's, removing and introducing a pair of brackets, and also a morphism $() \rightarrow (1)$. The symmetric groups act by permuting the symbols $1, \dots, k$. The operad multiplication is given by replacing one of the symbols by a corresponding expression.

It is clear that $\pi_0(\mathbf{h}_k^1) = \Sigma_k$ and all higher homotopy groups vanish. In other words \mathbf{h}^1 is an A_∞ -operad. The algebras of \mathbf{h}^1 in Cat are categories equipped with an n -fold tensor product satisfying some obvious associativity and unitality conditions. For example, instead of a single associativity isomorphism we will have two, perhaps noninvertible, morphisms from two different combinations of binary products to the triple tensor product; that is, a cospan

$$(a \otimes b) \otimes c \longrightarrow a \otimes b \otimes c \longleftarrow a \otimes (b \otimes c).$$

Instead of the pentagon, we will have a barycentric subdivision of it and so on. Such categories were called lax-monoidal in [16].

The operad \mathbf{H}^∞ is also classical. All the decorations again collapse to a point. But morphisms are more complicated and correspond to the maps of finite sets. So we can give the following description of the operad \mathbf{H}^∞ . A typical object of \mathbf{H}_n^∞ is a planar tree equipped with an injective function (labelling) from $[n]$ to the set of vertices of this tree. The symmetric group acts by permuting the labels. The morphisms are generated by contraction of an internal edge, growing of an internal edge, and dropping unlabelled leaves, with usual relations of associativity and unitality. We also will have an isomorphism $T \rightarrow \pi T$ for every permutation $\pi \in S_n$. This isomorphism should satisfy obvious equivariance conditions. Again the \mathbf{H}^∞ -algebras in Cat are symmetric lax-monoidal categories in the terminology of [17].

The internal operad is given by the trees

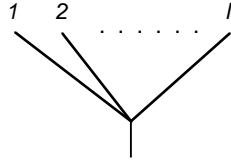

and this is a terminal object in \mathbf{H}^∞ . Hence, the nerve of \mathbf{H}^∞ is an E_∞ -operad.

Remark 10.1 The trees formalism from [21][Section 1.2] is actually a special case of our theorem 9.1 with $n = \infty$ and $A = V^\bullet$ for a symmetric monoidal category V .

To clarify the structure of \mathbf{h}^n for $2 \leq n < \infty$ we provide a part of the picture of \mathbf{h}_2^2 :

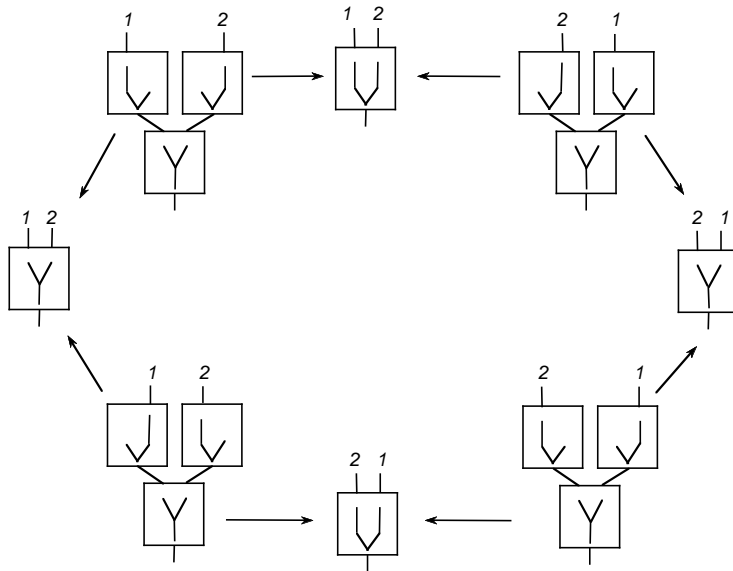

The reader can find an analogy with a diagram from the construction of the braiding in Proposition 5.3 from [23]. The reader may also look at a similar picture for the category $\tilde{\mathbf{m}}_2^2$ where $\tilde{\mathbf{m}}^2$ is a *Cat*-operad constructed in [3]. We also recommend the reader look at the picture of $\tilde{\mathbf{m}}_2^3$ in [3], which looks like a two dimensional sphere, and try to construct a similar picture in \mathbf{h}_2^3 . Of course, these are not accidental coincidences as we will show in the next paper [9].

11 Example: iterated monoidal category operad

First of all we briefly review the construction of the iterated monoidal category operad \mathbf{m}^n introduced in [3].

The objects of \mathbf{m}_k^n are all finite expressions generated by the symbols $1, \dots, k$ and n associative operations $\diamond_1, \dots, \diamond_n$ in which each generating symbol occurs exactly once. There is a natural left action of symmetric group on \mathbf{m}_k^n and an operation of substitution which provides an operadic structure on the objects of \mathbf{m}^n .

Now we can describe the morphisms in \mathbf{m}^n . They are generated by the middle interchange laws

$$\eta^{ij} : (1 \diamond_i 2) \diamond_j (3 \diamond_i 4) \rightarrow (1 \diamond_j 3) \diamond_i (2 \diamond_j 4), \quad j < i, \quad (11.1)$$

substitutions and permutations, and must satisfy the coherence conditions specified in the first section of [3]. It was shown in [3] that the operad \mathbf{m}^n is a poset operad. The algebras of \mathbf{m}^n in Cat are iterated n -monoidal categories, i.e. categories with n strict monoidal structures which are related by interchange morphisms (not necessary isomorphisms) satisfying some natural coherence conditions. They are also monoids in the category of iterated $(n - 1)$ -monoidal categories and they *lax* monoidal functors.

We also would like to introduce another categorical symmetric operad $\tilde{\mathbf{m}}^n$ which is constructed in the same way as \mathbf{m}^n but we use operations $\diamond_0, \dots, \diamond_{n-1}$ and we reverse the direction of the interchange law (11.1).

This is the picture of $\tilde{\mathbf{m}}_2^2$.

$$\begin{array}{ccc}
 & 1 \diamond_0 2 & \\
 \eta^{01} \nearrow & & \nwarrow \eta^{01} \\
 1 \diamond_1 2 & & 2 \diamond_1 1 \\
 \eta^{01} \searrow & & \swarrow \eta^{01} \\
 & 2 \diamond_0 1 &
 \end{array}$$

There is an obvious isomorphism of operads \mathbf{m}^n and $(\tilde{\mathbf{m}}^n)^{op}$. So the algebras of $\tilde{\mathbf{m}}^n$ are monoids in the category of iterated $(n - 1)$ -monoidal categories and their *oplax* monoidal functors. Of course, these two operads have the same homotopy type. We consider here the operad $\tilde{\mathbf{m}}^n$ simply because it is better adapted to our agreement about directions of middle interchange cells and numeration of operations, which makes our proof easier to follow.

Theorem 11.1 *The categorical symmetric operad \mathbf{m}^n contains both an internal n -operad and internal n -cooperad. The same is true for the operad $\tilde{\mathbf{m}}^n$.*

Remark 11.1 We did not discuss the notion of internal n -cooperad but it can be easily obtained from the definition of internal n -operad by inverting the structure cells.

Lemma 11.1 *Let the n -tree T be*

$$T = [k_n] \xrightarrow{\rho_{n-1}} [k_{n-1}] \xrightarrow{\rho_{n-2}} \dots \xrightarrow{\rho_0} [1]$$

then an element $u \diamond_i v$ is in a_T in the sense of [3] if and only if $u < v$ and

$$\rho_{n-1} \cdot \dots \cdot \rho_i(u) = \rho_{n-1} \cdot \dots \cdot \rho_i(v)$$

but

$$\rho_{n-1} \cdot \dots \cdot \rho_{i+1}(u) \neq \rho_{n-1} \cdot \dots \cdot \rho_{i+1}(v).$$

Now we want to construct the multiplication m_σ in the special case where

$$\sigma : T \longrightarrow M_k^2.$$

So we have to construct a morphism

$$m(1 \diamond_k 2; a_{T_1}, a_{T_2}) \longrightarrow \pi(\sigma)a_T.$$

According to [3] we have to check that $u \diamond_i v$ in $m(1 \diamond_k 2; a_{T_1}, a_{T_2})$ implies either $u \diamond_j v$ in $\pi(\sigma)a_T$ for $j \leq i$ or $v \diamond_j u$ in $\pi(\sigma)a_T$ for $j < i$.

Recall that $m(1 \diamond_k 2; a_{T_1}, a_{T_2}) = a_{T_1} \diamond_k a_{\bar{T}_2}$ where $a_{\bar{T}_2}$ is the same expression as a_{T_2} but all numbers are shifted on $|T_1|$. Let $\xi_i : T_i \rightarrow T, i = 1, 2$ be inclusions of T_i as i -th fiber.

Now, suppose $u \diamond_i v$ is in a_{T_1} . By our lemma it means that $u < v$ and

$$\rho_{n-1} \cdot \dots \cdot \rho_i(u) = \rho_{n-1} \cdot \dots \cdot \rho_i(v)$$

but

$$\rho_{n-1} \cdot \dots \cdot \rho_{i+1}(u) \neq \rho_{n-1} \cdot \dots \cdot \rho_{i+1}(v)$$

in T_1 . Hence, we have $\xi_1(u) < \xi_1(v)$ and

$$\rho_{n-1} \cdot \dots \cdot \rho_i(\xi_1(u)) = \rho_{n-1} \cdot \dots \cdot \rho_i(\xi_1(v))$$

but

$$\rho_{n-1} \cdot \dots \cdot \rho_{i+1}(\xi_1(u)) \neq \rho_{n-1} \cdot \dots \cdot \rho_{i+1}(\xi_1(v))$$

in T . But $\pi(\sigma)(\xi_1(w)) = w$ by definition of $\pi(\sigma)$. Therefore, $\pi(\sigma)^{-1}u < \pi(\sigma)^{-1}v$ and

$$\rho_{n-1} \cdot \dots \cdot \rho_i(\pi(\sigma)^{-1}u) = \rho_{n-1} \cdot \dots \cdot \rho_i(\pi(\sigma)^{-1}v)$$

but

$$\rho_{n-1} \cdot \dots \cdot \rho_{i+1}(\pi(\sigma)^{-1}u) \neq \rho_{n-1} \cdot \dots \cdot \rho_{i+1}(\pi(\sigma)^{-1}v)$$

in T . By our lemma it follows that $u \diamond_i v$ is in a_T .

The same argument applies if $u \diamond_i v$ is in $a_{\bar{T}_2}$ but all numbers must be shifted on $|T_1|$.

Now suppose u is in a_{T_1} but v is in $a_{\bar{T}_2}$. This means that $u \diamond_k v$ is in $a_{T_1} \diamond_k a_{\bar{T}_2}$.

We have two possibilities. The first is

$$\rho_{n-1} \cdot \dots \cdot \rho_k(u) = \rho_{n-1} \cdot \dots \cdot \rho_k(v)$$

where the first composite is in T_1 and the second is in T_2 . This means that

$$\rho_{n-1} \cdot \dots \cdot \rho_k(\xi_1(u)) = \rho_{n-1} \cdot \dots \cdot \rho_k(\xi_2(v))$$

already in T . But σ is a morphism of trees, hence, preserves order on fibers of ρ_k and we have $\xi_1(u) < \xi_2(v)$, hence, again $\pi(\sigma)^{-1}u < \pi(\sigma)^{-1}v$ and

$$\rho_{n-1} \cdot \dots \cdot \rho_k(\pi(\sigma)^{-1}u) = \rho_{n-1} \cdot \dots \cdot \rho_k(\pi(\sigma)^{-1}v)$$

and therefore $u \diamond_k v$ is in $\pi(\sigma)a_T$.

The last possibility is

$$\rho_{n-1} \cdot \dots \cdot \rho_l(u) = \rho_{n-1} \cdot \dots \cdot \rho_l(v)$$

for some $l < k$ but

$$\rho_{n-1} \cdot \dots \cdot \rho_{l+1}(u) \neq \rho_{n-1} \cdot \dots \cdot \rho_{l+1}(v)$$

again in T_1 and T_2 respectively. Then

$$\rho_{n-1} \cdot \dots \cdot \rho_l(\xi_1(u)) = \rho_{n-1} \cdot \dots \cdot \rho_l(\xi_2(v))$$

for some $l < k$; but

$$\rho_{n-1} \cdot \dots \cdot \rho_{l+1}(\xi_1(u)) \neq \rho_{n-1} \cdot \dots \cdot \rho_{l+1}(\xi_2(v))$$

already in T . By the usual argument it follows that either $u \diamond_l v$ or $v \diamond_l u$ is in $\pi(\sigma)a_T$, and that finishes the proof of the special case.

Now, suppose we have constructed m_σ for all σ whose codomain is $S = M_k^j$ and where $j \leq m$. Then, for $S = M_k^{m+1}$,

$$a_S = m(1 \diamond_k 2; a_{S_1}, a_{S_2})$$

and an easy inductive argument can be applied.

In general, let $\sigma : T \rightarrow S$ be a morphism of trees. If $S = U_n$ then we put $\mu_\sigma = id$. Now suppose we already have constructed μ_σ for all σ with codomain being an $(n-k)$ -fold suspension. Let S be an $(n-k-1)$ -fold suspension. Then the canonical decomposition of S gives us

$$\omega : S \rightarrow M_{n-k-1}^j$$

with $(n-k)$ -fold suspensions S_i , $1 \leq i \leq r$, as fibers. We have

$$\begin{aligned} m(a_S; a_{T_1}, \dots, a_{T_k}) &= m(m(1 \diamond_{n-k-1} \dots \diamond_{n-k-1} r; a_{S_1}, \dots, a_{S_r}), a_{T_1}, \dots, a_{T_k}) = \\ &= m(1 \diamond_{n-k-1} \dots \diamond_{n-k-1} r; m(a_{S_1}; a_{T_1^1}, \dots, a_{T_1^{m_1}}), \dots, m(a_{S_r}; a_{T_r^1}, \dots, a_{T_r^{m_r}})). \end{aligned}$$

By the inductive hypothesis we already have m_{σ_i} for the fibers of σ . So we have a morphism

$$m(1, m_{\sigma_1}, \dots, m_{\sigma_r}) : m(1 \diamond_{n-k-1} \dots \diamond_{n-k-1} r; m(a_{S_1}; a_{T_1^1}, \dots, a_{T_1^{m_1}}), \dots,$$

$\dots, m(a_{S_r}; a_{T_1^1}, \dots, a_{T_r^{m_r}}) \longrightarrow m(1 \diamond_{n-k-1} \dots \diamond_{n-k-1} r; \pi(\sigma_1)a_{T_1^1}, \dots, \pi(\sigma_r)a_{T_r^1}),$

where T_1^1, \dots, T_r^1 are fibers of $\sigma \cdot \omega$. But

$$\begin{aligned} & m(1 \diamond_{n-k-1} \dots \diamond_{n-k-1} r; \pi(\sigma_1)a_{T_1^1}, \dots, \pi(\sigma_r)a_{T_r^1}) = \\ & = \Gamma(1, \pi\sigma_1, \dots, \pi\sigma_r)m(1 \diamond_{n-k-1} \dots \diamond_{n-k-1} r; a_{T_1^1}, \dots, a_{T_r^1}). \end{aligned}$$

Now we already have the morphism

$$m_{\sigma \cdot \omega} : m(1 \diamond_{n-k-1} \dots \diamond_{n-k-1} r; a_{T_1^1}, \dots, a_{T_r^1}) \rightarrow \pi(\sigma \cdot \omega)a_T.$$

So we have

$$\begin{aligned} \Gamma(1, \pi\sigma_1, \dots, \pi\sigma_r)m_{\sigma \cdot \omega} : \Gamma(1, \pi\sigma_1, \dots, \pi\sigma_r)m(1 \diamond_{n-k-1} \dots \diamond_{n-k-1} r; a_{T_1^1}, \dots, a_{T_r^1}) &\rightarrow \\ &\rightarrow \Gamma(1, \pi\sigma_1, \dots, \pi\sigma_r)\pi(\sigma \cdot \omega)a_T. \end{aligned}$$

By Lemma 3.1,

$$\Gamma(1, \pi\sigma_1, \dots, \pi\sigma_r)\pi(\sigma \cdot \omega) = \Gamma(\pi(\omega), 1, \dots, 1)\pi(\sigma).$$

But ω is order preserving, hence, the last permutation is $\pi(\sigma)$. So the composite

$$m(1, m_{\sigma_1}, \dots, m_{\sigma_r}) \cdot \Gamma(1, \pi\sigma_1, \dots, \pi\sigma_r)m_{\sigma \cdot \omega}$$

gives us the required morphism

$$\mu_\sigma : m(a_S; a_{T_1}, \dots, a_{T_k}) \longrightarrow \pi(\sigma)a_T.$$

Associativity and unitality of this multiplication are trivial because $\tilde{\mathbf{m}}^n$ is a poset operad.

♣

In [3], a morphism of categorical operads

$$\mathbf{m}^n \longrightarrow \mathcal{K}^{(n)}$$

is constructed. Here $\mathcal{K}^{(n)}$ is the n -th filtration of Berger's complete graph operad [10], which plays a central role in his theory of cellular operads. So we have

Corollary 11.1.1 $\mathcal{K}^{(n)}$ contains an internal n -operad and an internal n -cooperad.

12 Free internal operads

In this section we apply the techniques described in Theorem 9.1 to get some formulas which will be of use in the final section as well as in [9].

Definition 12.1 We call a categorical n -operad cocomplete if each category A_T is cocomplete and multiplication in A preserves colimits in each variable. We give a similar definition of cocompleteness for symmetric operads.

An internal object in an n -operad A (see example on page 31) will be called an *internal n -collection in A* . So we have a category of internal n -collections $IColl_n(A)$ and the corresponding categorical operad \mathbf{H}_d^n which represents this 2-functor.

Example 12.1 Let $A = Des_n(V^\bullet)$ for a symmetric monoidal category V . Then the category $IColl_n(A)$ is isomorphic to the category $Coll_n(V)$ of n -collections in V .

Given an internal n -collection x in A we will denote by $\tilde{x} : \mathbf{H}_d^n \rightarrow A$ the corresponding operadic functor.

Theorem 12.1 *Let A be a cocomplete categorical n -operad.*

The free internal n -operad on an n -collection x is given by the formula

$$\mathcal{F}_n(x)_T = \coprod_{W \in \mathbf{H}_T^n} \tilde{x}(W).$$

More generally, the k -th iteration of \mathcal{F} is given by the formula

$$\mathcal{F}_n^k(x)_T = \coprod_{\substack{f_1 \\ W_1 \leftarrow W_2 \leftarrow \dots \leftarrow W_k}} \tilde{x}(W_k),$$

where f_1, \dots, f_{k-1} are morphisms in \mathbf{H}_T^n .

Proof. The left Kan extension in the 2-category of categorical n -collections of \tilde{x} along the inclusion $i : \mathbf{H}_d^n \rightarrow \mathbf{H}^n$ is given by the following formula

$$Lan_i(\tilde{x})(W) = \coprod_{W \leftarrow W'} \tilde{x}(W'). \quad (12.1)$$

We are going to prove that it is also a left Kan extension in \mathbf{CO}_n . We have thus to show that the functor Lan_i is operadic.

Indeed, let $\sigma : T \rightarrow S$ be a morphism of trees and let $W_S \in \mathbf{H}_S^n, W_1 \in \mathbf{H}_{T_1}^n, \dots, W_k \in \mathbf{H}_{T_k}^n$. Then

$$\begin{aligned} & \mu_A(Lan_i(\tilde{x})(W_S); Lan_i(\tilde{x})(W_1), \dots, Lan_i(\tilde{x})(W_k)) \simeq \\ & \simeq \coprod_{W_S \leftarrow W'_S, W_1 \leftarrow W'_1, \dots, W_k \leftarrow W'_k} \tilde{x}(W'_S) \times \tilde{x}(W'_1) \times \dots \times \tilde{x}(W'_k) = \\ & = \coprod_{\mu(W_S; W_1, \dots, W_k) \leftarrow \mu(W'_S; W'_1, \dots, W'_k)} \tilde{x}(\mu(W'_S; W'_1, \dots, W'_k)) \simeq \\ & \simeq \coprod_{\mu(W_S; W_1, \dots, W_k) \leftarrow W'} \tilde{x}(W') = Lan_i(\tilde{x})(\mu(W_S; W_1, \dots, W_k)), \end{aligned}$$

since \tilde{x} is an operadic functor and by the inductive construction of objects and morphisms in \mathbf{H}^n . Analogously one can prove that the counit of this adjunction

is operadic. It is straightforward now to show that this is really an operadic adjunction.

Let us denote by \mathbf{Lan} the monad generated by the adjunction $Lan_i \dashv i^*$. Then from the formula (12.1) we have the following formula for the iteration of this monad:

$$\mathbf{Lan}^k(\tilde{x})(W) = \coprod_{\begin{array}{c} f_0 \\ W \leftarrow W_1 \leftarrow W_2 \leftarrow \dots \leftarrow W_k \end{array}} \tilde{x}(W_k), \quad (12.2)$$

where f_0, \dots, f_{k-1} are morphisms in \mathbf{H}^n .

To obtain the formula for the free operad it is enough to evaluate the formula (12.1) at T . Since T is the terminal object in \mathbf{H}_T^n we get the formula as in the statement of the theorem. Analogously one obtains the formula for the iterated free operad monad.

♣

Remark 12.1 We will encounter a similar situation with the calculation of a Kan extension in Theorem 13.1.

The analogous result holds in the case of symmetric operads.

Theorem 12.2 *Let A be a cocomplete symmetric categorical operad.*

The free internal symmetric operad on a nonsymmetric internal collection x is given by the formula

$$\mathcal{F}_\infty(x)_m = \coprod_{W \in \mathbf{H}_m^\infty} \tilde{x}(W).$$

More generally, the k -th iteration of \mathcal{F}_∞ is given by the formula

$$\mathcal{F}_\infty^k(x)_m = \coprod_{\begin{array}{c} f_1 \\ W_1 \leftarrow W_2 \leftarrow \dots \leftarrow W_k \end{array}} \tilde{x}(W_k),$$

where f_1, \dots, f_{k-1} are morphisms in \mathbf{H}_m^∞ .

13 Colimit formula for symmetrisation

Now we return to the study of the canonical operadic functor

$$\zeta : \mathbf{h}^n \rightarrow \mathbf{H}^\infty$$

Lemma 13.1 *For $n \geq 2$ the functor ζ is final (in the sense of [29]).*

Proof. The functor ζ is surjective on objects by construction. Hence, it will be sufficient to prove that, for any morphism $f : a \rightarrow b$ in \mathbf{H}^∞ and any objects

$a', b' \in \mathbf{h}^n$ such that $\zeta(a') = a$ and $\zeta(b') = b$, there exist a chain of morphisms in \mathbf{h}^n

$$b' \leftarrow x_1 \rightarrow \dots \leftarrow x_{i+1} \xrightarrow{f'} x_i \leftarrow \dots \leftarrow x_m \rightarrow a'$$

with the following properties:

- there exists an $0 \leq i \leq m$ such that $\zeta(f') = f$;
- the image under ζ of any other arrow is either a retraction or its right inverse;
- the image under ζ of a composite of the appropriate morphisms or their inverses gives an identity $\zeta x_i \rightarrow a$;
- the image under ζ of a composite of the appropriate morphisms or their inverses gives an identity $\zeta x_{i+1} \rightarrow b$.

If these all are the case then the following commutative diagram provides a path between any two objects in the comma-category of ζ under the object a from \mathbf{H}^∞ .

$$\begin{array}{ccccc}
 \zeta(b) & \xleftarrow{f} & a & \xrightarrow{g} & \zeta(c) \\
 id \uparrow & \swarrow f & \searrow id & \searrow id & \uparrow id \\
 \zeta(x_i) & & & & \zeta(y_j) \\
 & \swarrow f & \searrow id & \searrow id & \\
 \zeta(x_{i+1}) & & \zeta(a') & \xrightarrow{id} & \zeta(y_{j+1})
 \end{array}$$

It is clear that it will be enough to show that the above property holds for a generating morphism

$$f : \mu([k]; [n_1], \dots, [n_k]) \longrightarrow \pi(\sigma)[m]$$

which corresponds to the morphism of ordinals $\sigma : [m] \rightarrow [k]$.

Let the trees T, S and T_1, \dots, T_k be such that

$$\zeta(T) = [m] ,$$

$$\zeta(S) = [k] ,$$

$$\zeta(T_i) = [m_i], \quad 1 \leq i \leq k.$$

Then

$$\zeta(\mu(S, T_1, \dots, T_k)) = \mu([k], [m_1], \dots, [m_k]).$$

Let

$$T' = M_0^m \quad , \quad S' = M_{n-1}^k \quad \text{and} \quad T'_i = M_0^{m_i} .$$

Then σ determines a unique morphism $\sigma' : T' \rightarrow S'$ in Ω_n with $\sigma'_n = \sigma$. This morphism gives the following morphism in \mathbf{h}^n :

$$f' : \mu(S'; T'_1, \dots, T'_k) \rightarrow \pi(\sigma)T'$$

with $\zeta(f') = f$.

There is also a unique morphisms $S \rightarrow S'$ with $\xi_n = id$, which gives a morphism

$$\xi : \mu(S'; S'_1, \dots, S'_k) \rightarrow S$$

in \mathbf{h}^n . Every S'_i has a unique tip. Hence, we have a morphism

$$\psi : \mu(S'; S'_1, \dots, S'_k) \rightarrow \mu(S'; U_n, \dots, U_n) \rightarrow S'$$

in \mathbf{h}^n . Now

$$\zeta(\xi) = \zeta(\psi) : \mu([k]; [1], \dots, [1]) \rightarrow [k]$$

is a retraction in \mathbf{H}^∞ . So we get a chain of morphisms

$$\mu(S'; T'_1, \dots, T'_k) \leftarrow \mu(\mu(S'; S'_1, \dots, S'_k); T'_1, \dots, T'_k) \rightarrow \mu(S; T'_1, \dots, T'_k)$$

in \mathbf{h}^n .

We continue by choosing a unique morphism $\phi : T' \rightarrow T$ with $\phi_n = id$ and construct the other side of the chain analogously. Finally observe, that we have morphisms $\sigma'_i : T'_i \rightarrow T_i$ with $(\sigma'_i)_n = id$ which allow us to complete the construction.

♣

Recall that

$$\zeta^* : IO_\infty^{sym}(A) \rightarrow IO_n^{sym}(A).$$

means the restriction functor along ζ . By Theorem 9.1, ζ^* is isomorphic to the functor of internal desymmetrisation δ_n .

Theorem 13.1 *Let A be a cocomplete categorical symmetric operad then a left adjoint sym_n to ζ^* exists, and on an internal n -operad $a \in IO_n^{sym}(A)$, is given by the formula*

$$(sym_n(a))_k \simeq \operatorname{colim}_{\mathbf{h}_k^n} \tilde{a}_k$$

where $\tilde{a}_k : \mathbf{h}_k^n \rightarrow A_k$ is the operadic functor representing the operad a .

Proof. The case $n = 1$ is well known. For an internal symmetric operad x the internal 1-operad $\zeta^*(x)$ has the same underlying collection as x and the same multiplication for the orderpreserving maps of ordinals. So the left adjoint to ζ^* on object a is given by

$$(sym_1(a))_n = \coprod_{\Sigma_n} a_n$$

which is the same as the colimit of \tilde{a} over \mathbf{h}^1 (see the description of \mathbf{h}^1 in Section 10).

Let $x : \mathbf{h}^n \rightarrow A$ be an operadic functor, $n \geq 2$. If we forget about the operadic structures on $\mathbf{h}^n, \mathbf{H}^\infty$ and A , we can take a left Kan extension

$$\begin{array}{ccc}
\mathbf{h}^n & \xrightarrow{x} & A \\
\zeta \downarrow & \searrow \phi & \nearrow L = \text{Lan}_\zeta(x) \\
\mathbf{H}^\infty & &
\end{array}$$

of x along ζ in the 2-category of symmetric *Cat*-collections. Since multiplication m in A preserves colimits in each variable, the following diagram is a left Kan extension.

$$\begin{array}{ccc}
\mathbf{h}_k^n \times \mathbf{h}_{n_1}^n \times \dots \times \mathbf{h}_{n_k}^n & \longrightarrow & A_k \times A_{n_1} \times \dots \times A_{n_k} \xrightarrow{m} A_{n_1+\dots+n_k} \\
\downarrow \phi_k \times \phi_{n_1} \times \dots \times \phi_{n_k} & \searrow & \nearrow L_k \times L_{n_1} \times \dots \times L_{n_k} \\
\mathbf{H}_k^\infty \times \mathbf{H}_{n_1}^\infty \times \dots \times \mathbf{H}_{n_k}^\infty & &
\end{array}$$

On the other hand, since ζ and x are strict operadic functors we have a natural transformation

$$\begin{array}{ccc}
\mathbf{h}_k^n \times \mathbf{h}_{n_1}^n \times \dots \times \mathbf{h}_{n_k}^n & \longrightarrow & A_k \times A_{n_1} \times \dots \times A_{n_k} \xrightarrow{m} A_{n_1+\dots+n_k} \\
\downarrow & \searrow \mu & \nearrow \phi \\
\mathbf{H}_k^\infty \times \mathbf{H}_{n_1}^\infty \times \dots \times \mathbf{H}_{n_k}^\infty & \xrightarrow{\mu} & \mathbf{H}_{n_1+\dots+n_k}^\infty \xrightarrow{L} A_{n_1+\dots+n_k}
\end{array}$$

and by the universal property of Kan extension we have a natural transformation

$$\rho : m(L_k; L_{n_1}, \dots, L_{n_k}) \rightarrow L_n(\mu)$$

which determines a structure of lax-operadic functor on L . Moreover, ϕ becomes an operadic natural transformation.

Now the sequence of objects $L(p) = L([p]), p \geq 0$, has a structure of an internal symmetric operad in A . For a map of ordinals $\sigma : [p] \rightarrow [k]$, let us define an internal multiplication λ_σ by the composite

$$m(L(k); L(p_1), \dots, L(p_k)) \xrightarrow{\rho} L(\mu([k], [p_1], \dots, [p_k])) \longrightarrow L(\pi(\sigma)[p]) = \pi(\sigma)L(p).$$

Let us denote this operad by $\mathcal{L}(x)$.

The calculation of $L(p)$ can be performed by the classical formula for pointwise left Kan extension [29]. It is therefore $\text{colim}_{f \in \zeta/[p]} \delta$, where $\delta(f) = x(S)$ for

an object $f : \zeta(S) \rightarrow [p]$ of the comma category $\zeta/[p]$. But according to the remark after Theorem 9.1, $[p]$ is a terminal object of \mathbf{H}_p^∞ and therefore

$$\operatorname{colim}_{f \in \zeta/[p]} \delta \simeq \operatorname{colim}_{\mathbf{h}_p^n} x_p .$$

It remains to prove that the internal operad $\mathcal{L}(\tilde{a})$ is $\operatorname{sym}_n(a)$. Indeed, for a given operadic morphism $\mathcal{L}(\tilde{a}) \rightarrow b$ the composite

$$\tilde{a} \xrightarrow{\phi} \zeta^* \mathcal{L}(\tilde{a}) \rightarrow \zeta^* \tilde{b}$$

is operadic since ϕ is operadic. But ζ is final and, therefore, the counit of the adjunction $\zeta^* \dashv \operatorname{Lan}_\zeta$ is an isomorphism. So for a given operadic morphism $\tilde{a} \rightarrow \zeta^* \tilde{b}$ of internal n -operads the morphism

$$\mathcal{L}(\tilde{a}) \rightarrow \mathcal{L}(\zeta^* \tilde{b}) \simeq \tilde{b}$$

is operadic, as well. So the proof of the theorem is completed. ♣

Corollary 13.1.1 *Let A be an n -operad in a cocomplete symmetric monoidal category and V , then*

$$(\operatorname{Sym}_n(A))_k \simeq \operatorname{colim}_{\mathbf{h}_k^n} \tilde{A}_k$$

where $\tilde{A}_k : \mathbf{h}_k^n \rightarrow V^\bullet$ is the operadic functor representing the operad A .

Theorem 13.2 *The isomorphism*

$$\mathbf{h}^n \longrightarrow \operatorname{Sym}_n(\mathbf{H}^n)$$

induces a canonical isomorphism

$$N(\mathbf{h}^n) \longrightarrow \operatorname{Sym}_n(N(\mathbf{H}^n)).$$

Proof. We have to calculate the result of the application of Sym_n to the simplicial Set n -operad $\mathcal{F}_n^*(1) = B(\mathcal{F}_n, \mathcal{F}_n, 1)$.

We have the following commutative diagram

$$\begin{array}{ccc} \operatorname{CO}_n(\mathbf{H}_d^n, \operatorname{Des}_n(\operatorname{Set}^\bullet)) & \xleftarrow{i^*} & \operatorname{CO}_n(\mathbf{H}^n, \operatorname{Des}_n(\operatorname{Set}^\bullet)) \\ \downarrow & & \downarrow \begin{array}{l} \nearrow \text{ev} \\ \searrow \text{sev} \end{array} \\ \operatorname{SCO}(\mathbf{h}_d^n, \operatorname{Set}^\bullet) & \xleftarrow{j^*} & \operatorname{SCO}(\mathbf{h}^n, \operatorname{Set}^\bullet) \end{array}$$

where the vertical morphisms are canonical isomorphisms and the horizontal morphisms are the corresponding restriction functors. In this diagram

$$sev : \mathbf{SCO}(\mathbf{h}^n, \mathbf{Set}) \longrightarrow O_n(\mathbf{Set})$$

is the isomorphism which gives an n -operad by evaluating an operadic functor on the generating objects of \mathbf{h}^n and ev the corresponding evaluation functor for n -operads.

Observe that the simplicial operad $\mathcal{F}_n^*(1)$ is the result of application of the functor ev to the simplicial operadic functor $\mathbf{Lan}^*(\tilde{1}) = B(\mathbf{Lan}, \mathbf{Lan}, \tilde{1})$ from Theorem 12.1.

This diagram above shows that

$$ev(\mathbf{Lan}^*(\tilde{1})) = sev(\mathbf{lan}^*(\tilde{1})),$$

where the monad \mathbf{lan} is the monad generated by the adjunction $j^* \vdash Lan_j$, which is an operadic adjunction by an argument analogous to the proof of the Theorem 12.1. We can also prove the following analogue for the formula (12.2) :

$$\mathbf{lan}^k(\tilde{x})(W) = \coprod_{\begin{array}{c} W \xleftarrow{f_0} W_1 \xleftarrow{f_1} W_2 \xleftarrow{f_2} \dots \xleftarrow{f_{k-1}} W_k \end{array}} \tilde{x}(W_k), \quad (13.1)$$

where f_0, \dots, f_{k-1} are morphisms in \mathbf{h}^n .

Applying the functor Lan_ζ to the operadic functor $\mathbf{lan}^k(\tilde{x})$ we have

$$Lan_\zeta(\mathbf{lan}^k(\tilde{x})) = Lan_\zeta(Lan_j(j^*\mathbf{lan}^{k-1}(\tilde{x}))) \simeq Lan_{\zeta \cdot j}(j^*\mathbf{lan}^{k-1}(\tilde{x})). \quad (13.2)$$

The left Kan extension $Lan_{\zeta \cdot j}(\tilde{x})$ is given by the formula

$$Lan_{\zeta \cdot j}(\tilde{x})(V) = \coprod_{V \xleftarrow{f} \zeta(W)} \tilde{x}(W), \quad (13.3)$$

where f runs over the morphisms of \mathbf{H}^∞ . So, combining formulas (13.1), (13.2) and (13.3) we get

$$Lan_\zeta(\mathbf{lan}^k(\tilde{x}))(V) \simeq \coprod_{V \xleftarrow{f} \zeta(W)} \coprod_{\begin{array}{c} W \xleftarrow{f_0} W_1 \xleftarrow{f_1} W_2 \xleftarrow{f_2} \dots \xleftarrow{f_{k-2}} W_{k-1} \end{array}} \tilde{x}(W_{k-1}) \quad (13.4)$$

Now to calculate the p -th space of $Sym_n(N(\mathbf{H}^n)) = Sym_n(sev(\mathbf{lan}^*(\tilde{1})))$ we have to put $x = 1$ and evaluate (13.4) at $V = [p]$. Since $[p]$ is a terminal object we have

$$Sym_n(N(\mathbf{H}^n)_p)^k \simeq \coprod_{\begin{array}{c} W_0 \xleftarrow{f_0} W_1 \xleftarrow{f_1} W_2 \xleftarrow{f_2} \dots \xleftarrow{f_{k-2}} W_{k-1} \end{array}} 1 = N(\mathbf{h}_p^n)^k.$$

It is not hard to see that these isomorphisms agree with face and degeneracy operators.

♣

References

- [1] Baez J., Dolan J., Higher-dimensional algebra and topological quantum field theory, *Journal Math. Phys.* **36** (1995), 6073-6105.
- [2] Baez J., Dolan J., Categorification, *Contemp. Math.* AMS, **230** (1998), 1-36.
- [3] Balteanu C., Fiedorowicz Z., Schwänzl R., Vogt R., Iterated Monoidal Categories, *Adv. Math.* **176** (2003), pp. 277-349.
- [4] Batanin M.A. Homotopy coherent category theory and A_∞ -structures in monoidal categories, *Journal of Pure and Appl. Algebras*, **123** (1998), 67-103.
- [5] Batanin M.A., Monoidal globular categories as a natural environment for the theory of weak n -categories, *Adv. Math.* **136** (1998), pp. 39-103.
- [6] Batanin M.A., Shuffle polytopes, cooperative games and 2-dimensional coherence for higher dimensional categories, in preparation.
- [7] Batanin M., Weber M., Multitensors and higher dimensional operads, in preparation.
- [8] Batanin M.A., Street R., The universal property of the multitude of trees, *Journal of Pure and Appl. Algebra* **154** (2000), 3-13.
- [9] Batanin M.A., Symmetrisation of n -operads and compactification of real configuration spaces, *Adv. Math.* **211** (2007), pp. 684-725.
- [10] Berger C., Combinatorial models for real configuration spaces and E_n -operads, *Contemp. Math.* **202** (1997), 37-52.
- [11] Berger C., A Cellular Nerve for Higher Categories, *Adv. Math.* **169** (2002), pp. 118-175.
- [12] Blackwell J., Kelly G.M., Power A.J., Two dimensional monad theory, *Journal of Pure and Appl. Algebras*, **59** (1989), 1-41.
- [13] Borceux F., Handbook of Categorical Algebra. *Encyclopedia of Mathematics and its Applications*, v. **50-52**, Cambridge University Press, 1994.
- [14] Crans S., Generalized Centers of Braided and Sylleptic Monoidal 2-Categories, *Adv. Math.* **136** (1998), 183-223.
- [15] Crans S., Teisi in Ab, *Homology, Homotopy and Appl.*, v. **3 n.4**, (2001), 87-100.
- [16] Day B., Street R., Lax monoids, pseudo-operads, and convolution, *Contemporary Mathematics* **318** (2003), 75-96.

- [17] Day B., Street R., Abstract substitution in enriched categories, *Journal of Pure and Appl. Algebra* **179** (2003), 49-63.
- [18] Dubuc E., Adjoint triangles, *Lecture Notes in Math.*, **61**, Springer Verlag, Berlin, (1968), 69-91.
- [19] Eckmann B., Hilton P., Group-like structures in categories, *Math. Ann.* **145** (1962), 227-255.
- [20] Gelfand I.M., Kapranov M.M., Zelevinsky A.V., Newton polytopes of classical determinant and resultant, *Adv. Math.*, **84** (1990), 255-271,
- [21] Ginzburg V., Kapranov M., Koszul duality for operads, *Duke Math. J.*, **76** (1994), 203-272.
- [22] Gordon R., Power A.J., Street R., Coherence for Tricategories, *Memoirs of the AMS*, **117**, n.558, 1995.
- [23] Joyal A., Street R., Braided tensor categories, *Adv. Math.*, **102** (1993), 20-78.
- [24] Joyal A., Disks, duality and Θ -categories, preprint, 1997.
- [25] Kapranov M., Voevodsky V., 2-Categories and Zamolodchikov tetrahedra equations, in *Proc. Symp. Pure Math.*, **56** p.2 (1994), AMS, Providence, pp. 177-260.
- [26] Kontsevich M., Operads and motives in deformation quantization, *Lett. Math. Phys.* **48** (1999), no. 1, 35–72.
- [27] Kontsevich M., Soibelman Y., Deformation of algebras over operads and Deligne’s conjecture, *Conférence Moshé Flato* **1**(Dijon) (1999), 255–307.
- [28] Lack S., Codescent objects and coherence, *Journal of Pure and Appl. Algebra*, **175**, (2002), no.1-3, 223-241.
- [29] Mac Lane S., Categories for the Working Mathematician, *Second edition. Graduate Texts in Mathematics*, **5** Springer-Verlag, New York, 1998.
- [30] Markl M., Shnider S., Stasheff J., Operads in Algebra, Topology and Physics, *Math. Surveys and Monographs*, **v.96**, AMS, 2002.
- [31] McClure J., Smith J., Cosimplicial objects and little n -cubes. I., *Amer. J. Math.*, **126**, (2004), no. 5, 1109–1153.
- [32] May P., The Geometry of Iterated Loop Spaces, *Lecture Notes in Math.*, **271**, Springer Verlag, Berlin, (1972).
- [33] Power A.J., A general coherence result, *Journal of Pure and Appl. Algebra*, **57** (1989), no. 2, 165–173.

- [34] Street R., Conspectus of variable categories, *Journal of Pure and Appl. Algebra* **21** (1981), 307-338.
- [35] Street R., Categorical and Combinatorial Aspects of Descent Theory, *Applied Categorical Structures*, **12** (2004), 537-576.
- [36] Street R., The role of Michael Batanin's monoidal globular categories, *Contemp. Math.* AMS, **230** (1998), 99-116.
- [37] Street R., The petit topos of globular sets, *Journal of Pure and Appl. Algebra*, **154** (2000), 299-315.
- [38] Simpson C., On the Breen-Baez-Dolan stabilization hypothesis for Tamamani's weak n -categories, preprint arXiv:math.CT/9810058 (1998).
- [39] Tamarkin D.E., The deformation complex of a d -algebra is a $(d+1)$ -algebra, preprint, 21 Jan 2001.
- [40] Weber M., Operads within Monoidal Pseudo Algebras, *Applied Cat. Structures*, **13** (2005), 389-420.