

The annular structure of subfactors.

Vaughan F.R. Jones

14th November 2018

1 Introduction.

A finite index subfactor N of a II_1 factor M is well known to have a "standard invariant" - two increasing sequences of finite dimensional algebras which were first defined as the commutants (or centralisers) of M and N in the increasing tower M_n of extensions of N defined inductively by $M_0 = N$, $M_1 = M$ and $M_{n+1} = \text{End}(M_n)$ where M_n is considered as a right M_{n-1} module.

The planar algebras defined in [13] grew out of an attempt to solve the massive systems of linear equations defining the standard invariant of a subfactor defined by a "commuting square" - see [16]. The standard invariant arises as the eigenspace of largest eigenvalue of the transfer matrix T (with free horizontal boundary conditions) in a certain statistical mechanical model whose Boltzman weights are defined by the commuting square. The planar operad of [13] acts multilinearly on V so as to commute with T . Hence the operad acts on the eigenspace of largest eigenvalue which places tight non-linear constraints on that eigenspace. It was shown in [13] that the ensuing action of the planar operad on the standard invariant can be defined directly from the data $N \subseteq M$ itself. The appearance of Popa's seminal paper [21] made it clear that the planar operad could be used, in the presence of reflection positivity of the partition function, to axiomatise standard invariants of subfactors. All this material is explained in detail in [13].

More significantly than the axiomatisation has been the totally different point of view on subfactors afforded by the planar algebra approach. The planar operad is graded by the number of inputs in a planar tangle. So the natural order of increasing complexity of operations on the standard invariant

*Research supported in part by NSF Grant DMS93-22675, the Marsden fund UOA520, and the Swiss National Science Foundation.

is by the number of inputs. Tangles with no inputs and one output are the so-called Temperley-Lieb tangles and, in retrospect, it was the study of these tangles that led in [12] to the first breakthrough on subfactors. (It was Kauffman who first saw the Temperley-Lieb algebra in a purely diagrammatic way in [17].) The natural next step in the order of complexity is to consider tangles with one input and one output. These are the annular tangles and in this paper we lay the foundations for the study of this the annular structure of subfactors.

The next step up in complexity will be to consider systematically tangles with two inputs, which give bilinear operations. This will be much harder than the study of annular tangles as tangles with up to two inputs generate the whole operad. In particular one will see the algebra structure on the standard invariant which has been the main tool of study in the orthodox approaches of Ocneanu([20]), Popa([21]) and others. From this perspective it is truly remarkable that the annular structure yields any information at all about subfactors seen from the orthodox point of view. Indeed, besides the algebra structure, the notions of principal graph, fusion and connection are entirely absent and even the index itself is just a parameter, with no indication that its size should measure complexity! Yet we will show herein that annular considerations alone are enough to give Ocneanu's restrictions on the principal graphs in index less than four and even the construction of the $A - D - E$ series. Restrictions will also be obtained in index greater than 4 by considering the generating function for the dimensions of the graded pieces in a planar algebra.

The notion that will systematise our study of annular structure is that of a *module* over a planar algebra. (In the operadic treatment of associative algebras the notion of "module" over an algebra over an operad actually defines a *bimodule* over the associative algebra.) Adapting the definition of [19], a module over a planar algebra will be a graded vector space whose elements can be used as inputs for a single internal disc in a planar tangle, the output being another vector in the module, as explained in section 1.

By combining all the internal discs that correspond to algebra inputs it is natural to think of a module as being a module over an *annular* category whose morphisms are given by annular planar tangles. A planar algebra will always be a module over itself. More significantly, if a planar algebra \mathcal{P} contains another \mathcal{Q} then \mathcal{P} is a module over \mathcal{Q} and will be decomposable as such. In particular any planar algebra contains the Temperley Lieb planar algebra TL and may be decomposed. In this paper we will exploit this decomposition for the first time.

There are two precursors to this study. The first is [14] where the TL category was completely analysed in the case of a particular planar algebra

called the tensor planar algebra in [13]. The second and very impressive precursor is the paper of Graham and Lehrer [9] where all TL modules are obtained in a purely algebraic setting which includes the non semisimple case.

We present two main applications of our technique. The first is a positivity result for the Poincaré series of a planar algebra, obtained by summing the generating functions of the TL -modules contained in a planar algebra. As a corollary one may obtain certain restrictions on the principal graph of a subfactor of index close to 4 (see [10]).

The second application is to give a uniform method for the construction of the ADE series of subfactors of index less than 4. We give two versions of the proof, the first of which interprets the vanishing of a certain determinant as being the flatness of a certain connection in the Ocneanu language, or the computation of the relative commutants for a certain commuting square in the language of [16]. This is the first convincing vindication of the power of planar algebras for computing commuting square invariants-which was the motivation 10 years ago for the introduction of planar algebras! To avoid a lengthy discussion of connections and commuting squares we cast this proof entirely in the language of planar algebras though the reader familiar with commuting squares will have no trouble recognising the origin of the proof. The second proof is a purely planar algebraic proof which proceeds by giving a system of "skein" relations on a generator of a planar algebra which allow one to calculate the partition function of any closed tangle. It was shown in [13] that the partition function completely determines the planar algebra if it is reflection positive. Both the proofs begin by finding the relevant generator inside a larger, general planar algebra obtained from the Coxeter graph in [15].

The results of Graham and Lehrer are crucial to both the above applications since they give the linear independence or lack thereof of certain elements, represented by labelled tangles, in TL -modules. Indeed the results are so important that we were compelled to find our own proofs of the relevant linear independence. There are two reasons for this. The first is that Graham and Lehrer never explicitly address the issues of positivity. Positivity cannot be deduced from the Graham-Lehrer determinants alone and even if we had just applied their results we would have had to do a large fraction of the work anyway. The second reason is that there are subtle but significant differences in the Graham-Lehrer context and our own. They had no reason, for instance, to worry about shading so their TL -modules are slightly different from ours. And their handling of sesquilinearity, while exemplary from a purely algebraic point of view, requires a little modification to apply to Hilbert space. Thus in order to have confidence in our own results we felt obliged to obtain our own proofs-albeit ones owing a lot to the ideas of

Graham and Lehrer. But even our own proofs are not quite self-contained as they use specialisations of the parameters to values contained in [14] and [15].

2 Notation.

Let \mathcal{P} be the planar coloured operad defined in [13]. By definition a planar algebra (or general planar algebra, we will not make the distinction here) is an algebra over this operad, i.e. a graded vector space $P = (P_0^\pm, P_n, n > 0)$ together with multilinear maps among the P_k 's indexed by the elements of \mathcal{P} . The multilinear maps are subject to a single compatibility property defined in [13].

Definition 2.1 *An annular tangle T will be a tangle in \mathcal{P} with the choice of a distinguished internal disc. The region in the plane between the distinguished internal disc and the outside boundary disc will be called the interior of the tangle. T will be called an annular (m, k) -tangle if it is an m -tangle whose distinguished internal disc has $2k$ boundary points. In case m or k is zero it is replaced with \pm as usual.*

Definition 2.2 *(Left) module over a planar algebra. If $P = (P_0^\pm, P_n, n > 0)$ is a planar algebra, a module over P , or P -module will be a graded vector space $V = (V_0^\pm, V_n, n > 0)$ with an action of P . That is to say, given an annular (m, k) -tangle T in \mathcal{P} with distinguished ("V input") internal disc D_1 with $2k$ boundary points and other ("P input") internal discs $D_p, p = 2, \dots, n$ with $2k_p$ boundary points, there is a linear map $Z_T : V_k \otimes (\otimes_{p=2}^n P_{k_p}) \rightarrow V_m$. Z_T satisfies the same compatibility condition for gluing of tangles as P itself where we note that the output of a tangle with a V input may be used as input into the distinguished internal disc of another tangle, and elements of P as inputs into the non-distinguished discs.*

Comments. (i) This definition of P -module is precisely the generalisation to the coloured setting of the definition of module over an algebra over an operad found in [19].

(ii) A planar algebra is always a module over itself. It will be considered to be the trivial module.

(iii) Any relation (linear combination of labelled planar tangles) that holds in P will hold in V . For instance if P is of modulus δ in the sense that a closed circle in a tangle can be removed by multiplying by δ , the same will

be true for the tangle applied to an input in V . This is a consequence of the compatibility condition.

(iv) The notions of submodule, quotient, irreducibility, indecomposability and direct sum of P -modules are obvious.

There is another way to approach P -modules which is more in the monadic spirit of [13]. If P is a planar algebra we define the associated annular category $AnnP$ to have two objects \pm for $k = 0$, one object for each $k > 0$, and whose morphisms are annular labelled tangles in the sense of [13], with labelling set all of P . Given an annular (m, k) -tangle T and an annular (k, n) -tangle S , TS is the annular (m, n) -tangle obtained by identifying the inside boundary of T with the outside boundary of S so that the $2k$ distinguished boundary points of each coincide, as do the distinguished initial regions, then removing the common boundary (and smoothing the strings if necessary). Let FAP be the linearization of $AnnP$ - it has the same objects but the set of morphisms from object k_1 to object k_2 is the vector space having as a basis the morphisms in $AnnP$ from k_1 to k_2 . Composition of morphisms in FAP is by linear extension of composition in $AnnP$. Let D be a contractible disc in the interior of an annular (m, n) -tangle T which intersects T in an ordinary k -tangle, $k \geq 0$. Define a subspace $\mathcal{R}(D)$ of FAP as follows: once T is labelled outside D it determines a linear map Φ_T from the universal presenting algebra for P to FAP by insertion of labelled tangles. Set $\mathcal{R}(D)$ to be the linear span of all $\Phi_T(ker)$ where ker is the kernel of the universal presenting map for P and all labellings of T outside D are considered.

Proposition 2.3 *Composition in FAP passes to the quotient by the subspace spanned by the $\mathcal{R}(D)$ as D runs over all discs as above.*

Proof. Composing any tangle with one of the form $\Phi_T(x)$ for $x \in ker$ gives another such tangle. \square

Definition 2.4 *The annular algebroid $AP = \{AP(m, n)\}$ (with m or n being \pm instead of zero as usual) is the quotient of FAP by $\mathcal{R}(D)$ defined by the previous lemma.*

In other words, AP is the quotient of the universal annular algebroid of P by all planar relations. Thus for instance if P has modulus δ in the sense that closed circles contribute a multiplicative factor δ , the same will be true for closed contractible circles in AP .

The notions of module over AP and module over P as above are the same.

Given a P -module V define an action of FAP on V as follows. Given a labelled annular tangle T , consider the subjacent unlabelled tangle as in

definition 2.2. Use the labels of T as P -inputs to obtain a linear map from V to itself. The compatibility condition for gluing V discs shows that V becomes a (left) module over FAP . Note (iii) above shows that this action passes to AP . Conversely, given a module V over AP , the multilinear maps required by the definition of P -module are obtained by labelling the interior discs of an annular tangle with elements of P and applying the resulting element of FAP to a vector in V . One has to check that these multilinear maps preserve composition of tangles. If the composition involves an annular boundary disc, use the fact that V is a FAP -module. If the composition involves an interior disc, the required identity refers only to objects within a contractible disc in the interior of the annular tangle, so the identity holds since V is an AP module and not just a FAP module. Altogether, this proves the following:

Theorem 2.5 *The identity map $V \rightarrow V$ defines an equivalence of categories between P modules in the sense of definition 2.2 and left modules over the algebroid AP .*

Annular tangles with the same number of boundary points inside and out give an algebra which will play an important role so we make the following.

Definition 2.6 *With $AP(m, n)$ as above, let AP_m be the algebra $AP(m, m)$ for each positive integer m , and AP_{\pm} to be the algebras spanned by annular tangles with no boundary points, with the regions near the boundaries shaded (+) or unshaded (-) according to the sign.*

If we apply this procedure to the Temperley-Lieb planar algebra $TL(\delta)$ for δ a scalar, we obtain the following:

For $m, n \geq 0$ let $AnnTL(m, n)$ be the set of all annular tangles having an internal disc with $2n$ boundary points and an external disc with $2m$ boundary points, and no contractible circular strings. Elements of $AnnTL(m, n)$ define elements of $ATL(m, n)$ by passing to the quotient of $FATL$. The objects of ATL are $+$ and $-$ for $m = 0$ and sets of $2m$ points when $m > 0$. It is easy to check that morphisms in $ATL(\delta)$ between m and n points are linear combinations of elements of $AnnTL(m, n)$, composed in the obvious way. In particular the algebra $ATL_m(\delta)$ has as a basis the set of annular tangles with no contractible circles, multiplication being composition of tangles and removal of contractible circles, each one counting a multiplicative factor of δ .

It will be important to allow non-contracible circular strings-ones that are not homologically trivial in the annulus. Their most obvious effect at this stage is to make each algebra ATL_m infinite dimensional. But only just, as the next discussion shows.

Definition 2.7 A through string in an annular tangle will be one which connects the inside and outside boundaries. $AnnTL(m, n)_t$ will denote the set of tangles in $AnnTL(m, n)$ with t through strings.

The number of through strings does not increase under composition so the linear span of $AnnTL(m, m)_r$ for $r \leq t$ is an ideal in ATL_m . The quotient by this ideal for $t = 0$ is finite dimensional. Its dimension was already calculated in [14].

For future reference we define certain elements of $AnnTL$. Of course they are defined also as elements of AP for any planar algebra P .

Definition 2.8 Let $m \geq 0$ be given. We define elements $\epsilon_i, \varepsilon_i, F_i, \sigma^\pm$ and the rotation ρ as follows:

(i) For $1 \leq i \leq 2m$, ϵ_i is the annular $(m-1, m)$ -tangle with $2m - 2$ through strings and the i th. internal boundary point connected to the $(i+1)$ th. (mod $2m$). The first internal and external boundary points are connected whenever possible but when $i = 1$ or $2m$ the third internal boundary point is connected to the first external one.

When $m = 1$, for ϵ_1 the two internal boundary points are connected by a string having the shaded region between it and the internal boundary and for ϵ_2 the string has the shaded region between it and the external boundary. To avoid confusion in this and future cases when $m = 1$ we draw ϵ_1 and ϵ_2 below. (Remember that the boundary region marked * is always unshaded.)

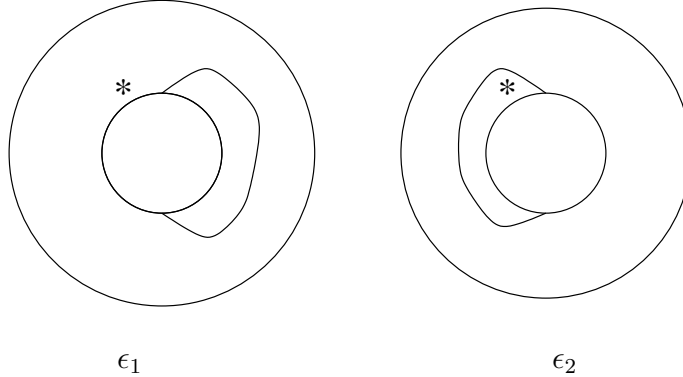

(ii) For $1 \leq i \leq 2m+2$, ε_i is the annular $(m+1, m)$ -tangle with $2m$ through strings and the i th. external boundary point connected to the $(i+1)$ th. (mod $2m+2$). The first internal and external boundary points are connected whenever possible but when $i = 1$ or $2m+2$ the third external boundary point is connected to the first internal one.

When $m = 0$, for ε_1 the two external boundary points are connected by a string having the shaded region between it and the external boundary and for ε_2 the string has the shaded region between it and the internal boundary.

(iii) For $1 \leq i \leq 2m$ let F_i be the annular (m, m) -tangle with $2m - 2$ through strings connecting the j th. internal boundary point to the j th. external one except when $j = i$ and $j = i + 1 \pmod{2m}$.

When $m = 1$ we adopt conventions as for ϵ and ε . We depict F_1 and F_2 below.

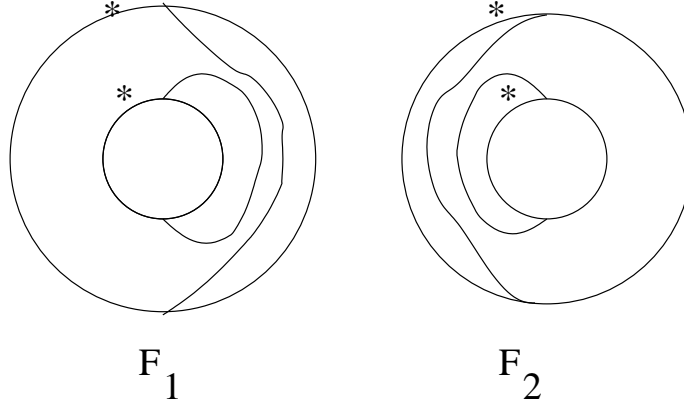

(iv) Let ρ be the annular (m, m) -tangle with $2m$ through strings with the first internal boundary point connected to the third external one.

(v) Let σ_{\pm} be the annular (\pm, \mp) tangles with opposite inside and outside shadings near the boundaries and a single homologically non-trivial circle inside the annulus.

Now return to the case of a general planar algebra P . To generalise the notion of through strings we introduce the following.

Definition 2.9 If T is an annular (m, n) tangle (an m -tangle with a distinguished internal disc having $2n$ boundary points), the rank of T is the minimum, over all embedded circles C inside the annulus which are homologically non trivial in the annulus and do not meet the internal discs, of the number of intersection points of C with the strings of T

For instance if T has no internal discs besides the distinguished one, it defines an element of $ATL(m, n)$ and the rank of T is just the number of through strings.

Remark. If an annular (m, n) tangle T has rank $2r$ it may be written as a composition $T_1 T_2$ where T_1 is an (m, r) tangle and T_2 is an (r, n) tangle.

Lemma 2.10 If P is a planar algebra, the linear span in the algebra AP_m of all labelled annular (m, m) -tangles of rank $\leq r$ is a two-sided ideal.

We do not expect the quotient of AP_m by the ideal of the previous lemma to be finite dimensional in general though there are cases different from Temperley Lieb where it is.

We conclude this section with a couple of generalities on P -modules. The terms irreducible and indecomposable have their obvious meanings.

Lemma 2.11 *Let $V = (V_k)$ be a P -module. Then V is indecomposable iff V_k is an indecomposable AP_k module for each k .*

Proof. Suppose V is indecomposable but that V_k has a proper AP_k module W for some k . Then applying AP to W one obtains a sub P -module X of V and $X_k \subseteq W$ since returning to V_k from X_m is the same as applying an element of AP_k . The converse is obvious. \square

Definition 2.12 *The weight $wt(V)$ of a P -module V is the smallest k for which V_k is non-zero. (If V_+ or V_- is non-zero we say V has weight zero.) Elements of $V_{wt(V)}$ will be called lowest weight vectors. The set of all lowest weight vectors is an $AP_{wt(V)}$ -module which we will call the lowest weight module.*

Definition 2.13 *The dimension of a P -module V is the formal power series*

$$\Phi_V(z) = \frac{1}{2} \dim(V_+ \oplus V_-) + \sum_{k=1}^{\infty} \dim(V_k) z^k$$

Observe that the dimension is additive under the direct sum of two P -modules.

We will not concern ourselves here with further purely algebraic properties. We are especially interested in subfactors, where positivity holds.

3 Hilbert P -modules.

A C^* -planar algebra P is one for which each P_k is a finite dimensional C^* -algebra with $*$ compatible with the planar algebra structure as in [13]. The $*$ -algebra structure on P induces $*$ -structure on AP as follows. Define an involution $*$ from annular (m, k) -tangles to (k, m) -tangles by reflection in a circle half way between the inner and outer boundaries. (The initial unshaded regions around all discs are the images under the reflection of the initial unshaded regions before reflection, as in the definition of a $*$ -planar algebra in [13].) If P is a C^* -planar algebra this defines an antilinear involution

$*$ on FAP by taking the $*$ of the unlabelled tangle subjacent to a labelled tangle T , replacing the labels of T by their $*$'s and extending by antilinearity. Since P is a planar $*$ -algebra, all the subspaces $\mathcal{R}(\mathcal{D})$ are preserved under $*$ on FAP , so $*$ passes to an antilinear involution on the algebroid AP . In particular all the AP_k are $*$ -algebras.

Definition 3.1 *Let P be a C^* -planar algebra. A P -module V will be called a Hilbert P -module if each V_k is a finite dimensional Hilbert space with inner product \langle, \rangle satisfying*

$$\langle av, w \rangle = \langle v, a^*w \rangle$$

for all v, w in V and a in AP (in the graded sense).

Comments. (i) A P -submodule of a Hilbert P -module is a Hilbert P -module.

(ii) The orthogonal complement (in the graded sense) of a submodule of a P -submodule is a P -submodule so that indecomposability and irreducibility are the same for Hilbert P -modules.

Recall from [13] that a C^* -planar algebra P is said to be spherical if there are linear functionals $Z : P_0^\pm \rightarrow \mathbb{C}$ which together define a spherically invariant function on labelled 0-tangles. The partition function Z is also required to be positive definite in the sense that $\langle x, y \rangle = Z(x_c y^*)$ is a positive definite Hermitian form on each P_k where $x_c y$ denotes the complete contraction of tangles x and y , i.e. the labelled 0-tangle illustrated below with 2 internal k -discs and $2k$ strings connecting them, with the initial regions of each disc in the same connected component of the plane minus the tangle, with x in one disc and y in the other, as shown below. It does not matter how the strings connect the two discs, by spherical invariance. ($Z(x_c y)$ would be $trace(xy)$ in the terminology of [13].)

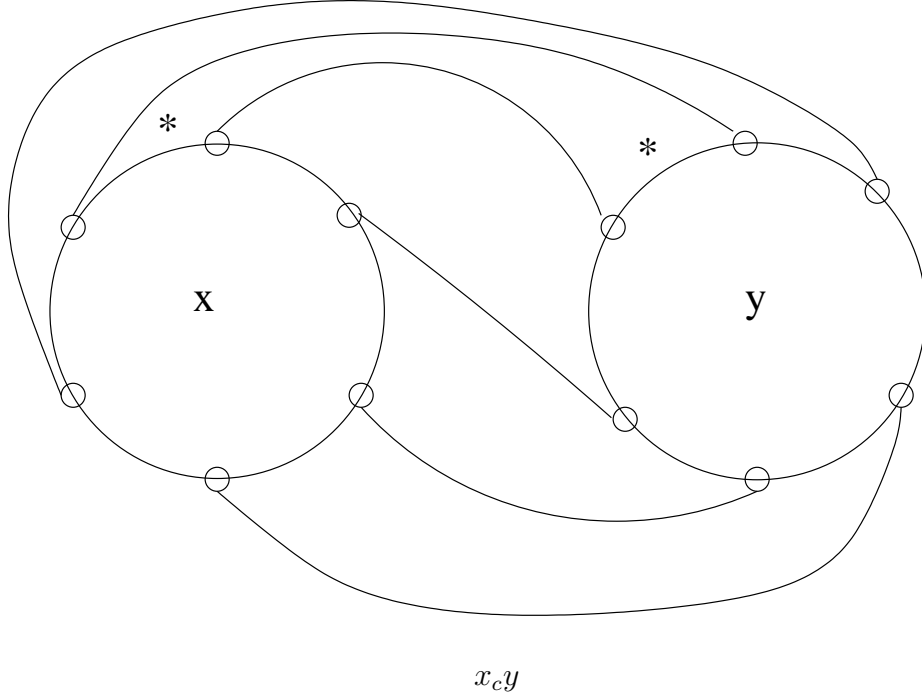

A spherical C^* -planar algebra always admits a Hilbert P -module, namely itself, as follows.

Proposition 3.2 *If P is a spherical C^* -planar algebra then the inner product $\langle x, y \rangle = Z(x_c y^*)$ makes P into a Hilbert P -module.*

Proof. The action of AP on P is that of composition of tangles. All that needs to be shown is the formula

$$\langle av, w \rangle = \langle v, a^* w \rangle$$

for all v, w in P and a in AP . We may assume that v, w , and a are all labelled tangles so the equation is $Z((av)_c w^*) = Z(v_c (a^* w)^*)$. In fact the two tangles $(av)_c w^*$ and $v_c (a^* w)^*$ are isotopic in the two-sphere. Observe as a check that the labels in the discs are correctly starred and unstarred on both sides of the equation. Also if we number the boundary regions of the tangles starting with the distinguished one we see that they are numbered the same on the left and right of the equation. (Note that taking the $*$ of an annular tangle reverses the order of the regions of an internal disc but preserves the order of the internal and external boundary discs.) Now imagine a cylinder with discs at either end, one containing v and one containing w^* . On the surface of the cylinder connect v and w with a . Isotoping the surface of the cylinder (minus

a point on the boundary between a and w) to the plane we see $(av)_c w^*$ and taking the point at infinity to be on the boundary between v and w we see $v_c(a^*w)^*$. By spherical invariance we are through. \square

In the operad theory of associative algebras a module over an algebra A over the relevant operad is equivalent to a *bimodule* over A . This is the trivial bimodule. So we will think of the Hilbert P -module P as being the trivial module. The trivial module may or may not be irreducible. It may be irreducible even when $\dim(P_0^\pm) > 1$ At first sight this contradicts lemma 2.11 but remember that σ_\pm determine maps between P_0^\pm .

We record some trivial properties of the elements $\epsilon_i, \epsilon_i^*, F_i, \sigma_\pm$ and the rotation ρ in a Hilbert P -module.

For the rest of this section, unless otherwise stated, planar algebras will be C^* ones and P -module will mean Hilbert P -module.

Proposition 3.3 *The following hold in $ATL(\delta)$:*

- (i) $\epsilon_i^* = \epsilon_i$
- (ii) $\epsilon_i^* \epsilon_i = F_i$ and $\epsilon_i \epsilon_i^* = \delta id$
- (iii) ρ is unitary, i.e. $\rho \rho^* = \rho^* \rho = 1$
- (iv) $F_i^* = F_i$ and if $f_i = \delta^{-1} F_i$, f_i is a projection, i.e. $f_i^2 = f_i$.
- (v) $(\sigma_+)^* = \sigma_-$.

Lemma 3.4 *Let V be a P -module. Suppose $W \subseteq V_k$ is an irreducible AP_k -submodule of V_k for some k . Then $AP(W)$ is an irreducible P -submodule of V .*

Proof. By 2.11 it suffices to show that $AP(W)_m$ is an irreducible AP_m -module for each m . But if v and w are non-zero elements of $AP(W)_m$ with $AP_m(v)$ orthogonal to $AP_m(w)$ then write $v = av'$ and $w = bw'$ for $a, b \in AP(m, k)$ and $v', w' \in W$. Then $a^*v = a^*av'$ and $b^*w = b^*bw'$ are non-zero elements of W with $AP_k(a^*v)$ orthogonal to $AP_k(a^*w)$. \square

Lemma 3.5 *Let U_1 and U_2 be orthogonal AP_k -invariant subspaces of V_k for a P -module V . Then $AP(U_1)$ is orthogonal to $AP(U_2)$.*

Proof. This follows immediately from invariance of \langle, \rangle . \square

Remark 3.6 *Lemmas 3.4 and 3.5 give a canonical decomposition of a P -module V as a countable orthogonal sum of irreducibles. First decompose $V_{wt(V)}$ into an orthogonal direct sum of irreducible $AP_{wt(V)}$ -modules. Each irreducible summand W_i will define a P -submodule $AP(W_i)$ and the $AP(W_i)$ are mutually orthogonal. The orthogonal complement of the $AP(W_i)$ has a higher weight than V so one may continue the process.*

Conversely, given a sequence of P -modules V^i with $\lim_{i \rightarrow \infty} (\text{wt}(V^i)) = \infty$ one may form the countable orthogonal direct sum of P -modules $\oplus_i V_i$.

Thus the dimension of a P -module is the countable sum of the dimensions of irreducible modules whose weights tend to infinity, so the sum of formal power series makes sense. We guess that the dimension of an irreducible P -module has radius of convergence at least as big as δ^{-2} if P has modulus δ .

Lemma 3.7 *Suppose V and W are two P -modules with V irreducible, and that $\theta : V_k \rightarrow W_k$ is a non-zero AP_k homomorphism. Then θ extends to an injective homomorphism Θ of P -modules.*

Proof. Since V is irreducible, for all m , any $v \in V_m$ is of the form av_0 for $v_0 \in V_k$ and $a \in AP(m, k)$. Set $\Theta(v) = a(\theta(v_0))$. To see that Θ is well defined it suffices to check inner products with other vectors in $AP(m, k)(W_k)$. Indeed, suppose $av_0 = bv_0$. Then for any $w_0 \in W_k$, and any $c \in AP$,

$$\begin{aligned} \langle a(\theta(v_0)), cw_0 \rangle &= \langle c^* a(\theta(v_0)), w_0 \rangle \\ &= \langle \theta(c^* av_0), w_0 \rangle \\ &= \langle \theta(c^* bv_0), w_0 \rangle \\ &= \langle b(\theta(v_0)), cw_0 \rangle. \end{aligned}$$

Thus Θ is well defined, a P -module homomorphism by construction and injective since V is irreducible. \square

Thus in particular an irreducible P -module is determined by its lowest weight module. Not all $AP_{\text{wt}(P)}$ -modules can be lowest weight modules as we shall see. Let \widehat{AP}_k be the ideal of AP_k spanned by elements of $\text{Ann}P(k, k)$ of rank (see 2.9) strictly less than $2k$.

Lemma 3.8 *If V is a P -module let W_k be the AP_k -submodule of V_k spanned by the k -graded pieces of all P -submodules of weight $< k$. Then*

$$W_k^\perp = \bigcap_{a \in \widehat{AP}_k} \ker(a)$$

Proof. (i) Choose $w \in W_k$. By definition it is a linear combination of elements of the form aw' with $a \in \text{Ann}P(k, m)$ for $m < k$. But then for $v \in V_k$

$$\langle aw', v \rangle = \langle w', a^*v \rangle$$

and a^* can be written up to a power of δ as the composition t^*ta^* for an appropriate $AnnTL$ tangle t . But then ta^* has rank at most m . So if $v \in \ker(ta^*)$, $a^*v = 0$. Hence w is orthogonal to $\bigcap_{a \in \widehat{AP}_k} \ker(a)$.

(ii) Now suppose $v \perp W_k$ and $a \in \widehat{AP}_k$. Then a is a linear combination of elements of the form bc for some $c \in AnnP(m, k)$ and $b \in AnnP(k, m)$ for some $m < k$. For such a bc and any $w \in W_k$ we have $\langle bcw, w \rangle = \langle v, c^*b^*w \rangle$ which is zero because b^*w is in V_m and therefore a linear combination of vectors in P -submodules of weight $< k$. \square

In the special case of the Temperley Lie algebra TL we get the following, where W_k has the same meaning as in the previous lemma.

Corollary 3.9 *If V is a TL -module then $W_k^\perp = \bigcap_{i=1,2,\dots,2k} \ker(\epsilon_i)$*

Proof. The ideal \widehat{ATL}_k is spanned by Temperley Lie diagrams with less than $2k$ through strings, each of which necessarily factorises as a product with some ϵ_i . \square

Corollary 3.10 *The lowest weight module of an irreducible P -module of weight k is an $\frac{AP_k}{AP_k}$ -module.*

Definition 3.11 *For each k we define the lowest weight algebra at weight k LWP_k to be the quotient $LWP_k = \frac{AP_k}{AP_k}$.*

We see that the job of listing all P -modules breaks down into 2 steps.

Step (i) Calculate the algebras LWP_k and their irreducible modules.

Step (ii) Determine which LWP_k -modules extend to P -modules.

The algebra LWP_k is usually much smaller than AP_k . For instance in the case of ATL it is abelian of dimension k (for $k > 0$) whereas ATL_k is infinite dimensional.

We shall now show how to equip AP with a C^* -norm which can be used to make it into a C^* -category. We first need a uniform bound on labelled tangles.

Lemma 3.12 *Let P be a C^* -planar algebra and V a P -module. Suppose T is a labelled tangle in $AnnP$. Then T defines a linear map between the finite dimensional spaces V_k and V_m . We have*

$$\|T\| \leq C \prod_{\text{internal discs of } T} \|a\|$$

where the constant C depends only on the unlabelled tangle subjacent to T and the a 's are the elements of P labelling the discs (which have norms since P is C^*)

Proof.

Arrange the tangle so that the inner and outer boundaries are concentric circles centred at the origin with internal radius R_0 and external radius R . Let r denote the distance to the origin. Isotope the tangle so that there is a partition $R_0 < R_1 < R_2 < \dots < R$ with only the following three situations in each annulus A_i where r runs from R_i to $R_{(i+1)}$:

- (i) There are no internal tangles in A_i and r has no maxima or minima in A_i . In this case the annular tangle inside A_i is a power of the rotation ρ .
- (ii) There are no internal tangles in A_i and r has a single local maximum (minimum) inside A_i . In this case the annular tangle inside A_i is ϵ_j (ε_j).
- (iii) There is a single k -disc D labelled a inside A_i , and all strings of the tangle inside A_i are intervals of rays from the origin.

We see that in any P -module V the linear map defined by T factorizes as a product of ρ 's, ϵ 's and maps defined by the very simple tangle of situation (iii) above. By 3.3 we only have to show the norm of a tangle Q in situation (iii) is less than $\|a\|$. This can be achieved as follows: we may suppose that half the strings of Q which meet the disc D are ray intervals beginning on the inside boundary of A_i . The map from P_k to AP which sends x to the tangle in A_i with D labelled by x is a $*$ -algebra homomorphism so since P_k is a C^* -algebra we are through. \square

We may thus make the following:

Definition 3.13 *If P is a C^* -planar algebra and $a \in AP(n, m)$ we define the norm of a to be*

$$\|a\| = \sup_{\text{all } P\text{-modules } V} \|\rho_V(a)\|$$

where $\rho_V(a)$ is the linear map from V_m to V_n determined by a and V .

This makes AP into a C^* -category and in particular all the AP_k become C^* -algebras. They are of type I for ATL but we do not know if they are of type I in general.

4 Facts about the ordinary Temperley-Lieb algebra.

For the convenience of the reader let us first recall some facts the ordinary (non-annular) Temperley-Lieb algebra and its representations. These facts

will be used in the proofs below and can all be deduced easily from [12],[7] and Kauffman's diagrammatic in [17].

Fix a complex number δ . The Temperley Lieb algebra TL_n on n strings admits the following presentation as an algebra:

Generators: $\{E_i : i = 1, 2, \dots, n - 1\}$ (and an identity, 1).

Relations: $E_i^2 = \delta E_i$, $E_i E_j = E_j E_i$ for $|i - j| \geq 2$, $E_i E_{i\pm 1} E_i = E_i$.

The algebra can be alternatively defined as that having a basis consisting of all connected n -tangles with the boundary conveniently deformed to a horizontal rectangle having the first boundary point, by convention, at the top left. Then E_i is the tangle with all boundary points except four connected by vertical lines and the i -th. and $i + 1$ -th. on the top (resp. bottom) connected to each other by a curve close to the top (resp. bottom) boundary. There is an adjoint operation $a \rightarrow a^*$ on TL_n defined by sesquilinear extension of the operation on tangles which is reflection in a horizontal line half way up the tangle. Alternatively, the operation $*$ is the unique anti-involution for which $E_i^* = E_i$.

Fact 4.1 *The dimension of TL_n is $\frac{1}{n+1} \binom{2n}{n}$.*

TL_n can, and will, be identified unitaly with the subalgebra of TL_{n+1} alternatively by adding a vertical string to the right of the rectangle defining TL_n , or by identifying the first $n - 1$ generators of T_{n+1} with those of TL_n .

Fact 4.2 *The map $x \rightarrow \frac{1}{\delta} x E_{n+1}$ defines an algebra isomorphism of TL_n onto the "corner" subalgebra $E_{n+1}(TL_{n+2})E_{n+1}$.*

Fact 4.3 *TL_n is a C^* -algebra, hence semisimple, for $\delta \in \mathbb{R}$, $\delta \geq 2$.*

Define the Tchebychev polynomials in δ by $P_{k+1} = \delta P_k - P_{k-1}$, with $P_0 = 0$ and $P_1 = 1$ so that if $\delta = 2 \sinh(x)$ we have

$$P_k(\delta) = \frac{\sinh(kx)}{\sinh(x)}$$

Fact 4.4 *For $\delta \geq 2$ let $1 - p_n$ denote the identity of the ideal of TL_n defined alternatively as the linear span of diagrams with at most $n - 1$ through strings or the linear span of non-empty words on the E_i . Then $p_1 = 1$ and*

$$p_{n+1} = p_n - \frac{P_n}{P_{n+1}} p_n E_n p_n.$$

Fact 4.5 We have $p_n^2 = p_n^* = p_n^2$ and p_n is the unique non-zero idempotent in TL_n for which $p_n E_i = E_i p_n = 0$ for all $i < n$.

The element p_n can thus be defined as the linear coefficient of words in the E_i 's (or alternatively n -tangles) defined by the above formula. The coefficients of the individual words do not appear to be known explicitly. Graham and Lehrer in [9] obtain explicit formulae at special values of δ . An improved knowledge of these coefficients is desirable but we will need only the following very simple case.

Lemma 4.6 For $1 \leq r \leq n - 1$, the coefficient of $E_{n-1}E_{n-2}\dots E_r$ in p_n is

$$\frac{(-1)^r \sinh(rx)}{\sinh(nx)}.$$

Proof. The only way to obtain the term $E_{n-1}E_{n-2}\dots E_{n-r}$ in Wenzl's formula in 4.4 is to multiply E_{n-1} by the term $E_{n-2}E_{n-2}\dots E_{n-r}$ in TL_{n-1} . So by induction we are done. \square

For each $t \leq n$ with $n-t$ even we consider the vector space V_n^t having as a basis the set \mathcal{V}_n^t of all rectangular horizontal Temperley-Lieb $(n+t)/2$ -tangles with t boundary points on the bottom and n points on the top with all strings connected to the bottom boundary points being through strings. V_n^t becomes a TL_n -module by joining the top of an element of \mathcal{V}_n^t with the bottom of an element of TL_n . Remove any closed circles formed as usual, each one counting a multiplicative factor of δ . If there are less than t through strings the result is zero. There is an inner product on V_n^t defined as $\langle x, y \rangle = \phi(y^*x)$ where ϕ is the map from TL_t to the one dimensional quotient of TL_t by the ideal spanned by TL tangles with less than t through strings.

Fact 4.7 The dimension of V_n^t is $\binom{n}{\frac{n-t}{2}} - \binom{n}{\frac{n-t-2}{2}}$.

Fact 4.8 For $\delta \geq 2$ each representation V_n^t is irreducible and any irreducible representation of TL_n is isomorphic to a V_n^t .

Fact 4.9 The inner product is invariant, i.e $\langle ax, y \rangle = \langle x, a^*y \rangle$ for $a \in TL_n$ and positive definite. It is the unique invariant inner product on V_n^t up to a scalar multiple.

Proposition 4.10 *If $\delta > 2$ and $0 \leq t < n$ with $n-t$ even, a representation π of TL_n on V contains V_n^t if and only if the restriction of π to $E_{n-1}(TL_n)E_{n-1}$ (on $\pi(E_{n-1})V$) contains V_{n-2}^t . If π is irreducible, an invariant inner product on V is positive definite if and only if it restricts to a positive definite one on $\pi(E_{n-1})V$.*

Proof. Note first that by 4.2 $E_{n-1}(TL_n)E_{n-1}$ is isomorphic to $TL_{(n-2)}$ so the assertion makes sense. But it is also clear that the subspace $E_{n-1}V_n^t$ is isomorphic as an $E_{n-1}(TL_n)E_{n-1}$ -module to V_{n-2}^t . So the containment assertion follows by decomposing V and $\pi(E_{n-1})V$ as TL_n and TL_{n-2} -modules respectively. The assertion about the inner products is an immediate consequence of 4.9. \square

For appendix B we will also need some information about the Hilbert space representations of the ordinary TL algebra when $\delta = 2 \cos \frac{\pi}{m}$ and $m = 3, 4, 5, \dots$. For these values of δ the TL-algebra has a largest C^* quotient whose Bratteli diagram is well known-see [12] or [7]. We will call this quotient TL_n , which is an abuse of notation. The modules V_n^t admit quotients which are Hilbert spaces on which TL_n is represented as a C^* -algebra. Continuing the abuse of notation we will call these Hilbert space representations V_n^t .

Fact 4.11 *If $\delta = 2 \cos \frac{\pi}{m}$ with $m = 3, 4, 5, \dots$ the TL_n modules are uniquely defined up to isomorphism by the conditions:*

$$\begin{aligned} V_n^t &= 0 \text{ for } t < 0 \text{ or } t > n \\ V_n^n &= \mathbb{C} \text{ for } n \leq m - 2 \\ V_{m-1}^{m-1} &= 0 \\ V_n^t &= V_{n-1}^{t-1} \oplus V_{n-1}^{t+1} \text{ as } TL_{n-1}\text{-modules.} \end{aligned}$$

All such representations have dimensions less than or equal to their generic values.

This fact is equivalent to the structure of the Bratteli diagram ([4]).

5 The TL -modules for $\delta > 2$.

We will use the approach outlined after definition 3.11 to obtain all TL -modules. The first step is very easy- the algebras $\frac{ATL_k}{ATL_k}$ and their irreducible modules are determined (for any δ) in the next lemma, for $k > 0$.

Lemma 5.1 For $k > 0$ the quotient $\frac{ATL_k}{ATL_k}$ is generated by the rotation ρ , thus its irreducible representations are 1-dimensional and parametrized naturally by the k th. root of unity by which ρ acts.

Proof. If all strings are through strings a (k, k) -tangle is necessarily a power of ρ . \square

For the rest of this section we will suppose $\delta > 2$. This simplifies the situation considerably. For $\delta \leq 2$ the quotient of ATL_k by the zero through-string ideal is no longer semisimple.

To see that each representation of the previous lemma extends to a TL -module, we begin by constructing modules of lowest weight k , $V^{k,\omega}$, for ω a k th. root of unity, quite explicitly in a way very similar to the construction of the non-annular Temperley-Lieb modules in the previous section.

Definition 5.2 Let $\widetilde{ATL}_{m,k}$ be the quotient of $ATL_{m,k}$ by the subspace spanned by tangles with less than $2k$ through strings. (So that $\widetilde{ATL}_{m,k} = 0$ if $m < k$.)

Since the number of through strings does not increase under composition of tangles, $\widetilde{ATL}_{m,k}$ is a TL -module of lowest weight k . One may describe this TL -module quite explicitly in terms of a basis as follows:

For $m \geq k$ let $Th_{m,k}$ be the set of all $ATL_{m,k}$ tangles with k through strings and no closed circular strings. Clearly the images of $Th_{m,k}$ in $\widetilde{ATL}_{m,k}$ form a basis. We now describe the action of ATL on this basis.

If $T \in AnnTL(p, m)$ and $Q \in Th_{m,k}$ consider the annular (p, k) tangle TQ . Suppose TQ has c closed circular strings and let \widehat{TQ} be TQ from which the closed strings have been removed.

Then $T(Q)$ is

- (i) 0 if TQ has less than $2k$ through strings.
- (ii) $\delta^c \widehat{TQ}$ otherwise.

The group $\mathbb{Z}/k\mathbb{Z}$ acts on $\widetilde{ATL}_{m,k}$ by internal rotation, freely permuting the basis $Th_{m,k}$. This action commutes with the action of ATL . Thus the TL -module $\widetilde{ATL}_{m,k}$ splits as a direct sum, over the k th. roots of unity ω , of TL -modules which are the eigenspaces for the action of $\mathbb{Z}/k\mathbb{Z}$ with eigenvalue ω . These are the $V^{k,\omega}$ with $V_m^{k,\omega}$ being the ω -eigensubspace of $\widetilde{ATL}_{m,k}$.

Proposition 5.3 The dimension of $V_m^{k,\omega}$ is $\binom{2m}{m-k}$ for $m \geq k$ (and zero for $m < k$).

Proof. Since the action of $\mathbb{Z}/k\mathbb{Z}$ is free, the dimension of $V_m^{k,\omega}$ is $\dim(\widetilde{ATL}_{m,k})/k$ and it was shown in [14] that $\dim(\widetilde{ATL}_{m,k}) = k \binom{2m}{m-k}$. \square

Let $\mathcal{C}(z) = \frac{1 - \sqrt{1 - 4z}}{2z}$, the generating function for the Catalan numbers.

Corollary 5.4 *The dimension of the TL -module $V^{k,\omega}$ is $z^k \frac{\mathcal{C}(z)^{2k}}{\sqrt{1 - 4z}}$.*

Proof. By 5.3 the generating function for $\dim(V_m^{k,\omega})$ is $z^k \sum_{r=0}^{\infty} \binom{2k + 2r}{r} z^r$.

By [8] page 203 this gives the answer above. \square

For each k choose a faithful trace tr on the abelian C^* -algebra $\widetilde{ATL}_{k,k}$. Extend tr to all of $ATL_{k,k}$ by composition with the quotient map. Use tr to define an inner product on the whole TL -module $\widetilde{ATL}_{m,k}$ as follows.

Given $S, T \in ATL_{m,k}$, T^*S is in $ATL_{k,k}$ so we set

$$\langle S, T \rangle = tr(T^*S)$$

This inner product clearly satisfies $\langle av, w \rangle = \langle v, a^*w \rangle$ as in definition 3.1. And the rotation is clearly unitary so that the decomposition into the $V^{k,\omega}$ is orthogonal. The main result of this section will be to show that the inner product is positive definite for $\delta > 2$, which is not always the case when $\delta \leq 2$.

Definition 5.5 *Let ψ_k^ω be a vector in $V_k^{k,\omega}$ proportional to $\sum_{j=1}^k \omega^{-j} \rho^j$ with $\langle \psi_k^\omega, \psi_k^\omega \rangle = 1$.*

Observe that $\epsilon_i \psi_k^\omega = 0$ for $i = 1, 2, \dots, 2k$. This is because $\epsilon_i \psi_k^\omega$ is in $V_{k-1}^{k,\omega}$ which is zero.

Proposition 5.6 *All inner products in $V^{k,\omega}$ are determined by the three formulae*

$$\begin{aligned} \epsilon_i \psi_k^\omega &= 0 \quad \text{for } i = 1, 2, \dots, 2k \\ \langle \psi_k^\omega, \psi_k^\omega \rangle &= 1 \\ \rho(\psi_k^\omega) &= \omega \psi_k^\omega \end{aligned}$$

Proof. $V^{k,\omega}$ is spanned by annular TL -tangles applied to ψ_k^ω . When calculating the partition function of such an R^*Q the answer will be zero unless all the strings leaving one ψ_k^ω are connected to the other. If they are not, R^*Q contains some ϵ_i applied to some ψ_k^ω . If the two ψ_k^ω 's are completely joined, one may apply some power of ρ so that, after removing closed circles, the tangle R^*Q is exactly that whose partition function gives $\langle \psi_k^\omega, \psi_k^\omega \rangle$. \square

Theorem 5.7 *For each $k \geq 1$ and for each k th. root of unity ω , the representation of ATL_k of lemma 5.1 extends to a representation $\Gamma^{k,\omega}$ on $V^{k,\omega}$ of lowest weight k , making $V^{k,\omega}$ into a Hilbert TL -module.*

Proof. It suffices to show that \langle, \rangle is positive definite on each $V_m^{k,\omega}$ which we will do by induction on m as follows.

Think of the annulus for annular (m, m) -tangles as two concentric circles with distinguished boundary points evenly spaced, and draw a straight line between inner and outer boundaries half way between the $2m$ th. and first boundary points. The subalgebra \mathcal{A}_m of ATL_m spanned by annular tangles never crossing this straight line is clearly isomorphic to the usual Temperley-Lieb algebra TL_{2m} , with elements $F_1, F_2, \dots, F_{2m-1}$ of definition 2.8 corresponding to the usual TL generators E_1, \dots, E_{2m-1} . The exact assertion we will prove by induction is the following:

Assertion: As a \mathcal{A}_m -module, $V_m^{k,\omega}$ is isomorphic to $\bigoplus_{j=2k, 2k+2, 2k+4, \dots, 2m} V_{2m}^j$, the sum being orthogonal with respect to the positive definite form \langle, \rangle .

The case $k = m$ is covered by the definition, so suppose the assertion is true for $m - 1$ which is $\geq k$. Identify \mathcal{A}_{m-1} with $F_{2m-1}\mathcal{A}_m F_{2m-1}$ as in 4.2. Pictures show that the map $x \rightarrow \varepsilon_{2m-1}(x)/\delta$ is an isometry (for \langle, \rangle) of $V_{m-1}^{k,\omega}$ onto the subspace $F_{m-1}V_m^{k,\omega}$ which intertwines the actions of \mathcal{A}_{m-1} and \mathcal{A}_m . Proposition 4.10 shows that $V_m^{k,\omega}$ contains V_{2m}^j for $j = 2k, 2k+2, \dots, 2m-2$. By 4.7 $V_m^{k,\omega}$ contains a submodule whose dimension is a telescoping sum adding up to $\binom{2m}{m-k} - 1$. Since $\dim V_m^{k,\omega} = \binom{2m}{m-k}$ we conclude that $V_m^{k,\omega}$ contains each V_m^k exactly once and since TL_m is a C^* -algebra, that the sum $\bigoplus_{j=2k, 2k+2, 2k+4, \dots, 2m-2} V_{2m}^j$ is orthogonal. Thus we will be done if we can show that there is a vector orthogonal to $\bigoplus_{j=2k, 2k+2, 2k+4, \dots, 2m-2} V_{2m}^j$ whose inner product with itself is strictly positive.

The range of the idempotent $p_{2m} \in \mathcal{A}_m$ will be orthogonal to $\bigoplus_{j=2k, 2k+2, 2k+4, \dots, 2m-2} V_{2m}^j$ since \langle, \rangle is invariant and $p_{2m} = p_{2m}^*$. The only vectors v of $V_m^{k,\omega}$ obtained by applying elements of $Th_{m,k}$ to ψ_k^ω for which $p_{2m}(v) \neq 0$ are proportional to the vector ξ depicted below. Note that we have not starred an initial region on the internal boundary. The location of such a $*$ would depend on the parity of $m - k$ and any choice of $*$ will differ only by a k th. root of unity which will be irrelevant to our argument. An

explicit choice of ξ would be $\varepsilon_{2m}\varepsilon_{2m-3}\varepsilon_{2m-4}\varepsilon_{2m-7}\varepsilon_{2m-8}\dots(\psi_k^\omega)$, with the last subscript of ε being even or odd depending on the parity of $m - k$.

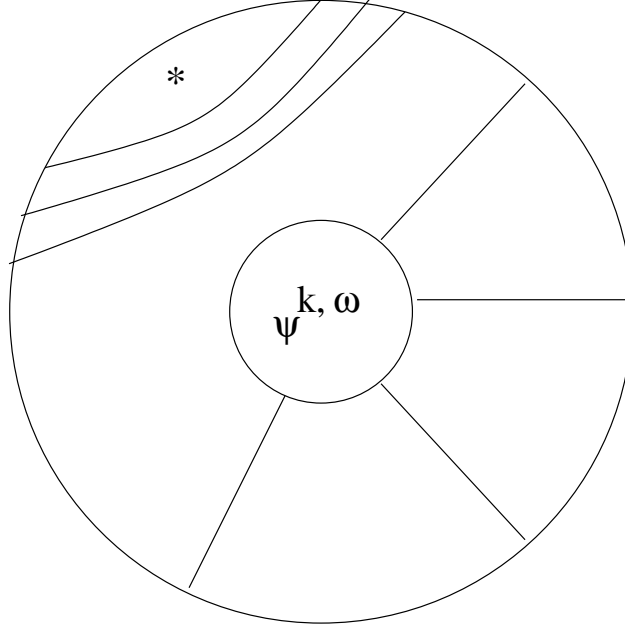

Let $\zeta = p_{2m}(\xi)$. To show that $\langle \zeta, \zeta \rangle > 0$ we could apply proposition 4.2 of [9] but because of differences in the setup such as specialisation to non-positive values and the colouring restriction we prefer to give another proof.

We begin by proving, by contradiction, that $\langle \zeta, \zeta \rangle$ cannot be 0. This will be the main step in the proof of the theorem. So suppose $\langle \zeta, \zeta \rangle = 0$. The form $\langle \cdot, \cdot \rangle$ is then positive semidefinite and ζ spans its kernel. (Note that ζ is not zero since when one expands p_{2m} as a linear combination of words, there is only one term that gives ξ , namely the identity of \mathcal{A}_m .) Since the kernel of a form is invariant under any isometry we conclude that $Ad\rho^{\frac{1}{2}}(\zeta) = z\zeta$ where $Ad\rho^{\frac{1}{2}}$ is the rotation by 1 of appendix A and z is a complex number of absolute value 1 (in fact a root of unity by A.6).

We shall now determine which words in the sum for p_{2m} contribute to the coefficient of ξ in ζ and $Ad\rho^{\frac{1}{2}}(\zeta)$. We draw pictures of all the elements below where we have deformed the annulus into the region between two rectangles and the outer annulus contains ψ_k^ω . The distinguished boundary regions are marked with a $*$ in all cases. The only way to obtain ξ from a summand of p_{2m} is to take the identity whose coefficient is of course 1. This follows from inspection of the figure below. Note that we have redrawn ξ by deforming the inner annulus boundary into a rectangle with all the $2k$ boundary points

on top. This is to help visualise what is happening inside the box containing p_{2m} which we have also drawn as a rectangle with $2m$ input strings at the bottom and $2m$ output ones at the top.

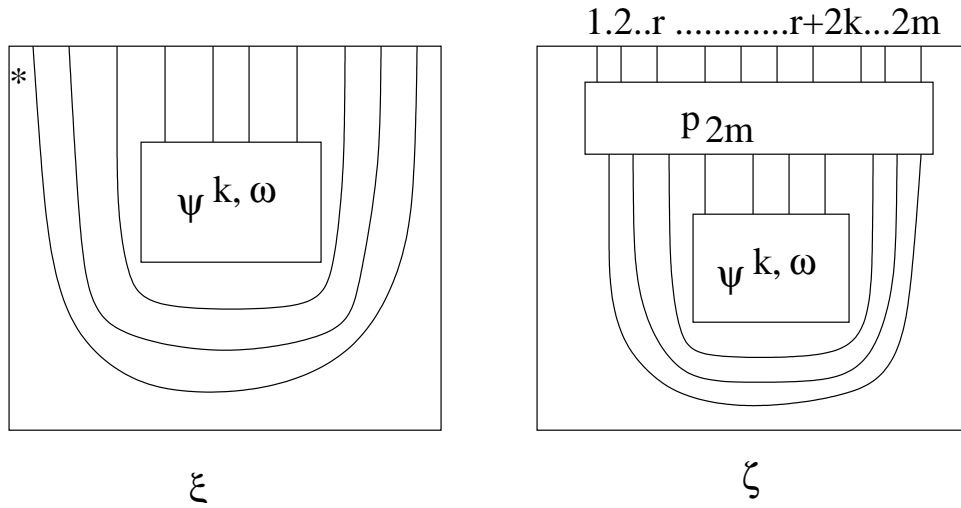

Now consider $Ad\rho^{\frac{1}{2}}(\xi)$ as below:

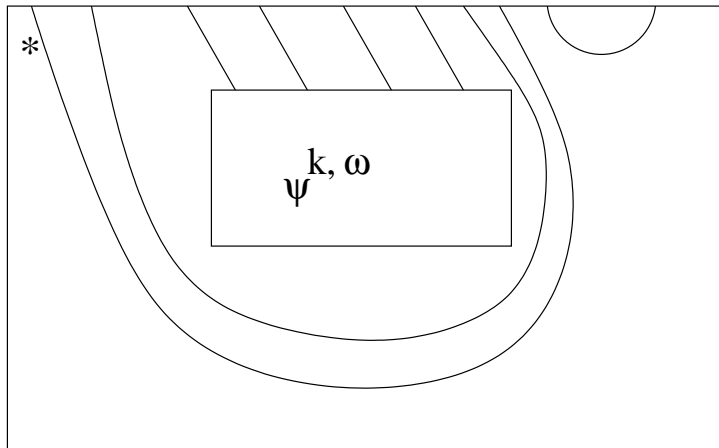

The coefficient of ξ in $(Ad\rho^{\frac{1}{2}})^{-1}(\zeta)$ is the same as the coefficient of $Ad\rho^{\frac{1}{2}}(\xi)$ in ζ so we must consider all possible TL tangles that can be inserted into the rectangle \mathcal{R} containing p_{2m} that will give the above picture of $Ad\rho^{\frac{1}{2}}(\xi)$. If such a tangle has less than $2m - 2$ through strings then there is a homologically non-trivial circle in the annulus which intersects the strings of the tangle less than $2m - 2$ times, whereas any such circle in the diagram for $Ad\rho^{\frac{1}{2}}(\xi)$ intersects the strings of the tangle at least $2m - 2$ times. And there must be some non-through strings since the identity inserted into \mathcal{R} gives

ξ itself. So at both the top and bottom of \mathcal{R} there is precisely one pair of neighbouring boundary points connected to each other. Number the boundary points at the top of \mathcal{R} as $1, 2, \dots, r, r+1, r+2, \dots, r+2k, r+2k+1, \dots, 2m$ where $r+k=m$, and the same on the bottom. Then if i and $i+1$ are connected on the bottom of \mathcal{R} for $i < r$ or $i > r+2k$ the same argument as we used to get $2m-2$ through strings applies and we do not get $Ad\rho^{\frac{1}{2}}(\xi)$. If they are connected for i between $r+1$ and $r+2k-1$ we get zero. So the only allowed connections on the bottom are between r and $r+1$ or between $r+2k$ and $r+2k+1$. On the top of \mathcal{R} it is clear that the only boundary points that can be connected are $2m-1$ and $2m$. Moreover we see the two tangles with both these top and bottom combinations do indeed give roots of unity times ξ . As words on the E_i , these two tangles are $E_{2m-1}E_{2m-2}\dots E_{r+2k}$ and $E_{2m-1}E_{2m-2}\dots E_r$. So by 4.6 we deduce that there are complex numbers z_1 and z_2 of absolute value 1 (in fact both roots of unity) so that, if $\delta = 2 \cosh(x)$,

$$\frac{z_1 \sinh((r+2k)x) + z_2 \sinh(rx)}{\sinh(2mx)} = 1.$$

But since $\sinh(2mx) = \sinh(rx) \cosh((r+2k)x) + \sinh((r+2k)x) \cosh(rx)$ and $\cosh t > 1$ for $t \neq 0$, this is impossible for $x \neq 0$. This contradicts the hypothesis that $\langle \zeta, \zeta \rangle = 0$.

We now need to rule out the possibility that $\langle \zeta, \zeta \rangle < 0$. But the interval $(2, \infty)$ is connected and $\langle \zeta, \zeta \rangle$ is a continuous function since the polynomials in the denominators appearing in p_{2m} have all their zeros in $[-2, 2]$. So it suffices to exhibit a single value of δ greater than 2 for which $\langle \zeta, \zeta \rangle \geq 0$. In [14] we showed that each of the modules $V_m^{k,\omega}$, for δ any integer $n \geq 3$, occurs as a summand of the tensor product of m copies of the 3×3 matrices which has a natural ATL structure and positive definite inner product.

So $V_m^{k,\omega}$ has the \mathcal{A} -module structure we asserted and \langle, \rangle is positive definite on it. By induction we are through. \square

Corollary 5.8 *The Hilbert TL-module $V^{k,\omega}$ is irreducible.*

Proof. $V^{k,\omega}$ is $ATL(\psi^{k,\omega})$ so apply 3.4. \square

We now take up the case of TL-modules with lowest weight 0. This is somewhat different from the previous situation as the algebras ATL_{\pm} are infinite dimensional.

Proposition 5.9 *The abelian algebra ATL_{\pm} is generated by the positive self-adjoint element $\sigma_{\mp}\sigma_{\pm}$.*

Proof. After removing any homologically trivial circles (which count for a factor of δ by note (iii) after definition 2.2), an annular $(0, 0)$ -tangle consists

of an even number of homologically non-trivial circles inside the annulus, which is by definition a power of $\sigma_{\mp}\sigma_{\pm}$. Positivity of $\sigma_{\mp}\sigma_{\pm}$ follows from 3.3. \square

Corollary 5.10 *In an irreducible Hilbert TL -module V of lowest weight 0 the dimensions of V_{\pm} are 0 or 1 and the maps $\sigma_{\mp}\sigma_{\pm}$ are both given by a single real number μ^2 with $0 \leq \mu \leq \delta$.*

Remark 5.11 *The number μ above corresponds to the $z + z^{-1}$ of Graham and Lehrer. The main difference between their setup and ours is that a single homologically non-trivial circle in an annulus does not act by a scalar in an irreducible representation - it is in fact the map σ_{\pm} .*

Theorem 5.12 *An irreducible Hilbert TL -module V of weight 0 is determined up to isomorphism by the dimensions of V_{\pm} and the number μ defined in corollary 5.10. Moreover $0 \leq \mu \leq \delta$.*

Proof. The uniqueness of the TL -module is a consequence of 3.7 since at least one of V_+ and V_- is non-zero. By definition, $\mu \geq 0$. To see that $\mu \leq \delta$, note that in an irreducible Hilbert TL -module V , as operators on V_1 , the elements F_1 and F_2 satisfy $F_1F_2F_1 = \mu^2F_1$, and $\frac{1}{\delta}F_1$ and $\frac{1}{\delta}F_2$ are projections. \square

We now take up the existence of Hilbert TL -modules of lowest weight 0. There is one value of μ for which the TL -module has already been constructed and that is of course $\mu = \delta$. Let $V_k^{\delta} = TL_k$. By 3.2 we know that V_k^{δ} is a Hilbert TL -module since $\delta > 2$. We have thus established the following.

Proposition 5.13 *Any irreducible Hilbert TL -module of lowest weight zero and $\mu = \delta$ is isomorphic to V^{δ} .*

We now obtain all irreducible TL -modules of lowest weight 0 with $0 < \mu < \delta$.

Definition 5.14 *For each $k > 0$ and \pm when $k = 0$ let Th_k be the set of all annular $(k, +)$ -tangles with no homologically trivial circles and at most one homologically non-trivial one.*

Lemma 5.15 *The cardinality of Th_k is $\binom{2k}{k}$, and 1 when $k = 0$.*

Proof. Such a tangle consists of an ordinary Temperley Lieb diagram with the outer annulus boundary in either a shaded or unshaded region according to whether it is or is not surrounded by a homologically non-trivial circle. There are $k + 1$ regions in an ordinary TL k -tangle. \square

Now for each number μ we form the graded vector space V^μ , whose k th. graded component has a basis Th_k , and equip it with a TL-module structure of lowest weight 0 as follows:

If T is an $ATL(n, k)$ -tangle and $R \in Th_k$, form the tangle TR . Let c be the number of contractible circles in TR . Suppose the inner boundary circle in TR is surrounded by $2d + \gamma$ homologically non-trivial circles where γ is 0 or 1. Then

$$T(R) = \delta^c \mu^{2d} \widehat{TR}$$

where \widehat{TR} is TR from which all contractible circles and $2d$ of the non-contractible ones have been removed.

Proposition 5.16 *The above definition makes V^μ into a TL-module of dimension $\frac{1}{\sqrt{1-4z}}$, in which $\sigma_\pm \sigma_\mp = \mu^2$.*

Proof. In the picture for $T_1 T_2 R$ (without any circles removed), circles, contractible or not, are either formed already in $T_2 R$ or formed when T_1 is applied to it. The dimension formula follows from 5.15 and page 203 of [8]. \square

Note that the choice of $(k, +)$ -tangles rather than $(k, -)$ ones to define V^μ was arbitrary. If we had made the other choice the map $T \rightarrow \mu^{-1} T \sigma_+$ would have defined an isometric TL-module isomorphism with the choice we have made. We now define an invariant inner product on V^μ .

Definition 5.17 *Given $S, T \in Th_k$ let $\langle S, T \rangle = \delta^c \mu^{2d}$ where c is the number of contractible circles in the (\pm, \pm) -tangle $T^* S$ and d is half the number of non-contractible ones.*

Invariance of \langle, \rangle follows from the fact that $T^* S = \langle S, T \rangle T_0$ where T_0 is the annular (\pm, \pm) -tangle with no strings whatsoever.

Theorem 5.18 *For $0 < \mu < \delta$ the above inner product is positive definite and so makes V^μ into an irreducible Hilbert TL-module of lowest weight 0.*

Proof. The proof is structurally identical to that of theorem 5.7. Define the algebra \mathcal{A}_m as before and make the same assertion to be proved by induction, namely:

Assertion: As a \mathcal{A}_m -module, $V_m^{k,\omega}$ is isomorphic to $\bigoplus_{j=2k, 2k+2, 2k+4, \dots, 2m} V_{2m}^j$, the sum being orthogonal with respect to the positive definite form $\langle \cdot, \cdot \rangle$.

By induction we need only show that any vector in the image of the idempotent $p_{2m} \in \mathcal{A}_m$ has non-zero inner product with itself. The vector ξ becomes the tangle in Th_m with m strings connecting the first m boundary points to the last m , going around the internal annulus boundary. If m is odd there are no circular strings and if n is even there is one such string surrounding the internal annulus boundary. The vector ζ is the result of applying p_{2m} to ξ . We illustrate in the odd case below.

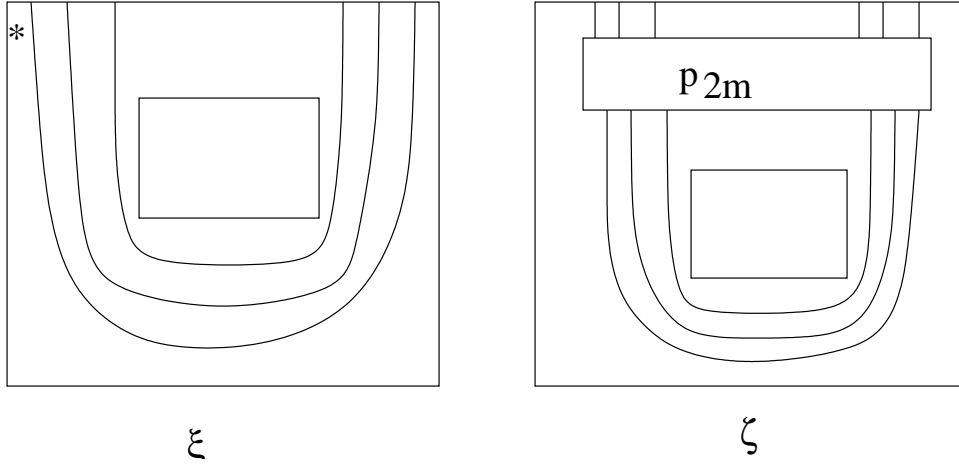

We are trying to show that $\langle \zeta, \zeta \rangle > 0$ and we begin by supposing, by way of contradiction, that $\langle \zeta, \zeta \rangle = 0$. This means that ζ is an eigenvector for the rotation by one (see the appendix). As we did in 5.7 we must find the terms in the expansion of p_{2m} as TL diagrams in ζ that give a multiple of $Ad\rho^{\frac{1}{2}}(\xi)$. We draw the unit vector $\mu Ad\rho^{\frac{1}{2}}(\xi)$ below.

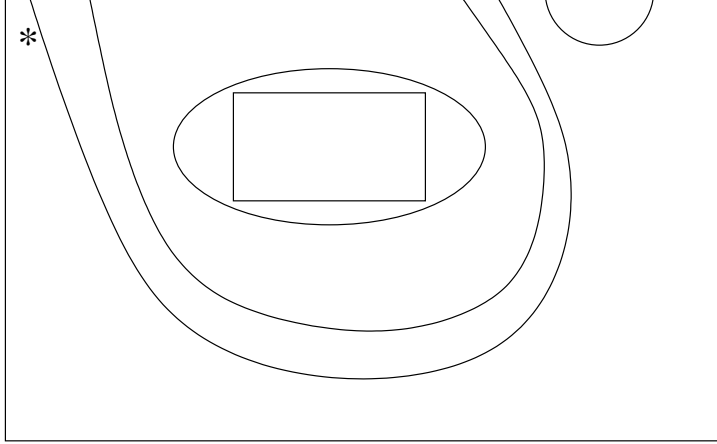

$$\mathfrak{u} \quad \text{Ad } \rho^{1/2}(\xi)$$

It is clear that there is only one TL diagram that can be inserted in the rectangle \mathcal{R} containing p_{2m} . It is the one where the m th. boundary point at the bottom of \mathcal{R} is connected to the $(m+1)$ th., and the last boundary point at the top \mathcal{R} is connected to the second to last. All other strings must be through strings. This diagram is the word $E_{2m-1}E_{2m-2}\dots E_m$ so by fact 4.6 the coefficient of $\mu \text{Ad} \rho^{1/2}(\xi)$ is, in absolute value, $\frac{\sinh(mx)}{\sinh(2mx)}$ where $\delta = 2 \cosh(x)$. So since $\mu < \delta < \cosh(mx)$, this coefficient is never $\frac{1}{\mu}$.

This contradicts the assumption that $\langle \zeta, \zeta \rangle = 0$. The region $\{(\mu, \delta) : 0 < \mu < \delta, \delta > 2\}$ is connected so as in 5.7 it suffices to find a single value in that region for which \langle, \rangle is positive semidefinite. Here we appeal to [15] where we gave planar algebras P with spherically invariant partition functions for any (finite) bipartite graph. The adjacency matrix Λ of the graph has a simple meaning in our picture. It is the matrix of the linear transformation σ_+ with respect to bases of minimal projections of P_0^+ and P_0^- . The parameter δ of the planar algebra is the norm of Λ , i.e. the square root of the largest eigenvalue of $\Lambda^T \Lambda$. Choose a unit eigenvector v of $\Lambda^T \Lambda$ whose eigenvalue is between 0 and δ^2 . And let μ be the positive square root of this eigenvalue. Consider the TL -submodule $ATL(v)$ of P generated by v . It is linearly spanned by $\cup_k Th_k(v)$. Moreover the inner product between vectors in $ATL(v)$ is given precisely by the formula 5.17 used to define the inner product in V_k^μ . But the inner product on the planar algebra P is by construction positive definite so the one on V_k^μ is positive semidefinite. Hence $\langle \zeta, \zeta \rangle > 0$ and the inductive assertion is true for m .

Irreducibility follows from 3.4 as before. \square

The last case to consider in the generic region $\delta > 2$ is the case $\mu = 0$.

Definition 5.19 For each k let Th_k^\pm be the set of annular (k, \pm) -tangles with no circular strings, contractible or otherwise.

Lemma 5.20 The cardinality of Th_k^\pm is $\frac{1}{2} \binom{2k}{k}$ if $k > 0$, 1 if $k = \pm$ and 0 if $k = \mp$.

Proof. The set Th_k^\pm splits into two subsets of equal cardinality—those where there is a single non-contractible circle and those where there is none. The result then follows from 5.15. \square

Now we form the graded vector space $V^{0,\pm}$, whose k th. graded component has a basis Th_k^\pm , and equip it with a TL -module structure of lowest weight 0 as follows:

If T is an $ATL(n, k)$ -tangle and $R \in Th_k^\pm$, form the tangle TR . Let c be the number of contractible circles in TR . Then

$$T(R) = \begin{cases} 0 & \text{if there is a non-contractible circle in } TR \\ \delta^c \widehat{TR} & \text{otherwise} \end{cases}$$

where \widehat{TR} is TR from which all contractible circles and $2d$ of the non-contractible ones have been removed.

Proposition 5.21 The above definition makes $V^{0,\pm}$ into a TL -module of dimension $\frac{1}{2\sqrt{1-4z}}$, in which $\sigma_\pm = 0$.

Proof. The module property follows as in 5.16. The dimension formula follows from the way the $k = 0$ case is handled in 2 and 5.20. Finally, σ^\pm creates a non-contractible circle. \square

We now define an inner product on $V^{0,\pm}$.

Definition 5.22 Given $S, T \in Th_k^\pm$, suppose there are c contractible circles in S^*T . Then set

$$\langle T, S \rangle = \begin{cases} 0 & \text{if there is a non-contractible circle in } S^*T \\ \delta^c & \text{otherwise} \end{cases}$$

This inner product is invariant for the same reason as before.

Theorem 5.23 For $\delta \geq 2$ the above inner product is positive definite and so makes $V^{0,\pm}$ into an irreducible Hilbert TL -module of lowest weight 0.

Proof. Again the proof will be via an inductive decomposition of $V_m^{0,\pm}$ with respect to non-annular TL . The rotation by one is not available but we give a closely related argument which shows that it is not really the rotation by one that is important but the existence of two copies of non-annular TL which differ with respect to the shading. For simplicity we will only do the $V^{0,+}$ case, the argument being the same in the other case up to obvious modifications.

Call TL_{2m}^a the Temperley Lieb algebra \mathcal{A}_m which we have used in 5.7 and set $TL_{2m}^b = Ad\rho^{\frac{1}{2}}(TL_{2m}^a)$. The inductive affirmation we will prove is as follows:

Affirmation: The inner product of 5.22 is positive definite on $V_m^{0,+}$, and for m odd, as a TL_{2m}^a -module, $V_m^{0,+} = \bigoplus_{j=2m, 2m-4, \dots, 2} V_{2m}^j$ and as a TL_{2m}^b -module, $V_m^{0,+} = \bigoplus_{j=2m-2, 2m-6, \dots, 0} V_{2m}^j$. For m even the situation is reversed.

Note that the fact that the dimensions involved in the affirmation both add up to $\frac{1}{2} \binom{2m}{m}$ are simple binomial identities coming from $(1-1)^{2m} = 0$.

For $m = 0$ and $m = 1$ the assertion is true. The $m = 0$ case depends a bit too much on conventions so one should check the case $m = 2$ as well. Here $V_2^{0,+}$ is 3 dimensional and for TL^a , $E_1 \neq E_3 \neq 0$ so by the structure of TL_4 , $V_2^{0,+}$ must be the irreducible 3-dimensional representation. With respect to TL^b , $E_1 = E_3 \neq 0$ so the other two irreducible representations occur. Positive definiteness of the inner product is a trivial calculation.

So we may suppose that the assertion is proved up to $m - 1$. If m is odd, reduce by $E_{2m} \in TL^b$ and use proposition 4.10 to conclude that the structure of $V_m^{0,+}$ as a TL_{2m}^b -module is correct, hence the form is positive definite by uniqueness as in 5.7. Reducing by $E_{2m} \in TL^a$ we see that the structure of $V_m^{0,+}$ as a TL_{2m}^a -module is correct. If m is even, simply reverse the roles of a and b in the argument. We have only used positive definiteness with respect to ordinary TL so the theorem is true for $\delta = 2$ as well. \square

To end this section let us summarize our results. We have obtained a complete list of all irreducible (hence all) Hilbert $TL(\delta)$ -modules for $\delta > 2$ and calculated their dimensions. They are distinguished by two invariants—the lowest weight k and another number which is a k th. root of unity if $k > 0$ and when $k = 0$ a real number μ with $0 \leq \mu \leq \delta$. The case $\mu = 0$ is exceptional in that there are two distinct modules distinguished by the shading in the 0-graded component. The following table contains all the information.

The TL -modules for $\delta > 2$				
Representation	Lowest wt	Action of ρ/σ_{\pm}	dimension	$dimV$
$V_n^{k,\omega}, n \geq k > 0$ $\omega^n = 1$	n	$\rho = \omega id$	$\binom{2n}{n-k}$	$z^k \frac{\mathcal{C}(z)^{2k}}{\sqrt{1-4z}}$
V_n^{TL}	0	$\sigma_{\pm} = \delta id$	$\frac{1}{n+1} \binom{2n}{n}$	$\mathcal{C}(z)$
V_n^{μ}	0	$\sigma_{\pm} \sigma_{\mp} = \mu^2 id$	$\binom{2n}{n}$	$\frac{1}{\sqrt{1-4z}}$
$V_n^{0,\pm}$	0	$\sigma_{\pm} = 0$	$\frac{1}{2} \binom{2n}{n}$ $dimV_{\pm}^{0,\pm} = 1$ $dimV_{\mp}^{0,\pm} = 0$	$\frac{1}{2\sqrt{1-4z}}$

We may also present the information pictorially. In the following picture there is an irreducible representation for each cross and each point on the segment $[0, \delta]$ (with 0 doubled as \pm), and we have represented the pair (k, ω) by the complex number $k\omega$.

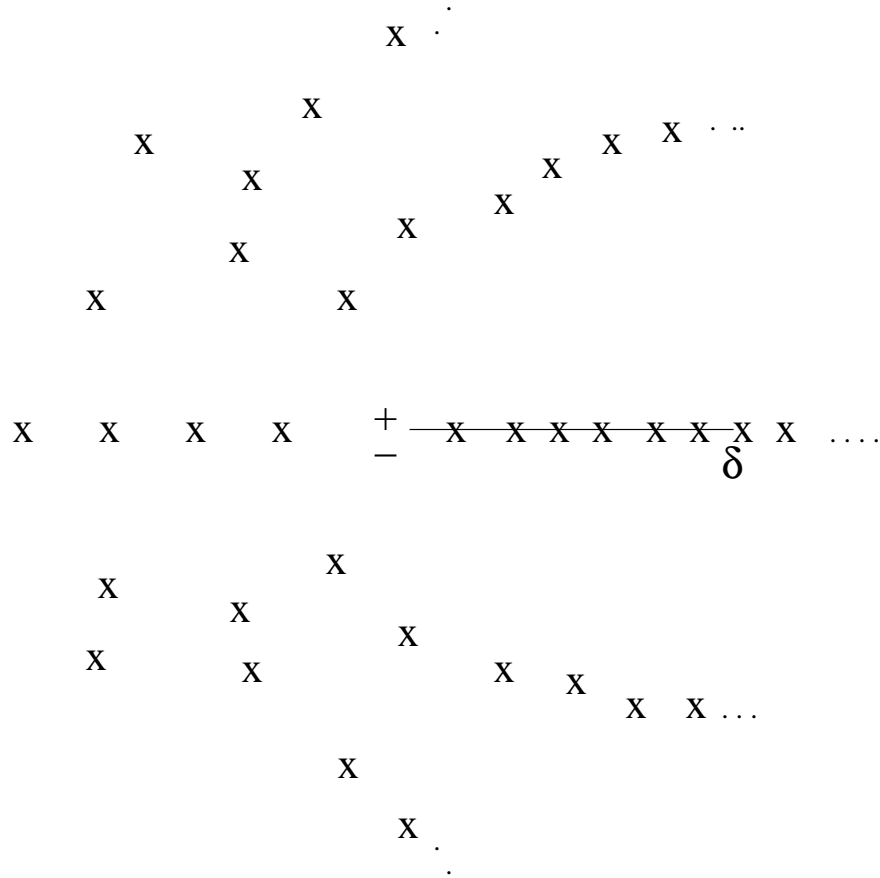

6 The Poincaré series of a planar algebra.

Definition 6.1 *If P is a planar algebra the Poincaré series of P is the dimension of the trivial P -module, i.e.*

$$\Phi_P = \frac{1}{2}(\dim P_0^+ + \dim P_0^-) + \sum_{i=1}^{\infty} \dim P_i z^i$$

The question of what power series arise as Poincaré series for planar algebras seems to be a difficult one. If a planar algebra P contains another one Q , P becomes a Q -module. In the C^* -case P will be a countable direct sum of Hilbert Q -modules so that the the Poincaré series for P will be a linear combination with non-negative integer coefficients of the dimensions of Hilbert Q -modules. This can give precise information on the Poincaré series for P .

Every planar algebra contains at least a quotient of the Temperley Lieb planar algebra so we can apply the method of the above paragraph with $Q = TL$ to obtain a formula for the Poincaré series of a spherical C^* -planar algebra with $\delta > 2$ which is particularly simple since all Hilbert TL -modules of the same lowest weight have the same dimension by corollary 5.4.

Definition 6.2 *Let P be a C^* planar algebra with spherically invariant positive definite partition function with $\delta > 2$ and $\dim(P_0^\pm) = 1$. Define a_k to be 1 for $k = 0$ and the number of copies of $V^{k,\omega}$, for all ω , in the TL -module P , for $k > 0$. Let $\Theta_P(q)$ be the generating function*

$$\Theta_P(q) = \sum_{j=0}^{\infty} a_j q^j$$

Theorem 6.3 *With hypotheses as in 6.2,*

$$\Theta_P(q) = \frac{1-q}{1+q} \Phi_P\left(\frac{q}{(1+q)^2}\right) + q.$$

Proof. By remark 3.6, as a TL -module, P consists of itself plus the sum for each k of a_k TL -modules of the same dimension. So by 5.4 we have:

$$\Phi_P(z) = \mathcal{C}(z) + \frac{\sum_{k=1}^{\infty} a_k z^k \mathcal{C}(z)^{2k}}{\sqrt{1-4z}}$$

But $z\mathcal{C}^2 = \mathcal{C} - 1$ so if $q = z\mathcal{C}^2$, $\mathcal{C} = q + 1$ and $z\mathcal{C}^2 = z(1+q)^2$ so $z = \frac{q}{(1+q)^2}$.

Finally $\mathcal{C} = 1 + q$ implies $\sqrt{1-4z} = \frac{1-q}{1+q}$ and we are done. \square

Corollary 6.4 *With hypotheses as in 6.2,*

$$\Theta_P(q) - q = 1 + \sum_{r=1}^{\infty} \left[\sum_{n=0}^r (-1)^{r-n} \frac{2r}{r+n} \binom{r+n}{r-n} \dim(P_n) \right] q^r.$$

Proof. Expanding $\frac{(1-q)q^n}{(1+q)^{2n+1}}$ by the binomial theorem we get $(1-q) \sum_{j=0}^{\infty} (-1)^j \binom{2n+j}{j} q^{j+n}$ which, using the binomial identity $\binom{a}{j} + \binom{a-1}{j-1} = \frac{a+j}{a} \binom{a}{j}$ (valid except when $a = j = 0$), equals $1 + \sum_{j=1}^{\infty} (-1)^j \frac{2n+j}{j} q^{j+n}$. But

$$\frac{1-q}{1+q} \Phi_P\left(\frac{q}{(1+q)^2}\right) = \sum_{n=0}^{\infty} \dim(P_n) \frac{(1-q)q^n}{(1+q)^{2n+1}}.$$

Summing over $r = n + j$ and n we get the answer. \square

A C^* planar algebra with spherically invariant positive definite partition function and $\dim(P_0^{\pm}) = 1$ is known to admit a "principal graph" $(\Lambda, *)$. This is a bipartite graph with a distinguished vertex $*$ such that there is a basis of P_k indexed by the walks on Λ of length $2k$ starting and ending at the distinguished vertex. Thus the Poincaré series of the planar algebra is determined by Λ . It is not true however that, if $(\Lambda, *)$ is a pointed bipartite graph and w_n is the number of loops of length $2n$ on Λ beginning and ending at $*$, that $a_r = \sum_{n=0}^r (-1)^{r-n} \frac{2r}{r+n} \binom{r+n}{r-n} w_n$ is non-negative for all $r > 1$.

The list of graphs (of norm > 2) for which any of these integers can be negative seems to be quite short. All graphs eliminated in [13] have a negative a_r when r is one plus the "critical depth". The same is true of the graphs X_n depicted below:

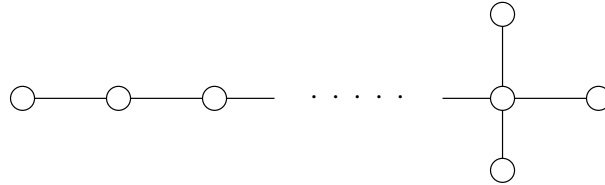

The graphs $Y_{n,2,2}$ depicted below have the property that $a_{n+1} = 1$, $a_n = 0$, but $a_{n+2} = -1$. Thus they cannot be principal graphs of subfactors. This was already proven by Haagerup in [10].

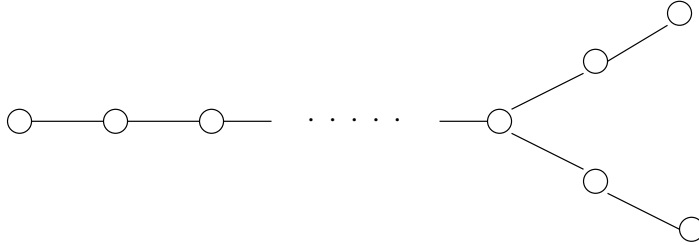

$Y_{n,2,2}$

7 The Temperley-Lieb modules, $\delta \leq 2$.

In section 8 we will give two novel constructions of the planar algebras of subfactors of index less than 4 (hence of the subfactors themselves). This will use some facts about Hilbert TL-modules for $\delta \leq 2$. In section 5 we gave a complete description of Hilbert TL-modules in the generic range. We simply showed that the inner product on certain spaces of tangles were positive definite. The situation for $\delta \leq 2$ is more complicated. The spaces of tangles $V_n^{k,\omega}$, V_n^μ and $V_n^{0,\pm}$, together with the invariant inner product, exist for all values of the parameters and have the dimensions calculated in section 5. But the inner product is not always positive definite or even positive semidefinite. In fact by proposition 5.6 a TL -module will exist iff the inner product is positive semidefinite (it is necessarily positive definite on the one-dimensional lowest weight subspace) since we may then take the quotient by the kernel of the form, which is invariant under ATL .

Definition 7.1 *Suppose the parameters are such that the inner product is positive semidefinite on $V^{k,\omega}$, V^μ or $V^{0,\pm}$. We call $\mathcal{H}^{k,\omega}$, \mathcal{H}^μ or $\mathcal{H}^{0,\pm}$ respectively the Hilbert TL module obtained by taking the quotient by the subspace of vectors of length 0. Otherwise we say that the Hilbert TL -module does not exist.*

In order to get quickly to the most original constructions of this paper we prefer to postpone the complete classification of the Hilbert TL -modules, including the values of the parameters for which they exist, to another paper. Also the construction of the D series of subfactors in index less than 4 can be easily accomplished using a period 2 automorphism of the A series (which were already constructed in [12])-see [6]. The constructions of subfactors of index equal to 4 are quite elementary. So we will limit our construction to the more difficult cases of E_6 and E_8 which were first constructed in [1] and

[11] respectively. Thus we gather together the information we will need in the following special result which admits immediate generalisation.

Theorem 7.2 *Let n be 12 or 30, let q be $e^{i\pi/n}$ and $\delta = q + q^{-1}$. Suppose $\mu > 0$ is 1 or of the form $q^a + q^{-a}$ with a and n relatively prime. Then if the Hilbert TL -modules $\mathcal{H}^{k,\omega}$ and \mathcal{H}^μ exist, the quotient maps from $V^{k,\omega}$ and V^μ are isomorphisms when restricted to the m -graded parts for $m \leq 3$ when $n = 12$ and $m \leq 5$ when $n = 30$.*

Proof. Our hypotheses imply that the inner products on $V^{k,\omega}$ and V_k^μ are positive semidefinite for the graded pieces in question. (We will show the existence of many of these Hilbert TL -modules below.)

So in the inductive arguments of the theorems of section 5 it suffices to show that the vectors ζ cannot be eigenvectors for $Ad\rho^{\frac{1}{2}}$. We will do this as before by showing that the coefficients of ξ in ζ and $Ad\rho^{-\frac{1}{2}}(\zeta)$ are different.

We begin with the case $k > 0$ and let $r + k = m$ as in 5.7. The formula relating the coefficients in this case is

$$\sin \frac{2m\pi}{n} = z_1 \sin \frac{r\pi}{n} + z_2 \sin \frac{(r+2k)\pi}{n}$$

where z_1 and z_2 are roots of unity. We need to look more closely at the nature of z_1 and z_2 . Observe that the two terms on the right hand side come from the diagrams below, where we have now been careful to fix a first boundary point on the inside annulus boundary.

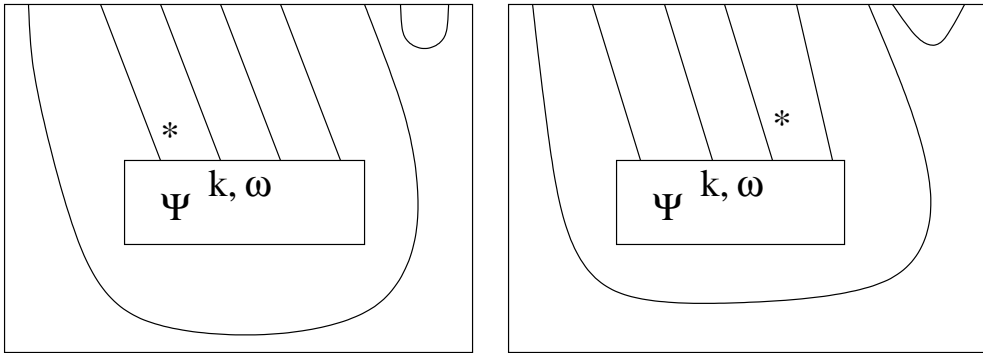

These two diagrams differ in $V_m^{k,\omega}$ by a factor of ω so the above equation can actually be rewritten (for some root of unity z)

$$(*) \quad z \sin \frac{2m\pi}{n} = \sin \frac{r\pi}{n} + \omega \sin \frac{(r+2k)\pi}{n}$$

(with perhaps some irrelevant ambiguity concerning ω and ω^{-1}).

We only need to show that formula (*) does not hold in any of the cases enumerated in the statement of the theorem. The cases $\omega = \pm 1$ (hence $k = 1, 2$) are excluded immediately by taking the absolute value and using the formula for the sine of the sum of two angles. This leaves only $n = 30$ and the cases

A) $k = 3, r = 1, 2$ and $\omega = e^{\frac{2\pi i}{3}}$

B) $k = 4, r = 1$ and $\omega = \pm i$.

Case A) is seen to be impossible in absolute value simply by drawing $\sin \frac{r\pi}{30}$ and $\omega \sin \frac{(r+2k)\pi}{30}$ in the complex plane. Taking absolute values in case B) would give $\sin^2 \frac{\pi}{3} = \sin^2 \frac{\pi}{30} + \sin^2 \frac{9\pi}{30}$ which is not true.

The reader may wonder if it is ever possible for (*) to be satisfied. If we choose $n = 12, k = 3, r = 1$ and $\omega = e^{\frac{2\pi i}{3}}$ we have the identity $e^{\frac{\pi i}{12}} \sin \frac{8\pi}{12} = \sin \frac{\pi}{12} + e^{\frac{2\pi i}{3}} \sin \frac{7\pi}{12}$. A similar identity holds for $n = 30, k = 5, r = 1$ and $\omega = e^{\frac{2\pi i}{5}}$.

We now turn to the case $k = 0$. By the same argument as in theorem 5.18 with a priori positive semidefiniteness as above we see that the form will be positive definite provided $2 \cos \frac{m\pi}{n}$ is never equal to μ for the values of m under consideration. This is obvious if n and a are relatively prime and $a \neq 1$. If $a = 1$ we are in the TL situation and the quotient map from V^δ to \mathcal{H}^δ must be an isomorphism since the inner product on the usual TL algebra is positive definite for the values of m in question (and indeed for m quite a bit larger). In the case $\mu = 1$ one simply checks that $2 \cos \frac{m\pi}{n}$ is not ± 1 . \square

8 Construction of E_6 and E_8 subfactors.

We begin by reviewing the non-existence proof for E_7 given in [13], in the language of the present paper. We want to extract information about the E_6 and E_8 cases. Let P be a C^* -planar algebra with spherically invariant positive definite partition function having principal graph $(\Lambda, *)$. Assume $*$ has only one edge connected to it. We defined the notion of "critical depth" d in [13] to be 1 plus the distance from $*$ to the first vertex of Λ of valence greater than 2. (So $d = 3, 4, 5$ for E_6, E_7 and E_8 respectively.) Decomposing the TL -module P into a sum of irreducible ones we see that P contains the the lowest weight 0 module \mathcal{H}^δ and a lowest weight d module necessarily of the form $\mathcal{H}^{d,\omega}$ for some d th. root of unity ω . Thus $\dim(P_{d+1})$ is at least as big as $\dim(TL_{d+1}) + r$ where r is the rank of the sesquilinear form on $V_{d+1}^{d,\omega}$. On the other hand by counting the number of loops starting and ending at

* on Λ we see that the dimension of P_{d+1} is precisely $\dim(TL_{d+1}) + 2d + 1$ if Λ is E_6, E_7 or E_8 . So in order for such a planar algebra to exist there must be a d th. root of unity such that the sesquilinear form on $V_{d+1}^{d,\omega}$ is degenerate, or alternatively that there is a vector $\nu \in V_{d+1}^{d,\omega}$ with $\langle \nu, \nu \rangle = 0$. It was shown in [13] that no such vector exists for E_7 so there can be no subfactor with principal graph E_7 .

However there is such a vector ν for E_6 provided $\omega = e^{\pm \frac{2\pi i}{3}}$ and for E_8 provided $\omega = e^{\pm \frac{2\pi i}{5}}$. We will use precise formulae for these null vectors ν . First some notation.

Suppose d and ω are as above and set

$$q = \begin{cases} e^{\frac{\pi i}{12}} & \text{for } E_6 \\ e^{\frac{\pi i}{30}} & \text{for } E_8 \end{cases}$$

$$\kappa = \begin{cases} e^{\mp \frac{\pi i}{12}} & \text{in the } E_6, e^{\pm \frac{2\pi i}{3}} \text{ case} \\ e^{\mp \frac{\pi i}{30}} & \text{in the } E_8, e^{\pm \frac{2\pi i}{5}} \text{ case} \end{cases}$$

$$\eta = \begin{cases} e^{\mp \frac{\pi i}{2}} & \text{in the } E_6, e^{\pm \frac{2\pi i}{3}} \text{ case} \\ e^{\mp \frac{\pi i}{3}} & \text{in the } E_8, e^{\pm \frac{2\pi i}{5}} \text{ case} \end{cases}$$

$$\delta = q + q^{-1}$$

Let $\xi = \varepsilon_2(\psi^{d,\omega})$ and $\psi = \varepsilon_3(\psi^{d,\omega})$. Let

$$\nu = \sum_{j=0}^d \eta^j \rho^j(\xi) - \kappa \sum_{j=0}^d \eta^j \rho^j(\psi)$$

Lemma 8.1 *The vector ν defined above in $V^{d,\omega}$ is nul, i.e. $\langle \nu, \nu \rangle = 0$.*

Proof. Let $v = \sum_{j=0}^d \rho^j(\xi)$ and $w = \sum_{j=0}^d \rho^j(\psi)$. Then the elements $\rho^j(\psi)$ are mutually orthogonal vectors of length $\sqrt{\delta}$ as are $\rho^j(\psi)$ so that

$$\langle v - \kappa w, v - \kappa w \rangle = 2(d+1)\delta - 2\text{Re}(\kappa \langle v, w \rangle).$$

And $\langle v, w \rangle = (d+1) \sum_{j=0}^d \langle \rho^j(\xi), \psi \rangle$. But the only terms in this sum that are not zero are the ones with $j = 0$ and $j = 1$. Thus the sum reduces to $\langle \xi, \psi \rangle + \eta \langle \rho(\xi), \psi \rangle$ and since $\psi^{d,\omega}$ is an eigenvector for ρ of eigenvalue ω , this sum is $1 + \eta\omega$. So $\langle v - \kappa w, v - \kappa w \rangle = 2(d+1)(\delta - \text{Re}(\kappa(1 + \eta\omega)))$. And with the given choices of κ, η and ω this is zero. \square

Note that we could also have deduced the above formula from the knowledge that there is a nul vector which has to be an eigenvector for $Ad\rho^{\frac{1}{2}}$, then applying the comment near the end of theorem 7.2.

We now come to the main new idea in our construction. If the planar algebra P existed one could choose an element $\xi \neq 0$ in P_d orthogonal to TL which would generate a copy of the TL module $\mathcal{H}^{d,\omega}$. We know from the above argument that ω is $e^{\pm\frac{2\pi i}{3}}$ for E_6 and $e^{\pm\frac{2\pi i}{5}}$ for E_8 . And the element ξ will then have to satisfy the relation $\nu = 0$ with ν as above. Our strategy will be to look for such an element ξ in some (not connected) planar algebra Q then use the relation $\nu = 0$ to show that the planar algebra R generated by ξ inside Q is in fact the planar algebra we want. Because of the paucity of graphs with norms less than 2 it will suffice to show that R_{\pm} is one-dimensional, i.e. any planar 0-tangle whose internal discs are all labelled by ξ is in fact a scalar multiple of the identity. The relation $\nu = 0$ goes a long way to proving that but for E_8 we will have to work somewhat harder.

The source of planar algebras Q which are to contain ξ as above will be the planar algebras of bipartite graphs constructed in [15]. In fact to obtain the E_6 planar algebra we will use the bipartite graph E_6 and similarly for E_8 . Thus our first task is to decompose the planar algebra of a bipartite graph as an orthogonal direct sum of TL -modules. Note that we showed in [15] that these planar algebras do support a spherically invariant positive definite inner product so they are Hilbert TL -modules by 3.2. We do this in each case separately. We use q and δ as above. Choose a bipartite structure $\mathcal{U}^+ \cup \mathcal{U}^-$ on E_6 as in [15]. Let P^{E_6} be the planar algebra of the bipartite graph E_6 with respect to the spin vector which is the Perron-Frobenius eigenvector $\mu = (\mu_a)$ for the adjacency matrix of E_6 normalized so that $\sum_{a \in \mathcal{U}^+} \mu_a^4 = 1$. By [15], P^{E_6} has spherically invariant positive definite partition function so it becomes a Hilbert TL -module by 3.2.

Theorem 8.2 *Let $\mu = q^5 + q^{-5}$. Then as a TL -module P^{E_6} contains the orthogonal direct sum of $\mathcal{H}^{\delta}, \mathcal{H}^{\mu}, \mathcal{H}^1, \mathcal{H}^{2,-1}, \mathcal{H}^{3,e^{\frac{2\pi i}{3}}}$ and $\mathcal{H}^{3,e^{-\frac{2\pi i}{3}}}$ (which all exist), each with multiplicity one, and no other TL -modules of lowest weight 3 or less.*

Proof. The algebras $P_{\pm}^{E_6}$ have bases of projections p_a which are the loops of length 0 starting and ending at the vertices of \mathcal{U}^{\pm} . Let Λ be the $(0,1)$ matrix whose rows are indexed by the vertices of \mathcal{U}^+ and columns are indexed by the vertices of \mathcal{U}^- with a 1 in the (i,j) position iff i is connected to j in E_6 .

According to the planar structure on P^{E_6} the matrix Λ is the matrix of the linear map $\sigma_+ : P_+^{E_6} \rightarrow P_-^{E_6}$ with respect to the orthonormal bases $\mu_a^{-2} p_a$ of $P_\pm^{E_6}$. The eigenvalues of $\Lambda^t \Lambda$ are $1, \delta^2, \mu^2$ with $\mu = q^5 + q^{-5} = \delta^{-1}$. The one dimensional subspaces spanned in $P_+^{E_6}$ by an orthonormal basis of eigenvectors for $\Lambda^t \Lambda$ are invariant under ATL_+ so by 3.5 they generate orthogonal TL -submodules $\mathcal{H}^1, \mathcal{H}^\delta$ and \mathcal{H}^μ of P^{E_6} .

The very existence of the lowest weight vectors inside a Hilbert TL -module implies immediately that the relevant irreducible Hilbert TL -module exists. This will apply to all the irreducible modules we find so we point it out here and refrain from mentioning it again in this theorem or the next.

The Bratteli diagram of P^{E_6} (for one choice of the bipartite structure) is below.

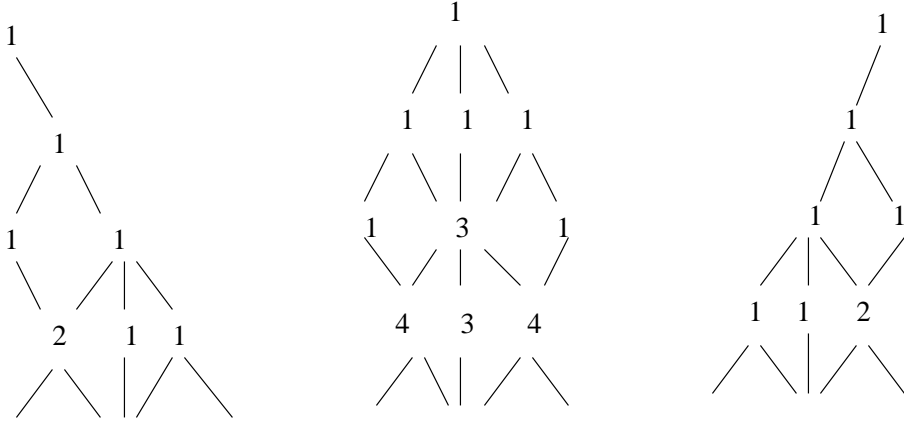

So $\dim P_\pm^{E_6} = 3$, $\dim P_1^{E_6} = 5$, $\dim P_2^{E_6} = 16$ and $\dim P_3^{E_6} = 53$. Now $\dim \mathcal{H}_1^\delta + \dim \mathcal{H}_1^\mu + \dim \mathcal{H}_1^1 = 5$ so P^{E_6} contains no submodules of lowest weight 1. But if $W = \mathcal{H}_2^\delta \oplus \mathcal{H}_2^\mu \oplus \mathcal{H}_2^1 \subseteq P_2^{E_6}$, we have $\dim W = 2 + 6 + 6 = 14$ by 7.2. So P^{E_6} contains two orthogonal TL -modules of lowest weight 2. To find out which they are we need to know the eigenvalues and multiplicities of ρ on $W^\perp \cap P_2^{E_6}$. But the representations of ρ on W and $P_2^{E_6}$ permute bases quite explicitly so we may compute eigenvalues simply by counting orbits. By inspecting tangles in Th_2 we see that ρ has two 2-element orbits and two fixed points on each of \mathcal{H}^μ and \mathcal{H}^1 . And ρ is the identity on \mathcal{H}^δ . So on W ρ has the eigenvalue 1 with multiplicity 10 and -1 with multiplicity 4.

On the other hand, ρ acts on loops on E_6 essentially by rotation. Fixed loops starting in \mathcal{U}^+ are in bijection with the edges of the graph and on other loops ρ acts freely. Thus on $P_2^{E_6}$ ρ has eigenvalue 1 with multiplicity 10 and -1 with multiplicity 5. We conclude that $\rho = -id$ on $W^\perp \cap P_2^{E_6}$ so that P^{E_6} contains the TL module $\mathcal{H}^{2,-1}$ orthogonal to $\mathcal{H}^\delta \oplus \mathcal{H}^\mu \oplus \mathcal{H}^1$ and no other modules of lowest weight 2.

We now turn to $P_3^{E_6}$ and repeat the count as above. The $W = \mathcal{H}_3^\delta \oplus \mathcal{H}_3^\mu \oplus \mathcal{H}_3^1 \oplus \mathcal{H}_3^{2,-1}$ has dimension $5 + 20 + 20 + 6 = 51$ by 7.2. And the rotation ρ , now of period 3 has, as permutations of bases, 2, 2, 2 and 0 fixed points on $\mathcal{H}_3^\delta, \mathcal{H}_3^\mu, \mathcal{H}_3^1$ and $\mathcal{H}_3^{2,-1}$ respectively. Thus ρ on W has eigenvalue 1 with multiplicity $3 + 8 + 8 + 2 = 21$ and eigenvalues $e^{\pm \frac{2\pi i}{3}}$ each with multiplicity $1 + 6 + 6 + 2 = 15$. On loops of length 6, ρ has 5 fixed points as before and 16 orbits with 3 elements. Thus on $P_3^{E_6}$ it has eigenvalues 1 with multiplicity 21 and $e^{\pm \frac{2\pi i}{3}}$ each with multiplicity 16. Hence on $W^\perp \cap P_3^{E_6}$, ρ has eigenvalues $e^{\pm \frac{2\pi i}{3}}$ each with multiplicity 1. Choosing an orthonormal basis of $W^\perp \cap P_3^{E_6}$ of eigenvectors of ρ we are done. \square

We now repeat the counting of theorem 8.2 for E_8 . So choose a bipartite structure $\mathcal{U}^+ \cup \mathcal{U}^-$ on E_8 as in [15]. Let P^{E_8} be the planar algebra of the bipartite graph E_8 with respect to the spin vector which is the Perron-Frobenius eigenvector $\mu = (\mu_a)$ for the adjacency matrix of E_8 normalized so that $\sum_{a \in \mathcal{U}^+} \mu_a^4 = 1$. By [15], P^{E_8} has spherically invariant positive definite partition function so it becomes a Hilbert TL -module by 3.2.

Theorem 8.3 *Let $\mu_1 = q^7 + q^{-7}, \mu_2 = q^{11} + q^{-11}$ and $\mu_3 = q^{13} + q^{-13}$. Then as a TL -module P^{E_8} contains the orthogonal direct sum of $\mathcal{H}^\delta, \mathcal{H}^{\mu_1}, \mathcal{H}^{\mu_2}, \mathcal{H}^{\mu_3}, \mathcal{H}^{2,-1}, \mathcal{H}^{3, e^{\frac{2\pi i}{3}}}, \mathcal{H}^{3, e^{-\frac{2\pi i}{3}}}, \mathcal{H}^{4,-1}, \mathcal{H}^{5, e^{\frac{2\pi i}{5}}}, \mathcal{H}^{5, e^{-\frac{2\pi i}{5}}}, \mathcal{H}^{5, e^{\frac{4\pi i}{5}}}$ and $\mathcal{H}^{5, e^{-\frac{4\pi i}{5}}}$, each with multiplicity one, and no other TL -modules of lowest weight 5 or less.*

To analyse the lowest weight 0 space observe that $\Lambda^t \Lambda$ is now a 4×4 matrix with $\delta^2 = (q + q^{-1})^2$ as largest eigenvalue. Now 7, 11 and 13 are all prime to 60 and $\mu_1 = q^7 + q^{-7}, \mu_2 = q^{11} + q^{-11}$ and $\mu_3 = q^{13} + q^{-13}$ are all distinct with positive real part. So the eigenvalues of $\Lambda^t \Lambda$ are δ, μ_1, μ_2 and μ_3 . Diagonalising $\sigma_- \sigma_+$ as before we see that P^{E_8} contains the orthogonal direct sum of $\mathcal{H}^\delta, \mathcal{H}^{\mu_1}, \mathcal{H}^{\mu_2}$ and \mathcal{H}^{μ_3} . The dimensions of the $\mathcal{H}_k^\delta, \mathcal{H}_k^{\mu_1}, \mathcal{H}_k^{\mu_2}$ and $\mathcal{H}_k^{\mu_3}$, for the relevant value of k , as well as the other TL -modules we will meet in this proof, are all the same as their values for generic δ by theorem 7.2.

From the Bratteli diagram for P^{E_8} or by any other means of counting loops we have $\dim P_1^{E_8} = 7, \dim P_2^{E_8} = 21, \dim P_3^{E_8} = 73, \dim P_4^{E_8} = 269$ and $\dim P_5^{E_8} = 1022$.

As in the previous case this means there are no TL -modules of lowest weight 1. The contribution of $\mathcal{H}^\delta, \mathcal{H}^{\mu_1}, \mathcal{H}^{\mu_2}$ and \mathcal{H}^{μ_3} to $\dim P_2^{E_8}$ is $2 + 6 + 6 + 6 = 20$ so P^{E_8} contains a single TL -module of lowest weight 2. Counting orbits as in 8.2 we conclude that this module is $\mathcal{H}^{2,-1}$. Thus the TL -modules of lowest weight less than 3 span a subspace W of dimension $5 + 20 + 20 + 20 + 6 = 71$ in the 73-dimensional space $P_3^{E_8}$. To find out which two irreducible

TL -modules span the orthogonal complement of W we count multiplicities of the eigenvalues of ρ (with $\rho^3 = 1$) as before. On \mathcal{H}_3^δ there are two fixed points and on each of the \mathcal{H}_3^μ there are two fixed points. On $\mathcal{H}_3^{2,-1}$ there are no fixed points. So the multiplicity of 1 is the total number of orbits is $3 + 8 + 8 + 8 + 2 = 29$ and each of $e^{\pm \frac{2\pi i}{3}}$ has multiplicity the total number of orbits of size 3 which is $1 + 6 + 6 + 6 + 2 = 21$. On loops of length 6 on E_6 there are 7 fixed points as usual and therefore each of $e^{\pm \frac{2\pi i}{3}}$ has multiplicity one on the orthogonal complement of W . Diagonalising ρ shows that P^{E_6} contains $\mathcal{H}^{3,e^{\frac{2\pi i}{3}}} \oplus \mathcal{H}^{3,e^{-\frac{2\pi i}{3}}}$.

In the case of lowest weight 4, the multiplicities are more tricky to compute because 4 is not prime. We only sketch the argument because our main results need only the existence of single TL -module of lowest weight four, which can be obtained simply via counting. Indeed the subspace $W \subseteq P_4^{E_6}$ spanned by TL -modules of lowest weight less than 4 has dimension $14 + 70 + 70 + 70 + 28 + 8 + 8 = 268$ which is one less than $\dim P_4^{E_8}$. We leave it to the reader to check that the multiplicities of $1, i, -i$ are the same on W as on loops on E_6 starting in \mathcal{U}^+ . The only subtle point is that although there are no fixed points for ρ^2 on annular $(2, 4)$ tangles there are tangles such that, in $V_4^{2,-1}$, are sent by ρ^2 to -1 times themselves.

Finally we tackle the case of lowest weight 5. The space W defined as above has dimension $42 + 252 + 252 + 252 + 120 + 45 + 45 + 10 = 1018$. But now the multiplicity count is very simple since 5 is prime and we only have to count fixed points. Here is the count on W , obtained simply by looking at tangles:

Number of fixed points for ρ ($\rho^5 = 1$)					
\mathcal{H}^δ	\mathcal{H}^μ	$\mathcal{H}^{2,-1}$	$\mathcal{H}^{e^{\pm \frac{2\pi i}{3}}}$	$\mathcal{H}^{4,-1}$	Loops on E_8
2	2 (times 3)	0	0 (times 2)	0	7
Number of orbits of order 5 for ρ ($\rho^5 = 1$)					
8	50 (times 3)	24	9 (times 2)	2	203

Thus the multiplicity of each of the primitive fifth roots of unity on W is $8 + 3 \times 50 + 24 + 9 \times 2 + 2 = 202$. So each primitive fifth root of unity occurs with multiplicity 1 in $W^\perp \cap P_5^{E_8}$ and by diagonalising ρ we are done. \square

We will need the following slight addition to the previous results which takes into account the interaction of the TL -module structure of a C^* -planar algebra with the $*$ -structure.

Proposition 8.4 *Let P be a C^* -planar algebra with spherically invariant positive definite partition function. The linear span of all irreducible TL -modules isomorphic to a given one is $*$ -invariant. In particular a TL -module*

occurring in P with multiplicity one contains a self-adjoint non-zero lowest weight vector.

Proof. The involution $*$ is a conjugate-linear isometry of P which clearly preserves the subspace W_k (of lemma 3.8) of the TL -module P . For $k > 0$, each TL -module which is the linear span of all irreducible TL -modules isomorphic to a given one, is generated by the eigenspace of ρ on the orthogonal complement of W_k . The assertion of the proposition now follows from the simple relation $\rho(x)^* = \rho^{-1}(x^*)$. \square

To give the first and simplest of our proofs of the existence of E_6 and E_8 planar algebras/subfactors, we begin by recalling the notion of biunitary from [13].

Definition 8.5 *If P is a C^* -planar algebra, a biunitary $U \in P$ is a unitary element of P_2 such that if $W = U^{-1}$ then the following two equations hold:*

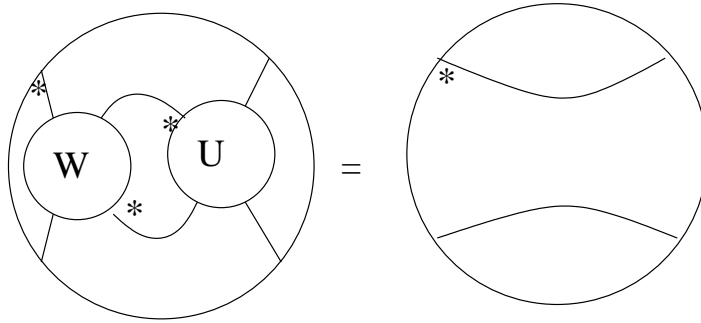

and

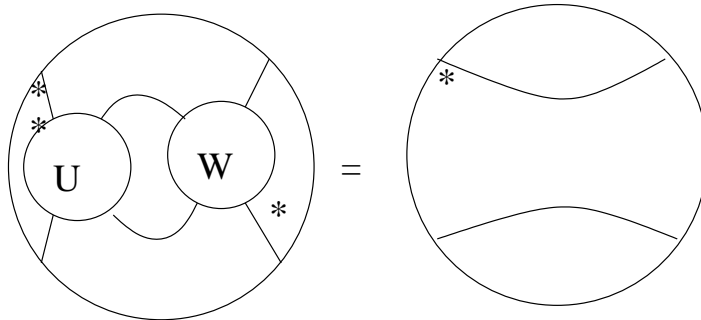

Given a biunitary U we adopt the following convention for making certain tangles in which the strings are allowed to cross into a planar tangle in the usual sense. (Note that we are using the shading to define local string orientation in this paper so that a single arrow on a string in this paper corresponds to two in [13].) Suppose T is a tangle, labelled or not, containing certain privileged strings which are *oriented* and are allowed to cross

(transversally) the other strings of the tangle but not themselves. Shade the regions of $T - \{\text{strings of } T\}$ with a shading consistent with that near the boundary discs. Then make T into a tangle by replacing the crossings by labelled discs according to the diagram below:

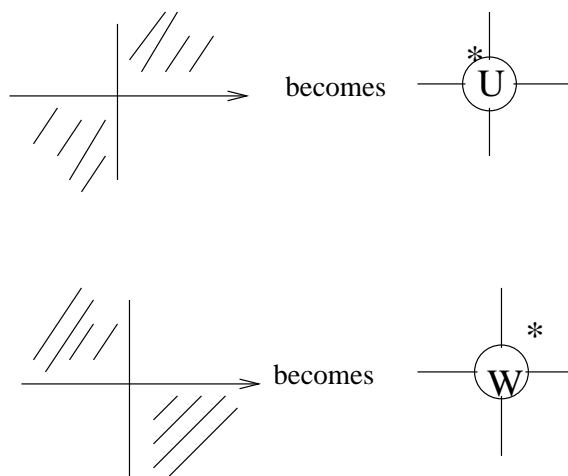

Remark 8.6 *It was observed in [13] that if one has a C^* -planar algebra P with a biunitary U then the (graded) subspace P^U of P consisting of all elements R for which there is a Q related as below forms a planar subalgebra of P .*

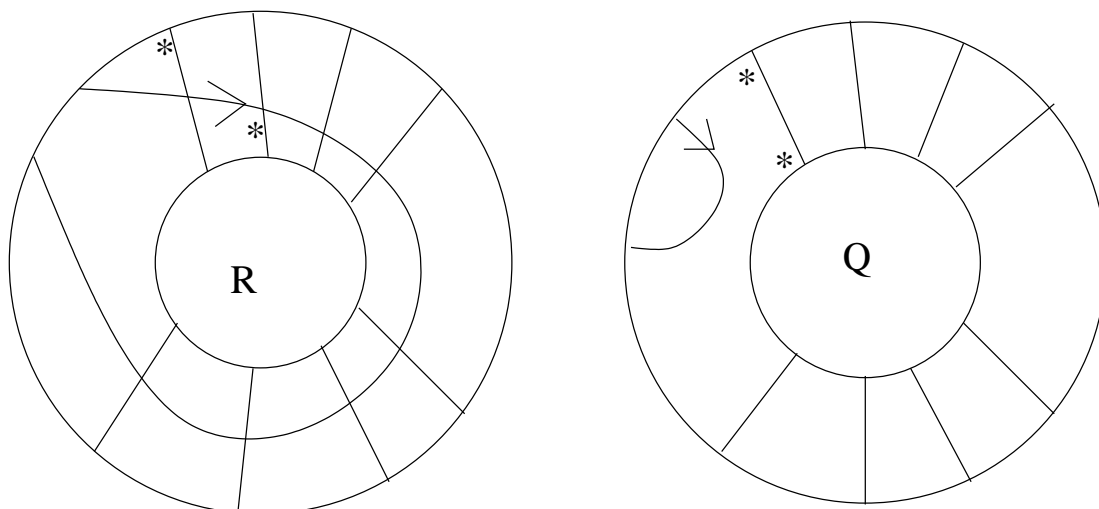

Proposition 8.7 *Consider the C^* -planar algebra TL for $0 < \delta \leq 2$ and suppose $A \in \mathbb{C}$ is such that $\delta = -A^2 - A^{-2}$. Then the element $U = AE_1 + A^{-1}id$ is a biunitary.*

Proof. Observe that A is necessarily a root of unity and the inverse of U is $Aid + A^{-1}E_1$. The conclusion follows by simple pictures. \square

Here is a picture of this U :

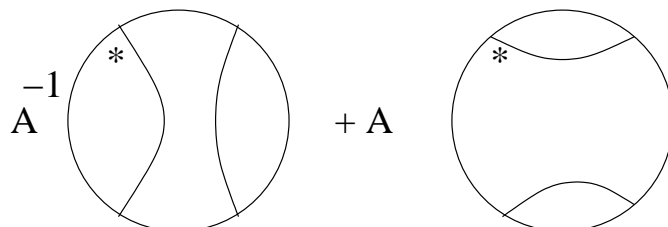

Definition 8.8 If P is a C^* -planar algebra and U a biunitary in P define, for each k the transfer matrix $T \in AP_k$ to be the annular tangle in which each internal boundary point i is connected by a string straight to external boundary point $i + 1$ and there is a single oriented string which is a homologically non-trivial circle going round the annulus in the clockwise direction. T is illustrated for $k = 4$ below. Note that for $k = 0$ the T 's are the tangles σ_{\pm} .

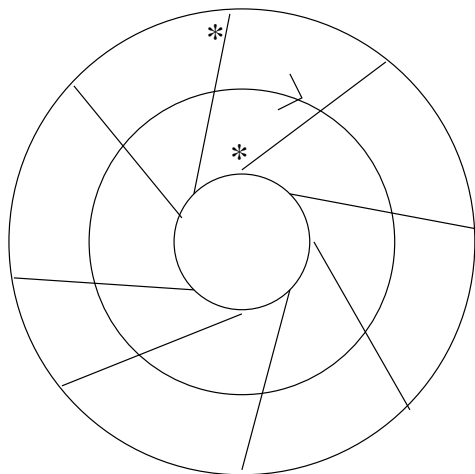

The tangle T for $k = 4$

Remark 8.9 Theorem 2.11.8 of [13] may be interpreted as saying that the P^U of remark 8.6 is the eigenspace of largest eigenvalue ($= \delta^2$) of T^*T .

Lemma 8.10 With U as in 8.7 and T as above, let $n = 12$ or 30 and $k = 3$ or 5 respectively. Let $\delta = 2 \cos \frac{\pi}{n}$ and $\omega = e^{\pm \frac{2\pi i}{k}}$. If $\psi^{k,\omega}$ is a lowest weight vector in a copy of $V^{k,\omega}$ inside a C^* -planar algebra, then

$$T(\psi^{k,\omega}) = z\psi^{k,\omega}$$

with $|z| = \delta$.

Proof. If the crossings in T are written as sums of TL elements by expanding the U 's, the fact that $\psi^{k,\omega}$ is in the kernel of all the ϵ 's means that the choice of an “ A ” or “ A^{-1} ” term at any of the crossing forces the same choice at all the other crossings. So there are only two nonzero terms in the sum, one having a coefficient of A^{2k} and the other one A^{-2k} . The two tangles giving non-zero contributions differ by a rotation so we need only check that $|A^{2k} + \omega A^{-2k}| = \delta$ which is easy. \square

Theorem 8.11 *For each of E_6 and E_8 there are up to isomorphism two non-isomorphic C^* -planar algebras P with positive definite spherically invariant partition function having the given principal graph. There is a conjugate linear isomorphism between the two.*

Proof. It is well known that the only possible position for the distinguished point on the principal graph is at maximal distance from the triple point. This follows from the correspondence with subfactors or by considering the reduction method of [13] by minimal projections corresponding to the vertices of the graph.

Note that the set of TL -modules occurring in P is an invariant and our construction will give one containing each $V^{3,e^{\pm\frac{2\pi i}{3}}}$ for E_6 and $V^{3,e^{\pm\frac{2\pi i}{5}}}$ for E_8 . They will thus be mutually non-isomorphic.

The construction is quite simple. Let P be the planar subalgebra of P^{E_6} (resp. P^{E_8}) generated by the eigenvector ψ of ρ of eigenvalue $e^{\pm\frac{2\pi i}{3}}$ (resp. $e^{\pm\frac{2\pi i}{5}}$) in $P_3^{E_6}$ (resp. $P_5^{E_8}$) which is orthogonal to all TL -submodules of smaller lowest weight. By 8.4 we may suppose that $\psi = \psi^*$ so that P is a C^* -planar algebra. By 8.9 and 8.10, any element of P is an eigenvector for T^*T . But on P_{\pm} T^*T is $\sigma_{\pm}\sigma_{\mp}$ and we have seen that the eigenvalue δ^2 has multiplicity one. Hence P is connected. This forces P to have principal graph E_6 (resp. E_8) because the only other possibilities are A and D which could not have an element orthogonal to TL in P_3 (resp. P_5).

We could avoid the use of theorem 2.11.8 of [13] by observing that the left hand side of the figure in remark 8.6 gives 7 (resp. 11) non-zero terms when U is inserted and that these terms, together with the right hand picture with $Q = \psi$ are precisely those of the null vector obtained in lemma 8.1.

Extending the identity on paths conjugate linearly to all of P^{E_6} (resp. P^{E_8}) yields the required conjugate linear isomorphism of planar algebras. \square

We would now like to give another, much longer proof of the previous result. Our reason for giving it is that it uses a method we suspect to be quite general and powerful. The idea will be to isolate certain planar relations satisfied by the generators of a planar algebra and show that labelled tangles

can be reduced using these relations to tangles where the generators appear in certain restricted configurations. In particular for tangles without boundary points we will show that all occurrences of the generator can be removed, thereby showing that the planar algebra is connected. We will carry out the argument only in the more complicated case of E_8 , leaving the E_6 case as an exercise. (In fact the D case is extremely easy in this regard as there are more relations-the corank of the matrix of inner products is actually 2.) One small bonus of this method is that the uniqueness of the planar algebra structures will be easy to see.

For the rest of the section P will denote a C^* -planar algebra with spherically invariant positive definite partition function and ψ will denote an element which is a lowest weight vector of length one for a copy of $V^{5,\omega}$ with $\omega = e^{\pm \frac{2\pi i}{5}}$ contained in P .

The idea will be to exploit as much as possible the relation of 8.1 that the vector $\nu \in V_6^{5,\omega}$ obtained from ψ is zero. Our ultimate aim is to find relations that reduce the number of occurrences of discs labelled by ψ in the planar algebra generated by ψ . The main step will be to show that if there are 2 such discs connected by 2 or more strings then they can be replaced by TL elements and a single disc. To this end we introduce the following tangles.

Definition 8.12 Let $Q_{p,q}$ and $R_{p,q}$ be the planar p -tangles with no contractible circles and 2 internal discs with $p+q$ boundary points each. The internal discs are connected to each other by q strings. The positions of the distinguished boundary regions are as indicated by the $*$'s in the picture below.

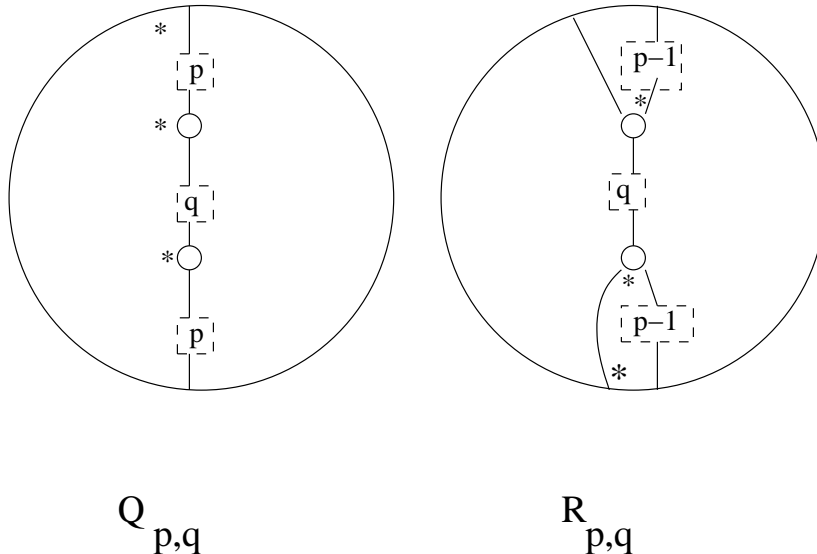

In the above pictures, as in subsequent ones, we adopt the convention that a string containing a dotted rectangle with the natural number n in it represents n close parallel copies of the string.

Note that $p + q = 10$.

The next lemma is an easy case of the arguments to follow but it needs to be treated separately. It shows that any tangle containing 2 discs labelled ψ connected by 9 strings is in fact 0.

Lemma 8.13 *The tangles $Q_{1,9}(\psi, \psi)$ and $R_{1,9}(\psi, \psi)$ obtained by labelling the 2 internal discs of $Q_{1,9}^\pm$ and $Q_{1,9}^\pm$ with ψ are proportional to a tangle with a single copy of $Q_{0,10}(\psi, \psi)$ and $R_{0,10}(\psi, \psi)$ respectively.*

Proof. We shall only carry out the argument for one position of $*$ as the other argument is structurally identical. Isotope $Q_{1,9}(\psi, \psi)$ so that it looks like the tangle below:

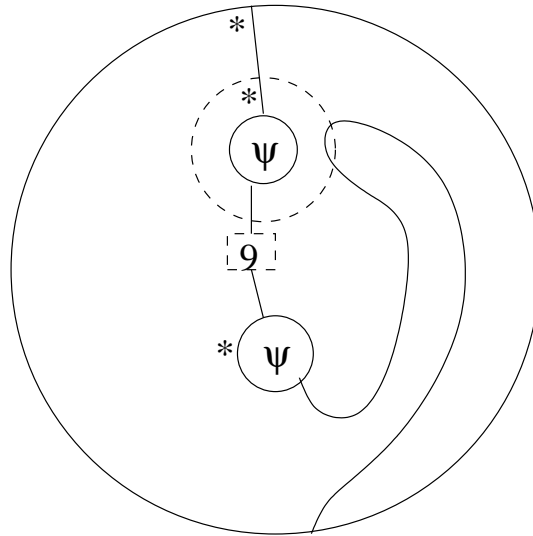

Recognize inside the dotted circle one of the terms in the expression for ν in 8.1. One may thus replace the interior of the dotted circle by the 11 other terms in ν . Nine of these terms give zero because a boundary point on the bottom ψ is connected to itself. One term is just a single curve joining the top and bottom boundary points of the outer disc with $Q_{0,10}(\psi, \psi)$ to the left of it. The other term is $-\eta^{-1}$ times the tangle below:

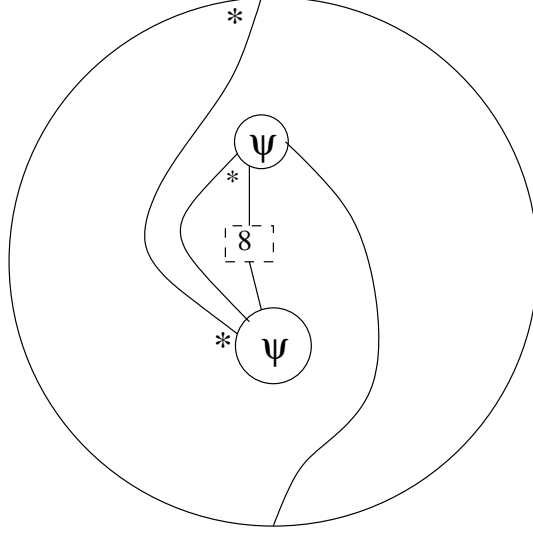

After an isotopy and using the fact that $\rho(\psi) = \omega\psi$ we find that $(1+\eta^{-1}\omega^{-1})Q_{1,9}(\psi, \psi)$ is a multiple of a tangle with a single copy of $Q_{0,10}(\psi, \psi)$.
 \square

Lemma 8.14 *The elements $Q_{0,10}(\psi, \psi)$ and $R_{0,10}(\psi, \psi)$, of P_+ and P_- respectively, are proportional to each other in P_1 with the natural embeddings of P_+ and P_- in P_1 .*

Proof. There was an asymmetry in the argument of the previous lemma. If we had worked from the left rather than the right we would have concluded that $Q_{1,9}(\psi, \psi)$ is a multiple of a 1 tangle with a single copy of $R_{0,10}(\psi, \psi)$ and no other internal discs. Thus both $Q_{0,10}(\psi, \psi)$ and $R_{0,10}(\psi, \psi)$ are in $P_+ \cap P_-$ and proportional to $Q_{1,9}(\psi, \psi)$. \square

Lemma 8.15 *Let $Q_{p,q}(\psi, \psi)$ and $R_{p,q}(\psi, \psi)$ be the elements of P_n defined by labelling both of the internal discs of $Q_{p,q}$ and $R_{p,q}$ by ψ . Then for $q = 1, 2, \dots, 8$, if p is odd*

$$Q_{p,q}(\psi, \psi) = -\omega^{-\frac{p+1}{2}} \eta^{-\frac{p+1}{2}} R_{p,q}(\psi, \psi) + X$$

and

$$R_{p,q}(\psi, \psi) = -\omega^{-\frac{p+1}{2}} \eta^{-\frac{p+1}{2}} \rho(Q_{p,q}(\psi, \psi)) + Y$$

and if p is even,

$$Q_{p,q}(\psi, \psi) = -\omega^{-\frac{p}{2}} \eta^{-\frac{p}{2}} \kappa^{-1} R_{p,q}(\psi, \psi) + Z$$

and

$$R_{p,q}(\psi, \psi) = -\omega^{-\frac{p+2}{2}} \eta^{-\frac{p+2}{2}} \kappa \rho(Q_{p,q}(\psi, \psi)) + T$$

where X, Y, Z and T are linear combinations of labelled tangles with 2 internal discs both labelled with ψ having $q + 1$ strings connecting the two internal discs. The coefficients of individual tangles in X, Y, Z and T do not depend on the particular planar algebra P .

Proof. The argument is structurally the same in all cases so we only do the case when p is odd. Isotope the tangle $Q_{p,q}(\psi, \psi)$ so that it is as below.

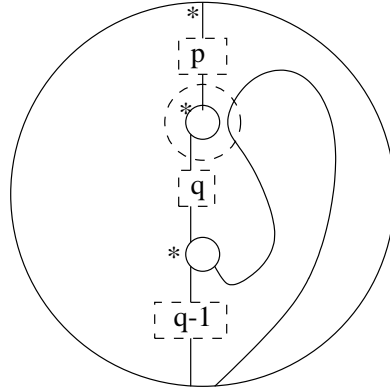

Inside the dotted circle recognise, up to the position of the $*$ of the upper internal disc, one of the terms in the formula for the nul vector ν in 8.1. Thus we may replace the inside of the dotted circle by the 11 other terms in ν with the appropriate coefficients. One of these terms gives the tangle $R_{p,q}(\psi, \psi)$ with the coefficient above and the other ones are either 0 because some string connects ψ to itself or they have $q + 1$ strings connecting the two internal discs.

Now begin with $R_{p,q}(\psi, \psi)$ and isotope it so it is as below.

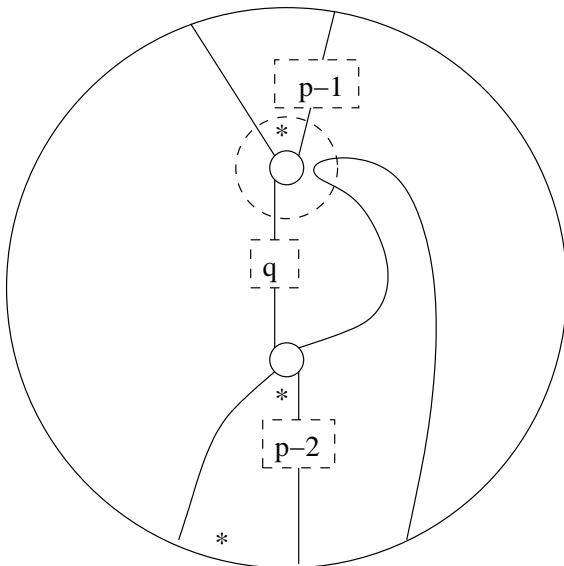

As before, after rotating the upper internal disc clockwise by $p-3$ strings one recognizes one of the terms in the formula for the nul vector ν . All but one of the other terms give 0 or have $q+1$ strings connecting the two internal discs. The one remaining term gives $-\eta^{-\frac{p+1}{2}}\rho(Q_{p,q})$ except that the position of $*$ is rotated 2 strings in an anticlockwise direction on both internal discs. This accounts for the total factor $\omega^{-\frac{p+1}{2}}$. \square

Let \mathcal{W}_p be the subspace of P_p spanned by labelled tangles (ψ being the only label) with at most 2 internal discs connected by more than $10-p$ strings. Observe that \mathcal{W}_p is invariant under the rotation.

Corollary 8.16 *With notation as above, for $1 < p < 10$*

$$\rho(Q_{p,q}(\psi, \psi)) = \omega^{p+1}\eta^{p+1}Q_{p,q}(\psi, \psi) + X$$

and

$$\rho(R_{p,q}(\psi, \psi)) = \omega^{p+1}\eta^{p+1}R_{p,q}(\psi, \psi) + X$$

where X is in \mathcal{W}_p .

Proof. Just apply the second equation of lemma 8.15 to the first, noting that tangles of the form X, Y etc. are invariant under the rotation. \square

Corollary 8.17 *With notation as above, for $p = 1, 2, 3, 4, 6, 7$ and 8 , $Q_{p,q}(\psi, \psi)$ and $R_{p,q}(\psi, \psi)$ are in \mathcal{W} .*

Proof. The case $p = 1$ is covered by lemma 8.13. For the other values of p we get that, modulo the subspace \mathcal{W} , $Q_{p,q}(\psi, \psi)$ and $R_{p,q}(\psi, \psi)$ are eigenvectors of ρ with eigenvalue $\omega^{p+1}\eta^{p+1}$. But since ρ has period p they are zero mod \mathcal{W} unless $\omega^{p+1}\eta^{p+1}$ is a p th. root of unity. \square

We will now deal with the case $p = 5$ and obtain the same conclusion as in the previous result but only by supposing that $P = P^{E_8}$ and using the dimension and multiplicity counts in this planar algebra.

Lemma 8.18 *Let P be P^{E_8} and ψ be a unit vector in $P_5^{E_8}$ generating a copy of $V^{5,\omega}$ whose existence is guaranteed by theorem 8.3. Then for $p < 5$ $Q_{p,q}(\psi, \psi)$ is in the Temperley Lieb algebra.*

Proof. Inductively apply corollary 8.17. Begin with the fact that $P_+^{E_8} \cap P_-^{E_8} = \mathbb{C}id$ to obtain the assertion for $p = 0$ by lemma 8.14. The subspace \mathcal{W} is then always contained in TL . \square

Lemma 8.19 *Let P be P^{E_8} and ψ be a unit vector in $P_5^{E_8}$ generating a copy of $V^{5,\omega}$ whose existence is guaranteed by theorem 8.3. Then*

$$Q_{5,5}(\psi, \psi) = A\psi + x$$

and

$$R_{5,5}(\psi, \psi) = B\psi + y$$

where A and B are scalars and x and y are Temperley-Lieb elements.

Proof. We will only do the argument for Q , the R case being the same.

From the general structure of a Hilbert TL -module we have the orthogonal decomposition

$$P_5^{E_8} = V_5^\delta \oplus V_{old} \oplus V_{new}$$

where V^δ are the Temperley Lieb elements, V_{old} is the linear span of Hilbert TL -modules of lowest weight less than 5 and V_{new} is the intersection of the kernels of the ϵ_i for $i = 1, 2, \dots, 10$ by corollary 3.9. Note also that V_5^δ , V_{old} and V_{new} are invariant under the ϵ_i for all i and the rotation ρ .

Write $Q_{5,5}(\psi, \psi) = x \oplus y \oplus z$ in this orthogonal decomposition. We first claim that $y = 0$. For if not there would be an i for which $\epsilon_i(y) \neq 0$. If i is different from 5 or 10, $\epsilon_i(Q_{5,5}(\psi, \psi)) = 0$ which is a contradiction. If i is 5 or 10 we apply corollary 8.16 and lemma 8.18 to obtain

$$\rho(Q_{p,q}(\psi, \psi)) = x' \oplus y \oplus z'$$

in the orthogonal decomposition. But $\rho(Q_{p,q}(\psi, \psi))$ is in the kernel of ϵ_5 and ϵ_{10} so in these cases we conclude $y = 0$ also.

It only remains to show that the z in the above decomposition is a multiple of ψ . But by 8.16, $Q_{5,5}(\psi, \psi)$ is an eigenvector of the rotation with eigenvalue ω modulo V^δ , and the multiplicity of this eigenspace is 1. \square

All that remains to prove that the planar algebra P^ψ generated by ψ in PE_8 has principal graph E_8 is to show how to reduce the number of internal discs in tangles labelled with ψ . In fact using the known restrictions on principal graphs we only need to show that $\dim P_\pm^\psi = 1$. This would follow from 8.17 8.18 and 8.19 if it was true that any 10-valent planar graph must have two vertices connected by more than one edge. And this is obvious for Euler characteristic reasons. We prefer to give a more general Euler characteristic argument which will be useful in more cases and avoids using “well known facts” about principal graphs. We will use tangles in the planar coloured operad \mathcal{P} of section 2. Such a tangle T will be called *connected* if the subset of the plane consisting of the strings of T and its internal discs is connected. Recall from [13] that a region of a tangle is a connected component of the complement of the strings and internal discs inside the external disc. A region will be called *internal* if its closure does not meet the external boundary disc of T .

Proposition 8.20 *If a connected k -tangle in \mathcal{P} has v internal discs, f internal regions and e strings, then*

$$v - e + f = 1 - 2k.$$

Proof. We follow Euler’s argument by observing that contracting an internal region to a single internal disc does not change $v - e + f$. Nor does it change the fact that the tangle is connected. When there are no more internal regions any two internal discs must be connected by a single string, the regions on both sides of which are not internal. Such a pair of discs may be combined into a single one along the string connecting them without changing $v - e + f$ or connectedness. After all such discs have been combined there is, by connectedness, a tangle which is a power of ρ . This has the desired value of $v - e + f$. \square

Corollary 8.21 *If the internal discs of a connected k -tangle all have $2p$ boundary points, then*

$$f = 1 + \frac{(p-1)e - (2p-1)k}{p}$$

Proof. If we count the boundary points on the internal discs we have counted all the strings of the tangle twice except the $2k$ strings connected to the boundary disc. Thus $2pv = 2e - 2k$. With $v - e + f = 1 - 2k$ this gives the answer. \square

Corollary 8.22 *Let T be a connected tangle satisfying the hypotheses of the preceding corollary. Suppose the boundary of every internal region of T contains at least 3 strings. Then*

$$(2p - 3)k \geq 3p + (p - 3)e.$$

Proof. Each edge which is not attached to the boundary disc, is in the boundary of at most 2 internal regions so $3f \leq 2e - 4k$. \square

Theorem 8.23 *Let P^ψ be the planar subalgebra of P^{Es} generated by ψ as above. Then for $k < 5$ P_k^ψ is equal to the Temperley-Lieb subalgebra.*

Proof. It suffices to show that any tangle containing an internal disc labelled only with ψ is a linear combination, modulo the Temperley-Lieb subalgebra, of ones with less internal discs labelled only with ψ . By induction we may suppose the tangle is connected. But if the tangle contains any internal discs labelled by ψ , e is at least 10 so by 8.22 with $p = 5$ there has to be an internal region with only two strings in its boundary. By 8.19 and 8.17 we are through. \square

Theorem 8.24 *For each $\omega = e^{\pm \frac{2\pi i}{5}}$ there is a unique C^* -planar algebra P (with positive definite spherically invariant partition function) up to planar algebra isomorphism with $\delta = 2 \cos \frac{\pi}{30}$ and $\dim P_5 = 43$, with ρ having eigenvalue ω on the orthogonal complement of the Temperley-Lieb subalgebra of P_5 .*

Proof. By proposition 8.4 we may choose the unit vector ψ to be self-adjoint in theorem 8.23, which means that P^ψ is a C^* -planar algebra. The dimension of P_5 is at least 43 since the dimension of the Temperley-Lieb subalgebra is 42 and ψ is orthogonal to it. But by any 5-tangle all of whose internal discs have 10 boundary points and having more than one internal disc must have at least 18 strings so by 8.22 there have to be 2 discs connected by more than one string. By 8.17, if all internal discs are labelled ψ , the number of strings connecting the 2 discs can be increased to 5 modulo terms with less internal discs. Then by 8.19 the total number of internal discs can be decreased. Thus any 5-tangle labelled only by ψ is a linear combination of TL -elements and ψ itself, and $\dim P_5 = 43$.

Now let P satisfy the conditions of the theorem. Choose an element $\psi \in P_5$ orthogonal to the Temperley Lieb subalgebra with $\rho(\psi) = \omega\psi$ and $\psi = \psi^*$ (by 8.4). The principal graph of P can only be E_8 and the same is true for the planar subalgebra of P generated by ψ so these two planar algebras have the same dimension and thus are equal. Since the partition function is positive

definite all the structure constants of the planar algebra are determined by knowledge of the partition functions of planar 0-tangles with all internal discs labelled by ψ . These partition functions may be computed by reducing the number of internal discs to zero. Any such reduction that only used the relations of 8.15 involve coefficients that are determined entirely by the coefficients of ν in 8.1. Thus the only possible ambiguity in the partition function comes from reduction of the tangles $Q_{5,5}(\psi, \psi)$ and $R_{5,5}(\psi, \psi)$ as linear combinations of TL elements and ψ . In fact only the Q case needs to be considered since, as might have been observed in 8.15, for p odd, $Q_{5,5}(\psi, \psi)$ may be rotated to become $R_{5,5}(\psi, \psi)$.

Observe that $Q_{5,5}(\psi, \psi) = \psi^2$ so a priori we need to determine 43 unknown coefficients in the expression $\psi^2 = A\psi + \theta$ where θ is in the Temperley Lieb subalgebra of P_5 . But note that both ψ and ψ^2 are zero when multiplied on the left or right by the elements E_i for $i = 1, 2, 3, 4$ so by fact 4.5, θ is necessarily a multiple of the p_5 of 4.4 and $\psi^2 = A\psi + Bp_5$. So the whole planar algebra structure is determined by the real numbers A and B . Also $p_5\psi = \psi p_5 = \psi$ because the only basis summand in p_5 which gives a non-zero product with ψ is the identity. So p_5 and ψ linearly span a 2-dimensional C^* -algebra \mathcal{A} of which p_5 is the identity. We know that the principal graph of P is E_8 and the partition function, appropriately normalised, defines the Markov trace on P . The weights of the trace can be found in [7]. Call the minimal projections in \mathcal{A} q_1 and q_2 . Then they are minimal central projections in P_5 so their traces τ_1 and τ_2 can be read off from [7]. Suppose $\psi = xq_1 + yq_2$ for some (real) x and y . Since $q_1 + q_2 = p_5$ the numbers A and B are determined by x and y . But $\psi^2 = x^2q_1 + y^2q_2$ and ψ is a unit vector of trace zero so taking the trace of these two equations we get

$$x\tau_1 + y\tau_2 = 0$$

and

$$x^2\tau_1 + y^2\tau_2 = 1.$$

So x^2 is determined which gives x up to a sign. On the other hand the vector ψ was always ambiguous up to a sign. So the arbitrary choice $x > 0$ could be imposed from the start and the partition function is completely determined.

□

We include in appendix B some observations concerning the presentation of E_6 and E_8 as planar algebras.

A Appendix: The rotation by one.

One of the features of the annular Temperley Lieb diagrams that is absent in the disc case is that there are diagrams which do not preserve a shading imposed on the boundary regions. The most obvious such tangle is the rotation by one in which all strings are through and the i internal boundary point is connected to the $i + 1$ th. external one. This is not an honest tangle according to our definition because in definition 2.1 we used elements from the planar operad of [13] where we insisted that planar tangles have a coherent shading. We explained our reasons for this restriction in the introduction to [13]. But it remains natural to eliminate the shading condition and define an extended notion of planar algebra in which the shading condition, and the requirement that the numbers of boundary points be even, would disappear. Indeed in the paper of Graham and Lehrer the annular TL diagrams have no restrictions except planarity. And in fact consideration of the rotation by one causes a major technical simplification in our proof of positive definiteness in 5.7. But rather than extend the whole formalism we shall allow non-shadable TL diagrams to act on algebra elements, and hence on the modules $V_m^{k,\omega}$ by making sure there are unshadable elements acting both on the inside and the outside.

We begin with the setup when there are boundary points on the inside and outside of the annuli. So let m be an integer > 0 .

Definition A.1 *Define the annular diagram $\rho^{\frac{1}{2}}$ to consist of an annulus with $2m$ internal and $2m$ external distinguished boundary points as usual with the i th. internal point connected by a string to the $(i + 1)$ th. external one so that the strings do not cross. The diagram is considered up to isotopy as usual.*

It makes sense to compose any annular tangle with $\rho^{\frac{1}{2}}$ on the inside or the outside provided the number of boundary points match up but one will obtain a diagram that is outside ATL . But if the diagram is composed both on the inside and the outside by an odd power of $\rho^{\frac{1}{2}}$ the result will be in ATL .

Definition A.2 *If T is a tangle in $AnnTL(m, n)$ we define $Ad\rho^{\frac{1}{2}} : AnnTL(m, n) \rightarrow AnnTL(m, n)$ by $Ad\rho^{\frac{1}{2}}(T) = \rho^{\frac{1}{2}}T(\rho^{\frac{1}{2}})^{-1}$.*

Proposition A.3 *$Ad\rho^{\frac{1}{2}}$ is an algebroid automorphism which is the identity on $ATL(m, m)$.*

Proof. Clearly $\rho^{\frac{1}{2}}$ is a square root of ρ and ρ generates $ATL(m, m)$. \square

Proposition A.4 $Ad\rho^{\frac{1}{2}}$ defines an isometry of $\widetilde{ATL}_{m,k}$ which commutes with the action of $\mathbb{Z}/k\mathbb{Z}$.

Proof. Applying $Ad\rho^{\frac{1}{2}}$ to a tangle does not change the number of through strings so $Ad\rho^{\frac{1}{2}}$ acts on the quotient $\widetilde{ATL}_{m,k}$. \square

Corollary A.5 $Ad\rho^{\frac{1}{2}}$ defines an isometry of $V_m^{k,\omega}$ sending an element $T(\psi_k^\omega)$ to $Ad\rho^{\frac{1}{2}}(T)(\psi_k^\omega)$.

Remark A.6 The period of $Ad\rho^{\frac{1}{2}}$ on $ATL(m,n)$ is at most $LCM(2m, 2n)$.

We have also used the rotation by one on the modules V_k^μ .

Definition A.7 Define $Ad\rho^{\frac{1}{2}} : V_k^\mu \rightarrow V_k^\mu$ on the basis Th_k by

$$Ad\rho^{\frac{1}{2}}(T) = \mu^{-1}\rho^{\frac{1}{2}}T\sigma_\pm.$$

Proposition A.8 $Ad\rho^{\frac{1}{2}}$ is an isometry of period at most $2k$.

Proof. The $(0,0)$ -tangle used to calculate $\langle Ad\rho^{\frac{1}{2}}(S), Ad\rho^{\frac{1}{2}}(T) \rangle$ has the same number of contractible circles as the tangle for $\langle S, T \rangle$ but 2 more non-contractible ones. The factors μ^{-1} compensate to give an isometry. \square

Note that there is no rotation by one on $V_k^{0,\pm}$.

B Appendix: Towards a skein theory for E_6 and E_8 .

Planar algebras provide a framework for knot-theoretic skein theory. In the approach pioneered and named by Conway ([5]), a tangle is much the same as we have defined except that all the internal discs have four boundary points and are labelled by under or over crossings. For the Alexander-Conway and HOMFLY polynomials the strings of a tangle are oriented and the sense of a crossing is relative to this orientation. For the Kauffman bracket and Kauffman two-variable polynomials there is no orientation but a shading may be used to give sense to the over and under crossings. (In [13] we showed how to handle the HOMFLY polynomial in an orientation-free manner using labels that contain triple rather than double points in a knot projection so that all internal discs are labelled with triple points-one may then orient the strings

as the boundaries of oriented shaded regions.) The relevant planar algebra is in all cases the quotient of the free planar algebra linearly spanned by all tangles, by relations given by three dimensional isotopy (or sometimes the more restrictive "regular" isotopy) and certain "skein relations", the first of which was the relation for the Alexander-Conway polynomial in [5]. Skein relations are interesting if they cause major collapse of the free planar algebra, especially if the quotient is non-zero but finite dimensional. In the examples discussed above the skein relations collapse tangles with no boundary points (i.e. link projections) to a one dimensional space and one thus obtains topological link invariants. In [13] we promoted the point of view that the Reidemeister moves allow three dimensional isotopy to be thought of as skein relations and we began to investigate planar algebras with more general Reidemeister-type relations, especially in work with Bisch-see [2] and [3]. One should think of *any* planar algebra as a generalised skein theory where the crossings are replaced by some family of generators. Of course these "crossings" no longer necessarily label discs with 4 boundary points. Skein relations will then be linear combinations of tangles labelled by the generators. A collection of skein relations will be considered more or less interesting according to the level of collapse they cause of the free planar algebra. Probably any set of skein relations causing collapse to finite dimensions (but not to zero) should be considered interesting. A point of view very close to this one has already been vigorously pursued in a slightly different formalism by G. Kuperberg who has obtained some of the most beautiful skein theories beyond the HOMFLY and Kauffman ones - see [18].

A highly desirable level of skein-theoretic understanding of a planar algebra P is to have a list of labelled k -tangles which form a basis of P_k , and a set of skein relations which allow an algorithmic reduction of any labelled tangle to a linear combination of basis ones. The list of tangles should be natural in some sense. Having a minimal number of internal discs is probably a useful requirement for basis tangles. In the HOMFLY case such a basis is indexed by permutations of a set of k points and the reduction algorithm is essentially that used in the Hecke algebra of type A_n . In the Kauffman (or BMW) case the basis is indexed by all partitions of a set of $2k$ points into subsets of size 2 and the reduction algorithm is essentially that used to calculate the Kauffman polynomial. Kuperberg has obtained a beautiful unified skein theory for knot invariants obtained from rank 2 Lie algebras.

One may obtain skein-theoretic control of a planar algebra with somewhat less than the knowledge of the previous paragraph. If we are dealing with a C^* -algebra with positive definite partition function then it suffices, in principle, to know an algorithm to compute the partition function of 0-tangles labelled with generators and their stars. For then to see if a linear combi-

nation x of labelled tangles is zero one can simply apply the algorithm to each term in x^*x and take the sum. This may be an acceptable situation but it is not ideal. For instance if we look at the Temperley-Lieb algebra when δ is $2 \cos \frac{\pi}{n}$, the partition function can be computed with the usual formula but we know that the C^* -planar algebra is obtained by taking the quotient by the relation that $p_n = 0$. Explicit knowledge of p_n has proved crucial in further developments of the theory, particularly applications to invariants of three-dimensional manifolds.

We would like to have such a theory for the C^* -planar algebras with principal graphs E_6 and E_8 and our diagrammatic proof of the existence of these planar algebras represents a step in that direction. The planar algebras are singly generated by the elements ψ which are almost uniquely defined by the relations saying that ψ is a lowest weight vector for a specific TL -module, which may be considered as skein relations. The all-important relation of 8.1 is then a further skein relation. Let us call that relation "nul". Nul was almost sufficient to provide an algorithm for reducing planar 0-tangles to scalar multiples of the identity by immediately reducing the number of internal labelled discs if there is a pair of such discs connected by a string. In fact this did not quite work in two ways: first, we were forced to use knowledge of a ψ occurring in a particular planar algebra, and second, we were unable to simplify directly a tangle with two internal discs connected by a single string. However, at the end of the day it did turn out, in the case of E_8 that the following relations on ψ are sufficient to algorithmically calculate the partition function of a labelled 0-tangle, where all constants are as in 8.1 and theorem 8.24:

- a) $\psi \in \ker(\epsilon_1) \cap \ker(\epsilon_2)$
- b) $\psi^* = \psi$ and $\langle \psi, \psi \rangle = 1$
- c) $\rho(\psi) = \omega\psi$
- d) $\sum_{j=0}^d \eta^j \rho^j(\epsilon_2(\psi)) = \kappa \sum_{j=0}^d \eta^j \rho^j(\epsilon_3(\psi))$
- e) $\psi^2 = A\psi + Bp_5$

Thus the above relations can be thought of as a presentation of the E_8 planar algebra in a C^* sense.

We hope we have motivated two further problems.

- (i) For each k find a list of k -tangles labelled by ψ which give a basis for P_k .
- (ii) Find a finite set of skein relations giving an algorithm for reduction of a given tangle to one in the list of (i).

We are a long way from solving problem (i) but we would like to point

out in this regard a way in which E_8 is significantly more complicated than E_6 . We had to work quite hard to obtain relations for E_8 which sufficed to calculate the partition function of 0 – tangles. It would have been trivial if we could have shown that the tangle $Q_{9,1}(\psi, \psi)$ was in fact in the linear span of tangles with at most one internal disc labelled ψ . Nothing we have shown disallows this possibility but we will see that it is not true, although the corresponding statement for E_6 is correct. (So a basis of tangles for E_6 exists with no strings connecting the internal labelled discs.) We will prove these assertions by a counting argument which will require a little more knowledge of dimensions of TL -modules on the one hand and a little more skein theoretic arguments on the other. We begin with the TL -module formulae. Recall from the proof of theorem that the annular Temperley Lieb algebra ATL_k contains two copies TL_{2k}^a and TL_{2k}^b of the ordinary Temperley Lieb algebra TL_{2k} as in theorem 5.7.

Theorem B.1 *Suppose that $\mathcal{H}^{k,\omega}$ is an irreducible Hilbert TL -module of lowest weight k and that $\dim \mathcal{H}_m^{k,\omega} = \binom{2m}{m-k} - 1$. Then for $n \geq m$, as a TL_{2n}^a and a TL_{2n}^b module $\mathcal{H}_n^{k,\omega}$ is a direct sum of irreducible TL_{2n} -modules V_{2n}^j for $j = 2k, 2k + 2, \dots, 2m - 2$.*

Proof. The result will follow from fact 4.11 and the following assertion: "If $\mathcal{H}_n^{k,\omega}$ contains neither the trivial representation of TL_{2n}^a nor that of TL_{2n}^b then $\mathcal{H}_{n+1}^{k,\omega}$ contains neither the trivial representation of TL_{2n+2}^a nor that of TL_{2n+2}^b ."

This assertion is not difficult. To say that a vector γ is in the trivial representation of TL_{2n+2}^a is to say that $F_i(\gamma) = 0$, and hence $\epsilon_i(\gamma) = 0$, for $i = 1, 2, \dots, 2n + 1$. Moreover $\epsilon_{2n+2}(\gamma) = 0$ since some power of ρ applied to it is in the trivial representation of TL_{2n}^b . Thus such a γ would be in $\bigcap_{i=1, \dots, 2n+2} \ker(\epsilon_i)$ and thus zero since $\mathcal{H}^{k,\omega}$ is irreducible (see 3.9).

Now let m_0 be the smallest integer for which $\mathcal{H}_{m_0}^{k,\omega}$ has dimension less than the generic value. Then for $n > m_0$ the same is true by fact 4.11 and the reduction procedure of theorem 5.7. Thus $m = m_0$ and $\mathcal{H}_m^{k,\omega}$ contains neither the trivial representation of TL_{2m}^a nor that of TL_{2m}^b by a dimension count. Thus for $n \geq m$ the reduction process to previous TL^a algebras shows that the only TL^a modules allowed are those listed, and that they all occur. \square

Note that in the above theorem $\delta < 2$ so the V_{2n}^j do not necessarily have their generic dimensions.

We can now prove the assertions made above about minimal tangles for the E_6 and E_8 planar algebras.

Theorem B.2 *The planar algebra P of E_6 is linearly spanned by tangles labelled by a single element in which no two labelled internal discs are connected by a string.*

Proof. Just as for E_8 it is clear that P is generated as a planar algebra by a lowest weight vector ψ for the TL -module $V^{3,\omega}$ so the theorem will follow from the assertion that $Q_{5,1}(\psi, \psi)$ (see 8.12) is in the TL -module generated by ψ . But to see this we need only show that $\dim(\mathcal{H}_5^{3,\omega}) + \dim(\mathcal{H}_5^\delta) = \dim(P_5)$. But since the Coxeter number of E_6 is 12, all ordinary irreducible Temperley-Lieb representations occurring have their generic values. In particular $\dim(\mathcal{H}_5^\delta) = 42$ and by theorem B.1 $\dim(\mathcal{H}_5^{3,\omega}) = \binom{10}{2} - \binom{10}{1} = 35$. And the dimension of P_6 is 77. \square

Theorem B.3 *For E_8 , with notation as in 8.18, $Q_{9,1}(\psi, \psi)$ is not in the linear span of the TL -submodules \mathcal{H}^δ and $\mathcal{H}^{5,\omega}$.*

Proof. We know that ψ generates a planar algebra P with principal graph E_8 . The Coxeter number of E_8 being 30, all ordinary Temperley-Lieb representations occurring have their generic values so $\dim(\mathcal{H}_9^\delta) = 4862$ and $\dim(\mathcal{H}_9^{5,\omega}) = 2244$ by B.1.

Thus there is a tangle with at least 2 internal discs, labelled ψ which is not in the linear span of \mathcal{H}_9^δ and $\mathcal{H}_9^{5,\omega}$. In fact $Q_{9,1}(\psi, \psi)$ must be such a tangle since otherwise any tangle with a string connecting two internal discs labelled ψ could be written as a linear combination of such tangles without strings connecting internal discs labelled ψ , and any 9-tangle of this form is in $\mathcal{H}_9^{5,\omega}$ or \mathcal{H}_9^δ . \square

So, unlike E_6 , the planar algebra of E_8 does not admit a basis of labelled tangles with no strings connecting internal discs.

References

- [1] J.Bion-Nadal, *Subfactor of the hyperfinite II_1 factor with Coxeter graph E_6 as invariant*. J. Operator Theory **28**,(1992),27-50.
- [2] D. Bisch and V.F.R. Jones, *Singly generated planar algebras of small dimension*, Duke Math. Journal **101**,(2000), 41–75
- [3] D.Bisch and V. Jones *Algebras associated to intermediate subfactors*. Inventiones Math. **128**,(1997), 89-157.

- [4] O.Bratteli *Inductive limits of finite dimensional C^* -algebras*. Transactions AMS **171**, (1972), 195–234.
- [5] J.H. Conway *An enumeration of knots and links, and some of their algebraic properties*. Computational Problems in Abstract Algebra (Proc. Conf., Oxford, 1967) (1970) 329–358
- [6] D.Evans and Y.Kawahigashi *Quantum symmetries on operator algebras* Clarendon Press, Oxford (1998).
- [7] F.M. Goodman, P. de la Harpe, and V.F.R. Jones, *Coxeter graphs and towers of algebras*, Springer-Verlag, 1989.
- [8] R.Graham, D.Knuth and O. Patashnik *Concrete Mathematics*(second edition), Addison Wesley, (1994).
- [9] J.J. Graham and G.I. Lehrer, *The representation theory of affine Temperley Lieb algebras*, L'Enseignement Mathématique **44**(1998),1–44.
- [10] U. Haagerup *Principal graphs of subfactors in the index range $4 < [M : N] < 3 + \sqrt{2}$* in: "Subfactors", World Scientific, Singapore-New Jersey-London-Hong Kong (1994) 1–39.
- [11] M. Izumi *On flatness of the Coxeter graph E_8 .*, Pacific Math. Journal **166**,(1994),305-327.
- [12] V.F.R. Jones, *Index for subfactors*, Invent. Math **72** (1983), 1–25.
- [13] , *Planar Algebras, I*, NZ Journal Math, to appear.
- [14] , *A quotient of the affine Hecke algebra in the Brauer algebra.*, L'Enseignement Mathématique **40**(1994),313-344.
- [15] .*The planar algebra of a bipartite graph*. In *Knots in Hellas '98* World Scientific, (2000), 94–117.
- [16] V.F.R. Jones and V.S.Sunder, *Introduction to Subfactors* LMS lecture note series **234**(1997)
- [17] L.Kauffman, *State models and the Jones polynomial*. Topology **26**,(1987),395-407.
- [18] G. Kuperberg *Spiders for rank 2 Lie algebras*, Commun. Math. Phys. **180**(1996),109–151.

- [19] J.P. May *Definitions: operads, algebras and modules*, Contemporary Mathematics **202**(1997),1–7.
- [20] A.Ocneanu *Quantized group, string algebras and Galois theory for algebras* in **Operator algebras and applications, vol. 2** L.M.S lecture note series, **136**, (1987), 119–172.
- [21] S.Popa, *An axiomatization of the lattice of higher relative commutants*, Invent. Math **120**(1995),427–445.