

Matching and Digital Control Implementation for Underactuated Systems

F. Andreev[†], D. Auckly[‡], L. Kapitanski[‡], A. G. Kelkar[§], and W. N. White[§]
 Kansas State University
 Manhattan, KS 66506

Abstract

This note describes two problems related to the digital implementation of control laws in the infinite dimensional family of matching control laws, namely state estimation and sampled data induced error. The entire family of control laws is written for an inverted pendulum cart. Numerical simulations which include sampled data and a state estimator are presented for one of the control laws in this family.

1 Introduction

Several papers have been written recently regarding the control of nonlinear underactuated systems [1]-[8]. Recall that an underactuated system, is a system with fewer control inputs than degrees of freedom. The idea that one should look for control laws such that the closed loop system takes a particular form is common to all of these papers. The particular form of the final equations is chosen so that there will be a natural candidate for a Lyapunov function. If the Lyapunov function attains a local minimum at an isolated point, then this point is a locally asymptotically stable equilibrium of the continuous system.

Digital implementation of continuous control laws introduces additional difficulties. It is not *a priori* clear that a method which produces good results in the continuous case with full state feedback will continue to produce acceptable results with state estimation and sampled data. For a digitally controlled system, the data is collected and the control input is calculated at discrete moments of time. In addition, the full state cannot be directly measured and must be estimated based on observable data. Assume the continuous closed-loop system is modelled by

$$\dot{x} = f(x, u(x)), \quad (1)$$

[†]Dept. of Mathematics, Visiting from Steklov Inst. of Math., St. Petersburg, Russia

[‡]Dept. of Mathematics

[§]Department of Mechanical and Nuclear Engineering.

This work was partially supported by NSF Grant No. CMS-9813182.

where u is a full state feedback control law. Let τ be the sample time, let $x_k = x(\tau k)$, let $y_k = C(x_k)$ be the observable data, and let \underline{x}_k be the estimated state at time τk . A model of a corresponding digitally controlled system is

$$\begin{aligned} \dot{x}(t) &= f(x(t), u(\underline{x}(t))), \\ \underline{x}(t) &= \underline{x}_k, \quad \text{for } \tau k \leq t < \tau(k+1), \\ \underline{x}_{k+1} &= g(y_k, \underline{x}_k), \end{aligned} \quad (2)$$

where g is the state estimator. In practice, it is not system 1, but rather system (2), which must have an asymptotically stable equilibrium. There is a lower bound on the sampling time, τ , dictated by the control apparatus. There is an upper bound on τ depending upon the state estimator and the control law.

For a simple linear system corresponding to $f(x, u) = Ax + Bu(x)$, $y = Cx$, conditions to make (2) asymptotically stable are well known. For the continuous closed-loop system to be asymptotically stable, there must exist a matrix, G so that the eigenvalues of $A - GC$ all lie in the left half plane, and τ must be sufficiently small.

For nonlinear systems, the situation is more complicated. One case, however, is easy to understand. Consider a nonlinear closed-loop system $\dot{x} = f(x, u(x))$ whose linearization, $\dot{x} = Ax + Bu(x)$, at the equilibrium $x = 0$ is asymptotically stable such that there exists a matrix G so that all eigenvalues of $A - GC$ lie in the left half plane. In this case, the continuous system

$$\begin{aligned} \dot{x} &= f(x, u(\underline{x})) \\ \dot{\underline{x}} &= f(\underline{x}, u(\underline{x})) + GC(x - \underline{x}) \end{aligned}$$

will be locally asymptotically stable. In fact any system with correct linearization will do. For digital control, one may choose, for example, the following system

$$\begin{aligned} \dot{x} &= f(x, u(\underline{x})) \\ \underline{x}(t) &= \underline{x}_k, \quad \text{for } \tau k \leq t < \tau(k+1), \\ \underline{x}_{k+1} &= A_d \underline{x}_k + B_d u \underline{x}_k + G_d C(x_k - \underline{x}_k), \end{aligned} \quad (3)$$

where $A_d = \exp(\tau A)$, $B_d = \int_0^\tau \exp(-sA) ds B$ and G_d is chosen such that $\text{spec}(A_d - G_d C) = \exp(\tau \text{spec}(A - GC))$. If the sampling time, τ , is sufficiently small, then the system (3) will be locally asymptotically stable.

2 The Control Law

In this section, we briefly recall a method for constructing an infinite dimensional family of controls laws for many nonlinear systems. We will then use the method to derive a specific control law for an inverted pendulum cart system. The implementation of this control law including a sample time and a state estimator will be discussed in the final section of this paper.

Let Q denote a configuration space. Let $g \in \Gamma(T^*Q \otimes T^*Q)$ be a metric. Let $c, f : TQ \rightarrow TQ$ be fiber-preserving maps. We assume that $c(-X) = -c(X)$. Let $V : Q \rightarrow \mathbf{R}$. The system that we consider is

$$\nabla_{\dot{\gamma}} \dot{\gamma} + c(\dot{\gamma}) + \text{grad}_{\gamma} V = f(\dot{\gamma}).$$

Let $P \in \Gamma(T^*Q \otimes TQ)$ be a g -orthogonal projection. We consider the situation where a constraint $P(f) = 0$ is imposed. A system is called underactuated if $P \neq 0$. In order to describe the final control law, we will use several other variables. The variable $\hat{g} \in \Gamma(T^*Q \otimes T^*Q)$ will be a metric, $\hat{c} : TQ \rightarrow TQ$ will be a fiber-preserving map, \hat{V} will be a real-valued function, and $\lambda \in \Gamma(T^*Q \otimes TQ)$ will be a g -self adjoint map. One first solves the equations

$$\nabla g \lambda|_{\text{Im } P \otimes 2} = 0,$$

for $\lambda|_{\text{Im } P}$. Then one solves

$$L_{\lambda P X} \hat{g} = L_{P X} g$$

(this is a slight rewrite of equation (1.12) of our previous paper [1]),

$$L_{\lambda P X} \hat{V} = L_{P X} V$$

(this is equation (1.13) of our previous paper [1]), then after solving,

$$P(c(X) - \hat{c}(X)) = 0,$$

the control input will be given by:

$$f(X) \equiv \nabla_X X - \hat{\nabla}_X X + \text{grad}_{\gamma} V - \widehat{\text{grad}}_{\gamma} \hat{V} + c(X) - \hat{c}(X) \quad (4)$$

We now apply the above method to the inverted pendulum cart depicted in Figure 1.

With appropriate scaling, the metric g is given by $g = d\theta^2 + 2b \cos(\theta) dx d\theta + dx^2$, where b is a physical parameter, $0 < b < 1$. The potential energy is given by $V = \cos(\theta)$. Since no torques can be applied directly to the pendulum, $P = (b \cos(\theta) dx + d\theta) \otimes \partial/\partial\theta$ is the orthogonal projection onto the direction $\partial/\partial\theta$. Assuming that there is no dissipation, $c = 0$.

Let θ be the coordinate with index 1, and x be the coordinate with index 2. Writing $\lambda P X = \sigma \frac{\partial}{\partial\theta} + \mu \frac{\partial}{\partial x}$, where σ and μ are yet to be found, the λ -equation may be rewritten as

$$\frac{\partial}{\partial\theta}(\sigma + b \cos(\theta)\mu) + 2b \sin(\theta)\mu = 0,$$

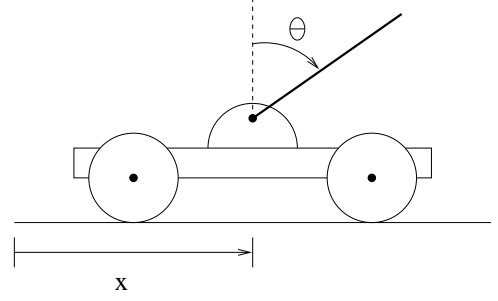

Figure 1: Inverted pendulum cart

$$\frac{\partial}{\partial x}(\sigma + b \cos(\theta)\mu) = 0.$$

For these equations to be consistent the following compatibility condition must hold:

$$\frac{\partial}{\partial x}(\sin(\theta)\mu) = 0.$$

This implies that μ is a function of θ . The second λ -equation implies that σ is a function of θ . The first λ -equation then becomes an ODE which may be solved for σ giving,

$$\sigma(\theta) = \sigma_0 + b\mu_0 - b \cos(\theta) - 2b \int_0^\theta \sin(t)\mu(t) dt.$$

Before solving the \hat{g} -equation, it is helpful to solve,

$$\sigma \frac{\partial y}{\partial\theta} + \mu \frac{\partial y}{\partial x} = 0.$$

Using the method of characteristics, we find,

$$y = x - \int_0^\theta \frac{\mu(t)}{\sigma(t)} dt.$$

The \hat{g} -equation may be rewritten as

$$\sigma \frac{\partial \hat{g}_{11}}{\partial\theta} + \mu \frac{\partial \hat{g}_{11}}{\partial x} + 2\left(\frac{\partial\sigma}{\partial\theta} - \frac{\sigma}{\mu} \frac{\partial\mu}{\partial\theta}\right) \hat{g}_{11} + 2 \frac{\partial\mu}{\partial\theta} = 0.$$

Let $\bar{\sigma}$ and $\bar{\mu}$ be σ and μ considered as functions of θ and y , i.e.,

$$\bar{\sigma}(\theta, y(\theta, x)) = \sigma(\theta, x), \quad \bar{\mu}(\theta, y(\theta, x)) = \mu(\theta, x).$$

The solution to the \hat{g} -equation is then given explicitly by

$$\hat{g}_{11}(\theta, x) = \frac{\mu^2}{\sigma^2} \left[-2 \int_0^\theta \frac{\bar{\sigma}}{\bar{\mu}^3} \frac{\partial \bar{\mu}}{\partial\theta} d\theta \Big|_y + h(y) \right],$$

where $h(y)$ is an arbitrary function of a single variable. Using the definition of λ , we have

$$\hat{g}_{12} = \frac{1}{\mu} (1 - \sigma \hat{g}_{11}),$$

$$\hat{g}_{22} = \frac{1}{\mu}(b \cos(\theta) - \sigma \hat{g}_{12}).$$

Using integration by parts and the first λ -equation, we can simplify the integral appearing in \hat{g}_{11} . Explicitly,

$$\hat{g}_{11}(\theta, x) = \frac{1}{\sigma} - \frac{\sigma_0 \mu^2}{\mu_0^2 \sigma^2} - \frac{b \cos(\theta) \mu}{\sigma^2} + \frac{b \mu^2}{\mu_0 \sigma_0^2} + \frac{\mu^2}{\sigma^2} h(y).$$

The function \hat{V} satisfies the equation

$$\sigma \frac{\partial \hat{V}}{\partial \theta} + \mu \frac{\partial \hat{V}}{\partial x} = -\sin(\theta).$$

Considering \hat{V} as a function of θ and y , this becomes an ODE. The resulting expression for \hat{V} is:

$$\hat{V}(\theta, x) = w(y(\theta, x)) - \int_0^\theta \frac{\sin(t)}{\sigma(t)} dt,$$

here $w(y)$ is an arbitrary function. Finally, the solution to the \hat{c} -equation is given by:

$$\hat{c}^1 = -b \cos(\theta)(\hat{c}^2 - c^2) + c^1,$$

where \hat{c}^2 is an arbitrary function which is odd in the velocities. The final control law is given by equation (4).

For the inverted pendulum in our lab, the parameter, b , is .238, and $c = 0$. (In practice, there is some dissipation in the base of the cart, but this may be directly counteracted by a term in the control law. The dissipation in the joint holding the pendulum is really negligible.) The value of b is different from the value that was used in the simulations in [1]. This is because we are now taking into account additional contributions to the mass of the base of the cart and to the mass of the pendulum.

The control law studied in [1] stabilized a wide range of initial conditions, however, it was found to be underdamped for small initial conditions. This was not disappointing because the arbitrary functions in our control law were chosen for algebraic simplicity, and not for specific engineering goals. For this paper, we decided to use step functions in place of some of the constants used previously. By using step functions we hoped to reduce the number of parameters to something which would be reasonable to analyze. Our plan was to try to blend the nonlinear control law which worked well for large disturbances with one which would linearize to the linear control law that worked well for small initial conditions. In particular, we took

$$\mu(\theta) = \begin{cases} \mu_0 \cos(\theta), & \text{for } |\theta| \leq \theta_L \\ \mu_\infty \cos(\theta), & \text{otherwise} \end{cases} .$$

$$h(y) = \begin{cases} h_0, & \text{for } y \leq y_L \\ h_\infty, & \text{otherwise} \end{cases}$$

$$w(y) = \begin{cases} \frac{1}{2} w_0 y^2, & \text{for } y \leq y_L \\ \frac{1}{2} w_\infty y^2, & \text{otherwise} \end{cases}$$

The entire motivation for this method is that $\hat{H}(\dot{\gamma}) = \frac{1}{2} \hat{g}(\dot{\gamma}, \dot{\gamma}) + \hat{V}(\gamma)$, is a natural candidate for a Lyapunov function for the closed loop system. The time derivative of \hat{H} is, $-\hat{g}(\hat{c}(X), X) = (\det \hat{g}) \cdot \hat{c}^2 \cdot (\mu_0 \cos \theta \dot{\theta} - \sigma_0 \dot{x})$. Thus taking $\hat{c}^2 = \Phi(\mu_0 \cos \theta \dot{\theta} - \sigma_0 \dot{x})$ will insure that \hat{H} is never increasing. We take,

$$\Phi(\theta) = \begin{cases} \Phi_0, & \text{for } |\theta| \leq \theta_L \\ \Phi_\infty, & \text{otherwise} \end{cases} .$$

With these choices, the function σ will take the form,

$$\sigma(\theta) = \begin{cases} \sigma_0, & \text{for } |\theta| \leq \theta_L \\ \sigma_\infty, & \text{otherwise} \end{cases} ,$$

where $\sigma_\infty = \sigma_0 + b(\mu_0 - \mu_\infty) \cos^2(\theta_L)$. We guessed $\theta_L = .3$ and $y_L = 15$. Values which stabilize a large region are:

$$\sigma_\infty = -.05, \quad \mu_\infty = 9.9, \quad w_\infty = 1.5, \quad \Phi_\infty = .75, \quad \text{and} \\ h_\infty = .03.$$

These are a slight modification of the values given in our previous paper, since we are using a slightly different value of b . To compute the appropriate values for the remaining constants, we write the linear control input as: $u_l = g(f, \frac{\partial}{\partial x}) = p_1 \theta + p_2 x + d_1 \dot{\theta} + d_2 \dot{x}$. Setting $\frac{\partial u}{\partial \theta}|_0 = p_1$, $\frac{\partial u}{\partial x}|_0 = p_2$, $d_1 \sigma_0 + d_2 \mu_0 = 0$, and $\sigma_\infty = \sigma_0 + b(\mu_0 - \mu_\infty) \cos^2(\theta_L)$ determines four of the remaining parameters. The final parameter is determined by the condition, $\frac{\partial u}{\partial \theta}|_0 = d_1$. The resulting parameters are:

$$\sigma_0 = -1.59, \quad \mu_0 = 17, \quad w_0 = .00296, \quad \Phi_0 = 1.48, \quad \text{and} \\ h_0 = .0081.$$

Numerical results comparing the control law described above with the linear control law are presented in Figs. 2 through 5 below. The small initial conditions were $\theta_0 = 0.4$, $x_0 = 0$, $\dot{\theta}_0 = 0$, and $\dot{x}_0 = 0$. The large initial conditions were $\theta_0 = 1.1$, $x_0 = 0$, $\dot{\theta}_0 = 0$, and $\dot{x}_0 = 0$.

3 Implementation

The inverted pendulum cart in our lab cannot directly observe the velocity or angular velocity of the cart. Thus, full state feedback is not possible and the modifications needed to implement the control law based upon the output of a non-trivial linear observer, C , must be considered. For our first test of a digital control system implementing the control law described above, we took an estimator of the form (3) with $\tau = 0.0143$,

$$A_d = \begin{pmatrix} 1 & 0 & 0.0143 & 0 \\ 0 & 1 & 0 & 0.0143 \\ 0.0151 & 0 & 1 & 0 \\ -.0036 & 0 & 0 & 1 \end{pmatrix},$$

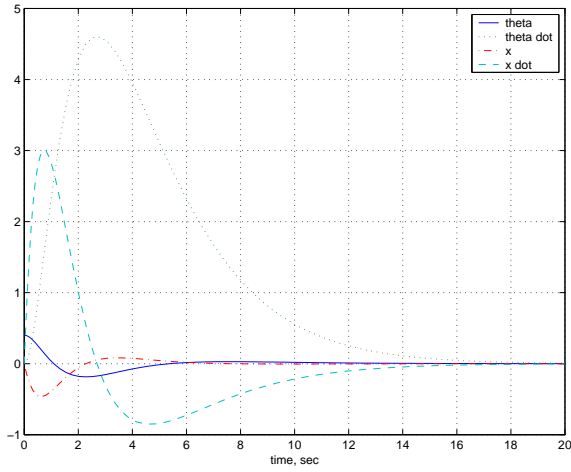

Figure 2: Linear control law with small initial conditions

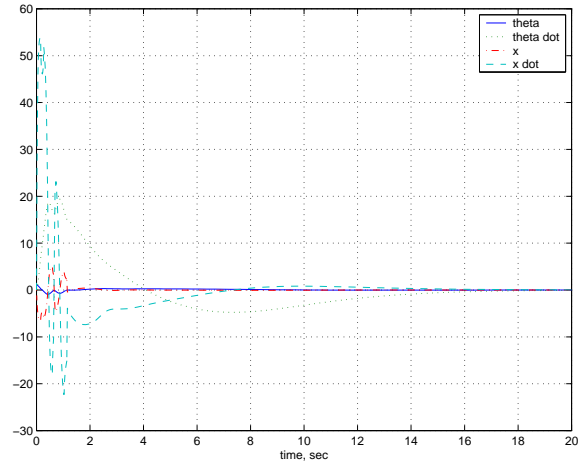

Figure 5: Nonlinear control law with large initial conditions

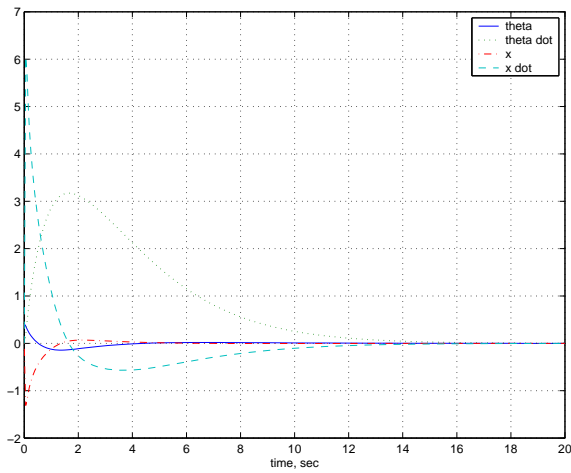

Figure 3: Nonlinear control law with small initial conditions

$$B_d = \begin{pmatrix} 0 \\ 0 \\ -0.0036 \\ 0.0151 \end{pmatrix}, C = \begin{pmatrix} 1 & 0 & 0 & 0 \\ 0 & 1 & 0 & 0 \end{pmatrix},$$

$$G_d = \begin{pmatrix} 0.168 & 0 \\ -0.0001 & 0.165 \\ 0.509 & 0 \\ -0.0039 & 0.473 \end{pmatrix}, x = \begin{pmatrix} \theta \\ x \\ \dot{\theta} \\ \dot{x} \end{pmatrix}$$

Results from our numerical computations of this larger system are displayed in Figures 6 and 7. The initial estimated state was chosen to be the same as the initial conditions. System (3) was unstable with the large initial conditions for both the linear and nonlinear control law.

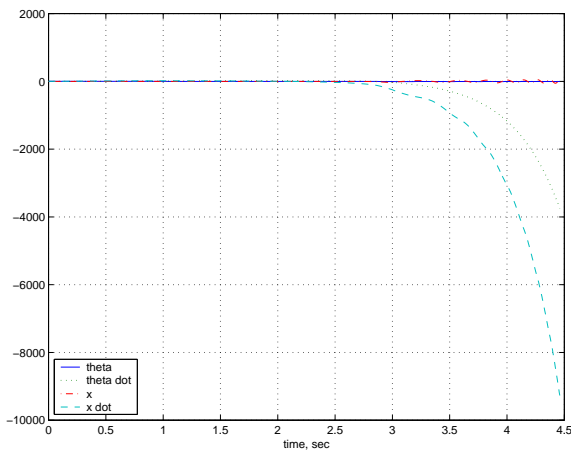

Figure 4: Linear control law with large initial conditions

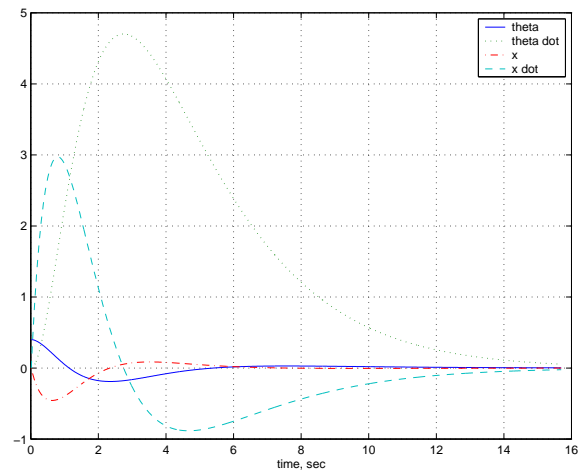

Figure 6: Linear control law with small initial conditions state estimation and sampled data

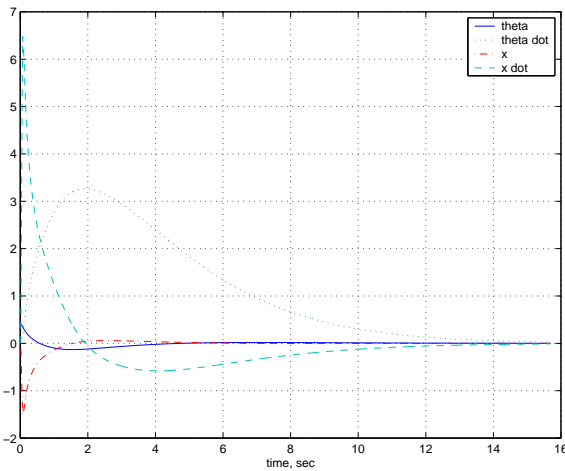

Figure 7: Nonlinear control law with small initial conditions, state estimation and sampled data

4 Conclusions

Looking for control laws so that the closed loop system takes some specified form appears to be a promising idea in nonlinear control theory. There are however many issues which have not been fully resolved. One must first decide what it means to say that one control law is better than another. With only an intuitive idea of what is "better" we would argue that a control law derived via the matching equations works "better" for an inverted pendulum cart than a linear control law. This brings up the question of finding control laws of this type. Such control laws are usually described as solutions to a system of partial differential equations. Just guessing a solution based on the form of the equations is not a very satisfactory solution to the problem. The general solution to the matching equations may be found for systems with two degrees of freedom. If there is some symmetry present, it is also possible to find solutions to the matching equations. This leaves open the problem of finding such control laws for systems with more degrees of freedom in the absence of symmetry. The general matching equations have many solutions. This means that one must have some method for picking a good solution to the matching equations.

Assuming that all of these questions have been answered, one must still come up with satisfactory answers to the main questions discussed in this paper: what state estimator should be used, and why will the closed loop system be stable when only sampled data is used. Mathematically, it is well known that the resulting system will be locally stable if the linearization about the equilibrium is stable and the sample time is sufficiently small. Perhaps some numerical and experimental tests will shed some light on the correct choice for a state estimation scheme. Given the promising results of the

matching control law applied to the inverted pendulum cart, and the wide array of open questions, this is a fertile area for future research.

References

- [1] Auckly, D., Kapitanski, L., and White, W.: Control of nonlinear underactuated systems, *Commun. Pure Appl. Math.*, Vol **53**, pp. 354-369, 2000.
- [2] Auckly, D., Kapitanski, L.: Mathematical Problems in the Control of Underactuated Systems, 2000, *Preprint*.
- [3] Andreev, F., Auckly, D., Kapitanski, L., Kelkar, A. G., and White, W. N.: Matching control laws for a ball and beam system, *Proc. IFAC Workshop on Lagrangian and Hamiltonian Methods for Control*, March 2000, *Preprint*.
- [4] Bloch, A., Leonard, N., and Marsden, J.: Matching and stabilization by the method of controlled Lagrangians, *Proc. IEEE Conf. on Decision and Control*, Tampa, FL, pp. 1446-1451, 1998.
- [5] Bloch, A., Leonard, N., and Marsden, J.: Stabilization of the pendulum on a rotor arm by the method of controlled Lagrangians, *Proc. IEEE Int. Conf. on Robotics and Automation*, Detroit, MI, pp. 500-505, 1999.
- [6] Hamberg, J.: General matching conditions in the theory of controlled Lagrangians, *Proceedings of the 38th Conference on Decision and Control*, 1999. Phoenix, AZ.
- [7] van der Schaft, A. J.: Stabilization of Hamiltonian systems, *Nonlinear Analysis, Theory, Methods & Applications*, **10**, 1021-1035, 1986.
- [8] Bloch, A., Leonard, N., and Marsden, J.: Stabilization of mechanical systems using controlled Lagrangians, *Proc. IEEE Conference on Decision and Control*, San Diego, CA, pp. 2356-2361, 1997.
- [9] Dorf, R. C. and Bishop, R. H.: *Modern Control Systems*, Addison-Wesley, 1995.
- [10] Sontag, E. D.: *Mathematical Control Theory*, Texts in applied mathematics, 6, Springer-Verlag, New York, 1990.