

# Derivation of the Cubic Non-linear Schrödinger Equation from Quantum Dynamics of Many-Body Systems

László Erdős<sup>2\*</sup>, Benjamin Schlein<sup>1†</sup> and Horng-Tzer Yau<sup>1‡</sup>

Department of Mathematics, Harvard University  
Cambridge, MA 02138, USA<sup>1</sup>

Institute of Mathematics, University of Munich,  
Theresienstr. 39, D-80333 Munich, Germany<sup>2</sup>

Jun 12, 2006

## Abstract

We prove rigorously that the one-particle density matrix of three dimensional interacting Bose systems with a short-scale repulsive pair interaction converges to the solution of the cubic non-linear Schrödinger equation in a suitable scaling limit. The result is extended to  $k$ -particle density matrices for all positive integer  $k$ .

AMS Classification Number (2000): 35Q55, 81Q15, 81T18, 81V70.

Running title: Derivation of the cubic NLS equation.

Keywords: Feynman diagrams, BBGKY hierarchy, dispersive estimates, propagation of chaos.

## 1 Introduction

The fundamental principle of quantum mechanics states that a quantum system of  $N$  particles is described by a wave function of  $N$  variables satisfying a Schrödinger equation. In realistic systems,  $N$  is so large that a direct solution of the Schrödinger equation for interacting systems is clearly an impossible task. Many-body dynamics is thus traditionally approximated by simpler effective dynamics where only the time evolution of a few cumulative degrees of freedom is monitored. In the simplest case only the one-particle marginal densities are considered. The many-body pair interaction is then replaced by an effective non-linear mean-field potential and higher order quantum correlations are neglected.

For Bose systems, there are three important examples: i) the Hartree equation describing Bose systems with soft or Coulomb interactions in the mean field limit; ii) the cubic non-linear Schrödinger (NLS) equation for Bose systems with short range interactions in suitable scaling limits and iii) the Gross-Pitaevskii equation for the condensate of Bose systems with short range interactions (including the hard core interaction) in a certain scaling limit. All three equations are non-linear Schrödinger

---

\*Partially supported by EU-IHP Network "Analysis and Quantum" HPRN-CT-2002-0027.

†Supported by NSF postdoctoral fellowship.

‡Partially supported by NSF grant DMS-0307295 and MacArthur Fellowship.

equations and the Gross-Pitaevskii equation is itself a cubic non-linear Schrödinger (NLS) equation. The fundamental reason why nonlinear Schrödinger equation describes these three systems is the following observation: the effective dynamics of a given particle is governed by the density times the two-body scattering process. In particular, all three-body scattering processes are negligible in the limit; a fact that should be established rigorously. We now introduce a model covering all these cases.

Before giving the precise definitions, we explain the physical differences among these three effective theories. Let  $\sum_{1 \leq i < j \leq N} U(x_i - x_j)$  be the many-body pair interaction, where  $x_j$  is the position of the  $j$ -th particle. The largest lengthscale of the problem is the size of the system and it is typically comparable with the variation scale of the particle density  $\varrho(x)$ . We will set this scale to be  $O(1)$ . Thus the density of the system,  $\varrho$ , is of order  $N$ . The potential  $U$  defines two lengthscales: the range of  $U$  and the scattering length of  $U$  (see Appendix for a definition), denoted by  $r_U$  and  $a_U$ , respectively. The scattering length determines the effective lengthscale of the two particle correlations. We shall set the scattering length  $a_U \sim O(N^{-1})$  so that  $\varrho a_U$  is order one. This is needed to obtain an effective one-particle dynamics in our model.

The case i), the Hartree equation, is obtained when  $r_U \sim O(1)$ , i.e. the range of  $U$  is comparable with spatial variation of the density. In this case, the effective two-body scattering process is of mean-field type, and each particle is subject to an effective potential  $U * \varrho$ . If  $a_U \ll r_U \ll 1$ , i.e. the range of  $U$  is much shorter than the spatial variation of the density but bigger than the scattering length, the effective two-body scattering process is its Born approximation and the effective potential is  $\varrho \int U$ . Mathematically, this can be explained by the fact that the weak limit of  $U(x)$  in this scaling is  $\delta(x) \int U$ . Since  $\varrho(x)$  is quadratic in the quantum mechanical wave function, one obtains a cubic nonlinear Schrödinger equation for the one-particle orbitals. Finally, the Gross-Pitaevskii equation arises when the potential  $U$  is so localized that its range is comparable with its scattering length,  $a_U \sim r_U$  (in particular, this is the case of the hard-core interaction). In this case, the effective two-body scattering is the full two-body scattering process and the effective potential is  $8\pi\varrho a_U$ .

We now give the precise definition of this model. We consider a system of  $N$  interacting bosons in  $d = 3$  dimensions. The state space of the  $N$ -boson system is  $L_s^2(\mathbb{R}^{3N}, d\mathbf{x})$ , the subspace of  $L^2(\mathbb{R}^{3N}, d\mathbf{x})$  containing all functions symmetric with respect to permutations of the  $N$  particles. Let  $V$  be a smooth, compactly supported, non-negative and symmetric ( i.e.  $V(x) = V(-x)$ ) function. Define the rescaling of  $V$  by

$$V_N(x) := N^{3\beta} V(N^\beta x), \quad (1.1)$$

where  $\beta$  is a nonnegative parameter. The Hamiltonian with pair interaction  $\frac{1}{N} V_N(x_i - x_j)$  is given by the nonnegative self-adjoint operator

$$H_N = - \sum_{j=1}^N \Delta_j + \frac{1}{N} \sum_{i < j} V_N(x_i - x_j) \quad (1.2)$$

acting on  $L_s^2(\mathbb{R}^{3N}, d\mathbf{x})$ . Denote by  $\psi_{N,t}$  the wave function at time  $t$ ; it satisfies the Schrödinger equation

$$i\partial_t \psi_{N,t} = H_N \psi_{N,t}, \quad (1.3)$$

with initial condition  $\psi_{N,0}$ . The Schrödinger equation conserves the energy, the  $L^2$ -norm and the permutation symmetry of the wave function.

Instead of describing the system through its wave function  $\psi_{N,t}$ , we can introduce the corresponding density matrix  $\gamma_{N,t}$ , defined as the orthogonal projection onto  $\psi_{N,t}$  in the space  $L^2(\mathbb{R}^{3N}, d\mathbf{x})$ ,

i.e.,  $\gamma_{N,t} = \pi\psi_{N,t}$ . The Schrödinger equation (1.3) assumes then the Heisenberg form

$$i\partial_t\gamma_{N,t} = [H_N, \gamma_{N,t}], \quad [A, B] := AB - BA. \quad (1.4)$$

Since  $\|\psi_{N,t}\| = 1$ , it follows that  $\text{Tr} \gamma_{N,t} = 1$ .

For any integer  $k = 1, \dots, N$ , we define the  $k$ -particle marginal density,  $\gamma_{N,t}^{(k)}$ , by taking the partial trace of  $\gamma_{N,t}$  over the last  $N - k$  particles. If  $\gamma_{N,t}(\mathbf{x}; \mathbf{x}') := \psi_{N,t}(\mathbf{x})\overline{\psi_{N,t}(\mathbf{x}' )}$  denotes the kernel of  $\gamma_{N,t}$ , then the kernel of  $\gamma_{N,t}^{(k)}$  is given by

$$\gamma_{N,t}^{(k)}(\mathbf{x}_k; \mathbf{x}'_k) = \int_{\mathbb{R}^{3(N-k)}} d\mathbf{x}_{N-k} \gamma_{N,t}(\mathbf{x}_k, \mathbf{x}_{N-k}; \mathbf{x}'_k, \mathbf{x}_{N-k}). \quad (1.5)$$

Here and henceforth we use the notation  $\mathbf{x} = (x_1, \dots, x_N)$ ,  $\mathbf{x}_k = (x_1, \dots, x_k)$ ,  $\mathbf{x}_{N-k} = (x_{k+1}, \dots, x_N)$ , and similarly for the primed variables. Due to the permutational symmetry of  $\psi_{N,t}$  in all variables, the marginal densities are also symmetric in the sense that

$$\gamma_{N,t}^{(k)}(x_1, x_2, \dots, x_k; x'_1, x'_2, \dots, x'_k) = \gamma_{N,t}^{(k)}(x_{\sigma(1)}, x_{\sigma(2)}, \dots, x_{\sigma(k)}; x'_{\sigma(1)}, x'_{\sigma(2)}, \dots, x'_{\sigma(k)}) \quad (1.6)$$

for any permutation  $\sigma \in \mathcal{S}_k$  ( $\mathcal{S}_k$  denotes the set of permutations on  $k$  elements). Denote by  $\Theta_\sigma$  the unitary operator

$$(\Theta_\sigma\psi)(x_1, \dots, x_k) = \psi(x_{\sigma(1)}, \dots, x_{\sigma(k)}). \quad (1.7)$$

Then (1.6) is equivalent to

$$\Theta_\sigma\gamma^{(k)}\Theta_{\sigma^{-1}} = \gamma^{(k)} \quad (1.8)$$

for all  $\sigma \in \mathcal{S}_k$ . By definition, *density matrices* are non-negative trace class operators,  $\gamma^{(k)} \geq 0$ , acting on  $L^2(\mathbb{R}^{3k})$  and with permutational symmetry (1.6). With a slight abuse of notation we will use the same notation for the operators and their kernels.

The two-body potential of this model is  $U = N^{-1}V_N$ . By scaling, the scattering length  $a_U = O(N^{-1})$ . The range of interaction,  $r_U$ , is of order  $r_U = O(N^{-\beta})$ . Cases i), ii) and iii) correspond to the cases  $\beta = 0$ ,  $0 < \beta < 1$  and  $\beta = 1$ , respectively. The focus of this paper is to study case ii). Our main result, the following Theorem 1.1, states that the time evolution of the one-particle density matrix is given by a cubic non-linear Schrödinger equation, provided  $0 < \beta < 1/2$ . The same result is expected to hold for all  $0 < \beta < 1$ ; the regime  $\beta \geq 1/2$  is an open problem. The topology and spaces used in this theorem, e.g., the weak\* topology of  $\mathcal{L}_k^1$ , will be defined in next section. We state the theorem only for the dimension  $d = 3$ , but the proof can be extended to  $d \leq 2$  as well.

**Theorem 1.1.** *Fix  $\varphi \in H^1(\mathbb{R}^3)$ , with  $\|\varphi\| = 1$ . Assume the Hamiltonian  $H_N$  is defined as in (1.2) with  $0 < \beta < 1/2$ . Suppose that the unscaled potential  $V$  is smooth, compactly supported, positive and symmetric, i.e. it satisfies  $V(x) = V(-x)$ . Let  $\psi_N(\mathbf{x}) := \prod_{j=1}^N \varphi(x_j)$ , and suppose  $\psi_{N,t}$  is the solution of the Schrödinger equation (1.3) with initial data  $\psi_{N,t=0} = \psi_N$ . Let  $\Gamma_{N,t} = \{\gamma_{N,t}^{(k)}\}_{k=1}^N$  be the family of marginal distributions associated to  $\psi_{N,t}$ . Then, for every fixed  $t \in \mathbb{R}$  and integer  $k \geq 1$  we have*

$$\gamma_{N,t}^{(k)} \rightarrow \gamma_t^{(k)} \quad \text{as } N \rightarrow \infty \quad (1.9)$$

with respect to the weak\* topology of  $\mathcal{L}_k^1$ . Here

$$\gamma_t^{(k)}(\mathbf{x}; \mathbf{x}') := \prod_{j=1}^k \varphi_t(x_j)\overline{\varphi_t(x'_j)}, \quad (1.10)$$

where  $\varphi_t$  is the solution of the nonlinear Schrödinger equation

$$i\partial_t\varphi_t = -\Delta\varphi_t + b_0|\varphi_t|^2\varphi_t \quad (1.11)$$

with initial data  $\varphi_{t=0} = \varphi$  and  $b_0 = \int V(x)dx$ .

For dimension  $d = 1$ , Adami, Golse and Teta recently obtained a result similar to Theorem 1.1 in [2] (certain partial results, for the one-dimensional case, were already obtained by these authors, together with Bardos, in [1]).

Theorem 1.1 holds also for  $\beta = 0$ . The nonlinear equation (1.11) then becomes the Hartree equation

$$i\partial_t u_t = -\Delta u_t + (V * |u_t|^2)u_t. \quad (1.12)$$

In this special case, the result was rigorously proven by Hepp [15] for smooth potentials  $V(x)$  and by Spohn [22] for bounded potentials. Ginibre and Velo [14] treated integrable potentials, but they required the initial state to be coherent. In particular, in the approach of [14], the number of particles cannot be fixed. For Coulomb potential, partial results were obtained in [3] and a complete proof was given in [11]. If the particles have a relativistic dispersion then (1.12) has to be replaced by

$$i\partial_t u_t = (1 - \Delta)^{1/2}u_t + (V * |u_t|^2)u_t.$$

This equation was recently derived in [8], starting from many-body dynamics, for the case of a Coulomb potential. A concise overview on results and open problems related to the Hartree equation in physical context is found in [12].

The basic strategy to prove Theorem 1.1 is the same as in [11]: We first write down the BBGKY hierarchy (2.1) for the marginal densities (1.5). Then we take the limit  $N \rightarrow \infty$  to obtain an infinite hierarchy of equations (2.2). Since this hierarchy was first mentioned in the context of the Gross-Pitaevskii scaling,  $\beta = 1$ , we will continue to call it *Gross-Pitaevskii hierarchy* even when the coefficient of the nonlinear term is given by the Born approximation of the scattering length. Finally we prove that the Gross-Pitaevskii hierarchy has a unique solution in a suitable space. Since tensor products of solutions to the non-linear Schrödinger equation (1.11) are trivial solutions to the hierarchy, this identifies the limit and thus proves Theorem 1.1.

The key steps in this approach are an a-priori estimate, the convergence of the BBGKY hierarchy to the infinite hierarchy and the proof of the uniqueness of the infinite hierarchy. The first part was already proved in [7]. The convergence has to be proven in a somewhat stronger sense than in [7]. The key point of the present paper is the uniqueness result stated as Theorem 9.1. This theorem is indeed the well-posedness of the Gross-Pitaevskii hierarchy. Since solutions of the cubic non-linear Schrödinger equation naturally generate solutions of the hierarchy by taking tensor products, Theorem 9.1 can be viewed as an extension of the well-posedness theorem of the NLS equation to infinite dimensions. Therefore, we have to either extend the fundamental tool in the well-posedness of the nonlinear Schrödinger equation, the Strichartz inequality, to infinite dimensions or find a method avoiding it (for a review on the Strichartz inequality and the well-posedness of nonlinear Schrödinger equations see, e.g., [4], [5], [24]). Apart from this issue, we have to control correlation effects of many-particle systems which are absent in the nonlinear equation in Euclidean space. Our method, based on the analysis of Feynman graphs, provides a solution to both problems and contains in certain sense a version of Strichartz inequality in infinite dimension—albeit we deal only with cubic nonlinearity. We will explain this issue in the remarks after Theorem 9.3.

We emphasize that our uniqueness result is valid for any coupling constant in the non-linear Schrödinger equation, in particular it is valid also for the special case of the Gross-Pitaevskii equation. Thus the main part of the paper actually is independent of the scaling in the  $N$ -body model, in particular it is independent of the choice of  $\beta$ . The restriction  $\beta < 1/2$  is only used to obtain the a-priori bound and therefore the convergence to the infinite hierarchy.

As mentioned earlier, the coupling constant  $b_0 = \int V$  in the non-linear Schrödinger equation in Theorem 1.1 is the Born approximation to the physically correct coupling constant:  $8\pi$  times the scattering length  $a_N$  of the potential  $\frac{1}{N}V_N$ . To see this, denote the scattering length of  $V$  by  $a_0$ . Then we have

$$\lim_{N \rightarrow \infty} Na_N = \begin{cases} b_0/8\pi & \text{if } 0 < \beta < 1, \\ a_0 & \text{if } \beta = 1. \end{cases} \quad (1.13)$$

The limit in the first case is proved in Lemma A.1 for radial potential; the second one is just a rescaling. Notice that at  $\beta = 1$ , the coupling constant is the scattering length of the unscaled potential, which indicates that the full two-body scattering process needs to be taken into account. For stationary problem in this case, the connection between the ground state energy of the Bose system and the Gross-Pitaevskii energy functional was rigorously established by Lieb and Yngvason [18]. Furthermore, the existence of Bose-Einstein condensation in this limit was proved by Lieb and Seiringer [16]. An excellent overview on the recent development in these problems, see [17]. For the dynamical problem, we have proved in [9] that the family of the reduced density matrices converges to a solution of the Gross-Pitaevskii hierarchy with the correct coupling constant  $8\pi a_0$ . However, the a priori estimate obtained in [9] was not strong enough to apply the uniqueness theorem in this paper, Theorem 9.1. Furthermore, the pair interactions in [9] were cutoff whenever many particles are in a very small physically unlikely region. To complete the project for  $\beta = 1$ , we still have to remove this cutoff and establish the a priori estimate needed for Theorem 9.1.

*Acknowledgement.* We would like to thank the referees for their helpful comments on how to improve the presentation of the results in the manuscript.

## 2 The BBGKY Hierarchy

The marginal density matrices (1.4) satisfy the BBGKY hierarchy:

$$\begin{aligned} i\partial_t \gamma_{N,t}^{(k)}(\mathbf{x}_k; \mathbf{x}'_k) &= \sum_{j=1}^k \left( -\Delta_{x_j} + \Delta_{x'_j} \right) \gamma_{N,t}^{(k)}(\mathbf{x}_k; \mathbf{x}'_k) \\ &+ \frac{1}{N} \sum_{1 \leq i < j \leq k} \left( V_N(x_i - x_j) - V_N(x'_i - x'_j) \right) \gamma_{N,t}^{(k)}(\mathbf{x}_k; \mathbf{x}'_k) \\ &+ \left( 1 - \frac{k}{N} \right) \sum_{j=1}^k \int dx_{k+1} \left( V_N(x_j - x_{k+1}) - V_N(x'_j - x_{k+1}) \right) \gamma_{N,t}^{(k+1)}(\mathbf{x}_k, x_{k+1}; \mathbf{x}'_k, x_{k+1}) \end{aligned} \quad (2.1)$$

for  $k = 1, 2, \dots, N$ . The first term on the right hand side of the hierarchy describes the kinetic energy of the first  $k$  particles; the second term is associated with the interactions among the first  $k$  particles, and the last term corresponds to interactions between the first  $k$  particles and the other  $N - k$  particles.

Recall that  $b_0 = \int dx V(x)$  is the  $L^1$  norm of the non-negative potential  $V$ . Since  $V_N(x) \rightarrow b_0\delta(x)$  as  $N \rightarrow \infty$ , the BBGKY hierarchy (2.1) converges formally, as  $N \rightarrow \infty$ , to the following *Gross-Pitaevskii hierarchy* of equations:

$$\begin{aligned} i\partial_t \gamma_t^{(k)}(\mathbf{x}_k; \mathbf{x}'_k) &= \sum_{j=1}^k \left( -\Delta_{x_j} + \Delta_{x'_j} \right) \gamma_t^{(k)}(\mathbf{x}_k; \mathbf{x}'_k) \\ &+ b_0 \sum_{j=1}^k \int dx_{k+1} \left( \delta(x_j - x_{k+1}) - \delta(x'_j - x_{k+1}) \right) \gamma_t^{(k+1)}(\mathbf{x}_k, x_{k+1}; \mathbf{x}'_k, x_{k+1}), \end{aligned} \quad (2.2)$$

for any  $k \geq 1$ . It is easy to see that the family of factorized densities  $\gamma_t^{(k)} = \prod_{j=1}^k \varphi_t(x_j) \overline{\varphi_t(x'_j)}$  is a solution of (2.2) if and only if  $\varphi_t$  is a solution of the cubic nonlinear Schrödinger equation

$$i\partial_t \varphi_t = -\Delta \varphi_t + b_0 |\varphi_t|^2 \varphi_t. \quad (2.3)$$

If we can establish the uniqueness of the Gross-Pitaevskii hierarchy, then for every fixed  $k \geq 1$ ,

$$\gamma_{N,t}^{(k)} \rightarrow \gamma_t^{(k)} = \prod_{j=1}^k \varphi_t(x_j) \overline{\varphi_t(x'_j)}, \quad \text{as } N \rightarrow \infty \quad (2.4)$$

with respect to some suitable topology.

As a technical point, we remark that the action of the delta-function on general density matrices in (2.2) is not well defined. However, in our case, the density matrices are in  $\mathcal{H}_k$ . For such density matrices (2.2) can be defined through an appropriate limiting procedure, see Section 8.

### 3 Banach Spaces of Density Matrices

In this section we define some Banach spaces which will be useful in order to take the limit  $N \rightarrow \infty$  of the marginal densities  $\gamma_{N,t}^{(k)}$ . For  $k \geq 1$ , we denote by  $\mathcal{L}_k^1$  and by  $\mathcal{K}_k$  the space of trace class and, respectively, of compact operators on the  $k$ -particle Hilbert space  $L^2(\mathbb{R}^{3k}, d\mathbf{x}_k)$ . We have

$$(\mathcal{L}_k^1, \|\cdot\|_1) = (\mathcal{K}_k, \|\cdot\|)^*, \quad (3.1)$$

where  $\|\cdot\|_1$  is the trace norm, and  $\|\cdot\|$  is the operator norm (see, for example, Theorem VI.26 in [19]). The density matrices are the nonnegative elements of  $\mathcal{L}_k^1$  with permutational symmetry (1.8).

For  $\gamma^{(k)} \in \mathcal{L}_k^1$ , we define the norm

$$\|\gamma^{(k)}\|_{\mathcal{H}_k} = \text{Tr} |S_1 \dots S_k \gamma^{(k)} S_k \dots S_1|$$

and the corresponding Banach space

$$\mathcal{H}_k = \{\gamma^{(k)} \in \mathcal{L}_k^1 : \|\gamma^{(k)}\|_{\mathcal{H}_k} < \infty\}.$$

Moreover we define the space of operators

$$\mathcal{A}_k = \{T^{(k)} = S_1 \dots S_k K^{(k)} S_k \dots S_1 : K^{(k)} \in \mathcal{K}_k\}$$

with the norm

$$\|T^{(k)}\|_{\mathcal{A}_k} = \|S_1^{-1} \dots S_k^{-1} T^{(k)} S_k^{-1} \dots S_1^{-1}\|$$

where  $\|\cdot\|$  is the operator norm. Then, analogously to (3.1), we have

$$(\mathcal{H}_k, \|\cdot\|_{\mathcal{H}_k}) = (\mathcal{A}_k, \|\cdot\|_{\mathcal{A}_k})^* \quad (3.2)$$

for every  $k \geq 1$ . This induces a weak\* topology on  $\mathcal{H}_k$  (for a proof of (3.2) see Lemma 3.1 in [11]). Since  $\mathcal{A}_k$  is separable, we can fix a dense countable subset of the unit ball of  $\mathcal{A}_k$ : we denote it by  $\{J_i^{(k)}\}_{i \geq 1} \in \mathcal{A}_k$ , with  $\|J_i^{(k)}\|_{\mathcal{A}_k} \leq 1$  for all  $i \geq 1$ . Using the operators  $J_i^{(k)}$  we define the following metric on  $\mathcal{H}_k$ : for  $\gamma^{(k)}, \bar{\gamma}^{(k)} \in \mathcal{H}_k$  we set

$$\rho_k(\gamma^{(k)}, \bar{\gamma}^{(k)}) := \sum_{i=1}^{\infty} 2^{-i} \left| \text{Tr} J_i^{(k)} \left( \gamma^{(k)} - \bar{\gamma}^{(k)} \right) \right|. \quad (3.3)$$

Then the topology induced by the metric  $\rho_k(\cdot, \cdot)$  and the weak\* topology are equivalent on the unit ball of  $\mathcal{H}_k$  (see [20], Theorem 3.16) and hence on any ball of finite radius as well. In other words, a uniformly bounded sequence  $\gamma_N^{(k)} \in \mathcal{H}_k$  converges to  $\gamma^{(k)} \in \mathcal{H}_k$  with respect to the weak\* topology, if and only if  $\rho_k(\gamma_N^{(k)}, \gamma^{(k)}) \rightarrow 0$  as  $N \rightarrow \infty$ .

For a fixed  $T \geq 0$ , let  $C([0, T], \mathcal{H}_k)$  be the space of functions of  $t \in [0, T]$  with values in  $\mathcal{H}_k$  which are continuous with respect to the metric  $\rho_k$ . On  $C([0, T], \mathcal{H}_k)$  we define the metric

$$\widehat{\rho}_k(\gamma^{(k)}(\cdot), \bar{\gamma}^{(k)}(\cdot)) := \sup_{t \in [0, T]} \rho_k(\gamma^{(k)}(t), \bar{\gamma}^{(k)}(t)). \quad (3.4)$$

Finally, we define the space  $\mathcal{H}$  as the direct sum over  $k \geq 1$  of the spaces  $\mathcal{H}_k$ , that is

$$\mathcal{H} = \bigoplus_{k \geq 1} \mathcal{H}_k = \left\{ \Gamma = \{\gamma^{(k)}\}_{k \geq 1} : \gamma^{(k)} \in \mathcal{H}_k, \quad \forall k \geq 1 \right\},$$

and, for a fixed  $T \geq 0$ , we consider the space

$$C([0, T], \mathcal{H}) = \bigoplus_{k \geq 1} C([0, T], \mathcal{H}_k),$$

equipped with the product of the topologies induced by the metric  $\widehat{\rho}^{(k)}$  on  $C([0, T], \mathcal{H}_k)$ . Let  $\tau$  denote this topology. That is, for  $\Gamma_{N,t} = \{\gamma_{N,t}^{(k)}\}_{k \geq 1}$  and  $\Gamma_t = \{\gamma_t^{(k)}\}_{k \geq 1}$  in  $C([0, T], \mathcal{H})$ , we have  $\Gamma_{N,t} \xrightarrow{\tau} \Gamma_t$  for  $N \rightarrow \infty$  if and only if, for every fixed  $k \geq 1$ ,

$$\widehat{\rho}_k(\gamma_{N,t}^{(k)}, \gamma_t^{(k)}) = \sup_{t \in [0, T]} \rho_k(\gamma_{N,t}^{(k)}, \gamma_t^{(k)}) \rightarrow 0$$

as  $N \rightarrow \infty$ .

*Notation.* As in (1.5), we use  $\mathbf{x} = (x_1, \dots, x_N) \in \mathbb{R}^{3N}$ ,  $\mathbf{x}_k = (x_1, \dots, x_k) \in \mathbb{R}^{3k}$ ,  $\mathbf{x}_{N-k} = (x_{k+1}, \dots, x_N) \in \mathbb{R}^{3(N-k)}$ , and analogously for the primed variables. We also use the notation  $\langle x \rangle = (1 + x^2)^{1/2}$ , for all  $x \in \mathbb{R}^d$ . We also set  $S_j = \langle p_j \rangle = (1 - \Delta_j)^{1/2}$ , for all integer  $j \geq 1$  ( $p_j = -i\nabla_{x_j}$  is the momentum of the  $j$ -th particle). Moreover  $\text{Tr}_j$  will indicate for the partial trace over the  $x_j$ -th variable. The norm notation without subscript,  $\|\cdot\|$ , will always refer to the  $L^2$ -norm for functions and to the operator norm in case of operators. Unless stated otherwise, all integrals are over  $\mathbb{R}^3$ , or on  $\mathbb{R}^{3k}$  if the measure is  $d\mathbf{x}_k, d\mathbf{p}_k$  etc. Universal constants will be denoted by (const.). Constants, that may depend on other parameters, will be denoted by  $C$ . The dependence is indicated in the statements but not always in the proofs. Typically  $C$  depends on the initial function  $\varphi$  and on the potential  $V$ . To compare positive numbers  $A, B$ , we also use  $A \lesssim B$  to indicate that there is a universal constant (const.)  $> 0$  with  $A \leq (\text{const.})B$ . The fact that  $A \lesssim B$  and  $B \lesssim A$  is denoted by  $A \sim B$ .

## 4 Outline of the Proof of the Main Theorem

The proof of Theorem 1.1 is divided into several steps. In the following we fix  $T > 0$  arbitrary.

*Step 1: Regularization of the initial data.* Fix  $\kappa > 0$  and  $\chi \in C_0^\infty(\mathbb{R})$ , with  $0 \leq \chi \leq 1$ ,  $\chi(s) = 1$ , for  $0 \leq s \leq 1$ , and  $\chi(s) = 0$  if  $s \geq 2$ . Define the regularized initial function

$$\psi_N^\kappa := \frac{\chi(\kappa H_N/N)\psi_N}{\|\chi(\kappa H_N/N)\psi_N\|},$$

and we denote by  $\psi_{N,t}^\kappa$  the solution of the Schrödinger equation (1.3) with initial data  $\psi_N^\kappa$ . Denote by  $\tilde{\Gamma}_{N,t} = \{\tilde{\gamma}_{N,t}^{(k)}\}_{k=1}^N$  the family of marginal densities associated with  $\psi_{N,t}^\kappa$ . The tilde in the notation indicates dependence on the cutoff parameter  $\kappa$ .

This regularization cuts off the high energy part of  $\psi_N$  and it allows us to obtain the strong a-priori estimate

$$\mathrm{Tr} (1 - \Delta_1) \dots (1 - \Delta_k) \tilde{\gamma}_{N,t}^{(k)} \leq \tilde{C}^k \quad (4.1)$$

for sufficiently large  $N$  and uniformly in  $t$  (see Theorem 7.1). Here the constant  $\tilde{C}$  depends on the cutoff  $\kappa > 0$ . We thus have the compactness stated in the following step.

*Step 2: Compactness of  $\tilde{\Gamma}_{N,t}$ .* For fixed  $k \geq 1$ , it follows from Theorem 7.1 that the sequence  $\tilde{\gamma}_{N,t}^{(k)} \in C([0, T], \mathcal{H}_k)$  is compact with respect to the topology induced by the metric  $\hat{\rho}_k$ . By a standard Cantor diagonalization argument, this implies that  $\tilde{\Gamma}_{N,t}$  is a compact sequence in  $C([0, T], \mathcal{H})$  with respect to the  $\tau$ -topology. It also follows from Theorem 7.1, that, if  $\tilde{\Gamma}_{\infty,t} = \{\tilde{\gamma}_{\infty,t}^{(k)}\}_{k \geq 1} \in C([0, T], \mathcal{H})$  denotes an arbitrary limit point of  $\tilde{\Gamma}_{N,t}$ , then  $\tilde{\gamma}_{\infty,t}^{(k)}$  is non-negative, symmetric w.r.t. permutations in the sense of (1.8), and satisfies

$$\mathrm{Tr} |S_1 \dots S_k \tilde{\gamma}_{\infty,t}^{(k)} S_k \dots S_1| \leq \tilde{C}^k \quad (4.2)$$

for all  $k \geq 1$  and  $t \in [0, T]$ . We put a tilde in the notation for  $\tilde{\Gamma}_{\infty,t}$  and  $\tilde{C}$ , because a-priori they may depend on the cutoff  $\kappa$ , which is kept fixed here. Notice that  $\tilde{C}$  is independent of  $k$ . From Step 3 and Step 4 below it will follow that  $\tilde{\Gamma}_{\infty,t}$  is actually independent of  $\kappa$ .

*Step 3: Convergence to solutions of the Gross-Pitaevskii hierarchy.* Define the free evolution operator

$$\mathcal{U}_0^{(k)}(t)\gamma^{(k)} = \exp\left(-it \sum_{j=1}^k (-\Delta_j)\right) \gamma^{(k)} \exp\left(it \sum_{j=1}^k (-\Delta_j)\right). \quad (4.3)$$

Theorem 8.1 states that an arbitrary limit point  $\tilde{\Gamma}_{\infty,t} \in C([0, T], \mathcal{H})$  of the sequence  $\tilde{\Gamma}_{N,t}$  satisfies the infinite Gross-Pitaevskii hierarchy in the integral form

$$\tilde{\gamma}_{\infty,t}^{(k)} = \mathcal{U}_0^{(k)}(t)\tilde{\gamma}_{\infty,0}^{(k)} - ib_0 \sum_{j=1}^k \int_0^t ds \mathcal{U}_0^{(k)}(t-s) \mathrm{Tr}_{k+1} [\delta(x_j - x_{k+1}), \tilde{\gamma}_{\infty,s}^{(k+1)}], \quad (4.4)$$

with initial data

$$\tilde{\gamma}_{\infty,t=0}^{(k)}(\mathbf{x}_k; \mathbf{x}'_k) = \gamma_0^{(k)}(\mathbf{x}_k; \mathbf{x}'_k) = \prod_{j=1}^k \varphi(x_j) \bar{\varphi}(x'_j). \quad (4.5)$$



Notice that (4.5) implies that the initial data  $\tilde{\Gamma}_{\infty,t=0}$  is independent of the cutoff  $\kappa$ .

*Step 4: Uniqueness of the solutions of the Gross-Pitaevskii hierarchy.* In Theorem 9.1 we prove that there is at most one solution  $\Gamma_t = \{\gamma_t^{(k)}\}_{k \geq 1}$  of (4.4) in the space  $C([0, T], \mathcal{H})$ , such that, for all  $k \geq 1$  and  $t \in [0, T]$ ,  $\gamma_t^{(k)}$  is non-negative, symmetric w.r.t. permutation (in the sense (1.8)) and satisfies (4.2) and (4.5). Hence the family of factorized densities  $\Gamma_t = \{\gamma_t^{(k)}\}_{k \geq 1}$  defined in (1.10) is the unique nonnegative symmetric solution of the Gross-Pitaevskii hierarchy (4.4). Thus  $\tilde{\Gamma}_{N,t} \rightarrow \Gamma_t$  as  $N \rightarrow \infty$  in the  $\tau$ -topology and this holds for any fixed  $\kappa$ , so the limit is independent of  $\kappa$ . Since  $\tilde{\gamma}_{N,t}^{(k)}$  is bounded in the  $\mathcal{H}_k$  norm, uniformly in  $N$ , the convergence in the metric  $\rho_k$  and the weak\* convergence of  $\mathcal{H}_k$  are equivalent. It therefore follows that for every fixed  $k \geq 1$ ,  $t \in [0, T]$  and  $\kappa > 0$ , we have  $\tilde{\gamma}_{N,t}^{(k)} \rightarrow \gamma_t^{(k)}$  as  $N \rightarrow \infty$  with respect to the weak\* topology of  $\mathcal{H}_k$ . Convergence in weak\*  $\mathcal{L}_k^1$  then trivially follows.

*Step 5: Removal of the cutoff and the conclusion of the proof.* It follows from Proposition 5.1, part ii), that

$$\|\psi_{N,t} - \psi_{N,t}^\kappa\| = \|\psi_N - \psi_N^\kappa\| \leq C\kappa^{1/2},$$

where the constant  $C$  is independent of  $N$  and  $\kappa$ . This implies that, for every  $J^{(k)} \in \mathcal{K}_k$ , we have

$$\left| \text{Tr } J^{(k)} \left( \gamma_{N,t}^{(k)} - \tilde{\gamma}_{N,t}^{(k)} \right) \right| \leq C\kappa^{1/2} \quad (4.6)$$

where the constant  $C$  depends on  $J^{(k)}$ , but is independent of  $N$ ,  $k$  or  $\kappa$ .

For fixed  $k \geq 1$  and  $t$ , we choose  $J^{(k)} \in \mathcal{K}_k$  and  $\varepsilon > 0$ . Then for any  $\kappa > 0$ , we have from (4.6) that

$$\begin{aligned} \left| \text{Tr } J^{(k)} \left( \gamma_{N,t}^{(k)} - \gamma_t^{(k)} \right) \right| &\leq \left| \text{Tr } J^{(k)} \left( \gamma_{N,t}^{(k)} - \tilde{\gamma}_{N,t}^{(k)} \right) \right| + \left| \text{Tr } J^{(k)} \left( \tilde{\gamma}_{N,t}^{(k)} - \gamma_t^{(k)} \right) \right| \\ &\leq C\kappa^{1/2} + \left| \text{Tr } J^{(k)} \left( \tilde{\gamma}_{N,t}^{(k)} - \gamma_t^{(k)} \right) \right|. \end{aligned} \quad (4.7)$$

Since  $\tilde{\gamma}_{N,t}^{(k)} \rightarrow \gamma_t^{(k)}$  with respect to the weak\* topology of  $\mathcal{L}_k^1$ , the last term vanishes in the limit  $N \rightarrow \infty$ . Since  $\kappa > 0$  is arbitrary, the r.h.s. of (4.7) is smaller as  $\varepsilon$  for  $N$  large enough. This completes the proof of the theorem.

*Remark.* Note that the main body of the proof, Steps 1–4, would have proven weak\* convergence in  $\mathcal{H}_k$ . It is in the removal of the cutoff, Step 5, that we can prove only under a weaker convergence. This situation is similar to the Coulomb interaction paper, [11], where the removal of the cutoffs resulted eventually in a weaker sense of convergence.

## 5 Cutoff of the initial wave function

In this section we show how to regularize the initial wave function  $\psi_N(\mathbf{x}) = \prod_{j=1}^N \varphi(x_j)$ . The aim is to find an approximate wave function  $\psi_N^\kappa$ , depending on a cutoff parameter  $\kappa > 0$ , so that, on the one hand, the expectation of  $H_N^k$  in the state  $\psi_N^\kappa$  is of the order  $N^k$ , and, on the other hand, the difference between  $\psi_N$  and  $\psi_N^\kappa$  converges to zero, as  $\kappa \rightarrow 0$ , uniformly in  $N$ .

**Proposition 5.1.** *Let  $\varphi \in H^1(\mathbb{R}^3)$ , with  $\|\varphi\|_{L^2} = 1$ . Assume  $H_N$  is defined as in (1.2): suppose that the unscaled potential  $V$  is smooth and positive, and that  $0 < \beta < 2/3$ . We define  $\psi_N(\mathbf{x}) = \prod_{j=1}^N \varphi(x_j)$ , and, for  $\kappa > 0$ ,*

$$\psi_N^\kappa = \frac{\chi(\kappa H_N/N) \psi_N}{\|\chi(\kappa H_N/N) \psi_N\|}. \quad (5.1)$$

Here  $\chi \in C_0^\infty(\mathbb{R})$  is a cutoff function such that  $0 \leq \chi \leq 1$ ,  $\chi(s) = 1$  for  $0 \leq s \leq 1$  and  $\chi(s) = 0$  for  $s \geq 2$ . We denote by  $\tilde{\gamma}_N^{(k)}$ , for  $k = 1, \dots, N$ , the marginal densities associated with  $\psi_N^\kappa$ .

i) For every integer  $k \geq 1$  and for  $\kappa > 0$  small enough, we have

$$(\psi_N^\kappa, H_N^k \psi_N^\kappa) \leq \frac{2^k N^k}{\kappa^k} \frac{1}{1 - C\kappa^{1/2}} \quad (5.2)$$

where the constant  $C$  only depends on the  $H^1$ -norm of  $\varphi$  and on the unscaled potential  $V(x)$ .

ii) We have

$$\|\psi_N - \psi_N^\kappa\| \leq C\kappa^{1/2}$$

uniformly in  $N$  ( $C$  only depends on the  $H^1$  norm of  $\varphi$  and on the unscaled potential  $V$ ).

iii) Let

$$\gamma_0^{(k)}(\mathbf{x}_k; \mathbf{x}'_k) = \prod_{j=1}^k \varphi(x_j) \bar{\varphi}(x'_j). \quad (5.3)$$

Then, for every fixed  $k \geq 1$  and  $J^{(k)} \in \mathcal{K}_k$ , we have

$$\text{Tr } J^{(k)} \left( \tilde{\gamma}_N^{(k)} - \gamma_0^{(k)} \right) \rightarrow 0 \quad (5.4)$$

as  $N \rightarrow \infty$  (the convergence is uniform in  $\kappa > 0$ , for  $\kappa$  small enough).

*Proof.* First we compute

$$\|\chi(\kappa H_N/N) \psi_N - \psi_N\|^2 = \left( \psi_N, (1 - \chi(\kappa H_N/N))^2 \psi_N \right) \leq \left( \psi_N, \mathbf{1}(\kappa H_N \geq N) \psi_N \right), \quad (5.5)$$

where  $\mathbf{1}(s \geq \lambda)$  is the characteristic function of  $[\lambda, \infty)$ . Next we use that  $\chi(s \geq 1) \leq s$ , for all  $s \geq 0$ . Therefore

$$\begin{aligned} \|\chi(\kappa H_N/N) \psi_N - \psi_N\|^2 &\leq \frac{\kappa}{N} (\psi_N, H_N \psi_N) \\ &= \frac{\kappa}{N} \left( N \|\nabla \varphi\|^2 + \frac{(N-1)}{2} N^{3\beta} (\psi_N, V(N^\beta(x_1 - x_2)) \psi_N) \right) \\ &\leq (\text{const.}) \kappa (\|\varphi\|_{H^1}^2 + \|V\|_{L^1} \|\varphi\|_{H^1}^2), \end{aligned} \quad (5.6)$$

where we used that  $N^{3\beta} V(N^\beta(x_1 - x_2)) \leq (\text{const.}) \|V\|_{L^1} (1 - \Delta_1)(1 - \Delta_2)$  (see Lemma A.3 from Appendix A). Hence

$$\|\chi(\kappa H_N/N) \psi_N - \psi_N\| \leq C\kappa^{1/2} \quad (5.7)$$

for a constant  $C$  only depending on the  $H^1$  norm of  $\varphi$  and on the unscaled potential  $V$ . Using (5.7) we obtain

$$(\psi_N^\kappa, H_N^k \tilde{\psi}_N^\kappa) = \frac{(\psi_N, \chi^2(\kappa H_N/N) H_N^k \psi_N)}{\|\chi(\kappa H_N/N) \psi_N\|^2} \leq \frac{2^k N^k}{\kappa^k} \frac{1}{1 - 2\|\chi(\kappa H_N/N) \psi_N - \psi_N\|} \leq \frac{2^k N^k}{\kappa^k} \frac{1}{1 - C\kappa^{1/2}}$$

for all  $0 < \kappa < 1/C^2$ , which proves i).

Part ii) follows very easily from (5.7) because, using the shorthand notation  $\chi = \chi(\kappa H_N/N)$  and using that  $\|\psi_N\| = 1$ :

$$\begin{aligned} \left\| \psi_N - \frac{\chi \psi_N}{\|\chi \psi_N\|} \right\| &\leq \|\psi_N - \chi \psi_N\| + \left\| \chi \psi_N - \frac{\chi \psi_N}{\|\chi \psi_N\|} \right\| = \|\psi_N - \chi \psi_N\| + |1 - \|\chi \psi_N\|| \\ &\leq 2\|\psi_N - \chi \psi_N\|. \end{aligned} \quad (5.8)$$

Finally, we prove iii). For fixed  $k \geq 1$ ,  $J^{(k)} \in \mathcal{K}_k$  and  $\varepsilon > 0$  we prove that

$$\left| \text{Tr } J^{(k)} \left( \tilde{\gamma}_N^{(k)} - \gamma_0^{(k)} \right) \right| \leq \varepsilon \quad (5.9)$$

if  $N$  is large enough (uniformly in  $\kappa$ , for  $\kappa$  sufficiently small). To this end, we choose  $\varphi^* \in H^2(\mathbb{R}^3)$  with  $\|\varphi^*\| = 1$ , such that  $\|\varphi - \varphi^*\| \leq \varepsilon/(24k\|J^{(k)}\|)$ . Then we define  $\psi_{N,*}(\mathbf{x}) = \prod_{j=1}^k \varphi^*(x_j) \prod_{j=k+1}^N \varphi(x_j)$ , and  $\tilde{\psi}_{N,*} = \chi(\kappa H_N/N) \psi_{N,*} / \|\chi(\kappa H_N/N) \psi_{N,*}\|$ . Moreover we set

$$\tilde{\gamma}_{N,*}^{(k)}(\mathbf{x}_k; \mathbf{x}'_k) = \int d\mathbf{x}_{N-k} \tilde{\psi}_{N,*}(\mathbf{x}_k, \mathbf{x}_{N-k}) \overline{\tilde{\psi}_{N,*}(\mathbf{x}'_k, \mathbf{x}_{N-k})}. \quad (5.10)$$

Note that even though  $\tilde{\psi}_{N,*}$  is not symmetric with respect to permutation of the  $N$  particles, it is still symmetric in the first  $k$  and the last  $N-k$  variables; hence  $\tilde{\gamma}_{N,*}^{(k)}$  is a symmetric density matrix. Next we define the Hamiltonian

$$\hat{H}_N = - \sum_{j \geq k+1} \Delta_j + \frac{1}{N} \sum_{k+1 \leq i < j \leq N} V_N(x_i - x_j),$$

with  $V_N(x) = N^{3\beta} V(N^\beta x)$ . We denote  $\hat{\chi} = \chi(\kappa \hat{H}_N/N)$  and we set  $\hat{\psi}_N = \hat{\chi} \psi_N / \|\hat{\chi} \psi_N\|$  and  $\hat{\psi}_{N,*} = \hat{\chi} \psi_{N,*} / \|\hat{\chi} \psi_{N,*}\|$ . We also define

$$\begin{aligned} \hat{\gamma}_N^{(k)}(\mathbf{x}_k; \mathbf{x}'_k) &:= \int d\mathbf{x}_{N-k} \hat{\psi}_N(\mathbf{x}_k, \mathbf{x}_{N-k}) \overline{\hat{\psi}_N(\mathbf{x}'_k, \mathbf{x}_{N-k})}, \\ \hat{\gamma}_{N,*}^{(k)}(\mathbf{x}_k; \mathbf{x}'_k) &:= \int d\mathbf{x}_{N-k} \hat{\psi}_{N,*}(\mathbf{x}_k, \mathbf{x}_{N-k}) \overline{\hat{\psi}_{N,*}(\mathbf{x}'_k, \mathbf{x}_{N-k})}. \end{aligned} \quad (5.11)$$

Although  $\hat{\psi}_N$  and  $\hat{\psi}_{N,*}$  are not symmetric with respect to permutations of the  $N$  particles, they are still symmetric w.r.t. permutations of the first  $k$  and the last  $N-k$  particles; hence  $\hat{\gamma}_N^{(k)}$  and  $\hat{\gamma}_{N,*}^{(k)}$  are density matrices symmetric in all their variables in the sense (1.6). Apart from the physical densities  $\gamma_N^{(k)}$ , we introduced, starting from the wave functions  $\psi_N$  and  $\psi_{N,*}$ , two more sets of density matrices; the densities  $\tilde{\gamma}_N^{(k)}$  and  $\tilde{\gamma}_{N,*}^{(k)}$ , regularized with the cutoff  $\chi(\kappa H_N/N)$ , and the densities  $\hat{\gamma}_N^{(k)}$  and  $\hat{\gamma}_{N,*}^{(k)}$ , regularized with the cutoff  $\hat{\chi} = \chi(\kappa \hat{H}_N/N)$ . Observe that, since the operator  $\hat{H}_N$  acts trivially on the first  $k$  variables of  $\psi_N$  and  $\psi_{N,*}$ , we have

$$\hat{\psi}_N = \varphi^{\otimes k} \otimes \frac{\hat{\chi} \varphi^{\otimes N-k}}{\|\hat{\chi} \varphi^{\otimes N-k}\|} \quad \text{and} \quad \hat{\psi}_{N,*} = (\varphi^*)^{\otimes k} \otimes \frac{\hat{\chi} \varphi^{\otimes N-k}}{\|\hat{\chi} \varphi^{\otimes N-k}\|} \quad (5.12)$$

where

$$\varphi^{\otimes k} = \underbrace{\varphi \otimes \cdots \otimes \varphi}_{k \text{ factors}}.$$

Hence  $\hat{\gamma}_N^{(k)} = \gamma_0^{(k)}$  (see (5.3)) and

$$\hat{\gamma}_{N,*}^{(k)} = |\varphi^*\rangle \langle \varphi^*|^{\otimes k} = \underbrace{|\varphi^*\rangle \langle \varphi^*| \otimes \cdots \otimes |\varphi^*\rangle \langle \varphi^*|}_{k \text{ factors}},$$

for every  $\kappa > 0$  and  $N \geq k$ . We estimate the l.h.s. of (5.9) by

$$\begin{aligned} \left| \text{Tr } J^{(k)} \left( \tilde{\gamma}_N^{(k)} - \gamma_0^{(k)} \right) \right| &= \left| \text{Tr } J^{(k)} \left( \tilde{\gamma}_N^{(k)} - \hat{\gamma}_N^{(k)} \right) \right| \leq \left| \text{Tr } J^{(k)} \left( \tilde{\gamma}_N^{(k)} - \tilde{\gamma}_{N,*}^{(k)} \right) \right| + \left| \text{Tr } J^{(k)} \left( \tilde{\gamma}_{N,*}^{(k)} - \hat{\gamma}_{N,*}^{(k)} \right) \right| \\ &\quad + \left| \text{Tr } J^{(k)} \left( \hat{\gamma}_{N,*}^{(k)} - \hat{\gamma}_N^{(k)} \right) \right|. \end{aligned} \quad (5.13)$$

The first term on the r.h.s. can be bounded by

$$\begin{aligned} \left| \text{Tr } J^{(k)} \left( \tilde{\gamma}_N^{(k)} - \tilde{\gamma}_{N,*}^{(k)} \right) \right| &\leq 2 \|J^{(k)}\| \left\| \frac{\chi \psi_N}{\|\chi \psi_N\|} - \frac{\chi \psi_{N,*}}{\|\chi \psi_{N,*}\|} \right\| \leq 4 \|J^{(k)}\| \frac{\|\chi(\psi_N - \psi_{N,*})\|}{\|\chi \psi_N\|} \\ &\leq \frac{4k \|J^{(k)}\|}{1 - C\kappa^{1/2}} \|\varphi - \varphi^*\| \leq \varepsilon/3 \end{aligned} \quad (5.14)$$

uniformly in  $\kappa$ , for  $\kappa$  small enough (recall that  $\chi = \chi(\kappa H_N/N)$ ). Here we used (5.7),  $\|\chi(\kappa H_N/N)\| \leq 1$ ,  $\|\varphi\| = \|\varphi^*\| = 1$ , and the choice  $\|\varphi - \varphi^*\| \leq \varepsilon/(24k\|J^{(k)}\|)$ . Analogously, the third term on the r.h.s. of (5.13) is bounded by

$$\left| \text{Tr } J^{(k)} \left( \hat{\gamma}_{N,*}^{(k)} - \hat{\gamma}_N^{(k)} \right) \right| = \left| \text{Tr } J^{(k)} \left( |\varphi^*\rangle\langle\varphi^*|^{\otimes k} - |\varphi\rangle\langle\varphi|^{\otimes k} \right) \right| \leq 2k \|J^{(k)}\| \|\varphi - \varphi^*\| \leq \varepsilon/3. \quad (5.15)$$

It remains to bound the second term on the r.h.s. of (5.13). To this end, we note that

$$\begin{aligned} \left| \text{Tr } J^{(k)} \left( \tilde{\gamma}_{N,*}^{(k)} - \hat{\gamma}_{N,*}^{(k)} \right) \right| &\leq 2 \|J^{(k)}\| \left\| \frac{\chi \psi_{N,*}}{\|\chi \psi_{N,*}\|} - \frac{\hat{\chi} \psi_{N,*}}{\|\hat{\chi} \psi_{N,*}\|} \right\| \\ &\leq 4 \|J^{(k)}\| \frac{\|(\chi - \hat{\chi})\psi_{N,*}\|}{\|\chi \psi_{N,*}\|} \leq \frac{4\|J^{(k)}\|}{1 - C\kappa^{1/2}} \|(\chi - \hat{\chi})\psi_{N,*}\| \end{aligned} \quad (5.16)$$

where we used (5.7). To estimate the last norm we expand the function  $\chi$  using the Helffer-Sjöstrand functional calculus (see, for example, [6]). Let  $\tilde{\chi}$  be an almost analytic extension of the smooth function  $\chi$  of order two (that is  $|\partial_{\bar{z}}\tilde{\chi}(z)| \leq C|y|^2$ , for  $y = \text{Im}z$  near zero): for example we can take  $\tilde{\chi}(z = x + iy) := (\chi(x) + iy\chi'(x) + \chi''(x)(iy)^2/2)\theta(x, y)$ , where  $\theta \in C_0^\infty(\mathbb{R}^2)$  and  $\theta(x, y) = 1$  for  $z = x + iy$  in some complex neighborhood of the support of  $\chi$ . Then

$$\begin{aligned} (\chi - \hat{\chi})\psi_{N,*} &= -\frac{1}{\pi} \int dx dy \partial_{\bar{z}}\tilde{\chi}(z) \left( \frac{1}{z - (\kappa H_N/N)} - \frac{1}{z - (\kappa \hat{H}_N/N)} \right) \psi_{N,*} \\ &= -\frac{\kappa}{N\pi} \int dx dy \partial_{\bar{z}}\tilde{\chi}(z) \frac{1}{z - (\kappa H_N/N)} (H_N - \hat{H}_N) \frac{1}{z - (\kappa \hat{H}_N/N)} \psi_{N,*}. \end{aligned} \quad (5.17)$$

Taking the norm we obtain

$$\|(\chi - \hat{\chi})\psi_{N,*}\| \leq \frac{C\kappa}{N} \int dx dy \frac{|\partial_{\bar{z}}\tilde{\chi}(z)|}{|y|} \left\| (H_N - \hat{H}_N) \frac{1}{z - (\kappa \hat{H}_N/N)} \psi_{N,*} \right\|. \quad (5.18)$$

Next we note that

$$H_N - \hat{H}_N = -\sum_{j=1}^k \Delta_j + \frac{1}{N} \sum_{i \leq k, i < j \leq N} V_N(x_i - x_j).$$

Therefore, using the symmetry of  $\psi_{N,*}$  and of  $\hat{H}_N$  w.r.t. permutations of the first  $k$  and the last  $N - k$  particles, we obtain

$$\begin{aligned} \left\| (H_N - \hat{H}_N) \frac{1}{z - (\kappa \hat{H}_N/N)} \psi_{N,*} \right\| &\leq k \left\| \Delta_1 \frac{1}{z - (\kappa \hat{H}_N/N)} \psi_{N,*} \right\| \\ &\quad + \frac{k^2}{N} \left\| V_N(x_1 - x_2) \frac{1}{z - (\kappa \hat{H}_N/N)} \psi_{N,*} \right\| \\ &\quad + \frac{k(N-k)}{N} \left\| V_N(x_1 - x_{k+1}) \frac{1}{z - (\kappa \hat{H}_N/N)} \psi_{N,*} \right\|. \end{aligned} \quad (5.19)$$

Using Lemma A.3, we can bound

$$\left\| V_N(x_1 - x_j) \frac{1}{z - (\kappa \widehat{H}_N/N)} \psi_{N,*} \right\| \leq (\text{const.}) N^{3\beta/2} \|V^2\|_{L^1} \left\| (1 - \Delta_1) \frac{1}{z - (\kappa \widehat{H}_N/N)} \psi_{N,*} \right\|. \quad (5.20)$$

Since  $\widehat{H}_N$  does not depend on the variable  $x_1$ , we can commute the derivatives with respect to  $x_1$  through the resolvent  $(z - (\kappa \widehat{H}_N/N))^{-1}$  and we conclude that

$$\left\| (H_N - \widehat{H}_N) \frac{1}{z - (\kappa \widehat{H}_N/N)} \psi_{N,*} \right\| \leq \frac{CN^{3\beta/2}}{|y|} \|\varphi^*\|_{H^2} \quad (5.21)$$

for a constant  $C$  which depends on  $k$ , but is independent of  $N$  and  $\kappa$ . Inserting this bound into (5.18) we obtain  $\|(\chi - \widehat{\chi})\psi_{N,*}\| \leq CN^{3\beta/2-1}$  and thus, since we assumed  $\beta < 2/3$ , we have, by (5.16),

$$\left| \text{Tr } J^{(k)} \left( \widetilde{\gamma}_{N,*}^{(k)} - \widehat{\gamma}_{N,*}^{(k)} \right) \right| \leq \varepsilon/3 \quad (5.22)$$

for  $N$  sufficiently large (uniformly in  $\kappa$ ). Together with (5.14) and (5.15), this completes the proof of part iii).  $\square$

## 6 A-Priori Estimate

The aim of this section is to prove an a-priori bound for the solution  $\psi_{N,t}^\kappa$  of the Schrödinger equation (1.3) with initial data  $\psi_N^\kappa$  (as defined in Proposition 5.1). Introduce the operator

$$S_j := (1 - \Delta_j)^{1/2}.$$

The a-priori bound is an estimate of the form

$$(\psi_{N,t}^\kappa, (1 - \Delta_1) \dots (1 - \Delta_k) \psi_{N,t}^\kappa) = \int dx |(1 - \Delta_1)^{1/2} \dots (1 - \Delta_k)^{1/2} \psi_{N,t}^\kappa|^2 \leq \widetilde{C}^k \quad (6.1)$$

for all  $k \geq 1$ , uniformly in  $t \in \mathbb{R}$  and in  $N$ , for  $N$  large enough (the constant  $\widetilde{C}$  depends on  $\kappa$ , but is independent of  $N$ ,  $t$  and  $k$ ). With density matrix notation, 6.1 is equivalent to

$$\text{Tr } S_1 S_2 \dots S_k \widetilde{\gamma}_{N,t}^{(k)} S_k \dots S_2 S_1 \leq \widetilde{C}^k.$$

To prove (6.1), we make use of the following energy estimate, which gives an upper bound on the mixed derivative operator in terms of higher powers of the Hamiltonian  $H_N$ .

**Proposition 6.1** (Energy Estimate). *Let  $H_N$  be defined as in (1.2), with  $V$  smooth and positive, and with  $0 < \beta < 3/5$ . Define*

$$\bar{H}_N := \sum_{j=1}^N S_j^2 + \frac{1}{N} \sum_{\ell \neq m} V_N(x_\ell - x_m) = H_N + N.$$

Fix  $k \in \mathbb{N}$  and  $0 < C < 1$ . Then there is  $N_0 = N_0(k)$  such that

$$(\psi, S_1^2 S_2^2 \dots S_k^2 \psi) \leq \frac{2^k}{N^k} (\psi, \bar{H}_N^k \psi) \quad (6.2)$$

for all  $N > N_0$  and all  $\psi \in L_s^2(\mathbb{R}^{3N})$  (the subspace of  $L^2(\mathbb{R}^{3N})$  containing all permutation symmetric functions).

*Proof.* The proof of this proposition can be found in [7]. The constant 2 could be replaced by any constant bigger than 1 at the expense of increasing  $N_0$ .  $\square$

Using this energy estimate, the conservation of the energy along the time evolution, and the fact that at time zero,  $(\psi_N^\kappa, H_N^k \psi_N^\kappa) \leq \tilde{C}^k N^k$  by the choice of  $\psi_N^\kappa$  (see Proposition 5.1), we obtain, in the next theorem, the bound (6.1).

**Theorem 6.2** (A-Priori Estimate). *Let  $H_N$  be defined as in (1.2), with  $V$  smooth and positive and with  $0 < \beta < 3/5$ . Fix  $\varphi \in H^1(\mathbb{R}^3)$  with  $\|\varphi\| = 1$  and  $\kappa > 0$  sufficiently small,  $\kappa \leq \kappa_0(\|\varphi\|_{H^1}, V)$ . Let  $\psi_N(\mathbf{x}) = \prod_{j=1}^N \varphi(x_j)$  and  $\psi_N^\kappa = \chi(\kappa H_N/N) \psi_N / \|\chi(\kappa H_N/N) \psi_N\|$ . Suppose that  $\psi_{N,t}^\kappa$  is the solution of the Schrödinger equation (1.3) with initial data  $\psi_N^\kappa$ . Then, for every  $k \geq 1$ , there exists  $N_0 = N_0(k)$ , with*

$$(\psi_{N,t}^\kappa, S_1^2 S_2^2 \dots S_k^2 \psi_{N,t}^\kappa) \leq \tilde{C}^k \quad (6.3)$$

for all  $N \geq N_0$ , and for all  $t \in \mathbb{R}$ . The constant  $\tilde{C}$  depends on the unscaled potential  $V(x)$ , on the  $H^1$ -norm of  $\varphi$ , and on the cutoff  $\kappa > 0$  (actually,  $\tilde{C}$  is proportional to  $1/\kappa$  for small  $\kappa$ ), but it is independent of  $t \in \mathbb{R}$ ,  $N$  and  $k$ . If we denote by  $\tilde{\gamma}_{N,t}^{(k)}$  the marginal densities associated with the wave function  $\psi_{N,t}^\kappa$ , then (6.3) is equivalent to the bound

$$\text{Tr} |S_1 \dots S_k \tilde{\gamma}_{N,t}^{(k)} S_k \dots S_1| \leq \tilde{C}^k \quad (6.4)$$

for all  $N \geq N_0$ .

*Proof.* For fixed  $k \geq 1$ , using  $\bar{H}_N^k \leq 2^k (H_N^k + N^k)$ , it follows from Proposition 6.1 that

$$(\psi_{N,t}^\kappa, S_1^2 \dots S_k^2 \psi_{N,t}^\kappa) \leq \frac{4^k}{N^k} (\psi_{N,t}^\kappa, H_N^k \psi_{N,t}^\kappa) + 2^k \|\psi_{N,t}^\kappa\|^2 = \frac{4^k}{N^k} (\psi_N^\kappa, H_N^k \psi_N^\kappa) + 2^k \quad (6.5)$$

for all  $N \geq N_0(k)$ . Here we used that the energy and the  $L^2$ -norm are conserved along the time evolution. From Proposition 5.1, we obtain

$$(\psi_{N,t}^\kappa, S_1^2 \dots S_k^2 \psi_{N,t}^\kappa) \leq \frac{8^k}{\kappa^k} \frac{1}{1 - C\kappa^{1/2}} + 2^k \quad (6.6)$$

which completes the proof of the theorem (assuming that  $0 < \kappa < 1/C^2$ ).  $\square$

## 7 Compactness of $\tilde{\gamma}_{N,t}^{(k)}$

In this section we keep the cutoff  $\kappa > 0$  fixed. We prove that, for fixed  $k \geq 1$ ,  $\tilde{\gamma}_{N,t}^{(k)}$  defines a compact sequence in  $C([0, T], \mathcal{H}_k)$  (recall that  $\tilde{\gamma}_{N,t}^{(k)}$  is the  $k$ -particle marginal density associated with the wave function  $\psi_{N,t}^\kappa$ ). To establish this result we prove the equicontinuity of  $\tilde{\gamma}_{N,t}^{(k)}$  in  $t \in [0, T]$ , and then we apply the Arzela-Ascoli theorem. To prove the equicontinuity of  $\tilde{\gamma}_{N,t}^{(k)}$  we use a simple criterium, stated at the end of this section, in Lemma 7.2.

**Theorem 7.1.** *Fix  $k \geq 1$ ,  $T \geq 0$ , and  $\kappa > 0$  small enough. Let  $\tilde{\gamma}_{N,t}^{(k)}$  be the  $k$ -particle marginal distribution associated with the solution  $\psi_{N,t}^\kappa$  of the Schrödinger equation (1.3), with regularized initial data  $\psi_N^\kappa$  (see Proposition 5.1 for the definition of  $\psi_N^\kappa$ ). Then we have  $\tilde{\gamma}_{N,t}^{(k)} \in C([0, T], \mathcal{H}_k)$  for all  $N \geq N(k, \kappa)$  large enough. Moreover, the sequence  $\tilde{\gamma}_{N,t}^{(k)}$  is compact in  $C([0, T], \mathcal{H}_k)$ . If*

$\tilde{\gamma}_{\infty,t}^{(k)} \in C([0,T], \mathcal{H}_k)$  is an arbitrary limit point of  $\tilde{\gamma}_{N,t}^{(k)}$ , then  $\tilde{\gamma}_{\infty,t}^{(k)}$  is non-negative, symmetric with respect to permutations (in the sense (1.8)) and satisfies

$$\|\tilde{\gamma}_{\infty,t}^{(k)}\|_{\mathcal{H}_k} = \text{Tr} |S_1 \dots S_k \tilde{\gamma}_{\infty,t}^{(k)} S_k \dots S_1| \leq \tilde{C}^k \quad (7.1)$$

for all  $t \in [0,T]$  and  $k \geq 1$  (the constant  $C$  is the same as in (6.4), and depends on the unscaled potential  $V(x)$ , on the  $H^1$  norm of  $\varphi$  and on the cutoff  $\kappa > 0$ , but it is independent of  $k$ ).

*Proof.* We prove that the sequence  $\tilde{\gamma}_{N,t}^{(k)}$  is equicontinuous in  $t$ , for  $t \in [0,T]$ . To this end we define the following dense subset of  $\mathcal{A}_k$ :

$$\mathcal{J}_k := \{J^{(k)} \in \mathcal{K}_k : \|S_i S_j J^{(k)} S_i^{-1} S_j^{-1}\| < \infty, 1 \leq i < j \leq k\}.$$

We will prove that there exists a threshold  $N(k, \kappa)$  such that for every  $\varepsilon > 0$  and for every  $J^{(k)} \in \mathcal{J}_k$  there exists  $\delta > 0$  such that

$$\sup_{N \geq N(k, \kappa)} \left| \text{Tr} J^{(k)} \left( \tilde{\gamma}_{N,t}^{(k)} - \tilde{\gamma}_{N,s}^{(k)} \right) \right| \leq \varepsilon \quad (7.2)$$

for all  $t, s \in [0,T]$  with  $|t - s| \leq \delta$ . Combining this with Lemma 7.2 below, we will obtain the equicontinuity.

In order to prove (7.2), we use the BBGKY hierarchy (2.1), rewritten in the integral form

$$\begin{aligned} \tilde{\gamma}_{N,t}^{(k)} - \tilde{\gamma}_{N,s}^{(k)} &= -i \sum_{j=1}^t \int_s^t d\tau [-\Delta_j, \tilde{\gamma}_{N,\tau}^{(k)}] - \frac{i}{N} \sum_{i < j}^k \int_s^t d\tau [V_N(x_i - x_j), \tilde{\gamma}_{N,\tau}^{(k)}] \\ &\quad - i \left(1 - \frac{k}{N}\right) \sum_{j=1}^k \int_s^t d\tau \text{Tr}_{k+1} [V_N(x_j - x_{k+1}), \tilde{\gamma}_{N,\tau}^{(k+1)}] \end{aligned} \quad (7.3)$$

where we recall the notation  $V_N(x) = N^{3\beta} V(N^\beta x)$ . Multiplying last equation with  $J^{(k)}$  and taking the trace we get the bound

$$\begin{aligned} \left| \text{Tr} J^{(k)} \left( \tilde{\gamma}_{N,t}^{(k)} - \tilde{\gamma}_{N,s}^{(k)} \right) \right| &\leq \sum_{j=1}^k \int_s^t d\tau \left| \text{Tr} \left( S_j^{-1} J^{(k)} S_j - S_j J^{(k)} S_j^{-1} \right) S_j \tilde{\gamma}_{N,\tau}^{(k)} S_j \right| \\ &\quad + \frac{1}{N} \sum_{i < j}^k \int_s^t d\tau \left| \text{Tr} \left( S_i^{-1} S_j^{-1} J^{(k)} S_i S_j S_i^{-1} S_j^{-1} V_N(x_i - x_j) S_i^{-1} S_j^{-1} S_i S_j \tilde{\gamma}_{N,\tau} S_i S_j \right. \right. \\ &\quad \left. \left. - S_i S_j J^{(k)} S_i^{-1} S_j^{-1} S_i S_j \tilde{\gamma}_{N,\tau} S_i S_j S_i^{-1} S_j^{-1} V_N(x_i - x_j) S_i^{-1} S_j^{-1} \right) \right| \\ &\quad + \left(1 - \frac{k}{N}\right) \sum_{j=1}^k \int_s^t d\tau \left| \text{Tr} \left( S_j^{-1} J^{(k)} S_j S_j^{-1} S_{k+1}^{-1} V_N(x_j - x_{k+1}) S_{k+1}^{-1} S_j^{-1} S_{k+1} S_j \tilde{\gamma}_{N,\tau}^{(k+1)} S_j S_{k+1} \right. \right. \\ &\quad \left. \left. - S_j J^{(k)} S_j^{-1} S_j S_{k+1} \tilde{\gamma}_{N,\tau}^{(k+1)} S_{k+1} S_j S_j^{-1} S_{k+1}^{-1} V_N(x_j - x_{k+1}) S_{k+1}^{-1} S_j^{-1} \right) \right| \end{aligned} \quad (7.4)$$

using that  $S_{k+1}$  commutes with  $J^{(k)}$ . Using that  $\|S_i^{-1} S_j^{-1} V_N(x_i - x_j) S_i^{-1} S_j^{-1}\|$  is finite, uniformly in  $N$  (see Lemma A.3), and the assumption that  $S_i S_j J^{(k)} S_i^{-1} S_j^{-1}$  is bounded, for every  $i, j \leq k$ , we

find

$$\begin{aligned}
\left| \text{Tr } J^{(k)} \left( \tilde{\gamma}_{N,t}^{(k)} - \tilde{\gamma}_{N,s}^{(k)} \right) \right| &\leq 2k|t-s| \sup_{j \leq k} \|S_j^{-1} J^{(k)} S_j\| \sup_{j \leq k, \tau \in [s,t]} \text{Tr } |S_j \tilde{\gamma}_{N,\tau}^{(k)} S_j| \\
&\quad + k^2 N^{-1} |t-s| \sup_{i,j \leq k} \|S_i S_j J^{(k)} S_i^{-1} S_j^{-1}\| \sup_{i < j \leq k, \tau \in [s,t]} \text{Tr } |S_i S_j \tilde{\gamma}_{N,\tau}^{(k)} S_j S_i| \\
&\quad + 2k \left(1 - \frac{k}{N}\right) \sup_{j \leq k} \|S_j^{-1} J^{(k)} S_j\| \sup_{j \leq k, \tau \in [s,t]} \text{Tr } |S_j S_{k+1} \tilde{\gamma}_{N,\tau}^{(k+1)} S_{k+1} S_j|
\end{aligned} \tag{7.5}$$

and thus, by Theorem 6.2,

$$\left| \text{Tr } J^{(k)} \left( \tilde{\gamma}_{N,t}^{(k)} - \tilde{\gamma}_{N,s}^{(k)} \right) \right| \leq C_k |t-s| \tag{7.6}$$

for a constant  $C_k$  depending on  $k$  and  $J^{(k)}$  (but independent of  $t, s$  and  $N$ ) and for all  $N$  large enough (depending on  $k$  and on the cutoff  $\kappa > 0$ ). This implies (7.2) and, by Lemma 7.2, it implies that the sequence  $\tilde{\gamma}_{N,t}^{(k)} \in C([0, T], \mathcal{H}_k)$  is equicontinuous in  $t$  (with respect to the metric  $\rho_k$  defined on  $\mathcal{H}_k$ ). Since moreover the sequence  $\tilde{\gamma}_{N,t}^{(k)}$  is uniformly bounded in  $\mathcal{H}_k$  (for  $N$  sufficiently large, by Theorem 6.2: note that here  $\kappa > 0$  is fixed), it follows by the Arzela-Ascoli Theorem that it is compact.

To prove that an arbitrary limit point  $\tilde{\gamma}_{\infty,t}^{(k)}$  of the non-negative sequence  $\tilde{\gamma}_{N,t}^{(k)}$  is also non-negative, we observe that, for an arbitrary  $\varphi \in L^2(\mathbb{R}^{3k})$  with  $\|\varphi\| = 1$ , the orthogonal projection  $P_\varphi = |\varphi\rangle\langle\varphi|$  is in  $\mathcal{A}_k$  and therefore we have

$$\langle \varphi, \tilde{\gamma}_{\infty,t}^{(k)} \varphi \rangle = \text{Tr } P_\varphi \tilde{\gamma}_{\infty,t}^{(k)} = \lim_{j \rightarrow \infty} \text{Tr } P_\varphi \tilde{\gamma}_{N_j,t}^{(k)} = \lim_{j \rightarrow \infty} \langle \varphi, \tilde{\gamma}_{N_j,t}^{(k)} \varphi \rangle \geq 0, \tag{7.7}$$

for an appropriate subsequence  $N_j$  with  $N_j \rightarrow \infty$  as  $j \rightarrow \infty$ . Similarly, the symmetry of  $\tilde{\gamma}_{\infty,t}^{(k)}$  w.r.t. permutations is inherited from the symmetry of  $\tilde{\gamma}_{N,t}^{(k)}$  for finite  $N$ . In fact, for an arbitrary  $J^{(k)} \in \mathcal{A}_k$  and a permutation  $\pi \in \mathcal{S}_k$ , we have

$$\begin{aligned}
\text{Tr } J^{(k)} \tilde{\gamma}_{\infty,t}^{(k)} &= \lim_{j \rightarrow \infty} \text{Tr } J^{(k)} \tilde{\gamma}_{N_j,t}^{(k)} = \lim_{j \rightarrow \infty} \text{Tr } J^{(k)} \Theta_\pi \tilde{\gamma}_{N_j,t}^{(k)} \Theta_{\pi^{-1}} = \lim_{j \rightarrow \infty} \text{Tr } \Theta_{\pi^{-1}} J^{(k)} \Theta_\pi \tilde{\gamma}_{N_j,t}^{(k)} \\
&= \text{Tr } \Theta_{\pi^{-1}} J^{(k)} \Theta_\pi \tilde{\gamma}_{\infty,t}^{(k)} = \text{Tr } J^{(k)} \Theta_\pi \tilde{\gamma}_{\infty,t}^{(k)} \Theta_{\pi^{-1}}
\end{aligned} \tag{7.8}$$

where we used that, since  $J^{(k)} \in \mathcal{A}_k$ , also  $\Theta_{\pi^{-1}} J^{(k)} \Theta_\pi \in \mathcal{A}_k$ , because

$$\begin{aligned}
\|\Theta_{\pi^{-1}} J^{(k)} \Theta_\pi\|_{\mathcal{A}_k} &= \|S_1^{-1} \dots S_k^{-1} \Theta_{\pi^{-1}} J^{(k)} \Theta_\pi S_k^{-1} \dots S_1^{-1}\| \\
&= \|\Theta_{\pi^{-1}} S_1^{-1} \dots S_k^{-1} J^{(k)} S_k^{-1} \dots S_1^{-1} \Theta_{\pi^{-1}}\| \\
&= \|S_1^{-1} \dots S_k^{-1} J^{(k)} S_k^{-1} \dots S_1^{-1}\| = \|J^{(k)}\|_{\mathcal{A}_k}.
\end{aligned} \tag{7.9}$$

Finally, the bound (7.1) follows because in the weak limit the norm can only decrease.  $\square$

**Lemma 7.2.** *Fix  $k$ . A sequence of time-dependent density matrices  $\gamma_{N,t}^{(k)}$ ,  $N = 1, 2, \dots$ , defined for  $t \in [0, T]$  and satisfying*

$$\sup_{N \geq 1} \sup_{t \in [0, T]} \|\gamma_{N,t}^{(k)}\|_{\mathcal{H}_k} \leq C, \tag{7.10}$$

*is equicontinuous in  $C([0, T], \mathcal{H}_k)$  with respect to the metric  $\rho_k$  (defined in (3.3)), if and only if there exists a dense subset  $\mathcal{J}_k$  of  $\mathcal{A}_k$  such that for any  $J^{(k)} \in \mathcal{J}_k$  and for every  $\varepsilon > 0$  there exists a  $\delta > 0$  such that*

$$\sup_{N \geq 1} \left| \text{Tr } J^{(k)} \left( \gamma_{N,t}^{(k)} - \gamma_{N,s}^{(k)} \right) \right| \leq \varepsilon \tag{7.11}$$

*for all  $t, s \in [0, T]$  with  $|t-s| \leq \delta$ .*



*Proof.* The proof of this lemma is similar to the proof of Lemma 9.2 in [9]; the main difference is that here we keep  $k$  fixed, while in [9] we considered equicontinuity in the direct sum  $C([0, T], \mathcal{H}) = \bigoplus_{k \geq 1} C([0, T], \mathcal{H}_k)$  over all  $k \geq 1$ .  $\square$

## 8 Convergence to solutions of the Gross-Pitaevskii hierarchy

From Theorem 7.1 and from the Cantor diagonalization argument explained in Step 2 of the proof of Theorem 1.1, we know that the the sequence  $\tilde{\Gamma}_{N,t} = \{\tilde{\gamma}_{N,t}^{(k)}\}_{k=1}^N$  has at least one limit point  $\tilde{\Gamma}_{\infty,t} = \{\tilde{\gamma}_{\infty,t}^{(k)}\}_{k \geq 1}$  in  $C([0, T], \mathcal{H})$  with respect to the  $\tau$ -topology. In the next theorem, we show that any such limit point is a solution of the infinite Gross-Pitaevskii hierarchy (2.2) in the integral form (4.4). The analogous theorem from [7] cannot be directly applied since here we work in  $\mathbb{R}^3$  in contrast to the compact configuration space of [7]. Moreover, the infinite hierarchy (4.4) is defined somewhat differently than (1.8) from [7].

**Theorem 8.1.** *Assume  $H_N$  is defined as in (1.2), with  $0 < \beta < 1/2$ . For a fixed  $\kappa > 0$ , let  $\psi_{N,t}^\kappa$  be the solution of the Schrödinger equation (1.3), with initial data  $\psi_N^\kappa$  (defined as in Proposition 5.1), and let  $\tilde{\Gamma}_{N,t} = \{\tilde{\gamma}_{N,t}^{(k)}\}_{k=1}^N$  be the marginal densities associated with  $\psi_{N,t}^\kappa$ . Suppose  $\tilde{\Gamma}_{\infty,t} = \{\tilde{\gamma}_{\infty,t}^{(k)}\}_{k \geq 1} \in C([0, T], \mathcal{H})$  is a limit point of the sequence  $\tilde{\Gamma}_{N,t}$  with respect to the  $\tau$ -topology. Then  $\tilde{\Gamma}_{\infty,t}$  is a solution of the infinite hierarchy*

$$\tilde{\gamma}_{\infty,t}^{(k)} = \mathcal{U}_0^{(k)}(t) \tilde{\gamma}_{\infty,0}^{(k)} - ib_0 \sum_{j=1}^k \int_0^t ds \mathcal{U}_0^{(k)}(t-s) \text{Tr}_{k+1} [\delta(x_j - x_{k+1}), \tilde{\gamma}_{\infty,s}^{(k+1)}], \quad (8.1)$$

with initial data

$$\tilde{\gamma}_{\infty,t=0}^{(k)}(\mathbf{x}_k; \mathbf{x}'_k) = \gamma_0^{(k)} := \prod_{j=1}^k \varphi(x_j) \bar{\varphi}(x'_j), \quad (8.2)$$

for all  $k \geq 1$ .

The action of the delta-function in the second term on the r.h.s. of (8.1) is defined through a limiting procedure. We define the operator  $B^{(k)}$ , acting on densities  $\gamma^{(k+1)}$  with smooth kernel,  $\gamma^{(k+1)}(\mathbf{x}_{k+1}; \mathbf{x}'_{k+1}) \in \mathcal{S}(\mathbb{R}^{6(k+1)})$  by

$$B^{(k)} \gamma^{(k+1)} = -ib_0 \sum_{j=1}^k \text{Tr}_{k+1} [\delta(x_j - x_{k+1}), \gamma^{(k+1)}]. \quad (8.3)$$

If we interpret this definition formally for arbitrary density matrices, then the infinite hierarchy (8.1) can be rewritten in the more compact form

$$\tilde{\gamma}_{\infty,t}^{(k)} = \mathcal{U}_0^{(k)}(t) \tilde{\gamma}_{\infty,0}^{(k)} + \int_0^t ds \mathcal{U}_0^{(k)}(t-s) B^{(k)} \tilde{\gamma}_{\infty,s}^{(k+1)}. \quad (8.4)$$

The action of  $B^{(k)}$  on kernels is formally given by

$$(B^{(k)} \gamma^{(k+1)})(\mathbf{x}_k; \mathbf{x}'_k) = -ib_0 \sum_{j=1}^k \int dx_{k+1} (\delta(x_j - x_{k+1}) - \delta(x'_j - x_{k+1})) \gamma^{(k+1)}(\mathbf{x}_k, x_{k+1}; \mathbf{x}'_k, x_{k+1}). \quad (8.5)$$

For the more precise definition of  $B^{(k)}$ , we choose a positive smooth function  $h \in C^\infty(\mathbb{R}^3)$ , with compact support and such that  $\int dx h(x) = 1$ . For  $\alpha > 0$ , we put  $\delta_\alpha(x) = \alpha^{-3}h(\alpha^{-1}x)$ . Then, for  $\gamma^{(k+1)} \in \mathcal{H}_{k+1}$ , we put

$$\begin{aligned} \left( B^{(k)} \gamma^{(k+1)} \right) (\mathbf{x}_k; \mathbf{x}'_k) &:= -ib_0 \lim_{\alpha_1, \alpha_2 \rightarrow 0} \sum_{j=1}^k \int dx_{k+1} dx'_{k+1} \delta_{\alpha_2}(x_{k+1} - x'_{k+1}) \\ &\quad \times \left( \delta_{\alpha_1}(x_j - x_{k+1}) - \delta_{\alpha_1}(x'_j - x_{k+1}) \right) \gamma^{(k+1)}(\mathbf{x}_k, x_{k+1}; \mathbf{x}'_k, x'_{k+1}). \end{aligned} \quad (8.6)$$

Lemma 8.2 below will show that  $B^{(k)}$  is well defined for any  $\gamma^{(k+1)} \in \mathcal{H}_{k+1}$ . We introduce the norm

$$\|J^{(k)}\|_j := \sup_{\mathbf{x}_k, \mathbf{x}'_k} \langle x_1 \rangle^4 \dots \langle x_k \rangle^4 \langle x'_1 \rangle^4 \dots \langle x'_k \rangle^4 \left( |J^{(k)}(\mathbf{x}_k; \mathbf{x}'_k)| + |\nabla_{x_j} J^{(k)}(\mathbf{x}_k; \mathbf{x}'_k)| + |\nabla_{x'_j} J^{(k)}(\mathbf{x}_k; \mathbf{x}'_k)| \right) \quad (8.7)$$

for any  $j \leq k$  and for any function  $J^{(k)}(\mathbf{x}_k; \mathbf{x}'_k)$ .

**Lemma 8.2.** *Suppose that  $\delta_\alpha(x)$  is a function satisfying  $0 \leq \delta_\alpha(x) \leq C\alpha^{-3}\mathbf{1}(|x| \leq \alpha)$  and  $\int \delta_\alpha(x)dx = 1$  (for example  $\delta_\alpha(x) = \alpha^{-3}h(x/\alpha)$ , for a bounded probability density  $h(x)$  supported in  $\{x : |x| \leq 1\}$ ). Then if  $\gamma^{(k+1)}(\mathbf{x}_{k+1}; \mathbf{x}'_{k+1})$  is the kernel of a density matrix on  $L^2(\mathbb{R}^{3(k+1)})$ , we have, for any  $j \leq k$ ,*

$$\begin{aligned} &\left| \int d\mathbf{x}_{k+1} d\mathbf{x}'_{k+1} J^{(k)}(\mathbf{x}_k; \mathbf{x}'_k) \left( \delta_{\alpha_1}(x_{k+1} - x'_{k+1}) \delta_{\alpha_2}(x_j - x_{k+1}) - \delta_{\alpha_1}(x_{k+1} - x'_{k+1}) \delta_{\alpha_2}(x_j - x_{k+1}) \right) \right. \\ &\quad \left. \times \gamma^{(k+1)}(\mathbf{x}_{k+1}; \mathbf{x}'_{k+1}) \right| \\ &\leq (\text{const.})^k \|J^{(k)}\|_j (\alpha_1 + \sqrt{\alpha_2}) \text{Tr} |S_j S_{k+1} \gamma^{(k+1)} S_j S_{k+1}|. \end{aligned} \quad (8.8)$$

Recall here that  $S_\ell = (1 - \Delta_{x_\ell})^{1/2}$ . Exactly the same bound holds if  $x_j$  is replaced with  $x'_j$  in (8.8) by symmetry.

This lemma is similar to Proposition 8.1 in [9], with the difference that here we work in the infinite space  $\mathbb{R}^3$  instead of a compact set  $\Lambda$  as in [9]. For completeness we give a proof of Lemma 8.2 at the end of Appendix A.

It follows from this lemma that the limit (8.6) exists for  $\gamma^{(k+1)} \in \mathcal{H}_{k+1}$ , in an appropriate weak topology, and that it is independent of the choice of  $h \in C^\infty(\mathbb{R}^3)$ . Here, with a slight abuse of the notation,  $\mathcal{H}_{k+1}$  is used both for the space of densities defined in Section 3, and for the space of kernels associated with these densities. Hence the operator  $B^{(k)}$ , originally defined on Schwarz functions, can be extended to a bounded operator from the whole  $\mathcal{H}_{k+1}$  and with values in some sufficiently large Banach space determined by the conditions on the test function  $J^{(k)}$ . Moreover, the following bound holds

$$\left| \int d\mathbf{x}_k d\mathbf{x}'_k J^{(k)}(\mathbf{x}_k; \mathbf{x}'_k) \text{Tr}_{k+1} [\delta(x_j - x_{k+1}), \gamma^{(k+1)}] \right| \leq C^k \|J^{(k)}\|_j \text{Tr} |S_j S_{k+1} \gamma^{(k+1)} S_{k+1} S_j| \quad (8.9)$$

for each term in (8.3), therefore a similar bound holds for the operator  $B^{(k)}$  as well.

The equality in (8.4) is then interpreted in the sense that there exists a representation of

$$\int_0^t ds \mathcal{U}_0^{(k)}(t-s) B^{(k)} \gamma_{\infty, s}^{(k+1)}$$

which lies in  $\mathcal{H}_k$  and such that (8.4) holds. This follows from the fact that both  $\gamma_{\infty, t}^{(k)}$  and  $\mathcal{U}_0^{(k)}(t) \gamma_{\infty, 0}^{(k)}$  are in  $\mathcal{H}_k$  and the equality can be checked in a weak sense.

*Proof of Theorem 8.1.* Without loss of generality we can assume that  $\tilde{\Gamma}_{N,t}$  converges to  $\tilde{\Gamma}_{\infty,t}$  with respect to the  $\tau$ -topology. This implies that, for every fixed  $k \geq 1$  and  $t \in [0, T]$  we have

$$\tilde{\gamma}_{N,t}^{(k)} \rightarrow \tilde{\gamma}_{\infty,t}^{(k)}$$

with respect to the weak\* topology of  $\mathcal{H}_k$ . That is, for every  $J^{(k)} \in \mathcal{A}_k$  we have

$$\mathrm{Tr} J^{(k)} \left( \tilde{\gamma}_{N,t}^{(k)} - \tilde{\gamma}_{\infty,t}^{(k)} \right) \rightarrow 0 \quad (8.10)$$

for  $N \rightarrow \infty$ .

Let

$$\Omega_k := \prod_{j=1}^k (\langle x_j \rangle + S_j) \quad (\text{with } S_j = (1 - \Delta_{x_j})^{1/2}).$$

In the following we assume that the observable  $J^{(k)} \in \mathcal{K}_k \subset \mathcal{A}_k$  is such that

$$\left\| \Omega_k^7 J^{(k)} \Omega_k^7 \right\|_{\mathrm{HS}} < \infty, \quad (8.11)$$

where  $\|A\|_{\mathrm{HS}}$  denotes the Hilbert-Schmidt norm of the operator  $A$ , that is  $\|A\|_{\mathrm{HS}}^2 = \mathrm{Tr} A^* A$ . Note that the set of observables  $J^{(k)}$  satisfying the condition (8.11) is a dense subset of  $\mathcal{A}_k$ .

It is straightforward to check that

$$\|S_1 \dots S_k J^{(k)}\| < \left\| \Omega_k^7 J^{(k)} \Omega_k^7 \right\|_{\mathrm{HS}}, \quad \text{and} \quad \|J^{(k)} S_k \dots S_1\| < \left\| \Omega_k^7 J^{(k)} \Omega_k^7 \right\|_{\mathrm{HS}}. \quad (8.12)$$

Moreover, for any  $j \leq k$

$$\|J^{(k)}\|_j \leq (\text{const.})^k \left\| \Omega_k^7 J^{(k)} \Omega_k^7 \right\|_{\mathrm{HS}}, \quad (8.13)$$

where the norm  $\|\cdot\|_j$  is defined in (8.7). This follows from the standard Sobolev inequality  $\|f\|_{\infty} \leq (\text{const.}) \|f\|_{2,2}$  in three dimensions applied to each variable separately in the form

$$\begin{aligned} \left( \sup_{x,x'} \langle x \rangle^4 \langle x' \rangle^4 |\nabla_x J(x, x')| \right)^2 &\leq (\text{const.}) \int dx dx' \left| (1 - \Delta_x) \left[ \langle x \rangle^4 (\nabla_x J(x, x')) \langle x' \rangle^4 \right] \right|^2 \\ &\leq (\text{const.}) \mathrm{Tr} (1 - \Delta) \langle x \rangle^4 \nabla J \langle x \rangle^8 J^* \nabla^* \langle x \rangle^4 (1 - \Delta) \\ &\leq (\text{const.}) \mathrm{Tr} \Omega^7 J \Omega^{14} J^* \Omega^7 \end{aligned}$$

with  $\Omega = \langle x \rangle + (1 - \Delta)^{1/2}$ . Similar estimates are valid for each term in the definition of  $\|\cdot\|_j$ , for  $j \leq k$ . Here we commuted derivatives and the weights  $\langle x \rangle$ ; the commutators can be estimated using Schwarz inequalities.

Rewriting the BBGKY hierarchy (2.1) in integral form, and multiplying it with  $J^{(k)}$  we obtain

$$\begin{aligned} \mathrm{Tr}^{(k)} J^{(k)} \tilde{\gamma}_{N,t}^{(k)} &= \mathrm{Tr}^{(k)} J^{(k)} \mathcal{U}^{(k)}(t) \tilde{\gamma}_{N,0}^{(k)} \\ &\quad - i \left( 1 - \frac{k}{N} \right) \sum_{j=1}^k \int_0^t ds \mathrm{Tr}^{(k)} J^{(k)} \mathcal{U}^{(k)}(t-s) \mathrm{Tr}_{k+1} [V_N(x_j - x_{k+1}), \tilde{\gamma}_{N,s}^{(k+1)}] \end{aligned} \quad (8.14)$$

where we recall the notation  $V_N(x) = N^{3\beta} V(N^\beta x)$  and

$$\mathcal{U}^{(k)}(t) \gamma^{(k)} = e^{-iH_N^{(k)} t} \gamma^{(k)} e^{iH_N^{(k)} t} \quad (8.15)$$

with

$$H_N^{(k)} = - \sum_{j=1}^k \Delta_j + \frac{1}{N} \sum_{i < j}^k V_N(x_i - x_j).$$

Here we use the notation  $\text{Tr}^{(k)}$  instead of  $\text{Tr}$  to explicitly stress that we take the trace over the degrees of freedom of  $k$  particles.

The l.h.s. of (8.14) clearly converges, as  $N \rightarrow \infty$ , to  $\text{Tr}^{(k)} J^{(k)} \tilde{\gamma}_{\infty, t}^{(k)}$  (by (8.10) and because  $J^{(k)} \in \mathcal{K}_k \subset \mathcal{A}_k$  by assumption). As for the first term on the r.h.s. of (8.14) we have

$$\text{Tr}^{(k)} J^{(k)} \left( \mathcal{U}^{(k)}(t) \tilde{\gamma}_{N,0}^{(k)} - \mathcal{U}_0^{(k)}(t) \tilde{\gamma}_{\infty,0}^{(k)} \right) \rightarrow 0 \quad (8.16)$$

for  $N \rightarrow \infty$ . The definition of  $\mathcal{U}_0^{(k)}$  is recalled from (4.3). To prove (8.16) we note that

$$\begin{aligned} \text{Tr}^{(k)} J^{(k)} \left( \mathcal{U}^{(k)}(t) \tilde{\gamma}_{N,0}^{(k)} - \mathcal{U}_0^{(k)}(t) \tilde{\gamma}_{\infty,0}^{(k)} \right) &= \text{Tr}^{(k)} J^{(k)} \left( \mathcal{U}^{(k)}(t) - \mathcal{U}_0^{(k)}(t) \right) \tilde{\gamma}_{N,0}^{(k)} \\ &\quad + \text{Tr}^{(k)} J^{(k)} \mathcal{U}_0^{(k)}(t) \left( \tilde{\gamma}_{N,0}^{(k)} - \tilde{\gamma}_{\infty,0}^{(k)} \right). \end{aligned} \quad (8.17)$$

The second term converges to zero, for  $N \rightarrow \infty$ , because, if  $J^{(k)} \in \mathcal{A}_k$ , then also  $\mathcal{U}_0^{(k)}(-t)J^{(k)} \in \mathcal{A}_k$ , and hence

$$\text{Tr} J^{(k)} \mathcal{U}_0^{(k)}(t) \left( \tilde{\gamma}_{N,0}^{(k)} - \tilde{\gamma}_{\infty,0}^{(k)} \right) = \text{Tr} \left( \mathcal{U}_0^{(k)}(-t)J^{(k)} \right) \left( \tilde{\gamma}_{N,0}^{(k)} - \tilde{\gamma}_{\infty,0}^{(k)} \right) \rightarrow 0$$

as  $N \rightarrow \infty$ . As for the first term on the r.h.s. of (8.17) we have

$$\text{Tr}^{(k)} J^{(k)} \left( \mathcal{U}^{(k)}(t) - \mathcal{U}_0^{(k)}(t) \right) \tilde{\gamma}_{N,0}^{(k)} = \frac{-i}{N} \sum_{i < j}^k \int_0^t ds \text{Tr}^{(k)} J^{(k)} \mathcal{U}^{(k)}(t-s) V_N(x_i - x_j) \mathcal{U}_0^{(k)}(s) \tilde{\gamma}_{N,0}^{(k)}. \quad (8.18)$$

This implies that

$$\begin{aligned} \left| \text{Tr}^{(k)} J^{(k)} \left( \mathcal{U}^{(k)}(t) - \mathcal{U}_0^{(k)}(t) \right) \tilde{\gamma}_{N,0}^{(k)} \right| &\leq \frac{k^2 t \|J^{(k)}\|}{N} \sup_{i < j \leq k} \|V_N(x_i - x_j) S_i^{-1} S_j^{-1}\| \sup_{i < j \leq k} \text{Tr} |S_i S_j \tilde{\gamma}_{N,0}^{(k)}| \\ &\leq \frac{k^2 t \|J^{(k)}\|}{N^{1-(3\beta/2)}} \text{Tr} |S_1 S_2 \tilde{\gamma}_{N,0}^{(k)} S_2 S_1|, \end{aligned}$$

where we used  $\text{Tr} |S_i S_j \gamma| \leq \text{Tr} |S_i S_j \gamma S_j S_i|$ , the permutation symmetry of  $\tilde{\gamma}_{N,0}^{(k)}$  and the bound  $\|V_N(x_i - x_j) S_i^{-1} S_j^{-1}\| \leq CN^{3\beta/2}$  with a constant  $C$  that only depends on the unscaled potential  $V(x)$  (see Lemma A.3). Since  $\beta < 1/2 < 2/3$ , we get, from Theorem 6.2,

$$\left| \text{Tr}^{(k)} J^{(k)} \left( \mathcal{U}^{(k)}(t) - \mathcal{U}_0^{(k)}(t) \right) \tilde{\gamma}_{N,0}^{(k)} \right| \rightarrow 0 \quad (8.19)$$

as  $N \rightarrow \infty$ .

Next we consider the second term on the r.h.s. of (8.14). More precisely we prove that the difference

$$\begin{aligned} \left( 1 - \frac{k}{N} \right) \sum_{j=1}^k \int_0^t ds \text{Tr}^{(k)} J^{(k)} \mathcal{U}^{(k)}(t-s) \text{Tr}_{k+1} [V_N(x_j - x_{k+1}), \tilde{\gamma}_{N,s}^{(k+1)}] \\ - b_0 \sum_{j=1}^k \int_0^t ds \text{Tr}^{(k)} J^{(k)} \mathcal{U}_0^{(k)}(t-s) \text{Tr}_{k+1} [\delta(x_j - x_{k+1}), \tilde{\gamma}_{\infty,s}^{(k+1)}] \end{aligned} \quad (8.20)$$

converges to zero, as  $N \rightarrow \infty$ . To this end we write this difference as the following sum of four terms

$$\begin{aligned}
& -\frac{k}{N} \sum_{j=1}^k \int_0^t ds \operatorname{Tr}^{(k)} J^{(k)} \mathcal{U}^{(k)}(t-s) \operatorname{Tr}_{k+1} [V_N(x_j - x_{k+1}), \tilde{\gamma}_{N,s}^{(k+1)}] \\
& + \sum_{j=1}^k \int_0^t ds \operatorname{Tr}^{(k)} J^{(k)} \left( \mathcal{U}^{(k)}(t-s) - \mathcal{U}_0^{(k)}(t-s) \right) \operatorname{Tr}_{k+1} [V_N(x_j - x_{k+1}), \tilde{\gamma}_{N,s}^{(k+1)}] \\
& + \sum_{j=1}^k \int_0^t ds \operatorname{Tr}^{(k)} J^{(k)} \mathcal{U}_0^{(k)}(t-s) \operatorname{Tr}_{k+1} [(V_N(x_j - x_{k+1}) - b_0 \delta(x_j - x_{k+1})), \tilde{\gamma}_{N,s}^{(k+1)}] \\
& + b_0 \sum_{j=1}^k \int_0^t ds \operatorname{Tr}^{(k)} J^{(k)} \mathcal{U}_0^{(k)}(t-s) \operatorname{Tr}_{k+1} \left[ \delta(x_j - x_{k+1}), \left( \tilde{\gamma}_{N,s}^{(k+1)} - \tilde{\gamma}_{\infty,s}^{(k+1)} \right) \right]
\end{aligned} \tag{8.21}$$

and we prove that each one of these terms converges to zero when  $N \rightarrow \infty$ .

Using that  $S_{k+1}$  commutes with  $J^{(k)} \mathcal{U}^{(k)}$ , the first term can be bounded in absolute value by

$$\begin{aligned}
& \frac{k}{N} \sum_{j=1}^k \int_0^t ds \left| \operatorname{Tr}^{(k+1)} J^{(k)} \mathcal{U}^{(k)}(t-s) [S_{k+1}^{-1} V_N(x_j - x_{k+1}) S_{k+1}^{-1}, S_{k+1} \tilde{\gamma}_{N,s}^{(k+1)} S_{k+1}] \right| \\
& \leq \frac{2k^2 t \|J^{(k)}\|}{N} \|S_{k+1}^{-1} V_N(x_j - x_{k+1}) S_{k+1}^{-1}\| \sup_{s \in [0,t]} \operatorname{Tr} S_{k+1} \tilde{\gamma}_{N,s}^{(k+1)} S_{k+1} \leq \tilde{C} N^{-1+\beta} \rightarrow 0 \tag{8.22}
\end{aligned}$$

as  $N \rightarrow \infty$ . Here we used Theorem 6.2 and that  $\|S_{k+1}^{-1} V_N(x_j - x_{k+1}) S_{k+1}^{-1}\| \leq C N^\beta$ , for a constant  $C$  which only depends on the unscaled potential  $V(x)$  (by the second statement in Lemma A.3). The constant  $\tilde{C}$  on the r.h.s. also depends on the cutoff  $\kappa$ .

The second term in (8.21), can be rewritten as

$$\begin{aligned}
& \sum_{j=1}^k \int_0^t ds \operatorname{Tr}^{(k)} J^{(k)} \left( \mathcal{U}^{(k)}(t-s) - \mathcal{U}_0^{(k)}(t-s) \right) \operatorname{Tr}_{k+1} [V_N(x_j - x_{k+1}), \tilde{\gamma}_{N,s}^{(k+1)}] \\
& = -i N^{-1} \sum_{j=1}^k \sum_{\ell < m}^k \int_0^t ds \int_0^{t-s} d\tau \operatorname{Tr}^{(k+1)} J^{(k)} \mathcal{U}_0^{(k)}(t-s-\tau) \\
& \quad \times \left[ V_N(x_\ell - x_m), \mathcal{U}^{(k)}(\tau) \left[ V_N(x_j - x_{k+1}), \tilde{\gamma}_{N,s}^{(k+1)} \right] \right].
\end{aligned} \tag{8.23}$$

Expanding the two commutators, we find that the absolute value of the r.h.s. of the last equation can be estimated by

$$\begin{aligned}
& C N^{-1} \sum_{j=1}^k \sum_{\ell < m}^k \int_0^t ds \int_0^{t-s} d\tau \left( \|J^{(k)} S_\ell S_m\| + \|S_\ell S_m J^{(k)}\| \right) \|S_\ell^{-1} S_m^{-1} V_N(x_\ell - x_m)\| \\
& \quad \times \|S_{k+1}^{-1} V_N(x_j - x_{k+1}) S_{k+1}^{-1} S_j^{-1}\| \operatorname{Tr} |S_j S_{k+1} \tilde{\gamma}_{N,s}^{(k+1)} S_{k+1}|.
\end{aligned} \tag{8.24}$$

Notice that  $\|S_{k+1}^{-1} V_N(x_j - x_{k+1}) S_{k+1}^{-1} S_j^{-1}\| \leq C N^{\beta/2}$  using both inequalities from Lemma A.3 and a Schwarz estimate. Combining this with (8.12), with  $\|S_\ell^{-1} S_m^{-1} V_N(x_\ell - x_m)\| \leq C N^{3\beta/2}$  and

$$\operatorname{Tr} |S_j S_{k+1} \tilde{\gamma}_{N,s}^{(k+1)} S_{k+1}| \leq \operatorname{Tr} S_1 S_2 \tilde{\gamma}_{N,s}^{(k+1)} S_2 S_1 \tag{8.25}$$

for all  $j = 1, \dots, k$ , by the symmetry of  $\tilde{\gamma}_{N,s}^{(k+1)}$ , we find

$$\left| \sum_{j=1}^k \int_0^t ds \operatorname{Tr}^{(k)} J^{(k)} \left( \mathcal{U}^{(k)}(t-s) - \mathcal{U}_0^{(k)}(t-s) \right) \operatorname{Tr}_{k+1} [V_N(x_j - x_{k+1}), \tilde{\gamma}_{N,s}^{(k+1)}] \right| \leq \tilde{C} N^{-1+2\beta} \quad (8.26)$$

which converges to zero, as  $N \rightarrow \infty$ , for  $\beta < 1/2$ . We remark that this is the only step where the more restrictive  $\beta < 1/2$  condition is used, the rest of the proof works for  $\beta < 3/5$ .

Next we consider the third term in (8.21). Using the kernel representation of  $\gamma_{N,s}^{(k+1)}$ , the absolute value of this term can be estimated by Lemma 8.2 (with  $\alpha_1 = 0$  and  $\alpha_2 = N^{-\beta}$ ) as

$$\begin{aligned} & b_0 \sum_{j=1}^k \int_0^t ds \left\{ \left| \int d\mathbf{x}_k d\mathbf{x}'_k dx_{k+1} \left( \mathcal{U}_0^{(k)}(s-t) J^{(k)} \right) (\mathbf{x}_k; \mathbf{x}'_k) \right. \right. \\ & \quad \times \left. \left( \frac{1}{b_0} V_N(x_j - x_{k+1}) - \delta(x_j - x_{k+1}) \right) \tilde{\gamma}_{N,s}^{(k+1)}(\mathbf{x}_k, x_{k+1}; \mathbf{x}'_k, x_{k+1}) \right| \\ & \quad + \left| \int d\mathbf{x}_k d\mathbf{x}'_k dx_{k+1} \left( \mathcal{U}_0^{(k)}(s-t) J^{(k)} \right) (\mathbf{x}_k; \mathbf{x}'_k) \right. \\ & \quad \times \left. \left( \frac{1}{b_0} V_N(x'_j - x_{k+1}) - \delta(x'_j - x_{k+1}) \right) \tilde{\gamma}_{N,s}^{(k+1)}(\mathbf{x}_k, x_{k+1}; \mathbf{x}'_k, x_{k+1}) \right| \left. \right\} \\ & \leq C N^{-\beta/2} \sup_{j \leq k, s \in [0, t]} \operatorname{Tr} |S_j S_{k+1} \tilde{\gamma}_{N,s}^{(k+1)} S_{k+1} S_j| \sum_{j=1}^k \int_0^t ds \|\mathcal{U}_0^{(k)}(s-t) J^{(k)}\|_j, \end{aligned} \quad (8.27)$$

for a constant  $C$  depending on  $k$ . Here we recall the definition of the norm  $\|\cdot\|_j$  from (8.7). Using the estimate (8.13), we have

$$\|\mathcal{U}_0^{(k)}(s-t) J^{(k)}\|_j \leq C \|\Omega_k^7 \mathcal{U}_0^{(k)}(s-t) J^{(k)} \Omega_k^7\|_{\text{HS}}$$

with a  $k$ -dependent constant  $C$ . Since  $e^{i(s-t)p_j^2} \langle x_j \rangle^m e^{-i(s-t)p_j^2} = \langle x_j + 2(s-t)p_j \rangle^m$ , for any  $j = 1, \dots, k$ ,  $m \in \mathbb{N}$ , with  $p_j = -i\nabla_j$ , we obtain that

$$\|\mathcal{U}_0^{(k)}(s-t) J^{(k)}\|_j \leq C(1 + |t-s|^7) \|\Omega_k^7 J^{(k)} \Omega_k^7\|_{\text{HS}}.$$

From the assumption (8.11) on  $J^{(k)}$  and the a-priori control on  $\tilde{\gamma}_{N,s}^{(k+1)}$ , we obtain that the r.h.s. of (8.27) is bounded by  $\tilde{C} N^{-\beta/2}$  with a constant  $\tilde{C}$  depending on  $k$ , on  $t$ , on  $J^{(k)}$ , and on the cutoff  $\kappa$ . Hence, the third term on the r.h.s. of (8.21) converges to zero, as  $N \rightarrow \infty$ .

Finally, we consider the fourth term in (8.21). For fixed  $s \in [0, t]$ , and  $j \leq k$  we have

$$\operatorname{Tr}^{(k+1)} J^{(k)} \mathcal{U}_0(t-s) \delta(x_j - x_{k+1}) \left( \tilde{\gamma}_{N,s}^{(k+1)} - \tilde{\gamma}_{\infty,s}^{(k+1)} \right) \rightarrow 0 \quad (8.28)$$

for  $N \rightarrow \infty$ , because  $J^{(k)} \mathcal{U}_0(t-s) \delta(x_j - x_{k+1}) \in \mathcal{A}_{k+1}$ . In fact

$$\begin{aligned} & \|S_1^{-1} \dots S_{k+1}^{-1} J^{(k)} \mathcal{U}_0(t-s) \delta(x_j - x_{k+1}) S_{k+1}^{-1} \dots S_1^{-1}\| \\ & \leq \|J^{(k)} S_j\| \|S_j^{-1} S_{k+1}^{-1} \delta(x_j - x_{k+1}) S_{k+1}^{-1} S_j^{-1}\| \end{aligned} \quad (8.29)$$

is finite. It follows that the integrand in the fourth term in (8.21) converges to zero, for every  $s \in [0, t]$ , and every  $j \leq k$ . Since the integrand is uniformly bounded using the uniform (in  $s$ ) a priori estimates on  $\tilde{\gamma}_{N,s}^{(k+1)}$  and  $\tilde{\gamma}_{\infty,s}^{(k+1)}$ , and the uniformity of the  $\mathcal{A}_{k+1}$ -norm of  $J^{(k)}\mathcal{U}_0(t-s)\delta(x_j - x_{k+1})$ , it follows that the fourth term converges to zero as well, for  $N \rightarrow \infty$ . This proves that, for every  $t \in [0, T]$ ,  $k \geq 1$  and  $J^{(k)} \in \mathcal{K}_k$  satisfying (8.11), we have

$$\begin{aligned} \mathrm{Tr}^{(k)} J^{(k)} \tilde{\gamma}_{\infty,t}^{(k)} &= \mathrm{Tr}^{(k)} J^{(k)} \mathcal{U}_0^{(k)}(t) \tilde{\gamma}_{\infty,0}^{(k)} \\ &\quad - ib_0 \sum_{j=1}^k \int_0^t ds \mathrm{Tr}^{(k)} J^{(k)} \mathcal{U}_0^{(k)}(t-s) \mathrm{Tr}_{k+1}[\delta(x_j - x_{k+1}), \tilde{\gamma}_{\infty,s}^{(k+1)}]. \end{aligned} \quad (8.30)$$

This implies that

$$\tilde{\gamma}_{\infty,t}^{(k)} = \mathcal{U}_0^{(k)}(t) \tilde{\gamma}_{\infty,0}^{(k)} - ib_0 \sum_{j=1}^k \int_0^t ds \mathcal{U}_0^{(k)}(t-s) \mathrm{Tr}_{k+1}[\delta(x_j - x_{k+1}), \tilde{\gamma}_{\infty,s}^{(k+1)}] \quad (8.31)$$

if we consider  $\tilde{\gamma}_{\infty,t}^{(k)}$  as elements of a large space of density matrices, the dual space of the Banach space consisting of all sufficiently smooth  $J^{(k)}$  (such that  $J^{(k)}$  satisfies (8.11)). Next since  $\tilde{\gamma}_{\infty,t}^{(k)} \in \mathcal{H}_k$  and  $\mathcal{U}_0^{(k)}(t) \tilde{\gamma}_{\infty,0}^{(k)} \in \mathcal{H}_k$ , it follows that also the second term on the r.h.s. of (8.31) lies in  $\mathcal{H}_k$  (or at least it has a representation as element of  $\mathcal{H}_k$ ), and that (8.31) holds as an equality on  $\mathcal{H}_k$ .

Finally we prove (8.2). For arbitrary  $N \geq k$  and  $J^{(k)} \in \mathcal{K}_k$ , we have

$$\mathrm{Tr} J^{(k)} \left( \tilde{\gamma}_{\infty,0}^{(k)} - \gamma_0^{(k)} \right) = \mathrm{Tr} J^{(k)} \left( \tilde{\gamma}_{\infty,0}^{(k)} - \tilde{\gamma}_{N,0}^{(k)} \right) + \mathrm{Tr} J^{(k)} \left( \tilde{\gamma}_{N,0}^{(k)} - \gamma_0^{(k)} \right). \quad (8.32)$$

From (8.10) (with  $t = 0$ ), the first term converges to zero, for  $N \rightarrow \infty$ . The second term converges to zero, as  $N \rightarrow \infty$ , by Proposition 5.1, part iii).  $\square$

## 9 Uniqueness of the infinite hierarchy

In this section we show the uniqueness of the solution of the infinite hierarchy (2.2). The following theorem is the main result of this section.

**Theorem 9.1.** *Fix  $T > 0$  and  $b_0 > 0$ . Suppose  $\Gamma_0 = \{\gamma_0^{(k)}\}_{k \geq 1}$  is such that  $\gamma_0^{(k)}$  is non-negative and symmetric with respect to permutations (in the sense of (1.8)) and it satisfies*

$$\|\gamma_0^{(k)}\|_{\mathcal{H}_k} = \mathrm{Tr} |S_1 \dots S_k \gamma_0^{(k)} S_k \dots S_1| \leq C^k \quad (9.1)$$

for all  $k \geq 1$  with some constant  $C$ . Then the infinite hierarchy

$$\gamma_t^{(k)} = \mathcal{U}_0^{(k)}(t) \gamma_0^{(k)} - ib_0 \sum_{j=1}^k \int_0^t ds \mathcal{U}_0^{(k)}(t-s) \mathrm{Tr}_{k+1} [\delta(x_j - x_{k+1}), \gamma_s^{(k+1)}], \quad (9.2)$$

has at most one solution  $\Gamma_t = \{\gamma_t^{(k)}\}_{k \geq 1} \in C([0, T], \mathcal{H})$  with  $\Gamma_{t=0} = \Gamma_0$ , such that  $\gamma_t^{(k)}$  is non-negative, symmetric with respect to permutations and satisfies the bound

$$\|\gamma_t^{(k)}\|_{\mathcal{H}_k} \leq C^k \quad (9.3)$$

for all  $k \geq 1$ , and  $t \in [0, T]$ .

*Remark:* In the proof we set  $b_0 = 1$  for convenience. The inclusion of  $b_0$  modifies all bounds in a trivial way, but it plays no role in the argument.

In order to prove this theorem, we will expand the solution in a Duhamel-type series. Recall from Section 8, the formal definition of the operator  $B^{(k)}$ , given by

$$B^{(k)}\gamma^{(k+1)} = -i \sum_{j=1}^k \text{Tr}_{k+1}[\delta(x_j - x_{k+1}), \gamma^{(k+1)}]. \quad (9.4)$$

On kernels in momentum space  $B^{(k)}$  acts according to

$$\begin{aligned} (B^{(k)}\gamma^{(k+1)})(\mathbf{p}_k; \mathbf{p}'_k) &= (-i) \sum_{j=1}^k \int dq_{k+1} dq'_{k+1} \left( \gamma^{(k+1)}(p_1, \dots, p_j - q_{k+1} + q'_{k+1}, \dots, p_k, q_{k+1}; \mathbf{p}'_k, q'_{k+1}) \right. \\ &\quad \left. - \gamma^{(k+1)}(\mathbf{p}_k, q_{k+1}; p'_1, \dots, p'_j + q_{k+1} - q'_{k+1}, \dots, p'_k, q'_{k+1}) \right) \\ &= (-i) \sum_{j=1}^k \int d\mathbf{q}_{k+1} d\mathbf{q}'_{k+1} \left( \prod_{\ell \neq j}^k \delta(p_\ell - q_\ell) \delta(p'_\ell - q'_\ell) \right) \gamma^{(k+1)}(\mathbf{q}_{k+1}; \mathbf{q}'_{k+1}) \\ &\quad \times [\delta(p'_j - q'_j) \delta(p_j - (q_j + q_{k+1} - q'_{k+1})) - \delta(p_j - q_j) \delta(p'_j - (q'_j + q'_{k+1} - q_{k+1}))]. \end{aligned} \quad (9.5)$$

These definitions are formal: they can be made precise using Lemma 8.2, as explained in Section 8. In the current paper we will work in momentum space, i.e. we apply (9.5) repeatedly and we will show that all integrals are absolute convergent.

With these notations we can expand the solution  $\{\gamma_t^{(k)}\}$  of (9.2) for any  $n \geq 1$  as

$$\begin{aligned} \gamma_t^{(k)} &= \mathcal{U}_0^{(k)}(t) \gamma_0^{(k)} + \sum_{m=1}^{n-1} \int_0^t ds_1 \int_0^{s_1} ds_2 \dots \int_0^{s_{m-1}} ds_m \\ &\quad \times \mathcal{U}_0^{(k)}(t - s_1) B^{(k)} \mathcal{U}_0^{(k+1)}(s_1 - s_2) B^{(k+1)} \dots B^{(k+m-1)} \mathcal{U}_0^{(k+m)}(s_m) \gamma_0^{(k+m)} \\ &+ \int_0^t ds_1 \int_0^{s_1} ds_2 \dots \int_0^{s_{n-1}} ds_n \\ &\quad \times \mathcal{U}_0^{(k)}(t - s_1) B^{(k)} \mathcal{U}_0^{(k+1)}(s_1 - s_2) B^{(k+1)} \dots \mathcal{U}_0^{(k+n-1)}(s_{n-1} - s_n) B^{(k+n-1)} \gamma_{s_n}^{(k+n)}. \end{aligned} \quad (9.6)$$

The terms in the summation will be called *fully expanded* as they contain only the initial data. The last error term involves the density matrix at an intermediate time  $s_n$ .

In Sections 9.1 and 9.2 below we show how the terms in this expansion can be written as a sum of contributions of suitable Feynman graphs. In Section 9.3, we show how to bound the contributions of the Feynman graphs. Then, in Section 9.6, we use these bounds to prove Theorem 9.1. Some technical estimates, used in Section 9.3 to bound the contributions of the Feynman graphs, are shown in Section 10.

*Notation.* For the rest of this paper we will mostly work in Fourier (momentum) space. We use the convention that variables  $p, q, r$  always refer to three dimensional Fourier variables, while  $x, y, z$  are reserved for configuration space variables. With this convention, the usual hat indicating the Fourier transform will be omitted. For example, the kernel of a two-particle density matrix  $\gamma_0^{(2)}$  in position space is  $\gamma_0^{(2)}(x_1, x_2; x'_1, x'_2)$ ; in momentum space it is given by the Fourier transform

$$\gamma_0^{(2)}(q_1, q_2; q'_1, q'_2) = \int dx_1 dx_2 dx'_1 dx'_2 \gamma_0^{(2)}(x_1, x_2; x'_1, x'_2) e^{-i(x_1 \cdot p_1 + x_2 \cdot p_2)} e^{i(x'_1 \cdot p'_1 + x'_2 \cdot p'_2)},$$



with the slight abuse of notation of omitting the hat on left hand side.

Furthermore, to avoid  $(2\pi)$ -factors in the Fourier transform, we make the convention that the integration measure for the three dimensional momentum variables  $p, q, r$  are always divided by  $(2\pi)^3$ , i.e.

$$dp := \frac{d_{\text{Leb}}p}{(2\pi)^3} \quad \text{for all three dimensional momentum variables}$$

where  $d_{\text{Leb}}$  denotes the usual Lebesgue measure. We will also use delta functions in momentum space,  $\delta(p)$ , and they will correspond to the measure  $dp$  above, i.e.

$$\int f(p)\delta(p-q)dp = f(q)$$

for smooth functions. Delta functions in position space,  $\delta(x)$ , remain subordinated to the usual Lebesgue measure.

Similar convention is used for the frequency variables (dual variables to the time) that will always be denoted by  $\alpha$ :

$$d\alpha := \frac{d_{\text{Leb}}\alpha}{2\pi} \quad \text{for all one dimensional frequency variables}$$

and to the delta functions involving  $\alpha$ -variables.

## 9.1 Graphs

Graphical representation is a convenient tool to bookkeep various terms in the perturbation expansion of many body systems; the graphs encode the collision histories of the particles in a concise form. We start by introducing *classical graphs*, which would appear in a diagrammatic expansion of the solution of the BBGKY hierarchy of a classical many particle system. Afterwards we will define *quantum graphs*, which are suitable for the diagrammatic representation of the expansion of a quantum system like (9.6). The quantum nature of the expansion requires a doubling of each edge of the classical graphs, corresponding to the fact that in the density matrix description each particle is associated with two different variables ( $x_j$  and  $x'_j$ ). In this paper we will only use the quantum graphs. Classical graphs are included only to facilitate the description of the quantum graphs and to derive a combinatorial estimate on their numbers.

### 9.1.1 Classical graphs

We consider rooted binary trees on  $n$  (internal) vertices and  $n+1$  leaves. The root and the leaves are not considered vertices; instead we identify them with the unique edge they are adjacent to. These edges are called *external* and we will use the terminology root and leaves for the external edges. For  $n=0$ , i.e. when there is no vertex, there is only one single edge, that is the root and the single leaf at the same time. However, when counting the external edges, we will count this edge twice. This tree will be called *trivial*. At every vertex three edges meet; the one that is closest to the root is called *father-edge*, the other two are called *son-edges* of this vertex. At every internal vertex we mark one of the son-edges. (In the expansion this son-edge will inherit the father's identity.) For illustration, one can draw such a graph so that the marked son-edge goes straight through, and the unmarked edge joins from below (see Fig. 1). The set of marked binary rooted trees of  $n$  vertices is denoted by  $\mathcal{G}_n$ .

Note that the number of marked binary trees with  $n$  vertices,  $C_n := |\mathcal{G}_n|$ , is given by the recursion

$$C_{n+1} = \sum_{k=0}^n C_k C_{n-k}, \quad C_0 = 1.$$

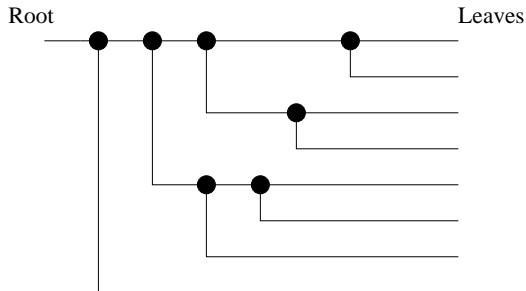

Figure 1: Example of a rooted, marked, binary tree with  $n = 7$  vertices

To show this formula, note that removing the vertex closest to the root splits any marked binary tree into two smaller ones, with  $k$  and  $n - k$  vertices. This recursion defines the so-called Catalan numbers. They are given by the closed formula

$$C_n = \frac{1}{n+1} \binom{2n}{n},$$

and can be estimated by  $C_n \leq 4^n$ .

For any  $G \in \mathcal{G}_n$ , the set of vertices is denoted by  $V(G)$  and the set of edges is denoted by  $E(G)$ . The root is denoted by  $R = R(G)$ , the set of  $n + 1$  leaves is denoted by  $L = L(G)$ . They together form the set of external edges,  $\text{Ext}(G) := R(G) \cup L(G)$ . The set of internal edges is defined as  $\text{Int}(G) := E(G) \setminus \text{Ext}(G)$ . We will draw the graphs as in Fig. 1, i.e., the root is on the left, and the leaves are on the right of the graph. Note that the vertices  $V(G)$  are partially ordered by their succession towards the root: for any  $v, v' \in V(G)$  we have  $v \prec v'$  if  $v$  lies on the (unique) route from  $v'$  to  $R$ . For any  $G \in \mathcal{G}_n$ , we denote by  $O(G)$  the set of complete orderings of the vertices  $V(G)$  that are compatible with the partial order  $\prec$  of  $V(G)$ . In general, for a given  $G \in \mathcal{G}_n$ , there are several complete orderings which are compatible with the partial order of  $G$ . The complete ordering can be visualized by drawing the graph in such a way that the horizontal coordinates of the vertices correspond to the ordering (see Fig. 2). Two rooted, binary, marked, and completely ordered trees  $G_1$  and  $G_2$  are said to be equivalent if there exists a one-to-one map between the edges and the vertices of  $G_1$  and  $G_2$ , such that all adjacency relations, all marks and all labels of the ordered vertices are preserved. The total number of inequivalent rooted, binary, marked trees with  $n$  completely ordered vertices is  $n!$ , i.e.

$$\sum_{G \in \mathcal{G}_n} |O(G)| = n!.$$

This follows from the fact that one can build up such a graph on  $n$  vertices by successively adjoining new leaves: a new leaf will be joined to an existing leaf in such a way that the existing leaf keeps its “father”-identity. In a graph with  $k - 1$  vertices and  $k$  leaves there are exactly  $k$  possibilities to adjoin the new leaf: one can create a new vertex on any of the existing leaves and adjoin the new  $(k + 1)$ -th leaf to it as unmarked.

For  $k \geq 1$  and  $n \geq 1$  consider forests consisting of  $k$  rooted, marked, binary trees,  $G_1, G_2, \dots, G_k$ , so that the total number of (internal) vertices is  $n$ . We assume that the trees, i.e. their roots are labelled, i.e. the permutation of the trees results in inequivalent forests. The set of such forests will

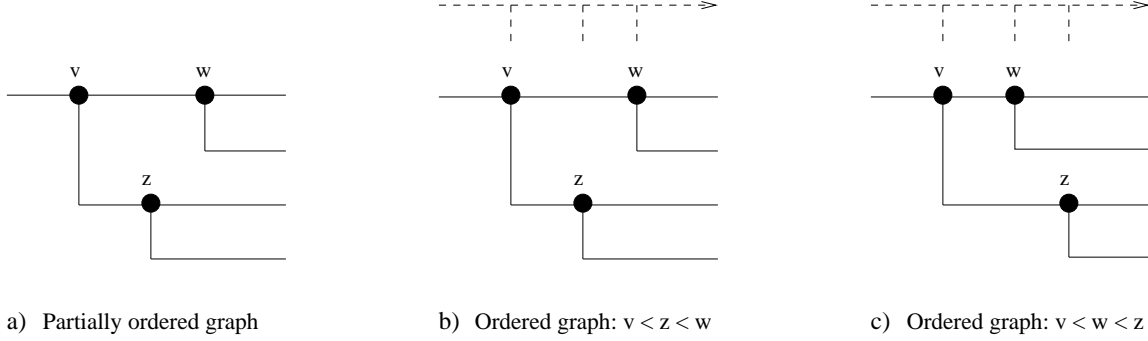

Figure 2: Ordering of graphs in  $\mathcal{G}_n$

be denoted by  $\mathcal{G}_{n,k}$ . In Fig. 3, we draw an example of a graph in  $\mathcal{G}_{7,4}$ . Note that the number of inequivalent forests in  $\mathcal{G}_{n,k}$  is given by

$$\sum_{(n_1, \dots, n_k): \sum_{i=1}^k n_i = n} C_{n_1} C_{n_2} \dots C_{n_k}$$

where the summation runs over all  $k$ -tuples of nonnegative integers that add up to  $n$ . This number can be bounded by

$$|\mathcal{G}_{n,k}| \leq 4^n \cdot \binom{n+k-1}{k-1} \leq 2^{3n+k}.$$

Again, for  $G \in \mathcal{G}_{n,k}$ , we will denote by  $V(G)$  the set of the vertices of  $G$ , by  $E(G)$  the set of edges, by  $\text{Int}(G)$ , and  $\text{Ext}(G)$  the sets of internal and, respectively, external edges. Moreover,  $R(G)$  and  $L(G)$  will be used for the set of roots (there are  $k$  roots in each forest), and for the set of leaves (there are  $n+k$  leaves) of  $G$ , respectively. The vertices in  $V(G)$  are again partially ordered by their succession towards the roots: for any  $v, v' \in V(G)$  within the same tree we have  $v < v'$  if  $v$  lies on the (unique) route from  $v'$  to the root of the tree. There is no order relation between vertices in different trees. For a given  $G \in \mathcal{G}_{n,k}$ , we define  $O(G)$  as the set of complete ordering of the  $n$  vertices of  $G$  which are compatible with the partial order of  $G$ : the number of non-equivalent forests with  $k$  trees and  $n$  completely ordered vertices is then

$$k(k+1)(k+2) \dots (n+k-1) = \frac{(n+k-1)!}{(k-1)!}.$$

This can again be seen by the successive build-up of the forest; if one starts with  $k$  trivial trees with no vertices, then the first new leaf can be adjoined in  $k$  different ways, the second one in  $(k+1)$  ways etc.

### 9.1.2 Quantum (Feynman) Graphs

For any  $n \geq 0$ ,  $k \geq 1$ , we now define the set of Feynman graphs  $\mathcal{F}_{n,k}$ . An element  $\Gamma \in \mathcal{F}_{n,k}$  is a union of  $k$  labelled pairs  $(T_j, T'_j)$ , where, for every  $j = 1, \dots, k$ ,  $T_j$  and  $T'_j$  are two disconnected oriented marked rooted trees. As in the classical graphs, the roots and the leaves of the trees are not considered vertices; we identify them with the edges they are adjacent to. These edges are called external. Each edge in  $T_j$  and  $T'_j$  is oriented (indicated by an arrow) and the edge is called *inward* or

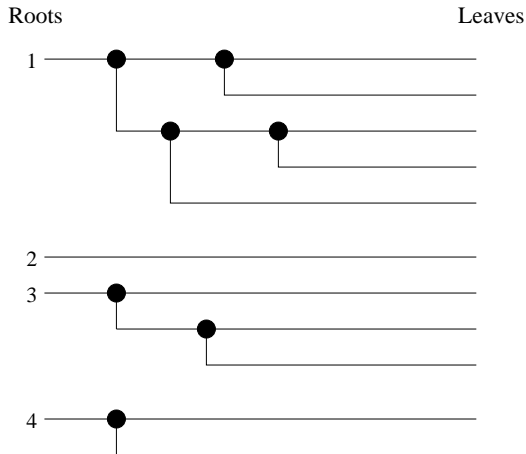

Figure 3: Example of forest in  $\mathcal{G}_{n,k}$  with  $n = 7$  and  $k = 4$

*outward* according to whether the orientation points towards or away from the root. For each  $j$  the root of  $T_j$  is outward, the root of  $T'_j$  is inward. Each vertex is adjacent to four edges. At each vertex we require that precisely two edges are incoming and two edges are outgoing. Note that the concept of incoming/outgoing is relative to the adjacent vertex and it does not coincide with the concept of inward/outward that is solely a property of the edge.

Similarly to the classical graphs, at each vertex we can introduce the notion of father-edge and son-edges. The father-edge is on the route from the vertex to the root, the other three edges are the son-edges. Moreover, two son-edges have the same orientation as the father-edge and one of them is distinguished and will be called the *marked son-edge* (we will say that the marked son-edge inherits the identity of the father-edge).

If the number of vertices of  $T_j$  and  $T'_j$  is  $m_j$  and  $m'_j$ , respectively, then the number of external edges is  $2m_j + 2$  and  $2m'_j + 2$ , respectively. Recall that for a trivial tree we count the leaf and the root as separate external edges. We assume that the total number of vertices is  $\sum_{j=1}^k (m_j + m'_j) = n$ . The vertices of  $\Gamma$  are denoted by  $V(\Gamma)$ . The edges of  $\Gamma$  are denoted by  $E(\Gamma)$ , the internal edges are  $\text{Int}(\Gamma)$  and the external ones are  $\text{Ext}(\Gamma)$ . For  $e \in E(\Gamma)$  and  $v \in V(\Gamma)$ , the notation  $e \in v$  indicates that the edge  $e$  is adjacent to the vertex  $v$ . We denote by  $R(\Gamma)$  the set of the root edges and by  $L(\Gamma)$  the set of leaf edges. Similarly to the classical graphs, the fact that each component of  $\Gamma$  has a root induces a partial ordering among the vertices of  $\Gamma$ , this will be denoted by  $\prec$ . Analogously, one can define a partial ordering among the edges of  $\Gamma$ , which will also be denoted by  $\prec$ .

Note that, because of the mark at every vertex, there is a natural pairing of the leaves of  $\Gamma$ . To define the pairing, we introduce the notion of the *ancestor*  $a(\ell)$  of a leaf  $\ell$  as follows: if  $\ell$  is an unmarked son-edge, then the ancestor of  $\ell$  is defined as  $\ell$  itself,  $a(\ell) = \ell$ . On the other hand, if  $\ell$  is a marked son-edge, or if it is the root, then the ancestor  $a(\ell)$  is defined as the minimal edge  $\bar{e}$  (minimal with respect to the partial order  $\prec$ ) on the route from  $\ell$  to the root, for which the set  $\{e \in E(\Gamma) : \bar{e} \prec e \prec \ell\}$  contains only marked son-edges. If we say that at each vertex the marked son-edge inherits the identity of the father-edge, then the ancestor  $a(\ell)$  is defined as the closest edge to the root whose identity is inherited by the leaf  $\ell$ . Clearly, the ancestor-map  $a : L(\Gamma) \rightarrow E(\Gamma)$  is injective (any two leaves have different ancestors) and it maps leaves of  $T_j$  or  $T'_j$  into edges of  $T_j$  or  $T'_j$ , respectively (the ancestor of  $\ell$  lies in the same tree as  $\ell$ ). Moreover, for every  $j = 1, \dots, k$ , the root of  $T_j$  (and of  $T'_j$ ) is always the ancestor of exactly one leaf in  $T_j$  (or  $T'_j$ , respectively).

Using the concept of ancestor, we define next the pairing of the leaves of  $\Gamma$ . For fixed  $j$ , two leaves  $\ell$  and  $\ell'$  in  $T_j$  (or in  $T'_j$ ) are paired (we say they are *companion leaves*) if  $a(\ell)$  and  $a(\ell')$  are the unmarked son-edges of a vertex in  $T_j$  (or in  $T'_j$ , respectively). Moreover, if the ancestor of a leaf  $\ell$  is the root of  $T_j$ , then we pair  $\ell$  with the unique leaf of  $T'_j$  whose ancestor is the root of  $T'_j$ . This completely defines a pairing of the leaves of  $T_j \cup T'_j$ , and thus of the whole graph  $\Gamma$ . Note that, if  $T_j$  has  $m_j$  vertices, then the number of leaves of  $T_j$  is  $2m_j + 1$ :  $2m_j$  leaves are paired within each other and one leaf, the one with the identity of the root, is paired with the leaf of  $T'_j$  whose ancestor is the root of  $T'_j$ .

For a given graph  $\Gamma \in \mathcal{F}_{n,k}$ , we define the labelling map,  $\pi_1 : R(\Gamma) \rightarrow \{1, \dots, k\}$ , where  $\pi_1(r) = j$  if  $r$  is the root of  $T_j$  or  $T'_j$ . For  $e \in E(\Gamma)$ , we also introduce the notation  $\tau_e = 1$  if  $e$  is outward and  $\tau_e = -1$  if  $e$  is inward. A root and the corresponding component will be called *trivial* if it contains no (internal) vertex. For  $\Gamma \in \mathcal{F}_{n,k}$  we denote by  $R_1(\Gamma)$  the set of trivial roots, and we set  $R_2(\Gamma) := R(\Gamma) \setminus R_1(\Gamma)$ . Let  $k_1(\Gamma) = |R_1(\Gamma)|$  and  $k_2(\Gamma) = |R_2(\Gamma)| = 2k - k_1(\Gamma)$ . Moreover, we define by  $E_2(\Gamma) := E(\Gamma) \setminus R_1(\Gamma)$ , then  $|E_2(\Gamma)| = 2k + 3n - k_1(\Gamma)$ . Let  $L_1(\Gamma)$  be the set of leaves of the trivial components; this set is naturally identified with  $R_1(\Gamma)$ . Let  $L_2(\Gamma) := L(\Gamma) \setminus L_1(\Gamma)$  be the set of leaves of the non-trivial components, clearly  $|L_2(\Gamma)| = 2n + 2k - k_1(\Gamma)$ .

When we draw graphs in  $\mathcal{F}_{n,k}$ , for every  $j = 1, \dots, k$ , we superpose the two trees  $T_j$  and  $T'_j$ ; this makes the pairing of the leaves clearer. As in the classical graphs, at each vertex we draw the marked son-edge so that it goes straight through, while the two unmarked son-edges join from below.

Next we will show that Feynman graphs can be constructed in a natural way starting from the classical ones. Later we will demonstrate that all quantum graphs can be obtained in this way. As a by-product we will derive a bound for the number of elements in  $\mathcal{F}_{n,k}$ .

For any  $G \in \mathcal{G}_{n,k}$  and  $\sigma = \{\sigma_v \in \{\pm 1\} : v \in V(G)\}$  we define a Feynman graph,  $\Gamma = \Gamma(G, \sigma) \in \mathcal{F}_{n,k}$ , as follows: We double each edge of  $G$  and equip them with an opposite orientation (arrows). At any vertex of  $G$  we define the new vertex of the six edges of  $\Gamma$  involved as follows. For  $\sigma_v = 1$ , the outward father-edge is joined with both edges of the unmarked son-edge and with the outward edge of the marked son-edge; this creates a vertex of  $\Gamma$  with four edges. The inward father-edge is joined with the inward edge of the marked son-edge and we consider it as a simple continuation, removing the (virtual) vertex. Analogously, if  $\sigma_v = -1$ , the inward father-edge is joined with both edges of the unmarked son-edge and with the inward edge of the marked son-edge. The outward father-edge is joined with the outward edge of the marked son-edge (and we consider it as a simple continuation). In Fig. 4 we illustrate this procedure with an example: given the graph  $G \in \mathcal{G}_{3,1}$  in a), we first double each edge of  $G$  and equip the new edges with opposite orientation in b). Then we define the new vertices: for example, if  $(\sigma_v, \sigma_w, \sigma_z) = (1, 1, -1)$  we obtain the Feynman graph in drawn in c). Hence, for  $G \in \mathcal{G}_{n,k}$  and  $\sigma \in \{\pm 1\}^n$ ,  $\Gamma(G, \sigma)$  is a Feynman graph with  $n + k$  incoming and  $n + k$  outgoing leaves (according to the arrows) and with  $k$  outgoing and  $k$  incoming root edges. The vertices of  $\Gamma$ ,  $V(\Gamma)$ , have four edges: two incoming and two outgoing. The set  $V(\Gamma)$  is in a natural one-to-one correspondence with  $V(G)$ .

We will now show that every element  $\Gamma \in \mathcal{F}_{n,k}$  can be obtained as  $\Gamma(G, \sigma)$  for some  $G \in \mathcal{G}_{n,k}$  and  $\sigma \in \{\pm 1\}^n$ . This representation is, however, not unique. The ambiguity comes from the fact that although the vertices of each component of  $G$  are partially ordered (according to their distance to the root), similarly for the components of  $\Gamma$ , but the order  $v \prec v'$  in the classical graph for  $v, v' \in V(G)$  is lost in the graph  $\Gamma$  if  $v$  and  $v'$  are assigned to different components of  $\Gamma$ . Therefore two different  $G$  or  $\sigma$  may lead to identical Feynman graphs (see Fig. 5: the Feynman graphs a) and b) are the same element of  $\mathcal{F}_{3,1}$ , but they are obtained from two different classical graphs in c) and d)).

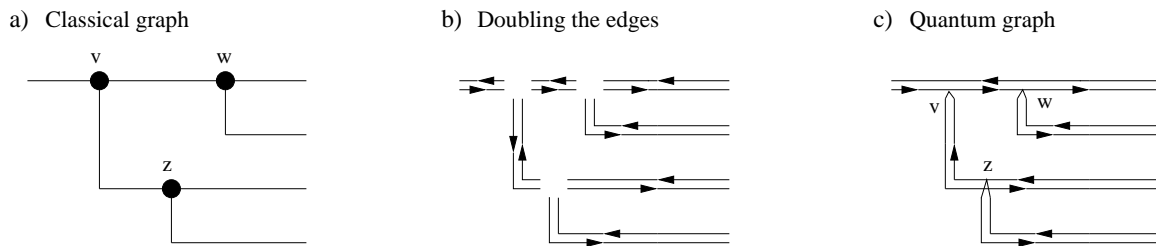

Figure 4: From  $\mathcal{G}_{n,k}$  to  $\mathcal{F}_{n,k}$

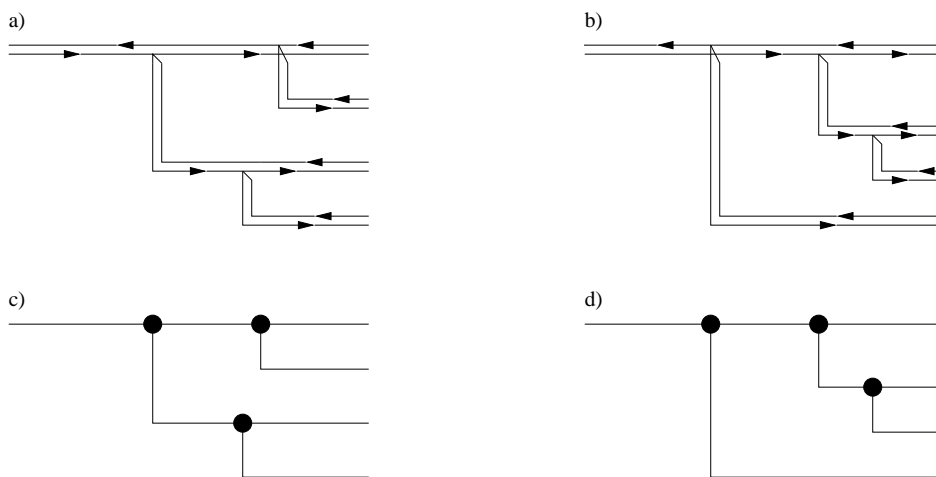

Figure 5: The graphs a) and b) are the same element of  $\mathcal{F}_{3,1}$ , but c) and d) are different elements of  $\mathcal{G}_{3,1}$

We can equip each Feynman graph with an extra ordering to make this construction unique. First we introduce the notion of *orderable pairs of vertices*. If  $v, \bar{v} \in V(\Gamma)$  and they belong to the same tree-pair but not to the same tree, i.e.,  $v \in T_j$  and  $\bar{v} \in T'_j$  for some  $j$ , then the pair  $(v, \bar{v})$  is called *orderable* if there is a leaf-pair  $(\ell, \ell')$  such that  $v$  is on the route from  $\ell$  to the root of  $T_j$  and  $\bar{v}$  is on the route from  $\ell'$  to the root of  $T'_j$ .

For any  $\Gamma \in \mathcal{F}_{n,k}$  we define the set of orderings  $O(\Gamma)$  on the vertices  $V(\Gamma)$  as follows. An ordering  $\prec$  belongs to  $O(\Gamma)$  if:

1. whenever  $v, \bar{v} \in V(\Gamma)$  belong to the same tree, then  $v \prec \bar{v}$  if and only if  $v$  lies on the route from  $\bar{v}$  to the root of the tree.
2. If  $v, \bar{v} \in V(\Gamma)$  belong to different tree-pairs, then there is no order relation between them.
3. Any orderable pair  $(v, \bar{v})$  is ordered by  $\prec$ .

It is easy to see that  $O(\Gamma)$  is not empty; for example the ordering  $v \prec \bar{v}$  for every orderable pair  $v \in T_j, \bar{v} \in T'_j$  within the same tree-pair is compatible with the requirements.

A Feynman graph  $\Gamma \in \mathcal{F}_{n,k}$  equipped with an ordering  $\prec \in O(\Gamma)$  is called *ordered Feynman graph*.

It is easy to see that every ordered Feynman graph  $\Gamma \in \mathcal{F}_{n,k}^o$  can be uniquely represented as  $\Gamma(G, \sigma)$  for some  $G \in \mathcal{G}_{n,k}$  and  $\sigma \in \{\pm 1\}^n$ . Moreover, since for any (unordered) Feynman graph  $\Gamma \in \mathcal{F}_{n,k}$  the set of orderings  $O(\Gamma)$  is not empty, we obtain in particular, that every Feynman graph  $\Gamma \in \mathcal{F}_{n,k}$  can be represented as  $\Gamma = \Gamma(G, \sigma)$ .

The number of Feynman graphs therefore satisfy the bound

$$|\mathcal{F}_{n,k}| \leq 2^n |\mathcal{G}_{n,k}| \leq 2^{4n+k}. \quad (9.7)$$

### 9.1.3 Amplitudes of Feynman graphs

Each Feynman graph  $\Gamma$  represents a map acting on density matrices; it encodes how the initial density matrix changes as the system undergoes a specific sequence of collisions. In this section we describe the kernel of this map, commonly known as the *amplitude* of the Feynman graph.

Given an arbitrary quantity  $x_e$  defined for  $e \in E(\Gamma)$ , and a vertex  $v \in V(\Gamma)$ , we will use the notation  $\sum_{e \in v} \pm x_e$  to indicate that  $x_e$  is summed with a plus sign if the edge  $e$  is incoming (w.r.t  $v$ ) while it is summed with a minus sign if  $e$  is outgoing.

For any  $\Gamma \in \mathcal{F}_{n,k}$ , we choose a family  $\boldsymbol{\eta} = \{\eta_e\}_{e \in E(\Gamma)}$ , with the property  $\eta_e > 0$  for all  $e \in E(\Gamma)$ , and such that, at every vertex  $v \in V(\Gamma)$ ,

$$\sum_{e \in v} \pm \tau_e \eta_e = 0. \quad (9.8)$$

(Recall that  $\tau_e = 1$  for outward and  $\tau_e = -1$  for inward edges.) It is easy to check that (9.8) is equivalent to the requirement that the  $\eta$  associated with any father-edge equals the sum of the  $\eta$  associated to its son-edges. In particular, the values of  $\eta$  on each of the  $2(n+k)$  leaves uniquely determine  $\eta_e$  for all edges  $e \in E(\Gamma)$ . For a given  $\Gamma \in \mathcal{F}_{n,k}$ , and a given family  $\boldsymbol{\eta}$ , we define the

operator  $K_{\Gamma,t,\boldsymbol{\eta}}$  through its kernel

$$\begin{aligned}
K_{\Gamma,t,\boldsymbol{\eta}}(\mathbf{q}_k, \mathbf{q}'_k; \mathbf{r}_{n+k}, \mathbf{r}'_{n+k}) &:= \frac{1}{(n+k)!} \sum_{\pi_2 \in \mathcal{S}_{n+k}} \prod_{e \in R_1(\Gamma) = L_1(\Gamma)} (-i\tau_e) e^{-it\tau_e (q_{\pi_1(e)}^{\#e})^2} \delta(q_{\pi_1(e)}^{\#e} - r_{\pi_2(e)}^{\#e}) \\
&\times \int_{\mathbb{R}} \int_{\mathbb{R}} \prod_{e \in E_2(\Gamma)} d\alpha_e dp_e \prod_{e \in R_2(\Gamma)} \delta(p_e - q_{\pi_1(e)}^{\#e}) \prod_{e \in L_2(\Gamma)} \delta(p_e - r_{\pi_2(e)}^{\#e}) e^{-it \sum_{e \in R_2(\Gamma)} \tau_e (\alpha_e + i\tau_e \eta_e)} \\
&\times \prod_{e \in E_2(\Gamma)} \frac{1}{\alpha_e - p_e^2 + i\tau_e \eta_e} \prod_{v \in V(\Gamma)} \delta\left(\sum_{e \in v} \pm \alpha_e\right) \delta\left(\sum_{e \in v} \pm p_e\right),
\end{aligned} \tag{9.9}$$

where  $q^{\#e} = q$  if  $e$  points away from the root and  $q^{\#e} = q'$  if  $e$  points toward the root and similar notation is used for the  $r$  variables. Here the map  $\pi_1$  labelling the roots is fixed, since  $\Gamma$  is considered as a graph with labelled roots. The map  $\pi_2 : L(\Gamma) \rightarrow \{1, \dots, n+k\}$  labels the leaves of  $\Gamma$  in such a way that the two elements of a leaf pair receives the same label. Since there is no natural order of the leaves, we sum over all possible labelling  $\pi_2$ , and we divide the result by the number of labelling  $(n+k)!$ . Notice that  $K_{\Gamma,t,\boldsymbol{\eta}}$  maps operators on  $L_s^2(\mathbb{R}^{3(n+k)})$  into operators on  $L_s^2(\mathbb{R}^{3k})$  by the formula

$$\left(K_{\Gamma,t,\boldsymbol{\eta}} \gamma^{(n+k)}\right)(\mathbf{q}_k; \mathbf{q}'_k) = \int K_{\Gamma,t,\boldsymbol{\eta}}(\mathbf{q}_k, \mathbf{q}'_k; \mathbf{r}_{n+k}, \mathbf{r}'_{n+k}) \gamma^{(n+k)}(\mathbf{r}_{n+k}; \mathbf{r}'_{n+k}) d\mathbf{r}_{n+k} d\mathbf{r}'_{n+k}$$

where  $\gamma^{(n+k)}$  is an operator on  $L_s^2(\mathbb{R}^{3(n+k)})$  given by the kernel  $\gamma^{(n+k)}(\mathbf{r}_{n+k}; \mathbf{r}'_{n+k})$  in Fourier space.

Note that there are  $|R_2| + |L_2| + |V| = 4k + 3n - 2k_1$  momentum delta-functions involving  $p_e$  variables and only  $|E_2| = 2k + 3n - k_1$  momentum integration variables. Together with the  $k_1$  direct delta-functions related to the roots in  $R_1(\Gamma)$ , we see that the kernel  $K_{\Gamma,t,\boldsymbol{\eta}}$  contains  $2k$  delta-functions among its  $2n + 4k$  variables. This corresponds to the  $2k$  momentum conservation in each of the  $2k$  components of  $\Gamma$ . It can easily be seen that all the  $p_e$  momenta can indeed be uniquely expressed through the external momenta  $\mathbf{r}_{n+k}, \mathbf{r}'_{n+k}, \mathbf{q}_k, \mathbf{q}'_k$ . In particular, the  $dp_e$  integrations are all well defined and they correspond to substituting the appropriate linear combinations of the external momenta into  $p_e$ .

We will represent the fully expanded terms in the Duhamel expansion (9.6) as a sum of contributions associated with the Feynman graphs. More precisely, we will show in the next subsection that the  $m$ -th term in the sum on the r.h.s. of (9.6) can be rewritten as the sum of  $K_{\Gamma,t,\boldsymbol{\eta}} \gamma_0^{(k+m)}$  over all  $\Gamma \in \mathcal{F}_{m,k}$  independent of the choice of  $\boldsymbol{\eta}$ .

On the intuitive level, it is possible to recognize the origin of some of the factors in the formula (9.9) for the kernel  $K_{\Gamma,t,\boldsymbol{\eta}}$ . The appearance of the one-dimensional variables  $\alpha_e$  and the propagators  $(\alpha_e - p_e^2 + i\tau_e \eta_e)^{-1}$ , for example, derives from the free evolution  $e^{-it\tau_e p_e^2}$ , expressed as

$$e^{-it\tau_e p_e^2} = (i\tau_e) \int_{\mathbb{R}} d\alpha_e \frac{e^{-it\tau_e (\alpha_e + i\tau_e \eta_e)}}{\alpha_e - p_e^2 + i\tau_e \eta_e}. \tag{9.10}$$

The presence of the factor  $\delta(\sum_{e \in v} \pm p_e)$  (conservation of momentum at every vertex), on the other hand, is due to the translation invariance of the interaction, and it just reproduces the kernel of the operators  $B^{(k)}$  in momentum space (see (9.5)). Finally, one can understand the presence of the factors  $\delta(\sum_{e \in v} \pm \alpha_e)$  as the result of the integration over the time-variables, after all the free evolutions  $e^{\pm it p_e^2}$  have been rewritten in terms of resolvents according to (9.10).



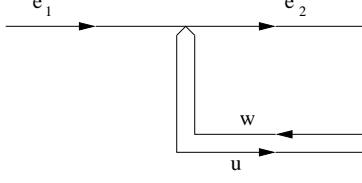

Figure 6: Integration over  $\alpha_e$

The absolute convergence of the  $d\alpha_e$  integrals in (9.9) can be proven by induction on  $n$ . For  $n = 0$  there is no such integration. For  $n = 1$ , the  $d\alpha_e$  integrations are of the form

$$\int_{\mathbb{R}} \frac{d\alpha_{e_1} d\alpha_{e_2} d\alpha_u d\alpha_w \delta(\alpha_{e_2} + \alpha_u - \alpha_{e_1} - \alpha_w)}{(\alpha_{e_1} - p_{e_1}^2 + i\tau_{e_1}\eta_{e_1})(\alpha_{e_2} - p_{e_2}^2 + i\tau_{e_2}\eta_{e_2})(\alpha_u - p_u^2 + i\tau_u\eta_u)(\alpha_w - p_w^2 + i\tau_w\eta_w)} \quad (9.11)$$

with  $\tau_{e_1} = \tau_{e_2}$  and  $\tau_u + \tau_w = 0$ . Here  $e_2$  corresponds to the marked son-edge of the father-edge  $e_1$  in  $\Gamma$ , and  $u, w$  correspond to the doubling of the unmarked son-edge (see Fig. 6). Recall that, by definition  $\eta_{e_1} = \eta_{e_2} + \eta_w + \eta_u$ , and all the  $\eta$ 's are strictly positive.

We will use the following inequality with  $\eta = \min(\eta_1, \eta_2)$ ,

$$\begin{aligned} \int_{\mathbb{R}} \frac{d\alpha}{|\alpha - a - i\eta_1||\alpha - b + i\eta_2|} &\leq \eta^{-2} \int_{\mathbb{R}} \frac{d\alpha}{|(\alpha - a)/\eta - i||(\alpha - b)/\eta + i|} \\ &\leq \eta^{-1} \int_{\mathbb{R}} \frac{dy}{|y - \frac{a}{\eta} - i|^{1-\frac{\varepsilon}{3}}|y - \frac{b}{\eta}|^{1-\frac{\varepsilon}{3}}} \leq \frac{C\eta^{-\varepsilon}}{|a - b - i\eta|^{1-\varepsilon}} \end{aligned} \quad (9.12)$$

for any  $a, b \in \mathbb{R}$ ,  $\eta_1, \eta_2 > 0$  and  $0 < \varepsilon < 1$  (in the last inequality we applied Lemma 10.1).

Using this inequality, (9.11) can be bounded by (with  $\eta := \min(\eta_{e_2}, \eta_w, \eta_u)$ )

$$\begin{aligned} C\eta^{-\varepsilon} \int_{\mathbb{R}} \frac{d\alpha_{e_1} d\alpha_{e_2}}{|\alpha_{e_1} - p_{e_1}^2 + i\eta| |\alpha_{e_2} - p_{e_2}^2 + i\eta| |\alpha_{e_2} - \alpha_{e_1} + p_u^2 - p_w^2 + i\eta|^{1-\varepsilon}} \\ \leq C^2 \eta^{-2\varepsilon} \int_{\mathbb{R}} \frac{d\alpha_{e_2}}{|\alpha_{e_2} - p_{e_2}^2 + i\eta| |\alpha_{e_2} - p_{e_1}^2 + p_u^2 - p_w^2 + i\eta|^{1-2\varepsilon}} \\ \leq \frac{C^3 \eta^{-3\varepsilon}}{|p_{e_2}^2 - p_{e_1}^2 + p_u^2 - p_w^2 + i\eta|^{1-3\varepsilon}} \leq \frac{C}{\eta} \end{aligned} \quad (9.13)$$

where we applied a slightly modified version of (9.12) two more times, and where we assumed that  $0 < \varepsilon < 1/3$ .

For a general  $n$  we note that any Feynman graph can be built up from the trivial graph with  $2k$  roots by successively adjoining new vertices to leaves. When we adjoin a new vertex to a Feynman graph  $\Gamma \in \mathcal{F}_{n-1, k}$ , we select a leaf,  $e \in L(\Gamma)$ , split it into two edges,  $e_1$  and  $e = e_2$  ( $e_1$  becomes the new leaf and it is equipped with the same orientation as  $e$ ) and we adjoin two more edges,  $u$  and  $w$  of opposite orientation (see Fig. 7).

We create three new denominators, three new  $\alpha$  variables and one new delta function among them. The additional integration is

$$\int_{\mathbb{R}} \frac{d\alpha_{e_1} d\alpha_u d\alpha_w}{(\alpha_{e_1} - p_{e_1}^2 + i\tau_{e_1}\eta_{e_1})(\alpha_u - p_u^2 + i\tau_u\eta_u)(\alpha_w - p_w^2 + i\tau_w\eta_w)} \delta(\alpha_e + \alpha_u - \alpha_{e_1} - \alpha_w) \quad (9.14)$$

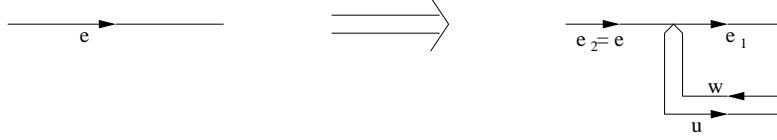

Figure 7: Insertion of a new edge

where the  $\eta$ 's are chosen such that  $\eta_{e_2} = \eta_{e_1} + \eta_w + \eta_u$ . This integral is absolutely convergent uniformly in  $\alpha_e$  and for any choice of  $\eta_{e_1}, \eta_u, \eta_w > 0$  and for any choice of the  $p$ -variables. This guarantees that the absolute convergence of all the  $d\alpha_e$  integrals in (9.9) can be checked with a step by step reduction.

Now we prove that the right hand side of (9.9) is independent of the family  $\boldsymbol{\eta} = \{\eta_e\}_{e \in E(\Gamma)}$ . Notice that, because of the condition that at each vertex the  $\eta$  associated with the father-edge equals the sum of the  $\eta$ 's associated with the son-edges, the only independent  $\eta$ 's are the ones associated with the leaves of  $\Gamma$ . It is moreover clear that, for every fixed  $\bar{e} \in L(\Gamma)$ ,  $K_{\Gamma,t,\boldsymbol{\eta}}$ , as a function of  $\eta_{\bar{e}}$ , has an analytic extension in the whole half plane  $\text{Re } \eta_{\bar{e}} > 0$ . It is therefore sufficient to show that  $K_{\Gamma,t,\boldsymbol{\eta}}$  is constant in a small neighborhood of a given value  $\eta_{\bar{e}}$  with  $\text{Re } \eta_{\bar{e}} > 0$  (while all the other  $\eta_e > 0$ ,  $\bar{e} \neq e \in L(\Gamma)$ , are kept constant). After replacing  $\eta_{\bar{e}}$  by  $\eta_{\bar{e}} + \xi$ , we can shift the  $\alpha_e$  variables as follows. For  $e \in E(\Gamma)$  on the route from  $\bar{e}$  to the unique root connected to  $\bar{e}$ , we shift  $\alpha_e \rightarrow \tilde{\alpha}_e = \alpha_e + i\tau_e \xi$ , while for all other  $e \in E(\Gamma)$  we leave  $\tilde{\alpha}_e = \alpha_e$ . Here we assume that  $|\text{Re } \xi| < \min_{e \in E(\Gamma)} \text{Re } \eta_e$  to avoid deforming the  $\alpha_e$  integral contour through the pole at  $\alpha_e = p_e^2 - i\tau_e \eta_e$ . Then we can see that the integral remains unchanged. This follows from observing that for all  $v$

$$\sum_{e \in v} \pm \alpha_e = \sum_{e \in v} \pm \tilde{\alpha}_e$$

thanks to the definition of  $\tau_e$  and the sign convention of the summation. This proves the independence of (9.9) from the family  $\boldsymbol{\eta}$ . In particular we can use the simpler notation  $K_{\Gamma,t}$ .

We note, that one may introduce dual variables  $\alpha_e$  for the trivial components  $e \in R_1(\Gamma)$  as well. Using the identity (9.10), one then may rewrite the definition of  $K_{\Gamma,t}$  into a more compact form

$$\begin{aligned} K_{\Gamma,t}(\mathbf{q}_k, \mathbf{q}'_k; \mathbf{r}_{n+k}, \mathbf{r}'_{n+k}) &= \frac{1}{(n+k)!} \sum_{\pi_2 \in S_{n+k}} \\ &\times \int \int_{\mathbb{R}} \prod_{e \in E(\Gamma)} d\alpha_e dp_e \prod_{e \in R(\Gamma)} \delta(p_e - q_{\pi_1(e)}^{\#e}) \prod_{e \in L(\Gamma)} \delta(p_e - r_{\pi_2(e)}^{\#e}) \\ &\times e^{-it \sum_{e \in R(\Gamma)} \tau_e (\alpha_e + i\tau_e \eta)} \prod_{e \in E(\Gamma)} \frac{1}{\alpha_e - p_e^2 + i\tau_e \eta_e} \prod_{v \in V(\Gamma)} \delta\left(\sum_{e \in v} \pm \alpha_e\right) \delta\left(\sum_{e \in v} \pm p_e\right). \end{aligned} \quad (9.15)$$

However, this definition will not result in absolute convergent integrals, therefore (9.10) has to be used for each  $e \in R_1(\Gamma)$  before any estimates. With this remark in mind, we can use the simpler formula (9.15).

The amplitudes  $K_{\Gamma,t}$  will describe the terms of the summation in (9.6). The input of the last term in (9.6) is somewhat different from the previous terms; it involves the density matrix  $\gamma^{(k+n)}$  at an intermediate time  $s_n$  and the last free evolution is absent. We thus introduce a slight modification

of the amplitude  $K_{\Gamma,t}$  to represent this term. We define the operator  $L_{\Gamma,t}$ , for  $\Gamma \in \mathcal{F}_{n,k}$ ,  $n, k \geq 1$ , through

$$\begin{aligned}
L_{\Gamma,t}(\mathbf{q}_k, \mathbf{q}'_k; \mathbf{r}_{n+k}, \mathbf{r}'_{n+k}) &:= \frac{1}{(n+k)!} \sum_{\pi_2 \in S_{n+k}} \sum_{\bar{v} \in M(\Gamma)} \sigma_{\bar{v}} \int \int_{\mathbb{R}} \prod_{\substack{e \in E(\Gamma) \\ e \notin S_{\bar{v}}}} d\alpha_e \prod_{e \in E(\Gamma)} dp_e \\
&\times \prod_{e \in R(\Gamma)} \delta(p_e - q_{\pi_1(e)}) \delta(p_{e'} - q'_{\pi_1(e)}) \prod_{e \in L(\Gamma)} \delta(p_e - r_{\pi_2(e)}) \delta(p_{e'} - r'_{\pi_2(e)}) \prod_{v \in V(\Gamma)} \delta\left(\sum_{e \in v} \pm p_e\right) \quad (9.16) \\
&\times \exp\left(-it \sum_{e \in R(\Gamma)} \tau_e(\alpha_e + i\tau_e \eta_e)\right) \prod_{\substack{e \in E(\Gamma) \\ e \notin S_{\bar{v}}}} \frac{1}{\alpha_e - p_e^2 + i\tau_e \eta_e} \prod_{\bar{v} \neq v \in V(\Gamma)} \delta\left(\sum_{e \in v} \pm \alpha_e\right),
\end{aligned}$$

where  $M(\Gamma) \subset V(\Gamma)$  is the set of maximal vertices of  $\Gamma$ , that is the set of all  $v \in V(\Gamma)$  so that there exists no  $\tilde{v}$  with  $\tilde{v} \succ v$  (recall that  $\prec$  was the partial order on  $V(\Gamma)$  induced by the distance to the root). Moreover, for a vertex  $v \in V(\Gamma)$ , we denote by  $S_v$  the set of son-edges of the vertex  $v$  (clearly,  $R(\Gamma) \cap S_v = \emptyset$ , for any  $v \in V(\Gamma)$ ), and we set

$$\sigma_v = \sum_{e \in S_v} \tau_e,$$

i.e.,  $\sigma_v = 1$  if of the four edges adjacent to  $v$ , three are outward and one is inward,  $\sigma_v = -1$  otherwise.

In other words,  $L_{\Gamma,t}$  is defined so that there are no propagators associated with the son-edges of a  $\bar{v} \in M(\Gamma)$ . The variables  $\boldsymbol{\eta} = \{\eta_e\}_{e \in E(\Gamma)}$  are chosen as in (9.8): although  $\eta_e$ , for  $e \in S_{\bar{v}}$ , does not appear directly in (9.16), the value of the  $\eta$ -variable associated to the father-edge of  $\bar{v}$  depends on it. Analogously to  $K_{\Gamma,t}$ , it can be proven that  $L_{\Gamma,t}$  is independent of the choice of  $\boldsymbol{\eta}$ . In (9.16) we define  $L_{\Gamma,t}$  using a form analogous to the simpler definition (9.15); clearly  $L_{\Gamma,t}$  can be rewritten into a form analogous to (9.9) as well after integrating out all  $\alpha_e$ ,  $e \in R_1(\Gamma)$ .

## 9.2 Duhamel expansion in terms of Feynman graphs

In this section, we shall prove that the Duhamel expansion for the solution (9.6) can be expressed as sums over Feynman graphs. Similar representations were used in the physics literature and proofs are available for the expansions of the imaginary time many-fermion Green functions via the method of (Grassmannian) functional integrals, see e.g., [21]. Our relatively short proof is elementary and does not rely on functional integral. It also allows for an explicit remainder term.

**Theorem 9.2.** *Fix  $k, n \geq 1$ . Then, for any  $\gamma_0^{(k+n)}$  that is symmetric with respect to permutations (in the sense of (1.8)), we have*

$$\begin{aligned}
&\int_0^t ds_1 \int_0^{s_1} ds_2 \dots \int_0^{s_{n-1}} ds_n \mathcal{U}_0^{(k)}(t - s_1) B^{(k)} \dots \mathcal{U}_0^{(k+n-1)}(s_{n-1} - s_n) B^{(k+n-1)} \mathcal{U}_0^{(k+n)}(s_n) \gamma_0^{(k+n)} \\
&= \sum_{\Gamma \in \mathcal{F}_{n,k}} K_{\Gamma,t} \gamma_0^{(k+n)}. \quad (9.17)
\end{aligned}$$

For  $n = 0$ ,  $k \geq 1$  we have

$$\mathcal{U}_0^{(k)}(t) \gamma_0^{(k)} = \sum_{\Gamma \in \mathcal{F}_{0,k}} K_{\Gamma,t} \gamma_0^{(k)} \quad (9.18)$$

where the summation is only for the trivial graph.

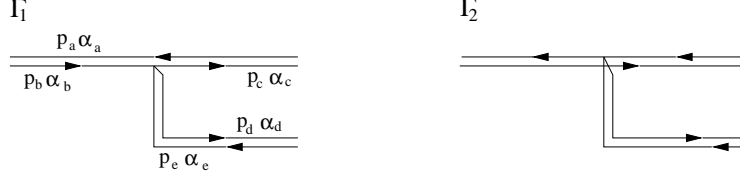

Figure 8: The two Feynman graphs in  $\mathcal{F}_{1,1}$

Moreover, for any fixed  $k, n \geq 1$ , if  $\gamma_t^{(k+n)} \in C([0, T]; \mathcal{H}_k)$  is symmetric with respect to permutations for all  $t \in [0, T]$ , then we have

$$\begin{aligned} & \int_0^t ds_1 \int_0^{s_1} ds_2 \dots \int_0^{s_{n-1}} ds_n \mathcal{U}_0^{(k)}(t-s_1) B^{(k)} \dots \mathcal{U}_0^{(k+n-1)}(s_{n-1}-s_n) B^{(k+n-1)} \gamma_{s_n}^{(k+n)} \\ &= -i \sum_{\Gamma \in \mathcal{F}_{n,k}} \int_0^t ds L_{\Gamma, t-s} \gamma_s^{(k+n)} \end{aligned} \quad (9.19)$$

for all  $t \in [0, T]$ .

Before presenting the proof for the general case, it is instructive to show how the structure of the operators  $K_{\Gamma, t}$  emerges from the Duhamel expansion. We thus consider (9.17) in the very simple case  $n = 1, k = 1$ , i.e.,

$$\int_0^t ds \mathcal{U}_0^{(1)}(t-s) B^{(1)} \mathcal{U}_0^{(2)}(s) \gamma_0^{(2)} = K_{\Gamma_1, t} \gamma_0^{(2)} + K_{\Gamma_2, t} \gamma_0^{(2)}, \quad (9.20)$$

where  $\Gamma_1$  and  $\Gamma_2$  are the two elements of  $\mathcal{F}_{1,1}$  drawn in Figure 8.

By definition of the map  $B^{(1)}$ , the l.h.s. of (9.20) is given by

$$-i \int_0^t ds \mathcal{U}_0^{(1)}(t-s) \text{Tr}_2 \delta(x_1 - x_2) \mathcal{U}_0^{(2)}(s) \gamma_0^{(2)} + i \int_0^t ds \mathcal{U}_0^{(1)}(t-s) \text{Tr}_2 \mathcal{U}_0^{(2)}(s) \gamma_0^{(2)} \delta(x_1 - x_2). \quad (9.21)$$

We now show that the first term coincides with the contribution of the Feynman diagram  $\Gamma_1$  (analogously one can prove that the second term equals the contribution of  $\Gamma_2$ ).

Recall that  $K_{\Gamma_1, t} \in \mathcal{F}_{1,1}$  maps operators on  $L_s^2(\mathbb{R}^3 \times \mathbb{R}^3)$  into operators on  $L_s^2(\mathbb{R}^3)$ . In momentum space, the kernel of  $\gamma_0^{(2)}$  has four variables,  $\gamma_0^{(2)}(p_c, p_d; p_a, p_e)$ . These are the momentum variables on the right hand side of Feynman graph  $\Gamma_1$ . The resulting operator,  $K_{\Gamma_1, t} \gamma_0^{(2)}$ , acts on  $L_s^2(\mathbb{R}^3)$ , and its kernel has two variables,  $(p_b; p_a)$  represented on the l.h.s. of the Feynman graph.

The pairs of variables,  $(p_c; p_a)$  and  $(p_d; p_e)$ , in the argument of  $\gamma_0^{(2)}$  correspond to the input and output of the first and the second variable of the  $L_s^2(\mathbb{R}^3 \times \mathbb{R}^3)$  space. Similarly,  $p_b$  is the input and  $p_a$  is the output variable of the resulting operator  $K_{\Gamma_1, t} \gamma_0^{(2)}$ : arrows in the Feynman graph pointing away from the roots indicate input-variables, arrows pointing towards the roots indicate output-variables of the corresponding density matrix.

For any kernel  $\gamma^{(2)}(p_1, p_2; p'_1, p'_2)$ , the free time evolution in momentum space acts as follows

$$\left( \mathcal{U}_0^{(2)}(s) \gamma^{(2)} \right) (p_1, p_2; p'_1, p'_2) = e^{-is(p_1^2 + p_2^2)} e^{is(p'_1{}^2 + p'_2{}^2)} \gamma_0^{(2)}(p_1, p_2; p'_1, p'_2).$$

The multiplication by  $\delta(x_1 - x_2)$  corresponds to convolution with  $\delta(p_1 + p_2)$  in Fourier space,

$$\left( \delta(x_1 - x_2) \gamma^{(2)} \right) (p_1, p_2; p'_1, p'_2) = \int dr \gamma^{(2)}(r, p_1 - r + p_2; p'_1, p'_2),$$

thus after taking the partial trace, we have

$$\left[ \text{Tr}_2 \left( \delta(x_1 - x_2) \gamma^{(2)} \right) \right] (p_1; p'_1) = \int dr dq \gamma^{(2)}(r, p_1 - r + q; p'_1, q).$$

Applying these elementary steps for the first term of (9.21), we get

$$\begin{aligned} & \left[ -i \int_0^t ds \mathcal{U}_0^{(1)}(t-s) \text{Tr}_2 \delta(x_1 - x_2) \mathcal{U}_0^{(2)}(s) \gamma_0^{(2)} \right] (p_b; p_a) \\ &= -i \int_0^t ds e^{-i(t-s)p_b^2} e^{i(t-s)p_a^2} \int dq dr \left( \mathcal{U}_0^{(2)}(s) \gamma_0^{(2)} \right) (r, p_b - r + q; p_a, q) \\ &= -i \int_0^t ds e^{-i(t-s)p_b^2} e^{i(t-s)p_a^2} \int dp_c dp_d dp_e \delta(p_b + p_e - p_c - p_d) \left( \mathcal{U}_0^{(2)}(s) \gamma_0^{(2)} \right) (p_c, p_d; p_a, p_e). \end{aligned} \quad (9.22)$$

In the last step we changed variables, which now correspond to the variables in the Feynman graph. In particular, the vertex involves a delta function expressing the Kirchoff law (conservation of momentum at the vertex).

Now we show how the time integrals of the propagators can be expressed in terms of auxiliary  $\alpha$ -integrals and resolvents. Neglecting the momentum integrations, the last term in (9.22) contains the following propagators:

$$\Pi := \int_0^t ds e^{-i(t-s)p_b^2} e^{i(t-s)p_a^2} e^{-is(p_c^2+p_d^2)} e^{is(p_a^2+p_e^2)}.$$

Using the identity (9.10) for the propagator of each momentum variable, we obtain

$$\Pi = i \int_0^t ds \int_{\mathbb{R}} \frac{d\alpha_a d\alpha_b d\alpha_c d\alpha_d d\alpha_e e^{it(\alpha_a - i\eta_a) - i(t-s)(\alpha_b + i\eta_b) - is(\alpha_c + i\eta_c) - is(\alpha_d + i\eta_d) + is(\alpha_e - i\eta_e)}}{(\alpha_a - p_a^2 - i\eta_a)(\alpha_b - p_b^2 + i\eta_b)(\alpha_c - p_c^2 + i\eta_c)(\alpha_d - p_d^2 + i\eta_d)(\alpha_e - p_e^2 - i\eta_e)}$$

(In our example,  $\tau_b = \tau_c = \tau_d = 1$  and  $\tau_a = \tau_e = -1$  by the definition of  $\tau$ ). Notice that the time integration can be extended to  $s \in (-\infty, \infty)$ , since all  $\eta$ 's are positive and by residue calculation

$$\int_{\mathbb{R}} \frac{d\alpha e^{-is(\alpha + i\eta)}}{\alpha - p^2 + i\eta} = 0$$

if  $s < 0$  and  $\eta > 0$ .

Using that  $\eta_b = \eta_c + \eta_d + \eta_e$  and performing the  $ds$  integration, we obtain the delta function in the  $\alpha$  variables:

$$\Pi = i \int_{\mathbb{R}} \frac{e^{it(\alpha_a - i\eta_a)} e^{-it(\alpha_b + i\eta_b)} d\alpha_a d\alpha_b d\alpha_c d\alpha_d d\alpha_e \delta(\alpha_b - \alpha_c - \alpha_d + \alpha_e)}{(\alpha_a - p_a^2 - i\eta_a)(\alpha_b - p_b^2 + i\eta_b)(\alpha_c - p_c^2 + i\eta_c)(\alpha_d - p_d^2 + i\eta_d)(\alpha_e - p_e^2 - i\eta_e)}$$

(recall that the  $\delta$ -function in the  $\alpha$ -variables is defined w.r.t. to the measure  $d\alpha = d_{\text{Leb}}\alpha/2\pi$ ). Combining this formula with (9.22), we arrive at

$$\begin{aligned} & \left[ -i \int_0^t ds \mathcal{U}_0^{(1)}(t-s) \text{Tr}_2 \delta(x_1 - x_2) \mathcal{U}_0^{(2)}(s) \gamma_0^{(2)} \right] (p_b; p_a) \\ &= \int dp_c dp_d dp_e \delta(p_b + p_e - p_c - p_d) \gamma_0^{(2)}(p_c, p_d; p_a, p_e) \\ & \quad \times \int e^{it(\alpha_a - i\eta_a)} e^{-it(\alpha_b + i\eta_b)} \left[ \prod_{j=a,b,c,d,e} \frac{d\alpha_j}{\alpha_j - p_j^2 + i\tau_j \eta_j} \right] \delta(\alpha_b + \alpha_e - \alpha_c - \alpha_d) \end{aligned} \quad (9.23)$$

which is exactly the action of the kernel  $K_{\Gamma_1,t}$  (as defined in (9.15)) on  $\gamma_0^{(2)}$ .

Now we come to the proof of the general theorem.

*Proof of Theorem 9.2.* We start by proving (9.17) and (9.18). For  $k \geq 1$ ,  $n \geq 1$ , and  $t \in [0, T]$ , let

$$\begin{aligned} \xi_{n,t}^{(k)} := & \int_0^t ds_1 \int_0^{s_1} ds_2 \dots \int_0^{s_{n-1}} ds_n \mathcal{U}_0^{(k)}(t - s_1) B^{(k)} \dots \mathcal{U}_0^{(k+n-1)}(s_{n-1} - s_n) B^{(k+n-1)} \\ & \times \mathcal{U}_0^{(k+n)}(s_n) \gamma_0^{(k+n)}. \end{aligned} \quad (9.24)$$

For  $k \geq 1$ ,  $n = 0$  and  $t \in [0, T]$ , let

$$\xi_{0,t}^{(k)} := \mathcal{U}_0^{(k)}(t) \gamma_0^{(k)}. \quad (9.25)$$

We also define  $\theta_{n,t}^{(k)}$  for  $k \geq 1$ ,  $n \geq 0$ , and  $t \in [0, T]$  through its kernel given by

$$\theta_{n,t}^{(k)}(\mathbf{q}_k; \mathbf{q}'_k) := \sum_{\Gamma \in \mathcal{F}_{n,k}} \int d\mathbf{r}_{n+k} d\mathbf{r}'_{n+k} K_{\Gamma,t}(\mathbf{q}_k, \mathbf{q}'_k; \mathbf{r}_{n+k}, \mathbf{r}'_{n+k}) \gamma_0^{(n+k)}(\mathbf{r}_{n+k}, \mathbf{r}'_{n+k}). \quad (9.26)$$

We need to show that  $\xi_{n,t}^{(k)} = \theta_{n,t}^{(k)}$  for all  $n \geq 0$ ,  $k \geq 1$ , and for all  $t \in [0, T]$ . The proof is based on induction over  $n$ . For  $n = 0$  the claim is trivial using the identity (9.10), thus from now on we assume that  $n \geq 1$ . We prove that  $\xi_{m,t}^{(k)} = \theta_{m,t}^{(k)}$  for  $m = n$  and for all  $k \geq 1$  and  $t \in [0, T]$ , assuming that this is true for all  $m < n$ . We will first check that  $\xi_{n,0}^{(k)} = \theta_{n,0}^{(k)}$ , then compare their time derivatives.

At  $t = 0$  clearly  $\xi_{n,0}^{(k)} = 0$ . To see  $\theta_{n,0}^{(k)} = 0$ , we check that the  $K_{\Gamma,t}$  kernel vanishes at  $t = 0$ , for  $\Gamma \in \mathcal{F}_{n,k}$ ,  $n \geq 1$ . We use the representation (9.9). Since  $n \geq 1$ , we know that  $E_2(\Gamma) \neq \emptyset$ , in particular there is at least one propagator factor  $(\alpha_{\bar{e}} - p_{\bar{e}}^2 + i\tau_{\bar{e}}\eta_{\bar{e}})^{-1}$  on the right hand side for some  $\bar{e} \in L_2(\Gamma)$ . Notice that for  $t = 0$  the exponentially increasing factor  $\prod_{e \in R_2(\Gamma)} e^{\eta_e t}$  is not present. Using the absolute convergence of all the vertex integrals (9.14) uniformly for large  $\boldsymbol{\eta}$  and the estimate (9.13) for the integration of a maximal vertex, we can let  $\eta_e \rightarrow \infty$  for all  $e \in L_2(\Gamma)$  (recall that the  $\eta$ 's on the leaves determine all  $\eta$  values), and conclude that  $K_{\Gamma,t=0}(\mathbf{q}_k, \mathbf{q}'_k; \mathbf{r}_{n+k}, \mathbf{r}'_{n+k})$ , for any fixed values of its argument, is bounded by a quantity converging to zero as  $\eta_e \rightarrow \infty$ , for all  $e \in L_2(\Gamma)$ . Since  $K_{\Gamma,t=0}$  is independent of  $\boldsymbol{\eta}$ , we obtain that it is zero.

Next we prove that  $\xi_{n,t}^{(k)}$  and  $\theta_{n,t}^{(k)}$  both satisfy the same equations:

$$\begin{aligned} i\partial_t \xi_{n,t}^{(k)}(\mathbf{q}_k; \mathbf{q}'_k) &= \sum_{j=1}^k (q_j^2 - (q'_j)^2) \xi_{n,t}^{(k)}(\mathbf{q}_k; \mathbf{q}'_k) + i \left( B^{(k)} \xi_{n-1,t}^{(k+1)} \right) (\mathbf{q}_k; \mathbf{q}'_k) \\ i\partial_t \theta_{n,t}^{(k)}(\mathbf{q}_k; \mathbf{q}'_k) &= \sum_{j=1}^k (q_j^2 - (q'_j)^2) \theta_{n,t}^{(k)}(\mathbf{q}_k; \mathbf{q}'_k) + i \left( B^{(k)} \theta_{n-1,t}^{(k+1)} \right) (\mathbf{q}_k; \mathbf{q}'_k). \end{aligned} \quad (9.27)$$

Since, by induction assumption,  $\xi_{n,0}^{(k)} = \theta_{n,0}^{(k)}$  and  $\xi_{n-1,t}^{(k+1)} = \theta_{n-1,t}^{(k+1)}$  for every  $k \geq 1$  and every  $t \in [0, T]$ , it follows from (9.27) that  $\xi_{n,t}^{(k)} = \theta_{n,t}^{(k)}$  for all  $k \geq 1$  and  $t \in [0, T]$ . It remains to prove (9.27).

We start by deriving the equation for  $\xi_{n,t}^{(k)}$ . To this end we compute the derivative of  $\xi_{n,t}^{(k)}$  with

respect to  $t$ .

$$\begin{aligned}
\partial_t \xi_{n,t}^{(k)} &= \int_0^t ds_2 \dots \int_0^{s_{n-1}} ds_n B^{(k)} \mathcal{U}_0^{(k+1)}(t-s_2) \dots \mathcal{U}_0^{(k+n-1)}(s_{n-1}-s_n) B^{(k+n-1)} \\
&\quad \times \mathcal{U}_0^{(k+n)}(s_n) \gamma_0^{(k+n)} \\
&+ i \sum_{j=1}^k \int_0^t ds_1 \int_0^{s_1} ds_2 \dots \int_0^{s_{n-1}} ds_n \left[ \Delta_j, \mathcal{U}_0^{(k)}(t-s_1) B^{(k)} \dots \right. \\
&\quad \left. \times \mathcal{U}_0^{(k+n-1)}(s_{n-1}-s_n) B^{(k+n-1)} \mathcal{U}_0^{(k+n)}(s_n) \gamma_0^{(k+n)} \right].
\end{aligned} \tag{9.28}$$

Hence, in Fourier space,

$$i \partial_t \xi_{n,t}^{(k)}(\mathbf{q}_k; \mathbf{q}'_k) = \sum_{j=1}^k (q_j^2 - (q'_j)^2) \xi_{n,t}^{(k)}(\mathbf{q}_k; \mathbf{q}'_k) + i \left( B^{(k)} \xi_{n-1,t}^{(k+1)} \right)(\mathbf{q}_k; \mathbf{q}'_k), \tag{9.29}$$

which proves the first equation in (9.27). Next we show the second equation in (9.27).

Using (9.9), we compute the time derivative of  $\theta_{n,t}^{(k)}$ :

$$\begin{aligned}
\partial_t \theta_{n,t}^{(k)}(\mathbf{q}_k; \mathbf{q}'_k) &= -i \sum_{\Gamma \in \mathcal{F}_{n,k}} \int d\mathbf{r}_{n+k} d\mathbf{r}'_{n+k} \gamma_0^{(n+k)}(\mathbf{r}_{n+k}; \mathbf{r}'_{n+k}) \\
&\quad \times \frac{1}{(n+k)!} \sum_{\pi_2 \in S_{n+k}} \prod_{e \in R_1(\Gamma)} (-i\tau_e) e^{-it\tau_e (q_{\pi_1(e)}^{\#e})^2} \delta(q_{\pi_1(e)}^{\#e} - r_{\pi_2(e)}^{\#e}) \\
&\quad \times \int \int_{\mathbb{R}} \prod_{e \in E_2(\Gamma)} d\alpha_e dp_e \prod_{e \in R_2(\Gamma)} \delta(p_e - q_{\pi_1(e)}^{\#e}) \prod_{e \in L_2(\Gamma)} \delta(p_e - r_{\pi_2(e)}^{\#e}) \\
&\quad \times e^{-it \sum_{e \in R_2(\Gamma)} \tau_e (\alpha_e + i\tau_e \eta_e)} \left( \sum_{e \in R_1(\Gamma)} \tau_e (q_{\pi_1(e)}^{\#e})^2 + \sum_{e \in R_2(\Gamma)} \tau_e (\alpha_e + i\tau_e \eta_e) \right) \\
&\quad \times \prod_{e \in E_2(\Gamma)} \frac{1}{\alpha_e - p_e^2 + i\tau_e \eta_e} \prod_{v \in V(\Gamma)} \delta\left(\sum_{e \in v} \pm \alpha_e\right) \delta\left(\sum_{e \in v} \pm p_e\right).
\end{aligned} \tag{9.30}$$

(Strictly speaking, this calculation is formal, since after the differentiation the  $d\alpha_e$  integral is not absolutely convergent. We will remark on this issue at the end.) We write

$$\sum_{e \in R_2(\Gamma)} \tau_e (\alpha_e + i\tau_e \eta_e) = \sum_{e \in R_2(\Gamma)} \tau_e (\alpha_e - p_e^2 + i\tau_e \eta_e) + \sum_{e \in R_2(\Gamma)} \tau_e p_e^2. \tag{9.31}$$

Because of the delta-functions  $\prod_{e \in R_2(\Gamma)} \delta(p_e - q_{\pi_1(e)}^{\#e})$ , we also have

$$\sum_{e \in R_1(\Gamma)} \tau_e (q_{\pi_1(e)}^{\#e})^2 + \sum_{e \in R_2(\Gamma)} \tau_e p_e^2 = \sum_{e \in R(\Gamma)} \tau_e (q_{\pi_1(e)}^{\#e})^2 = \sum_{j=1}^k (q_j^2 - (q'_j)^2).$$

From the last two equations we obtain

$$\begin{aligned}
i\partial_t \theta_{n,t}^{(k)}(\mathbf{q}_k; \mathbf{q}'_k) &= \sum_{\Gamma \in \mathcal{F}_{n,k}} \sum_{j=1}^k (q_j^2 - (q'_j)^2) \int d\mathbf{r}_{n+k} d\mathbf{r}'_{n+k} K_{\Gamma,t}(\mathbf{q}_k, \mathbf{q}'_k; \mathbf{r}_{n+k}, \mathbf{r}'_{n+k}) \gamma_0^{(n+k)}(\mathbf{r}_{n+k}; \mathbf{r}'_{n+k}) \\
&+ \sum_{\Gamma \in \mathcal{F}_{n,k}} \int d\mathbf{r}_{n+k} d\mathbf{r}'_{n+k} \gamma_0^{(n+k)}(\mathbf{r}_{n+k}; \mathbf{r}'_{n+k}) \\
&\times \frac{1}{(n+k)!} \sum_{\pi_2} \prod_{e \in R_1(\Gamma)} (-i\tau_e) e^{-it\tau_e (q_{\pi_1(e)}^{\#e})^2} \delta(q_{\pi_1(e)}^{\#e} - r_{\pi_2(e)}^{\#e}) \\
&\times \int \int_{\mathbb{R}} \prod_{e \in E_2(\Gamma)} d\alpha_e dp_e \prod_{e \in R_2(\Gamma)} \delta(p_e - q_{\pi_1(e)}^{\#e}) \prod_{e \in L_2(\Gamma)} \delta(p_e - r_{\pi_2(e)}^{\#e}) \\
&\times e^{-it \sum_{e \in R_2(\Gamma)} \tau_e (\alpha_e + i\tau_e \eta_e)} \left( \sum_{e \in R_2(\Gamma)} \tau_e (\alpha_e - p_e^2 + i\tau_e \eta_e) \right) \\
&\times \prod_{e \in E_2(\Gamma)} \frac{1}{\alpha_e - p_e^2 + i\tau_e \eta_e} \prod_{v \in V(\Gamma)} \delta\left(\sum_{e \in v} \pm \alpha_e\right) \delta\left(\sum_{e \in v} \pm p_e\right).
\end{aligned} \tag{9.32}$$

For a given  $\bar{e} \in R_2(\Gamma)$  let  $\bar{v} = \bar{v}(\bar{e}) \in V(\Gamma)$  be the only vertex such that  $\bar{e} \in \bar{v}$  (by definition of  $R_2(\Gamma)$  there is such vertex). Then the second term on the r.h.s. of (9.32) can be rewritten as (we use that  $L_2(\Gamma) \cap R_2(\Gamma) = \emptyset$ ):

$$\begin{aligned}
&\sum_{\Gamma \in \mathcal{F}_{n,k}} \sum_{\bar{e} \in R_2(\Gamma)} \tau_{\bar{e}} \int d\mathbf{r}_{n+k} d\mathbf{r}'_{n+k} \gamma_0^{(n+k)}(\mathbf{r}_{n+k}; \mathbf{r}'_{n+k}) \\
&\times \frac{1}{(n+k)!} \sum_{\pi_2} \prod_{e \in R_1(\Gamma)} (-i\tau_e) e^{-it\tau_e (q_{\pi_1(e)}^{\#e})^2} \delta(q_{\pi_1(e)}^{\#e} - r_{\pi_2(e)}^{\#e}) \\
&\times \int \int_{\mathbb{R}} \prod_{e \in \bar{v}} d\alpha_e dp_e e^{-it\tau_e (\alpha_{\bar{e}} + i\tau_e \eta_{\bar{e}})} \delta\left(\sum_{e \in \bar{v}} \pm \alpha_e\right) \delta\left(\sum_{e \in \bar{v}} \pm p_e\right) \\
&\times \int \int_{\mathbb{R}} \prod_{\substack{e \in E_2(\Gamma) \\ e \notin \bar{v}}} d\alpha_e dp_e \prod_{\substack{e \in R_2(\Gamma) \\ e \neq \bar{e}}} \delta(p_e - q_{\pi_1(e)}^{\#e}) \prod_{e \in L_2(\Gamma)} \delta(p_e - r_{\pi_2(e)}^{\#e}) \\
&\times e^{-it \sum_{e \in R_2(\Gamma), e \neq \bar{e}} \tau_e (\alpha_e + i\tau_e \eta_e)} \\
&\times \prod_{\substack{e \in E_2(\Gamma) \\ e \neq \bar{e}}} \frac{1}{\alpha_e - p_e^2 + i\tau_e \eta_e} \prod_{\substack{v \in V(\Gamma) \\ v \neq \bar{v}}} \delta\left(\sum_{e \in v} \pm \alpha_e\right) \delta\left(\sum_{e \in v} \pm p_e\right).
\end{aligned} \tag{9.33}$$

Next we perform the  $\alpha_{\bar{e}}$  integration. Using that, by definition of the family  $\boldsymbol{\eta}$ ,  $\eta_{\bar{e}} = \sum_{\bar{e} \neq e \in \bar{v}} \eta_e$ , and the fact that

$$\sum_{e \in \bar{v}} \pm \alpha_e = 0 \iff \tau_{\bar{e}} \alpha_{\bar{e}} = \sum_{e \in \bar{v}, e \neq \bar{e}} \tau_e \alpha_e \tag{9.34}$$

from the definition of  $\tau_e$ , we obtain

$$\int_{\mathbb{R}} d\alpha_{\bar{e}} e^{-it\tau_{\bar{e}} (\alpha_{\bar{e}} + i\tau_{\bar{e}} \eta_{\bar{e}})} \delta\left(\sum_{e \in \bar{v}} \pm \alpha_e\right) = e^{-it \sum_{\bar{e} \neq e \in \bar{v}} \tau_e (\alpha_e + i\tau_e \eta_e)}. \tag{9.35}$$



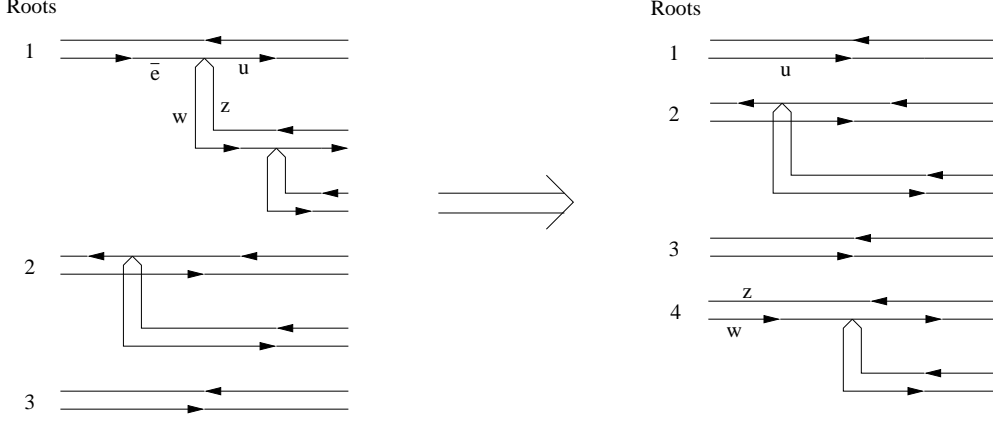

Figure 9: The map  $(\Gamma, \bar{e}) \rightarrow \tilde{\Gamma}$

Multiplying this contribution with the factor  $\exp(-it \sum_{e \in R_2(\Gamma), e \neq \bar{e}} \tau_e(\alpha_e + i\tau_e \eta_e))$  from (9.33) and using (9.34), we obtain  $\exp(-it \sum_{e \in R} \tau_e(\alpha_e + i\tau_e \eta_e))$  with  $R = \{e \in R_2(\Gamma) : e \neq \bar{e}\} \cup \{e \in \bar{v} : e \neq \bar{e}\}$ . The set  $R \cup R_1$  can be interpreted as the set of roots of a new graph, with  $k+1$  root-pairs and with  $n-1$  vertices as follows.

Given  $\Gamma \in \mathcal{F}_{n,k}$  and  $\bar{e} \in R_2(\Gamma)$ , we define a new graph  $\tilde{\Gamma} = \tilde{\Gamma}(\Gamma, \bar{e}) \in \mathcal{F}_{n-1,k+1}$  as follows: the roots of  $\tilde{\Gamma}$  are given by  $R(\tilde{\Gamma}) = \{e \in R(\Gamma) : e \neq \bar{e}\} \cup \{e \in \bar{v} : e \neq \bar{e}\}$ , that is we remove the edge  $\bar{e}$ , and we add all other edges adjacent to the vertex  $\bar{v}$  to the set of roots (recall that  $\bar{v} \in V(\Gamma)$  is the unique vertex to which  $\bar{e}$  is adjacent). The label  $\tilde{\pi}_1$  of the roots in  $\tilde{\Gamma}$  is defined so that the two unmarked son-edges of  $\bar{e}$  at the vertex  $\bar{v}$  become the  $(k+1)$ -th pair of roots of  $\tilde{\Gamma}$ , while the marked son-edge at  $\bar{v}$  inherits the label of  $\bar{e}$ , and all the other roots keep their label. The vertices and the edges of the new graph  $\tilde{\Gamma}$  are  $V(\tilde{\Gamma}) = V(\Gamma) \setminus \{\bar{v}\}$  and, respectively,  $E(\tilde{\Gamma}) = E(\Gamma) \setminus \{\bar{e}\}$ . Finally, the leaves of  $\tilde{\Gamma}$  are the same as the leaves of  $\Gamma$ , that is  $L(\Gamma) = L(\tilde{\Gamma})$ . Graphically the map from  $(\Gamma, \bar{e})$  (with  $\Gamma \in \mathcal{F}_{n,k}$  and  $\bar{e} \in R_2(\Gamma)$ ) to  $\tilde{\Gamma} \in \mathcal{F}_{n-1,k+1}$  corresponds to the cancellation of the edge  $\bar{e}$  and of the vertex  $\bar{v}$  and to moving the two new roots (the two unmarked son-edges at  $\bar{v}$ ) with their full tree graphs to the bottom of the graph (see Fig. 9).

Note that the map from  $\Gamma \in \mathcal{F}_{n,k}$  and  $\bar{e} \in R_2(\Gamma)$  to  $\tilde{\Gamma} \in \mathcal{F}_{n-1,k+1}$  is surjective but not injective: in fact for every  $\tilde{\Gamma} \in \mathcal{F}_{n-1,k+1}$  there are  $2k$  possible choices of  $\Gamma \in \mathcal{F}_{n,k}$  and  $\bar{e} \in R_2(\Gamma)$ , because the last  $(k+1)$ -th pair of roots of  $\tilde{\Gamma}$  can be attached to any of the first  $2k$  roots. This implies that the sum over  $\Gamma \in \mathcal{F}_{n,k}$  and  $\bar{e} \in R_2(\Gamma)$  in (9.33) can be replaced by a sum over  $\tilde{\Gamma} \in \mathcal{F}_{n-1,k+1}$  and a sum over the first  $k$  pair of roots of  $\tilde{\Gamma}$  plus a binary choice between the two parallel root edges.

With all these notations, (9.33) can be rewritten as

$$\begin{aligned}
& \int d\mathbf{r}_{n+k} d\mathbf{r}'_{n+k} \gamma_0^{(n+k)}(\mathbf{r}_{n+k}; \mathbf{r}'_{n+k}) \sum_{\tilde{\Gamma} \in \mathcal{F}_{n-1,k+1}} \sum_{j=1}^k \int d\tilde{\mathbf{q}}_{k+1} d\tilde{\mathbf{q}}'_{k+1} \prod_{\ell \neq j}^k \delta(q_\ell - \tilde{q}_\ell) \delta(q'_\ell - \tilde{q}'_\ell) \\
& \times \left[ \delta(q_j - \tilde{q}_j - \tilde{q}_{k+1} + \tilde{q}'_{k+1}) \delta(q'_j - \tilde{q}'_j) - \delta(q'_j - \tilde{q}'_j - \tilde{q}'_{k+1} + \tilde{q}_{k+1}) \delta(q_j - \tilde{q}_j) \right] \\
& \times \frac{1}{(n+k)!} \sum_{\pi_2} \int \int_{\mathbb{R}} \prod_{e \in E(\tilde{\Gamma})} d\alpha_e dp_e \prod_{e \in R(\tilde{\Gamma})} \delta(p_e - \tilde{q}_{\pi_1(e)}^\#) \prod_{e \in L(\tilde{\Gamma})} \delta(p_e - r_{\pi_2(e)}^\#) \\
& \times e^{-it \sum_{e \in R(\tilde{\Gamma})} \tau_e(\alpha_e + i\tau_e \eta_e)} \prod_{e \in E(\tilde{\Gamma})} \frac{1}{\alpha_e - p_e^2 + i\tau_e \eta_e} \prod_{v \in V(\tilde{\Gamma})} \delta\left(\sum_{e \in v} \pm \alpha_e\right) \delta\left(\sum_{e \in v} \pm p_e\right).
\end{aligned} \tag{9.36}$$

In the second line we rewrote the integration over the momenta  $p_e$ ,  $e \in \bar{v}$ , in (9.33), so that it is clear that it describes exactly the action of the operator  $iB^{(k)}$  (see (9.5)). From the last equation, together with (9.32), we obtain

$$i\partial_t \theta_{n,t}^{(k)}(\mathbf{q}_k; \mathbf{q}'_k) = \sum_{j=1}^k (q_j^2 - (q'_j)^2) \theta_{n,t}^{(k)}(\mathbf{q}_k; \mathbf{q}'_k) + i \left( B^{(k)} \theta_{n-1,t}^{(k+1)} \right) (\mathbf{q}_k; \mathbf{q}'_k) \quad (9.37)$$

which proves the second equation in (9.27). This completes the proof of (9.17) and (9.18).

Let us now prove (9.19). The l.h.s. of (9.19) can be rewritten as

$$\begin{aligned} & \int_0^t ds_1 \int_0^{s_1} ds_2 \dots \int_0^{s_{n-1}} ds_n \mathcal{U}_0^{(k)}(t - s_1) B^{(k)} \dots \mathcal{U}_0^{(k+n-1)}(s_{n-1} - s_n) B^{(k+n-1)} \gamma_{s_n}^{(k+n)} \\ &= \int_0^t ds \left[ \int_0^{t-s} ds_1 \int_0^{s_1} \dots \int_0^{s_{n-2}} ds_{n-1} \mathcal{U}_0^{(k)}(t - s - s_1) B^{(k)} \dots \right. \\ & \quad \left. \times \mathcal{U}_0^{(k+n-2)}(s_{n-2} - s_{n-1}) B^{(k+n-2)} \mathcal{U}_0^{(k+n-1)}(s_{n-1}) \right] B^{(k+n-1)} \gamma_s^{(k+n)}. \end{aligned} \quad (9.38)$$

From (9.17), the last expression equals

$$\omega_t^{(k)} := \int_0^t ds \sum_{\tilde{\Gamma} \in \mathcal{F}_{k,n-1}} K_{\tilde{\Gamma}, t-s} B^{(k+n-1)} \gamma_s^{(k+n)}. \quad (9.39)$$

Using (9.15) and (9.5), we obtain

$$\begin{aligned} \omega_t^{(k)}(\mathbf{q}_k; \mathbf{q}'_k) &= -i \int_0^t ds \sum_{\tilde{\Gamma} \in \mathcal{F}_{k,n-1}} \frac{1}{(n+k-1)!} \sum_{\pi_2 \in S_{n+k-1}} \sum_{j=1}^{n+k-1} \\ & \times \int d\mathbf{r}_{n+k-1} d\mathbf{r}'_{n+k-1} \int \int_{\mathbb{R}} \prod_{e \in E(\tilde{\Gamma})} d\alpha_e dp_e \prod_{e \in R(\tilde{\Gamma})} \delta(p_e - q_{\pi_1(e)}^{\#e}) \prod_{e \in L(\tilde{\Gamma})} \delta(p_e - r_{\pi_2(e)}^{\#e}) \\ & \times e^{-it \sum_{e \in R(\tilde{\Gamma})} \tau_e (\alpha_e + i\tau_e \eta_e)} \prod_{e \in E(\tilde{\Gamma})} \frac{1}{\alpha_e - p_e^2 + i\tau_e \eta_e} \prod_{v \in V(\tilde{\Gamma})} \delta\left(\sum_{e \in v} \pm \alpha_e\right) \delta\left(\sum_{e \in v} \pm p_e\right) \\ & \times \int d\mathbf{p}_{n+k} d\mathbf{p}'_{n+k} \left( \prod_{\ell \neq j} \delta(r_\ell - p_\ell) \delta(r'_\ell - p'_\ell) \right) \gamma_s^{(n+k)}(\mathbf{p}_{n+k}; \mathbf{p}'_{n+k}) \\ & \times \left[ \delta(r'_j - p'_j) \delta(r_j - (p_j + p_{n+k} - p'_{n+k})) - \delta(r_j - p_j) \delta(r'_j - (p'_j + p'_{n+k} - p_{n+k})) \right], \end{aligned} \quad (9.40)$$

where the sum over  $j$  and the last two lines correspond to the action of the operator  $B^{(n+k-1)}$  on the density  $\gamma_s^{(k+n)}$ . Note that  $j$  actually labels the leaf-pairs of  $\tilde{\Gamma}$ . Fixing  $j = 1, \dots, k+n-1$  and one of the two terms in the square bracket on the last line of (9.40) is equivalent to choosing one of the leaves of  $\tilde{\Gamma}$ . For a given  $\tilde{\Gamma}$  and  $\bar{e} \in L(\tilde{\Gamma})$ , we can define a new graph  $\Gamma \in \mathcal{F}_{n,k}$  by splitting the edge  $\bar{e}$  with a new vertex and attaching two new leaf edges to this vertex (see Fig. 10). The same graph in  $\mathcal{F}_{n,k}$  can clearly be obtained starting from different graphs  $\tilde{\Gamma} \in \mathcal{F}_{n-1,k}$ . More precisely, if we denote by  $M(\Gamma)$  the set of maximal vertices of  $\Gamma$  ( $v \in M(\Gamma)$  if  $v \in V(\Gamma)$  and there is no  $\tilde{v} \in V(\Gamma)$  with  $v \prec \tilde{v}$ ), then we find all possible  $\tilde{\Gamma}$  by removing a vertex  $\bar{v} \in M(\Gamma)$  (and deleting the son-edges of  $\bar{v}$ ). It is hence clear that, in (9.40) we can replace the sum over  $\tilde{\Gamma} \in \mathcal{F}_{n-1,k}$ , the sum

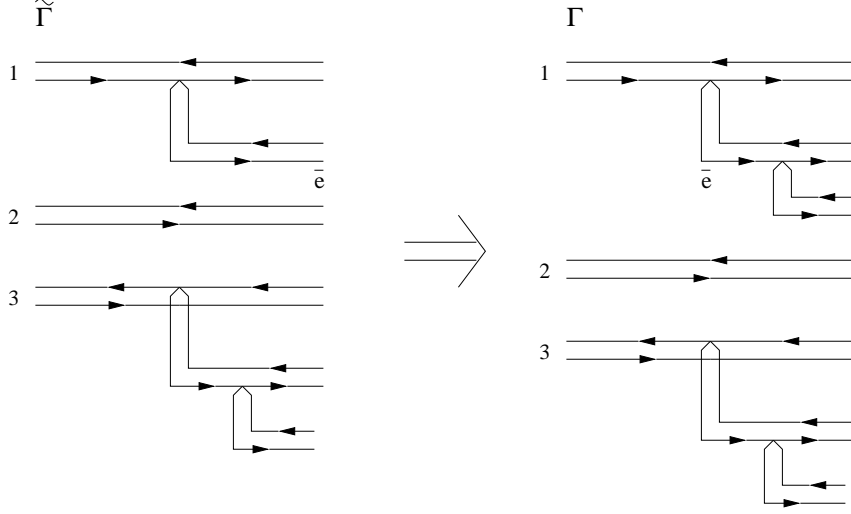

Figure 10: The map  $(\tilde{\Gamma}, \bar{e}) \rightarrow \Gamma$

over  $j \in \{1, \dots, n+k-1\}$  and the binary choice of one of the two terms in the last line, by a sum over all  $\Gamma \in \mathcal{F}_{n,k}$  and over all  $\bar{v} \in M(\Gamma)$ .

In order to rewrite (9.40) in terms of the new Feynman graph  $\Gamma \in \mathcal{F}_{n,k}$ , we observe from (9.40), that the son-edges of  $\bar{v}$  will have a momentum like all the other edges, and that momentum conservation holds at  $\bar{v}$  (see the last line of (9.40)), but they will not have any  $\alpha$ -variable, any  $\eta$ -variable, and any propagator. The labelling  $\pi_2$  of the leaves of  $\tilde{\Gamma}$  induces a labelling with  $\{1, \dots, n+k-1\}$  of the leaves of  $\Gamma$ , with the exception of the two unmarked son-edges of the chosen  $\bar{v} \in M(\Gamma)$ : these two edges are always labelled by the number  $n+k$ . Of course, because of the permutation symmetry of  $\gamma^{(n+k)}$ , we can restore a full symmetry of the leaf-variables; to this end we replace the sum over  $\pi_2 \in S_{n+k-1}$  by a sum over  $\pi_2 \in S_{n+k}$  and we replace the factor  $(n+k-1)!$  by  $(n+k)!$ . We conclude that

$$\begin{aligned}
\omega_t^{(k)}(\mathbf{q}_k; \mathbf{q}'_k) &= -i \int_0^t ds \sum_{\Gamma \in \mathcal{F}_{n,k}} \frac{1}{(n+k)!} \sum_{\pi_2 \in S_{n+k}} \sum_{\bar{v} \in M(\Gamma)} \sigma_{\bar{v}} \int d\mathbf{p}_{n+k} d\mathbf{p}'_{n+k} \\
&\times \int \prod_{e \in E(\Gamma)} dp_e \prod_{e \in E(\Gamma) \setminus S_{\bar{v}}} d\alpha_e \prod_{e \in R(\Gamma)} \delta(p_e - q_{\pi_1(e)}^{\#e}) \prod_{e \in L(\Gamma)} \delta(p_e - p_{\pi_2(e)}^{\#e}) e^{-it \sum_{e \in R(\Gamma)} \tau_e (\alpha_e + i\tau_e \eta)} \\
&\times \prod_{e \in E(\Gamma) \setminus S_{\bar{v}}} \frac{1}{\alpha_e - p_e^2 + i\tau_e \eta_e} \prod_{\bar{v} \neq v \in V(\Gamma)} \delta\left(\sum_{e \in v} \pm \alpha_e\right) \prod_{v \in V(\Gamma)} \delta\left(\sum_{e \in v} \pm p_e\right) \gamma_s^{(n+k)}(\mathbf{p}_{n+k}; \mathbf{p}'_{n+k})
\end{aligned} \tag{9.41}$$

where  $S_{\bar{v}}$  is the set of son-edges of  $\bar{v}$  and we recall that  $\sigma_{\bar{v}} = \sum_{e \in S_{\bar{v}}} \tau_e$ . From (9.16) we obtain (9.19).

Finally we comment on how to make the formal differentiation in (9.30) rigorous. In the definition (9.9) we could have defined  $K_{\Gamma, t, \eta, \varepsilon}$  instead of  $K_{\Gamma, t, \eta}$  with introducing a regularizing factor  $\exp(-\varepsilon \sum_{e \in E_2(\Gamma)} \alpha_e^2)$  in the integrals and similarly we would have defined  $\theta_{n, t, \varepsilon}^{(k)}$  in (9.26). Then the time derivative of  $\theta_{n, t, \varepsilon}^{(k)}$  can be computed by differentiating the integrand. Note that before differentiation, the  $d\alpha_e$  integrals in (9.9) are absolutely convergent and the convergence is uniform in  $\varepsilon > 0$

and  $t \in [0, T]$  for any fixed  $T$ . Therefore we obtain

$$\lim_{\varepsilon \rightarrow 0+0} \theta_{n,t,\varepsilon}^{(k)} = \theta_{n,t}^{(k)} \quad (9.42)$$

for any fixed  $n, k$  and uniformly for  $t \in [0, T]$ . In particular, the relation  $\xi_{n,t}^{(k)} = \lim_{\varepsilon \rightarrow 0+0} \theta_{n,0,\varepsilon}^{(k)} = 0$  for  $n \geq 1$  still holds. The identity (9.10) will not hold any more but

$$\lim_{\varepsilon \rightarrow 0+0} \int_{-\infty}^{\infty} \frac{d\alpha_e e^{-\varepsilon\alpha_e^2} e^{-it\tau_e\alpha_e}}{\alpha_e - p_e^2 + i\tau_e\eta} = (-i\tau_e) e^{-it\tau_e p_e^2} e^{-\eta t} \quad (9.43)$$

still holds, therefore  $\xi_{0,t}^{(k)} = \lim_{\varepsilon \rightarrow 0+0} \theta_{0,t,\varepsilon}^{(k)}$ . In the integral (9.35) we pick up a factor

$$\exp \left[ -\varepsilon \left( \sum_{\bar{e} \neq e \in \bar{v}} \pm \alpha_e \right)^2 \right]$$

which converges to 1 in the limit. The integrations in (9.36) are again absolutely convergent with or without the regularizing factors. We therefore conclude the following version of (9.37) for  $\varepsilon > 0$ :

$$i\partial_t \theta_{n,t,\varepsilon}^{(k)}(\mathbf{q}_k; \mathbf{q}'_k) = \sum_{j=1}^k (q_j^2 - (q'_j)^2) \theta_{n,t,\varepsilon}^{(k)}(\mathbf{q}_k; \mathbf{q}'_k) + i \left( B^{(k)} \theta_{n-1,t,\varepsilon}^{(k+1)}(\mathbf{q}_k; \mathbf{q}'_k) + o(1) \right) \quad (9.44)$$

as  $\varepsilon \rightarrow 0+0$ . Integrating back this system of differential equations, comparing the result with the solution to (9.29) and using that the difference in the initial conditions vanish as  $\varepsilon \rightarrow 0$ , we obtain that

$$\theta_{n,t,\varepsilon}^{(k)} = \xi_{n,t}^{(k)} + o(1)$$

for any fixed  $n, k$  and uniformly on  $t \in [0, T]$  for any fixed  $T > 0$ . Combining it with (9.42), we obtain the rigorous proof that the differentiation in (9.30) is allowed for our purposes.  $\square$

### 9.3 Bounds for Amplitudes of Feynman Graphs

For brevity, we introduce the notation

$$\langle J^{(k)}, K_{\Gamma,t} \gamma^{(n+k)} \rangle := \int d\mathbf{q}_k d\mathbf{q}'_k d\mathbf{r}_{n+k} d\mathbf{r}'_{n+k} J^{(k)}(\mathbf{q}_k; \mathbf{q}'_k) K_{\Gamma,t}(\mathbf{q}_k, \mathbf{q}'_k; \mathbf{r}_{n+k}, \mathbf{r}'_{n+k}) \gamma^{(n+k)}(\mathbf{r}_{n+k}, \mathbf{r}'_{n+k})$$

for an operator  $J^{(k)} \in \mathcal{K}_k$  with kernel  $J^{(k)}(\mathbf{q}_k; \mathbf{q}'_k)$  expressed in momentum space. We also define  $\langle J^{(k)}, L_{\Gamma,t} \gamma^{(n+k)} \rangle$  similarly. In the next two theorems we show how to bound  $\langle J^{(k)}, K_{\Gamma,t} \gamma^{(n+k)} \rangle$  and  $\langle J^{(k)}, L_{\Gamma,t} \gamma^{(n+k)} \rangle$  (for  $\Gamma \in \mathcal{F}_{n,k}$  and for an observable  $J^{(k)}$  decaying sufficiently fast in momentum space) in terms of the  $\mathcal{H}_{n+k}$ -norm of  $\gamma^{(n+k)}$ . By Theorem 9.2, this will allow us to control the Duhamel expansion (9.6) of any solution of the infinite hierarchy (9.2). Recall that the contribution  $\langle J^{(k)}, K_{\Gamma,t} \gamma^{(n+k)} \rangle$  shows up in the analysis of the fully expanded terms in (9.6), while  $\langle J^{(k)}, L_{\Gamma,t} \gamma^{(n+k)} \rangle$  shows up in the error term of (9.6).

**Theorem 9.3.** *Fix  $k \geq 1$ . For any  $n \geq 1$ , suppose  $\gamma^{(n+k)}$  is non-negative and symmetric with respect to permutations (in the sense of (1.8)). Assume  $0 < t \leq 1$ . Choose  $J^{(k)} \in \mathcal{K}_k$  that is symmetric with respect to permutations and whose kernel satisfies*

$$|J^{(k)}(\mathbf{p}_k; \mathbf{p}'_k)| \leq C \prod_{j=1}^k \frac{1}{\langle p_j \rangle^3 \langle p'_j \rangle^3}. \quad (9.45)$$

Then we have

$$\left| \langle J^{(k)}, K_{\Gamma,t} \gamma^{(n+k)} \rangle \right| \leq C^n \text{Tr} (1 - \Delta_1) \dots (1 - \Delta_{n+k}) \gamma^{(n+k)} \quad (9.46)$$

for every  $n \geq 0$ .

**Theorem 9.4.** Fix  $k \geq 1$ . For any  $n \geq 1$ , suppose  $\gamma^{(n+k)}$  is non-negative and symmetric with respect to permutations (in the sense of (1.8)). Assume  $0 < t \leq 1$ . Choose  $J^{(k)} \in \mathcal{K}_k$  symmetric with respect to permutations and with a kernel satisfying (9.45). Then, for every  $n \geq 10 + k/2$ , we have

$$\left| \langle J^{(k)}, L_{\Gamma,t} \gamma^{(n+k)} \rangle \right| \leq C^n t^{\frac{n}{4}} \text{Tr} (1 - \Delta_1) \dots (1 - \Delta_{n+k}) \gamma^{(n+k)}. \quad (9.47)$$

*Remark.* The integer  $k \geq 1$  is fixed. The constant  $C$  in (9.45) depends on  $k$ , and so do the constants on the r.h.s. of (9.46) and (9.47). The restriction  $t \leq 1$  plays no significant role in the theorems; it simplifies the proof in a trivial manner. It is also possible to obtain a  $t$ -power in (9.46) but we will not need it. Theorem 9.3 will be applied to control the fully expanded terms in the Duhamel series (9.6), which, by Theorem 9.2, can be expressed in terms of the kernels  $K_{\Gamma,t}$ . For our proof of the uniqueness of the solution to the BBGKY hierarchy, it will be sufficient to show that these terms are finite. They involve only the initial condition, therefore these terms will be identical for any solution with the same initial data. On the other hand, Theorem 9.4 will be applied to control the last term in (9.6) involving a density matrix at an intermediate time  $s_n$ . In this case it is not enough to show the finiteness of the contributions; we also need to prove that they are small. It is for this reason that in Theorem 9.4 we need to extract a time dependence and we will use the a priori bound (9.3) and that  $C^n t^{n/4} \rightarrow 0$  as  $n \rightarrow \infty$  if  $t$  is small. Note also that the power  $n/4$  in (9.47) is not optimal and we do not aim at the optimal  $t$ -dependence, but we remark that this issue is related to exploiting an additional smoothing effect of the free Schrödinger evolution.

Before proving these theorems, we point out that the estimates (9.46), (9.47) can be viewed as Strichartz type inequalities in the many particle setting. Recall that the Strichartz inequality states that

$$\int_0^t \|e^{is\Delta} f\|_p^r ds \leq C \|f\|_2^r, \quad f \in L^2(\mathbb{R}^3),$$

for  $r, p$  satisfying  $\frac{2}{r} + \frac{3}{p} = \frac{3}{2}$  and  $2 \leq r \leq \infty$ . This inequality implies that

$$\int_0^t \|e^{is\Delta} f\|_p ds \leq C t^{1-\frac{1}{r}} \|f\|_2,$$

which means that the free evolution smoothes out possible singularities of  $f$  at the expense of reducing the  $t$ -power.

Another form of the Strichartz inequality asserts that

$$\left\| \int_0^t ds e^{i(t-s)\Delta} f_s \right\|_{L_t^r L_x^p} \leq C \|f_t\|_{L_t^{r'} L_x^{p'}}, \quad f_t = f_t(x),$$

where  $L_t^r L_x^p$  denotes the space  $L^r(\mathbb{R}; L^p(\mathbb{R}^3))$  and the positive exponents  $p, r, p', r'$  satisfy

$$\frac{1}{p} + \frac{2}{3r} = \frac{1}{2}, \quad r \geq 2; \quad \frac{1}{p'} + \frac{2}{3r'} = \frac{7}{6}, \quad r' \leq 2. \quad (9.48)$$

Once again, this estimate quantifies the smoothing effect of the free evolution operator. The price of reducing the  $t$ -power is now expressed in terms of the change from the  $L^r$  norm to the  $L^{r'}$  norm in the  $t$  variable.

The kernels  $K_{\Gamma,t}$  and  $L_{\Gamma,t}$ , though defined in Green function form, actually have representations in terms of  $n$ -fold time integrations like the formulae appearing in (9.17) and (9.19) (with the operator  $B^{(m)}$  defined in (8.3)). If we replace the  $\delta$ -function (which came from the two-body interaction) in the definition of  $B^{(m)}$  by a smooth function, the correct  $t$  dependence in (9.47) would be  $t^n$  (at least for small  $t$ ). The estimate (9.47) states that the  $\delta$  interaction is allowed if we give up some power in  $t$  — in the same spirit as in the Strichartz inequality.

Each integration step on the left hand side of (9.17) and (9.19) actually involves a time integration and a space integration via the partial trace in  $B^{(m)}$ . It would therefore be natural to perform an iterative estimate involving subsequent one-particle space-time dispersive bounds. Unfortunately, we were unable to find an appropriate one-particle scheme to implement this approach. Our method is much more complicated and it involves tracking several singularity structures of the density matrices in the integration step.

One reason to use the Feynman diagram representation is to obtain estimates with correct  $n$  dependence. From the summation in the definition of  $B^{(m)}$  (see (9.4)), the number of terms on the l.h.s of (9.19) is  $2^n k(k+1)\cdots(n+k-1) \sim n!$ . This factorial can be exactly compensated by the multiple time integration,

$$\int_0^t ds_1 \int_0^{s_1} ds_2 \dots \int_0^{s_{n-1}} ds_n = \frac{t^n}{n!}, \quad (9.49)$$

but only if the  $L^1$ -norm is used in time. Higher  $L^r$ -norms in time result in a partial loss of the  $1/n!$  in (9.49) and thus the summation of these estimates over  $n$  will not converge for any  $t$ .

For this reason, we developed a new method, based on the expansions (9.17) and (9.19) in terms of Feynman graphs. Our graphical representation, among its other merits, reduces the number of terms in the expansion from  $n!$  to  $C^n$  (see (9.7)). This combinatorial reduction stems from combining graphs like b) and c) on Fig. 2. The dispersive properties of  $e^{it\Delta}$  are now captured by the decay properties of the integrands in the kernels  $K_{\Gamma,t}$ ,  $L_{\Gamma,t}$  (see (9.15), (9.16)). These multiple integrations can be successively performed and we thus obtain the bounds (9.46), (9.47). Our representation treats all smoothing effects simultaneously and thus exploits an additional decay which we were not able to obtain with one-particle methods. However, we do not know if it is possible to design a one-particle inequality similar to the Strichartz inequality to give a short proof for the estimates (9.46) and (9.47).

### 9.4 Proof of Theorem 9.3

To better explain how the dispersive properties of the free evolution are used in our approach, we first discuss the main ideas involved in the proof of (9.46) on a heuristic level; similar ideas apply to the proof of (9.47). We have to bound all integrals over the three dimensional momentum variables  $p_e$  and over the one-dimensional variables  $\alpha_e$  appearing in the definition of the kernel  $K_{\Gamma,t}$  (see (9.15)). Notice that, because of the singularity of the  $\delta$ -potential in position space, here we face a large momentum problem: we have to make sure that all integrals over  $p_e$  (and  $\alpha_e$ ) are convergent in the large  $p_e$  (respectively, large  $\alpha_e$ ) regime. To this end we will develop an integration scheme dictated by the structure of the Feynman graph  $\Gamma$ .

We will start by integrating over the variables  $p_e$  and  $\alpha_e$  associated with the leaves of  $\Gamma$ . The momenta on the leaves are exactly the variables of the density  $\gamma^{(n+k)}$ . The factor  $\text{Tr}(1 - \Delta_1) \dots (1 - \Delta_{n+k}) \gamma^{(n+k)}$  on the r.h.s. of (9.46) implies that each leaf carries a decaying factor  $|p_e|^{-(2+\lambda)}$  (for large  $p_e$ ), for any  $\lambda < 1/2$ . In the rigorous proof we will have stronger restrictions on the value of  $\lambda$ . The idea then is that we integrate over all the  $p$  and  $\alpha$  variables, starting from the leaves and then moving towards the roots. At each step we propagate the momentum decay from the son-edges to the father edge of a certain vertex of  $\Gamma$  by integrating out the variables of the son-edges.

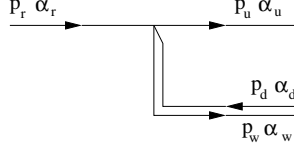

Figure 11: Integration scheme: a typical vertex

A typical step in the integration scheme is as follows: choose a vertex  $v \in V(\Gamma)$  such that we already have demonstrated a decay  $|p|^{-(2+\lambda)}$  in the momenta  $p_u, p_d, p_w$  of the three son edges of  $v$  (denoted by  $u, d$  and  $w$ , see Figure 11). This means that all the momentum- and  $\alpha$ -variables of the edges which are to the right of  $u, d$  and  $w$  in the graph have already been integrated out. Then we first perform the integration over the three  $\alpha$ -variables of the son edges. By power counting, we obtain formally

$$\int d\alpha_u d\alpha_d d\alpha_w \frac{\delta(\alpha_r = \alpha_u + \alpha_d - \alpha_w)}{\langle \alpha_u - p_u^2 \rangle \langle \alpha_d - p_d^2 \rangle \langle \alpha_w - p_w^2 \rangle} \leq \frac{\text{const}}{\langle \alpha_r - p_u^2 - p_d^2 + p_w^2 \rangle}$$

(up to logarithmic factors). Then we integrate over the momenta of the son-edges by using their decay factor and we obtain, again by simple power counting,

$$\int \frac{dp_u dp_d dp_w}{|p_u|^{2+\lambda} |p_d|^{2+\lambda} |p_w|^{2+\lambda}} \frac{\delta(p_r = p_u + p_d - p_w)}{\langle \alpha_r - p_u^2 - p_d^2 + p_w^2 \rangle} \leq \frac{\text{const}}{|p_r|^{2+\lambda}}$$

Here the power counting requires that  $3(2+\lambda) + 2 - 6 > 2 + \lambda$  which holds for any  $\lambda > 0$ . Thus the same decay in the large momentum regime propagated from the son-edges to the father edge. This procedure can then be iterated until we reach the roots of  $\Gamma$ . At that point we can complete the integration scheme by using the smoothness (momentum decay) of the observable  $J^{(k)}$ .

In this formal computation, the dispersive nature of the free evolution is expressed via the decay in  $p$  and  $\alpha$  of the resolvent  $\langle \alpha - p^2 \rangle^{-1}$ . The decay in both variables is critical to complete the integration scheme. The rigorous proof of Theorems 9.3 and 9.4 is more involved than this simple model calculation because the singularity structure of  $\langle \alpha - p^2 \rangle^{-1}$  is spherical and it cannot be described by a simple power counting alone. We will have to consider edges of various types, characterized by different decay properties, and we still have to close the iteration scheme.

*Proof of Theorem 9.3.* From the definition of  $K_{\Gamma,t}$  in (9.9), we have

$$\begin{aligned} \langle J^{(k)}, K_{\Gamma,t} \gamma^{(n+k)} \rangle &= \frac{1}{(n+k)!} \sum_{\pi_2 \in S_{n+k}} \int d\mathbf{q}_k d\mathbf{q}'_k d\mathbf{r}_{n+k} d\mathbf{r}'_{n+k} J^{(k)}(\mathbf{q}_k; \mathbf{q}'_k) \gamma^{(n+k)}(\mathbf{r}_{n+k}, \mathbf{r}'_{n+k}) \\ &\times \prod_{e \in R_1(\Gamma) = L_1(\Gamma)} (-i\tau_e) e^{-it\tau_e (q_{\pi_1(e)}^{\#e})^2} \delta(q_{\pi_1(e)}^{\#e} - r_{\pi_2(e)}^{\#e}) \\ &\times \int \prod_{e \in E_2(\Gamma)} d\alpha_e dp_e \prod_{e \in R_2(\Gamma)} \delta(p_e - q_{\pi_1(e)}^{\#e}) \prod_{e \in L_2(\Gamma)} \delta(p_e - r_{\pi_2(e)}^{\#e}) e^{-it \sum_{e \in R_2(\Gamma)} \tau_e (\alpha_e + i\tau_e \eta_e)} \\ &\times \prod_{e \in E_2(\Gamma)} \frac{1}{\alpha_e - p_e^2 + i\tau_e \eta_e} \prod_{v \in V(\Gamma)} \delta\left(\sum_{e \in v} \pm \alpha_e\right) \delta\left(\sum_{e \in v} \pm p_e\right). \end{aligned} \tag{9.50}$$

Because of the permutation symmetry of  $\gamma^{(n+k)}$ , the integral has the same value for every choice of  $\pi_2$ . Hence, instead of averaging, we fix  $\pi_2 \in S_{n+k}$ . We define the sets

$$Q_1 := \{e \in L(\Gamma) : \tau_e = 1\}, \quad \text{and} \quad Q_2 = \{e \in L(\Gamma) : \tau_e = -1\}; \quad (9.51)$$

that is  $Q_1$  is the set of outward leaves and  $Q_2$  is the set of inward leaves. Clearly  $L(\Gamma) = Q_1 \cup Q_2$  and  $|Q_1| = |Q_2| = n+k$ . We use the notation  $\gamma^{(n+k)}(\{(p_e; p_{e'})\}_{e \in Q_1})$  to stress the fact that, because of the permutation symmetry, the density  $\gamma^{(n+k)}$  only depends on the set of pairs  $(p_e; p_{e'})$  of momenta associated with the (paired) leaves of  $\Gamma$ , and not on the order of the pairs. Integrating over the variables  $\mathbf{q}_k, \mathbf{q}'_k$  and  $\mathbf{r}_{n+k}, \mathbf{r}'_{n+k}$  and using all the delta-functions, the absolute value of (9.50) can be estimated by

$$C e^{t \sum_{e \in R(\Gamma)} \eta_e} \int \prod_{e \in E(\Gamma)} dp_e \prod_{e \in E_2(\Gamma)} d\alpha_e \prod_{e \in E_2(\Gamma)} \frac{1}{|\alpha_e - p_e^2 + i\tau_e \eta_e|} \prod_{e \in R(\Gamma)} \frac{1}{\langle p_e \rangle^3} \times \prod_{v \in V(\Gamma)} \delta\left(\sum_{e \in v} \pm \alpha_e\right) \delta\left(\sum_{e \in v} \pm p_e\right) \left| \gamma^{(n+k)}(\{(p_e; p_{e'})\}_{e \in Q_1}) \right|, \quad (9.52)$$

where the factor  $\prod_{e \in R(\Gamma)} \langle p_e \rangle^{-3}$  comes from estimating the observable  $J^{(k)}$  using the assumption (9.45).

Since the observable  $J^{(k)}$  is symmetric w.r.t. permutations, and since  $K_{\Gamma,t}$  preserves the symmetry, to compute the quantity on the l.h.s. of (9.50) we can replace the density  $\gamma^{(n+k)}$  by its restriction onto the subspace  $L_s^2(\mathbb{R}^{3(n+k)})$  consisting of all permutation symmetric functions in  $L^2(\mathbb{R}^{3(n+k)})$ . Hence,  $\gamma^{(n+k)}$  can be written as  $\gamma^{(n+k)} = \sum_j \lambda_j |\psi_j\rangle \langle \psi_j|$ , with  $\psi_j \in L_s^2(\mathbb{R}^{3(n+k)})$  such that  $\|\psi_j\| = 1$  for all  $j$ , with  $\lambda_j \geq 0$  for all  $j$  (by the non-negativity of  $\gamma^{(n+k)}$ ), and with  $\sum_j \lambda_j < \infty$ . Hence it is enough to prove the bound (9.46) for  $\gamma^{(n+k)}$  being a one-dimensional projection. In the following we therefore assume that  $\gamma^{(n+k)}(\mathbf{p}_{n+k}; \mathbf{p}'_{n+k}) = \psi(\mathbf{p}_{n+k}) \bar{\psi}(\mathbf{p}'_{n+k})$ .

We again use the notation  $\psi(\{p_e\}_{e \in Q_1})$  to indicate that  $\psi$  is a function of the set of the momenta associated with leaves in  $Q_1$ , and not of their order. Moreover we choose  $\eta_e = 1/t$ , for all  $e \in L(\Gamma)$ : this implies that  $\eta_e \geq 1/t$  for every  $e \in E(\Gamma)$ , and  $\sum_{e \in R(\Gamma)} \eta_e = (2n+1)/t$ . With a weighted Schwarz inequality, we can then bound (9.52) by

$$\begin{aligned} & C e^{2n+1} \int \prod_{e \in E(\Gamma)} dp_e \prod_{e \in E_2(\Gamma)} \frac{d\alpha_e}{|\alpha_e - p_e^2 + \frac{i}{t}|} \prod_{e \in R(\Gamma)} \frac{1}{\langle p_e \rangle^3} \prod_{v \in V(\Gamma)} \delta\left(\sum_{e \in v} \pm \alpha_e\right) \delta\left(\sum_{e \in v} \pm p_e\right) \\ & \quad \times \left( \frac{\prod_{e \in Q_1} p_e^2}{\prod_{e \in Q_2} p_e^2} |\psi(\{p_e\}_{e \in Q_1})|^2 + \frac{\prod_{e \in Q_2} p_e^2}{\prod_{e \in Q_1} p_e^2} |\psi(\{p_e\}_{e \in Q_2})|^2 \right) \\ & \leq C^n \int d\mathbf{p}_{n+k} p_1^2 \cdots p_{n+k}^2 |\psi(\mathbf{p}_{n+k})|^2 \\ & \quad \times \left( \sup_{\{p_e\}_{e \in Q_1}} \int \prod_{e \in E(\Gamma) \setminus Q_1} dp_e \prod_{e \in E_2(\Gamma)} \frac{d\alpha_e}{\langle \alpha_e - p_e^2 \rangle} \prod_{e \in R(\Gamma)} \frac{1}{\langle p_e \rangle^3} \prod_{e \in Q_2} \frac{1}{p_e^2} \prod_{v \in V(\Gamma)} \delta\left(\sum_{e \in v} \pm \alpha_e\right) \delta\left(\sum_{e \in v} \pm p_e\right) \right. \\ & \quad \left. + \sup_{\{p_e\}_{e \in Q_2}} \int \prod_{e \in E(\Gamma) \setminus Q_2} dp_e \prod_{e \in E_2(\Gamma)} \frac{d\alpha_e}{\langle \alpha_e - p_e^2 \rangle} \prod_{e \in R(\Gamma)} \frac{1}{\langle p_e \rangle^3} \prod_{e \in Q_1} \frac{1}{p_e^2} \prod_{v \in V(\Gamma)} \delta\left(\sum_{e \in v} \pm \alpha_e\right) \delta\left(\sum_{e \in v} \pm p_e\right) \right) \\ & =: A + B \end{aligned} \quad (9.53)$$

where we used that, since we assumed that  $t \leq 1$ ,  $|\alpha_e - p_e^2 + i/t|^{-1} \leq \langle \alpha_e - p_e^2 \rangle^{-1}$ . In the contribution  $A$ , resulting from the first term in the parenthesis, we have taken the supremum over all momenta



$p_e$  associated with the leaves in  $Q_1$ . We will refer to this estimate as *freezing* these momenta and the corresponding legs  $e \in Q_1$  will be called *dead-edges*, the rest are called *live-edges*. In the contribution  $B$  we froze all momenta of the leaves  $Q_2$ .

In order to bound these integrals, we will successively integrate over all  $\alpha$  variables and over all non-frozen momenta starting from the leaves, until we are left with an integral involving only the momenta of the roots. Finally, we integrate out the root momenta: at this point we will also make use of the decay factor  $\prod_{e \in R(\Gamma)} \langle p_e \rangle^{-3}$  we gained from the test-function  $J^{(k)}$ .

The large  $p_e$  and large  $\alpha_e$  regimes are critical for the convergence of our integrals. The decay of the non-frozen leaf-momenta,  $|p_e|^{-2}$ , alone is not sufficient to render these integrals finite; for the intermediate edges even such decay is not available. The propagators provide extra decays,  $\langle \alpha - p_e \rangle^{-1}$ , but they may disappear (even with a possible logarithmic divergence) in the  $d\alpha_e$ -integrals. On the other hand, the delta functions of course help since they reduce the effective number of integrals. Finally, the test-function provides a strong decay for the root variables (9.45). Due to the complexity of this structure, it requires a carefully designed successive integration scheme, combined with appropriate bounds, to show that these multiple integrals are actually convergent. The precise bound will then easily follow along the same lines. Unfortunately, the scheme is complicated by fact that in certain estimates (namely when Lemma 10.3 is applied) mild local point singularities arise. This is unavoidable even if one uses weights  $\langle p_e \rangle^2$  instead of  $p_e^2$  in the Schwarz inequality in (9.53). Therefore some care is needed to avoid accumulation of local divergences. We suggest the reader to neglect this issue at the first reading and concentrate only on the large momentum regime of the estimates in the proof of (9.46).

Next we illustrate the successive integration scheme for (9.53): we consider the term  $A$ , where the momenta of the edges in  $Q_1$  (recall  $Q_1$  is the set of outward leaves) are frozen. The analysis of the  $B$  is analogous.

Since the delta functions always relate variables within the connected components of  $\Gamma$ , the integrations can be done independently in each connected component (tree) of  $\Gamma$ . The order of integration is prescribed by the tree structure: we start from the leaf-variables and proceed toward the root.

The key step is what we call *integrating out a vertex*. It consists in integrating over the  $\alpha$  variables and the momenta of the live son-edges of this vertex. The integral will be estimated in terms of the  $\alpha$ -variable and the momentum variable of the father-edge and in terms of the frozen momenta of the dead edges from the set  $\{\ell \in Q_1 : v \text{ lies on the route from } \ell \text{ to its root}\}$ . A vertex  $v$  will be integrated only when all vertices  $v'$  with  $v' \succ v$  have already been integrated out.

More precisely, we define an increasing sequence of subsets of the vertices  $V(\Gamma)$ ,  $V_1(\Gamma) \subset V_2(\Gamma) \subset \dots \subset V(\Gamma)$ , where  $V_m(\Gamma)$  contains all vertices that have been integrated out after the first  $m$  integration steps, in particular  $|V_m(\Gamma)| = m$ . In the  $(m + 1)$ -th integration step we integrate out one of the maximal vertices in the set  $V(\Gamma) \setminus V_m(\Gamma)$ . The maximality is considered with respect to the ordering defined by the restriction of  $\prec$  onto  $V(\Gamma) \setminus V_m(\Gamma)$ . After  $m = |V(\Gamma)|$  integration steps all vertices have been integrated out.

The process of integrating out each last vertex  $v$  (a vertex whose father-edge is a root) in the  $2k - |R_1(\Gamma)|$  non-trivial connected components of  $\Gamma$  is a little bit different. In this case we integrate simultaneously over the  $\alpha$ -variable of the son-edges and of the father-edge, and, like in the other vertices, we integrate over the momenta of the son-edges. Here we will estimate the integrals in terms of the momentum of the father-edge, and of the momenta of the dead leaves in the connected component we are considering. As a result, after integrating out all vertices of  $\Gamma$ , we will be left with an integral over the the momenta associated with the roots: the integrand will depend on the root-momenta, on the dead momenta and on the observable  $J^{(k)}$ .

Along the procedure we keep track of the available decay factors for each edges. Every edge

carries its own propagator,  $\langle \alpha_e - p_e^2 \rangle^{-1}$ , and we will focus on the additional decay factors. We see from (9.53) that the every momentum associated with a live leaf carries a decaying factor  $1/|p_e|^2$ . We will show that when we integrate out a vertex, a similar polynomial decaying factor can be propagated to the father-edge. Because of the propagators  $\langle \alpha_e - p_e^2 \rangle^{-1}$ , we will actually be able to gain more decay in the momenta of the father-edges, which will be available for the next integration, when the momentum of such a father-edge will be integrated out as a son-edge of the next vertex. The additional decay is typically in the form of point singularity with a power higher than 2 (i.e. of the form  $|p_e - a|^{-2-\kappa}$ ,  $\kappa > 0$ , with a possible shift  $a$  depending only on dead-momenta), but sometimes a so-called *spherical decay* in the form  $\langle \alpha_e + \beta_j + (p_e - b_j)^2 \rangle^{-1}$  arises, where the shifts  $b_j, \beta_j$  depend only on the dead-edge momenta.

We will therefore distinguish different types of edges, according to the momentum-decay they carry. For  $e \in E_2(\Gamma)$ , we define the set of vertices

$$V_e = \{v \in V(\Gamma) : e \text{ lies on the route from } v \text{ to its root}\},$$

and the set of dead leaves

$$D_e = \{\ell \in Q_1 : e \text{ lies on the route from } \ell \text{ to its root}\}. \quad (9.54)$$

We choose  $\lambda > 0$  and  $\varepsilon > 0$  sufficiently small (the correct conditions will be specified later on). Then we have the following type of edges:

i) *d*-edges: these are the dead edges, over whose momenta we do not integrate. Dead-edges are always leaves; note that one companion of each pair of leaves is dead, the other is live.

ii) 2-edges: they carry a factor

$$\frac{1}{|p_e|^2}. \quad (9.55)$$

These edges are exactly the live leaves.

iii)  $(2 + \lambda)$ -edges and  $(2 + 2\lambda)$ -edges: they carry a sum of decaying factors

$$\sum_{j=1}^{\nu(e)} \frac{1}{|p_e - a_j|^{2+\lambda}}, \quad \text{respectively} \quad \sum_{j=1}^{\nu(e)} \frac{1}{|p_e - a_j|^{2+2\lambda}} \quad (9.56)$$

where  $a_j$  are linear combinations of the momenta of the dead-edges lying in  $D_e$ . Here the number of terms,  $\nu(e)$  is bounded by  $\nu(e) \leq C^{|V_e|}$ , for a universal constant  $C$ .

iv)  $(2 + s + \kappa)$ -edges with  $\kappa = 0, \lambda, 2\lambda$ : they carry a sum of decaying factors of the form:

$$\sum_{j=1}^{\nu(e)} \frac{1}{|p_e - a_j|^{2+\kappa}} \frac{1}{\langle \alpha_e + \beta_j + (p_e - b_j)^2 \rangle^{1-\varepsilon}}. \quad (9.57)$$

Here  $a_j, b_j$ , are linear combinations of the momenta of the dead-edges in  $D_e$ , the numbers  $\beta_j$  are quadratic functions of the same momenta. The number of terms,  $\nu(e)$ , is bounded by  $\nu(e) \leq C^{|V_e|}$ , for a universal constant  $C$  (the symbol  $s$  in  $(2 + s + \kappa)$  refer to the ‘‘spherical decay’’  $\langle \alpha + \beta + (p - a)^2 \rangle^{-1+\varepsilon}$ ). If  $e$  is a root edge, then it can still be of the type  $(2 + s)$ ,  $(2 + s + \lambda)$  or  $(2 + s + 2\lambda)$ , but in this case, in (9.57) we replace  $\alpha_e$  with  $p_e^2$ .

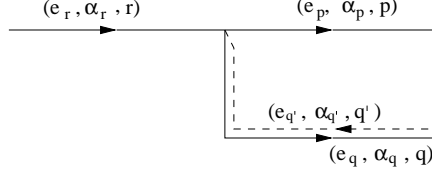

Figure 12: The vertex of transition 2)

The summations in (9.56) and (9.57) reflect different cases that originate from the fact that the three son-edges of a vertex do not play fully symmetric roles. The precise number and the possible relations among  $a_j, b_j, \beta_j$  of these terms play no role in the procedure since all our estimates will be uniform in these shift variables. The reader can therefore safely neglect the complicated structure of (9.56) and (9.57) at the first reading. The only important issue is the type of singularity and the power  $\kappa$ ; these information are carried in the shorthand notation  $2, 2 + \kappa, 2 + s + \kappa$ .

We will show that every time three edges of one of these types meet as son-edges at a vertex, the father-edge will be again of one of these types after integrating out this vertex. We will prove the following transitions, to determine the type of the father-edge after integration, given the types of the son-edges.

- 1)  $(d, d, 2 + \kappa) \rightarrow 2 + s + \kappa$ , for  $\kappa = 0, \lambda, 2\lambda$
- 2)  $(d, 2 + \kappa_1, 2 + \kappa_2) \rightarrow 2 + 2\lambda$ , for  $\kappa_{1,2} = 0, \lambda, 2\lambda$
- 3)  $(2 + \kappa_1, 2 + \kappa_2, 2 + \kappa_3) \rightarrow 2 + 2\lambda$ , for  $\kappa_{1,2,3} = 0, \lambda, 2\lambda$  with  $\kappa_1 + \kappa_2 + \kappa_3 \geq 3\lambda$  (9.58)
- 4)  $(2 + 2\lambda, 2, 2) \rightarrow 2 + \lambda$
- 5)  $(2 + s + \kappa_1, 2 + \kappa_2, 2 + \kappa_3) \rightarrow 2 + 2\lambda$  for  $\kappa_{1,2,3} = 0, \lambda, 2\lambda$

The short notation  $(A, B, C) \rightarrow D$  means that  $A, B, C$  type decays on the son-edges yields a  $D$ -type decay on the father-edge after integrating out the vertex. The order of  $A, B, C$  is irrelevant. For example, transition 2) is a short-hand writing of the following estimate:

$$\begin{aligned} \sup_{\alpha_r} \sum_{i=1}^{\nu(e_p)} \sum_{j=1}^{\nu(e_q)} \int \int_{\mathbb{R}} \frac{\delta(\alpha_r = \alpha_p + \alpha_q - \alpha_{q'}) d\alpha_p d\alpha_q d\alpha_{q'} \delta(r = p + q - q') dp dq}{\langle \alpha_p - p^2 \rangle |p - a_i|^{2+\kappa_1} \langle \alpha_q - q^2 \rangle \langle \alpha_{q'} - (q')^2 \rangle |q' - b_j|^{2+\kappa_1}} \\ \leq C \sum_{k=1}^{\nu(e_r)} \frac{1}{|r - c_k|^{2+2\lambda}} \end{aligned} \quad (9.59)$$

(see Fig. 12 for the notation, where we choose the dashed line with momentum  $q'$  to be the dead-edge for definiteness). Here  $c_k$  are linear combinations of  $a_i, b_j$  variables and of the dead edge momentum  $q'$ .

The transitions (9.58) have to be combined with the following set of rules, to see that they indeed form a closed system along the successive vertex integration. The rules are as follows:

- a) At every vertex, there are at most two  $d$ -edges. This is clear, because  $d$ -edges are always outward pointing leaves, and it is impossible to have a vertex with three son-edges having the same orientation.
- b) At every vertex, there are at most two 2-edges: this follows analogously to a), because all 2-edges are inward pointing leaves.

- c) There is no vertex with son-edges  $(2 + \lambda, 2, 2)$ . Note that the  $(2 + \lambda)$ -edge can only result as the father-edge of a vertex with son-edges  $(2, 2, 2 + 2\lambda)$ , and thus (since the 2-edges always point inward) it must have inward orientation. But all three son-edges of a vertex cannot have the same orientation.
- d) There is no vertex with son-edges  $(2 + \lambda, 2 + \lambda, 2)$ . As we have seen in b) and c), all 2-edges and  $(2 + \lambda)$ -edges have inward orientation and all three son-edges of a vertex cannot have the same orientation.

Combining these rules with the transitions in (9.58), and observing that the spherical denominator  $\langle \alpha + \beta + (p - a_j)^2 \rangle^{-1+\varepsilon}$  can be always estimated by one (i.e.  $+s$  can always be removed from  $2 + s + \kappa$  for free), we see that we have a closed system starting solely from  $d$ -edges and 2-edges. Along the integration, every edge in  $\Gamma$  will become one of the types described in i)-iv) above and each vertex integration corresponds to one of the steps 1)-5).

Before proving the transitions 1)-5) rigorously, let us indicate their validity by a simple power counting argument. All integrals are locally convergent if  $\lambda < 1/3$ , so it is sufficient to focus on their large momentum (short distance) behavior. The integration variables  $p_e$  are momentum variables with dimension  $[length]^{-1}$ . Because of the propagators  $\langle \alpha_e - p_e^2 \rangle^{-1}$ , the  $\alpha_e$  variables have the same dimension as  $p_e^2$ , i.e.  $[length]^{-2}$ . Hence the three propagators associated with the three son-edges always have the dimension  $[length]^6$ .

In the transition 1), we have effectively two  $\alpha$  integrations and no momentum integration. In fact, there are three  $\alpha$ -variables and one live momentum associated with the three son-edges of the vertex under consideration; but, because of the  $\delta$ -functions  $\delta(\sum_{e \in v} \pm \alpha_e)$  and  $\delta(\sum_{e \in v} \pm p_e)$ , we only have to perform two  $\alpha$  integration. Each  $d\alpha$ -integration carries the dimension  $[length]^{-2}$ . Since the momentum decay factor associated with the  $2 + \kappa$ -edge has the dimension  $[length]^{2+\kappa}$ , the result of the integral has the dimension  $[length]^{6-2 \cdot 2+(2+\kappa)} = [length]^{4+\kappa}$ . The r.h.s. of 1), on the other hand, has the dimension  $[length]^{4+\kappa-2\varepsilon}$ . Therefore  $\varepsilon > 0$  guarantees that in the relevant short distance regime, the r.h.s is indeed bigger than the l.h.s., as the corresponding exponent on the r.h.s is smaller than the exponent on the left. We lose some decay in our estimates to compensate for logarithmic factors.

In the transition 2), we have effectively two  $\alpha$ -integrations and one momentum integration ( $dp_e$  has the dimension  $[length]^{-3}$ ): hence the left side of 2) has the dimensions  $[length]^{3+\kappa_1+\kappa_2}$ , while the r.h.s. has the dimension  $[length]^{2+2\lambda}$ . For  $\lambda$  small enough, the exponent on the right is smaller than the exponent on the left.

In 3),4), and 5) we have two  $\alpha$ - and two momentum integrations. The dimension of the left side of 3) is  $[length]^{2+\kappa_1+\kappa_2+\kappa_3}$ ; the right side has the dimension  $[length]^{2+2\lambda}$ . This explains where the condition  $\kappa_1 + \kappa_2 + \kappa_3 \geq 3\lambda$  comes from. The transition 4) is similar. As for 5), the left side has the dimension  $[length]^{4+\kappa_1+\kappa_2+\kappa_3}$ , and the right side has the dimension  $[length]^{2+2\lambda}$ : again, for  $\lambda$  small enough, the exponent on the left is larger than the exponent on the right.

Next, we give a rigorous proof of the transitions (9.58). Choose a vertex  $v \in V(\Gamma)$  and assume we already performed the integration over all  $v' \succ v$ . We start by performing the integration over the  $\alpha$ -variables associated with the son-edges of the vertex  $v$ . Let  $e_r$  denote the father edge of the vertex  $v$  (see Fig. 13). We distinguish two cases according to whether  $e_r$  is the root or not.

Suppose first that  $e_r$  is not a root (that is  $v$  is not the last vertex left). If there is no spherical denominator among the son-edges, that is, if the son-edges are all of the type  $d$ ,  $2$ ,  $2 + \lambda$  or  $2 + 2\lambda$ , then we estimate the  $\alpha$ -integrations, for a fixed and small enough  $\varepsilon > 0$ , by (with the notation of

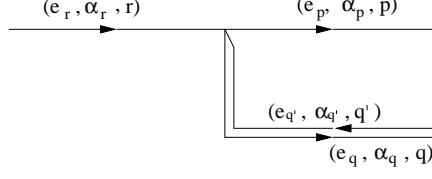

Figure 13: Integrating out a vertex

Fig. 13):

$$\begin{aligned}
& \int d\alpha_p d\alpha_q d\alpha_{q'} \delta(\alpha_r = \alpha_p + \alpha_q - \alpha_{q'}) \frac{1}{\langle \alpha_p - p^2 \rangle \langle \alpha_q - q^2 \rangle \langle \alpha_{q'} - (q')^2 \rangle} \\
&= \int d\alpha_p d\alpha_q \frac{1}{\langle \alpha_p - p^2 \rangle \langle \alpha_q - q^2 \rangle \langle \alpha_r - \alpha_p - \alpha_q + (q')^2 \rangle} \\
&\lesssim \frac{1}{\langle \alpha_r - p^2 - q^2 + (q')^2 \rangle^{1-\varepsilon}},
\end{aligned} \tag{9.60}$$

where we applied Lemma 10.1 twice, once in the  $\alpha_q$  and once in the  $\alpha_p$ -integration (after estimating  $\langle \alpha \rangle^{-1} \leq |\alpha|^{-1+\delta}$ , for a sufficiently small  $\delta > 0$ ). On the other hand, if one of the son-edges (say the  $e_p$  edge in Fig. 13) is of the type  $2 + s$ ,  $2 + s + \lambda$  or  $2 + s + 2\lambda$ , then we use the bound

$$\begin{aligned}
& \int d\alpha_p d\alpha_q d\alpha_{q'} \frac{\delta(\alpha_r = \alpha_p + \alpha_q - \alpha_{q'})}{\langle \alpha_p - p^2 \rangle \langle \alpha_p + \beta + (p-a)^2 \rangle^{1-\varepsilon} \langle \alpha_q - q^2 \rangle \langle \alpha_{q'} - (q')^2 \rangle} \\
&= \int d\alpha_p d\alpha_q \frac{1}{\langle \alpha_p - p^2 \rangle \langle \alpha_p + \beta + (p-a)^2 \rangle^{1-\varepsilon} \langle \alpha_q - q^2 \rangle \langle \alpha_r - \alpha_p - \alpha_q + (q')^2 \rangle} \\
&\lesssim \int \frac{d\alpha_p}{\langle \alpha_p \rangle \langle \alpha_p + p^2 + \beta + (p-a)^2 \rangle^{1-\varepsilon} \langle \alpha_r - \alpha_p - p^2 - q^2 + (q')^2 \rangle} \\
&\lesssim \frac{1}{\langle \beta + p^2 + (p-a)^2 \rangle^{1-\varepsilon}} \int d\alpha_p \left( \frac{1}{\langle \alpha_p \rangle} + \frac{1}{\langle \alpha_p + \beta + p^2 + (p-a)^2 \rangle} \right) \frac{1}{\langle \alpha_r - \alpha_p - p^2 - q^2 + (q')^2 \rangle} \\
&\lesssim \frac{1}{\langle \tilde{\beta} + (p-\tilde{a})^2 \rangle^{1-\varepsilon}} \left( \frac{1}{\langle \alpha_r - p^2 - q^2 + (q')^2 \rangle^{1-\varepsilon}} + \frac{1}{\langle \alpha_r + \beta + (p-a)^2 - q^2 + (q')^2 \rangle^{1-\varepsilon}} \right).
\end{aligned} \tag{9.61}$$

where  $\tilde{\beta}$  and  $\tilde{a}$ , like  $\beta$  and  $\alpha$  depend only on the frozen momenta associated to the dead leaves in  $D_{e_r}$  (see the definition (9.54)).

Suppose now that  $e_r$  is a root, that is there is no vertex  $\tilde{v}$  with  $\tilde{v} \prec v$ . In this case we also integrate over the  $\alpha$  variable associated with the father-edge  $e_r$ . We use

$$\begin{aligned}
& \int d\alpha_r d\alpha_p d\alpha_q d\alpha_{q'} \delta(\alpha_r = \alpha_p + \alpha_q - \alpha_{q'}) \frac{1}{\langle \alpha_r - r^2 \rangle \langle \alpha_p - p^2 \rangle \langle \alpha_q - q^2 \rangle \langle \alpha_{q'} - (q')^2 \rangle} \\
&= \int d\alpha_r d\alpha_p d\alpha_q \frac{1}{\langle \alpha_r - r^2 \rangle \langle \alpha_p - p^2 \rangle \langle \alpha_q - q^2 \rangle \langle \alpha_r - \alpha_p - \alpha_q + (q')^2 \rangle} \\
&\lesssim \frac{1}{\langle r^2 - p^2 - q^2 + (q')^2 \rangle^{1-\varepsilon}},
\end{aligned} \tag{9.62}$$

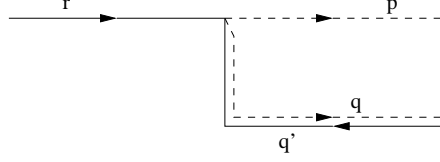

Figure 14: A vertex with two dead edges

if there is no spherical singularity in the son-edges, and

$$\int d\alpha_r d\alpha_p d\alpha_q d\alpha_{q'} \frac{\delta(\alpha_r = \alpha_p + \alpha_q - \alpha_{q'})}{\langle \alpha_r - r^2 \rangle \langle \alpha_p - p^2 \rangle \langle \alpha_p + \beta + (p - a)^2 \rangle^{1-\varepsilon} \langle \alpha_q - q^2 \rangle \langle \alpha_{q'} - (q')^2 \rangle} \lesssim \frac{1}{\langle \tilde{\beta} + (p - \tilde{a})^2 \rangle^{1-\varepsilon}} \left( \frac{1}{\langle r^2 - p^2 - q^2 + (q')^2 \rangle^{1-\varepsilon}} + \frac{1}{\langle r^2 + \beta + (p - a)^2 - q^2 + (q')^2 \rangle^{1-\varepsilon}} \right). \quad (9.63)$$

if there is a spherical denominator in the son-edges.

Next we have to estimate the momenta integrations. Let us first consider the case 1) in (9.58). Since we have two dead edges and one momentum delta-function, effectively no integration needs to be done. With the notation of Fig. 14, where dashed lines indicate dead-edges, we obtain, using the result of (9.60),

$$\int \frac{dq'}{|q' - a|^{2+\kappa}} \frac{\delta(r = p + q - q')}{\langle \alpha_r - p^2 - q^2 + (q')^2 \rangle^{1-\varepsilon}} = \frac{1}{|r - b|^{2+\kappa}} \frac{1}{\langle \alpha_r + \beta + (r - c)^2 \rangle^{1-\varepsilon}} \quad (9.64)$$

where  $\kappa$  can assume the values  $0, \lambda, 2\lambda$ , and  $\beta$ ,  $b, c$  depend on  $a$  and on the frozen momenta  $p, q$ . If  $e_r$  is a root, then, according to (9.62), we replace  $\alpha_r$  by  $r^2$  in (9.64). This proves 1) (note that the two dead edges always have the same orientation: with the notation of Fig. 14, it is impossible, for example, that  $p$  and  $q'$  are both dead).

The transition 2) is proven, using the result of (9.60) (or (9.62), if the father-edge is a root) in Proposition 10.4 (where  $\kappa_1, \kappa_2$  can assume the values  $0, \lambda$  and  $2\lambda$ ), under the conditions  $\lambda < 1/6$  and  $\varepsilon < 1/3$ . Note that the vertices of the type 2) involve two integrals, but because of the  $\delta$ -function from the momentum conservation, one integral is a trivial substitution.

The transitions 3) and 4) are proven in Proposition 10.6, using the result of the  $\alpha$ -integration (9.60) (or (9.62) if the father-edge is a root) under the condition that  $\lambda < 1/6$  and  $\varepsilon < \lambda/2$ . Finally, the transition 5) is shown, using the result of (9.61) (or (9.63), if the father-edge is a root), in Proposition 10.7 (with  $\lambda$  replaced by  $2\lambda$ ), under the condition that  $\kappa_1 + \kappa_2 + \kappa_3 \leq 2\lambda$  and that  $\lambda < 1/10$  and  $\varepsilon < \lambda$ . If  $\kappa_1 + \kappa_2 + \kappa_3 > 2\lambda$ , then we can drop the denominator with the spherical singularity, and use the transition 4) to prove 5). Therefore, assuming that  $0 < \lambda < 1/10$  and  $0 < \varepsilon < \lambda/2$ , we have proven the transitions 1)-5) in (9.58).

After integrating over all vertices in the graph  $\Gamma$  we are left with an integral over the momenta of the roots in  $R(\Gamma) \setminus Q_1$  (a trivial root can be dead). Recall that we already integrated over the  $\alpha$ -variable associated to the roots (we performed this integration together with the integration over the  $\alpha$ -variables of the son-edges of the roots in (9.62) and (9.63)). Estimating all the spherical

denominators left by one, we obtain from (9.53) that

$$\begin{aligned}
A &\leq C^n \left( \int d\mathbf{p}_{n+k} p_1^2 \cdots p_{n+k}^2 |\psi(\mathbf{p}_{n+k})|^2 \right) \\
&\quad \times \sup_{\{p_e\}_{e \in Q_1}} \prod_{e \in R(\Gamma) \cap Q_1} \frac{1}{\langle p_e \rangle^3} \prod_{e \in R(\Gamma) \setminus Q_1} \left( \sum_{j=1}^{\nu(e)} \int \frac{dp_e}{|p_e - a_{e,j}|^{2+\kappa_e} \langle p_e \rangle^3} \right)
\end{aligned} \tag{9.65}$$

where, for every  $e$ ,  $\kappa_e = 0, \lambda$  or  $2\lambda$ , where  $a_{e,j}$  are linear combinations of the momenta associated to dead leaves in  $D_e$ , and where the number of terms  $\nu(e)$  is bounded by  $\nu(e) \leq C^{|V_e|}$ . Since the integrals are uniformly bounded in the dead-momenta, and since  $\sum_{e \in R(\Gamma) \setminus Q_1} |V_e| = n$ , it immediately follows that

$$A \leq C^n \left( \int d\mathbf{p}_{n+k} p_1^2 \cdots p_{n+k}^2 |\psi(\mathbf{p}_{n+k})|^2 \right). \tag{9.66}$$

In the same way we can prove that the term  $B$  in (9.53) satisfies the same bound. Hence we conclude that

$$\begin{aligned}
&\left| \int d\mathbf{q}_k d\mathbf{q}'_k d\mathbf{r}_{n+k} d\mathbf{r}'_{n+k} J^{(k)}(\mathbf{q}_k; \mathbf{q}'_k) K_{\Gamma,t}(\mathbf{q}_k, \mathbf{q}'_k; \mathbf{r}_{n+k}, \mathbf{r}'_{n+k}) \gamma^{(n+k)}(\mathbf{r}_{n+k}, \mathbf{r}'_{n+k}) \right| \\
&\leq C^n \text{Tr} (1 - \Delta_1) \cdots (1 - \Delta_{n+k}) \gamma^{(n+k)} \tag{9.67}
\end{aligned}$$

for every  $t \leq 1$ . □

## 9.5 Proof of Theorem 9.4

Despite the obvious analogy, the bound (9.47) cannot be directly reduced to (9.46). The reason is that there are three propagators missing at the truncated vertex  $\bar{v}$  that appears in the definition (9.16). Their missing decays need to be propagated through the whole integration procedure until the strong decay of the observable  $J$  will compensate for them. For this reason, edges carrying a momentum decay of the type i)-iv) introduced in (9.55)-(9.57) are not sufficient to prove (9.47), and we need to introduce additional types of decay. Of course this also requires to consider additional vertex integrations, slightly different from the transitions 1)-5) in (9.58).

*Proof of Theorem 9.4.* As in the proof of Theorem 9.3, it is enough to prove (9.47) for rank-one projectors,  $\gamma^{(n+k)}(\mathbf{p}_{n+k}; \mathbf{p}'_{n+k}) = \psi(\mathbf{p}_{n+k}) \bar{\psi}(\mathbf{p}'_{n+k})$ , for a  $\psi \in L_s^2(\mathbb{R}^{3(n+k)})$ ; the general case follows then from the expansion

$$\gamma^{(n+k)}(\mathbf{p}_{n+k}; \mathbf{p}'_{n+k}) = \sum_j \lambda_j \psi_j(\mathbf{p}_{n+k}) \bar{\psi}_j(\mathbf{p}'_{n+k}), \quad \text{with } \psi_j \in L_s^2(\mathbb{R}^{3(n+k)}), \quad \|\psi_j\| = 1, \quad \forall j$$

where the eigenvalues of  $\gamma^{(n+k)}$  satisfy  $\lambda_j \geq 0$  for all  $j$  and  $\sum_j \lambda_j < \infty$ .

In order to prove (9.47) we start with the expression (9.16). Recall that if there is only one denominator containing  $\alpha_e$ , then the  $d\alpha_e$  integral would not be absolutely convergent, so this integration has to be performed before taking the absolute value. This was the reason behind distinguishing the roots of the trivial components,  $R_1(\Gamma)$ , in (9.9). For the kernel  $L_{\Gamma,t}$ , the same problem arises for the component containing  $\bar{v} \in M(\Gamma)$  (see (9.16)), if this component has only one vertex. This justifies the following definition.

For a given  $\Gamma \in \mathcal{F}_{n,k}$  and  $\bar{v} \in M(\Gamma)$ , we define the set of edges  $\tilde{E}_2(\Gamma, \bar{v})$  as follows: if there exists  $\bar{e} \in R(\Gamma)$  such that  $\bar{e} \in \bar{v}$ , then  $\tilde{E}_2(\Gamma, \bar{v}) := E_2(\Gamma) \setminus \{\bar{e}\}$ . Otherwise  $\tilde{E}_2(\Gamma, \bar{v}) := E_2(\Gamma)$ . In the former

case, starting from (9.16), we perform the integration over the  $\alpha_{\bar{e}}$  using (9.10) before we take the absolute value; in other words, we treat  $\bar{e}$  as the trivial roots in  $R_1(\Gamma)$ . This is necessary because, since the son-edges of  $\bar{v}$  do not carry a propagator, there is only one denominator containing  $\alpha_{\bar{e}}$  and the  $d\alpha_e$  integral is not absolutely convergent. After performing the integration over all  $\alpha_e$  associated to  $e \notin \tilde{E}_2(\Gamma, \bar{v})$ , we take the absolute value of the integrand, and we conclude that (9.47) is bounded, similarly to (9.53), by (recall that we take here  $\gamma^{(n+k)}(\mathbf{p}_{n+k}; \mathbf{p}'_{n+k}) = \psi(\mathbf{p}_{n+k})\bar{\psi}(\mathbf{p}'_{n+k})$ )

$$\begin{aligned}
& C^n \int d\mathbf{p}_{n+k} \langle p_1 \rangle^2 \dots \langle p_{n+k} \rangle^2 |\psi(\mathbf{p}_{n+k})|^2 \\
& \times \left( \sup_{\{p_e\}_{e \in Q_1}} \sum_{\bar{v} \in M(\Gamma)} \int \prod_{e \in E(\Gamma) \setminus Q_1} dp_e \prod_{e \in \tilde{E}_2(\Gamma, \bar{v}) \setminus S_{\bar{v}}} \frac{d\alpha_e}{|\alpha_e - p_e^2 + \frac{i}{t}|} \prod_{e \in R(\Gamma)} \frac{1}{\langle p_e \rangle^3} \right. \\
& \quad \times \prod_{e \in Q_2 \setminus S_{\bar{v}}} \frac{1}{p_e^2} \prod_{e \in Q_2 \cap S_{\bar{v}}} \frac{1}{\langle p_e \rangle^2} \prod_{\bar{v} \neq v \in V(\Gamma)} \delta(\sum_{e \in v} \pm \alpha_e) \prod_{v \in V(\Gamma)} \delta(\sum_{e \in v} \pm p_e) \\
& + \sup_{\{p_e\}_{e \in Q_2}} \sum_{\bar{v} \in M(\Gamma)} \int \prod_{e \in E(\Gamma) \setminus Q_2} dp_e \prod_{e \in \tilde{E}_2(\Gamma, \bar{v}) \setminus S_{\bar{v}}} \frac{d\alpha_e}{|\alpha_e - p_e^2 + \frac{i}{t}|} \prod_{e \in R(\Gamma)} \frac{1}{\langle p_e \rangle^3} \\
& \quad \left. \times \prod_{e \in Q_1 \setminus S_{\bar{v}}} \frac{1}{p_e^2} \prod_{e \in Q_1 \cap S_{\bar{v}}} \frac{1}{\langle p_e \rangle^2} \prod_{\bar{v} \neq v \in V(\Gamma)} \delta(\sum_{e \in v} \pm \alpha_e) \prod_{v \in V(\Gamma)} \delta(\sum_{e \in v} \pm p_e) \right). \tag{9.68}
\end{aligned}$$

Recall that  $S_{\bar{v}}$  denotes the set of son-edges of  $\bar{v}$  and that  $Q_1$  and  $Q_2$  denote the set of outward and, respectively, inward leaves (9.51). Note that the weights in the Schwarz inequality are somewhat different from the ones used in (9.53): we take the decay factor  $\langle p \rangle^{-2}$  instead of  $|p|^{-2}$  in the son-edges of the vertex  $\bar{v}$  (the reason will be clear later on). Moreover, in contrast to (9.53), we keep track of the  $1/t$  factors in the propagators to detect the short time behavior. To do so, we select  $\eta_e = t^{-1}$  for all leaf-edges,  $e \in L(\Gamma)$ , and notice that for an arbitrary  $e \in E(\Gamma)$  the value of  $\eta_e$  is  $t^{-1}$  times the number of edges in the subgraph of descendants of  $e$ . In particular

$$\sum_{e \in R(\Gamma)} \eta_e = t^{-1} \cdot (3n)$$

since the total number of non-root edges is  $3n$ . Therefore every propagator in (9.16) carries at least the regularization  $t^{-1}$  (that is  $\eta_e \geq t^{-1}$ , for all  $e \in E(\Gamma)$ ); on the other side, the exponential prefactor is at most  $e^{3n} = C^n$  after taking absolute value. This justifies (9.68).

To scale out the  $t$  variables, we rescale  $p_e$ , for all  $e \in E(\Gamma)$ , and we rescale  $\alpha_e$ , for  $e \in \tilde{E}_2(\Gamma, \bar{v}) \setminus S_{\bar{v}}$  as

$$p_e \rightarrow t^{-\frac{1}{2}} p_e \quad \text{for } e \in E(\Gamma) \quad \text{and} \quad \alpha_e \rightarrow \alpha_e t^{-1} \quad \text{for } e \in \tilde{E}_2(\Gamma, \bar{v}) \setminus S_{\bar{v}}.$$

Then

$$\frac{d\alpha_e}{|\alpha_e - p_e^2 + \frac{i}{t}|} \rightarrow \frac{d\alpha_e}{|\alpha_e - p_e^2 + i|}, \quad \delta(\sum_{e \in v} \pm \alpha_e) \rightarrow t \delta(\sum_{e \in v} \pm \alpha_e), \quad \delta(\sum_{e \in v} \pm p_e) \rightarrow t^{3/2} \delta(\sum_{e \in v} \pm p_e).$$



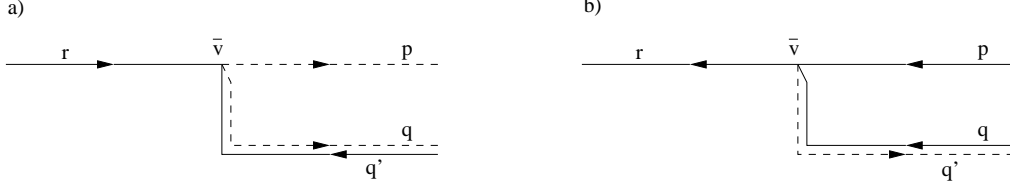

Figure 15: Integrating out the vertex  $\bar{v}$

From (9.68) we can bound (9.47) by (recall  $t \leq 1$ )

$$\begin{aligned}
& C^n t^{\frac{n-k}{2}-3} \int d\mathbf{p}_{n+k} \langle p_1 \rangle^2 \dots \langle p_{n+k} \rangle^2 |\psi(\mathbf{p}_{n+k})|^2 \\
& \times \left( \sup_{\{p_e\}_{e \in Q_1}} \sum_{\bar{v} \in M(\Gamma)} \int \prod_{e \in E(\Gamma) \setminus Q_1} dp_e \prod_{e \in \tilde{E}_2(\Gamma, \bar{v}) \setminus S_{\bar{v}}} \frac{d\alpha_e}{\langle \alpha_e - p_e^2 \rangle} \prod_{e \in R(\Gamma)} \frac{1}{\langle t^{-\frac{1}{2}} p_e \rangle^3} \right. \\
& \quad \times \prod_{e \in Q_2 \setminus S_{\bar{v}}} \frac{1}{p_e^2} \prod_{e \in Q_2 \cap S_{\bar{v}}} \frac{1}{\langle p_e \rangle^2} \prod_{\substack{v \in V(\Gamma) \\ v \neq \bar{v}}} \delta(\sum_{e \in v} \pm \alpha_e) \prod_{v \in V(\Gamma)} \delta(\sum_{e \in v} \pm p_e) \\
& + \sup_{\{p_e\}_{e \in Q_2}} \sum_{\bar{v} \in M(\Gamma)} \int \prod_{e \in E(\Gamma) \setminus Q_2} dp_e \prod_{e \in \tilde{E}_2(\Gamma, \bar{v}) \setminus S_{\bar{v}}} \frac{d\alpha_e}{\langle \alpha_e - p_e^2 \rangle} \prod_{e \in R(\Gamma)} \frac{1}{\langle t^{-\frac{1}{2}} p_e \rangle^3} \\
& \quad \times \left. \prod_{e \in Q_1 \setminus S_{\bar{v}}} \frac{1}{p_e^2} \prod_{e \in Q_1 \cap S_{\bar{v}}} \frac{1}{\langle p_e \rangle^2} \prod_{\substack{v \in V(\Gamma) \\ v \neq \bar{v}}} \delta(\sum_{e \in v} \pm \alpha_e) \prod_{v \in V(\Gamma)} \delta(\sum_{e \in v} \pm p_e) \right) \\
& =: A_L + B_L.
\end{aligned} \tag{9.69}$$

Note that here we rescale also the frozen momenta with  $t^{-1/2}$ : of course this is allowed, since we take the supremum over them. For  $e \in Q_2 \cap S_{\bar{v}}$  in the term  $A_L$  (and for  $e \in Q_1 \cap S_{\bar{v}}$  in  $B_L$ ), we used that  $\langle t^{-1/2} p_e \rangle^{-2} \leq \langle p_e \rangle^{-2}$  (because  $0 < t \leq 1$ ). We show how to control  $A_L$ , where the outward leaves are dead; the proof for  $B_L$  is then analogous.

To estimate  $A_L$  we proceed very similarly as in our analysis of the contribution  $A$  in (9.53). But here we first have to get rid of the vertex  $\bar{v}$ , whose son-edges do not have propagators. We distinguish two cases.

In the first case, we assume that  $\bar{v}$  is a vertex involving two dead-edges (see Fig. 15, part a)). Then the momentum integration at  $\bar{v}$  (there is no  $\alpha$ -integration here) gives

$$\int \frac{dq'}{\langle q' \rangle^2} \delta(r - (p + q - q')) = \frac{1}{\langle r - p - q \rangle^2} \leq \frac{1}{|r - p - q|^{1+2\lambda}} \tag{9.70}$$

for  $\lambda > 0$  small enough. Edges carrying such a decay will be called  $(1 + 2\lambda)$ -edges, similarly to the notation introduced in i)-iv) above (see (9.55)-(9.57)). Note that in the last inequality, we dropped part of the decay for large momenta: this simplifies a little bit the classification of the possible types of edges in  $\Gamma$  (see the points v)-vii) below). Here we used the fact that in (9.69) we chose the decay  $\langle p_e \rangle^{-2}$  instead of  $|p_e|^{-2}$  for the son-edges of the vertex  $\bar{v}$  to avoid an irrelevant complication in the short momentum regime.

In the second case, if  $\bar{v}$  only involves one dead-edge (there is always at least one dead edge

adjacent to  $\bar{v}$ ), then we obtain (see Fig. 15, part b))

$$\int \frac{dpdq}{\langle p \rangle^2 \langle q \rangle^2} \delta(r - (p + q - q')) \lesssim \frac{C}{|r + q'|}. \quad (9.71)$$

In this case, the father-edge of the  $\bar{v}$ -vertex will be called a type 1-edge.

After dealing with the vertex  $\bar{v}$ , we are faced with the problem of integrating out the other  $n - 1$  vertices of  $\Gamma$ . This is very similar to the problem we encountered when we proved the bound (9.46): every non-trivial edge carries now a propagator  $\langle \alpha_e - p_e^2 \rangle^{-1}$  exactly as in (9.53). Here an edge is called trivial if it is a trivial root or if it is a root adjacent to  $\bar{v}$ . The difference is that now we start with more types of edges (in the analysis of  $K_{\Gamma,t}$ , we started solely with  $d$ - and 2-edges; here we also have a 1- or a  $1 + 2\lambda$ -edge): this implies that, integrating out the other  $n - 1$  vertices, we will create new types of edges, which were not defined in i)-iv) (see (9.55)-(9.57) in the proof of Theorem 9.3). Therefore, we have to supplement the definitions i)-iv) with the following new types of edges.

v) 1-edges: they carry a decaying factor:

$$\frac{1}{|p_e - a|},$$

where  $a$  is a linear combination of the dead momenta in  $D_e$ . As we will see, there can be only one 1-edge along the integration procedure; it is the father-edge of  $\bar{v}$ , if it is not a root and if only one of the son-edges of  $\bar{v}$  is a dead edge (case b) in Fig. 15). In this case the two live son-edges have inward orientation, so does the father-edge of  $\bar{v}$ , therefore the 1-edge is always inward.

vi)  $(1 + \lambda)$ -edges and  $(1 + 2\lambda)$ -edges: they carry a sum of decaying factors

$$\sum_{j=1}^{\nu(e)} \frac{1}{|p_e - a_j|^{1+\lambda}}, \quad \text{respectively} \quad \sum_{j=1}^{\nu(e)} \frac{1}{|p_e - a_j|^{1+2\lambda}} \quad (9.72)$$

where  $a_j$  are linear combinations of the momenta of the dead-edges lying in  $D_e$ . Here the number of terms,  $\nu(e)$  is bounded by  $\nu(e) \leq C^{|V_e|}$ , for a universal constant  $C$ .

vii)  $(1 + s + \kappa)$ -edges with  $\kappa = 0, \lambda, 2\lambda$ : they carry a sum of decaying factors of the form:

$$\sum_{j=1}^{\nu(e)} \frac{1}{|p_e - a_j|^{1+\kappa}} \frac{1}{\langle \alpha_e + \beta_j + (p_e - b_j)^2 \rangle^{1-\varepsilon}}. \quad (9.73)$$

Here  $a_j, b_j$  are linear combinations of the momenta of the dead-edges in  $D_e$ , the numbers  $\beta_j$  are quadratic functions of the same momenta. The number of terms,  $\nu(e)$ , is bounded by  $\nu(e) \leq C^{|V_e|}$ , for a universal constant  $C$  (the symbol  $s$  in  $(1 + s + \kappa)$  refer to the ‘‘spherical decay’’  $\langle \alpha + \beta + (p - a)^2 \rangle^{-1+\varepsilon}$ ). If  $e$  is a root edge, then it can still be of the type  $(1 + s)$ ,  $(1 + s + \lambda)$  or  $(1 + s + 2\lambda)$ , but in this case, in (9.73) we replace  $\alpha_e$  with  $p_e^2$ .

Note that in our classification of the edges of  $\Gamma$ , we disregard the edges in  $S_{\bar{v}}$ : their only effect is to produce a  $(1 + 2\lambda)$ - or a 1-edge. Notice also that the new types of edges appear only on the route from  $\bar{v}$  to the root: all other edges are still either 2-,  $(2 + \lambda)$ -,  $(2 + 2\lambda)$ -,  $(2 + s)$ -,  $(2 + s + \lambda)$ -, or  $(2 + s + 2\lambda)$ -edges. In order to take care of the new type of edges we have to add to (9.58) the

following new transitions:

$$\begin{aligned}
6) & (d, d, 1 + \kappa) \rightarrow 1 + s + \kappa \quad \text{for } \kappa = 0, \lambda, 2\lambda \\
7) & (d, 1 + \kappa_1, 2 + \kappa_2) \rightarrow 1 + 2\lambda \quad \text{for } \kappa_{1,2} = 0, \lambda, 2\lambda \\
8) & (1 + \kappa_1, 2 + \kappa_2, 2 + \kappa_3) \rightarrow 1 + 2\lambda \quad \text{for } \kappa_{1,2,3} = 0, \lambda, 2\lambda \quad \text{with } \kappa_1 + \kappa_2 + \kappa_3 \geq 3\lambda \\
9) & (1 + 2\lambda, 2, 2) \rightarrow 1 + \lambda \\
10) & (1, 2 + 2\lambda, 2) \rightarrow 1 + \lambda \\
11) & (1 + s + \kappa_1, 2 + \kappa_2, 2 + \kappa_3) \rightarrow 1 + 2\lambda \quad \text{for } \kappa_{1,2,3} = 0, \lambda, 2\lambda \\
12) & (1 + \kappa_1, 2 + s + \kappa_2, 2 + \kappa_3) \rightarrow 1 + 2\lambda \quad \text{for } \kappa_{1,2,3} = 0, \lambda, 2\lambda
\end{aligned} \tag{9.74}$$

Moreover we have to add the following rules to the set a)-d) introduced above.

- e) At every integration step, among the son-edges there can only be one edge of the type v)-vii): this is clear because these edges can only be found on the route from  $\bar{v}$  to the root.
- f) There is no vertex with son-edges of the type  $(1, 2, 2)$ ,  $(1, 2 + \lambda, 2)$ , or  $(1, 2 + \lambda, 2 + \lambda)$ . This follows because there cannot be three son-edges with the same orientation, and because, from the previous observations (item b), c) and v)), any 1-edge, 2-edge and  $(2 + \lambda)$ -edge has always inward orientation.
- g) There is no vertex with son-edges of the type  $(1 + \lambda, 2, 2)$  or  $(1 + \lambda, 2 + \lambda, 2)$ . This follows from the observation that the  $1 + \lambda$  edge, which can only result from a transition 8) or 9), has always inward orientation (because 1- and 2-edges have inward orientation).

Taking into account the fact that the spherical denominator  $\langle \alpha + \beta + (p - a)^2 \rangle^{-1+\varepsilon}$  can be always estimated by one (i.e.  $+s$  can always be removed from the decay characterization of any edge), it is clear that the transitions 1)-12) together with the rules a)-g) define a closed system, so that every edge that arises in the successive vertex-integration of  $\Gamma$  (with the exception of the son-edges of  $\bar{v}$ ) is of either one of the types i)-vii) described above.

Let us now prove the transitions 6)-12). The  $\alpha$ -integration can be performed as in (9.60), (9.61) (or in (9.62) and (9.63), if we consider vertices adjacent to root-edges). As for the momenta integration we proceed as follows. The transition 6) can be shown similarly to the transition 1) (see (9.64)). The transition 7) follows, using the result of (9.60) (or of (9.62), if the father-edge is a root) to bound the  $\alpha$ -integration, from the second part of Proposition 10.4, under the condition that  $0 < \lambda < 1/6$  and  $\varepsilon < 1/3$ . The transitions 8), 9) and 10) follow, again with the help of (9.60) or (9.62), from Proposition 10.6, under the assumption that  $0 < \lambda < 1/6$  and  $\varepsilon < \lambda/2$ . For  $\kappa_1 + \kappa_2 + \kappa_3 \leq 2\lambda$ , the transitions 11) and 12) follow, using the result of (9.61) (or (9.63), if the father-edge is a root), by Proposition 10.7 under the condition that  $0 < \lambda < 1/10$  and  $\varepsilon < \lambda$  (here we use this Proposition with  $2\lambda$  instead of  $\lambda$ ). If  $\kappa_1 + \kappa_2 + \kappa_3 > 2\lambda$ , then we can drop the spherical denominator, and 11) and 12) follow from 8). Assuming that  $0 < \lambda < 1/10$  and  $0 < \varepsilon < \lambda/2$ , this completes the proof of (9.74).

Using the transitions (9.58) and (9.74) we can iteratively integrate over all vertices in  $\Gamma$ , until we are left with an integral over the non-frozen root-momenta. From (9.69) we obtain

$$\begin{aligned}
A_L \leq & C^m t^{\frac{n-k-6}{2}} \left( \int d\mathbf{p}_{n+k} \langle p_1 \rangle^2 \dots \langle p_{n+k} \rangle^2 |\psi(\mathbf{p}_{n+k})|^2 \right) \sup_{\{p_e\}_{e \in Q_1}} \left\{ \prod_{e \in R(\Gamma) \cap Q_1} \frac{1}{\langle t^{-\frac{1}{2}} p_e \rangle^3} \right. \\
& \times \left. \sum_{\bar{v} \in M(\Gamma)} \prod_{\substack{e \in R(\Gamma) \setminus Q_1 \\ e \neq \bar{e}}} \left( \sum_{j=1}^{\nu(e)} \int \frac{dp_e}{|p_e - a_{e,j}|^{2+\kappa_e} \langle t^{-\frac{1}{2}} p_e \rangle^3} \right) \sum_{j=1}^{\nu(\bar{e})} \int \frac{dp_{\bar{e}}}{|p_{\bar{e}} - a_{\bar{e},j}|^{1+\kappa_{\bar{e}}} \langle t^{-\frac{1}{2}} p_{\bar{e}} \rangle^3} \right\}, \tag{9.75}
\end{aligned}$$

where we denote by  $\bar{e}$  the unique root edge connected with the vertex  $\bar{v}$ . As in (9.65),  $\kappa_e = 0, \lambda$  or  $2\lambda$ , the  $a_{e,j}$ 's are linear combinations of the momenta of the dead edges in  $D_e$ , and  $\nu(e) \leq C^{|V_e|}$ . Note that the  $(1 + \kappa)$ -type is inherited within the tree containing  $\bar{v}$ , in particular the decay of the corresponding root-edge is weaker than that of all other root-edges.

Rescaling the momenta, we observe that

$$\sup_a \int \frac{dp}{|p-a|^{2+\kappa} \langle t^{-1/2} p \rangle^3} \leq C t^{\frac{1-\kappa}{2}}, \quad \text{and} \quad \sup_a \int \frac{dp}{|p-a|^{1+\kappa} \langle t^{-1/2} p \rangle^3} \leq C t^{\frac{2-\kappa}{2}}. \quad (9.76)$$

Since we assumed  $t \leq 1$ , since  $|R(\Gamma) \setminus Q_1| \geq k$ ,  $|M(\Gamma)| \leq 2(n+k)$ , and since  $\kappa_e \leq 2\lambda$ , we obtain

$$A_L \leq (n+k) C^n t^{\frac{n-5}{2}-\lambda k} \text{Tr} (1 - \Delta_1) \dots (1 - \Delta_{n+k}) \gamma^{(n+k)}. \quad (9.77)$$

Since we assumed  $n \geq 10 + k/2$ , and  $\lambda < 1/10$ , we find

$$A_L \leq C^n t^{\frac{n}{4}} \text{Tr} (1 - \Delta_1) \dots (1 - \Delta_{n+k}) \gamma^{(n+k)}.$$

Since the same is true for  $B_L$  (see (9.69)), this completes the proof of Theorem 9.4.  $\square$

## 9.6 Proof of Theorem 9.1

*Proof of Theorem 9.1.* Suppose that  $\Gamma_{1,t} = \{\gamma_{1,t}^{(k)}\}_{k \geq 1}$  and  $\Gamma_{2,t} = \{\gamma_{2,t}^{(k)}\}_{k \geq 1}$  are two solutions in  $C([0, T], \mathcal{H})$  of the infinite hierarchy (9.2), such that, for  $j = 1, 2$ ,  $\gamma_{j,t}^{(k)}$  is non-negative, symmetric w.r.t. permutations and satisfies  $\|\gamma_{j,t}^{(k)}\|_{\mathcal{H}_k} \leq C^k$ , for all  $k \geq 1$  and  $t \in [0, T]$ , and such that  $\gamma_{1,0}^{(k)} = \gamma_{2,0}^{(k)}$ , for all  $k \geq 1$ . We want to prove that  $\Gamma_{1,t} = \Gamma_{2,t}$ , for every  $t \in [0, T]$ . To this end we will prove that, for every fixed  $k \geq 1$ ,  $\gamma_{1,t}^{(k)} = \gamma_{2,t}^{(k)}$  for every  $t \in [0, T]$  (as elements of  $\mathcal{H}_k$ ). By a simple approximation argument it is then sufficient to prove that

$$\text{Tr} J^{(k)} \left( \gamma_{1,t}^{(k)} - \gamma_{2,t}^{(k)} \right) = 0 \quad (9.78)$$

for all  $J^{(k)}$  in a dense subset of the dual space of  $\mathcal{H}_k$ . Since we assumed  $\gamma_{1,t}^{(k)}$  and  $\gamma_{2,t}^{(k)}$  to be symmetric w.r.t. permutations, it is enough to consider permutation symmetric observables  $J^{(k)}$ . We will show (9.78) for all permutation symmetric  $J^{(k)}$  with kernel  $J^{(k)}(\mathbf{p}_k; \mathbf{p}'_k)$  (in momentum space) satisfying

$$|J^{(k)}(\mathbf{p}_k; \mathbf{p}'_k)| \leq C \prod_{j=1}^k \frac{1}{\langle p_j \rangle^3 \langle p'_j \rangle^3}.$$

For fixed  $k \geq 1$  we can expand  $\gamma_{j,t}^{(k)}$  in a Duhamel-type expansion as in (9.6). With Theorem 9.2 we can identify each term in the expansion (9.6) as the sum of contributions of Feynman graphs. We obtain, for any  $n$ , that

$$\gamma_{j,t}^{(k)} = \mathcal{U}_0^{(k)}(t) \gamma_{j,0}^{(k)} + \sum_{m=1}^{n-1} \sum_{\Gamma \in \mathcal{F}_{m,k}} K_{\Gamma,t} \gamma_{j,0}^{(k+m)} - i \sum_{\Gamma \in \mathcal{F}_{n,k}} \int_0^t ds L_{\Gamma,t-s} \gamma_{j,s}^{(k+n)} \quad (9.79)$$

for  $j = 1, 2$ . Multiplying with the observable  $J^{(k)}$  and taking the trace we obtain

$$\text{Tr} J^{(k)} \gamma_{j,t}^{(k)} = \langle J^{(k)}, \mathcal{U}_0^{(k)}(t) \gamma_{j,0}^{(k)} \rangle + \sum_{m=1}^{n-1} \sum_{\Gamma \in \mathcal{F}_{m,k}} \langle J^{(k)}, K_{\Gamma,t} \gamma_{j,0}^{(m+k)} \rangle - i \sum_{\Gamma \in \mathcal{F}_{n,k}} \int_0^t ds \langle J^{(k)}, L_{\Gamma,t-s} \gamma_{j,s}^{(n+k)} \rangle \quad (9.80)$$

for  $j = 1, 2$ . From Theorem 9.3, it follows that the terms in the sum over  $m$  are bounded in absolute value by  $C^m \|\gamma_{j,0}^{(m+k)}\|_{\mathcal{H}_{m+k}}$ , in particular they are finite. Since  $\gamma_{1,0}^{(k+m)} = \gamma_{2,0}^{(k+m)}$  for every  $m \geq 1$ , when we take the difference between  $\text{Tr } J^{(k)} \gamma_{1,t}^{(k)}$  and  $\text{Tr } J^{(k)} \gamma_{2,t}^{(k)}$ , the free evolution terms  $\langle J^{(k)}, \mathcal{U}_0^{(k)} \gamma_{j,0}^{(k)} \rangle$  and all the terms in the sum over  $m$  disappear and it only remains to bound the contributions from the last term in (9.80). From Theorem 9.3, and since  $|\mathcal{F}_{n,k}| \leq C^{n+k}$ , we obtain, under the assumption that  $t \leq 1$  and  $n \geq 10 + k/2$ ,

$$\left| \text{Tr } J^{(k)} \left( \gamma_{1,t}^{(k)} - \gamma_{2,t}^{(k)} \right) \right| \leq C^n \int_0^t ds (t-s)^{\frac{n}{4}} \left( \|\gamma_{1,s}^{(n+k)}\|_{\mathcal{H}_{k+n}} + \|\gamma_{2,s}^{(n+k)}\|_{\mathcal{H}_{k+n}} \right) \leq C^n t^{\frac{n}{4}}, \quad (9.81)$$

where we used that, by assumption,  $\sup_{s \in [0, T]} \|\gamma_{j,s}^{(n+k)}\|_{\mathcal{H}_{n+k}} \leq C^{n+k}$  for  $j = 1, 2$ . Hence, if we choose  $t < \min(1, (1/2C)^4)$  we conclude that

$$\left| \text{Tr } J^{(k)} \left( \gamma_{1,t}^{(k)} - \gamma_{2,t}^{(k)} \right) \right| \leq 2^{-n}. \quad (9.82)$$

Since  $n \geq 1$  is arbitrary, this clearly proves (9.78) for every  $t \leq \min(1, (1/2C)^4)$ . The proof can then be iterated to show that  $\gamma_{1,t}^{(k)} = \gamma_{2,t}^{(k)}$  for all  $t \in [0, T]$ .  $\square$

## 10 Integrating Out a Vertex

In this section we prove some estimates used in the proofs of Theorem 9.3 and Theorem 9.4 to control the momentum integration in the transitions 1)-5) in (9.58) and 6)-12) in (9.74).

### 10.1 Preliminary Estimates

We begin by proving some useful lemmas: they contain the prototypes of integration we have to deal with when integrating out a vertex.

**Lemma 10.1.** *For every  $\varepsilon, \lambda, \eta$  with  $0 \leq \varepsilon < \lambda < 1$  and  $0 < \eta < \lambda - \varepsilon$  there exists a constant  $C_{\lambda, \varepsilon, \eta}$  such that*

$$\int_{-\infty}^{\infty} \frac{d\beta}{\langle \alpha - \beta \rangle^{1-\varepsilon} |\beta|^\lambda} \leq \frac{C_{\lambda, \varepsilon, \eta}}{\langle \alpha \rangle^{\lambda - \varepsilon - \eta}} \quad (10.1)$$

for all  $\alpha \in \mathbb{R}$ .

*Proof.* If  $|\alpha| \leq 1$ , then  $\langle \alpha \rangle \sim 1$ ,  $\langle \alpha - \beta \rangle \sim \langle \beta \rangle$  and (10.1) is trivial. For  $|\alpha| \geq 1$  we split the integral into two parts. For  $|\beta| \leq |\alpha|/2$ , we use

$$\frac{1}{\langle \alpha - \beta \rangle^{1-\varepsilon}} \lesssim \frac{1}{\langle \alpha - \beta \rangle^{1-\lambda+\eta} \langle \alpha \rangle^{\lambda-\varepsilon-\eta}}$$

and we obtain

$$\begin{aligned} \int_{|\beta| \leq |\alpha|/2} \frac{d\beta}{\langle \alpha - \beta \rangle^{1-\varepsilon} |\beta|^\lambda} &\leq \frac{C}{\langle \alpha \rangle^{\lambda-\varepsilon-\eta}} \int_{|\beta| \leq |\alpha|/2} \frac{d\beta}{\langle \alpha - \beta \rangle^{1-\lambda+\eta} |\beta|^\lambda} \\ &\leq \frac{C}{\langle \alpha \rangle^{\lambda-\varepsilon-\eta}} \left( \int_{|\beta| \leq 1/2} \frac{d\beta}{|\beta|^\lambda} + \int d\beta \left( \frac{1}{\langle \beta \rangle^{1+\eta}} + \frac{1}{\langle \alpha - \beta \rangle^{1+\eta}} \right) \right) \\ &\leq \frac{C}{\langle \alpha \rangle^{\lambda-\varepsilon-\eta}} \end{aligned} \quad (10.2)$$

where we used the Schwarz inequality and the fact that, if  $|\beta| \geq 1/2$ ,  $|\beta| \sim \langle \beta \rangle$ . For  $|\beta| \geq |\alpha|/2$ , on the other hand, we use

$$\frac{1}{|\beta|^\lambda} \lesssim \frac{1}{|\alpha|^{\lambda-\varepsilon-\eta} |\beta|^{\varepsilon+\eta}} \lesssim \frac{1}{\langle \alpha \rangle^{\lambda-\varepsilon-\eta} |\beta|^{\varepsilon+\eta}}$$

and conclude similarly.  $\square$

**Lemma 10.2.** *For every  $\varepsilon, \delta, \gamma$  with  $0 \leq \varepsilon < 1$ ,  $\delta < (1/2) - \varepsilon$ ,  $\delta > -1/2$ , and  $0 \leq \gamma < \min(1 - \varepsilon; 1 + 2\delta; 1 - 2\delta - 2\varepsilon)$ , and for every  $\eta > 0$  sufficiently small (depending on  $\varepsilon, \delta, \gamma$ ), there exists a constant  $C = C_{\delta, \varepsilon, \gamma, \eta}$  with*

$$I = \int \frac{dp}{|p|^{2-2\delta} \langle \alpha - (p-a)^2 \rangle^{1-\varepsilon}} \leq \frac{C}{\langle a \rangle^\gamma \langle \alpha - a^2 \rangle^{\frac{1}{2} - \frac{\gamma}{2} - \delta - \varepsilon - \eta}} \quad (10.3)$$

for all  $\alpha \in \mathbb{R}$  and  $a \in \mathbb{R}^3$ .

*Proof.* We consider first the case  $|a| < 1$ . Then  $\langle \alpha - a^2 \rangle \sim \langle \alpha \rangle$  and  $\langle a \rangle \sim 1$ , so it is sufficient to prove the estimate (10.3) when  $a^2$  and  $\langle a \rangle$  are removed from the r.h.s. of (10.3). We now distinguish two cases, depending on the size of  $|\alpha|$ .

If  $|\alpha| \leq 10$ , then the integral  $I$  is comparable with

$$I \lesssim \int \frac{dp}{|p|^{2-2\delta} \langle p-a \rangle^{2-2\varepsilon}} \lesssim \int_{|p| \leq 1} \frac{dp}{|p|^{2-2\delta}} + \int dp \left( \frac{1}{\langle p \rangle^{4-2\delta-2\varepsilon}} + \frac{1}{\langle p-a \rangle^{4-2\delta-2\varepsilon}} \right)$$

which is uniformly bounded in  $\alpha$  and  $a$ . Here we applied a Schwarz inequality, and we used that, by assumption,  $\delta > -1/2$  and  $\delta + \varepsilon < 1/2$ . Since in this case  $\langle \alpha \rangle \simeq 1$ , this proves (10.3).

If  $|\alpha| \geq 10$ , then we split the  $dp$ -integration into three different regimes. In the regime  $p^2 \leq |\alpha|/2$  we have  $\langle \alpha - (p-a)^2 \rangle \sim \langle \alpha \rangle$  and, putting  $y = p^2$ ,

$$\int_{|p|^2 \leq |\alpha|/2} \frac{dp}{|p|^{2-2\delta} \langle \alpha - (p-a)^2 \rangle^{1-\varepsilon}} \lesssim \frac{1}{\langle \alpha \rangle^{1-\varepsilon}} \int_0^{|\alpha|/2} dy \frac{1}{|y|^{\frac{1}{2}-\delta}} \lesssim \frac{1}{\langle \alpha \rangle^{\frac{1}{2}-\varepsilon-\delta}} \quad (10.4)$$

because  $\delta > -1/2$ . In the regime  $|\alpha|/2 \leq p^2 \leq 2|\alpha|$  we have

$$\begin{aligned} \int_{|\alpha|/2 \leq p^2 \leq 2|\alpha|} \frac{dp}{|p|^{2-2\delta} \langle \alpha - (p-a)^2 \rangle^{1-\varepsilon}} &\lesssim \frac{1}{\langle \alpha \rangle^{1-\delta}} \int_{|\alpha|/2 \leq p^2 \leq 2|\alpha|} \frac{dp}{\langle \alpha - (p-a)^2 \rangle^{1-\varepsilon}} \\ &\leq \frac{1}{\langle \alpha \rangle^{1-\delta}} \int_{|\alpha|/2 \leq (q+a)^2 \leq 2|\alpha|} \frac{dq}{\langle \alpha - q^2 \rangle^{1-\varepsilon}} \leq \frac{1}{\langle \alpha \rangle^{1-\delta}} \int_{|\alpha|/3 \leq q^2 \leq 3|\alpha|} \frac{dq}{\langle \alpha - q^2 \rangle^{1-\varepsilon}} \\ &\lesssim \frac{1}{\langle \alpha \rangle^{1-\delta}} \int_{|\alpha|/3}^{3|\alpha|} \frac{dy \sqrt{y}}{\langle \alpha - y \rangle^{1-\varepsilon}} \lesssim \frac{1}{\langle \alpha \rangle^{\frac{1}{2}-\delta}} \int_{|\alpha|/3}^{3|\alpha|} \frac{dy}{|\alpha - y|^{1-\varepsilon}} \lesssim \frac{1}{\langle \alpha \rangle^{\frac{1}{2}-\varepsilon-\delta}}. \end{aligned} \quad (10.5)$$

Finally, for  $p^2 \geq 2|\alpha|$ , we have  $\langle \alpha - (p-a)^2 \rangle \sim p^2$  and hence

$$\int_{p^2 \geq 2|\alpha|} \frac{dp}{|p|^{2-2\delta} \langle \alpha - (p-a)^2 \rangle^{1-\varepsilon}} \lesssim \int_{p^2 \geq 2|\alpha|} \frac{dp}{|p|^{4-2\delta-2\varepsilon}} \lesssim \frac{1}{\langle \alpha \rangle^{\frac{1}{2}-\varepsilon-\delta}}. \quad (10.6)$$

Combining (10.4), (10.5), and (10.6), we obtain (10.3) for arbitrary  $\gamma \geq 0$  and  $\eta > 0$ .

Now we turn to the case  $|a| \geq 1$ . By rotational symmetry, we can assume that  $a = (|a|, 0, 0)$ . After a change of variables and introducing  $\varrho := p_2^2 + p_3^2$  we find

$$I \lesssim \int_{\mathbb{R}} dp_1 \int_0^\infty \frac{d\varrho}{|\varrho + p_1^2|^{1-\delta} \langle \alpha - a^2 - \varrho - p_1^2 + 2|a|p_1 \rangle^{1-\varepsilon}}.$$

We define the new variables:

$$u := \varrho + p_1^2, \quad v := \alpha - a^2 - u + 2|a|p_1.$$

The map  $D \ni (u, v) \rightarrow (p_1, \varrho) \in \mathbb{R} \times [0, \infty)$  is one-to-one if we choose

$$D = \left\{ (u, v) \in \mathbb{R}^2 : u \geq \left( \frac{\alpha - a^2 - u - v}{2|a|} \right)^2 \right\}.$$

Computing the Jacobian of this transformation, we obtain

$$I \lesssim \frac{1}{|a|} \int_D \frac{dudv}{|u|^{1-\delta} \langle v \rangle^{1-\varepsilon}}.$$

Using the definition of the domain  $D$ , we get, for  $0 \leq \gamma \leq 1$ ,

$$I \lesssim \frac{1}{|a|} \int_D \frac{dudv}{|u|^{\frac{1}{2} + \frac{\gamma}{2} - \delta} \langle v \rangle^{1-\varepsilon} \left| \frac{\alpha - a^2 - u - v}{2|a|} \right|^{1-\gamma}} \lesssim \frac{1}{|a|^\gamma} \int_{\mathbb{R}^2} \frac{dudv}{|u|^{\frac{1}{2} + \frac{\gamma}{2} - \delta} |\alpha - a^2 - u - v|^{1-\gamma} \langle v \rangle^{1-\varepsilon}}. \quad (10.7)$$

Applying the bound (10.1) twice, to integrate first over  $v$  and then over  $u$ , and using the assumptions that  $0 \leq \gamma < \min(1 - \varepsilon; 1 + 2\delta; 1 - 2\delta - 2\varepsilon)$  and that  $\eta$  is small enough, we find

$$I \lesssim \frac{1}{|a|^\gamma} \int_{\mathbb{R}} \frac{du}{|u|^{\frac{1}{2} + \frac{\gamma}{2} - \delta} \langle \alpha - a^2 - u \rangle^{1-\gamma-\varepsilon-\frac{\eta}{2}}} \lesssim \frac{C_{\delta, \varepsilon, \gamma, \varepsilon}}{\langle a \rangle^\gamma \langle \alpha - a^2 \rangle^{\frac{1}{2} - \frac{\gamma}{2} - \delta - \varepsilon - \eta}}. \quad (10.8)$$

Here we used that  $|a| \geq 1$ , to replace  $|a|$  by  $\langle a \rangle$ .  $\square$

**Lemma 10.3.** *For any  $\varepsilon, \delta, \eta$  with  $0 \leq \varepsilon < 2\delta < 1$ , and  $0 < \eta < 2\delta - \varepsilon$ , there exists a constant  $C_{\delta, \eta, \varepsilon}$  such that*

$$I = \int \frac{dp}{|p|^{2+2\delta} \langle \alpha - p \cdot a \rangle^{1-\varepsilon}} \leq \frac{C_{\delta, \eta, \varepsilon}}{\langle \alpha \rangle^{2\delta - \varepsilon - \eta} |a|^{1-2\delta}} \quad (10.9)$$

for every  $a \in \mathbb{R}^3$ ,  $\alpha \in \mathbb{R}$ .

*Proof.* By rotational symmetry, we can assume  $a = (|a|, 0, 0)$ . Introducing the variable  $\varrho = p_2^2 + p_3^2$ , we find

$$I \lesssim \int_{\mathbb{R}} \frac{dp_1}{\langle \alpha - p_1 |a| \rangle^{1-\varepsilon}} \int_0^\infty \frac{d\varrho}{|p_1^2 + \varrho|^{1+\delta}} \lesssim \int_{\mathbb{R}} \frac{dp_1}{\langle \alpha - p_1 |a| \rangle^{1-\varepsilon} |p_1|^{2\delta}} = \frac{1}{|a|^{1-2\delta}} \int_{\mathbb{R}} \frac{dy}{\langle \alpha - y \rangle^{1-\varepsilon} |y|^{2\delta}}$$

and we conclude by (10.1).  $\square$

## 10.2 Momentum Integration

Using the results of the last subsection, we provide here bounds for the integration over the momenta carried by the son-edges of a given vertex. The bounds in the next proposition are used to integrate out vertices with one dead edge, i.e. vertices of type 2) in (9.58) and type 7) in (9.74)). These vertices involve integration over two momenta; however, because of the momentum delta-function, effectively we only need to integrate over one momentum (see Fig. 16).

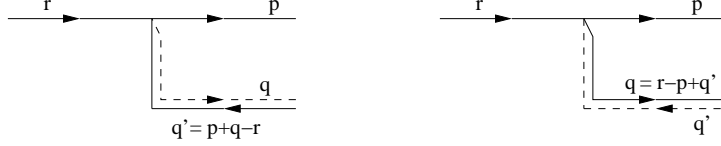

Figure 16: The vertices of Prop. 10.4

**Proposition 10.4.** *Suppose  $0 < \lambda < 1/6$  and  $0 \leq \varepsilon < 1/3$ . Let  $\kappa_1, \kappa_2 \geq 0$ , with  $\kappa_1 + \kappa_2 \leq 4\lambda$ . Then there exists a constant  $C = C(\lambda, \varepsilon, \kappa_1, \kappa_2)$  such that*

$$\sup_{\alpha} \int \frac{dp}{|p - a_1|^{2+\kappa_1} |r - p - q - a_2|^{2+\kappa_2}} \frac{1}{\langle \alpha - p^2 \pm (r - p - q)^2 \rangle^{1-\varepsilon}} \leq C \sum_{j=1}^{\mu} \frac{1}{|r - b_j|^{2+2\lambda}} \quad (10.10)$$

and

$$\sup_{\alpha} \int \frac{dp}{|p - a_1|^{1+\kappa_1} |r - p - q - a_2|^{2+\kappa_2}} \frac{1}{\langle \alpha - p^2 \pm (r - p - q)^2 \rangle^{1-\varepsilon}} \leq C \sum_{j=1}^{\mu} \frac{1}{|r - b_j|^{1+2\lambda}} \quad (10.11)$$

for any  $r, q, a_1, a_2 \in \mathbb{R}^3$ . Here  $b_j$  are linear combinations of  $a_1, a_2$  and of the frozen momentum  $q$ , and  $\mu$  is a universal integer constant.

*Remark.* The different signs in the propagator on the l.h.s. of (10.10) are needed because of the two possible orientation of the dead edge. The positive sign in (10.10) corresponds to the vertex on the left side of Fig. 16 since in this case the two live son-edges, carrying the propagators  $p^2$  and  $(p + q - r)^2$ , have opposite orientation. For the vertex on the right, first replace  $q$  with  $-q'$  in (10.10) and then use the negative sign, corresponding to the parallel orientations of the live son-edges. The bound (10.11) is used when one of the son-edges is a  $1 + \kappa$ -edge, for  $\kappa = 0, \lambda$  or  $2\lambda$ . The different signs in the propagator again take care of the possible orientations of the dead edge and of the  $1 + \kappa$ -edge.

*Proof of Proposition 10.4.* We will make use of the following inequality to separate denominators.

**Lemma 10.5.** *For arbitrary  $\alpha, \beta > 0$  and  $0 \leq \gamma \leq \min(\alpha, \beta)$ , there exists a constant  $C_{\alpha, \beta, \gamma}$  such that*

$$\frac{1}{|a|^{\alpha} |b - a|^{\beta}} \leq \frac{C_{\alpha, \beta, \gamma}}{|b|^{\gamma}} \left( \frac{1}{|a|^{\alpha + \beta - \gamma}} + \frac{1}{|b - a|^{\alpha + \beta - \gamma}} \right). \quad (10.12)$$

*Proof of Lemma 10.5.* Note that, since  $|b| \leq |b - a| + |a|$ , we have  $|b|^{\gamma} \leq C_{\gamma} (|b - a|^{\gamma} + |a|^{\gamma})$  and thus

$$\frac{|b|^{\gamma}}{|a|^{\gamma} |b - a|^{\gamma}} \leq C_{\gamma} \left( \frac{1}{|a|^{\gamma}} + \frac{1}{|b - a|^{\gamma}} \right). \quad (10.13)$$

Hence

$$\begin{aligned} \frac{1}{|a|^{\alpha} |b - a|^{\beta}} &= \frac{1}{|a|^{\gamma} |b - a|^{\gamma}} \frac{1}{|a|^{\alpha - \gamma} |b - a|^{\beta - \gamma}} \leq \frac{C_{\gamma}}{|b|^{\gamma}} \left( \frac{1}{|a|^{\gamma}} + \frac{1}{|b - a|^{\gamma}} \right) \frac{1}{|a|^{\alpha - \gamma} |b - a|^{\beta - \gamma}} \\ &\leq \frac{C_{\gamma}}{|b|^{\gamma}} \left( \frac{1}{|a|^{\alpha} |b - a|^{\beta - \gamma}} + \frac{1}{|a|^{\alpha - \gamma} |b - a|^{\beta}} \right) \end{aligned} \quad (10.14)$$

and (10.12) follows by a Schwarz inequality.  $\square$



Returning to the proof of Proposition 10.4, we introduce a parameter  $\theta$  which can assume the values 1 and 2. In this way we can prove (10.10) and (10.11) in parallel; we use  $\theta = 2$  for the proof of (10.10),  $\theta = 1$  for the proof of (10.11). According to the sign in the denominator, we have to bound one of the two integrals

$$\begin{aligned} \text{(I)} &:= \sup_{\alpha} \int \frac{dp}{|p - a_1|^{\theta + \kappa_1} |r - p - q - a_2|^{2 + \kappa_2}} \frac{1}{\langle \alpha - 2p \cdot (r - q) \rangle^{1 - \varepsilon}} \\ \text{(II)} &:= \sup_{\alpha} \int \frac{dp}{|p - a_1|^{\theta + \kappa_1} |r - p - q - a_2|^{2 + \kappa_2}} \frac{1}{\langle \alpha - 2(p - \frac{r - q}{2})^2 \rangle^{1 - \varepsilon}}. \end{aligned} \quad (10.15)$$

Here we shifted the  $\alpha$  variable by a  $p$ -independent number: this is of course allowed because we take the supremum over  $\alpha$ .

We consider first the integral (I). Using (10.12) we obtain, for arbitrary  $-1 < \gamma \leq \min(\kappa_1, \kappa_2)$ ,

$$\begin{aligned} \text{(I)} &\lesssim \frac{1}{|r - q - a_1 - a_2|^{\theta + \gamma}} \\ &\quad \times \sup_{\alpha} \int dp \left( \frac{1}{|p - a_1|^{2 + \kappa_1 + \kappa_2 - \gamma}} + \frac{1}{|r - q - p - a_2|^{2 + \kappa_1 + \kappa_2 - \gamma}} \right) \frac{1}{\langle \alpha - 2p \cdot (r - q) \rangle^{1 - \varepsilon}} \\ &\lesssim \frac{1}{|r - q - a_1 - a_2|^{\theta + \gamma}} \sup_{\alpha} \int \frac{dp}{|p|^{2 + \kappa_1 + \kappa_2 - \gamma}} \frac{1}{\langle \alpha - 2p \cdot (r - q) \rangle^{1 - \varepsilon}}. \end{aligned}$$

Assuming that

$$\varepsilon < \kappa_1 + \kappa_2 - \gamma < 1 \quad (10.16)$$

we can find  $\eta > 0$  such that  $0 < \eta < \kappa_1 + \kappa_2 - \gamma - \varepsilon$  and we can apply Lemma 10.3 to find

$$\begin{aligned} \text{(I)} &\lesssim \frac{1}{|r - q - a_1 - a_2|^{\theta + \gamma} |r - q|^{1 + \gamma - \kappa_1 - \kappa_2}} \\ &\lesssim \frac{1}{|r - q|^{\theta + 1 + 2\gamma - \kappa_1 - \kappa_2}} + \frac{1}{|r - q - a_1 - a_2|^{\theta + 1 + 2\gamma - \kappa_1 - \kappa_2}}. \end{aligned} \quad (10.17)$$

Choosing  $2\gamma = \kappa_1 + \kappa_2 - 1 + 2\lambda$  we can bound (I) by the r.h.s. of (10.10) or of (10.11) (according to whether  $\theta = 2$  or  $\theta = 1$ ), with  $\mu = 2$ ,  $b_1 = q$  and  $b_2 = q + a_1 + a_2$ : we only have to check that this choice of  $\gamma$  is compatible with the condition  $-1 < \gamma \leq \min(\kappa_1, \kappa_2)$  and with (10.16). This follows from the assumptions that  $\kappa_1 + \kappa_2 \leq 4\lambda$ ,  $\lambda < 1/6$  and  $0 \leq \varepsilon < 1/3$ .

Next we consider the term (II) in (10.15). Using (10.12) and changes of variables, we conclude that

$$\begin{aligned} \text{(II)} &\lesssim \frac{1}{|r - q - a_1 - a_2|^{\theta}} \\ &\quad \times \sup_{\alpha} \int dp \left( \frac{1}{|p - a_1|^{2 + \kappa_1 + \kappa_2}} + \frac{1}{|r - p - q - a_2|^{2 + \kappa_1 + \kappa_2}} \right) \frac{1}{\langle \alpha - 2(p - \frac{r - q}{2})^2 \rangle^{1 - \varepsilon}} \\ &\lesssim \frac{1}{|r - q - a_1 - a_2|^{\theta}} \\ &\quad \times \sup_{\alpha} \int \frac{dp}{|p|^{2 + \kappa_1 + \kappa_2}} \left( \frac{1}{\langle \alpha - 2(p + a_1 - \frac{r - q}{2})^2 \rangle^{1 - \varepsilon}} + \frac{1}{\langle \alpha - 2(p + a_2 - \frac{r - q}{2})^2 \rangle^{1 - \varepsilon}} \right). \end{aligned} \quad (10.18)$$

Applying Lemma 10.2, with  $\gamma = 2\lambda$  and  $\delta = -(\kappa_1 + \kappa_2)/2$ , we obtain for  $0 < \eta < 1/2 - \lambda - \varepsilon$ ,

$$\begin{aligned} \text{(II)} &\lesssim \frac{1}{|r - q - a_1 - a_2|^{\theta}} \left( \frac{1}{|r - q - 2a_1|^{2\lambda}} + \frac{1}{|r - q - 2a_2|^{2\lambda}} \right) \sup_{\alpha} \frac{1}{\langle \alpha \rangle^{\frac{1 + \kappa_1 + \kappa_2}{2} - \lambda - \varepsilon - \eta}} \\ &\lesssim \frac{1}{|r - q - a_1 - a_2|^{\theta + 2\lambda}} + \frac{1}{|r - q - 2a_1|^{\theta + 2\lambda}} + \frac{1}{|r - q - 2a_2|^{\theta + 2\lambda}}. \end{aligned} \quad (10.19)$$

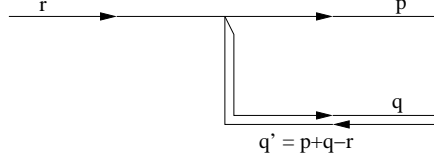

Figure 17: The vertex of Prop. 10.6

Here we used that  $\lambda < 1/6$ ,  $\varepsilon < 1/3$  and  $\kappa_1 + \kappa_2 \leq 4\lambda$ . This completes the proof of (10.10) and (10.11).  $\square$

In the next proposition we show how to integrate out vertices where all the son-edges are live  $(2 + \kappa)$ - or  $(1 + \kappa)$ -edges, with  $\kappa = 0, \lambda$ , or  $2\lambda$ . These will include the vertex integrations of type 3) and 4) in (9.58) and type 8), 9) and 10) in (9.74). After the  $\alpha$ -integrations, these vertices involve integration over three momenta  $p, q, q'$ . Using the delta-function  $\delta(r - (p + q - q'))$ , we are left with two effective integrations which need to be controlled (see Fig. 17).

**Proposition 10.6.** *Suppose  $\kappa_1, \kappa_2, \kappa_3 \geq 0$  with  $0 < \kappa_1 + \kappa_2 + \kappa_3 < 1$ . Let  $0 \leq \kappa < \kappa_1 + \kappa_2 + \kappa_3$ , and  $\varepsilon < (\kappa_1 + \kappa_2 + \kappa_3 - \kappa)/2$ . Then there is a constant  $C = C(\kappa_1, \kappa_2, \kappa_3, \kappa, \varepsilon)$  such that*

$$\sup_{\alpha} \int \frac{dp dq}{|p - a_1|^{2+\kappa_1} |q - a_2|^{2+\kappa_2} |r - p - q - a_3|^{2+\kappa_3}} \times \frac{1}{\langle \alpha - p^2 - q^2 + (r - p - q)^2 \rangle^{1-\varepsilon}} \leq C \sum_{j=1}^{\mu} \frac{1}{|r - b_j|^{2+\kappa}} \quad (10.20)$$

and

$$\sup_{\alpha} \int \frac{dp dq}{|p - a_1|^{1+\kappa_1} |q - a_2|^{2+\kappa_2} |r - p - q - a_3|^{2+\kappa_3}} \times \frac{1}{\langle \alpha - p^2 - q^2 + (r - p - q)^2 \rangle^{1-\varepsilon}} \leq C \sum_{j=1}^{\mu} \frac{1}{|r - b_j|^{1+\kappa}} \quad (10.21)$$

and

$$\sup_{\alpha} \int \frac{dp dq}{|p - a_1|^{2+\kappa_1} |q - a_2|^{2+\kappa_2} |r - p - q - a_3|^{1+\kappa_3}} \times \frac{1}{\langle \alpha - p^2 - q^2 + (r - p - q)^2 \rangle^{1-\varepsilon}} \leq C \sum_{j=1}^{\mu} \frac{1}{|r - b_j|^{1+\kappa}} \quad (10.22)$$

for all  $r, a_1, a_2, a_3 \in \mathbb{R}^3$ . Here the  $b_j$  are linear combinations of  $a_1, a_2, a_3$ , and  $\mu$  is a universal constant.

*Remark.* The bound (10.21) is used when the edge carrying momentum  $p$  is a  $(1 + \kappa)$ -edge, for  $\kappa = 0, \lambda, 2\lambda$ . The bound (10.22), on the other hand, is used when the edge with momentum  $q' = r - p - q$  is a  $(1 + \kappa)$ -edge (if the edge with momentum  $q$  is a  $(1 + \kappa)$ -edge, then, after exchanging  $p \leftrightarrow q$ , we can use (10.21)).

*Proof.* In this proof we will assume that  $a_1 = a_2 = a_3 = 0$ : the generalization to  $a_1, a_2, a_3 \neq 0$  can be obtained with similar shifts as we did in the proof of Proposition 10.4. Using

$$\frac{1}{|p|^{\kappa_1}|q|^{\kappa_2}|r-p-q|^{\kappa_3}} \leq \left( \frac{1}{|p|^\theta} + \frac{1}{|q|^\theta} + \frac{1}{|r-p-q|^\theta} \right)$$

with  $\theta = \kappa_1 + \kappa_2 + \kappa_3$ , and the symmetry of the integrand w.r.t. the exchange  $p \leftrightarrow q$ , the l.h.s. of (10.20) is bounded by

$$\begin{aligned} & 2 \sup_{\alpha} \int \frac{dp dq}{|p|^{2+\theta}|q|^2|r-p-q|^2} \frac{1}{\langle \alpha - p^2 - q^2 + (r-p-q)^2 \rangle^{1-\varepsilon}} \\ & + \sup_{\alpha} \int \frac{dp dq}{|p|^2|q|^2|r-p-q|^{2+\theta}} \frac{1}{\langle \alpha - p^2 - q^2 + (r-p-q)^2 \rangle^{1-\varepsilon}} \\ & \lesssim \sup_{\alpha} \int \frac{dq}{|q|^2|r-q|^2} \int dp \left( \frac{1}{|p|^{2+\theta}} + \frac{1}{|r-q-p|^{2+\theta}} \right) \frac{1}{\langle \alpha - p^2 - q^2 + (r-p-q)^2 \rangle^{1-\varepsilon}} \quad (10.23) \\ & \lesssim \sup_{\alpha_1} \int \frac{dq}{|q|^2|r-q|^2} \int \frac{dp}{|p|^{2+\theta}} \frac{1}{\langle \alpha_1 - 2r \cdot q - 2p \cdot (r-q) \rangle^{1-\varepsilon}} \\ & + \sup_{\alpha_2} \int \frac{dq}{|q|^2|r-q|^2} \int \frac{dp}{|p|^{2+\theta}} \frac{1}{\langle \alpha_2 - 2(q - \frac{r}{2})^2 + 2p \cdot (r-q) \rangle^{1-\varepsilon}} \end{aligned}$$

where we applied the inequality (10.12) and then we shifted the variable  $q \rightarrow (r-p-q)$  to obtain the last term. Applying Lemma 10.3 we conclude that the l.h.s. of (10.20) can be estimated by

$$\begin{aligned} & \sup_{\alpha} \int \frac{dp dq}{|p|^{2+\kappa_1}|q|^{2+\kappa_2}|r-p-q|^{2+\kappa_3}} \frac{1}{\langle \alpha - p^2 - q^2 + (r-p-q)^2 \rangle^{1-\varepsilon}} \\ & \lesssim \sup_{\alpha_1} \int \frac{dq}{|q|^2|r-q|^{3-\theta}} \frac{1}{\langle \alpha_1 - 2r \cdot q \rangle^{\theta-\varepsilon-\eta}} \quad (10.24) \\ & + \sup_{\alpha_2} \int \frac{dq}{|q|^2|r-q|^{3-\theta}} \frac{1}{\langle \alpha_2 - 2(q - \frac{r}{2})^2 \rangle^{\theta-\varepsilon-\eta}}, \end{aligned}$$

for any sufficiently small  $\eta > 0$ . To bound the first term we use again (10.12) and Lemma 10.3:

$$\begin{aligned} & \sup_{\alpha_1} \int \frac{dq}{|q|^2|r-q|^{3-\theta}} \frac{1}{\langle \alpha_1 - 2r \cdot q \rangle^{\theta-\varepsilon-\eta}} \\ & \lesssim \frac{1}{|r|^{2-\frac{\theta-\kappa}{2}}} \sup_{\alpha_1} \int dq \left( \frac{1}{|q|^{3-\frac{\theta+\kappa}{2}}} + \frac{1}{|r-q|^{3-\frac{\theta+\kappa}{2}}} \right) \frac{1}{\langle \alpha_1 - 2r \cdot q \rangle^{\theta-\varepsilon-\eta}} \quad (10.25) \\ & \lesssim \frac{1}{|r|^{2+\kappa}} \sup_{\alpha_1} \frac{1}{\langle \alpha_1 \rangle^{\frac{\theta-\kappa}{2}-\varepsilon-2\eta}} \lesssim \frac{1}{|r|^{2+\kappa}}, \end{aligned}$$

because  $\kappa < \theta$ ,  $0 \leq 2\varepsilon < \theta - \kappa$  and  $\eta > 0$  is arbitrarily small. Using (10.12) and Lemma 10.2 (with  $\gamma = \kappa$ ), the second term on the r.h.s. of (10.24) can be controlled by:

$$\begin{aligned} & \sup_{\alpha_2} \int \frac{dq}{|q|^2|r-q|^{3-\theta}} \frac{1}{\langle \alpha_2 - 2(q - \frac{r}{2})^2 \rangle^{\theta-\varepsilon-\eta}} \\ & \lesssim \frac{1}{|r|^2} \sup_{\alpha_2} \int dp \left( \frac{1}{|q|^{3-\theta}} + \frac{1}{|r-q|^{3-\theta}} \right) \frac{1}{\langle \alpha_2 - 2(q - \frac{r}{2})^2 \rangle^{\theta-\varepsilon-\eta}} \quad (10.26) \\ & \lesssim \frac{1}{|r|^{2+\kappa}} \sup_{\alpha_3} \frac{1}{\langle \alpha_3 \rangle^{\frac{\theta-\kappa}{2}-\varepsilon-2\eta}} \lesssim \frac{1}{|r|^{2+\kappa}}, \end{aligned}$$

because  $\theta > \kappa$  and  $2\varepsilon < \theta - \kappa$ , and  $\eta$  is arbitrarily small. This completes the proof of (10.20).

Next we prove (10.21). With  $\theta = \kappa_1 + \kappa_2$ , we have, similarly to (10.24),

$$\begin{aligned} & \sup_{\alpha} \int \frac{dp dq}{|p||q|^{2+\kappa_1}|r-p-q|^{2+\kappa_2}} \frac{1}{\langle \alpha - p^2 - q^2 + (r-p-q)^2 \rangle^{1-\varepsilon}} \\ & \lesssim \sup_{\alpha} \int \frac{dp}{|p||r-p|^2} \int dq \left( \frac{1}{|q|^{2+\theta}} + \frac{1}{|r-q-p|^{2+\theta}} \right) \frac{1}{\langle \alpha - p^2 - q^2 + (r-p-q)^2 \rangle^{1-\varepsilon}} \quad (10.27) \\ & \lesssim \sup_{\alpha_1} \int \frac{dp}{|p||r-p|^{3-\theta}} \frac{1}{\langle \alpha_1 - 2p \cdot r \rangle^{\theta-\varepsilon-\eta}} + \sup_{\alpha_2} \int \frac{dp}{|p||r-p|^{3-\theta}} \frac{1}{\langle \alpha_2 - 2(p-\frac{r}{2})^2 \rangle^{\theta-\varepsilon-\eta}}, \end{aligned}$$

for any small  $\eta > 0$ . Using Lemma 10.3, the first term can be handled as follows

$$\begin{aligned} & \sup_{\alpha_1} \int \frac{dp}{|p||r-p|^{3-\theta}} \frac{1}{\langle \alpha_1 - 2p \cdot r \rangle^{\theta-\varepsilon-\eta}} \\ & \lesssim \frac{1}{|r|^{1-\frac{\theta}{2}}} \sup_{\alpha_1} \int dp \left( \frac{1}{|p|^{3-\frac{\theta}{2}}} + \frac{1}{|r-p|^{3-\frac{\theta}{2}}} \right) \frac{1}{\langle \alpha_1 - 2p \cdot r \rangle^{\theta-\varepsilon-\eta}} \quad (10.28) \\ & \lesssim \frac{1}{|r|} \sup_{\alpha_1} \frac{1}{\langle \alpha_1 \rangle^{\frac{\theta}{2}-\varepsilon-2\eta}} \lesssim \frac{1}{|r|} \end{aligned}$$

because  $\theta > 0$ ,  $\varepsilon < \theta/2$ , and  $\eta$  is arbitrarily small. As for the second term on the r.h.s. of (10.27), from Lemma 10.2, we find (using again that  $0 < \varepsilon < \theta/2$  and choosing  $\gamma = 0$ )

$$\begin{aligned} & \sup_{\alpha_2} \int \frac{dp}{|p||r-p|^{3-\theta}} \frac{1}{\langle \alpha_2 - 2(p-\frac{r}{2})^2 \rangle^{\theta-\varepsilon-\eta}} \\ & \lesssim \frac{1}{|r|} \sup_{\alpha_2} \int dp \left( \frac{1}{|p|^{3-\theta}} + \frac{1}{|r-p|^{3-\theta}} \right) \frac{1}{\langle \alpha_2 - 2(p-\frac{r}{2})^2 \rangle^{\theta-\varepsilon-\eta}} \quad (10.29) \\ & \lesssim \frac{1}{|r|} \sup_{\alpha_3} \frac{1}{\langle \alpha_3 \rangle^{\frac{\theta}{2}-\varepsilon-2\eta}} \lesssim \frac{1}{|r|}. \end{aligned}$$

Exactly the same proof also works for (10.22).  $\square$

Finally, in the next proposition, we show how to integrate out vertices with three alive son-edges, one of which carries a spherical denominator (that is one of the son-edges is a  $(2+s+\kappa)$ - or a  $(1+s+\kappa)$ -edge): these are vertices of the type 5) in (9.58) and of the type 11) or 12) in (9.74).

**Proposition 10.7.** *Suppose  $0 < \lambda < 1/5$  and  $0 \leq \varepsilon < \lambda/2$ . Let  $\kappa_1, \kappa_2, \kappa_3 \geq 0$ , with  $\kappa_1 + \kappa_2 + \kappa_3 \leq \lambda$ . Then there exists a constant  $C = C(\lambda, \varepsilon, \kappa_1, \kappa_2, \kappa_3)$  such that*

$$\begin{aligned} & \sup_{\alpha, \beta, c} \int \frac{dp dq}{|p-c_1|^{2+\kappa_1}|q-c_2|^{2+\kappa_2}|r-p-q-c_3|^{2+\kappa_3}} \frac{1}{\langle \beta + (p-c)^2 \rangle^{1-\varepsilon}} \\ & \quad \times \frac{1}{\langle \alpha - p^2 \pm q^2 \pm (r-p-q)^2 \rangle^{1-\varepsilon}} \leq C \sum_{j=1}^{\mu} \frac{1}{|r-b_j|^{2+\lambda}} \quad (10.30) \end{aligned}$$

and

$$\begin{aligned} & \sup_{\alpha, \beta, c} \int \frac{dp dq}{|p-c_1|^{1+\kappa_1}|q-c_2|^{2+\kappa_2}|r-p-q-c_3|^{2+\kappa_3}} \frac{1}{\langle \beta + (p-c)^2 \rangle^{1-\varepsilon}} \\ & \quad \times \frac{1}{\langle \alpha - p^2 \pm q^2 \pm (r-p-q)^2 \rangle^{1-\varepsilon}} \leq C \sum_{j=1}^{\mu} \frac{1}{|r-b_j|^{1+\lambda}} \quad (10.31) \end{aligned}$$

and

$$\begin{aligned} \sup_{\alpha, \beta, c} \int \frac{dp dq}{|p - c_1|^{2+\kappa_1} |q - c_2|^{1+\kappa_2} |r - p - q - c_3|^{2+\kappa_3}} \frac{1}{\langle \beta + (p - c)^2 \rangle^{1-\varepsilon}} \\ \times \frac{1}{\langle \alpha - p^2 \pm q^2 \pm (r - p - q)^2 \rangle^{1-\varepsilon}} \leq C \sum_{j=1}^{\mu} \frac{1}{|r - b_j|^{1+\lambda}} \end{aligned} \quad (10.32)$$

for every  $c_1, c_2, c_3 \in \mathbb{R}^3$ . Here the  $b_j$  are linear combinations of  $c_1, c_2, c_3$  and  $\mu$  is a universal integer constant. The bounds hold for all four possible choices of the two signs.

*Remarks.* The bound (10.31) is used if one of the son-edges is a  $(1 + \kappa)$ -edge and one of the other two son-edges is a  $(2 + s + \kappa)$ -edge, with  $\kappa = 0, \lambda$ , or  $2\lambda$ . The bound (10.32), on the other hand, is used if one of the son-edges is a  $(1 + s + \kappa)$ -edge. The different signs in the propagators are needed depending on the orientation of the edge carrying the spherical denominator (in our notation this is the edge with momentum  $p$ ), and on which one of the two terms on the r.h.s. of (9.61) arising from the  $\alpha$ -integration we are considering. Note that since one of the son edges always has an opposite orientation with respect to the other two, the sign combination  $(--)$  in the propagators does not arise in our applications. Although the estimates remain true also in this case, we prove them only for the other combinations  $(++)$ ,  $(+-)$  and  $(-+)$ .

*Proof.* We prove the proposition in the case  $c_1 = c_2 = c_3 = 0$ : to generalize the proof for  $c_1, c_2, c_3 \neq 0$  one can proceed as we did in Proposition 10.4 (since we assume  $c_1 = c_2 = c_3 = 0$ , in our proof we will only need one term on the r.h.s. of (10.30), (10.31) and (10.32), that is we can take  $\mu = 1$  and  $b_1 = 0$ ; however, when  $c_1, c_2, c_3$  do not vanish, one need  $\mu > 1$ , as in Prop. 10.4). Without loss of generality we can also assume that  $\varepsilon > 0$  (the l.h.s. of (10.30), (10.31) and (10.32) is clearly increasing in  $\varepsilon$ ). We begin by proving (10.30) and (10.31): to this end we introduce the parameter  $\theta$  which can assume the values 1, 2 (to prove (10.30) we use  $\theta = 2$ , to prove (10.31) we use  $\theta = 1$ ). The possible combinations of the two signs lead to the three contributions

$$\begin{aligned} \text{(I)} &:= \sup_{\alpha, \beta, c} \int \frac{dp dq}{|p|^{\theta+\kappa_1} |q|^{2+\kappa_2} |r - p - q|^{2+\kappa_3}} \frac{1}{\langle \beta + (p - c)^2 \rangle^{1-\varepsilon}} \frac{1}{\langle \alpha - \frac{1}{4}(p+r)^2 + (q + \frac{p-r}{2})^2 \rangle^{1-\varepsilon}} \\ \text{(II)} &:= \sup_{\alpha, \beta, c} \int \frac{dp dq}{|p|^{\theta+\kappa_1} |q|^{2+\kappa_2} |r - p - q|^{2+\kappa_3}} \frac{1}{\langle \beta + (p - c)^2 \rangle^{1-\varepsilon}} \frac{1}{\langle \alpha - (p - \frac{r}{2})^2 - q \cdot (p - r) \rangle^{1-\varepsilon}} \\ \text{(III)} &:= \sup_{\alpha, \beta, c} \int \frac{dp dq}{|p|^{\theta+\kappa_1} |q|^{2+\kappa_2} |r - p - q|^{2+\kappa_3}} \frac{1}{\langle \beta + (p - c)^2 \rangle^{1-\varepsilon}} \frac{1}{\langle \alpha - p \cdot r + q \cdot (p - r) \rangle^{1-\varepsilon}} \end{aligned} \quad (10.33)$$

The first formula corresponds to the sign choice  $(++)$ , the second and third ones are the choices  $(+-)$  and  $(-+)$  (as remarked above, we do not consider, in this proof, the case  $(--)$ , because we do not need it in our applications). Recall that  $\theta = 2$  is needed for the proof of (10.30) and  $\theta = 1$  for the proof of (10.31). To derive (10.33), we shifted the variable  $\alpha$  by some number independent of  $p$  and  $q$ : this is clearly allowed, because we take the supremum over  $\alpha$ .

We start by estimating the contribution (I). With  $\kappa = \kappa_1 + \kappa_2 + \kappa_3$ , and using the assumption  $\kappa \leq \lambda$ , we find, from (10.12),

$$\begin{aligned} \frac{1}{|p|^{\theta+\kappa_1} |q|^{2+\kappa_2} |r - p - q|^{2+\kappa_3}} \lesssim \frac{1}{|p|^{\theta+\kappa} |r - p|^{2-2\lambda-\frac{\kappa}{2}+\varepsilon}} \left( \frac{1}{|q|^{2+2\lambda+\frac{\kappa}{2}-\varepsilon}} + \frac{1}{|r - p - q|^{2+2\lambda+\frac{\kappa}{2}-\varepsilon}} \right) \\ + \frac{1}{|p|^\theta |r - p|^{2-2\lambda+\frac{\kappa}{2}+\varepsilon}} \left( \frac{1}{|q|^{2+2\lambda+\frac{\kappa}{2}-\varepsilon}} + \frac{1}{|r - p - q|^{2+2\lambda+\frac{\kappa}{2}-\varepsilon}} \right). \end{aligned} \quad (10.34)$$

This implies, with a simple shift of the  $q$  variable, that

$$\begin{aligned}
(\text{I}) &\lesssim \sup_{\alpha, \beta, c} \int \frac{dp}{|p|^{\theta+\kappa}|r-p|^{2-2\lambda-\frac{\kappa}{2}+\varepsilon}} \frac{1}{\langle \beta + (p-c)^2 \rangle^{1-\varepsilon}} \\
&\quad \times \int \frac{dq}{|q|^{2+2\lambda+\frac{\kappa}{2}-\varepsilon}} \frac{1}{\langle \alpha - \frac{1}{4}(p+r)^2 + (q + \frac{p-r}{2})^2 \rangle^{1-\varepsilon}} \\
&+ \sup_{\alpha, \beta, c} \int \frac{dp}{|p|^\theta |r-p|^{2-2\lambda+\frac{\kappa}{2}+\varepsilon}} \frac{1}{\langle \beta + (p-c)^2 \rangle^{1-\varepsilon}} \\
&\quad \times \int \frac{dq}{|q|^{2+2\lambda+\frac{\kappa}{2}-\varepsilon}} \frac{1}{\langle \alpha - \frac{1}{4}(p+r)^2 + (q + \frac{p-r}{2})^2 \rangle^{1-\varepsilon}}.
\end{aligned} \tag{10.35}$$

To bound the  $q$ -integrals, we apply Lemma 10.2 with  $\gamma = 1 - 2\lambda - \frac{\kappa}{2} - \varepsilon$ ,  $2\delta = -2\lambda - \frac{\kappa}{2} + \varepsilon$  and  $\eta = \varepsilon$ ; this is allowed, because  $1 - 2\lambda - \frac{\kappa}{2} - \varepsilon > 0$  (since  $\varepsilon < \lambda/2$  and  $\lambda < 1/5$ ), because  $1 - 2\lambda - (\kappa/2) - \varepsilon < 1 - 2\lambda - (\kappa/2) + \varepsilon$  (since we assumed  $\varepsilon > 0$ ), and because  $1 - 2\lambda - (\kappa/2) - \varepsilon < 1 + 2\lambda + (\kappa/2) - 3\varepsilon$ . We obtain (using that  $\kappa \leq \lambda < 1/5$ )

$$\begin{aligned}
(\text{I}) &\lesssim \sup_{\alpha, \beta, c} \int \frac{dp}{|p|^{\theta+\kappa}|r-p|^{3-4\lambda-\kappa}} \frac{1}{\langle \beta + (p-c)^2 \rangle^{1-\varepsilon}} \frac{1}{\langle \alpha - p \cdot r \rangle^{2\lambda+\frac{\kappa}{2}-2\varepsilon}} \\
&+ \sup_{\alpha, \beta, c} \int \frac{dp}{|p|^\theta |r-p|^{3-4\lambda}} \frac{1}{\langle \beta + (p-c)^2 \rangle^{1-\varepsilon}} \frac{1}{\langle \alpha - p \cdot r \rangle^{2\lambda+\frac{\kappa}{2}-2\varepsilon}} \\
&\lesssim \frac{1}{|r|^\theta} \sup_{\alpha, \beta, c} \int \frac{dp}{|p|^{3-4\lambda}} \frac{1}{\langle \beta + (p-c)^2 \rangle^{1-\varepsilon}} \frac{1}{\langle \alpha - p \cdot r \rangle^{2\lambda+\frac{\kappa}{2}-2\varepsilon}}
\end{aligned} \tag{10.36}$$

where we used (10.12) and a simple shift of the  $p$ -variable (and also of the variables  $\alpha$  and  $c$ , over which we take the supremum). To estimate this term we use a Hölder inequality:

$$\begin{aligned}
&\sup_{\alpha, \beta, c} \int \frac{dp}{|p|^{3-4\lambda}} \frac{1}{\langle \beta + (p-c)^2 \rangle^{1-\varepsilon}} \frac{1}{\langle \alpha - p \cdot r \rangle^{2\lambda+\frac{\kappa}{2}-2\varepsilon}} \\
&\lesssim \sup_{\alpha, \beta, c} \left( \int \frac{dp}{|p|^{2+\frac{1-5\lambda-(\kappa/2)+2\varepsilon}{1-2\lambda-(\kappa/2)+2\varepsilon}}} \frac{1}{\langle \beta + (p-c)^2 \rangle} \right)^{1-2\lambda-\frac{\kappa}{2}+2\varepsilon} \\
&\quad \times \left( \int \frac{dp}{|p|^{2+\frac{\lambda+(\kappa/2)-2\varepsilon}{2\lambda+(\kappa/2)-2\varepsilon}}} \frac{1}{\langle \alpha - p \cdot r \rangle} \right)^{2\lambda+\frac{\kappa}{2}-2\varepsilon}
\end{aligned} \tag{10.37}$$

where we used that  $(1-\varepsilon)/(1-2\lambda-(\kappa/2)+2\varepsilon) \geq 1$  (this follows from  $\varepsilon < \lambda/2$ ) and that  $\langle \beta - (p-c)^2 \rangle \geq 1$ . The first integral is bounded uniformly in  $\beta$  and  $c$ : this follows from Lemma 10.2 (with  $\gamma = 0$ ), because  $-1 < (1 - 5\lambda - (\kappa/2) + 2\varepsilon)/(1 - 2\lambda - (\kappa/2) + 2\varepsilon) < 1$  (this follows from  $\kappa \leq \lambda < 1/5$ ). As for the second integral, since  $0 < (\lambda + (\kappa/2) - 2\varepsilon)/(2\lambda + (\kappa/2) - 2\varepsilon) < 1$  (from  $\varepsilon < \lambda/2$ ), we can apply Lemma 10.3:

$$\sup_{\tilde{\alpha}, \beta, c} \int \frac{dp}{|p|^{3-4\lambda}} \frac{1}{\langle \beta + (p-\tilde{c})^2 \rangle^{1-\varepsilon}} \frac{1}{\langle \tilde{\alpha} - 2p \cdot r \rangle^{2\lambda+\frac{\kappa}{2}-2\varepsilon}} \lesssim \frac{1}{|r|^\lambda}. \tag{10.38}$$

The powers of  $|p|$  in (10.37) were chosen exactly in order to get this decay. With (10.36), we conclude that  $(\text{I}) \lesssim |r|^{-\theta-\lambda}$ .

Next we consider the term (II) in (10.33). Instead of (10.34) we use here the similar bound

$$\begin{aligned} \frac{1}{|p|^{\theta+\kappa_1}|q|^{2+\kappa_2}|r-p-q|^{2+\kappa_3}} &\lesssim \frac{1}{|p|^{\theta+\kappa}|r-p|^{2-2\lambda-\frac{\kappa}{2}}} \left( \frac{1}{|q|^{2+2\lambda+\frac{\kappa}{2}}} + \frac{1}{|r-p-q|^{2+2\lambda+\frac{\kappa}{2}}} \right) \\ &\quad + \frac{1}{|p|^\theta|r-p|^{2-2\lambda+\frac{\kappa}{2}}} \left( \frac{1}{|q|^{2+2\lambda+\frac{\kappa}{2}}} + \frac{1}{|r-p-q|^{2+2\lambda+\frac{\kappa}{2}}} \right). \end{aligned} \quad (10.39)$$

With a shift of the  $q$  variable, we obtain

$$\begin{aligned} \text{(II)} &\lesssim \sup_{\alpha,\beta,c} \int \frac{dp}{|p|^{\theta+\kappa}|r-p|^{2-2\lambda-\frac{\kappa}{2}}} \frac{1}{\langle \beta + (p-c)^2 \rangle^{1-\varepsilon}} \int \frac{dq}{|q|^{2+2\lambda+\frac{\kappa}{2}}} \frac{1}{\langle \alpha - (p-\frac{r}{2})^2 - q \cdot (p-r) \rangle^{1-\varepsilon}} \\ &\quad + \sup_{\alpha,\beta,c} \int \frac{dp}{|p|^{\theta+\kappa}|r-p|^{2-2\lambda-\frac{\kappa}{2}}} \frac{1}{\langle \beta + (p-c)^2 \rangle^{1-\varepsilon}} \int \frac{dq}{|q|^{2+2\lambda+\frac{\kappa}{2}}} \frac{1}{\langle \alpha - p \cdot r - q \cdot (p-r) \rangle^{1-\varepsilon}} \\ &\quad + \sup_{\alpha,\beta,c} \int \frac{dp}{|p|^\theta|r-p|^{2-2\lambda+\frac{\kappa}{2}}} \frac{1}{\langle \beta + (p-c)^2 \rangle^{1-\varepsilon}} \int \frac{dq}{|q|^{2+2\lambda+\frac{\kappa}{2}}} \frac{1}{\langle \alpha - (p-\frac{r}{2})^2 - q \cdot (p-r) \rangle^{1-\varepsilon}} \\ &\quad + \sup_{\alpha,\beta,c} \int \frac{dp}{|p|^\theta|r-p|^{2-2\lambda+\frac{\kappa}{2}}} \frac{1}{\langle \beta + (p-c)^2 \rangle^{1-\varepsilon}} \int \frac{dq}{|q|^{2+2\lambda+\frac{\kappa}{2}}} \frac{1}{\langle \alpha - p \cdot r - q \cdot (p-r) \rangle^{1-\varepsilon}}. \end{aligned} \quad (10.40)$$

Applying Lemma 10.3 (with  $\eta = \varepsilon$ ) to bound the  $q$ -integral in the four terms, we find

$$\begin{aligned} \text{(II)} &\lesssim \sup_{\alpha,\beta,c} \int \frac{dp}{|p|^{\theta+\kappa}|r-p|^{3-4\lambda-\kappa}} \frac{1}{\langle \beta + (p-c)^2 \rangle^{1-\varepsilon}} \frac{1}{\langle \alpha - (p-\frac{r}{2})^2 \rangle^{2\lambda+\frac{\kappa}{2}-2\varepsilon}} \\ &\quad + \sup_{\alpha,\beta,c} \int \frac{dp}{|p|^{\theta+\kappa}|r-p|^{3-4\lambda-\kappa}} \frac{1}{\langle \beta + (p-c)^2 \rangle^{1-\varepsilon}} \frac{1}{\langle \alpha - p \cdot r \rangle^{2\lambda+\frac{\kappa}{2}-2\varepsilon}} \\ &\quad + \sup_{\alpha,\beta,c} \int \frac{dp}{|p|^\theta|r-p|^{3-4\lambda}} \frac{1}{\langle \beta + (p-c)^2 \rangle^{1-\varepsilon}} \frac{1}{\langle \alpha - (p-\frac{r}{2})^2 \rangle^{2\lambda+\frac{\kappa}{2}-2\varepsilon}} \\ &\quad + \sup_{\alpha,\beta,c} \int \frac{dp}{|p|^\theta|r-p|^{3-4\lambda}} \frac{1}{\langle \beta + (p-c)^2 \rangle^{1-\varepsilon}} \frac{1}{\langle \alpha - p \cdot r \rangle^{2\lambda+\frac{\kappa}{2}-2\varepsilon}}. \end{aligned} \quad (10.41)$$

Using that  $\kappa \leq \lambda < 1/5$ , it follows from (10.12) and from a shift of the  $p$  variable (and of the  $\alpha$  and  $c$  variable as well), that

$$\begin{aligned} \text{(II)} &\lesssim \frac{1}{|r|^\theta} \sup_{\alpha,\beta,c} \int \frac{dp}{|p|^{3-4\lambda}} \frac{1}{\langle \beta + (p-c)^2 \rangle^{1-\varepsilon}} \frac{1}{\langle \alpha - (p-\frac{r}{2})^2 \rangle^{2\lambda+\frac{\kappa}{2}-2\varepsilon}} \\ &\quad + \frac{1}{|r|^\theta} \sup_{\alpha,\beta,c} \int \frac{dp}{|p|^{3-4\lambda}} \frac{1}{\langle \beta + (p-c)^2 \rangle^{1-\varepsilon}} \frac{1}{\langle \alpha - p \cdot r \rangle^{2\lambda+\frac{\kappa}{2}-2\varepsilon}}. \end{aligned} \quad (10.42)$$

The second term is identical to the r.h.s. of (10.36), and can be estimated in the same way. As for the first term on the r.h.s. of the last equation, we apply a Hölder inequality (we use here the same exponents as in (10.37) but here we divide the powers of  $|p|$  in a different way):

$$\begin{aligned} &\sup_{\alpha,\beta,c} \int \frac{dp}{|p|^{3-4\lambda}} \frac{1}{\langle \beta + (p-c)^2 \rangle^{1-\varepsilon}} \frac{1}{\langle \alpha - (p-\frac{r}{2})^2 \rangle^{2\lambda+\frac{\kappa}{2}-2\varepsilon}} \\ &\lesssim \sup_{\alpha,\beta,c} \left( \int \frac{dp}{|p|^{2+\frac{1-4\lambda}{1-2\lambda-\frac{\kappa}{2}+2\varepsilon}}} \frac{1}{\langle \beta + (p-c)^2 \rangle} \right)^{1-2\lambda-\frac{\kappa}{2}+2\varepsilon} \left( \int \frac{dp}{|p|^2} \frac{1}{\langle \alpha - (p-\frac{r}{2})^2 \rangle} \right)^{2\lambda+\frac{\kappa}{2}-2\varepsilon}. \end{aligned} \quad (10.43)$$

Since  $-1 < (1-4\lambda)/(1-2\lambda - (\kappa/2) + 2\varepsilon) < 1$  (as follows from  $\lambda < 1/5$ ), the first integral is bounded uniformly in  $\beta$  and  $c$  by Lemma 10.2. To estimate the second integral we use again Lemma 10.2, with  $\gamma = \lambda/(2\lambda + (\kappa/2) - 2\varepsilon)$  (this is allowed because  $\lambda/(2\lambda + (\kappa/2) - 2\varepsilon) < 1$  for  $\varepsilon < \lambda/2$ ). We conclude that

$$\sup_{\alpha, \beta, c} \int \frac{dp}{|p|^{3-4\lambda}} \frac{1}{\langle \beta - (p-c)^2 \rangle^{1-\varepsilon}} \frac{1}{\langle \alpha - (p - \frac{r}{2})^2 \rangle^{2\lambda + \frac{\kappa}{2} - 2\varepsilon}} \lesssim \frac{1}{\langle r \rangle^\lambda} \leq \frac{1}{|r|^\lambda}. \quad (10.44)$$

From (10.42) it follows that (II)  $\lesssim |r|^{-\theta-\lambda}$ .

Next we consider the term (III) in (10.33). With (10.39), we find

$$\begin{aligned} \text{(III)} &\lesssim \sup_{\alpha, \beta, c} \int \frac{dp}{|p|^{\theta+\kappa} |r-p|^{2-2\lambda-\frac{\kappa}{2}}} \frac{1}{\langle \beta + (p-c)^2 \rangle^{1-\varepsilon}} \int \frac{dq}{|q|^{2+2\lambda+\frac{\kappa}{2}}} \frac{1}{\langle \alpha - p \cdot r + q \cdot (p-r) \rangle^{1-\varepsilon}} \\ &+ \sup_{\alpha, \beta, c} \int \frac{dp}{|p|^{\theta+\kappa} |r-p|^{2-2\lambda-\frac{\kappa}{2}}} \frac{1}{\langle \beta + (p-c)^2 \rangle^{1-\varepsilon}} \int \frac{dq}{|q|^{2+2\lambda+\frac{\kappa}{2}}} \frac{1}{\langle \alpha - (p-\frac{r}{2})^2 + q \cdot (p-r) \rangle^{1-\varepsilon}} \\ &+ \sup_{\alpha, \beta, c} \int \frac{dp}{|p|^\theta |r-p|^{2-2\lambda+\frac{\kappa}{2}}} \frac{1}{\langle \beta + (p-c)^2 \rangle^{1-\varepsilon}} \int \frac{dq}{|q|^{2+2\lambda+\frac{\kappa}{2}}} \frac{1}{\langle \alpha - p \cdot r + q \cdot (p-r) \rangle^{1-\varepsilon}} \\ &+ \sup_{\alpha, \beta, c} \int \frac{dp}{|p|^\theta |r-p|^{2-2\lambda+\frac{\kappa}{2}}} \frac{1}{\langle \beta + (p-c)^2 \rangle^{1-\varepsilon}} \int \frac{dq}{|q|^{2+2\lambda+\frac{\kappa}{2}}} \frac{1}{\langle \alpha - (p-\frac{r}{2})^2 + q \cdot (p-r) \rangle^{1-\varepsilon}}. \end{aligned} \quad (10.45)$$

These terms can be estimated as we did with the four terms on the r.h.s. of (10.40) (the different sign in front of the factor  $q \cdot (p-r)$  plays no role in our bounds).

As for (10.32), similarly to (10.33) we find the three contributions

$$\begin{aligned} \text{(I')} &:= \sup_{\alpha, \beta, c} \int \frac{dp dq}{|p|^{2+\kappa_1} |q|^{1+\kappa_2} |r-p-q|^{2+\kappa_3}} \frac{1}{\langle \beta + (p-c)^2 \rangle^{1-\varepsilon}} \frac{1}{\langle \alpha - \frac{1}{4}(p+r)^2 + (q + \frac{p-r}{2})^2 \rangle^{1-\varepsilon}} \\ \text{(II')} &:= \sup_{\alpha, \beta, c} \int \frac{dp dq}{|p|^{2+\kappa_1} |q|^{1+\kappa_2} |r-p-q|^{2+\kappa_3}} \frac{1}{\langle \beta + (p-c)^2 \rangle^{1-\varepsilon}} \frac{1}{\langle \alpha - (p-\frac{r}{2})^2 - q \cdot (p-r) \rangle^{1-\varepsilon}} \\ \text{(III')} &:= \sup_{\alpha, \beta, c} \int \frac{dp dq}{|p|^{2+\kappa_1} |q|^{1+\kappa_2} |r-p-q|^{2+\kappa_3}} \frac{1}{\langle \beta + (p-c)^2 \rangle^{1-\varepsilon}} \frac{1}{\langle \alpha - p \cdot r + q \cdot (p-r) \rangle^{1-\varepsilon}}. \end{aligned} \quad (10.46)$$

The analysis of (I')–(III') is then very similar to the one of (I)–(III): the only difference is that instead of using (10.34) and (10.39), we employ

$$\begin{aligned} \frac{1}{|p|^{2+\kappa_1} |q|^{1+\kappa_2} |r-p-q|^{2+\kappa_3}} &\lesssim \frac{1}{|p|^{2+\kappa} |r-p|^{1-2\lambda-\frac{\kappa}{2}+\varepsilon}} \left( \frac{1}{|q|^{2+2\lambda+\frac{\kappa}{2}-\varepsilon}} + \frac{1}{|r-p-q|^{2+2\lambda+\frac{\kappa}{2}-\varepsilon}} \right) \\ &+ \frac{1}{|p|^2 |r-p|^{1-2\lambda+\frac{\kappa}{2}+\varepsilon}} \left( \frac{1}{|q|^{2+2\lambda+\frac{\kappa}{2}-\varepsilon}} + \frac{1}{|r-p-q|^{2+2\lambda+\frac{\kappa}{2}-\varepsilon}} \right) \end{aligned} \quad (10.47)$$

to bound the term (I'), and

$$\begin{aligned} \frac{1}{|p|^{2+\kappa_1} |q|^{2+\kappa_2} |r-p-q|^{2+\kappa_3}} &\lesssim \frac{1}{|p|^{2+\kappa} |r-p|^{1-2\lambda-\frac{\kappa}{2}}} \left( \frac{1}{|q|^{2+2\lambda+\frac{\kappa}{2}}} + \frac{1}{|r-p-q|^{2+2\lambda+\frac{\kappa}{2}}} \right) \\ &+ \frac{1}{|p|^2 |r-p|^{1-2\lambda+\frac{\kappa}{2}}} \left( \frac{1}{|q|^{2+2\lambda+\frac{\kappa}{2}}} + \frac{1}{|r-p-q|^{2+2\lambda+\frac{\kappa}{2}}} \right) \end{aligned} \quad (10.48)$$

to bound (II') and (III') (we use (10.47) when the propagator is quadratic in  $q$ , (10.48) when it is linear).  $\square$



## A Some Technical Bounds

In this Appendix we collect some simple information that are used throughout the paper.

**Lemma A.1.** *Let  $a_N$  be the scattering length of  $\frac{1}{N}V_N$  with  $V_N$  given in (1.1) and let  $b_0 := \int V_N = \int V$ . We assume additionally that  $V$  is radially symmetric. Then for any  $0 < \beta < 1$*

$$\lim_{N \rightarrow \infty} Na_N = \frac{b_0}{8\pi}. \quad (\text{A.1})$$

*Proof.* Let  $R$  be the radius of the support of  $V$ , i.e.  $V(x) = 0$  for  $|x| \geq R$ . An upper bound for  $a_N$  can be obtained by the inequality (see, for example [23])

$$8\pi a_N \leq \int \frac{1}{N} V_N = \frac{b_0}{N}. \quad (\text{A.2})$$

To derive a lower bound for  $a_N$ , we recall that the scattering length can be computed through the integral

$$8\pi a_N = \int \frac{1}{N} V_N f, \quad (\text{A.3})$$

where  $f(x)$  is the radial symmetric solution of the zero energy equation

$$\left( -\Delta + \frac{1}{2N} V_N \right) f = 0$$

with  $f(x) \rightarrow 1$  as  $|x| \rightarrow \infty$ . It is easy to show that

$$f(x) \geq \begin{cases} 1 - \frac{a_N}{|x|} & \text{for } |x| \geq a_N \\ 0 & \text{for } |x| \leq a_N \end{cases}. \quad (\text{A.4})$$

This can be proven as follows. We write  $f(x) = g(|x|)/|x|$ . Then  $g$  satisfies the one-dimensional equation

$$-g''(r) + \frac{N^{3\beta}}{2N} V(N^\beta r)g(r) = 0.$$

Simple arguments show that  $g(r) \geq 0$  for all  $r \geq 0$ . Moreover, for  $r \geq RN^{-\beta}$ , we have  $g(r) = r - a_N$  (it is easy to see that this definition of the scattering length  $a$  agrees with (A.3)). For  $r < RN^{-\beta}$  we have

$$\begin{aligned} g(RN^{-\beta}) - g(r) &= \int_r^{RN^{-\beta}} ds g'(s) \\ &= \int_r^{RN^{-\beta}} ds \left( g'(RN^{-\beta}) - \int_s^{RN^{-\beta}} d\tau g''(\tau) \right) \\ &= (RN^{-\beta} - r) - \int_r^{RN^{-\beta}} ds \int_s^{RN^{-\beta}} d\tau \frac{N^{3\beta-1}}{2} V(N^\beta \tau)g(\tau), \end{aligned} \quad (\text{A.5})$$

because  $g'(RN^{-\beta}) = 1$ . Since  $g(RN^{-\beta}) = RN^{-\beta} - a_N$ , we obtain

$$r - g(r) = a_N - \int_r^{RN^{-\beta}} ds \int_s^{RN^{-\beta}} d\tau N^{3\beta-1} V(N^\beta \tau)g(\tau). \quad (\text{A.6})$$

From the non-negativity of the potential and from  $g \geq 0$ , it follows that  $r - g(r) \leq a_N$  for all  $r < RN^{-\beta}$ , and hence  $f(x) = g(|x|)/|x| \geq 1 - a_N/|x|$ . Eq. (A.4) now follows because  $f(x) \geq 0$  for all  $x \in \mathbb{R}^3$ .

Inserting (A.4) into (A.3), and using the bound (A.2), we conclude that

$$\begin{aligned}
8\pi N a_N &\geq \int_{|x| \geq a_N} dx N^{3\beta} V(N^\beta x) \left(1 - \frac{a_N}{|x|}\right) \\
&\geq \int_{|x| \geq b_0/8\pi N} dx N^{3\beta} V(N^\beta x) - \frac{b_0}{8\pi N} \int \frac{dx}{|x|} N^{3\beta} V(N^\beta x) \\
&\geq b_0 - \int_{|x| \leq b_0/8\pi N} dx N^{3\beta} V(N^\beta x) - \frac{b_0}{8\pi} N^{\beta-1} \int \frac{dx}{|x|} V(x) \\
&\geq b_0 - \frac{4\pi}{3} \left(\frac{b_0 N^{\beta-1}}{8\pi}\right)^3 \|V\|_\infty - \frac{b_0}{8\pi} N^{\beta-1} \|V\|_\infty \int_{|x| \leq R} \frac{dx}{|x|}.
\end{aligned} \tag{A.7}$$

This, together with (A.2), implies that

$$b_0 - C_1 N^{3\beta-3} - C_2 N^{\beta-1} \leq 8\pi N a_N \leq b_0, \tag{A.8}$$

for two  $N$ -independent constants  $C_1, C_2$ . Hence, for  $0 < \beta < 1$ , we obtain (A.1).  $\square$

In the next lemma we prove that solutions of the nonlinear Schrödinger equation which are in the space  $H^1(\mathbb{R}^3)$  at time  $t = 0$ , have  $H^1$  norm uniformly bounded in time.

**Lemma A.2.** *Suppose  $\varphi \in H^1(\mathbb{R}^3)$ , and let  $\varphi_t$  be the solution of the nonlinear Schrödinger equation*

$$i\partial_t \varphi_t = -\Delta \varphi_t + b_0 |\varphi_t|^2 \varphi_t \tag{A.9}$$

with  $b_0 > 0$ . Then

$$(\varphi_t, (1 - \Delta)\varphi_t) = \int dx (|\varphi_t(x)|^2 + |\nabla \varphi_t(x)|^2) \leq C \tag{A.10}$$

for all  $t \in \mathbb{R}$ . Hence, with  $\gamma_t^{(k)}(\mathbf{x}_k; \mathbf{x}'_k) = \prod_{j=1}^k \varphi_t(x_j) \overline{\varphi_t(x'_j)}$ , we have

$$\text{Tr} |S_1 \dots S_k \gamma_t^{(k)} S_k \dots S_1| \leq C^k \tag{A.11}$$

The constant  $C$  only depends on  $b_0$  and on the  $H^1$ -norm of  $\varphi$ .

*Proof.* The  $L^2$ -norm of  $\varphi_t$  is conserved in time. Also the energy

$$E(\varphi) = \int dx |\nabla \varphi(x)|^2 + \frac{b_0}{2} \int dx |\varphi(x)|^4$$

is conserved. By the Sobolev inequality, we have

$$\int dx |\nabla \varphi(x)|^2 \leq E(\varphi) \leq C \|\varphi\|_{H^1}^4,$$

for a constant  $C$  only depending on  $b_0$ . Hence

$$\int |\nabla \varphi_t(x)|^2 \leq E(\varphi_t) = E(\varphi) \leq C \|\varphi\|_{H^1}^4.$$

$\square$

The following lemma is useful to bound the pair interaction  $V_N(x)$  in terms of the kinetic energy.

**Lemma A.3.** *Let  $V \in L^1(\mathbb{R}^3) \cap L^{3/2}(\mathbb{R}^3)$ . Put  $V_N(x) = N^{3\beta}V(N^\beta x)$ . Then*

$$V_N(x_1 - x_2) \leq (\text{const.})\|V\|_{L^1} (1 - \Delta_1)(1 - \Delta_2)$$

and

$$V_N(x_1 - x_2) \leq (\text{const.})N^\beta\|V\|_{L^{3/2}}(1 - \Delta_1)$$

hold with universal constants.

*Proof.* For a proof of these results, see Lemma 5.2 in [9].  $\square$

Finally, we give a proof of Lemma 8.2 that is a slight modification of the proof of Proposition 8.1 in [9].

*Proof of Lemma 8.2.* By the positivity of  $\gamma^{(k+1)}$ , it is enough to prove (8.8) for the special case  $\gamma^{(k+1)}(\mathbf{x}_{k+1}, \mathbf{x}'_{k+1}) = f(\mathbf{x}_{k+1})\bar{f}(\mathbf{x}'_{k+1})$ . We can then bound the l.h.s. of (8.8) by the sum

$$\begin{aligned} & \left| \int d\mathbf{x}_{k+1} d\mathbf{x}'_{k+1} J^{(k)}(\mathbf{x}_k; \mathbf{x}'_k) (\delta_{\alpha_1}(x'_{k+1} - x_{k+1}) - \delta(x'_{k+1} - x_{k+1})) \delta_{\alpha_2}(x_j - x_{k+1}) f(\mathbf{x}_{k+1})\bar{f}(\mathbf{x}'_{k+1}) \right| \\ & + \left| \int d\mathbf{x}_{k+1} d\mathbf{x}'_{k+1} J^{(k)}(\mathbf{x}_k; \mathbf{x}'_k) \delta(x'_{k+1} - x_{k+1}) (\delta_{\alpha_2}(x_j - x_{k+1}) - \delta(x_j - x_{k+1})) f(\mathbf{x}_{k+1})\bar{f}(\mathbf{x}'_{k+1}) \right|. \end{aligned} \quad (\text{A.12})$$

The first term can be bounded by

$$\begin{aligned} & \left| \int d\mathbf{x}_{k+1} d\mathbf{x}'_{k+1} J^{(k)}(\mathbf{x}_k; \mathbf{x}'_k) (\delta_{\alpha_1}(x'_{k+1} - x_{k+1}) - \delta(x'_{k+1} - x_{k+1})) \delta_{\alpha_2}(x_j - x_{k+1}) f(\mathbf{x}_{k+1})\bar{f}(\mathbf{x}'_{k+1}) \right| \\ & \leq \int d\mathbf{x}_{k+1} d\mathbf{x}'_k |J^{(k)}(\mathbf{x}_k; \mathbf{x}'_k)| \delta_{\alpha_2}(x_j - x_{k+1}) |f(\mathbf{x}_{k+1})| \\ & \quad \times \left| \int dx'_{k+1} \delta_{\alpha_1}(x_{k+1} - x'_{k+1}) [f(\mathbf{x}'_k, x_{k+1}) - f(\mathbf{x}'_k, x'_{k+1})] \right|. \end{aligned} \quad (\text{A.13})$$

We use the estimate  $\delta_{\alpha_1}(x) \leq \frac{C}{|B|} \cdot \mathbf{1}_B(x)$  where  $B := \{x : |x| \leq \alpha_1\}$ . A standard Poincaré-type inequality (see, e.g. Lemma 7.16 in [13]) yields that

$$\left| \int dx'_{k+1} \delta_{\alpha_1}(x_{k+1} - x'_{k+1}) [f(\mathbf{x}'_k, x_{k+1}) - f(\mathbf{x}'_k, x'_{k+1})] \right| \leq C \int_{|y| \leq \alpha_1} \frac{|\nabla_{k+1} f(\mathbf{x}'_k, x_{k+1} + y)|}{|y|^2} dy \quad (\text{A.14})$$

for any  $\mathbf{x}'_k$  and  $x_{k+1}$ . Inserting this inequality on the r.h.s. of (A.13) and applying a Schwarz

inequality we get

$$\begin{aligned}
& \left| \int d\mathbf{x}_{k+1} d\mathbf{x}'_{k+1} J^{(k)}(\mathbf{x}_k; \mathbf{x}'_k) (\delta_{\alpha_1}(x'_{k+1} - x_{k+1}) - \delta(x'_{k+1} - x_{k+1})) \delta_{\alpha_2}(x_j - x_{k+1}) f(\mathbf{x}_{k+1}) \bar{f}(\mathbf{x}'_{k+1}) \right| \\
& \leq C \int d\mathbf{x}_{k+1} d\mathbf{x}'_k dy \frac{\mathbf{1}(|y| \leq \alpha_1)}{|y|^2} \delta_{\alpha_2}(x_j - x_{k+1}) |J^{(k)}(\mathbf{x}_k; \mathbf{x}'_k)| \\
& \quad \times (|f(\mathbf{x}_k, x_{k+1})|^2 + |\nabla_{k+1} f(\mathbf{x}'_k, x_{k+1} + y)|^2) \\
& \leq C \alpha_1 \left( \sup_{\mathbf{x}_k} \int d\mathbf{x}'_k |J^{(k)}(\mathbf{x}_k; \mathbf{x}'_k)| \right) \int d\mathbf{x}_{k+1} \delta_{\alpha_2}(x_j - x_{k+1}) |f(\mathbf{x}_k, x_{k+1})|^2 \\
& \quad + C \left( \sup_{\mathbf{x}'_k, x_{k+1}} \int d\mathbf{x}_k \delta_{\alpha_2}(x_j - x_{k+1}) |J^{(k)}(\mathbf{x}_k; \mathbf{x}'_k)| \right) \\
& \quad \times \int d\mathbf{x}'_k dx_{k+1} dy \frac{\mathbf{1}(|y| \leq \alpha_1)}{|y|^2} |\nabla_{k+1} f(\mathbf{x}'_k, x_{k+1} + y)|^2.
\end{aligned} \tag{A.15}$$

In the first term we apply Lemma A.3 and in the second term we shift the  $x_{k+1}$  variable, and then we compute the  $y$ -integral. Moreover we use that

$$\sup_{\mathbf{x}_k} \int d\mathbf{x}'_k |J^{(k)}(\mathbf{x}_k; \mathbf{x}'_k)| \leq C^k \|J^{(k)}\|_j \tag{A.16}$$

and

$$\sup_{\mathbf{x}'_k, x_{k+1}} \int d\mathbf{x}_k \delta_{\alpha_2}(x_j - x_{k+1}) |J^{(k)}(\mathbf{x}_k; \mathbf{x}'_k)| \leq C^k \|J^{(k)}\|_j \tag{A.17}$$

for a universal constant  $C$  (recall the definition of the norm  $\|J^{(k)}\|_j$  from (8.7)). Thus, we find

$$\begin{aligned}
& \left| \int d\mathbf{x}_{k+1} d\mathbf{x}'_{k+1} J^{(k)}(\mathbf{x}_k; \mathbf{x}'_k) (\delta_{\alpha_1}(x'_{k+1} - x_{k+1}) - \delta(x'_{k+1} - x_{k+1})) \delta_{\alpha_2}(x_j - x_{k+1}) f(\mathbf{x}_{k+1}) \bar{f}(\mathbf{x}'_{k+1}) \right| \\
& \leq C^k \alpha_1 \|J^{(k)}\|_j \text{Tr} (1 - \Delta_j)(1 - \Delta_{k+1}) \gamma^{(k+1)}.
\end{aligned}$$

In order to control the second term on the r.h.s. of (A.12), we use that

$$\begin{aligned}
& \int d\mathbf{x}_{k+1} d\mathbf{x}'_{k+1} J^{(k)}(\mathbf{x}_k; \mathbf{x}'_k) \delta(x'_{k+1} - x_{k+1}) (\delta_{\alpha_2}(x_j - x_{k+1}) - \delta(x_j - x_{k+1})) f(\mathbf{x}_{k+1}) \bar{f}(\mathbf{x}'_{k+1}) \\
& = \int d\mathbf{x}_k d\mathbf{x}'_k dx_{k+1} (\delta_{\alpha_2}(x_j - x_{k+1}) - \delta(x_j - x_{k+1})) J^{(k)}(\mathbf{x}_k; \mathbf{x}'_k) f(\mathbf{x}_k, x_{k+1}) \bar{f}(\mathbf{x}'_k, x_{k+1}) \\
& = - \int dx_1 \dots dx_{j-1} dx_{j+1} \dots dx_{k+1} d\mathbf{x}'_k \bar{f}(\mathbf{x}'_k, x_{k+1}) \\
& \quad \times \left( J^{(k)}(\hat{\mathbf{x}}_k; \mathbf{x}'_k) f(\hat{\mathbf{x}}_k, x_{k+1}) - \int dx_j \delta_{\alpha_2}(x_j - x_{k+1}) J^{(k)}(\mathbf{x}_k; \mathbf{x}'_k) f(\mathbf{x}_k, x_{k+1}) \right),
\end{aligned} \tag{A.18}$$

where we introduced the notation  $\hat{\mathbf{x}}_k = (x_1, \dots, x_{j-1}, x_{k+1}, x_{j+1}, \dots, x_k)$  (that is  $\hat{\mathbf{x}}_k$  is the same as  $\mathbf{x}_k$ , but with  $x_j$  replaced by  $x_{k+1}$ ). Using again the generalization of the Poincaré inequality that

led to (A.14), we obtain

$$\begin{aligned}
& \left| \int d\mathbf{x}_{k+1} d\mathbf{x}'_{k+1} J^{(k)}(\mathbf{x}_k; \mathbf{x}'_k) \delta(x'_{k+1} - x_{k+1}) (\delta_{\alpha_2}(x_j - x_{k+1}) - \delta(x_j - x_{k+1})) f(\mathbf{x}_{k+1}) \bar{f}(\mathbf{x}'_{k+1}) \right| \\
& \leq C \int d\mathbf{x}_k d\mathbf{x}'_k dx_{k+1} \frac{\mathbf{1}(|x_j - x_{k+1}| \leq \alpha_2)}{|x_j - x_{k+1}|^2} \left| \nabla_j [J^{(k)}(\mathbf{x}_k; \mathbf{x}'_k) f(\mathbf{x}_k, x_{k+1})] \right| |f(\mathbf{x}'_k, x_{k+1})| \\
& \leq C \int d\mathbf{x}_k d\mathbf{x}'_k dx_{k+1} \frac{\mathbf{1}(|x_j - x_{k+1}| \leq \alpha_2)}{|x_j - x_{k+1}|^2} \\
& \quad \times \left( |\nabla_j J^{(k)}(\mathbf{x}_k; \mathbf{x}'_k)| |f(\mathbf{x}_k, x_{k+1})| |f(\mathbf{x}'_k, x_{k+1})| + |J^{(k)}(\mathbf{x}_k; \mathbf{x}'_k)| |\nabla_j f(\mathbf{x}_k, x_{k+1})| |f(\mathbf{x}'_k, x_{k+1})| \right) \\
& \leq C \int d\mathbf{x}_k d\mathbf{x}'_k dx_{k+1} \frac{\mathbf{1}(|x_j - x_{k+1}| \leq \alpha_2)}{|x_j - x_{k+1}|^2} |\nabla_j J^{(k)}(\mathbf{x}_k; \mathbf{x}'_k)| (\kappa |f(\mathbf{x}_k, x_{k+1})|^2 + \kappa^{-1} |f(\mathbf{x}'_k, x_{k+1})|^2) \\
& \quad + C \int d\mathbf{x}_k d\mathbf{x}'_k dx_{k+1} \frac{\mathbf{1}(|x_j - x_{k+1}| \leq \alpha_2)}{|x_j - x_{k+1}|^2} |J^{(k)}(\mathbf{x}_k; \mathbf{x}'_k)| (\kappa |\nabla_j f(\mathbf{x}_k, x_{k+1})|^2 + \kappa^{-1} |f(\mathbf{x}'_k, x_{k+1})|^2).
\end{aligned} \tag{A.19}$$

In the terms proportional to  $\kappa$  we drop the restriction  $\mathbf{1}(|x_j - x_{k+1}| \leq \alpha_2)$  and we apply the Hardy's inequality to the  $x_{k+1}$ -integration. In the terms containing  $\kappa^{-1}$ , on the other hand, we perform the  $x_j$  integration (after estimating  $|J^{(k)}|$  and  $|\nabla_j J^{(k)}|$  by their supremum). We get

$$\begin{aligned}
& \left| \int d\mathbf{x}_{k+1} d\mathbf{x}'_{k+1} J^{(k)}(\mathbf{x}_k; \mathbf{x}'_k) \delta(x'_{k+1} - x_{k+1}) (\delta_{\alpha_2}(x_j - x_{k+1}) - \delta(x_j - x_{k+1})) f(\mathbf{x}_{k+1}) \bar{f}(\mathbf{x}'_{k+1}) \right| \\
& \leq C\kappa \left( \sup_{\mathbf{x}_k} \int d\mathbf{x}'_k (|J^{(k)}(\mathbf{x}_k; \mathbf{x}'_k)| + |\nabla_j J^{(k)}(\mathbf{x}_k; \mathbf{x}'_k)|) \right) \int d\mathbf{x}_{k+1} |(1 - \Delta_{k+1})^{1/2} (1 - \Delta_j)^{1/2} f(\mathbf{x}_{k+1})|^2 \\
& \quad + C\kappa^{-1} \alpha_2 \left( \sup_{\mathbf{x}'_k, x_j} \int dx_1 \dots dx_{j-1} dx_{j+1} \dots dx_k (|J^{(k)}(\mathbf{x}_k; \mathbf{x}'_k)| + |\nabla_j J^{(k)}(\mathbf{x}_k; \mathbf{x}'_k)|) \right) \\
& \quad \times \int d\mathbf{x}'_k dx_{k+1} |f(\mathbf{x}'_k, x_{k+1})|^2 \\
& \leq C^k (\kappa + \alpha_2 \kappa^{-1}) \|J^{(k)}\|_j \text{Tr} (1 - \Delta_j) (1 - \Delta_{k+1}) \gamma^{(k+1)}.
\end{aligned}$$

Choosing  $\kappa = \alpha_2^{1/2}$ , we find (8.8). □

## References

- [1] R. Adami, C. Bardos, F. Golse and A. Teta: *Towards a rigorous derivation of the cubic nonlinear Schrödinger equation in dimension one*. Asymptot. Anal. **40** (2) (2004), 93–108.
- [2] R. Adami, F. Golse and A. Teta: *Rigorous derivation of the cubic NLS in dimension one*. Preprint: mp-arc 05-211.
- [3] C. Bardos, F. Golse and N. Mauser: *Weak coupling limit of the  $N$ -particle Schrödinger equation*. Methods Appl. Anal. **7** (2000), 275–293.
- [4] J. Bourgain: *Global solutions of nonlinear Schrödinger equations*. American Mathematical Society Colloquium Publications, 46. American Mathematical Society, Providence, RI, 1999.
- [5] T. Cazenave: *Semilinear Schrödinger equations*. Courant Lecture Notes in Mathematics, 10. American Mathematical Society, Providence, RI, 2003.

- [6] E.B. Davies: *The functional calculus*. J. London Math. Soc. (2) **52** (1) (1995), 166–176.
- [7] A. Elgart, L. Erdős, B. Schlein, and H.-T. Yau: *Gross-Pitaevskii Equation as the Mean Filed Limit of weakly coupled bosons*. To appear in Arch. Rat. Mech. Anal. Preprint arXiv:math-ph/0410038.
- [8] A. Elgart, B. Schlein : *Mean Field Dynamics of Boson Stars*. Preprint arXiv:math-ph/0504051. To appear in Commun. Pure Appl. Math.
- [9] L. Erdős, B. Schlein and H.-T. Yau: *Derivation of the Gross-Pitaevskii Equation for the Dynamics of Bose-Einstein Condensate*. Preprint arXiv:math-ph/0410005.
- [10] L. Erdős and H.-T. Yau: *Linear Boltzmann equation as the weak coupling limit of the random Schrödinger equation*. Commun. Pure Appl. Math. LIII (2000), 667–735.
- [11] L. Erdős and H.-T. Yau: *Derivation of the nonlinear Schrödinger equation from a many body Coulomb system*. Adv. Theor. Math. Phys. **5** (6) (2001), 1169–1205.
- [12] J. Fröhlich, E. Lenzmann: *Mean-field limit of quantum Bose gases and nonlinear Hartree equation*. Séminaire Équations aux Dérivées Partielles. 2003–2004, Exp. No. XIX, École Polytech., Palaiseau, 2004.
- [13] D. Gilbarg, N.S. Trudinger: *Elliptic Partial Differential Equations of Second Order*. Springer 1977.
- [14] J. Ginibre and G. Velo: *The classical field limit of scattering theory for non-relativistic many-boson systems. I and II*. Commun. Math. Phys. **66**, 37–76 (1979) and **68**, 45-68 (1979).
- [15] K. Hepp: *The classical limit for quantum mechanical correlation functions*. Commun. Math. Phys. **35**, 265–277 (1974).
- [16] E.H. Lieb, R. Seiringer: *Proof of Bose-Einstein condensation for dilute trapped gases*. Phys. Rev. Lett. **88**, 170409 (2002)
- [17] E.H. Lieb, R. Seiringer, J.-P. Solovej, J. Yngvason: *The Mathematics of the Bose Gas and its Condensation*. Oberwolfach Seminars, Birkhäuser 2005.
- [18] E.H. Lieb, J. Yngvason: *The Ground State Energy of a Dilute Bose Gas*. Differential Equations and Mathematical Physics, University of Alabama, Birmingham (1999), R. Weikard and G. Weinstein, eds., 271–282 Amer. Math. Soc./Internat. Press (2000).
- [19] M. Reed and B. Simon: *Methods of mathematical physics. Vol. I*. Academic Press, 1975.
- [20] W. Rudin: *Functional analysis*. McGraw-Hill Series in Higher Mathematics, McGraw-Hill Book Co., New York, 1973.
- [21] M. Salmhofer: *Renormalization. An introduction*. Text and monograph in physics. Springer, Berlin, 1999.
- [22] H. Spohn: *Kinetic Equations from Hamiltonian Dynamics*. Rev. Mod. Phys. **52** (3) (1980), 569–615.
- [23] L. Spruch, L. Rosenberg: *Upper bounds on scattering lengths for static potentials*. Phys. Rev. **116** (4) (1959), 1034–1040.

- [24] T. Tao: *Local and global analysis of nonlinear dispersive and wave equations*.  
<http://www.math.ucla.edu/~tao/preprints/books.html>