

# Hyperbolic Kac–Moody superalgebras

L. Frappat<sup>a</sup> and A. Sciarrino<sup>b</sup>

<sup>a</sup> *Laboratoire d’Annecy-le-Vieux de Physique Théorique LAPTH  
CNRS, UMR 5108, associée à l’Université de Savoie  
BP 110, F-74941 Annecy-le-Vieux Cedex, France  
Member of Institut Universitaire de France*

<sup>b</sup> *Dipartimento di Scienze Fisiche, Università di Napoli “Federico II”  
and I.N.F.N., Sezione di Napoli  
Complesso Universitario di Monte S. Angelo, Via Cintia, I-80126 Napoli, Italy*

## Abstract

We present a classification of the hyperbolic Kac–Moody (HKM) superalgebras. The HKM superalgebras of rank  $r \geq 3$  are finite in number (213) and limited in rank (6). The Dynkin–Kac diagrams and the corresponding simple root systems are determined. We also discuss a class of singular sub(super)algebras obtained by a folding procedure.

MSC number: 17B65, 17B67

LAPTH-1068/04  
DSF-TH-28/04  
math-ph/0409041  
September 2004

# 1 Introduction

Affine Kac–Moody are presently well established tools of theoretical physics. The indefinite Kac–Moody (KM) algebras [1] form a so general set of algebras that they defy any general classification. A subclass of these KM algebras, called hyperbolic, which are defined by the property that the diagrams (generally disconnected) obtained taking away a dot from their defining diagrams define a direct sum of finite and/or affine KM algebras have been classified in [2, 3]. It has been found that these algebras are finite in number (238 in which 142 have a symmetric or symmetrizable Cartan matrix) and bounded in rank (10). These algebras have in the last decade attracted the attention of physicists, as they appear in a variety of physical models in two-dimensional field theories (supergravity, string theory, cosmological billiards) [4, 5, 6, 7]. Therefore it seems natural to study the corresponding partners in the realm of Kac–Moody superalgebras [8, 9, 10]. From these motivations, the authors of Ref. [11] have recently classified hyperbolic Kac–Moody (HKM) superalgebras by a procedure quite close to that followed to classify the hyperbolic Kac–Moody ones, showing that they are limited in rank, now the maximum rank being 6, and that they are finite in number (for rank  $> 2$ ). However, as we remarked that many diagrams are missing, while some of the proposed Dynkin–Kac diagrams correspond in fact to diagrams of untwisted or twisted affine Lie superalgebras (sometimes in the not distinguished basis), we present here a, hopefully exhaustive, classification of HKM superalgebras, together with a corresponding simple roots basis and we discuss a class of singular subalgebras.

The article is organized as follows: in section 2 we recall the definition of a superalgebra, the relation between Dynkin–Kac diagrams and generalized Cartan matrices, the action of the (super)Weyl or generalized Weyl transformations on the simple roots systems and the structure of the supplementary or non Serre relations. Although most of the material is not new, we believe it is worthwhile to report it in some details for several reasons: (i) the standard rules of translating matrices in diagrams have to be slightly and suitably defined to include the case of indefinite, in particular hyperbolic, KM superalgebras; (ii) the deformation of the Dynkin–Kac diagrams has to be carefully handled, otherwise one is lead to naively include diagrams for HKM superalgebras, which really correspond to more general indefinite KM superalgebras; (iii) the action of the generalized Weyl transformations, which provides also in the case of HKM superalgebras all the not equivalent simple roots systems, allows one not to be worried about the appearance of new non Serre relations. In section 3 and the related appendices we present the diagrams corresponding to HKM superalgebras, together with their (not unique) system of simple roots and with their maximal regular subalgebras; in section 4 we list the singular subalgebras, obtained by the procedure of folding.

## 2 Kac–Moody superalgebras

### 2.1 Generalized Cartan matrices and Dynkin diagrams

Let  $A$  be a  $r \times r$  matrix and  $\{i_1, \dots, i_p\}$  be a subset of indices of  $I = \{1, \dots, r\}$ . The principal  $\{i_1, \dots, i_p\}$ -submatrix of  $A$ , of order  $r - p$ , is a matrix obtained from  $A$  by deleting the rows and columns labelled by  $i_1, \dots, i_p$ . A principal submatrix of order  $r - 1$  is called leading.

We start by defining the notion of generalized Cartan matrix. In the case of  $\mathbb{Z}_2$ -graded algebras, it is convenient to deal with a recursive definition.

**Definition 2.1** *A  $r \times r$  matrix  $A$  with integral entries  $a_{ij}$  is called a generalized Cartan matrix if for each  $i \in \{1, \dots, r\}$ , the leading principal  $\{i\}$ -submatrix of  $A$  is a generalized Cartan matrix (which may be of block diagonal form).*

The Cartan matrices of the simple Lie algebras –  $A_n$ ,  $B_n$ ,  $C_n$ ,  $D_n$ ,  $E_{6,7,8}$ ,  $F_4$  and  $G_2$  – and of the basic Lie superalgebras –  $A(m, n)$ ,  $B(m, n)$ ,  $C(n + 1)$ ,  $D(m, n)$ ,  $F(4)$ ,  $G(3)$  and  $D(2, 1, \alpha)$  – are generalized Cartan matrices.

The matrix  $A$  is called symmetrizable if it exists an invertible diagonal matrix  $D$  such that  $DA$  is a symmetric matrix. The matrix  $A$  is called indecomposable if it cannot be reduced to a block diagonal form by reordering rows and columns.

We will only consider generalized Cartan matrices which are indecomposable and symmetrizable. Moreover, we assume that the generalized Cartan matrices are properly normalized, i.e.  $a_{ii} = 2$  or  $a_{ii} = 0$  for each  $i$ . If one defines the matrix  $D_{ij} = d_i \delta_{ij}$  where the rational coefficients  $d_i$  satisfy  $d_i a_{ij} = d_j a_{ji}$ , the symmetric Cartan matrix  $A'$  is given from the generalized Cartan matrix  $A$  by  $A' = DA$ . Note that, due to fact that off-diagonal entries of a row of a Cartan matrix corresponding to  $a_{ii} = 0$  may have different signs, the diagonal entries of the symmetric Cartan matrices are not necessarily positive.

**Remark 2.1** It follows from the definition that the Cartan matrices of the affine (untwisted or twisted) Kac–Moody algebras and superalgebras are generalized Cartan matrices.

**Definition 2.2** Let  $\tau$  be a subset of  $I = \{1, \dots, r\}$ . To a given generalized Cartan matrix  $A$  and subset  $\tau$ , we associate a complex contragredient Lie superalgebra  $\mathcal{G}(A, \tau)$  – called Kac–Moody superalgebra – with  $3r$  generators  $h_i$ ,  $e_i^\pm$  and  $\mathbb{Z}_2$ -gradation defined by  $\deg e_i^\pm = \bar{0}$  if  $i \notin \tau$ ,  $\deg e_i^\pm = \bar{1}$  if  $i \in \tau$  and  $\deg h_i = \bar{0}$  for all  $i$ . The generators  $h_i$  and  $e_i^\pm$  are subject the following set of relations:

$$[h_i, h_j] = 0 \tag{2.1}$$

$$[h_i, e_j^\pm] = \pm a_{ij} e_j^\pm \tag{2.2}$$

$$[e_i^+, e_j^-] = \delta_{ij} h_i \tag{2.3}$$

$$[[e_i^\pm, e_i^\pm]] = 0 \quad \text{if } a_{ii} = 0 \tag{2.4}$$

and

$$(\text{ad } e_i^\pm)^{1-\tilde{a}_{ij}} e_j^\pm = 0 \tag{2.5}$$

where the matrix  $\tilde{A} = (\tilde{a}_{ij})$  is deduced from the Cartan matrix  $A = (a_{ij})$  of  $\mathcal{G}(A, \tau)$  by replacing all its positive off-diagonal entries by  $-1$ . Here  $\text{ad}$  denotes the adjoint action:

$$(\text{ad } X)Y = [[X, Y]] = XY - (-1)^{\deg X \cdot \deg Y} YX \tag{2.6}$$

We denote by  $\mathcal{G}_{\bar{0}}$  and  $\mathcal{G}_{\bar{1}}$  the even and odd parts of the Kac–Moody superalgebra  $\mathcal{G}(A, \tau)$ . Let  $\mathcal{H} \subset \mathcal{G}_{\bar{0}}$  be the subalgebra of  $\mathcal{G}$  generated by the  $h_i$  (Cartan subalgebra). The superalgebra  $\mathcal{G}(A, \tau)$  can be decomposed as  $\mathcal{G} = \bigoplus_{\alpha} \mathcal{G}_{\alpha}$  where  $\mathcal{G}_{\alpha} = \{x \in \mathcal{G} \mid [h, x] = \alpha(h)x, h \in \mathcal{H}\}$ . By definition, the root system of  $\mathcal{G}$  is the set  $\Delta = \{\alpha \in \mathcal{H}^* \mid \mathcal{G}_{\alpha} \neq 0\}$ . A root  $\alpha$  is called even (resp. odd) if  $\mathcal{G}_{\alpha} \cap \mathcal{G}_{\bar{0}} \neq \emptyset$  (resp.  $\mathcal{G}_{\alpha} \cap \mathcal{G}_{\bar{1}} \neq \emptyset$ ). The set of even (resp. odd) roots is denoted by  $\Delta_{\bar{0}}$  (resp.  $\Delta_{\bar{1}}$ ). Since  $\mathcal{G}(A, \tau)$  clearly admits a Borel decomposition, one defines as usual the notion of simple root system [8, 12].

To each superalgebra  $\mathcal{G}(A, \tau)$  can be associated a Dynkin diagram according to the following rules [12]. We will always assume that  $i \in \tau$  if  $a_{ii} = 0$ .

1. Using the generalized Cartan matrix  $A$ :

- (a) One associates to each  $i$  such that  $a_{ii} = 2$  and  $i \notin \tau$  a white dot, to each  $i$  such that  $a_{ii} = 2$  and  $i \in \tau$  a black dot, to each  $i$  such that  $a_{ii} = 0$  and  $i \in \tau$  a grey dot.

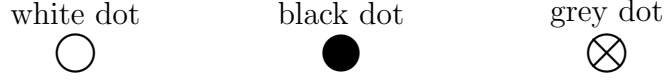

(b) The  $i$ -th and  $j$ -th dots will be joined by  $\eta_{ij}$  lines where

$$\eta_{ij} = \max(|a_{ij}|, |a_{ji}|) \quad \text{if } a_{ii} \neq 0 \text{ or/and } a_{jj} \neq 0 \text{ and } |a_{ij} a_{ji}| \leq 4$$

$$\eta_{ij} = |a_{ij}| = |a_{ji}| \quad \text{if } a_{ii} = a_{jj} = 0 \text{ and } |a_{ij}|, |a_{ji}| \leq 4$$

Otherwise, the  $i$ -th and  $j$ -th dots will be joined by a boldface line equipped with an ordered pair of integers  $(|a_{ij}|, |a_{ji}|)$ . Note that this latter case does not appear for finite or affine Kac–Moody superalgebras.

- (c) We add an arrow on the lines connecting the  $i$ -th and  $j$ -th dots when  $\eta_{ij} > 1$  and  $|a_{ij}| \neq |a_{ji}|$ , pointing from  $j$  to  $i$  if  $|a_{ij}| > 1$ .
- (d) For  $D(2, 1; \alpha)$ ,  $\eta_{ij} = 1$  if  $a_{ij} \neq 0$  and  $\eta_{ij} = 0$  if  $a_{ij} = 0$ . No arrow is put on the Dynkin diagram.

2. Using the symmetric Cartan matrix  $A'$ :

- (a) One associates to each  $i$  such that  $a'_{ii} \neq 0$  and  $i \notin \tau$  a white dot, to each  $i$  such that  $a'_{ii} \neq 0$  and  $i \in \tau$  a black dot, to each  $i$  such that  $a'_{ii} = 0$  and  $i \in \tau$  a grey dot (see pictures above).
- (b) The  $i$ -th and  $j$ -th dots will be joined by  $\eta_{ij}$  lines where

$$\eta_{ij} = \frac{2|a'_{ij}|}{\min(|a'_{ii}|, |a'_{jj}|)} \quad \text{if } a'_{ii} \cdot a'_{jj} \neq 0 \text{ and } a'_{ij}{}^2 \leq |a'_{ii} \cdot a'_{jj}|$$

$$\eta_{ij} = \frac{2|a'_{ij}|}{\min(|a'_{ii}|, 2)} \quad \text{if } a'_{ii} \neq 0, a'_{jj} = 0 \text{ and } \eta_{ij} \leq 4$$

$$\eta_{ij} = |a'_{ij}| \quad \text{if } a'_{ii} = a'_{jj} = 0 \text{ and } |a'_{ij}| \leq 4$$

Otherwise, the  $i$ -th and  $j$ -th dots will be joined by a boldface line equipped with an ordered pair of integers  $(|a_{ij}|, |a_{ji}|)$ .

- (c) We add an arrow on the lines connecting the  $i$ -th and  $j$ -th dots when  $\eta_{ij} > 1$ , pointing from  $i$  to  $j$  if  $a'_{ii} \cdot a'_{jj} \neq 0$  and  $|a'_{ii}| > |a'_{jj}|$  or if  $a'_{ii} = 0, a'_{jj} \neq 0, |a'_{jj}| < 2$ , and pointing from  $j$  to  $i$  if  $a'_{ii} = 0, a'_{jj} \neq 0, |a'_{jj}| > 2$ .
- (d) For  $D(2, 1; \alpha)$ ,  $\eta_{ij} = 1$  if  $a'_{ij} \neq 0$  and  $\eta_{ij} = 0$  if  $a'_{ij} = 0$ . No arrow is put on the Dynkin diagram.

Although the rules seem more complicated when using the symmetric Cartan matrix  $A'$ , the computation of the Cartan matrix  $A$  is often more involved than the symmetric Cartan matrix  $A'$ .

**Remark 2.2** The entries of the symmetric Cartan matrices  $A'$  can be obtained as the scalar products of the simple roots, i.e.  $a'_{ij} = (\alpha_i, \alpha_j)$  (up to a multiplication by a suitable factor in order to get integer entries).

**Remark 2.3** The above rules imply that two white/black dots of square length  $L$  and scalar product  $S$  are connected by  $|2S/L|$  lines. With this convention, the Dynkin diagram of the affine Kac–Moody algebra  $A_1^{(1)}$  is simply given by two white dots connected by two lines without any arrow.

Note that for superalgebras Dynkin–Kac diagrams with the same "topology" may be different. For example the diagrams drawn below represent respectively the superalgebras  $sl(2|2)$ ,  $osp(4|2)$ ,  $osp(4|4)$  and a hyperbolic Kac–Moody superalgebra of rank four (see definition 3.1). The root systems are described in terms of the orthogonal vectors  $\varepsilon_i$ ,  $\delta_i$  and  $K^\pm$  (see Appendix B for conventions).

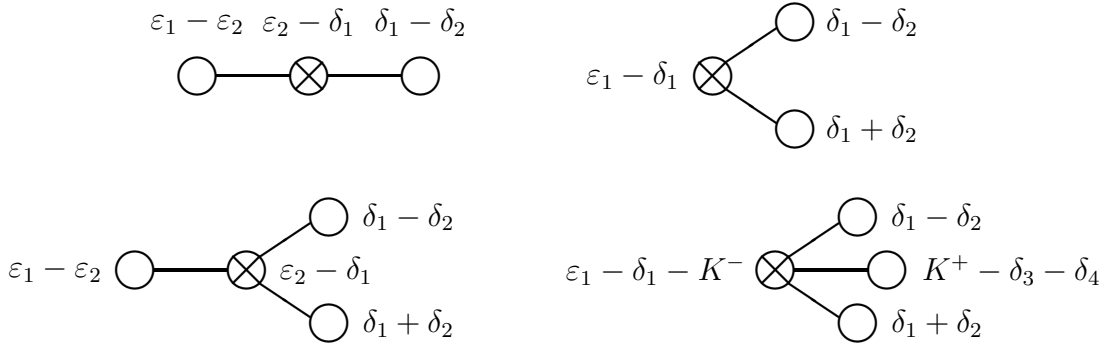

## 2.2 Non Serre type relations and generalized Weyl transformations

In the case of finite and affine Kac–Moody superalgebras, it is known that the description given by the Serre relations (2.1) to (2.4) may lead to superalgebras with non trivial ideals [13, 14]. In order to obtain a simple superalgebra, it is necessary to write supplementary relations involving more than two generators, in order to quotient the bigger superalgebra. These supplementary non Serre type conditions appear when one deals with isotropic odd roots (that is  $a_{ii} = 0$ ).

The supplementary conditions depend on the different kinds of vertices which appear in the Dynkin diagrams. The vertices for finite and affine superalgebras can be of the following type:

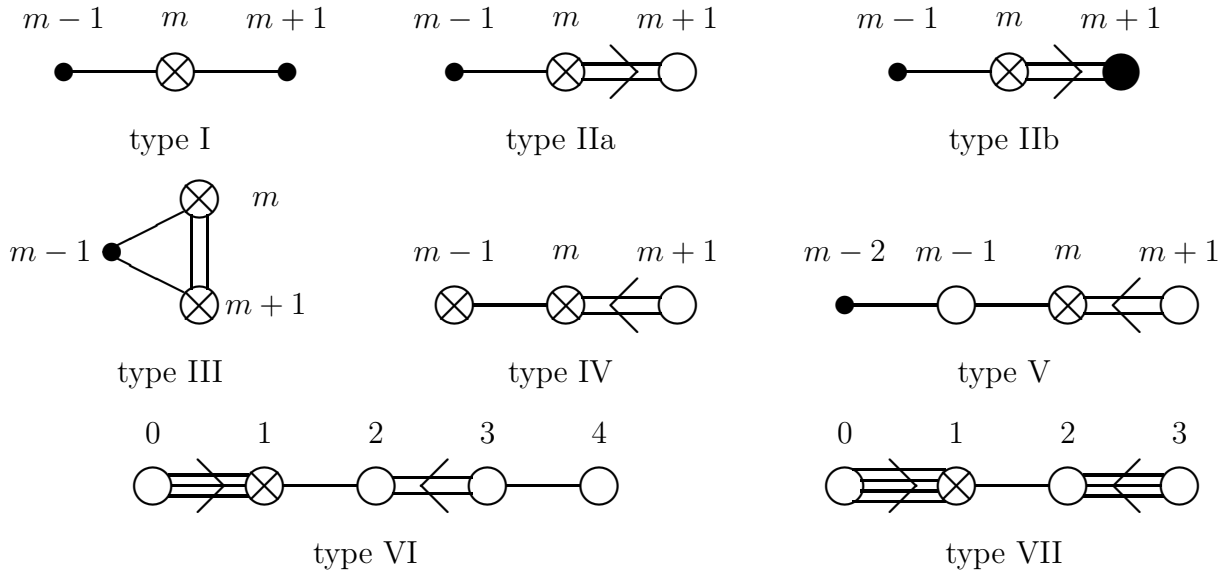

where the small black dots represent either white dots associated to even roots or grey dots associated to isotropic odd roots. Hyperbolic superalgebras exhibit also more complicated vertices.

The supplementary conditions take the following form [13, 14, 15]:

- type I, IIa and IIb vertices:  $[[e_m^\pm, [e_{m+1}^\pm, [e_m^\pm, e_{m-1}^\pm]]]] = 0$
- type III vertex:  $[[e_m^\pm, [e_{m+1}^\pm, e_{m-1}^\pm]]] - [[e_{m+1}^\pm, [e_m^\pm, e_{m-1}^\pm]]] = 0$
- type IV vertex:  $[[e_m^\pm, [[e_{m+1}^\pm, [e_m^\pm, e_{m-1}^\pm]], [e_m^\pm, e_{m-1}^\pm]]]] = 0$
- type V vertex:  $[[e_m^\pm, [e_{m-1}^\pm, [e_m^\pm, [e_{m+1}^\pm, [e_m^\pm, [e_{m-1}^\pm, e_{m-2}^\pm]]]]]]]] = 0$
- type VI vertex:  $[[e_2^\pm, [e_1^\pm, [e_3^\pm, [e_2^\pm, [e_1^\pm, e_0^\pm]]]]]] - 2 [[e_1^\pm, [e_2^\pm, [e_3^\pm, [e_2^\pm, [e_1^\pm, e_0^\pm]]]]]] = 0$
- type VII vertex:  $2 [[e_2^\pm, [e_1^\pm, [e_3^\pm, [e_2^\pm, [e_1^\pm, e_0^\pm]]]]]] - 3 [[e_1^\pm, [e_2^\pm, [e_3^\pm, [e_2^\pm, [e_1^\pm, e_0^\pm]]]]]] = 0$

For Kac–Moody superalgebras, there are in general many inequivalent simple root systems (when they contain isotropic odd roots), up to a transformation of the Weyl group  $W(\mathcal{G})$  of  $\mathcal{G}$ . Following [16], the Weyl group  $W(\mathcal{G})$  is extended by adding the following transformations (called generalized Weyl transformations) associated to the isotropic odd roots of  $\mathcal{G}$ . For  $\alpha \in \Delta_{\bar{1}}$ , one defines:

$$\begin{aligned}
w_\alpha(\beta) &= \beta - 2 \frac{(\alpha, \beta)}{(\alpha, \alpha)} \alpha && \text{if } (\alpha, \alpha) \neq 0 \\
w_\alpha(\beta) &= \beta + \alpha && \text{if } (\alpha, \alpha) = 0 \text{ and } (\alpha, \beta) \neq 0 \\
w_\alpha(\beta) &= \beta && \text{if } (\alpha, \alpha) = 0 \text{ and } (\alpha, \beta) = 0 \\
w_\alpha(\alpha) &= -\alpha
\end{aligned} \tag{2.7}$$

The transformation associated to an isotropic odd root  $\alpha$  cannot be lifted to an automorphism of the superalgebra since  $w_\alpha$  transforms even roots into odd ones, and vice versa, and the  $\mathbb{Z}_2$ -gradation would not be respected.

Let  $\Delta^0$  be a simple root system of  $\mathcal{G}$  and  $\alpha$  an isotropic odd root. Then one has for any root  $\gamma \neq n_\alpha \alpha$ :

$$\gamma = \sum_{\substack{\beta \neq \alpha \in \Delta^0 \\ a_{\alpha\beta} \neq 0}} n_\beta \beta + \sum_{\substack{\beta \neq \alpha \in \Delta^0 \\ a_{\alpha\beta} = 0}} n_\beta \beta + n_\alpha \alpha = \sum_{\beta \neq \alpha \in \Delta^0} n_\beta w_\alpha(\beta) + s_\gamma w_\alpha(\alpha) \tag{2.8}$$

where the coefficients  $n_\alpha, n_\beta \in \mathbb{Z}_{\geq 0}$  and  $s_\gamma$  is given by

$$s_\gamma = \sum_{\substack{\beta \neq \alpha \in \Delta^0 \\ a_{\alpha\beta} \neq 0}} n_\beta - n_\alpha \tag{2.9}$$

Then, by induction on the height of the root  $\gamma$ , one can prove that  $s_\gamma$  is a non negative number, which shows that the transformed simple root system  $w_\alpha(\Delta^0)$  is again a simple root system [16]. The generalization of the Weyl group gives a method for constructing all the simple root systems of  $\mathcal{G}$  and hence all the inequivalent Dynkin diagrams. A simple root system  $\Delta^0$  being given, from any isotropic odd root  $\alpha \in \Delta^0$ , one constructs the simple root system  $w_\alpha(\Delta^0)$  where  $w_\alpha$  is the generalized

Weyl reflection with respect to  $\alpha$  and one repeats the procedure on the obtained system until no new basis arises.

Note that this procedure is in fact very general and apply for any Kac–Moody superalgebra whose simple root systems contain isotropic odd roots. However, for Kac–Moody superalgebras which are neither of finite type nor of affine one, one may obtain in certain cases simple root systems containing even or odd root(s) of very large negative length. We will comment this point in the next section in the peculiar case of hyperbolic KM superalgebras.

### 3 Hyperbolic Kac–Moody superalgebras

#### 3.1 Definition

Let  $\mathcal{G}(A, \tau)$  be a Kac–Moody superalgebra with generalized Cartan matrix  $A$  and  $\mathbb{Z}_2$ -gradation  $\tau$ . By convention, it will be called indefinite Kac–Moody superalgebra if it is neither of finite nor of affine type. Of course, when the  $\mathbb{Z}_2$ -gradation  $\tau$  is trivial, one recovers the usual classification of the Kac–Moody algebras.

**Definition 3.1** *Let  $\mathcal{G}(A, \tau)$  be an indefinite Kac–Moody superalgebra with generalized Cartan matrix  $A$  and non trivial  $\mathbb{Z}_2$ -gradation  $\tau$  corresponding to a connected Dynkin–Kac diagram.  $\mathcal{G}(A, \tau)$  is called a hyperbolic Kac–Moody (HKM) superalgebra if every leading principal submatrix of  $A$  decomposes into constituents of finite or affine type, or equivalently, if deleting a vertex of the Dynkin diagram, one gets Dynkin diagrams of finite or affine type.*

The hyperbolic superalgebras are divided into the following classes:

1. strictly hyperbolic if every leading principal submatrix of  $A$  decomposes into constituents of finite type,
2. purely hyperbolic if every leading principal submatrix of  $A$  decomposes into constituents of affine type,
3. hyperfinite if at least one leading principal submatrix of  $A$  decomposes into constituents of finite type,
4. hyperaffine if at least one leading principal submatrix of  $A$  decomposes into constituents of affine type.

**Theorem 3.2** *The hyperbolic Kac–Moody superalgebras of rank  $r \geq 3$  are finite in number (213) and limited in rank (6). They are listed in Appendix A.*

**Remark 3.1** As in the algebraic case, the HKM superalgebras are *not* of finite growth [17, 10]. Let us remind the notion of growth: let  $\mathcal{G}(A, \tau)$  be a Kac–Moody superalgebra and  $\mathcal{I} \subset \mathcal{G}$  a finite subset of  $\mathcal{G}$ . The growth of  $\mathcal{G}$  is by definition the number

$$r(\mathcal{G}) = \sup_{\mathcal{I}} \overline{\lim}_{n \rightarrow \infty} (\ln d(\mathcal{I}, n) / \ln n) \tag{3.1}$$

where  $\mathcal{I}$  runs over all finite subsets of  $\mathcal{G}$  and  $d(\mathcal{I}, n)$  is the dimension of the linear span of the commutators of length at most  $n$  of elements of  $\mathcal{I}$ . The superalgebra  $\mathcal{G}$  is of finite growth if  $r(\mathcal{G}) < \infty$ .

By applying the definition 3.1, one gets a Dynkin diagram for a given HKM superalgebra. The other Dynkin diagrams are obtained by means of generalized Weyl transformations. Generally, the transformed Dynkin diagrams do not satisfy the definition 3.1 (see example below). We conjecture that it always exists only one Dynkin diagram with the minimal number of odd roots satisfying definition 3.1. Such a Dynkin diagram will be called distinguished.

### 3.2 Example

As an illustration of the generalized Weyl transformations procedure, we give below the different inequivalent simple root systems with the corresponding Dynkin diagrams and symmetric Cartan matrices of a HKM superalgebra of rank 6. Let  $(\varepsilon_+ = K^+, \varepsilon_- = K^-, \varepsilon_1, \varepsilon_2, \varepsilon_3, \varepsilon_4, \varepsilon_5 = \delta)$  be a basis of  $\mathbb{R}^{(5,2)}$  with metric  $g_{ij} = (\varepsilon_i, \varepsilon_j)$  such that  $g_{+-} = g_{-+} = g_{11} = g_{22} = g_{33} = g_{44} = -g_{55} = 1$  and all other values are zero.

- Simple root system  $\Delta^0 = \{\alpha_1 = \delta - \varepsilon_1 - K^-, \alpha_2 = \varepsilon_1 - \varepsilon_2, \alpha_3 = \varepsilon_2 - \varepsilon_3, \alpha_4 = \varepsilon_3 - \varepsilon_4, \alpha_5 = \varepsilon_3 + \varepsilon_4, \alpha_6 = K^+ - \varepsilon_1 - \varepsilon_2\}$

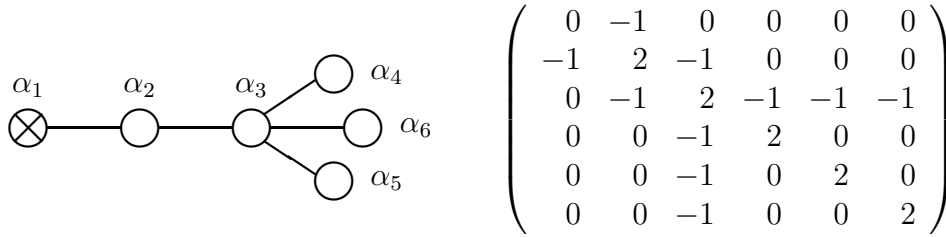

- Simple root system  $\Delta^0 = \{\alpha_1 = K^- - \delta + \varepsilon_1, \alpha_2 = \delta - \varepsilon_2 - K^-, \alpha_3 = \varepsilon_2 - \varepsilon_3, \alpha_4 = \varepsilon_3 - \varepsilon_4, \alpha_5 = \varepsilon_3 + \varepsilon_4, \alpha_6 = K^+ - \varepsilon_1 - \varepsilon_2\}$

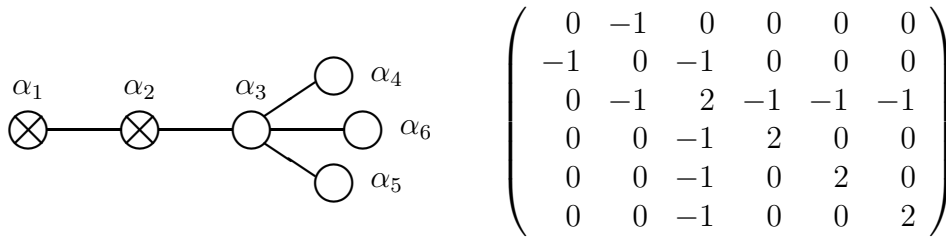

- Simple root system  $\Delta^0 = \{\alpha_1 = \varepsilon_1 - \varepsilon_2, \alpha_2 = K^- - \delta + \varepsilon_2, \alpha_3 = \delta - \varepsilon_3 - K^-, \alpha_4 = \varepsilon_3 - \varepsilon_4, \alpha_5 = \varepsilon_3 + \varepsilon_4, \alpha_6 = K^+ - \varepsilon_1 - \varepsilon_2\}$

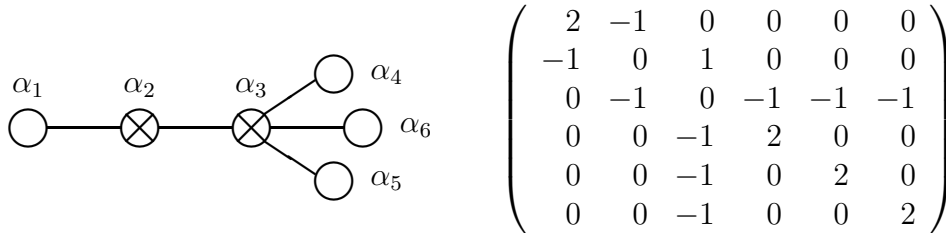

- Simple root system  $\Delta^0 = \{\alpha_1 = \varepsilon_1 - \varepsilon_2, \alpha_2 = \varepsilon_2 - \varepsilon_3, \alpha_3 = K^- - \delta + \varepsilon_3, \alpha_4 = \delta - \varepsilon_4 - K^-, \alpha_5 = \delta + \varepsilon_4 - K^-, \alpha_6 = K^+ - K^- + \delta - \varepsilon_1 - \varepsilon_2 - \varepsilon_3\}$

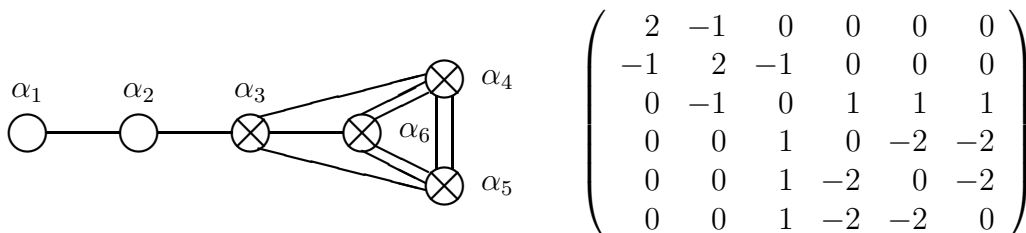



- Simple root system  $\Delta^0 = \{\alpha_1 = \varepsilon_1 - \varepsilon_2, \alpha_2 = \varepsilon_2 - \varepsilon_3, \alpha_3 = \varepsilon_3 - \varepsilon_4, \alpha_4 = K^- - \delta + \varepsilon_4, \alpha_5 = 2\delta - 2K^-, \alpha_6 = K^+ - 2K^- + 2\delta - \varepsilon_1 - \varepsilon_2 - \varepsilon_3 - \varepsilon_4\}$

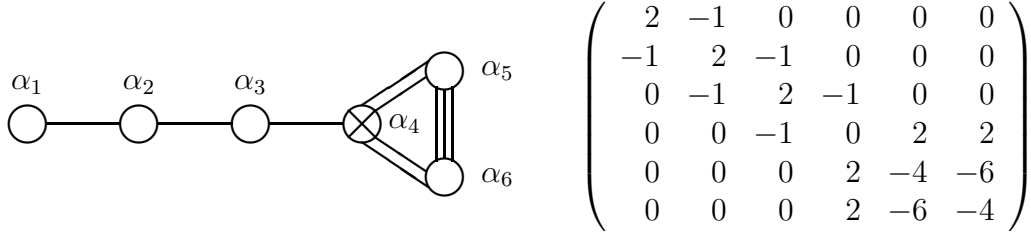

The explicit form of the non Serre type supplementary relations for HKM superalgebras is not known yet, at least for the vertices which are not of finite nor of affine type. However, another alternative way of describing the HKM superalgebras is to consider *all* inequivalent Dynkin diagrams and write the usual Serre relations (2.1)–(2.2) (of course this leads to redundant information). Indeed, the non Serre type relations become Serre relations after a generalized Weyl reflection with respect to an appropriate isotropic odd root [18].

Note nevertheless that in the case of HKM superalgebras, one may produce by generalized Weyl transformations some exotic simple root systems corresponding to Cartan matrices with non integer (rational) entries associated to weird non standard Dynkin diagrams (this was *not* the case in the above example). As in the usual case, one gets supplementary non Serre type relations, but now also associated to non isotropic even simple roots.

### 3.3 Rank two HKM superalgebras

Clearly any rank 2 HKM superalgebra is described by a Dynkin–Kac diagram of the form

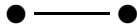

where the dot can be a white, black or grey dot. Both dots cannot be either white, as this diagram describes KM algebras, or grey, as this diagram is isomorphic to the diagram, in the non distinguished basis, of  $sl(1/2)$ . The Dynkin–Kac diagrams corresponding to rank 2 finite and affine KM superalgebras, up to generalized Weyl transformations, are listed below:

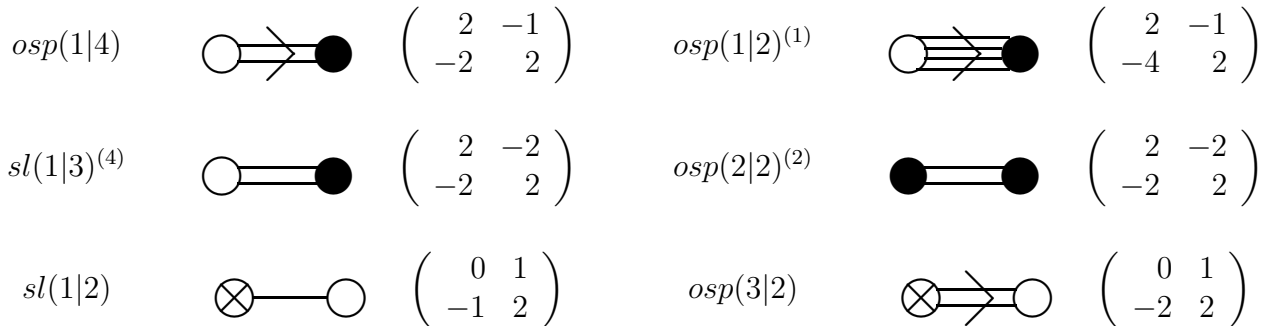

In [17, 10], it is proven that any superalgebra associated to a  $2 \times 2$  matrix not appearing in the above list is of *infinite growth*. It follows:

**Theorem 3.3** *The hyperbolic Kac–Moody superalgebras of rank two are infinite in number. Their generalized Cartan matrix and Dynkin diagram are, up to generalized Weyl transformations, reducible to one of the following list:*

- with  $\mathbb{Z}_2$ -gradation  $\tau = \{1\}$

$$\begin{pmatrix} 2 & -k \\ -k' & 2 \end{pmatrix} \quad \text{with } (k, k') = (1, k'), k' \leq 4, (k, k') = (3, 1) \text{ or } k, k' \in \mathbb{Z}_{>0}, kk' > 4$$

$$\begin{pmatrix} 0 & 1 \\ -k & 2 \end{pmatrix} \quad \text{with } k \in \mathbb{Z}_{>0}, k > 2$$

- with  $\mathbb{Z}_2$ -gradation  $\tau = \{1, 2\}$

$$\begin{pmatrix} 2 & -k \\ -k' & 2 \end{pmatrix} \quad \text{with } (k, k') = (1, k'), k' \leq 4 \text{ or } k, k' \in \mathbb{Z}_{>0}, kk' > 4$$

$$\begin{pmatrix} 0 & 1 \\ -k & 2 \end{pmatrix} \quad \text{with } k \in \mathbb{Z}_{>0}, k \neq 2$$

We denote them as  $BW(k, k')$ ,  $GW(k)$ ,  $BB(k, k')$  and  $GB(k)$ , with corresponding Dynkin diagrams:



Note that in order to write only one type of diagram, we have not strictly followed the rules given in section 2.

The simple root systems of the HKM superalgebras  $BW(k, k')$  and  $BB(k, k')$  are given by

$$\alpha = \sum_{i=1}^n k_i \varepsilon_i + k_\alpha K^+ \quad \text{and} \quad \alpha' = -\sum_{i=1}^{n'} k'_i \varepsilon_i - k'_\alpha K^- \quad (3.2)$$

where  $k_i, k'_i, k_\alpha, k'_\alpha \in \mathbb{Z}_{\geq 0}$  satisfy  $kk' = k_\alpha k'_\alpha + \sum_{i=1}^{\min(n, n')} k_i k'_i$ ,  $k^2 = \sum_{i=1}^n k_i^2$  and  $k'^2 = \sum_{i=1}^{n'} k'_i^2$ , while for the HKM superalgebras  $GW(k)$  and  $GB(k)$  the simple roots are  $\alpha = -k K^-$  and  $\alpha' = \varepsilon_1 - \varepsilon_2 + K^+$ .

## 4 Subalgebras of hyperbolic KM superalgebras

Let  $\mathcal{G}$  be a Kac–Moody superalgebra, and consider its canonical root decomposition

$$\mathcal{G} = \mathcal{H} \oplus \bigoplus_{\alpha \in \Delta} \mathcal{G}_\alpha$$

where  $\mathcal{H}$  is the Cartan subalgebra of  $\mathcal{G}$  and  $\Delta$  its corresponding root system.

A sub(super)algebra  $\mathcal{G}'$  of  $\mathcal{G}$  is called regular if  $\mathcal{G}'$  has the root decomposition

$$\mathcal{G}' = \mathcal{H}' \oplus \bigoplus_{\alpha' \in \Delta'} \mathcal{G}'_{\alpha'}$$

where  $\mathcal{H}' \subset \mathcal{H}$  and  $\Delta \subset \Delta'$ .

Consider a HKM superalgebra  $\mathcal{G}$ . Deleting a dot in the distinguished Dynkin diagram of  $\mathcal{G}$  leads to regular sub(super)algebras of  $\mathcal{G}$  of finite or affine type by definition. In Appendix C, we list these regular sub(super)algebras corresponding to the Dynkin diagrams of Appendix A. Note that in several cases, the diagram of the subsuperalgebra is not the distinguished one.

A sub(super)algebra  $\mathcal{G}'$  of  $\mathcal{G}$  is called singular if it is not regular. The folding method allows one to obtain some singular sub(super)algebras of the HKM superalgebras. Let  $\mathcal{G}$  be a HKM superalgebra with a distinguished Dynkin diagram exhibiting a  $\mathbb{Z}_N$  symmetry. This  $\mathbb{Z}_N$  symmetry is generated by an automorphism  $\tau$  of order  $N$  ( $\tau^N = 1$ ) acting on the root system. The automorphism  $\tau$  can be lifted at the algebra level by setting  $\tau(e_\alpha) = e_{\tau(\alpha)}$  for a generator  $e_\alpha$  associated to a simple root  $\alpha$ . The symmetry of the Dynkin diagram induces a direct construction of the sub(super)algebra  $\mathcal{G}'$  invariant under the  $\mathcal{G}$  automorphism associated to  $\tau$ . Indeed, if the simple root  $\alpha$  is transformed into  $\tau(\alpha)$ , then  $\alpha' = \alpha + \tau(\alpha) + \dots + \tau^{N-1}(\alpha)$  is  $\tau$ -invariant since  $\tau^N = 1$ , and appears as a simple root of  $\mathcal{G}'$  associated to the generator  $e_{\alpha'} = e_\alpha + e_{\tau(\alpha)} + \dots + e_{\tau^{N-1}(\alpha)}$ , where  $e_{\tau^k(\alpha)}$  is the generator corresponding to the root  $\tau^k(\alpha)$  ( $k = 0, \dots, N-1$ ). A Dynkin diagram of  $\mathcal{G}'$  will therefore be obtained by folding the  $\mathbb{Z}_N$ -symmetric Dynkin diagram of  $\mathcal{G}$ , that is by transforming each  $N$ -uple  $(\alpha, \tau(\alpha), \dots, \tau^{N-1}(\alpha))$  into the root  $\alpha' = \alpha + \tau(\alpha) + \dots + \tau^{N-1}(\alpha)$  of  $\mathcal{G}'$ . It is easy to convince oneself that for  $\mathcal{G}'$  the defining relations (2.1)–(2.5) of a HKM superalgebra hold (be aware that, in particular for the Serre relations (2.5), the entries of the Cartan matrix are now those of  $\mathcal{G}'$ ).

We present in Table 1 the list of HKM superalgebras  $\mathcal{G}$  to which the folding procedure can be applied and the corresponding singular subsuperalgebras  $\mathcal{G}'$ . Note that in general the obtained singular subsuperalgebras are also HKM superalgebras. However, in the case of the HKM superalgebra #6 of rank 6, one obtains for  $\mathcal{G}'$  the simple Lie superalgebra  $F(4)$  (note that for affine Lie (super)algebras the folding procedure always leads to (super)algebras of affine type). This is due to the fact that for HKM superalgebras the root system contains *two* isotropic roots whose scalar product is not trivial.

**Remark 4.1** The folding procedure cannot be applied to the rank four HKM superalgebras labelled by the numbers #59 to #62, despite the apparent  $\mathbb{Z}_2$ -symmetry of the distinguished Dynkin diagram, as the  $\mathbb{Z}_2$ -grading of the invariant generators would not be respected.

Table 1: Folding of the HKM superalgebras

| rank of $\mathcal{G}$ | $\mathcal{G}$ label | order of $\tau$ | rank of $\mathcal{G}'$ | $\mathcal{G}'$ label |
|-----------------------|---------------------|-----------------|------------------------|----------------------|
| 3                     | #24                 | 2               | 2                      | $BW(4, 2)$           |
| 3                     | #25                 | 2               | 2                      | $BW(2, 4)$           |
| 3                     | #27                 | 2               | 2                      | $BB(2, 4)$           |
| 3                     | #28                 | 2               | 2                      | $BB(4, 2)$           |
| 3                     | #31                 | 2               | 2                      | $BW(8, 1)$           |
| 4                     | #33                 | 2               | 4                      | #37                  |
| 4                     | #34                 | 2               | 4                      | #39                  |
| 4                     | #40                 | 2               | 3                      | #57                  |
| 4                     | #41                 | 2               | 3                      | #5                   |
| 4                     | #42                 | 2               | 3                      | #21                  |
| 4                     | #44                 | 2               | 3                      | #26                  |
| 4                     | #45                 | 2               | 3                      | #15                  |
| 4                     | #46                 | 2               | 3                      | #13                  |
| 4                     | #47                 | 2               | 3                      | #14                  |
| 4                     | #48                 | 2               | 3                      | #34                  |
| 4                     | #55                 | 2               | 3                      | #52                  |
| 4                     | #56                 | 2               | 3                      | #54                  |
| 4                     | #57                 | 2               | 3                      | #53                  |
| 4                     | #58                 | 2               | 3                      | #47                  |

Table 1: Folding of the HKM superalgebras (cont'd)

| rank of $\mathcal{G}$ | $\mathcal{G}$ label | order of $\tau$ | rank of $\mathcal{G}'$ | $\mathcal{G}'$ label |
|-----------------------|---------------------|-----------------|------------------------|----------------------|
| 4                     | #63                 | 2               | 3                      | #37                  |
| 4                     | #64                 | 2               | 3                      | #5                   |
| 4                     | #65                 | 2               | 3                      | #1                   |
| 4                     | #66                 | 2               | 3                      | #9                   |
| 4                     | #67                 | 2               | 3                      | #6                   |
| 4                     | #68                 | 2               | 3                      | #24                  |
| 4                     | #68                 | 2               | 4                      | #28                  |
| 4                     | #69                 | 2               | 4                      | #7                   |
| 4                     | #70                 | 2               | 4                      | #42                  |
| 4                     | #71                 | 2               | 4                      | #51                  |
| 4                     | #72                 | 2               | 4                      | #50                  |
| 4                     | #73                 | 2               | 4                      | #58                  |
| 5                     | #28                 | 2               | 4                      | #14                  |
| 5                     | #30                 | 2               | 4                      | #8                   |
| 5                     | #31                 | 2               | 4                      | #9                   |
| 5                     | #32                 | 2               | 4                      | #11                  |
| 5                     | #33                 | 2               | 4                      | #5                   |
| 5                     | #34                 | 2               | 4                      | #7                   |
| 5                     | #35                 | 3               | 3                      | #2                   |
| 5                     | #36                 | 2               | 4                      | #1                   |
| 5                     | #37                 | 2               | 4                      | #13                  |
| 5                     | #38                 | 3               | 3                      | #36                  |
| 6                     | #6                  | 2               | 4                      | F(4)                 |
| 6                     | #12                 | 2               | 4                      | #1                   |
| 6                     | #14                 | 3               | 4                      | #21                  |
| 6                     | #15                 | 3               | 4                      | #26                  |

# A. Dynkin diagrams of the hyperbolic superalgebras

Rank 3 hyperbolic superalgebras (87 diagrams)

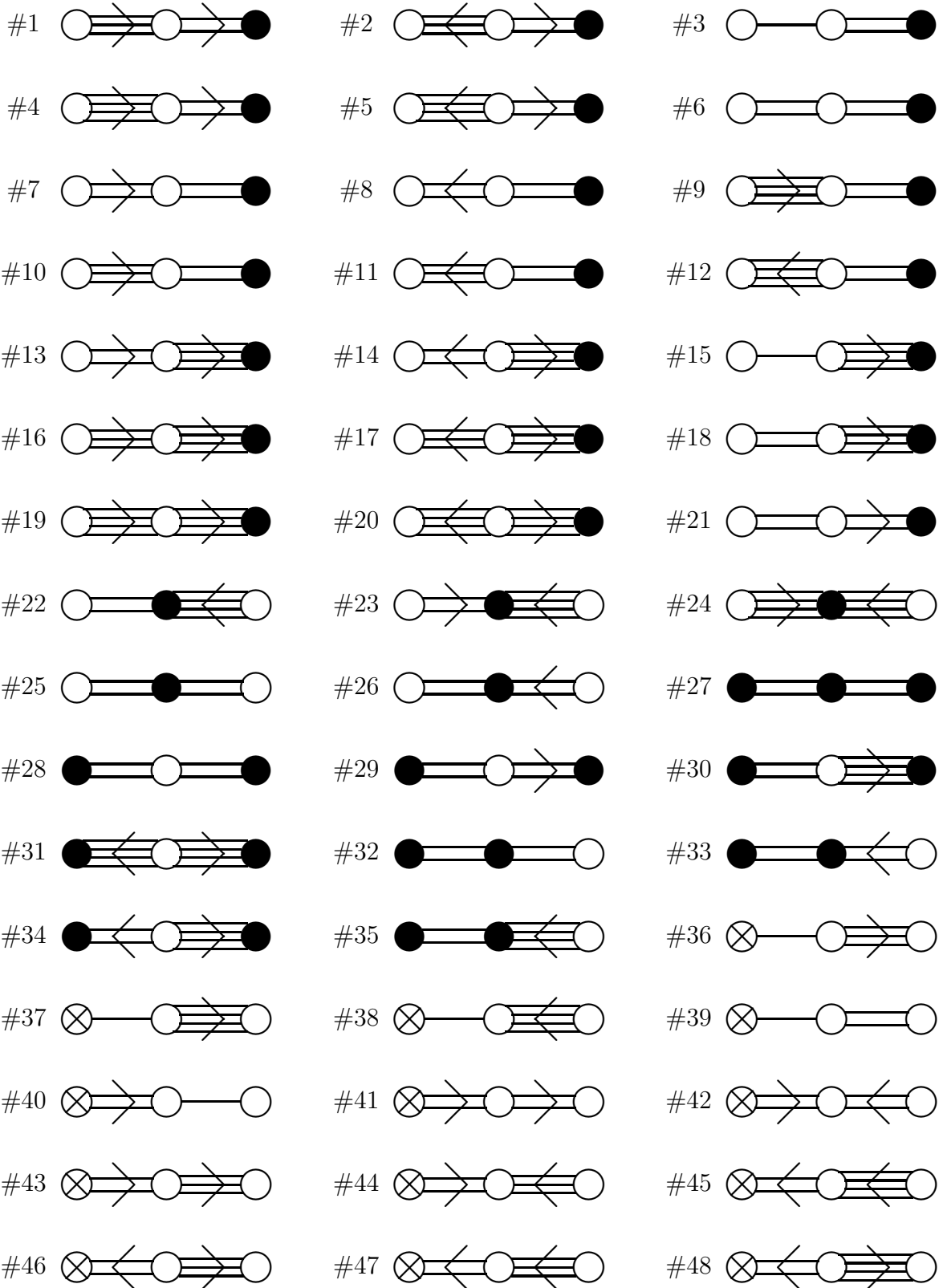

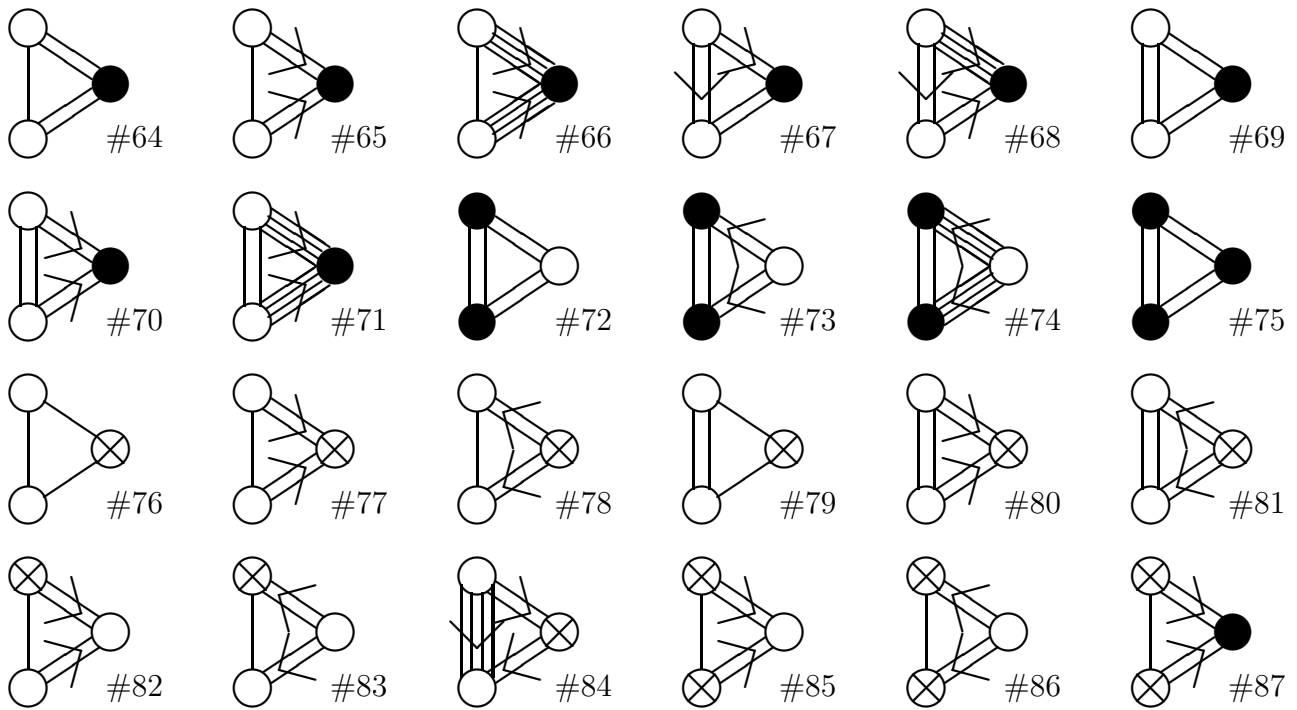
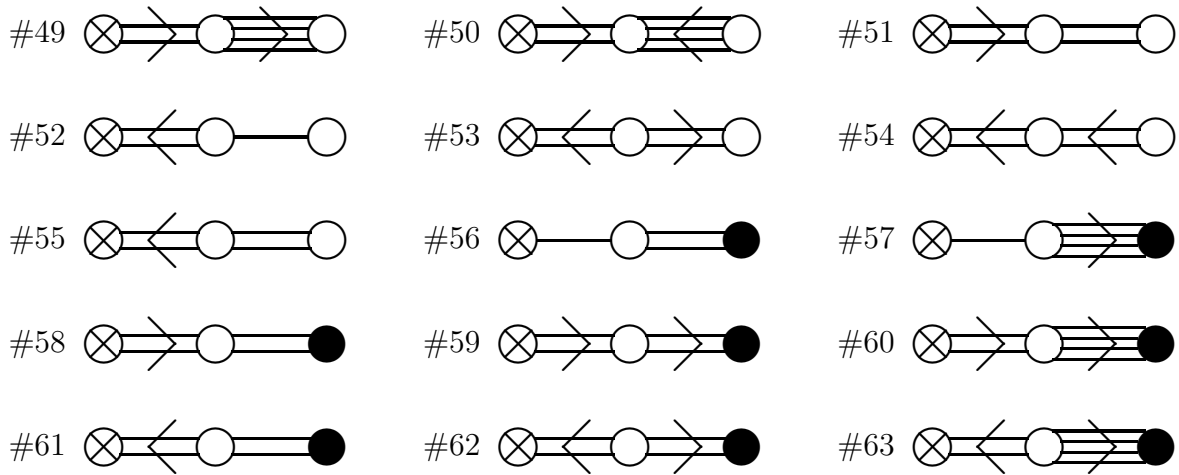

Rank 4 hyperbolic superalgebras (73 diagrams)

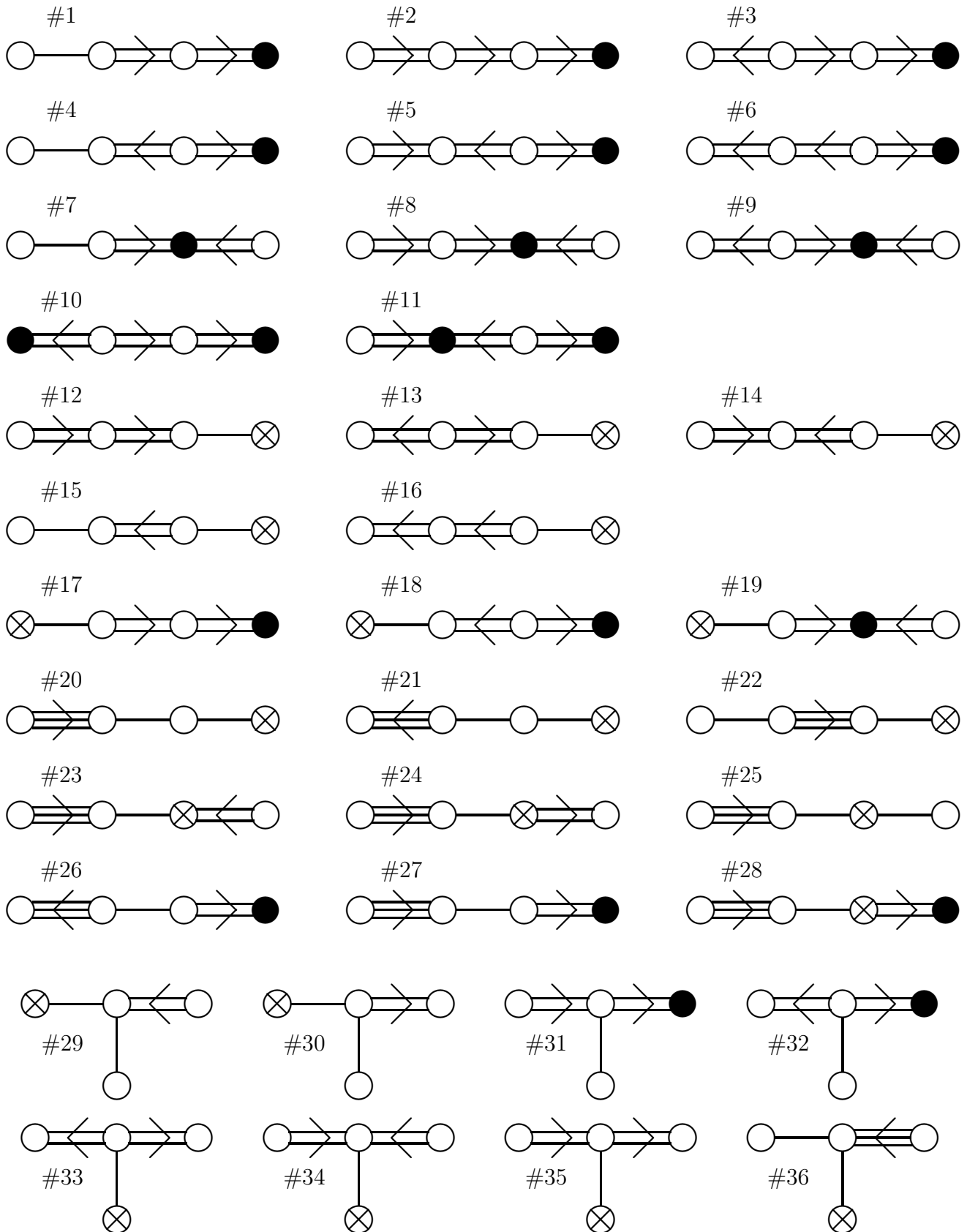

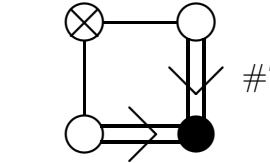
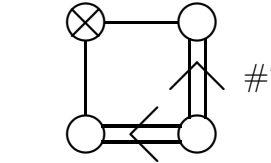
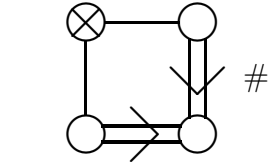
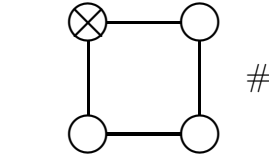
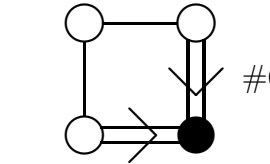
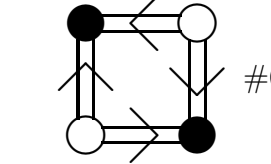
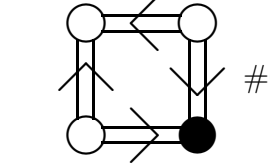
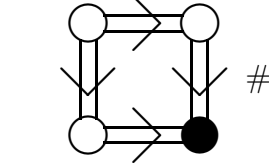
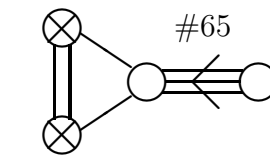
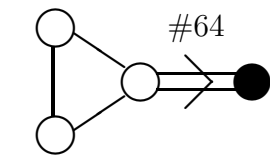
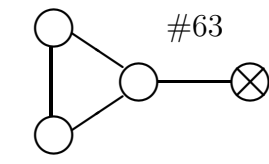
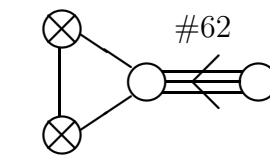
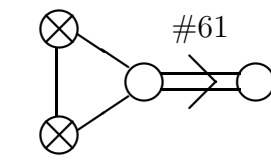
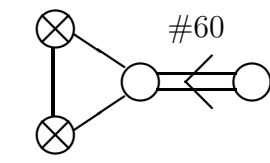
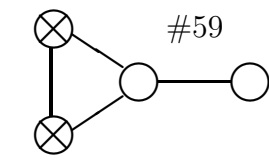
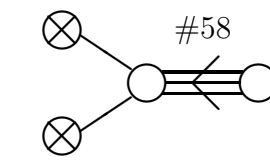
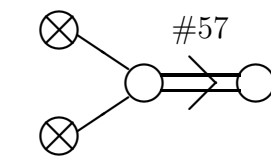
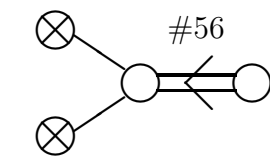
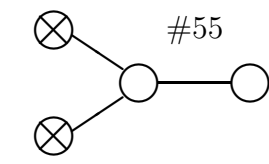
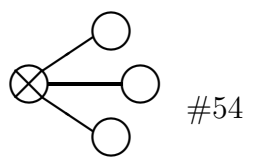
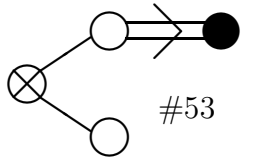
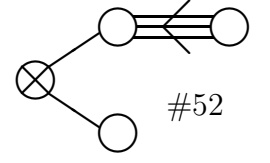
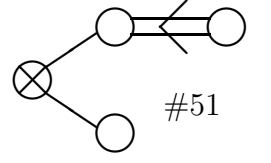
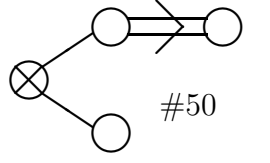
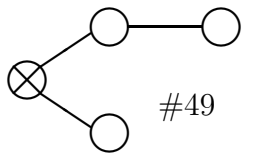
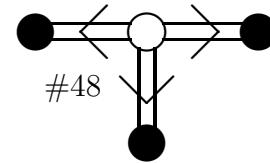
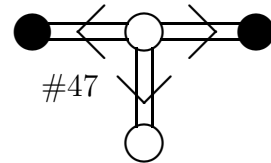
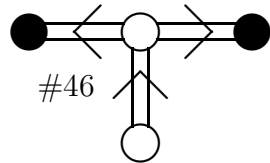
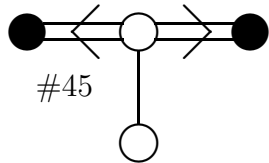
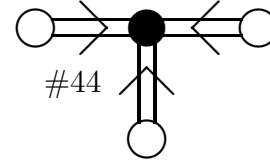
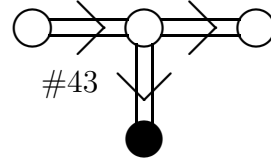
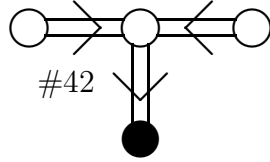
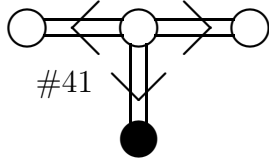
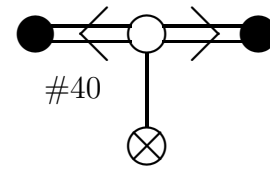
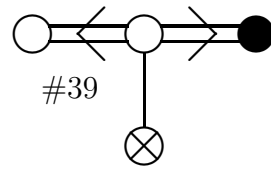
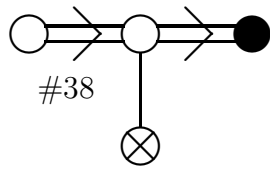
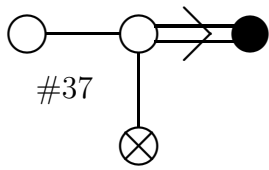



Rank 5 hyperbolic superalgebras (38 diagrams)

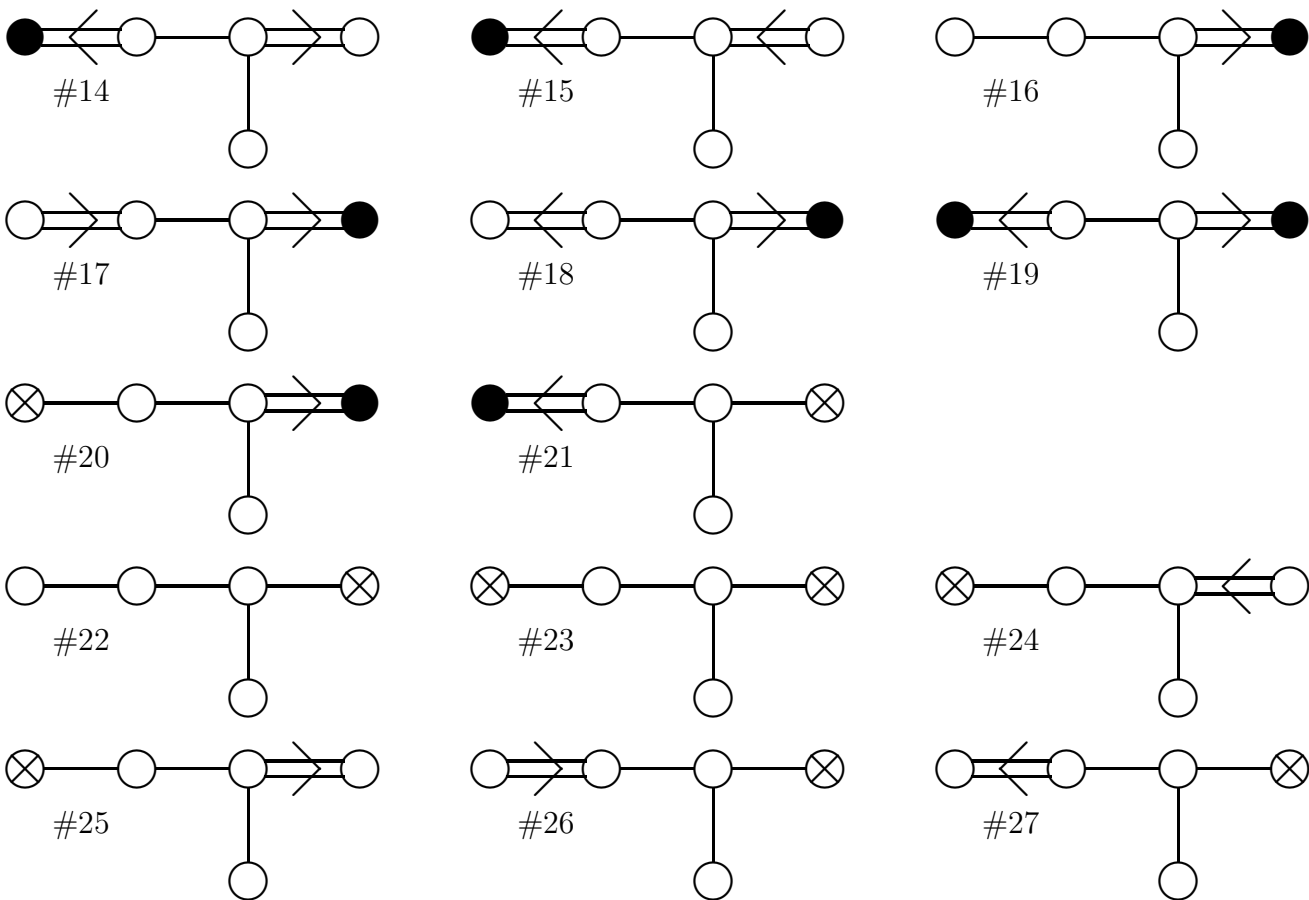
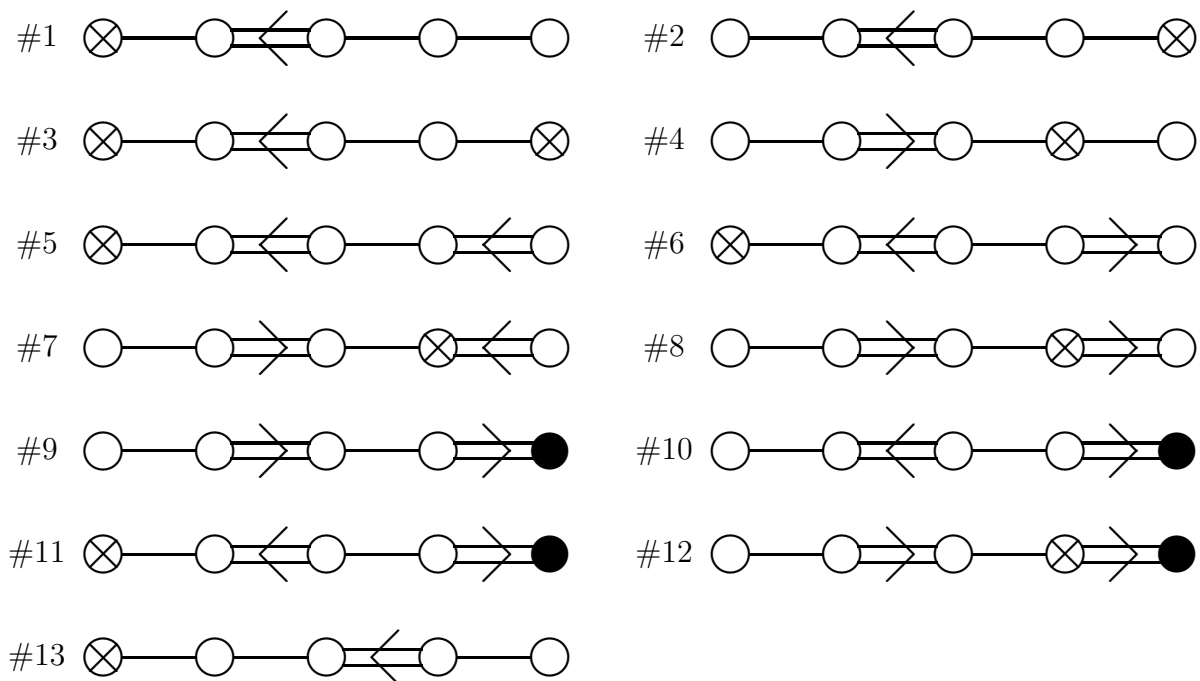

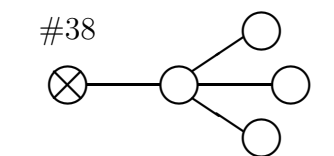
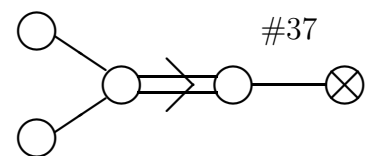
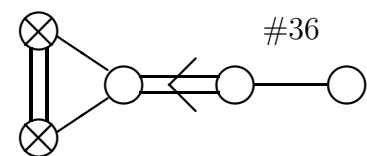
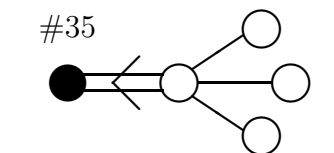
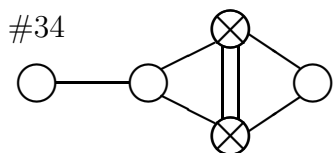
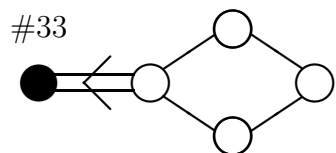
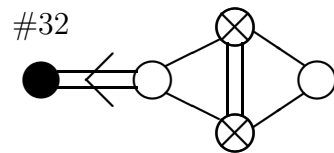
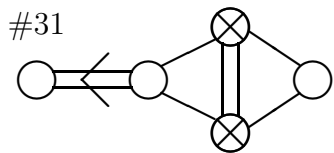
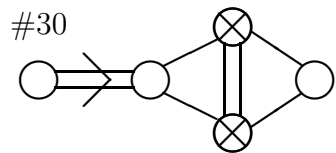
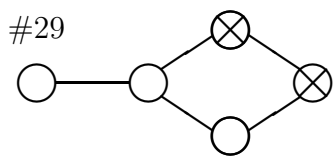
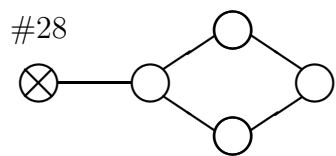

Rank 6 hyperbolic superalgebras (15 diagrams)

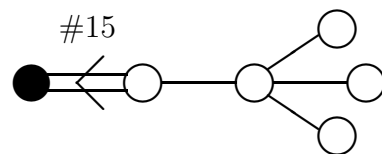
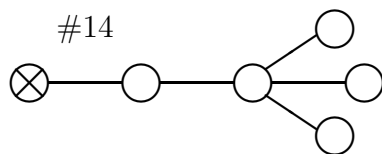
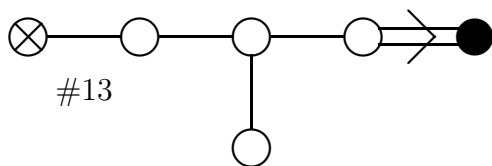
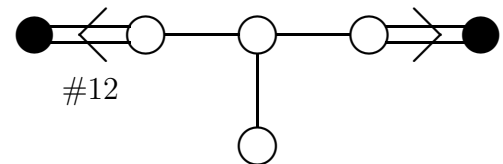
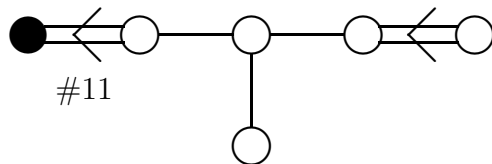
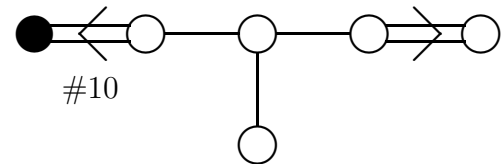
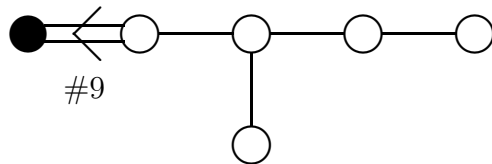
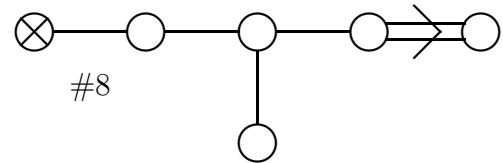
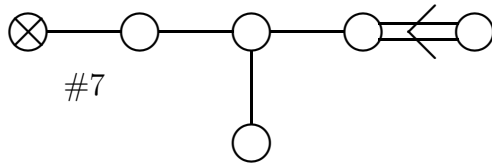
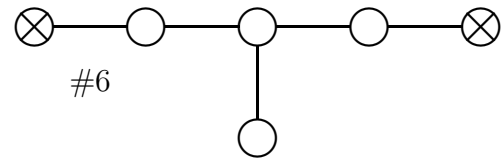
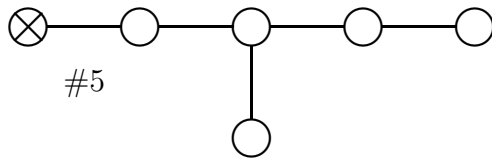
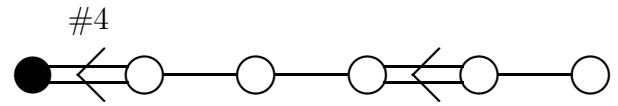
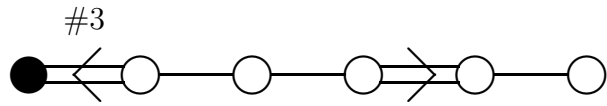
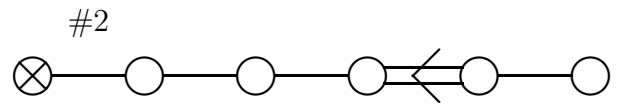
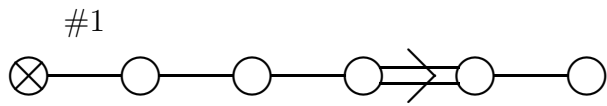

## B. Simple root systems

We describe in this section the simple root systems corresponding to the Dynkin diagrams of Appendix A (as usual, the parametrization is not unique). We give below the conventions used to describe the simple root systems depending on the topology of the considered Dynkin diagrams. In any case, the simple roots are written in terms of orthogonal vectors  $\varepsilon_i$ ,  $\delta_i$ ,  $K^+$  and  $K^-$  such that  $(\varepsilon_i, \varepsilon_j) = 1$ ,  $(\delta_i, \delta_j) = -1$ ,  $(K^+, K^-) = 1$  and all other scalar products are zero. It is also convenient to introduce  $\tilde{\delta} = \delta_1 + \delta_2 + \delta_3$  which satisfies  $(\tilde{\delta}, \tilde{\delta}) = -3$  and  $(\tilde{\delta}, \varepsilon_i) = (\tilde{\delta}, K^+) = (\tilde{\delta}, K^-) = 0$ .

### Rank 3 hyperbolic superalgebras

Conventions for the simple root systems  $\Delta^0 = \{\alpha_1, \alpha_2, \alpha_3\}$ :

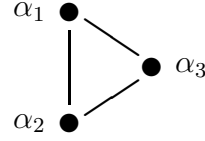
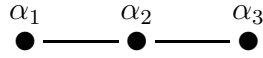

- #1 :  $\Delta^0 = \{ 2\varepsilon_1 - \varepsilon_2 - \varepsilon_3 - K^-, \varepsilon_2 - \varepsilon_1, 2K^+ + \varepsilon_1 \}$
- #2 :  $\Delta^0 = \{ \frac{1}{3}(2\varepsilon_1 - \varepsilon_2 - \varepsilon_3) - K^-, \varepsilon_2 - \varepsilon_1, \frac{2}{3}K^+ + \varepsilon_1 \}$
- #3 :  $\Delta^0 = \{ -\frac{1}{2}(\varepsilon_1 + \varepsilon_2 + \varepsilon_3 + \varepsilon_4) - K^-, \varepsilon_1, -\varepsilon_1 + \frac{1}{2}K^+ \}$
- #4 :  $\Delta^0 = \{ -2\varepsilon_1 + 2\varepsilon_2 - K^-, \varepsilon_1 - \varepsilon_2, 2K^+ + \varepsilon_2 \}$
- #5 :  $\Delta^0 = \{ -\frac{1}{2}(\varepsilon_1 - \varepsilon_2) - K^-, \varepsilon_1 - \varepsilon_2, \frac{1}{2}K^+ + \varepsilon_2 \}$
- #6 :  $\Delta^0 = \{ -\varepsilon_1 - K^-, \varepsilon_1, -\varepsilon_1 + K^+ \}$
- #7 :  $\Delta^0 = \{ -\varepsilon_1 + \varepsilon_2 - K^-, \varepsilon_1, -\varepsilon_1 + K^+ \}$
- #8 :  $\Delta^0 = \{ \frac{1}{2}(-\varepsilon_1 + \varepsilon_2) - K^-, \varepsilon_1, -\varepsilon_1 + \frac{1}{2}K^+ \}$
- #9 :  $\Delta^0 = \{ -2\varepsilon_1 - K^-, \varepsilon_1, -\varepsilon_1 + 2K^+ \}$
- #10 :  $\Delta^0 = \{ -\frac{1}{2}(3\varepsilon_1 + \varepsilon_2 + \varepsilon_3 + \varepsilon_4) - \frac{3}{2}K^-, \varepsilon_1, -\varepsilon_1 + K^+ \}$
- #11 :  $\Delta^0 = \{ -\frac{1}{6}(3\varepsilon_1 + \varepsilon_2 + \varepsilon_3 + \varepsilon_4) - \frac{1}{2}K^-, \varepsilon_1, -\varepsilon_1 + K^+ \}$
- #12 :  $\Delta^0 = \{ -\frac{1}{2}\varepsilon_1 - K^-, \varepsilon_1, -\varepsilon_1 + \frac{1}{2}K^+ \}$
- #13 :  $\Delta^0 = \{ 2\varepsilon_1 - 2\varepsilon_2 - K^-, 2\varepsilon_2, 2K^+ - \varepsilon_2 \}$
- #14 :  $\Delta^0 = \{ \varepsilon_1 - \varepsilon_2 - K^-, 2\varepsilon_2, K^+ - \varepsilon_2 \}$
- #15 :  $\Delta^0 = \{ \varepsilon_1 + \varepsilon_2 + \varepsilon_3 + \varepsilon_4 - K^-, -2\varepsilon_1, K^+ + \varepsilon_1 \}$
- #16 :  $\Delta^0 = \{ 2\varepsilon_1 - \varepsilon_2 - \varepsilon_3 - K^-, \varepsilon_2 - \varepsilon_1, \frac{3}{2}K^+ + \frac{1}{2}(\varepsilon_1 - \varepsilon_2) \}$
- #17 :  $\Delta^0 = \{ \frac{1}{3}(2\varepsilon_1 - \varepsilon_2 - \varepsilon_3) - K^-, \varepsilon_2 - \varepsilon_1, \frac{1}{2}K^+ + \frac{1}{2}(\varepsilon_1 - \varepsilon_2) \}$
- #18 :  $\Delta^0 = \{ 2\varepsilon_1 - K^-, -2\varepsilon_1, 2K^+ + \varepsilon_1 \}$
- #19 :  $\Delta^0 = \{ -4\varepsilon_1 - K^-, 2\varepsilon_1, -\varepsilon_1 + 4K^+ \}$
- #20 :  $\Delta^0 = \{ -\varepsilon_1 - K^-, 2\varepsilon_1, K^+ - \varepsilon_1 \}$
- #21 :  $\Delta^0 = \{ -\varepsilon_1 + \varepsilon_2 - K^-, \varepsilon_1 - \varepsilon_2, K^+ + \varepsilon_2 \}$
- #22 :  $\Delta^0 = \{ -\varepsilon_1 - 2K^-, \varepsilon_1, -2\varepsilon_1 + K^+ \}$
- #23 :  $\Delta^0 = \{ \varepsilon_1 - \varepsilon_2 - 2K^-, \varepsilon_2, K^+ - 2\varepsilon_2 \}$
- #24 :  $\Delta^0 = \{ -2\varepsilon_1 - 2K^-, \varepsilon_1, 2K^+ - 2\varepsilon_1 \}$
- #25 :  $\Delta^0 = \{ -\varepsilon_1 - K^-, \varepsilon_1, -\varepsilon_1 + K^+ \}$
- #26 :  $\Delta^0 = \{ -\varepsilon_1 - K^-, \varepsilon_1, -\varepsilon_1 + \varepsilon_2 + K^+ \}$
- #27 :  $\Delta^0 = \{ -\varepsilon_1 - K^-, \varepsilon_1, -\varepsilon_1 + K^+ \}$
- #28 :  $\Delta^0 = \{ -\varepsilon_1 - K^-, \varepsilon_1, -\varepsilon_1 + K^+ \}$
- #29 :  $\Delta^0 = \{ -\varepsilon_1 - \frac{1}{2}K^-, \varepsilon_1, -\frac{1}{2}(\varepsilon_1 - \varepsilon_2) + K^+ \}$
- #30 :  $\Delta^0 = \{ -\varepsilon_1 - \frac{1}{2}K^-, \varepsilon_1, -\frac{1}{2}\varepsilon_1 + K^+ \}$

- #31 :  $\Delta^0 = \{ -\varepsilon_1 - K^-, 2\varepsilon_1, K^+ - \varepsilon_1 \}$   
 #32 :  $\Delta^0 = \{ -\varepsilon_1 - K^-, \varepsilon_1, -\varepsilon_1 + K^+ \}$   
 #33 :  $\Delta^0 = \{ -\varepsilon_1 - K^-, \varepsilon_1, -\varepsilon_1 + \varepsilon_2 + K^+ \}$   
 #34 :  $\Delta^0 = \{ -\varepsilon_1 - \frac{1}{2}K^-, \varepsilon_1 - \varepsilon_2, -\frac{1}{2}(\varepsilon_1 - \varepsilon_2) + K^+ \}$   
 #35 :  $\Delta^0 = \{ -\varepsilon_1 - 2K^-, \varepsilon_1, -2\varepsilon_1 + K^+ \}$   
 #36 :  $\Delta^0 = \{ \delta_1 - \varepsilon_2 - K^-, \varepsilon_2 - \varepsilon_1, \frac{1}{3}K^+ + \frac{1}{3}(2\varepsilon_1 - \varepsilon_2 - \varepsilon_3) \}$   
 #37 :  $\Delta^0 = \{ \delta_1 - \varepsilon_1 - K^-, \varepsilon_1 - \varepsilon_2, -\frac{1}{2}(\varepsilon_1 - \varepsilon_2) + \frac{1}{2}K^+ \}$   
 #38 :  $\Delta^0 = \{ \delta_1 - \varepsilon_1 - K^-, \varepsilon_1 - \varepsilon_2, -2\varepsilon_1 + 2\varepsilon_2 + 2K^+ \}$   
 #39 :  $\Delta^0 = \{ \delta_1 - \varepsilon_1 - K^-, \varepsilon_1 - \varepsilon_2, -\varepsilon_1 + \varepsilon_2 + K^+ \}$   
 #40 :  $\Delta^0 = \{ \varepsilon_1 - \delta_1 - K^-, -\varepsilon_1, \frac{1}{2}(\varepsilon_1 + \varepsilon_2 + \varepsilon_3 + \varepsilon_4) + \frac{1}{2}K^+ \}$   
 #41 :  $\Delta^0 = \{ \varepsilon_1 - \delta_1 - K^-, -\varepsilon_1, \frac{1}{2}(\varepsilon_1 - \varepsilon_2) + \frac{1}{2}K^+ \}$   
 #42 :  $\Delta^0 = \{ \varepsilon_1 - \delta_1 - K^-, -\varepsilon_1, \varepsilon_1 - \varepsilon_2 + K^+ \}$   
 #43 :  $\Delta^0 = \{ \delta_1 - \varepsilon_1 - K^-, \varepsilon_1, -\frac{1}{2}\varepsilon_1 + \frac{1}{6}(\varepsilon_2 + \varepsilon_3 + \varepsilon_4) + \frac{1}{2}K^+ \}$   
 #44 :  $\Delta^0 = \{ \delta_1 - \varepsilon_1 - K^-, \varepsilon_1, -\frac{3}{2}\varepsilon_1 + \frac{1}{2}(\varepsilon_2 + \varepsilon_3 + \varepsilon_4) + \frac{3}{2}K^+ \}$   
 #45 :  $\Delta^0 = \{ \varepsilon_1 - \delta_1 - 4K^-, -2\varepsilon_1, 4\varepsilon_1 + K^+ \}$   
 #46 :  $\Delta^0 = \{ \delta_1 - \varepsilon_1 - K^-, 2\varepsilon_1, -\varepsilon_1 + \frac{1}{3}(\varepsilon_2 + \varepsilon_3 + \varepsilon_4) + K^+ \}$   
 #47 :  $\Delta^0 = \{ \delta_1 - \varepsilon_1 - K^-, \varepsilon_1, -3\varepsilon_1 + \varepsilon_2 + \varepsilon_3 + \varepsilon_4 + 3K^+ \}$   
 #48 :  $\Delta^0 = \{ \varepsilon_1 - \delta_1 - K^-, -2\varepsilon_1, \varepsilon_1 + K^+ \}$   
 #49 :  $\Delta^0 = \{ \varepsilon_1 - \delta_1 - \frac{1}{2}K^-, -\varepsilon_1, \frac{1}{2}\varepsilon_1 + K^+ \}$   
 #50 :  $\Delta^0 = \{ \varepsilon_1 - \delta_1 - 2K^-, -\varepsilon_1, 2\varepsilon_1 + K^+ \}$   
 #51 :  $\Delta^0 = \{ \varepsilon_1 - \varepsilon_2 - \delta_1 + \delta_2 - 2K^-, -\varepsilon_1 + \varepsilon_2, \varepsilon_1 - \varepsilon_2 + K^+ \}$   
 #52 :  $\Delta^0 = \{ \varepsilon_1 - \delta_1 - K^-, -2\varepsilon_1, \varepsilon_1 + \varepsilon_2 + \varepsilon_3 + \varepsilon_4 + K^+ \}$   
 #53 :  $\Delta^0 = \{ \varepsilon_1 - \delta_1 - K^-, -2\varepsilon_1, \varepsilon_1 - \varepsilon_2 + K^+ \}$   
 #54 :  $\Delta^0 = \{ \varepsilon_1 - \delta_1 - 2K^-, -2\varepsilon_1, 2\varepsilon_1 - 2\varepsilon_2 + K^+ \}$   
 #55 :  $\Delta^0 = \{ \varepsilon_1 - \delta_1 - 2K^-, -2\varepsilon_1, 2\varepsilon_1 + K^+ \}$   
 #56 :  $\Delta^0 = \{ \delta_1 - \varepsilon_1 - K^-, \varepsilon_1 - \varepsilon_2, -\varepsilon_1 + \varepsilon_2 + K^+ \}$   
 #57 :  $\Delta^0 = \{ \delta_1 - \varepsilon_1 - \frac{1}{2}K^-, \varepsilon_1 - \varepsilon_2, -\frac{1}{2}(\varepsilon_1 - \varepsilon_2) + K^+ \}$   
 #58 :  $\Delta^0 = \{ \varepsilon_1 - \delta_1 - K^-, -\varepsilon_1, \varepsilon_1 + K^+ \}$   
 #59 :  $\Delta^0 = \{ \varepsilon_1 - \delta_1 - K^-, -\varepsilon_1, \frac{1}{2}(\varepsilon_1 - \varepsilon_2) + \frac{1}{2}K^+ \}$   
 #60 :  $\Delta^0 = \{ \varepsilon_1 - \delta_1 - \frac{1}{2}K^-, -\varepsilon_1, \frac{1}{2}\varepsilon_1 + K^+ \}$   
 #61 :  $\Delta^0 = \{ \varepsilon_1 - \delta_1 - 2K^-, -2\varepsilon_1, 2\varepsilon_1 + K^+ \}$   
 #62 :  $\Delta^0 = \{ \varepsilon_1 - \delta_1 - K^-, -2\varepsilon_1, \varepsilon_1 - \varepsilon_2 + K^+ \}$   
 #63 :  $\Delta^0 = \{ \varepsilon_1 - \delta_1 - K^-, -2\varepsilon_1, \varepsilon_1 - \varepsilon_2 + K^+ \}$   
 #64 :  $\Delta^0 = \{ -\varepsilon_1 + \varepsilon_2 - 3K^-, -\varepsilon_1 + \varepsilon_2 + K^+, \varepsilon_1 - \varepsilon_2 \}$   
 #65 :  $\Delta^0 = \{ \varepsilon_1 + \varepsilon_2 - 3K^-, \varepsilon_1 + \varepsilon_2 + K^+, -\varepsilon_1 \}$   
 #66 :  $\Delta^0 = \{ -2\varepsilon_1 - 3K^-, -2\varepsilon_1 + 2K^+, \varepsilon_1 \}$   
 #67 :  $\Delta^0 = \{ \varepsilon_1 - \varepsilon_2 - 2K^-, -\varepsilon_2 + K^+, \varepsilon_2 \}$   
 #68 :  $\Delta^0 = \{ -2\varepsilon_2 - 2K^-, \varepsilon_1 - \varepsilon_2 + 2K^+, \varepsilon_2 \}$   
 #69 :  $\Delta^0 = \{ \varepsilon_1 - \varepsilon_2 - 2K^-, \varepsilon_1 - \varepsilon_2 + 2K^+, -\varepsilon_1 + \varepsilon_2 \}$   
 #70 :  $\Delta^0 = \{ \varepsilon_1 - \varepsilon_2 - 2K^-, \varepsilon_1 - \varepsilon_2 + 2K^+, -\varepsilon_1 \}$   
 #71 :  $\Delta^0 = \{ \varepsilon_1 - \varepsilon_2 - 2K^-, \varepsilon_1 - \varepsilon_2 + 2K^+, -\frac{1}{2}(\varepsilon_1 - \varepsilon_2) \}$   
 #72 :  $\Delta^0 = \{ \varepsilon_1 - 2K^-, \varepsilon_1 + K^+, -\varepsilon_1 \}$   
 #73 :  $\Delta^0 = \{ \varepsilon_1, -\varepsilon_1 - 2K^-, \varepsilon_2 - \varepsilon_1 + K^+ \}$   
 #74 :  $\Delta^0 = \{ \varepsilon_1, -\varepsilon_1 - 2K^-, -2\varepsilon_1 + 2K^+ \}$   
 #75 :  $\Delta^0 = \{ \varepsilon_1 - 2K^-, \varepsilon_1 + K^+, -\varepsilon_1 \}$   
 #76 :  $\Delta^0 = \{ \varepsilon_1 - \varepsilon_2 - K^-, \varepsilon_1 + \varepsilon_2 + K^+, \delta_1 - \varepsilon_1 \}$   
 #77 :  $\Delta^0 = \{ 2\varepsilon_1 - 3K^-, 2\varepsilon_1 + 2K^+, \delta_1 - \varepsilon_1 \}$

- #78 :  $\Delta^0 = \{ \varepsilon_1 - \frac{3}{2}K^-, \varepsilon_1 + K^+, \delta_1 - \varepsilon_1 \}$   
#79 :  $\Delta^0 = \{ \varepsilon_1 - \varepsilon_2 - 2K^-, \varepsilon_1 - \varepsilon_2 + 2K^+, \delta_1 - \varepsilon_1 \}$   
#80 :  $\Delta^0 = \{ 2\varepsilon_1 - 4K^-, 2\varepsilon_1 + 2K^+, \delta_1 - \varepsilon_1 \}$   
#81 :  $\Delta^0 = \{ \varepsilon_1 - 2K^-, \varepsilon_1 + K^+, \delta_1 - \varepsilon_1 \}$   
#82 :  $\Delta^0 = \{ \varepsilon_1 - \delta_1 - 2K^-, \varepsilon_1 - \varepsilon_2 + K^+, -\varepsilon_1 \}$   
#83 :  $\Delta^0 = \{ \varepsilon_1 - \delta_1 - 2K^-, \varepsilon_1 - \varepsilon_2 + K^+, -2\varepsilon_1 \}$   
#84 :  $\Delta^0 = \{ 2\varepsilon_1 - 2K^-, \varepsilon_1 + 2K^+, \delta_1 - \varepsilon_1 \}$   
#85 :  $\Delta^0 = \{ \varepsilon_1 - \delta_1 + K^-, \varepsilon_1 - \delta_1 + K^+, -\varepsilon_1 \}$   
#86 :  $\Delta^0 = \{ \varepsilon_1 - \delta_1 + K^-, \varepsilon_1 - \delta_1 + K^+, -2\varepsilon_1 \}$   
#87 :  $\Delta^0 = \{ \varepsilon_1 + \delta_1 - K^-, \varepsilon_1 + \delta_1 + K^+, -\varepsilon_1 \}$

### Rank 4 hyperbolic superalgebras

Conventions for the simple root systems  $\Delta^0 = \{ \alpha_1, \alpha_2, \alpha_3, \alpha_4 \}$ :

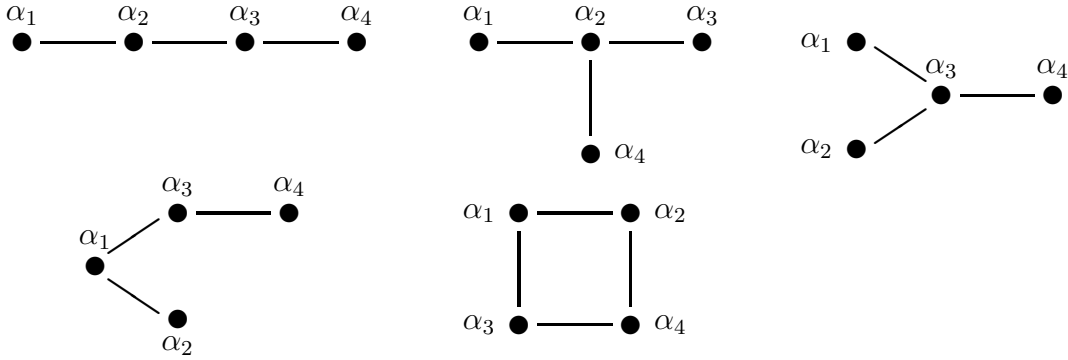

- #1 :  $\Delta^0 = \{ \varepsilon_1 + \varepsilon_2 + \varepsilon_3 + \varepsilon_4 - K^-, -2\varepsilon_1, \varepsilon_1 - \varepsilon_2, K^+ + \varepsilon_2 \}$   
#2 :  $\Delta^0 = \{ 2\varepsilon_1 + 2\varepsilon_2 - K^-, -2\varepsilon_1, \varepsilon_1 - \varepsilon_2, 2K^+ + \varepsilon_2 \}$   
#3 :  $\Delta^0 = \{ \varepsilon_1 + \varepsilon_2 - K^-, -2\varepsilon_1, \varepsilon_1 - \varepsilon_2, K^+ + \varepsilon_2 \}$   
#4 :  $\Delta^0 = \{ \frac{1}{2}(\varepsilon_1 + \varepsilon_2 + \varepsilon_3 + \varepsilon_4) - K^-, -\varepsilon_1, \varepsilon_1 - \varepsilon_2, \frac{1}{2}K^+ + \varepsilon_2 \}$   
#5 :  $\Delta^0 = \{ \varepsilon_1 + \varepsilon_2 - K^-, -\varepsilon_1, \varepsilon_1 - \varepsilon_2, K^+ + \varepsilon_2 \}$   
#6 :  $\Delta^0 = \{ \frac{1}{2}(\varepsilon_1 + \varepsilon_2) - K^-, -\varepsilon_1, \varepsilon_1 - \varepsilon_2, \frac{1}{2}K^+ + \varepsilon_2 \}$   
#7 :  $\Delta^0 = \{ \varepsilon_1 - \varepsilon_2 - K^-, \varepsilon_2 - \varepsilon_3, \varepsilon_3, K^+ - \varepsilon_2 - \varepsilon_3 \}$   
#8 :  $\Delta^0 = \{ -2\varepsilon_1 - K^-, \varepsilon_1 - \varepsilon_2, \varepsilon_2, 2K^+ - \varepsilon_1 - \varepsilon_2 \}$   
#9 :  $\Delta^0 = \{ -\varepsilon_1 - K^-, \varepsilon_1 - \varepsilon_2, \varepsilon_2, K^+ - \varepsilon_1 - \varepsilon_2 \}$   
#10 :  $\Delta^0 = \{ \varepsilon_1 + \varepsilon_2 - K^-, -2\varepsilon_1, \varepsilon_1 - \varepsilon_2, K^+ + \varepsilon_2 \}$   
#11 :  $\Delta^0 = \{ \varepsilon_1 + \varepsilon_2 - K^-, -\varepsilon_1, \varepsilon_1 - \varepsilon_2, K^+ + \varepsilon_2 \}$   
#12 :  $\Delta^0 = \{ -2\varepsilon_1 - 2\varepsilon_2 - K^-, 2\varepsilon_2, \varepsilon_1 - \varepsilon_2, \delta_1 - \varepsilon_1 + 2K^+ \}$   
#13 :  $\Delta^0 = \{ -\varepsilon_1 - \varepsilon_2 - K^-, 2\varepsilon_2, \varepsilon_1 - \varepsilon_2, \delta_1 - \varepsilon_1 + K^+ \}$   
#14 :  $\Delta^0 = \{ -\varepsilon_1 - \varepsilon_2 - K^-, \varepsilon_2, \varepsilon_1 - \varepsilon_2, K^+ + \delta_1 - \varepsilon_1 \}$   
#15 :  $\Delta^0 = \{ -\frac{1}{2}(\varepsilon_1 + \varepsilon_2 + \varepsilon_3 + \varepsilon_4) + K^-, \varepsilon_2, \varepsilon_1 - \varepsilon_2, \frac{1}{2}K^+ + \varepsilon_2 - \delta_1 \}$   
#16 :  $\Delta^0 = \{ \frac{1}{2}(\varepsilon_1 + \varepsilon_2) - K^-, -\varepsilon_1, \varepsilon_1 - \varepsilon_2, \frac{1}{2}K^+ + \varepsilon_2 - \delta_1 \}$   
#17 :  $\Delta^0 = \{ \delta_1 - \varepsilon_1 - K^-, \varepsilon_1 - \varepsilon_2, \varepsilon_2, -\frac{1}{2}(\varepsilon_1 + \varepsilon_2) + \frac{1}{2}K^+ \}$   
#18 :  $\Delta^0 = \{ \delta_1 - \varepsilon_1 - K^-, \varepsilon_1 - \varepsilon_2, 2\varepsilon_2, -\varepsilon_1 - \varepsilon_2 + K^+ \}$   
#19 :  $\Delta^0 = \{ \delta_1 - \varepsilon_1 - K^-, \varepsilon_1 - \varepsilon_2, \varepsilon_2, K^+ - \varepsilon_1 - \varepsilon_2 \}$   
#20 :  $\Delta^0 = \{ 2\varepsilon_3 - \varepsilon_1 - \varepsilon_2 - K^-, \varepsilon_2 - \varepsilon_3, \varepsilon_1 - \varepsilon_2, K^+ - \varepsilon_1 + \delta_1 \}$   
#21 :  $\Delta^0 = \{ \frac{1}{3}(2\varepsilon_3 - \varepsilon_1 - \varepsilon_2) - K^-, \varepsilon_2 - \varepsilon_3, \varepsilon_1 - \varepsilon_2, \frac{1}{3}K^+ - \varepsilon_1 + \delta_1 \}$   
#22 :  $\Delta^0 = \{ 2\varepsilon_3 - \varepsilon_1 - \varepsilon_2 - K^-, 2\varepsilon_2 - \varepsilon_1 - \varepsilon_3 - K^-, \varepsilon_1 - \varepsilon_2, \delta_1 - \varepsilon_1 + K^+ \}$   
#23 :  $\Delta^0 = \{ 2\varepsilon_2 - \varepsilon_1 - \varepsilon_3 - K^-, \varepsilon_1 - \varepsilon_2, \delta_1 - \varepsilon_1 + K^+, -2\delta_1 \}$







- #30 :  $\Delta^0 = \{ -2\varepsilon_2 - K^-, \varepsilon_1 + \varepsilon_2, \delta_1 - \varepsilon_1, -\delta_1 - \varepsilon_1, 2K^+ + \varepsilon_1 - \varepsilon_2 \}$   
#31 :  $\Delta^0 = \{ -\varepsilon_2 - K^-, \varepsilon_1 + \varepsilon_2, \delta_1 - \varepsilon_1, -\delta_1 - \varepsilon_1, K^+ + \varepsilon_1 - \varepsilon_2 \}$   
#32 :  $\Delta^0 = \{ -\varepsilon_2 - K^-, \varepsilon_1 + \varepsilon_2, \delta_1 - \varepsilon_1, -\delta_1 - \varepsilon_1, K^+ + \varepsilon_1 - \varepsilon_2 \}$   
#33 :  $\Delta^0 = \{ \varepsilon_4 - K^-, \varepsilon_3 - \varepsilon_4, \varepsilon_2 - \varepsilon_3, K^+ + \varepsilon_4 - \varepsilon_1, \varepsilon_1 - \varepsilon_2 \}$   
#34 :  $\Delta^0 = \{ \varepsilon_3 - \varepsilon_2 - K^-, \varepsilon_1 + \varepsilon_2, \delta_1 - \varepsilon_1, -\delta_1 - \varepsilon_1, K^+ + \varepsilon_1 - \varepsilon_2 \}$   
#35 :  $\Delta^0 = \{ -\varepsilon_2 - K^-, \varepsilon_2 - \varepsilon_3, \varepsilon_3 - \varepsilon_4, \varepsilon_3 + \varepsilon_4, K^+ + \varepsilon_1 - \varepsilon_2 \}$   
#36 :  $\Delta^0 = \{ \delta_1 - \varepsilon_1 - K^-, -\delta_1 - \varepsilon_1 - K^-, \varepsilon_1 - \varepsilon_2, 2\varepsilon_2, -\varepsilon_1 - \varepsilon_2 - \varepsilon_3 - \varepsilon_4 + K^+ \}$   
#37 :  $\Delta^0 = \{ \varepsilon_1 - \varepsilon_2, K^+ - \varepsilon_1 - \varepsilon_2, \varepsilon_2 - \varepsilon_3, \varepsilon_3, \frac{1}{2}(\tilde{\delta} - \varepsilon_1 - \varepsilon_2 - \varepsilon_3) - K^- \}$   
#38 :  $\Delta^0 = \{ \delta_1 - \varepsilon_2 - K^-, \varepsilon_2 - \varepsilon_3, \varepsilon_3 - \varepsilon_4, \varepsilon_3 + \varepsilon_4, K^+ + \varepsilon_1 - \varepsilon_2 \}$

## Rank 6 hyperbolic superalgebras

Conventions for the simple root systems  $\Delta^0 = \{ \alpha_1, \alpha_2, \alpha_3, \alpha_4, \alpha_5, \alpha_6 \}$ :

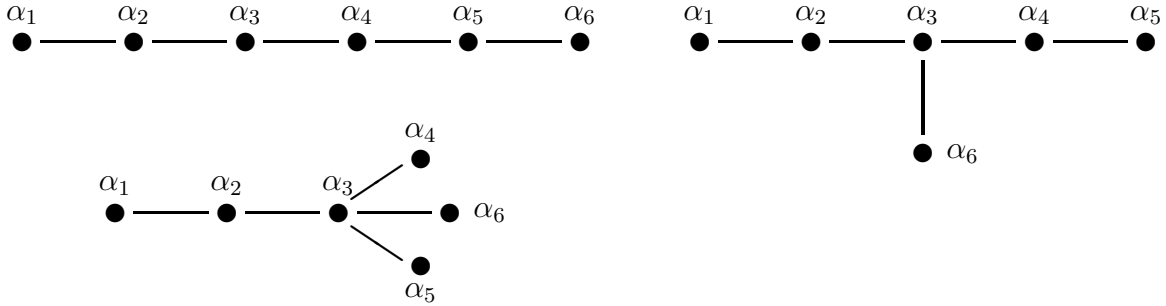

- #1 :  $\Delta^0 = \{ -\varepsilon_1 + \delta_1 - \frac{1}{2}K^-, \varepsilon_1 - \varepsilon_2, \varepsilon_2 - \varepsilon_3, \varepsilon_3 - \varepsilon_4, \varepsilon_4, K^+ - \frac{1}{2}(\varepsilon_1 + \varepsilon_2 + \varepsilon_3 + \varepsilon_4) \}$   
#2 :  $\Delta^0 = \{ \delta_1 - \varepsilon_1 - K^-, \varepsilon_1 - \varepsilon_2, \varepsilon_2 - \varepsilon_3, \varepsilon_3 - \varepsilon_4, 2\varepsilon_4, K^+ - (\varepsilon_1 + \varepsilon_2 + \varepsilon_3 + \varepsilon_4) \}$   
#3 :  $\Delta^0 = \{ -\varepsilon_1 - \frac{1}{2}K^-, \varepsilon_1 - \varepsilon_2, \varepsilon_2 - \varepsilon_3, \varepsilon_3 - \varepsilon_4, \varepsilon_4, K^+ - \frac{1}{2}(\varepsilon_1 + \varepsilon_2 + \varepsilon_3 + \varepsilon_4) \}$   
#4 :  $\Delta^0 = \{ -\varepsilon_1 - K^-, \varepsilon_1 - \varepsilon_2, \varepsilon_2 - \varepsilon_3, \varepsilon_3 - \varepsilon_4, 2\varepsilon_4, K^+ - (\varepsilon_1 + \varepsilon_2 + \varepsilon_3 + \varepsilon_4) \}$   
#5 :  $\Delta^0 = \{ \delta_1 - \varepsilon_1 - K^-, \varepsilon_1 - \varepsilon_2, \varepsilon_2 - \varepsilon_3, \varepsilon_3 - \varepsilon_4, \varepsilon_4 - \varepsilon_5, K^+ - \varepsilon_1 - \varepsilon_2 \}$   
#6 :  $\Delta^0 = \{ \frac{1}{2}(\tilde{\delta} - \varepsilon_1 - \varepsilon_2 - \varepsilon_3) - 3K^-, \varepsilon_3 + \varepsilon_4, \varepsilon_2 - \varepsilon_3, \varepsilon_3 - \varepsilon_4, \frac{1}{2}(-\tilde{\delta} - \varepsilon_1 - \varepsilon_2 - \varepsilon_3) + \frac{1}{2}K^+, \varepsilon_1 - \varepsilon_2 \}$   
#7 :  $\Delta^0 = \{ \delta_1 - \varepsilon_1 - K^-, \varepsilon_1 - \varepsilon_2, \varepsilon_2 - \varepsilon_3, \varepsilon_3 - \varepsilon_4, 2\varepsilon_4, K^+ - \varepsilon_1 - \varepsilon_2 \}$   
#8 :  $\Delta^0 = \{ \delta_1 - \varepsilon_1 - K^-, \varepsilon_1 - \varepsilon_2, \varepsilon_2 - \varepsilon_3, \varepsilon_3 - \varepsilon_4, \varepsilon_4, K^+ - \varepsilon_1 - \varepsilon_2 \}$   
#9 :  $\Delta^0 = \{ -\varepsilon_1 - K^-, \varepsilon_1 - \varepsilon_2, \varepsilon_2 - \varepsilon_3, \varepsilon_3 - \varepsilon_4, \varepsilon_4 - \varepsilon_5, K^+ - \varepsilon_1 - \varepsilon_2 \}$   
#10 :  $\Delta^0 = \{ -\varepsilon_1 - K^-, \varepsilon_1 - \varepsilon_2, \varepsilon_2 - \varepsilon_3, \varepsilon_3 - \varepsilon_4, \varepsilon_4, K^+ - \varepsilon_1 - \varepsilon_2 \}$   
#11 :  $\Delta^0 = \{ -\varepsilon_1 - K^-, \varepsilon_1 - \varepsilon_2, \varepsilon_2 - \varepsilon_3, \varepsilon_3 - \varepsilon_4, 2\varepsilon_4, K^+ - \varepsilon_1 - \varepsilon_2 \}$   
#12 :  $\Delta^0 = \{ -\varepsilon_1 - K^-, \varepsilon_1 - \varepsilon_2, \varepsilon_2 - \varepsilon_3, \varepsilon_3 - \varepsilon_4, \varepsilon_4, K^+ - \varepsilon_1 - \varepsilon_2 \}$   
#13 :  $\Delta^0 = \{ \delta_1 - \varepsilon_1 - K^-, \varepsilon_1 - \varepsilon_2, \varepsilon_2 - \varepsilon_3, \varepsilon_3 - \varepsilon_4, \varepsilon_4, K^+ - \varepsilon_1 - \varepsilon_2 \}$   
#14 :  $\Delta^0 = \{ \delta_1 - \varepsilon_1 - K^-, \varepsilon_1 - \varepsilon_2, \varepsilon_2 - \varepsilon_3, \varepsilon_3 - \varepsilon_4, \varepsilon_3 + \varepsilon_4, K^+ - \varepsilon_1 - \varepsilon_2 \}$   
#15 :  $\Delta^0 = \{ -\varepsilon_1 - K^-, \varepsilon_1 - \varepsilon_2, \varepsilon_2 - \varepsilon_3, \varepsilon_3 - \varepsilon_4, \varepsilon_3 + \varepsilon_4, K^+ - \varepsilon_1 - \varepsilon_2 \}$

## C. Subalgebras of the hyperbolic KM superalgebras

### Rank 3 hyperbolic superalgebras

- |   |  |
|---|--|
| #1 : $G_2, osp(1 2) \oplus sl(2), osp(1 4)$                   | #2 : $G_2, osp(1 2) \oplus sl(2), osp(1 4)$                  |
| #3 : $sl(1 3)^{(4)}, osp(1 2) \oplus sl(2), sl(3)$            | #4 : $osp(1 4), osp(1 2) \oplus sl(2), sl(3)^{(2)}$          |
| #5 : $osp(1 4), osp(1 2) \oplus sl(2), sl(3)^{(2)}$           | #6 : $sl(1 3)^{(4)}, osp(1 2) \oplus sl(2), sl(2)^{(1)}$     |
| #7 : $sl(1 3)^{(4)}, osp(1 2) \oplus sl(2), sp(4)$            | #8 : $sl(1 3)^{(4)}, osp(1 2) \oplus sl(2), sp(4)$           |
| #9 : $sl(1 3)^{(4)}, osp(1 2) \oplus sl(2), sl(3)^{(2)}$      | #10 : $sl(1 3)^{(4)}, osp(1 2) \oplus sl(2), G_2$            |
| #11 : $sl(1 3)^{(4)}, osp(1 2) \oplus sl(2), G_2$             | #12 : $sl(1 3)^{(4)}, osp(1 2) \oplus sl(2), sl(3)^{(2)}$    |
| #13 : $osp(1 2)^{(1)}, osp(1 2) \oplus sl(2), sp(4)$          | #14 : $osp(1 2)^{(1)}, osp(1 2) \oplus sl(2), sp(4)$         |
| #15 : $osp(1 2)^{(1)}, osp(1 2) \oplus sl(2), sl(3)$          | #16 : $osp(1 2)^{(1)}, osp(1 2) \oplus sl(2), G_2$           |
| #17 : $osp(1 2)^{(1)}, osp(1 2) \oplus sl(2), G_2$            | #18 : $osp(1 2)^{(1)}, osp(1 2) \oplus sl(2), sl(2)^{(1)}$   |
| #19 : $osp(1 2)^{(1)}, osp(1 2) \oplus sl(2), sl(3)^{(2)}$    | #20 : $osp(1 2)^{(1)}, osp(1 2) \oplus sl(2), sl(3)^{(2)}$   |
| #21 : $osp(1 4), osp(1 2) \oplus sl(2), sl(2)^{(1)}$          | #22 : $osp(1 2)^{(1)}, 2sl(2), sl(1 3)^{(4)}$                |
| #23 : $osp(1 2)^{(1)}, 2sl(2), osp(1 4)$                      | #24 : $osp(1 2)^{(1)}, 2sl(2)$                               |
| #25 : $sl(1 3)^{(4)}, 2sl(2)$                                 | #26 : $sl(1 3)^{(4)}, 2sl(2), osp(1 4)$                      |
| #27 : $osp(2 2)^{(2)}, 2osp(1 2)$                             | #28 : $sl(1 3)^{(4)}, 2osp(1 2)$                             |
| #29 : $osp(1 4), 2osp(1 2), sl(1 3)^{(4)}$                    | #30 : $osp(1 2)^{(1)}, 2osp(1 2), sl(1 3)^{(4)}$             |
| #31 : $osp(1 2)^{(1)}, 2osp(1 2)$                             | #32 : $sl(1 3)^{(4)}, osp(1 2) \oplus sl(2), osp(2 2)^{(2)}$ |
| #33 : $osp(1 4), osp(1 2) \oplus sl(2), osp(2 2)^{(2)}$       | #34 : $osp(1 2)^{(1)}, 2osp(1 2), osp(1 4)$                  |
| #35 : $osp(1 2)^{(1)}, osp(1 2) \oplus sl(2), osp(2 2)^{(2)}$ | #36 : $G_2, sl(1 1) \oplus sl(2), sl(1 2)$                   |
| #37 : $sl(3)^{(2)}, sl(1 1) \oplus sl(2), sl(1 2)$            | #38 : $sl(3)^{(2)}, sl(1 1) \oplus sl(2), sl(1 2)$           |
| #39 : $sl(2)^{(1)}, sl(1 1) \oplus sl(2), sl(1 2)$            | #40 : $sl(3), sl(1 1) \oplus sl(2), osp(3 2)$                |
| #41 : $sp(4), sl(1 1) \oplus sl(2), osp(3 2)$                 | #42 : $sp(4), sl(1 1) \oplus sl(2), osp(3 2)$                |
| #43 : $G_2, sl(1 1) \oplus sl(2), osp(3 2)$                   | #44 : $G_2, sl(1 1) \oplus sl(2), osp(3 2)$                  |
| #45 : $sl(3)^{(2)}, sl(1 1) \oplus sl(2), osp(2 2)$           | #46 : $G_2, sl(1 1) \oplus sl(2), osp(2 2)$                  |
| #47 : $G_2, sl(1 1) \oplus sl(2), osp(2 2)$                   | #48 : $sl(3)^{(2)}, sl(1 1) \oplus sl(2), osp(2 2)$          |
| #49 : $sl(3)^{(2)}, sl(1 1) \oplus sl(2), osp(3 2)$           | #50 : $sl(3)^{(2)}, sl(1 1) \oplus sl(2), osp(3 2)$          |
| #51 : $sl(2)^{(1)}, sl(1 1) \oplus sl(2), osp(3 2)$           | #52 : $sl(3), sl(1 1) \oplus sl(2), osp(2 2)$                |
| #53 : $so(5), sl(1 1) \oplus sl(2), osp(2 2)$                 | #54 : $sp(4), sl(1 1) \oplus sl(2), osp(2 2)$                |
| #55 : $sl(2)^{(1)}, sl(1 1) \oplus sl(2), osp(2 2)$           | #56 : $sl(1 3)^{(4)}, sl(1 1) \oplus osp(1 2), sl(1 2)$      |
| #57 : $osp(1 2)^{(1)}, sl(1 1) \oplus osp(1 2), sl(1 2)$      | #58 : $sl(1 3)^{(4)}, sl(1 1) \oplus osp(1 2), osp(3 2)$     |
| #59 : $osp(1 4), osp(1 2) \oplus sl(1 1), osp(3 2)$           | #60 : $osp(1 2)^{(1)}, osp(1 2) \oplus sl(1 1), osp(3 2)$    |
| #61 : $sl(1 3)^{(4)}, sl(1 1) \oplus osp(1 2), osp(2 2)$      | #62 : $osp(1 4), osp(1 2) \oplus sl(1 1), osp(2 2)$          |
| #63 : $osp(1 2)^{(1)}, osp(1 2) \oplus sl(1 1), osp(2 2)$     | #64 : $sl(1 3)^{(4)}, sl(3)$                                 |
| #65 : $osp(1 4), sl(3)$                                       | #66 : $osp(1 2)^{(1)}, sl(3)$                                |
| #67 : $osp(1 4), sp(4), sl(1 3)^{(4)}$                        | #68 : $osp(1 4), osp(1 2)^{(1)}, sp(4)$                      |
| #69 : $sl(1 3)^{(4)}, sl(2)^{(1)}$                            | #70 : $osp(1 4), sl(2)^{(1)}$                                |
| #71 : $osp(1 2)^{(1)}, sl(2)^{(1)}$                           | #72 : $osp(2 2)^{(2)}, sl(1 3)^{(4)}$                        |
| #73 : $osp(2 2)^{(2)}, osp(1 4)$                              | #74 : $osp(2 2)^{(2)}, osp(1 2)^{(1)}$                       |
| #75 : $osp(2 2)^{(2)}$  | #76 : $sl(1 2), sl(3)$                                       |
| #77 : $osp(2 2), sl(3)$                                       | #78 : $osp(3 2), sl(3)$                                      |
| #79 : $sl(1 2), sl(2)^{(1)}$                                  | #80 : $osp(2 2), sl(2)^{(1)}$                                |
| #81 : $osp(3 2), sl(2)^{(1)}$                                 | #82 : $so(5), sl(1 2), osp(3 2)$                             |
| #83 : $sp(4), sl(1 2), osp(2 2)$                              | #84 : $sl(3)^{(2)}, osp(3 2), osp(2 2)$                      |
| #85 : $osp(3 2), sl(1 2)$                                     | #86 : $osp(2 2), sl(1 2)$                                    |
| #87 : $osp(3 2), sl(1 2)$                                     |  |

## Rank 4 hyperbolic superalgebras

- #1 :  $osp(1|4)^{(1)}$ ,  $sl(2) \oplus osp(1|4)$ ,  $sl(3) \oplus osp(1|2)$ ,  $so(7)$
- #2 :  $osp(1|4)^{(1)}$ ,  $sl(2) \oplus osp(1|4)$ ,  $so(5) \oplus osp(1|2)$ ,  $sl(5)^{(2)}$
- #3 :  $osp(1|4)^{(1)}$ ,  $sl(2) \oplus osp(1|4)$ ,  $sp(4) \oplus osp(1|2)$ ,  $sl(4)^{(2)}$
- #4 :  $sl(1|5)^{(4)}$ ,  $sl(2) \oplus osp(1|4)$ ,  $sl(3) \oplus osp(1|2)$ ,  $sp(6)$
- #5 :  $sl(1|5)^{(4)}$ ,  $sl(2) \oplus osp(1|4)$ ,  $sp(4) \oplus osp(1|2)$ ,  $sp(4)^{(1)}$
- #6 :  $sl(1|5)^{(4)}$ ,  $sl(2) \oplus osp(1|4)$ ,  $sp(4) \oplus osp(1|2)$ ,  $sl(5)^{(2)}$
- #7 :  $sl(1|4)^{(2)}$ ,  $sl(2) \oplus osp(1|4)$ ,  $sl(3) \oplus sl(2)$ ,  $osp(1|6)$
- #8 :  $sl(1|4)^{(2)}$ ,  $sl(2) \oplus osp(1|4)$ ,  $sp(4) \oplus sl(2)$ ,  $osp(1|4)^{(1)}$
- #9 :  $sl(1|4)^{(2)}$ ,  $sl(2) \oplus osp(1|4)$ ,  $sp(4) \oplus sl(2)$ ,  $sl(1|5)^{(4)}$
- #10 :  $osp(1|4)^{(1)}$ ,  $osp(1|2) \oplus osp(1|4)$ ,  $sl(1|5)^{(4)}$
- #11 :  $osp(2|4)^{(2)}$ ,  $sl(2) \oplus osp(1|4)$ ,  $osp(1|4) \oplus osp(1|2)$ ,  $sl(1|4)^{(2)}$
- #12 :  $osp(2|4)$ ,  $sl(2) \oplus sl(1|2)$ ,  $sp(4) \oplus sl(1|1)$ ,  $sl(5)^{(2)}$
- #13 :  $osp(2|4)$ ,  $sl(2) \oplus sl(1|2)$ ,  $so(5) \oplus sl(1|1)$ ,  $sl(4)^{(2)}$
- #14 :  $osp(5|2)$ ,  $sl(2) \oplus sl(1|2)$ ,  $sp(4) \oplus sl(1|1)$ ,  $sp(4)^{(1)}$
- #15 :  $osp(5|2)$ ,  $sl(2) \oplus sl(1|2)$ ,  $sl(3) \oplus sl(1|1)$ ,  $sp(6)$
- #16 :  $osp(5|2)$ ,  $sl(2) \oplus sl(1|2)$ ,  $sp(4) \oplus sl(1|1)$ ,  $sl(5)^{(2)}$
- #17 :  $osp(1|4)^{(1)}$ ,  $sl(1|1) \oplus osp(1|4)$ ,  $sl(1|2) \oplus osp(1|2)$ ,  $osp(5|2)$
- #18 :  $sl(1|5)^{(4)}$ ,  $sl(1|1) \oplus osp(1|4)$ ,  $sl(1|2) \oplus osp(1|2)$ ,  $osp(2|4)$
- #19 :  $sl(1|4)^{(2)}$ ,  $sl(1|1) \oplus osp(1|4)$ ,  $sl(1|2) \oplus sl(2)$ ,  $osp(3|4)$
- #20 :  $sl(1|3)$ ,  $sl(2) \oplus sl(1|2)$ ,  $G_2 \oplus sl(1|1)$ ,  $D_4^{(3)}$
- #21 :  $sl(1|3)$ ,  $sl(2) \oplus sl(1|2)$ ,  $G_2 \oplus sl(1|1)$ ,  $G_2^{(1)}$
- #22 :  $G(3)$ ,  $sl(2) \oplus sl(1|2)$ ,  $sl(3) \oplus sl(1|1)$ ,  $G_2^{(1)}$
- #23 :  $osp(4|2)$ ,  $sl(2) \oplus osp(2|2)$ ,  $G_2 \oplus sl(2)$ ,  $G(3)$
- #24 :  $osp(3|4)$ ,  $sl(2) \oplus osp(3|2)$ ,  $G_2 \oplus sl(2)$ ,  $G(3)$
- #25 :  $sl(2|2)$ ,  $sl(2) \oplus sl(1|2)$ ,  $G_2 \oplus sl(2)$ ,  $G(3)$
- #26 :  $osp(1|6)$ ,  $sl(2) \oplus osp(1|4)$ ,  $G_2 \oplus osp(1|2)$ ,  $G_2^{(1)}$
- #27 :  $osp(1|6)$ ,  $sl(2) \oplus osp(1|4)$ ,  $G_2 \oplus osp(1|2)$ ,  $D_4^{(3)}$
- #28 :  $osp(5|2)$ ,  $sl(2) \oplus osp(3|2)$ ,  $G_2 \oplus osp(1|2)$ ,  $G(3)$
- #29 :  $sp(6)$ ,  $sl(1|1) \oplus 2 sl(2)$ ,  $sl(1|3)$ ,  $osp(2|4)$
- #30 :  $so(7)$ ,  $sl(1|1) \oplus 2 sl(2)$ ,  $sl(1|3)$ ,  $osp(5|2)$
- #31 :  $osp(1|6)$ ,  $osp(1|2) \oplus 2 sl(2)$ ,  $sp(6)$ ,  $osp(1|4)^{(1)}$
- #32 :  $osp(1|6)$ ,  $osp(1|2) \oplus 2 sl(2)$ ,  $so(7)$ ,  $sl(1|5)^{(4)}$
- #33 :  $osp(5|2)$ ,  $sl(1|1) \oplus 2 sl(2)$ ,  $sl(4)^{(2)}$
- #34 :  $osp(2|4)$ ,  $sl(1|1) \oplus 2 sl(2)$ ,  $sp(4)^{(1)}$
- #35 :  $osp(2|4)$ ,  $sl(1|1) \oplus 2 sl(2)$ ,  $osp(5|2)$ ,  $sl(5)^{(2)}$
- #36 :  $G(3)$ ,  $sl(1|1) \oplus 2 sl(2)$ ,  $sl(1|3)$ ,  $D_4^{(3)}$
- #37 :  $osp(3|4)$ ,  $osp(1|2) \oplus sl(1|1) \oplus sl(2)$ ,  $sl(1|3)$ ,  $osp(1|6)$
- #38 :  $osp(3|4)$ ,  $osp(1|2) \oplus sl(1|1) \oplus sl(2)$ ,  $osp(2|4)$ ,  $osp(1|4)^{(1)}$
- #39 :  $osp(3|4)$ ,  $osp(1|2) \oplus sl(1|1) \oplus sl(2)$ ,  $osp(5|2)$ ,  $sl(1|5)^{(4)}$
- #40 :  $osp(3|4)$ ,  $2 osp(1|2) \oplus sl(1|1)$ ,  $osp(2|4)^{(2)}$
- #41 :  $sl(1|5)^{(2)}$ ,  $osp(1|2) \oplus 2 sl(2)$ ,  $sl(4)^{(2)}$
- #42 :  $osp(1|4)^{(1)}$ ,  $osp(1|2) \oplus 2 sl(2)$ ,  $sp(4)^{(1)}$
- #43 :  $osp(1|4)^{(1)}$ ,  $osp(1|2) \oplus 2 sl(2)$ ,  $sl(1|5)^{(4)}$ ,  $sl(5)^{(2)}$
- #44 :  $sl(1|4)^{(2)}$ ,  $3 sl(2)$
- #45 :  $osp(1|6)$ ,  $2 osp(1|2) \oplus sl(2)$ ,  $sl(1|5)^{(4)}$

- #46 :  $osp(1|4)^{(1)}$ ,  $2 osp(1|2) \oplus sl(2)$ ,  $sl(1|5)^{(4)}$   
 #47 :  $osp(2|4)^{(2)}$ ,  $2 osp(1|2) \oplus sl(2)$ ,  $sl(1|5)^{(4)}$   
 #48 :  $sl(1|5)^{(4)}$ ,  $3 osp(1|2)$   
 #49 :  $sl(1|3)$ ,  $sl(2) \oplus sl(3)$ ,  $sl(1|2) \oplus sl(2)$ ,  $osp(4|2)$   
 #50 :  $osp(5|2)$ ,  $sl(2) \oplus so(5)$ ,  $sl(1|2) \oplus sl(2)$ ,  $osp(4|2)$   
 #51 :  $osp(2|4)$ ,  $sl(2) \oplus sp(4)$ ,  $sl(1|2) \oplus sl(2)$ ,  $osp(4|2)$   
 #52 :  $G(3)$ ,  $sl(2) \oplus G_2$ ,  $sl(1|2) \oplus sl(2)$ ,  $osp(4|2)$   
 #53 :  $osp(3|4)$ ,  $sl(2) \oplus osp(1|4)$ ,  $sl(1|2) \oplus osp(1|2)$ ,  $osp(4|2)$   
 #54 :  $osp(4|2)$ ,  $3 sl(2)$   
 #55 :  $sl(1|3)$ ,  $sl(2) \oplus 2 sl(1|1)$ ,  $sl(2|2)$   
 #56 :  $osp(2|4)$ ,  $sl(2) \oplus 2 sl(1|1)$ ,  $sl(2|2)$   
 #57 :  $osp(5|2)$ ,  $sl(2) \oplus 2 sl(1|1)$ ,  $sl(2|2)$   
 #58 :  $G(3)$ ,  $sl(2) \oplus 2 sl(1|1)$ ,  $sl(2|2)$   
 #59 :  $sl(1|2)^{(1)}$ ,  $sl(1|2) \oplus sl(2)$ ,  $sl(1|3)$   
 #60 :  $sl(1|2)^{(1)}$ ,  $sl(1|2) \oplus sl(2)$ ,  $osp(2|4)$   
 #61 :  $sl(1|2)^{(1)}$ ,  $sl(1|2) \oplus sl(2)$ ,  $osp(5|2)$   
 #62 :  $sl(1|2)^{(1)}$ ,  $sl(1|2) \oplus sl(2)$ ,  $G(3)$   
 #63 :  $sl(3)^{(1)}$ ,  $sl(3) \oplus sl(1|1)$ ,  $sl(1|3)$   
 #64 :  $sl(3)^{(1)}$ ,  $sl(3) \oplus osp(1|2)$ ,  $osp(1|6)$   
 #65 :  $osp(2|4)$ ,  $osp(2|2) \oplus sl(2)$ ,  $G(3)$   
 #66 :  $sl(1|4)^{(2)}$ ,  $osp(1|4)^{(1)}$ ,  $sl(4)^{(2)}$   
 #67 :  $sl(1|4)^{(2)}$ ,  $sl(1|5)^{(4)}$ ,  $sp(4)^{(1)}$   
 #68 :  $sl(1|4)^{(2)}$ ,  $osp(2|4)^{(2)}$   
 #69 :  $sl(1|4)^{(2)}$ ,  $osp(1|6)$ ,  $sl(4)$   
 #70 :  $sl(4)$ ,  $sl(1|3)$ ,  $sl(2|2)$   
 #71 :  $sp(4)^{(1)}$ ,  $osp(5|2)$ ,  $osp(4|2)$   
 #72 :  $sl(4)^{(2)}$ ,  $osp(2|4)$ ,  $osp(4|2)$   
 #73 :  $sl(1|4)^{(2)}$ ,  $sl(2|2)$ ,  $osp(3|4)$

### Rank 5 hyperbolic superalgebras

- #1 :  $so(9)$ ,  $sl(4) \oplus sl(1|1)$ ,  $sl(3) \oplus sl(1|2)$ ,  $osp(2|4) \oplus sl(2)$ ,  $F(4)$   
 #2 :  $osp(7|2)$ ,  $sl(2) \oplus sl(1|3)$ ,  $sl(3) \oplus sl(1|2)$ ,  $sp(6) \oplus sl(1|1)$ ,  $F_4$   
 #3 :  $osp(7|2)$ ,  $sl(1|3) \oplus sl(1|1)$ ,  $2 sl(1|2)$ ,  $osp(2|4) \oplus sl(1|1)$ ,  $F(4)$   
 #4 :  $osp(4|4)$ ,  $sl(2|2) \oplus sl(2)$ ,  $sl(3) \oplus sl(1|2)$ ,  $so(7) \oplus sl(2)$ ,  $F(4)$   
 #5 :  $sl(7)^{(2)}$ ,  $sp(6) \oplus sl(1|1)$ ,  $sp(4) \oplus sl(1|2)$ ,  $osp(2|4) \oplus sl(2)$ ,  $F(4)$   
 #6 :  $so(8)^{(2)}$ ,  $so(7) \oplus sl(1|1)$ ,  $so(5) \oplus sl(1|2)$ ,  $osp(2|4) \oplus sl(2)$ ,  $F(4)$   
 #7 :  $sl(2|4)^{(2)}$ ,  $osp(4|2) \oplus sl(2)$ ,  $osp(2|2) \oplus sl(3)$ ,  $so(7) \oplus sl(2)$ ,  $F(4)$   
 #8 :  $osp(3|4)^{(1)}$ ,  $osp(3|4) \oplus sl(2)$ ,  $osp(3|2) \oplus sl(3)$ ,  $so(7) \oplus sl(2)$ ,  $F(4)$   
 #9 :  $osp(1|6)^{(1)}$ ,  $osp(1|6) \oplus sl(2)$ ,  $osp(1|4) \oplus sl(3)$ ,  $osp(1|2) \oplus so(7)$ ,  $F_4$   
 #10 :  $sl(1|7)^{(4)}$ ,  $osp(1|6) \oplus sl(2)$ ,  $osp(1|4) \oplus sl(3)$ ,  $osp(1|2) \oplus sp(6)$ ,  $F_4$   
 #11 :  $sl(1|7)^{(4)}$ ,  $osp(1|6) \oplus sl(1|1)$ ,  $osp(1|4) \oplus sl(1|2)$ ,  $osp(2|4) \oplus osp(1|2)$ ,  $F(4)$   
 #12 :  $sl(5|2)^{(2)}$ ,  $osp(5|2) \oplus sl(2)$ ,  $osp(3|2) \oplus sl(3)$ ,  $so(7) \oplus osp(1|2)$ ,  $F(4)$   
 #13 :  $F_4$ ,  $so(7) \oplus sl(1|1)$ ,  $sl(3) \oplus sl(1|2)$ ,  $sl(2) \oplus sl(1|3)$ ,  $osp(2|6)$   
 #14 :  $so(7)^{(1)}$ ,  $so(7) \oplus osp(1|2)$ ,  $osp(1|4) \oplus 2 sl(2)$ ,  $osp(1|8)$ ,  $sl(1|7)^{(4)}$   
 #15 :  $sl(6)^{(2)}$ ,  $sp(6) \oplus osp(1|2)$ ,  $osp(1|4) \oplus 2 sl(2)$ ,  $osp(1|8)$ ,  $osp(1|6)^{(1)}$   
 #16 :  $sl(1|6)^{(2)}$ ,  $osp(1|6) \oplus sl(2)$ ,  $sl(3) \oplus sl(2) \oplus osp(1|2)$ ,  $sl(5)$ ,  $osp(1|8)$   
 #17 :  $sl(1|6)^{(2)}$ ,  $osp(1|6) \oplus sl(2)$ ,  $sp(4) \oplus osp(1|2) \oplus sl(2)$ ,  $sp(8)$ ,  $osp(1|6)^{(1)}$   
 #18 :  $sl(1|6)^{(2)}$ ,  $osp(1|6) \oplus sl(2)$ ,  $so(5) \oplus osp(1|2) \oplus sl(2)$ ,  $so(9)$ ,  $sl(1|7)^{(4)}$   
 #19 :  $sl(1|6)^{(2)}$ ,  $osp(1|6) \oplus osp(1|2)$ ,  $osp(1|4) \oplus osp(1|2) \oplus sl(2)$ ,  $osp(1|8)$ ,  $osp(2|6)^{(2)}$   
 #20 :  $sl(1|6)^{(2)}$ ,  $osp(1|6) \oplus sl(1|1)$ ,  $sl(1|2) \oplus osp(1|2) \oplus sl(2)$ ,  $sl(1|4)$ ,  $osp(3|6)$   
 #21 :  $osp(6|2)$ ,  $osp(1|2) \oplus sl(1|3)$ ,  $osp(1|4) \oplus sl(1|1) \oplus sl(2)$ ,  $osp(1|8)$ ,  $osp(3|6)$   
 #22 :  $osp(6|2)$ ,  $sl(2) \oplus sl(1|3)$ ,  $sl(3) \oplus sl(2) \oplus sl(1|1)$ ,  $sl(5)$ ,  $sl(1|4)$   
 #23 :  $osp(6|2)$ ,  $sl(1|3) \oplus sl(1|1)$ ,  $sl(1|2) \oplus sl(1|1) \oplus sl(2)$ ,  $sl(1|4)$ ,  $sl(2|3)$   
 #24 :  $sl(6)^{(2)}$ ,  $sp(6) \oplus sl(1|1)$ ,  $sl(1|2) \oplus 2 sl(2)$ ,  $sl(1|4)$ ,  $osp(2|6)$   
 #25 :  $so(7)^{(1)}$ ,  $so(7) \oplus sl(1|1)$ ,  $sl(1|2) \oplus 2 sl(2)$ ,  $sl(1|4)$ ,  $osp(7|2)$

#26 :  $osp(6|2)$ ,  $sl(2) \oplus sl(1|3)$ ,  $sp(4) \oplus sl(2) \oplus sl(1|1)$ ,  $sp(8)$ ,  $osp(2|6)$   
 #27 :  $osp(6|2)$ ,  $sl(2) \oplus sl(1|3)$ ,  $so(5) \oplus sl(2) \oplus sl(1|1)$ ,  $so(9)$ ,  $osp(7|2)$   
 #28 :  $sl(4)^{(1)}$ ,  $sl(4) \oplus sl(1|1)$ ,  $sl(1|4)$ ,  $osp(6|2)$   
 #29 :  $sl(1|3)^{(1)}$ ,  $sl(1|3) \oplus sl(2)$ ,  $sl(1|4)$ ,  $osp(6|2)$   
 #30 :  $sl(2|4)^{(2)}$ ,  $osp(2|4) \oplus sl(2)$ ,  $osp(4|4)$ ,  $osp(2|4)^{(1)}$   
 #31 :  $sl(2|4)^{(2)}$ ,  $osp(2|4) \oplus sl(2)$ ,  $osp(5|4)$ ,  $sl(5|2)^{(2)}$   
 #32 :  $sl(2|4)^{(2)}$ ,  $osp(2|4) \oplus osp(1|2)$ ,  $osp(5|4)$ ,  $osp(3|4)^{(1)}$   
 #33 :  $sl(4)^{(1)}$ ,  $sl(4) \oplus osp(1|2)$ ,  $sl(1|6)^{(2)}$ ,  $osp(1|8)$   
 #34 :  $sl(2|4)^{(2)}$ ,  $osp(2|4) \oplus sl(2)$ ,  $sl(2|3)$ ,  $osp(2|6)$   
 #35 :  $so(8)$ ,  $osp(1|2) \oplus 3 sl(2)$ ,  $sl(1|6)^{(2)}$   
 #36 :  $F(4)$ ,  $osp(2|2) \oplus sl(3)$ ,  $osp(2|4) \oplus sl(2)$ ,  $osp(2|4)^{(1)}$   
 #37 :  $F(4)$ ,  $sl(1|2) \oplus 2 sl(2)$ ,  $sl(4) \oplus sl(1|1)$ ,  $so(7)^{(1)}$   
 #38 :  $so(8)$ ,  $osp(6|2)$ ,  $sl(1|1) \oplus 3 sl(2)$

### Rank 6 hyperbolic superalgebras

#1 :  $F_4^{(1)}$ ,  $sl(1|1) \oplus F_4$ ,  $sl(1|2) \oplus sp(6)$ ,  $sl(1|3) \oplus sl(3)$ ,  $sl(1|4) \oplus sl(2)$ ,  $osp(9|2)$   
 #2 :  $E_6^{(2)}$ ,  $sl(1|1) \oplus F_4$ ,  $sl(1|2) \oplus so(7)$ ,  $sl(1|3) \oplus sl(3)$ ,  $sl(1|4) \oplus sl(2)$ ,  $osp(2|8)$   
 #3 :  $F_4^{(1)}$ ,  $osp(1|2) \oplus F_4$ ,  $osp(1|4) \oplus sp(6)$ ,  $osp(1|6) \oplus sl(3)$ ,  $osp(1|8) \oplus sl(2)$ ,  $sl(1|9)^{(4)}$   
 #4 :  $E_6^{(2)}$ ,  $osp(1|2) \oplus F_4$ ,  $osp(1|4) \oplus so(7)$ ,  $osp(1|6) \oplus sl(3)$ ,  $osp(1|8) \oplus sl(2)$ ,  $osp(1|8)^{(1)}$   
 #5 :  $so(10)$ ,  $sl(1|1) \oplus sl(5)$ ,  $sl(1|2) \oplus sl(3) \oplus sl(2)$ ,  $sl(1|4) \oplus sl(2)$ ,  $osp(8|2)$ ,  $sl(1|5)$   
 #6 :  $osp(8|2)$ ,  $sl(1|1) \oplus sl(1|4)$ ,  $sl(2) \oplus 2 sl(1|2)$ ,  $sl(2|4)$   
 #7 :  $sl(8)^{(2)}$ ,  $sl(1|1) \oplus sp(8)$ ,  $sl(1|2) \oplus sl(2) \oplus sp(4)$ ,  $sl(1|4) \oplus sl(2)$ ,  $osp(8|2)$ ,  $osp(2|8)$   
 #8 :  $so(9)^{(1)}$ ,  $sl(1|1) \oplus so(9)$ ,  $sl(1|2) \oplus sl(2) \oplus so(5)$ ,  $sl(1|4) \oplus sl(2)$ ,  $osp(8|2)$ ,  $osp(9|2)$   
 #9 :  $so(10)$ ,  $osp(1|2) \oplus sl(5)$ ,  $sl(2) \oplus sl(3) \oplus osp(1|4)$ ,  $sl(2) \oplus osp(1|8)$ ,  $sl(1|8)^{(2)}$ ,  $osp(1|10)$   
 #10 :  $so(9)^{(1)}$ ,  $osp(1|2) \oplus so(9)$ ,  $osp(1|4) \oplus sl(2) \oplus so(5)$ ,  $osp(1|8) \oplus sl(2)$ ,  $sl(1|8)^{(2)}$ ,  $sl(1|9)^{(4)}$   
 #11 :  $sl(8)^{(2)}$ ,  $osp(1|2) \oplus sp(8)$ ,  $osp(1|4) \oplus sl(2) \oplus sp(4)$ ,  $osp(1|8) \oplus sl(2)$ ,  $sl(1|8)^{(2)}$ ,  $osp(1|8)^{(1)}$   
 #12 :  $sl(1|8)^{(2)}$ ,  $osp(1|2) \oplus osp(1|8)$ ,  $osp(1|4) \oplus sl(2) \oplus osp(1|4)$ ,  $osp(2|8)^{(2)}$   
 #13 :  $sl(1|8)^{(2)}$ ,  $sl(1|1) \oplus osp(1|8)$ ,  $sl(1|2) \oplus sl(2) \oplus osp(1|4)$ ,  $sl(1|4) \oplus osp(1|2)$ ,  $osp(8|2)$ ,  $osp(3|8)$   
 #14 :  $so(8)^{(1)}$ ,  $sl(1|1) \oplus so(8)$ ,  $sl(1|2) \oplus 3 sl(2)$ ,  $osp(8|2)$   
 #15 :  $so(8)^{(1)}$ ,  $osp(1|2) \oplus so(8)$ ,  $osp(1|4) \oplus 3 sl(2)$ ,  $sl(1|8)^{(2)}$

## References

- [1] V.G. Kac, *Infinite-dimensional Lie algebras*, 3rd edition, Cambridge University Press (1994).
- [2] C. Saclioglu, *Dynkin diagrams for hyperbolic Kac–Moody Algebras*, J. Phys. A: Math. Gen. **22** (1989) 3753.
- [3] L. Wanglai, *Classification of generalized Cartan matrices of hyperbolic type*, Chin. Ann. Math. **9B** (1988) 68.
- [4] R.W. Gebert, H. Nicolai, P.C. West, *Multistring vertices and hyperbolic Kac–Moody algebras*, Int. J. Mod. Phys. **A11** (1996) 429.
- [5] J.A. Harvey, G.W. Moore, *Algebras, BPS states and strings*, Nucl. Phys. **B463** (1996) 315.
- [6] T. Damour, M. Henneaux, H. Nicolai, *Cosmological billiards*, Class. Quant. Grav. **20** (2003) R145.
- [7] A. Kleinschmidt, N. Nicolai,  *$E(10)$  and  $SO(9, 9)$  invariant supergravity*, JHEP 0407 (2004) 041.
- [8] V.G. Kac, *Lie superalgebras*, Adv. Math. **26** (1977) 8.
- [9] V.G. Kac, *Infinite dimensional algebras, Dedekind’s  $\eta$ -function, classical Möbius function and the very strange formula*, Adv. Math. **30** (1978) 85.
- [10] J.W. Van der Leur, *Contragredient Lie superalgebras of finite growth*, thesis, Utrecht University (1985); short version in Commun. Alg. **17** (1989) 1815.
- [11] L.K. Tripathy, B. Das, K.C. Pati, *Dynkin diagrams of hyperbolic Kac–Moody superalgebras*, J. Phys. A: Math. Gen. **36** (2003) 2087.
- [12] L. Frappat, A. Sciarrino, P. Sorba, *Dictionary on Lie algebras and superalgebras*, Academic Press (2000), London.
- [13] D.A. Leites, V.V. Serganova, *Defining relations for classical Lie superalgebras*, Proceedings of the Euler IMI conference on quantum groups, Leningrad (1990).
- [14] M. Scheunert, *The presentation and  $q$ -deformation of special linear Lie superalgebras*, J. Math. Phys. **34** (1993) 3780.
- [15] H. Yamane, *Quantized enveloping algebras associated to simple and affine Lie superalgebras*, Proceedings of the XXth ICGTMP, Toyonaka (1994); World Scientific, Singapore (1995).
- [16] D.A. Leites, M.V. Saveliev, V.V. Serganova, *Embeddings of Lie superalgebra  $osp(1|2)$  and the associated nonlinear supersymmetric equations*, in Group theoretical methods in physics, M.A. Markov, V.I. Man’ko and V.V. Dodonov (eds.), p. 255, VUN Science Press, Utrecht, The Netherlands (1986).
- [17] V.G. Kac, *Simple irreducible graded Lie algebras of finite*, Math. USSR Izvestija **2** (1968) 1271.
- [18] P. Grozman, D.A. Leites, *Defining relations for Lie superalgebras with Cartan matrix*, hep-th/9702073.