

Calabi-Yau Moduli Space, Mirror Manifolds and Spacetime Topology Change in String Theory

Paul S. Aspinwall,[†] Brian R. Greene[#] and David R. Morrison^{*}

We analyze the moduli spaces of Calabi-Yau threefolds and their associated conformally invariant nonlinear σ -models and show that they are described by an unexpectedly rich geometrical structure. Specifically, the Kähler sector of the moduli space of such Calabi-Yau conformal theories admits a decomposition into adjacent domains some of which correspond to the (complexified) Kähler cones of topologically distinct manifolds. These domains are separated by walls corresponding to singular Calabi-Yau spaces in which the spacetime metric has degenerated in certain regions. We show that the union of these domains is isomorphic to the complex structure moduli space of a *single* topological Calabi-Yau space — the mirror. In this way we resolve a puzzle for mirror symmetry raised by the apparent *asymmetry* between the Kähler and complex structure moduli spaces of a Calabi-Yau manifold. Furthermore, using mirror symmetry, we show that we can interpolate in a physically smooth manner between *any* two theories represented by distinct points in the Kähler moduli space, even if such points correspond to topologically distinct spaces. Spacetime topology change in string theory, therefore, is realized by the most basic operation of deformation by a truly marginal operator. Finally, this work also yields some important insights on the nature of orbifolds in string theory.

8/93

[†] School of Natural Sciences, Institute for Advanced Study, Princeton, NJ 08540.

[#] F.R. Newman Laboratory of Nuclear Studies, Cornell University, Ithaca, NY 14853.

^{*} School of Mathematics, Institute for Advanced Study, Princeton, NJ 08540. On leave from: Department of Mathematics, Duke University, Box 90320, Durham, NC 27708.

1. Introduction

Over the years, research on string theory has followed two main paths. One such path has been the attempt to extract detailed and specific low energy models from string theory in an attempt to make contact with observable physics. A wealth of research towards this end has shown conclusively that string theory contains within it all of the ingredients essential to building the standard model and that, if we are maximally optimistic about those things we do not understand at present, fairly realistic low energy models can be constructed. The second research path has focused on those properties of the theory which are generic to all models based on strings and which are difficult, if not impossible, to accommodate in a theory based on point particles. Such properties single out characteristic “stringy” phenomena and hence constitute the true distinguishing features of string theory. With our present inability to extract definitive low energy predictions from string theory, there is strong motivation to study these generic features.

One such feature was identified some time ago in the work of [1]. These authors showed that whereas point particle theories appear to require a smooth background spacetime, string theory is well defined in the presence of a certain class of spacetime singularities: toroidal quotient singularities. Another characteristically stringy feature is that of mirror symmetry and mirror manifolds. Mirror symmetry was conjectured based upon naturality arguments in [2,3], was strongly suggested by the computer studies of [4], and was established to exist in certain cases by direct construction in [5]. The phenomenon of mirror manifolds shows that vastly different spacetime backgrounds can give rise to identical physics — something quite unexpected in nonstring based theories such as general relativity and Kaluza-Klein theory. The present work is a natural progression along these lines of research. By using mirror symmetry we show, amongst other things, that the topology of spacetime can change by passing through a mathematically singular space while the physics of string theory is perfectly well behaved.

From a more general vantage point, the present work focuses on the structure of the moduli spaces of Calabi-Yau manifolds and their associated superconformal nonlinear σ -models. There has been much work on this subject over the last few years [6], mainly focusing on local properties. The burden of the sequel is to show that an investigation of more global properties reveals a remarkably rich structure. As we shall see, whereas previous studies [6] have, as a prime example, considered the local geometry of the complexified Kähler cone for a Calabi-Yau space of a fixed topology, we find that a more global perspective shows that numerous such Kähler cones for topologically distinct Calabi-Yau spaces

(and other more exotic entities to be discussed) fit together by adjoining along common walls to form what we term the *enlarged Kähler moduli space*. The common walls of these Kähler cones correspond to metrically degenerate Calabi-Yau spaces in which some homologically nontrivial cycle has zero volume. In other words, points in these walls correspond to a configuration in which some nontrivial subvariety of the Calabi-Yau space (or, in fact, the whole Calabi-Yau itself!) is shrunk down to a point. Nonetheless, we show, by making use of mirror symmetry, that a generic point in such a wall corresponds to a perfectly well behaved conformal field theory. In fact, the generic point in such a wall has *no special significance* from the point of view of conformal field theory and hence none from the point of view of physics. As is familiar from previous studies, one can move around a path in moduli space by changing the expectation value of truly marginal operators. We show that a typical path passes through these walls without any unusual physical consequence. Hence, this makes it evident that it is physically incomplete to study a single Kähler cone.

There are four main implications of this newfound need to pass from a single complexified Kähler cone to the enlarged Kähler moduli space:

1) Mirror symmetry, combined with standard reasoning from conformal field theory, leads one to the conclusion that if X and Y are a mirror pair of Calabi-Yau spaces then the complexified Kähler moduli space of X is isomorphic to the complex structure moduli space of Y and vice versa [5]. This is a puzzling statement mathematically because a complexified Kähler moduli space is a bounded domain (as we shall discuss this is due to the usual constraints that the Kähler form should yield positive volumes) whereas a complex structure moduli space is not bounded, but is rather of the form $A - B$ with A and B subvarieties of some projective space [7]. The present work shows that the true object which is mirror to a complex structure moduli space is not a single complexified Kähler cone, but rather the enlarged Kähler moduli space introduced above. We show that the latter has an identical mathematical description (using toric geometry) as the mirror's complex structure moduli space, thus resolving this important issue.

2) In the example considered in [8] and discussed in greater detail here, the enlarged Kähler moduli space consists of 100 distinct regions. In the more familiar example of the mirror of the quintic hypersurface, we expect the number of regions in the enlarged Kähler moduli space to be far greater – possibly many orders of magnitude greater – than in the example studied here. An important question is to give the physical interpretation of the theories in each region. In [8] we found that five of the 100 regions in our example were

interpretable as the complexified Kähler moduli spaces of five topologically distinct Calabi-Yau spaces related by the operation of *flopping* [9,10]. We will review this shortly. What about the other 95 regions? We will postpone a detailed answer to this question to section VI and also to a forthcoming paper, but there is one essential point worthy of emphasis here. Some of these regions correspond to Calabi-Yau spaces with orbifold singularities (similar to those studied in [1] except that the covering space is a nontoroidal Calabi-Yau space). Conventional wisdom and detailed analyses have always considered such orbifolds to be “boundary points in Calabi-Yau moduli space”. This implies, in particular, that smooth Calabi-Yau theories are represented by the generic points in moduli space while orbifold theories are special isolated points. It also implies that by giving any nonzero expectation value to “blow-up modes” in the orbifold theory, we move from the orbifold theory to a smooth Calabi-Yau theory. The present work shows that these interpretations of the orbifold results are misleading. Rather, it is better to think of orbifold theories as occupying their own *regions* in the enlarged Kähler moduli space and hence they are just as generic as smooth Calabi-Yau theories, which simply correspond to other regions. Furthermore, these orbifold regions are adjacent to smooth Calabi-Yau regions, but turning on expectation values for twist fields does not immediately resolve the singularities and move one into the Calabi-Yau region. Rather, one must traverse the orbifold region by turning on an expectation value for a twist field until one reaches a wall of the smooth Calabi-Yau region. Then, if one goes further (for which there is no physical obstruction) one enters the region of smooth Calabi-Yau theories. This is a significant departure from the hitherto espoused description of orbifolds in string theory.

3) In the mirror manifold construction of [5], typically both the original Calabi-Yau space and its mirror are singular. Quite generally, there is more than one way of repairing these singularities to yield a smooth Calabi-Yau manifold, and the resulting smooth spaces can be topologically distinct. A natural question is: is one or some subset of these possible desingularizations (which are on equal footing mathematically) singled out by string theory, or are all possible desingularizations realized by physical models? We show that each possible desingularization to a smooth Calabi-Yau manifold has its own region in the fully enlarged Kähler moduli space. (In fact, these particular regions constitute what we call the *partially* enlarged Kähler moduli space.)

4) As remarked earlier, and as will be one of our main foci, the present work establishes the veracity of the long suspected belief that string theory admits physically smooth processes which can result in a change of the topology of spacetime. Some of the regions

in the enlarged Kähler moduli space correspond to the complexified Kähler cones of topologically distinct smooth Calabi-Yau manifolds. Since we show that there is no physical obstruction to deforming our theories by truly marginal operators which take us smoothly from one region to another, we see that we can change the topology of spacetime in a physically smooth manner. Furthermore, there is nothing at all exotic about such processes. They correspond to the most basic kind of deformation to which one can subject a conformal field theory. This should be contrasted to the situation where one can change the topology of a Calabi-Yau manifold by passing through a *conifold* point in the moduli space as studied in [11]. In such a process one necessarily encounters singularities.

Our approach to establishing these results [8], as mentioned, relies heavily on properties of mirror manifolds originally established in [5]. These will be reviewed in the next section. Basically, mirror symmetry has established that a given conformal field theory may have more than one geometrical realization as a nonlinear σ -model with a Calabi-Yau target space. Two *totally different* Calabi-Yau spaces can give rise to isomorphic conformal theories (with the isomorphism being given by a change of sign of a certain charge). One important implication of this result is that any physical observable in the underlying conformal theory has two geometrical interpretations — one on each of the associated Calabi-Yau spaces. Furthermore, a one parameter family of conformal field theories of this sort likewise has two geometrical interpretations in terms of a family of Calabi-Yau spaces and in terms of a mirror family of Calabi-Yau spaces. The mirror manifold phenomenon can be an extremely powerful physical tool because certain questions which are hard to analyze in one geometrical interpretation are far easier to address on the mirror. For instance, as shown in [5], certain observables which have an extremely complicated geometrical realization on one of the Calabi-Yau spaces (involving an infinite series of instanton corrections, for example) have an equally simple geometrical interpretation on the mirror Calabi-Yau space (involving a single calculable integral over the space).

For the question of topology change, and more generally, the question of the structure of Calabi-Yau moduli space, we make use of mirror manifolds in the following way. The picture we are presenting implies that under mirror symmetry the complex structure moduli space of Y is mapped to the *enlarged* Kähler moduli space of X (and vice versa). From this we conclude that for any point in the enlarged Kähler moduli space of X we can find a corresponding point in the complex structure moduli space of Y such that correlation functions of corresponding observables are identically equal since these points should correspond to isomorphic conformal theories. By choosing representative points which lie

in distinct regions of the enlarged Kähler moduli space of X , the veracity of the latter statement provides an extremely sensitive test of the picture we are presenting. In [8] as amplified upon here, we showed that this prediction could be explicitly verified in a nontrivial example.

The picture of topology change, therefore, as discussed in [8] and here can be summarized as follows. We consider a one parameter family of conformal field theories which have a mirror manifold realization. On one of these two families of Calabi-Yau spaces, the topological type changes as we progress through the family since we pass through a wall in the enlarged Kähler moduli space. Classically one would expect to encounter a singularity in this process. However, although the classical geometry passes through a singularity, it is possible that the quantum physics does not¹. This is a difficult possibility to analyze directly because it is precisely in this circumstance — one in which the volume of curves in the internal space are small — that we do not trust perturbative methods in quantum field theory. However, it proves extremely worthwhile to consider the description on the mirror family of Calabi-Yau spaces. On the mirror family, only the complex structure changes and the Kähler form can be fixed at a large value, thereby allowing perturbation theory to be reliable. As we shall discuss, on the mirror family no topology change occurs — rather a continuous change of shape accompanied by *smoothly varying* physical observables is all that transpires. Thus, on the mirror family we can directly see that no physical singularity is encountered even though one of our geometrical descriptions involves a discontinuous change in topology².

¹ We emphasize that all of our analysis is at string tree-level and our use of the term “quantum” throughout this paper refers to quantum properties of the two-dimensional conformal field theory on the sphere which describes classical string propagation. It might be more precise to use the word “stringy” instead of “quantum” but we shall continue to use the latter common parlance.

² One might interpret this statement to mean that — at some level — no topology change is really occurring so long as one makes use of the correct geometrical description. This is not true. A more precise version of the statement given in the text, and one which will be explained fully in the sequel, is: certain topology changing transitions associated with changing the Kähler structure on a Calabi-Yau space can be reformulated as physically smooth topology preserving deformations of the complex structure on its mirror. The general situation is one in which the Kähler structure *and* the complex structure of a given Calabi-Yau change and hence similarly for its mirror. Generically, the Kähler structure deformations of both the original Calabi-Yau and its mirror will result in both families undergoing topology change. We can analyze the physical description of such transitions by studying the mirror equivalent complex structure deformations

To avoid confusion, we emphasize that the topology changing transitions which we study are *not* between a Calabi-Yau and its mirror. Rather, mirror manifolds are used as a tool to study topology changing transitions in which, for example, the Hodge numbers are preserved and only more subtle topological invariants change. The observation that a given Calabi-Yau space may have a number of “close relatives” with the same Hodge numbers but a different topology (constructed by flopping) was made a number of years ago by Tian and Yau [9]. What is new here is the smooth interpolation between the σ -models based on these different spaces.

Although this picture of topology change, as presented and verified in [8], is both compelling and convincing, it is natural to wonder how string theory, at a microscopic level, avoids a physical singularity when passing through a topology changing transition. The local description of the topology changing transitions studied here was given in [12] which, contemporaneously with [8], established this first concrete arena of spacetime topology change. In [12], by direct examination of particular correlation functions it was shown that quantum corrections exactly cancel the discontinuity that is experienced by the classical contribution — in precise agreement with what is expected based on [8]. Moreover, the results of [12] thoroughly and precisely map out the physical significance of regions in the “fully enlarged Kähler moduli space” (which we shall discuss in some detail). These regions are interpreted in [12] as phases of $N = 2$ quantum field theories and shown to include Calabi-Yau σ -models on birationally equivalent but topologically distinct target spaces, Landau-Ginzburg theories and other “hybrid” models which we shall discuss in section VI. The results of [12] have helped to shape the interpretations we give here and provide complimentary evidence in support of the topology changing processes we present.

Much of this paper is aimed at explaining the methods and results of [8]. In section II we will give a more detailed summary of the topology changing picture established in [8] while emphasizing the background material on mirror manifolds that is required. We will see that our discussion requires some understanding of toric geometry and we will give a detailed primer on this subject in section III. In section IV we shall apply some concepts of toric geometry to discuss mirror symmetry following [13] and [14]. We will extend this discussion to yield a toric description of the Kähler and complex structure moduli spaces — naturally leading to the important concepts of the secondary fan , the

(and hence see that the physical description is smooth) but we cannot give a nonlinear σ -model geometrical interpretation which does not involve topology change.

“partially” enlarged Kähler moduli space and the monomial-divisor mirror map. In section V we shall apply these concepts to verify our picture of moduli space, the action of mirror symmetry and topology change. We will do this in the context of a particularly tractable example, but it will be clear that our results are general. We will review the calculation of [8] which established the topology changing picture reviewed above. In section VI we will indicate the structure of the “fully” enlarged moduli space alluded to above and in [8], and show its relation to the “hybrid” models found in [12]. We will leave some important calculations in these theories to a forthcoming paper. Finally, in section VII we shall offer our conclusions.

2. Mirror Manifolds, Moduli Spaces and Topology Change

In this section we aim to give an overview of the topology changing picture established in [8] and use subsequent sections to fill in essential technical details that shall arise in our discussion.

2.1. Mirror Manifolds

Mirror symmetry was conjectured based upon naturality arguments in [2,3], was suggested by the computer studies of [4] and was established to exist in certain cases by direction construction in [5]. Mirror symmetry describes a situation in which two very different Calabi-Yau spaces (of the same complex dimension) X and Y , when taken as target spaces for two-dimensional nonlinear σ -models, give rise to isomorphic $N = 2$ superconformal field theories (with the explicit isomorphism involving a change in the sign of a certain $U(1)$ charge). Such a pair of Calabi-Yau spaces X and Y are said to constitute a *mirror pair* [5]. Note that the tree level actions of these σ -models are thoroughly different as X and Y are topologically distinct. Nonetheless, when each such action is modified by the series of corrections required by quantum mechanical conformal invariance, the two nonlinear σ -models become isomorphic.

The naturality arguments of [2,3] were based on the observation that the two types of moduli in a Calabi-Yau σ -model — the Kähler and complex structure moduli (see the following subsections for a brief review) — are very different geometrical objects. However, their conformal field theory counterparts — truly marginal operators — differ only by the sign of their charge under a $U(1)$ subgroup of the superconformal algebra. It is unnatural that a pronounced geometric distinction corresponds to such a minor conformal

field theory distinction. This unnatural circumstance would be resolved if for each such conformal theory there is a second Calabi-Yau space interpretation in which the association of conformal fields and geometrical moduli is *reversed* (with respect to this $U(1)$ charge) relative to the first. If this scenario were to be realized, it would imply, for instance, the existence of pairs of Calabi-Yau spaces whose Hodge numbers satisfy $h_X^{p,q} = h_Y^{d-p,q}$. A computer survey of hypersurfaces for the case $d = 3$ [4] revealed a host of such pairs. It is important to realize, especially in light of more recent mathematical discussions of mirror symmetry [13,14], that if X and Y satisfy the appropriate Hodge number identity this by no means establishes that they form a mirror pair. To be a mirror pair, X and Y must correspond to the same conformal field theory. Such mirror pairs of Calabi-Yau spaces were constructed in [5] and at present are the only known examples of mirror manifolds. This construction will play a central role in our analysis so we now briefly review it.

In [5] it was shown that any string vacuum K built from products of $N = 2$ minimal models [15] respects a certain symmetry group G such that K and K/G are isomorphic conformal theories with the explicit isomorphism being given by a change in sign of the left moving $U(1)$ quantum numbers of all conformal fields. Furthermore, G has a geometrical interpretation [5] as an action on the Calabi-Yau space X_0 associated to K [16,17]. This geometrical action, in contrast to its conformal field theory realization, does not yield an isomorphic Calabi-Yau space. Rather, X_0 and $Y_0 = X_0/G$ are topologically quite different. Nonetheless, K and K/G are geometrically interpretable in terms of X_0 and Y_0 , respectively — and since the former are isomorphic conformal theories, the latter topologically distinct Calabi-Yau spaces yield isomorphic nonlinear σ -models³. The two Calabi-Yau spaces therefore constitute a mirror pair. As we will discuss in more detail below, the explicit isomorphism between K and K/G being a reversal of the sign of the left moving $U(1)$ charge implies that X_0 and Y_0 have Hodge numbers (when singularities are suitably resolved) which satisfy the mirror relation given in the last paragraph.

Having built a specific mirror pair of theories, as stressed in [5], one can now use marginal operators to move about the moduli space of each theory to construct whole

³ In light of the results of [12] which reveal a subtlety in the Calabi-Yau/Landau-Ginzburg correspondence, the arguments of [5] more precisely show that the Landau-Ginzburg (orbifold) theory corresponding to K and that associated to K/G are isomorphic. To arrive at the geometric correspondence between X_0 and Y_0 , one must vary the parameters in the theory. This point should become clear in section VI.

families of mirror pairs. It is important to realize however that this process is being performed at the level of conformal field theory and that there may be some subtle difficulties in translating this into statements about the *geometry* of mirror families. In fact, it was shown in [18] that there is an apparent contradiction between the structure of the moduli space of Kähler forms according to classical geometry and according to conformal field theory. This issue thus carries into mirror symmetry [19]. If one builds a mirror pair of theories by the method of [5], then at least one theory will be an orbifold and the associated target space will have quotient singularities. Classically, varying parameters in the local moduli space of Kähler forms around this point has the effect of “blowing-up” these singularities. Typically this process is not unique and so leads to a fan-like structure with many regions as will be discussed. Such a structure is not seen locally in the mirror partner. It was suggested in [19] that a resolution of this conundrum would occur if string theory were somehow able to smooth out so-called “flops” which relate different blow-ups to each other. In this paper we will describe exactly how to study the geometry of mirror families. We will see how the fan-like structure appears the moduli space of conformal field theories once one looks at the global structure of the moduli space and that flop transitions are indeed smoothed out in string theory. We will also find that there are many other transitions that can occur in the fan structure.

2.2. Conformal Field Theory Moduli Space

Amongst the operators which belong to a given conformal field theory there is a special subset, $\{\Phi_i\}$, consisting of “truly marginal operators”. These operators have the property that they have conformal dimension $(1,1)$ and hence can be used to deform the original theory through the addition of terms to the original action which to first order have the form

$$\sum t_i \int d^2z \Phi_i. \tag{2.1}$$

The Φ_i being truly marginal, higher order terms can be chosen so that the resulting theory is still conformal. We consider all such theories that can be constructed in this manner to be in the same *family* — differing from each other by truly marginal perturbations. The parameter space of all such conformal field theories is known as the *moduli space* of the family.

If we consider a family of conformal field theories which have a geometrical interpretation in terms of a family of nonlinear σ -models, we can give a geometrical interpretation

to the conformal field theory moduli space. Namely, marginal perturbations in conformal field theory correspond to deformations of the target space geometry which preserve conformal invariance. In the case of interest to us, we study $N = 2$ superconformal field theories which correspond to nonlinear σ -models with Calabi-Yau target spaces. We will also impose the condition that the Hodge number $h^{2,0} = 0$. There are two types of geometrical deformations of these spaces which preserve the Calabi-Yau condition and hence do not spoil conformal invariance. Namely, one can deform the *complex structure* or one can deform the *Kähler structure*. In fact, with the above condition on $h^{2,0}$, *all* of the truly marginal operators Φ_i appearing in (2.1) have a geometric realization in terms of complex structure and Kähler structure moduli of the associated Calabi-Yau space, and these two sectors are independent of each other. The conformal field theory moduli space is therefore geometrically interpretable in terms of the moduli spaces parametrizing all possible complex and Kähler structure deformations of the associated Calabi-Yau space, and is locally a product of the moduli space of complex structures and the moduli space of Kähler structures.

The truly marginal operators Φ_i are endowed with an additional quantum number: their charge under a $U(1)$ subgroup of the $N = 2$ superconformal algebra. This charge can be 1 or -1 and hence the set of all Φ_i can be partitioned into two sets according to the sign of this quantum number. One such set corresponds to the Kähler moduli of X and the other set corresponds to the complex structure moduli of X . It is rather unnatural that such a trivial conformal field theory distinction — the sign of a $U(1)$ charge — has such a pronounced geometrical interpretation. The mirror manifold scenario removes this issue in that if Y is the mirror of X then the association of truly marginal conformal fields to geometrical moduli is reversed relative to X . In this way, each truly marginal operator has an interpretation as *both* a Kähler and a complex structure moduli — albeit on distinct spaces.

In the next two subsections we shall describe the two geometrical moduli spaces—the spaces of complex structures and of Kähler structures—in turn. Our discussion will, for the most part, be a classical mathematical exposition of these moduli spaces. It is important to realize that classical mathematical formulations are generally lowest order approximations to structures in conformal field theory. The description of the Kähler moduli space given below most certainly is only a classical approximation to the structure of the corresponding *quantum* conformal field theory moduli space. An important implication of this for our purposes is that if our classical analysis indicates that a point in the Kähler

moduli space corresponds to a singular Calabi-Yau space, it does not necessarily follow that the associated conformal field theory is singular (i.e. has badly behaved physical observables). Physical properties and geometrical properties are related but they are not identical. One might think that a similar statement could be made regarding the complex structure moduli space — however in our applications there is a crucial difference. We will only need to study the physical properties of theories represented by points in the complex structure moduli space which correspond to smooth (i.e. transverse) complex structures. By Yau’s theorem [20], in such a circumstance, one can find a smooth Ricci-flat metric (which solves the lowest order β -function equations) which is in the same cohomology class as any chosen Kähler form on the manifold. By choosing this Kähler form to be “large” (large overall volume and large volume for all rational curves) we can trust perturbation theory and all physical observables are perfectly well defined. Thus, we can trust that *nonsingular* points in the complex structure moduli space give rise to *nonsingular* physics (for sufficiently general choices of the Kähler class). It is this fact which shall play a crucial role in our analysis of topology changing transitions.

2.3. Complex Structure Moduli Space

A given real $2d$ dimensional manifold may admit more than one way of being viewed as a complex d dimensional manifold. Concretely, a complex d -dimensional manifold is one in which complex coordinates z_1, \dots, z_d have been specified in various “coordinate patches” such that transition functions between patches are holomorphic functions of these coordinates. Any two sets of such complex coordinates which themselves differ by an invertible holomorphic change of variables are considered equivalent. If there is no such holomorphic change of variables between two sets of complex coordinates, they are said to define different complex structures on the underlying real manifold.

Given a complex structure on a complex manifold X , there is a cohomology group which parameterizes all possible infinitesimal deformations of the complex structure: $H^1(X, T)$, where T is the holomorphic tangent bundle. For the case of X being Calabi-Yau, it has been shown [21] that there is no obstruction to integrating infinitesimal deformations to finite deformations and hence this cohomology group may be taken as the tangent space to the parameter space of all possible complex structures on X . As is well known, because X has a nowhere vanishing holomorphic $(d, 0)$ form, we have the isomorphism $H^1(X, T) \cong H^{d-1,1}(X)$. For certain types of Calabi-Yau spaces X , there is a simple way

of describing these complex structures. In the present paper we will focus almost exclusively on hypersurfaces in weighted projective space. So, let X be given as the vanishing locus of a single homogeneous polynomial in the weighted projective space $\mathbb{P}_{\{k_0, \dots, k_d\}}^{(d+1)}$. Our notation here is that if z_0, \dots, z_d are homogeneous coordinates in this weighted projective space then we have the identification

$$[z_0, \dots, z_d] \cong [\lambda^{k_0} z_0, \dots, \lambda^{k_d} z_d]. \quad (2.2)$$

For X to be Calabi-Yau it must be homogeneous of degree equal to the sum of the weights k_i . Consider the most general form for the defining equation of X

$$W = \sum a_{i_0 i_1 \dots i_d} z_{i_0}^{p_0} \dots z_{i_d}^{p_d} = 0 \quad (2.3)$$

with $\sum k_{i_j} p_j = \sum k_j$. In order to count each complex structure that arises here only once, we must make identifications among sets of coefficients $a_{i_0 i_1 \dots i_d}$ which give rise to isomorphic hypersurfaces through general projective linear coordinate transformations on the z_i . This gives a space of possible complex structures that can be put on the real manifold underlying X (but in general there may be other complex structures as well [22]). Thus, we have a very simple description of this part of the complex structure moduli space of the Calabi-Yau manifold X . We will illustrate these ideas in an explicit example in section V.

Given a Calabi-Yau hypersurface defined by (2.3), note that each monomial $z_{i_0}^{p_0} \dots z_{i_d}^{p_d}$ appearing in (2.3) can be regarded as a truly marginal operator which deforms the complex structure. These deformations enter into (2.3) in a purely linear way—no higher order corrections are necessary.

One subtlety in the above description is that not all choices of the coefficients $a_{i_0 i_1 \dots i_d}$ lead to a nonsingular X .⁴ Namely, if there is a solution to the equations $\partial f / \partial z_i = 0$ other than $z_i = 0$ for all i , then X is not smooth. In the moduli space of complex structures, this singularity condition is met on the “discriminant locus” of X , which is a complex codimension one variety. Being complex codimension one, note (figure 1) that we can choose a path between any two nonsingular complex structures which avoids the discriminant locus. This will be a useful fact later on.

⁴ More precisely, not all choices lead to an X which is “no more singular than it has to be”. There will be certain singularities of X which arise from singularities of the weighted projective space itself; we wish to exclude any *additional* singularities.

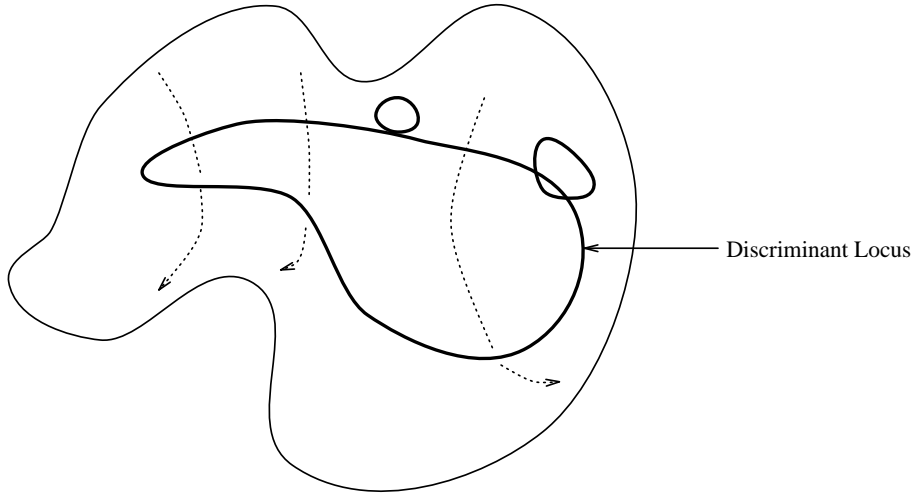

Figure 1. The moduli space of complex structures.

2.4. Kähler Structure Moduli Space

In addition to deformations of the complex structure of X , one can also consider deformations of the “size” of X . More precisely, X is a Kähler manifold and hence is endowed with a Kähler metric $g_{i\bar{j}}dz^i \otimes d\bar{z}^{\bar{j}}$ from which we construct the Kähler form $J = ig_{i\bar{j}}dz^i \wedge d\bar{z}^{\bar{j}}$. The Kähler form is a closed $(1, 1)$ cohomology class, i.e. is an element of $H^{1,1}(X)$. Deformations of the Kähler structure on X refer to deformations of the Kähler metric (hence the “size”) which preserve the $(1, 1)$ nature of J and which cannot be realized by a change of coordinates on X . (We remark that deformations of the complex structure *do not* preserve the type $(1, 1)$ nature of J .) Such deformations yield new Kähler forms J' which are in distinct cohomology classes. The space of all such distinct $(1, 1)$ classes is precisely given by $H^{1,1}(X)$ whose general member can be written as

$$\sum a_i e_i \tag{2.4}$$

where a_i are real coefficients and e_i are a basis for $H^{1,1}(X)$.

Not every choice of the a_i gives rise to an acceptable Kähler form on X . To be a Kähler form, the $(1, 1)$ form must be such that it gives rise to positive volumes for topologically nontrivial curves, surfaces, hypersurfaces, etc. which reside in X . That is, we require

$$\int_{C_r} J^r > 0 \tag{2.5}$$

where C_r is a homologically nontrivial effective algebraic r -cycle and J^r denotes $J \wedge J \wedge \dots \wedge J$ (with r factors of J). The Kähler moduli space of X is thus given by a cone (the “Kähler cone”) which consists of those $(1, 1)$ forms which satisfy (2.5). This is a real space whose dimension is $h^{1,1}$.

To gain a better understanding of the Kähler moduli space, it proves worthwhile to study (2.5) in the special case of $r = 1$ — that is, the case in which C_r is a curve. We consider a curve C with the property that the limiting condition $\int_C J = 0$ can be achieved while simultaneously maintaining all of the remaining conditions in (2.5) for all⁵ other curves, and for all higher dimensional subspaces. These inequalities (and equality) define a “boundary wall” in the moduli space. We can approach this wall by changing the Kähler metric so as to shrink the volume of the curve C to a value which is arbitrarily small. The limiting wall is defined as the place in moduli space where the volume of C has been shrunk to zero — one says that C has been “blown down” to a point. What happens if one goes even further and allows the a_i in (2.4) to take on values which pass through to the other side of the wall? Formally, the volume of the curve C would appear to become negative. This uncomfortable conclusion, though, can have a very natural resolution. The curve C can actually have positive volume on the other side of the wall, however it must be viewed as residing on a *topologically different* space⁶. This procedure of blowing a curve C down to a point and then restoring it to positive volume (“blowing up”) in a manner which changes the topology of the underlying space is known as “flopping”. We can think of this flopping operation of algebraic geometry as providing a means of traversing a wall⁷ of the Kähler cone by passing through a *singular* space and then on to a different smooth

⁵ In practice, we may need to allow the condition $\int_{C_i} J = 0$ to hold for a finite number of holomorphic curves C_i , all of which lie in the same cohomology class as C . It is crucial for this discussion that there be *only* finitely many such curves.

⁶ This interpretation of the volumes is implicit in the analysis of [23], which studied the metric behavior of the conifold transitions. It has also been considered in the mathematics literature [24]. The *topology changing* property of these transformations was first pointed out by Tian and Yau [9]; see [25] for an update.

⁷ It must be stressed that not every wall of the Kähler moduli space has this property—this only happens for the so-called “flopping walls”. There are other walls, at which certain families of curves also shrink down to zero, for which the change upon crossing the wall is not of this geometric type, but rather, a new kind of physical theory is born. In the simplest cases, after shrinking down the curves we will have orbifold singularities, and previous “blowup modes” go over into “twist field modes”. We will encounter some of these other walls in section VI.

topological model. Typically there may be many algebraic curves on X which define this kind of wall of the Kähler cone and so can be flopped on in this way. Each of these flopped models has its own Kähler cone with walls determined in the manner just described. Our discussion, therefore, leads to the natural suggestion that we enlarge our perspective on the Kähler moduli space so as to include *all* of these Kähler cones glued together along their common walls. We will call this the “partially enlarged moduli space” for reasons which shall become clear in section VI.

We emphasize that in passing through a wall (i.e. in flopping a curve) the Hodge numbers of X remain invariant. Thus, the topology change involved here is different from that, for example, encountered in the conifold transitions of [11]. However, more refined topological invariants do change. For instance, the intersection forms on flopped models generally do differ from one another. Again, we shall see this explicitly in an example in section V.

So much for the mathematical description of the space of Kähler forms on a Calabi-Yau manifold and on its flopped versions. Conformal field theory instructs us to modify our picture of the Kähler moduli space in two important ways.

First, as discussed, there are quantum corrections to this classical analysis which in general prove difficult to calculate exactly. We will get on a handle on such corrections by appealing to mirror symmetry.

Second, we have noted that the real dimension of the Kähler moduli space is equal to $h^{1,1}$. Conformal field theory instructs us to double this dimension to *complex* dimension $h^{1,1}$ by combining our real Kähler form J with the *antisymmetric tensor field* B to form a complexified Kähler form $K = B + iJ$. The motivation for doing this comes from supersymmetry transformations which show that it is precisely this combination that forms the scalar component of a spacetime superfield. Our discussion concerning the conditions on J carries through unaltered — being now applied to the imaginary part of K . There are no constraints on the $(1, 1)$ class B — however, the conformal field theory is invariant under shifts in B by integral $(1, 1)$ classes, i.e. elements of $H^2(X, \mathbb{Z})$. Incorporating this symmetry naturally leads us to exponentiate the naïve coordinates on Kähler moduli space and consider the true coordinates to be $w_k = e^{2\pi i(B_k + iJ_k)}$ where B_k and J_k are the components of the two-forms B and J relative to an integral basis of $H^2(X, \mathbb{Z})$. In terms of these exponentiated complex coordinates, the adjacent Kähler cones of the partially enlarged moduli space (figure 2) now become bounded domains attached along their common closures as illustrated in figure 3. Note that the walls of the various Kähler cones — and

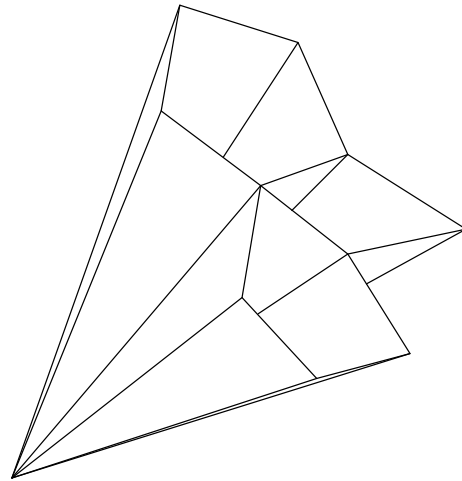

Figure 2. Adjoining Kähler cones.

their exponentiated versions as boundaries of domains — are real codimension one and hence divide the partially enlarged moduli space into regions. It is impossible to pass from one region into another without passing through a wall.

2.5. *Topology Change*

In this subsection we will consider the implication of applying the mirror manifold discussion of subsection 2.1 to the moduli space discussion of subsections 2.2–2.4.

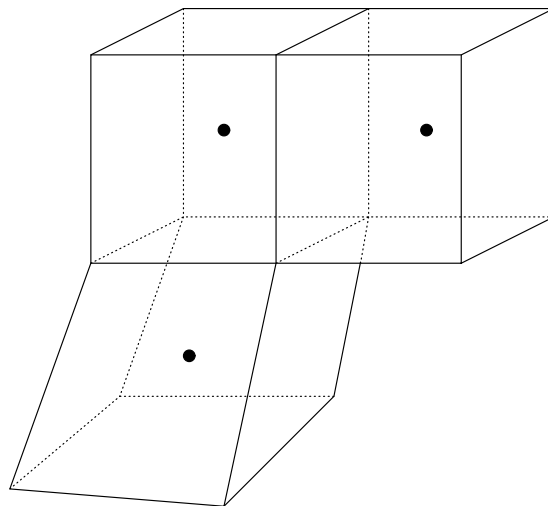

Figure 3. Adjoining Cells.

As we have discussed, if X and Y are a pair of mirror Calabi-Yau spaces, their corresponding conformally invariant nonlinear σ -models are isomorphic. We mentioned earlier that the explicit isomorphism involves a change in sign of the left-moving $U(1)$ charge of the $N = 2$ superconformal algebra. From our discussion of subsection 2.2 we therefore see that this isomorphism maps complex structure moduli of X to Kähler moduli of Y and vice versa. Even as a local result this is a remarkable statement — mathematically X and Y are *a priori* unrelated Calabi-Yau spaces. Mirror symmetry establishes, though, a physical link — their common conformal field theory. Furthermore, the roles played by the complex and Kähler structure moduli of X and Y are reversed in the associated physical model. As a global result which claims an isomorphism between the full quantum mechanical Kähler moduli space of X and the complex structure moduli space of Y and vice versa, the statement harbors great potential but also raises a confusing issue. If we compare figures 1 and 3 we are led to ask: how is it possible for these two spaces to be isomorphic when manifestly they have different structures? Specifically, figure 3 is divided up into cells with the cell walls corresponding to singular Calabi-Yau spaces lying at the transition between distinct topological types. In figure 1, however, the space contains no such cell division. Rather, there are real codimension two subspaces parametrizing singular complex structures. In figure 3, the passage from one cell to another necessarily passes through a wall, while in figure 1 — by judicious choice of path — we can pass between any two nonsingular complex structures without encountering a singularity. So, the puzzle we are faced with is how are these seemingly distinct spaces isomorphic?

There is another compelling way of stating this question. As mentioned, in the known construction of mirror pairs [5], typically both of the geometric spaces X_0 and Y_0 have quotient singularities. We know that string propagation on such singular spaces, say X_0 , is well defined [1] because the string effectively resolves the singularities. However, in some situations there is more than one way of repairing the singularities giving rise to topologically distinct smooth spaces. Resolving singularities therefore involves a choice of desingularization⁸. These manifolds differ by flops [10]. The moduli space of Calabi-Yau manifolds takes the form of figure 3. (This partially enlarged moduli space does *not* include the point corresponding to the Landau-Ginzburg theory but this will not be

⁸ Stating this more carefully, bearing in mind that we have actually had to vary parameters from an initial Landau-Ginzburg theory to arrive at X_0 , we are asserting that by a further variation of parameters X_0 can be deformed into more than one Calabi-Yau manifold.

important until later in this paper.) On the mirror to X , namely Y , one would expect to find some corresponding choices in the *complex structure* moduli space. In figure 1, however, there are no divisions into regions, no topological choices to be made. Thus, what is the physical significance of the topologically distinct regions of figure 3?

Two possible answers to these questions immediately present themselves, however neither is at first sight convincing. First, it might be that only one region in figure 3 has a physical interpretation and this region would correspond under mirror symmetry to the whole complex structure moduli space of Y . This explanation implies that the operation of flopping rational curves (passing through a wall in figure 3) has no conformal field theory (and hence no physical) realization. Furthermore, it helps to resolve the asymmetry between figures 1 and 3 as neither, effectively, would be divided into regions. This explanation would imply that of all the possible resolutions of singularities of X_0 — which are on completely equal footing from the mathematical perspective — the string somehow picks out one. Although unnatural, *a priori* the string might make some physical distinction between these possibilities.

As a second possible resolution of the puzzle, it might be that all of the regions in figure 3 are realized by physical models but, as mentioned, this is not immediately convincing because the walls dividing the Kähler moduli space in figure 3 into topologically distinct regions have no counterpart in the complex structure moduli space of the mirror. However, it is important to realize that our discussion of figures 1 and 3 has been based on classical mathematical analysis. As discussed earlier, although we can trust that nonsingular points in the complex structure moduli space correspond to nonsingular physical models it is generally *incorrect* to conclude that singular points in the Kähler moduli space correspond to singular physical models. It is therefore possible that the quantum version of figures 2 and 3 *are* isomorphic with generic points on the walls of the classical version of figure 3 corresponding to *nonsingular* physical models. In particular, this would imply that one can pass from one topological type to another in figure 3 — necessarily passing through a singular Calabi-Yau space — without encountering a *physical* singularity. Notice that the mirror description of such a process does not involve topology change. Rather, it simply involves a continuous and smooth change in the complex structure of the mirror space (analogous to continuously changing the τ parameter for a torus). Thus, this second resolution would establish that certain topology changing processes (corresponding to flops of rational curves) are no more exotic than — and by mirror symmetry can equally well be described as — smooth changes in the shape of spacetime.

In [8], we gave compelling evidence that the latter possibility is in fact correct and we refer to this resolution as giving rise to *multiple mirror manifolds*. It is as if a single topological type (focusing on the complex structure moduli space of Y) has not one but many topological images in its mirror reflection (in the partially enlarged Kähler moduli space of X). Mirror manifolds thus yield a rich catoptric-like moduli space geometry. To avoid confusion, though, note that a fixed conformal field theory in our family still has precisely two geometrical interpretations.

We established this picture of topology change in [8] by verifying an extremely sensitive prediction of this scenario which we now review. In section VI we will also describe a means of identifying the fully enlarged Kähler moduli space of X with the complex structure moduli space of Y by means of concepts from toric geometry.

Let X and Y be a mirror pair of Calabi-Yau manifolds. Because they are a mirror pair, a striking and extremely useful equality between the Yukawa couplings amongst the $(1, 1)$ forms on M and the $(2, 1)$ forms on Y (and vice versa) is satisfied. This equality demands that [5]:

$$\int_Y \omega^{abc} \tilde{b}_a^{(i)} \wedge \tilde{b}_b^{(j)} \wedge \tilde{b}_c^{(k)} \wedge \omega = \int_X b^{(i)} \wedge b^{(j)} \wedge b^{(k)} + \sum_{m, \{u\}} e^{\int_{\mathbb{P}^1} u_m^* K} \left(\int_{\mathbb{P}^1} u^* b^{(i)} \int_{\mathbb{P}^1} u^* b^{(j)} \int_{\mathbb{P}^1} u^* b^{(k)} \right). \quad (2.6)$$

where on the left hand side (as derived in [26]) the $\tilde{b}_a^{(i)}$ are $(2, 1)$ forms (expressed as elements of $H^1(Y, T)$ with their subscripts being tangent space indices), ω is the holomorphic three form and on the right hand side (as derived in [27,28,29,30]) the $b^{(i)}$ are $(1, 1)$ forms on X , $\{u\}$ is the set of holomorphic maps to rational curves on X , $u : \mathbb{P}^1 \rightarrow \Gamma$ (with Γ such a holomorphic curve), π_m is an m -fold cover $\mathbb{P}^1 \rightarrow \mathbb{P}^1$ and $u_m = u \circ \pi_m$. One should note that the left-hand side of (2.6) is independent of Kähler form information of Y and the right-hand side is independent of the complex structure of X . In particular (2.6) can still be valid when Y has rational singularities with Kähler resolutions since such a singular Y may be thought of as a smooth Y' with a deformation of Kähler form.

Notice the interesting fact that for X at “large radius” (i.e., when $|\exp(\int_{\mathbb{P}^1} u_m^* K)| \ll 1$, for all u) the right hand side of (2.6) reduces to the topological intersection form on X and hence mirror symmetry (in this particular limit) equates a topological invariant of X to a

quasitopological invariant (i.e., one depending on the complex structure) of Y [5].⁹ In a simple case a suitable limit was found in [33] such that the intersection form of a manifold could indeed be calculated from its mirror partner in this way. If the multiple mirror manifold picture is correct, and all regions of figure 3 are physically realized, the following must hold: Each of the distinct intersection forms, which represents the large radius limit of the $(1, 1)$ Yukawa couplings on each of the topologically distinct resolutions of X_0 , must be equal to the $(2, 1)$ Yukawa couplings on Y for suitable corresponding “large complex structure” limits. That is, if there are N distinct resolutions of X_0 , one should be able to perform a calculation along the lines of [33] such that N different sets of intersection numbers are obtained by taking N different limits. We schematically illustrate these limits by means of the marked points in the interiors of the regions in figure 3. We emphasize that checking (2.6) in the large radius limit makes the calculation much more tractable but it does not in any way compromise our results. This is an extremely sensitive test of the *global* picture of topology change and of moduli space that we are presenting. Now, actually invoking this equality requires understanding the precise complex structure limits that correspond, under mirror symmetry, to the particular large Kähler structure limits being taken. In the simple case studied in [33] it was possible to use discrete symmetries to make a well-educated guess at the desired large complex structure. That example did not admit any flops however. It appears almost inevitable that any example which has the required complexity to admit flops will be too difficult to approach along the lines of [33]. What we are in need of then is a more sophisticated way of knowing which large complex limits are to be identified with which intersection numbers of the mirror manifold. It turns out that the mathematical machinery of *toric geometry* provides the appropriate tools for discussing these moduli spaces and hence for finding these limit points in the complex structure moduli space. Thus, in the next section we shall give a brief primer on the subject of toric geometry, in section IV we shall apply these concepts to mirror symmetry and in section V we shall examine an explicit example.

⁹ In [29] equation (2.6) was combined with an explicit determination of the *mirror map* (the map between the Kähler moduli space of X and the complex structure moduli space of X/G for X being the Fermat quintic in \mathbb{P}^4) to determine the number of rational curves of arbitrary degree on (deformations of) X . This calculation has subsequently been described mathematically [31] and extended to a number of other examples [32].

3. A Primer on Toric Geometry

In this section we give an elementary discussion of toric geometry emphasizing those points most relevant to the present work. For more details and proofs the reader should consult [34,35].

3.1. Intuitive Ideas

Toric geometry describes the structure of a certain class of geometrical spaces in terms of simple combinatorial data. When a space admits a description in terms of toric geometry, many basic and essential characteristics of the space — such as its divisor classes, its intersection form and other aspects of its cohomology — are neatly coded and easily deciphered from analysis of corresponding lattices. We will describe this more formally in the following subsections. Here we outline the basic ideas.

A toric variety V over \mathbb{C} (one can work over other fields but that shall not concern us here) is a complex geometrical space which contains the *algebraic torus* $T = \mathbb{C}^* \times \dots \times \mathbb{C}^* \cong (\mathbb{C}^*)^n$ as a dense open subset. Furthermore, there is an action of T on V ; that is, a map $T \times V \rightarrow V$ which extends the natural action of T on itself. The points in $V - T$ can be regarded as limit points for the action of T on itself; these serve to give a partial compactification of T . Thus, V can be thought of as a $(\mathbb{C}^*)^n$ together with additional limit points which serve to partially (or completely) compactify the space¹⁰. Different toric varieties V , therefore, are distinguished by their different compactifying sets. The latter, in turn, are distinguished by restricting the limits of the allowed action of T — and these restrictions can be encoded in a convenient combinatorial structure as we now describe.

In the framework of an action $T \times V \rightarrow V$ we can focus our attention on one-parameter subgroups of the full T action¹¹. Basically, we follow all possible holomorphic curves in T as they act on V , and ask whether or not the action has a limit point in V . As the algebraic torus T is a commutative algebraic group, all of its one-parameter subgroups are

¹⁰ As we shall see in the next subsection, this discussion is a bit naïve — these spaces need not be smooth, for instance. Hence it is not enough just to say what points are added — we must also specify the local structure near each new point.

¹¹ We use subgroups depending on one *complex* parameter.

labeled by points in a lattice $N \cong \mathbb{Z}^n$ in the following way. Given $(n_1, \dots, n_n) \in \mathbb{Z}^n$ and $\lambda \in \mathbb{C}^*$ we consider the one-parameter group \mathbb{C}^* acting on V by

$$\lambda \times (z_1, \dots, z_n) \rightarrow (\lambda^{n_1} z_1, \dots, \lambda^{n_n} z_n) \quad (3.1)$$

where (z_1, \dots, z_n) are local holomorphic coordinates on V (which may be thought of as residing in the open dense $(\mathbb{C}^*)^n$ subset of V). Now, to describe all of V (that is, in addition to T) we consider the action of (3.1) in the limit that λ approaches zero (and thus moves from \mathbb{C}^* into \mathbb{C}). It is these limit points which supply the partial compactifications of T thereby yielding the toric variety V . The limit points obtained from the action (3.1) depend upon the explicit vector of exponents $(n_1, \dots, n_n) \in \mathbb{Z}^n$, but many different exponent-vectors can give rise to the same limit point. We obtain different toric varieties by imposing different restrictions on the allowed choices of (n_1, \dots, n_n) , and by grouping them together (according to common limit points) in different ways.

We can describe these restrictions and groupings in terms of a “fan” Δ in N which is a collection of *strongly convex rational polyhedral cones* σ_i in the real vector space $N_{\mathbb{R}} = N \otimes_{\mathbb{Z}} \mathbb{R}$. (In simpler language, each σ_i is a convex cone with apex at the origin spanned by a finite number of vectors which live in the lattice N and such that any angle subtended by these vectors at the apex is $< 180^\circ$.) The fan Δ is a collection of such cones which satisfy the requirement that the face of any cone in Δ is also in Δ . Now, in constructing V , we associate a coordinate patch of V to each *large* cone¹² σ_i in Δ , where large refers to a cone spanning an n -dimensional subspace of N . This patch consists of $(\mathbb{C}^*)^n$ together with all the limit points of the action (3.1) for (n_1, \dots, n_n) restricted to lie in $\sigma_i \cap N$. There is a single point which serves as the common limit point for all one-parameter group actions with vector of exponents (n_1, \dots, n_n) lying in the *interior* of σ_i ; for exponent-vectors on the boundary of σ_i , additional families of limit points must be adjoined.

We glue these patches together in a manner dictated by the precise way in which the cones σ adjoin each other in the collection Δ . Basically, the patches are glued together in a manner such that the one-parameter group actions in the two patches agree along the

¹² There are also coordinate patches for the smaller cones, but we ignore these for the present.

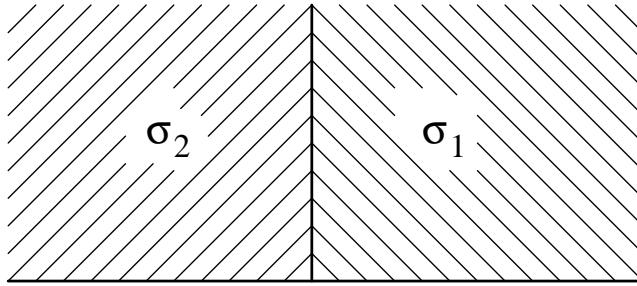

Figure 4. A simple fan.

common faces of the two cones in Δ . We will be more precise on this point shortly. The toric variety V is therefore completely determined by the combinatorial data of Δ .

For a simple illustration of these ideas, consider the two-dimensional example of Δ shown in figure 4. As Δ consists of two large cones, V contains two coordinate patches. The first patch — corresponding to the cone σ_1 — represents $(\mathbb{C}^*)^2$ together with all limit points of the action

$$\lambda \times (z_1, z_2) \rightarrow (\lambda^{n_1} z_1, \lambda^{n_2} z_2) \quad (3.2)$$

with n_1 and n_2 non-negative as λ goes to zero. We add the single point $(0, 0)$ as the limit point when $n_1 > 0$ and $n_2 > 0$, we add points of the form $(z_1, 0)$ as limit points when $n_1 = 0$ and $n_2 > 0$, and we add points of the form $(0, z_2)$ as limit points when $n_1 > 0$ and $n_2 = 0$.¹³

Clearly, this patch corresponds to \mathbb{C}^2 . By symmetry, we also associate a \mathbb{C}^2 with the cone σ_2 . Now, these two copies of \mathbb{C}^2 are glued together in a manner dictated by the way σ_1 and σ_2 adjoin each other. Explaining this requires that we introduce some more formal machinery to which we now turn.

3.2. The M and N Lattices

In the previous subsection we have seen how a fan Δ in $N_{\mathbb{R}}$ serves to define a toric variety V . The goal of this subsection is to make the connection between lattice data and V more explicit by showing how to derive the transition functions between the patches of V . The first part of our presentation will be in the form of an algorithm that answers:

¹³ Note that it is possible to extend this reasoning to the case $n_1 = n_2 = 0$: the corresponding trivial group action has as “limit points” all points (z_1, z_2) , so even the points interior to T itself can be considered as appropriate limit points for actions by subgroups.

given the fan Δ how do we explicitly define coordinate patches and transition functions for the toric variety V ? We will then briefly describe the mathematics underlying the algorithm.

Towards this end, it proves worthwhile to introduce a second lattice defined as the dual lattice to N , $M = \text{Hom}(N, \mathbb{Z})$. We denote the dual pairing of M and N by $\langle \cdot, \cdot \rangle$. Corresponding to the fan Δ in $N_{\mathbb{R}}$ we define a collection of dual cones $\check{\sigma}_i$ in $M_{\mathbb{R}}$ via

$$\check{\sigma}_i = \{m \in M_{\mathbb{R}} : \langle m, n \rangle \geq 0 \text{ for all } n \in \sigma_i\}. \quad (3.3)$$

Now, for each dual cone $\check{\sigma}_i$ we choose a finite set of elements $\{m_{i,j} \in M\}$ (with $j = 1, \dots, r_i$) such that

$$\check{\sigma}_i \cap M = \mathbb{Z}_{\geq 0} m_{i,1} + \dots + \mathbb{Z}_{\geq 0} m_{i,r_i}. \quad (3.4)$$

We then find a finite set of relations

$$\sum_{j=1}^{r_i} p_{s,j} m_{i,j} = 0 \quad (3.5)$$

with $s = 1, \dots, R$ such that *any* relation

$$\sum_{j=1}^{r_i} p_j m_{i,j} = 0 \quad (3.6)$$

can be written as a linear combination of the given set, with integer coefficients. (That is, $p_j = \sum_{s=1}^R \mu_s p_{s,j}$ for some integers μ_s .) We associate a coordinate patch U_{σ_i} to the cone $\sigma_i \in \Delta$ by

$$U_{\sigma_i} = \{(u_{i,1}, \dots, u_{i,r_i}) \in \mathbb{C}^{r_i} \mid u_{i,1}^{p_{s,1}} u_{i,2}^{p_{s,2}} \dots u_{i,r_i}^{p_{s,r_i}} = 1 \text{ for all } s\}, \quad (3.7)$$

the equations representing constraints on the variables $u_{i,1}, \dots, u_{i,r_i}$. We then glue these coordinate patches U_{σ_i} and U_{σ_j} together by finding a complete set of relations of the form

$$\sum_{l=1}^{r_i} q_l m_{i,l} + \sum_{l=1}^{r_j} q'_l m_{j,l} = 0 \quad (3.8)$$

where the q_l and q'_l are integers. For each of these relations we impose the coordinate transition relation

$$u_{i,1}^{q_1} u_{i,2}^{q_2} \dots u_{i,r_i}^{q_r} u_{j,1}^{q'_1} u_{j,2}^{q'_2} \dots u_{j,r_j}^{q'_r} = 1. \quad (3.9)$$

This algorithm explicitly shows how the lattice data encodes the defining data for the toric variety V .

Before giving a brief description of the mathematical meaning behind this algorithm, we pause to illustrate it in two examples. First, let us return to the fan Δ given in figure 4. It is straightforward to see that the dual cones, in this case, take precisely the same form as in figure 4. We have $m_{1,1} = (1, 0), m_{1,2} = (0, 1); m_{2,1} = (-1, 0), m_{2,2} = (0, 1)$. As the basis vectors within a given patch are linearly independent, each patch consists of a \mathbb{C}^2 . To glue these two patches together we follow (3.8) and write the set of relations

$$m_{1,1} + m_{2,1} = 0 \tag{3.10}$$

$$m_{1,2} - m_{2,2} = 0. \tag{3.11}$$

These yield the transition functions

$$u_{1,1} = u_{2,1}^{-1}, \quad u_{1,2} = u_{2,2}. \tag{3.12}$$

These transition functions imply that the corresponding toric variety V is the space $\mathbb{P}^1 \times \mathbb{C}$.

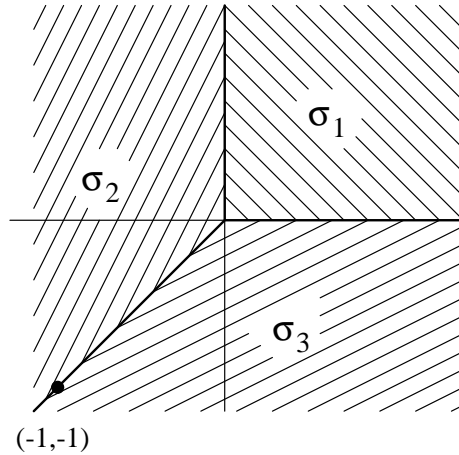

Figure 5. The fan for \mathbb{P}^2 .

As a second example, consider the fan Δ given in figure 5. It is straightforward to determine that the dual cones in $M_{\mathbb{R}}$ take the form shown in figure 6. Following the above procedure we find that the corresponding toric variety V consists of three patches with coordinates related by

$$u_{1,1} = u_{2,1}^{-1}, \quad u_{1,2} = u_{2,2}u_{2,1}^{-1} \tag{3.13}$$

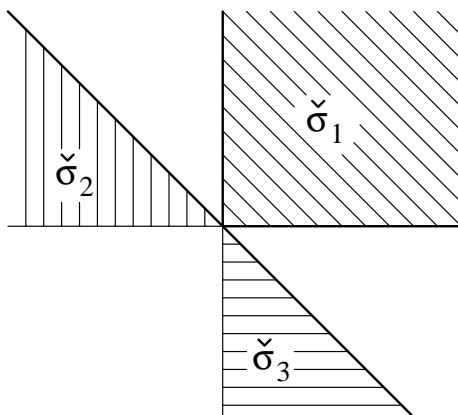

Figure 6. The dual cones for \mathbb{P}^2 .

and

$$u_{2,2} = u_{3,2}^{-1}, \quad u_{2,1} = u_{3,1}u_{3,2}^{-1}. \quad (3.14)$$

These transition functions imply that the toric variety V associated to the fan Δ in figure 5 is \mathbb{P}^2 .

The mathematical machinery behind this association of lattices and complex analytic spaces relies on a shift in perspective regarding what one means by a geometrical space. Algebraic geometers identify geometrical spaces by means of the *rings of functions* that are well defined on those spaces.¹⁴ To make this concrete we give two illustrative examples. Consider the space \mathbb{C}^2 . It is clear that the ring of functions on \mathbb{C}^2 is isomorphic to the polynomial ring $\mathbb{C}[x, y]$ where x and y are formal symbols, but may be thought of as *coordinate functions* on \mathbb{C}^2 . By contrast, consider the space $(\mathbb{C}^*)^2$. Relative to \mathbb{C}^2 , we want to eliminate geometrical points either of whose coordinate vanishes. We can do this by *augmenting* the ring $\mathbb{C}[x, y]$ so as to include functions that are not well defined on such geometrical points. Namely, $\mathbb{C}[x, y, x^{-1}, y^{-1}]$ contains functions only well defined on $(\mathbb{C}^*)^2$. The ring $\mathbb{C}[x, y, x^{-1}, y^{-1}]$ can be written more formally as $\mathbb{C}[x, y, z, w]/(zx - 1, wy - 1)$ where the denominator denotes modding out by the ideal generated by the listed functions. One says that

$$\mathbb{C}^2 \cong \text{Spec } \mathbb{C}[x, y] \quad (3.15)$$

¹⁴ This can be done in a number of different contexts. Different kinds of rings of functions—such as continuous functions, smooth functions, or algebraic functions—lead to different kinds of geometry: topology, differential geometry, and algebraic geometry in the three cases mentioned. We will concentrate on rings of algebraic functions, and algebraic geometry.

and

$$(\mathbb{C}^*)^2 \cong \text{Spec} \frac{\mathbb{C}[x, y, z, w]}{(zx - 1, wy - 1)} \quad (3.16)$$

where the term “Spec” may intuitively be thought of as “the minimal space of points where the following function ring is well defined”.

With this terminology, the coordinate patch U_{σ_i} corresponding to the cone σ_i in a fan Δ is given by

$$U_{\sigma_i} \cong \text{Spec} \mathbb{C}[\check{\sigma}_i \cap M] \quad (3.17)$$

where by $\check{\sigma}_i \cap M$ we refer to the monomials in local coordinates that are naturally assigned to lattice points in M by virtue of its being the dual space to N . Explicitly, a lattice point (m_1, \dots, m_n) in M corresponds to the monomial $z_1^{m_1} z_2^{m_2} \dots z_n^{m_n}$. The latter are sometimes referred to as *group characters* of the algebraic group action given by T .

Within a given patch, $\text{Spec} \mathbb{C}[\check{\sigma}_i \cap M]$ is a polynomial ring generated by the monomials associated to the lattice points in $\check{\sigma}_i$. By the map given in the previous paragraph between lattice points and monomials, we see that linear relations between lattice points translate into multiplicative relations between monomials. These relations are precisely those given in (3.5).

Between patches, if σ_i and σ_j share a face, say τ , then $\mathbb{C}[\check{\sigma}_i \cap M]$ and $\mathbb{C}[\check{\sigma}_j \cap M]$ are both subalgebras of $\mathbb{C}[\check{\tau} \cap M]$. This provides a means of identifying elements of $\mathbb{C}[\check{\sigma}_i \cap M]$ and elements of $\mathbb{C}[\check{\sigma}_j \cap M]$ which translates into a map between $\text{Spec} \mathbb{C}[\check{\sigma}_i \cap M]$ and $\text{Spec} \mathbb{C}[\check{\sigma}_j \cap M]$. This map is precisely that given in (3.9).

3.3. Singularities and their Resolution

In general, a toric variety V need not be a smooth space. One advantage of the toric description is that a simple analysis of the lattice data associated with V allows us to identify singular points. Furthermore, simple modifications of the lattice data allow us to construct from V a toric variety \tilde{V} in which all of the singular points are repaired. We now briefly describe these ideas.

The essential result we need is as follows:

Let V be a toric variety associated to a fan Δ in N . V is smooth if for each cone σ in the fan we can find a \mathbb{Z} basis $\{n_1, \dots, n_r\}$ of N and an integer $r \leq n$ such that $\sigma = \mathbb{R}_{\geq 0} n_1 + \dots + \mathbb{R}_{\geq 0} n_r$.

For a proof of this statement the reader should consult, for example, [34] or [35]. The basic idea behind the result is as follows. If V satisfies the criterion in the proposition, then the dual cone $\check{\sigma}$ to σ can be expressed as

$$\check{\sigma} = \sum_{i=1}^r \mathbb{R}_{\geq 0} m_i + \sum_{i=r+1}^n \mathbb{R} m_i \quad (3.18)$$

where $\{m_1, \dots, m_n\}$ is the dual basis to $\{n_1, \dots, n_n\}$. We can therefore write

$$\check{\sigma} \cap M = \sum_{i=1}^r \mathbb{Z}_{\geq 0} m_i + \sum_{i=r+1}^n \mathbb{Z}_{\geq 0} m_i + \sum_{i=r+1}^n \mathbb{Z}_{\geq 0} (-m_i). \quad (3.19)$$

From our prescription of subsection 3.2, this patch is therefore isomorphic to

$$\text{Spec} \frac{\mathbb{C}[x_1, \dots, x_n, y_{r+1}, \dots, y_n]}{\prod_{i=r+1}^n (x_i y_i - 1)}. \quad (3.20)$$

In plain language, this is simply $\mathbb{C}^r \times (\mathbb{C}^*)^{n-r}$, which is certainly nonsingular. The key to this patch being smooth is that σ is r -dimensional and it is spanned by r linearly independent lattice vectors in N . This implies, via the above reasoning, that there are no “extra” constraints on the monomials associated with basis vectors in the patch (see (3.7)) hence leaving a smooth space.

Of particular interest in this paper will be toric varieties V whose fan Δ is *simplicial*. This means that each cone σ in the fan can be written in the form $\sigma = \mathbb{R}_{\geq 0} n_1 + \dots + \mathbb{R}_{\geq 0} n_r$ for some linearly independent vectors $n_1, \dots, n_r \in N$. (Such a cone is itself called *simplicial*.) When $r = n$, we define a “volume” for simplicial cones as follows: choose each n_j to be the first nonzero lattice point on the ray $\mathbb{R}_{\geq 0} n_j$ and define $\text{vol}(\sigma)$ to be the volume of the polyhedron with vertices O, n_1, \dots, n_n . (We normalize our volumes so that the unit simplex in \mathbb{R}^n (with respect to the lattice N) has volume 1. Then the volume of σ coincides with the index $[N : N_\sigma]$, where N_σ is the lattice generated by n_1, \dots, n_n .) Note that the coordinate chart U_σ associated to a simplicial cone σ of dimension n is smooth at the origin precisely when $\text{vol}(\sigma) = 1$.

To illustrate this idea, we consider a fan Δ , figure 7, which gives rise to a singular variety. This fan has one big (simplicial) cone of volume 2 generated by $v_1 = (0, 1) = n_1$ and $v_2 = (2, 1) = n_1 + 2n_2$. The dual cone $\check{\sigma}$ is generated by $w_1 = (2, -1) = 2m_1 - m_2$ and $w_2 = (0, 1) = m_2$. In these expressions, n_i and m_j are the standard basis vectors. It is clear that this toric variety is not smooth since it does not meet the conditions of the proposition.

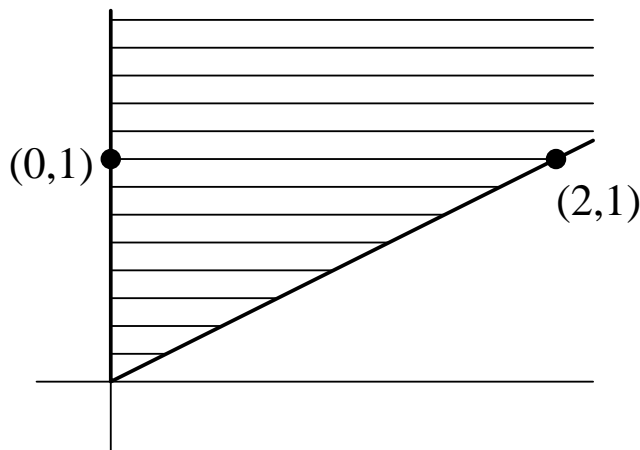

Figure 7. The fan for \mathbb{C}/\mathbb{Z}_2 .

More explicitly, following (3.7) we see that $\check{\sigma} \cap M = \mathbb{Z}_{\geq 0}(2m_1 - m_2) + \mathbb{Z}_{\geq 0}(m_2) + \mathbb{Z}_{\geq 0}(m_1)$ and hence $V = \text{Spec}(\mathbb{C}[x, y, z]/(z^2 - xy = 0))$. In plain language, V is the vanishing locus of $z^2 - xy$ in \mathbb{C}^3 . This is singular at the origin, as is easily seen by the transversality test. Alternatively, a simple change of variables; $z = u_1 u_2$, $x = u_1^2$, $y = u_2^2$, reveals that V is in fact $\mathbb{C}^2/\mathbb{Z}_2$ (with \mathbb{Z}_2 generated by the action $(u_1, u_2) \rightarrow (-u_1, -u_2)$) which is singular at the origin as this is a fixed point. Notice that the key point leading to this singularity is the fact that we require three lattice vectors to span the two dimensional sublattice $\check{\sigma} \cap M$.

The proposition and this discussion suggest a procedure to follow to modify any such V so as to repair singularities which it might have. Namely, we construct a new fan $\tilde{\Delta}$ from the original fan Δ by *subdividing*: first subdividing all cones into simplicial ones, and then subdividing the cones σ_i of volume > 1 until the stipulations of the nonsingularity proposition are met. The new fan $\tilde{\Delta}$ will then be the toric data for a nonsingular *resolution* of the original toric variety V . This procedure is called *blowing-up*. We illustrate it with our previous example of $V = \mathbb{C}^2/\mathbb{Z}_2$. Consider constructing $\tilde{\Delta}$ by subdividing the cone in Δ into two pieces by a ray passing through the point $(1, 1)$. It is then straightforward to see that each cone in $\tilde{\Delta}$ meets the smoothness criterion. By following the procedure of subsection 3.2 one can derive the transition functions on \tilde{V} and find that it is the total space of the line bundle $\mathcal{O}(-2)$ over \mathbb{P}^1 (which is smooth). This is the well known blow-up of the quotient singularity $\mathbb{C}^2/\mathbb{Z}_2$.

If the volume of a cone as defined above behaved the way one might hope, i.e., whenever dividing a cone of volume v into other cones, one produced new cones whose volumes summed to v , then subdivision would clearly be a finite process. Unfortunately this is not

the case¹⁵ and in general one can continue dividing any cone for as long as one has the patience. This corresponds to the fact that one can blow-up any point on a manifold to obtain another manifold. In our case, however, we will utilize the fact that string theory demands that the canonical bundle of a target space is trivial. The Calabi-Yau manifold will not be the toric variety itself as we will see in subsection 3.5 but we do require that any resolution of singularities adds nothing new to the canonical class of V . This will restrict the allowed blowups rather severely.

In order to have a resolution which adds nothing new to the canonical class, the singularities must be what are called *canonical Gorenstein singularities* [36]. A characterization of which toric singularities have this property was given by Danilov and Reid. To state it, consider a cone σ from our fan Δ , and examine the one-dimensional edges of σ . As we move away from O along any of these edges we eventually reach a point in N . In this way we associate a collection of points $\mathcal{S} \subset N$ with σ . (These points will lie in the boundary of a polyhedron P° which we will discuss in more detail in subsection 3.5.) The fact we require is that *the singularities of the affine toric variety U_σ are canonical Gorenstein singularities if all the points in \mathcal{S} lie in an affine hyperplane H in $N_{\mathbb{R}}$ of the form*

$$H = \{x \in N_{\mathbb{R}} \mid \langle m, x \rangle = 1\} \tag{3.21}$$

for some $m \in M$, and if there are no lattice points $x \in \sigma \cap N$ with $0 < \langle m, x \rangle < 1$. ([36], p.294). Furthermore, in order to avoid adding anything new to the canonical class, we must choose all one-dimensional cones used in subdividing σ from among rays of the form $\mathbb{R}_{\geq 0} x$ where $x \in \sigma \cap N$ lies on the hyperplane H (i.e., $\langle m, x \rangle = 1$).

If we have a big simplicial cone, then the n points in $N_{\mathbb{R}}$ associated to the one-dimensional subcones of this cone always define an affine hyperplane in $N_{\mathbb{R}}$. If we assume the singularity is canonical and Gorenstein, then this hyperplane is one integral unit away from the origin and volumes can be conveniently calculated on it. In particular, if the volume of the big cone is greater than 1 then this hyperplane will intersect more points in $\sigma \cap N$. These additional points define the one-dimensional cones that can be used for further subdivisions of the cone that do not affect the canonical class. Since volumes are calculated in the hyperplane H , the volume property behaves well under such resolutions,

¹⁵ If the closest lattice point to the origin on the subdividing ray does not lie on a face of the polyhedron $\langle O, n_1, \dots, n_n \rangle$ then the new polyhedra will be unrelated to the old, and the volumes will not add.

i.e., the sum of the volumes of the new cones is equal to the volume of the original cone that was subdivided.

In some cases, there will not be enough of these additional points to complete subdivide into cones of volume 1. However, in the case of primary interest in this paper (in which V is a four-dimensional toric variety which contains three-dimensional Calabi-Yau varieties as hypersurfaces), we *can* achieve a partial resolution of singularities which leaves only isolated singularities on V . Happily, the Calabi-Yau hypersurfaces will avoid those isolated singularities, so their singularities are completely resolved by this process.

For simplicity of exposition, we shall henceforth assume that our toric varieties V have the following property: if we partially resolve by means of a subdivision which (a) makes all cones simplicial, and (b) divides simplicial cones into cones of volume 1, adding nothing new to the canonical class, then we obtain a smooth variety. This property holds for the example we will consider in detail in section V. We will point out from time to time the modifications which must be made when this property is *not* satisfied; a systematic exposition of the general case is given in [37].

An important point for our study is the fact that, in general, there is no unique way to construct $\tilde{\Delta}$ from the original fan Δ . On the contrary, there are often numerous ways of subdividing the cones in Δ so as to conform to the volume 1 and canonical class conditions. Thus, there are numerous smooth varieties that can arise from different ways of resolving the singularities on the original singular space. These varieties are birationally equivalent but will, in general, be *topologically distinct*. For three-dimensional Calabi-Yau varieties such topologically distinct resolutions can always be related by a sequence of flops [10]. For the simplest kind of flops¹⁶, a small neighbourhood of the \mathbb{P}^1 being flopped is isomorphic to an open subset of a three-dimensional toric variety, and that flop can be given a toric description as follows.

To a three-dimensional toric variety we associate a fan in \mathbb{R}^3 . If this variety is smooth we can intersect the fan with an S^2 enclosing the origin to obtain a triangulation of S^2 , or part of S^2 . (Different smooth models will correspond to different triangulations of S^2 .) We show a portion of two such triangulations in figure 8. In figure 8 one sees that if two neighbouring triangles form a convex quadrilateral then this quadrilateral can be triangulated the other way to give a different triangulation. Any two triangulations can be related by a sequence of such transformations. When translated into toric geometry the reconfiguration of the fan shown in figure 8 is precisely a flop.

¹⁶ In fact, these are the only kinds of flops that we need [38].

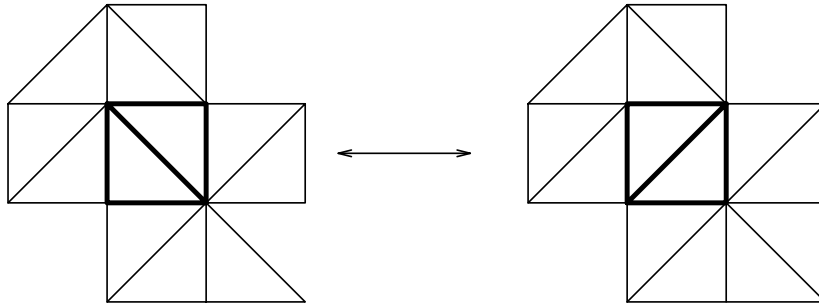

Figure 8. A flop in toric geometry.

3.4. Compactness and Intersections

Another feature of the toric variety V which can be directly determined from the data in Δ is whether or not it is compact. Quite simply, V is compact if Δ covers all of \mathbb{R}^n . For a more precise statement and proof the reader is referred to [34]. This condition on Δ is intuitively clear. Recall that we have associated points in N with one parameter group actions on V . Those points in N which also lie in Δ are special in that the limit points of the corresponding group actions are part of V . Now, if every point in N lies in Δ then the limit points of all one parameter group actions are part of V . In other words, V contains all of its limit points — it is compact. The examples we have given illustrate this point. Only the fan of figure 6 covers all of N and hence only its corresponding toric variety (\mathbb{P}^2) is compact. Note that a compact toric variety cannot be a Calabi-Yau manifold. This does not stop toric geometry being useful in the construction of Calabi-Yau manifolds however, as we shall see.

This picture of complete fans corresponding to compact varieties can be extended to analyze parts of the fan and gives one a good idea of how to interpret a fan just by looking at it. If we consider an r -dimensional cone σ in the interior of a fan then there is a $(n - r)$ -dimensional complete fan surrounding this cone (in the normal direction). Thus we can identify an $(n - r)$ -dimensional compact toric subvariety $V^\sigma \subset V$ associated to σ . For example, each one-dimensional cone in Δ is associated to a codimension one holomorphically embedded subspace of V , i.e., a *divisor*.

We can take this picture further. Suppose an r -dimensional cone σ_r is part of an s -dimensional cone σ_s , where $s > r$. When we interpret these cones as determining subvarieties of V we see that $V^{\sigma_s} \subset V^{\sigma_r} \subset V$. Now suppose we take two cones σ_1 and σ_2 ,

and find a maximal cone $\sigma_{1,2}$ such that σ_1 and σ_2 are both contained in $\sigma_{1,2}$. The toric interpretation tells us that

$$V^{\sigma_{1,2}} \cong V^{\sigma_1} \cap V^{\sigma_2}. \quad (3.22)$$

If no such $\sigma_{1,2}$ exists then V^{σ_1} and V^{σ_2} do not intersect. If we take n one-dimensional cones σ_i that form the one-dimensional edges of a big cone then the divisors V_{σ_i} intersect at a point.

Thus we see that the fan Δ contains information about the intersection form of the divisors within V . Actually the fan Δ contains the information to determine self-intersections too and thus all the intersection numbers are determined by Δ .

Referring back to figure 8 we can describe a flop in the language of toric geometry. To perform the transformation in figure 8 we first remove the diagonal bold line the in middle of the diagram. This line is the base of a two-dimensional cone (which thus has codimension one). The only one dimensional compact toric variety is \mathbb{P}^1 so this line we have removed represented a rational curve. After removing this line we are left with a square-based cone in the fan which is not simplicial, so the resulting toric variety is singular. We then add the diagonal line in the other direction to resolve this singularity thus adding in a new rational curve. This is precisely a flop — we blew down one rational curve to obtain a singular space and then blew it up with another rational curve to resolve the singularity.

3.5. Hypersurfaces in Toric Varieties

Our interest is not with toric varieties, *per se*, but rather with Calabi-Yau spaces. The preceding discussion is useful in this domain because a large class of Calabi-Yau spaces can be realized as hypersurfaces in toric varieties. These were introduced into the physics literature in [9], were argued to be equivalent, in some sense, to minimal model string vacua in [15,16,17,12] and were partially cataloged by computer search (for the case of threefolds) in [4]. The toric varieties of greatest relevance here are weighted projective spaces. We have seen how ordinary projective spaces (in particular \mathbb{P}^2) are toric varieties and the same is true for weighted projective spaces.

To illustrate this point, let us construct the weighted projective space $\mathbb{P}_{\{3,2,1\}}^2$. As in the case of \mathbb{P}^2 , there are three patches for this space. The explicit transition functions between these patches are:

$$u_{1,1} = u_{2,1}^{-1}, \quad u_{1,2}^3 = u_{2,2}u_{2,1}^{-2} \quad (3.23)$$

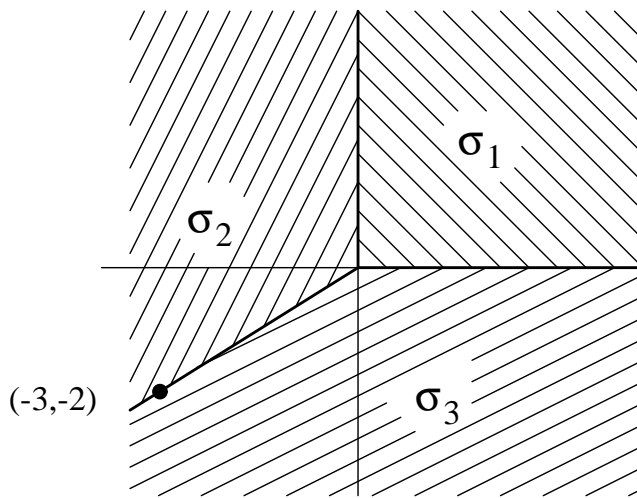

Figure 9. The fan for $\mathbb{P}^2_{\{3,2,1\}}$.

and

$$u_{2,2} = u_{3,2}^{-1}, \quad u_{2,1}^2 = u_{3,1}^3 u_{3,2}^{-1}. \quad (3.24)$$

Consider the fan Δ in figure 9. By following the procedure of subsection 3.2 one can directly determine that this fan yields the same set of transition functions. Notice that $\mathbb{P}^2_{\{3,2,1\}}$ is not smooth, by the considerations of subsection 3.2. This is as expected since the equivalence relation of (2.2) has nontrivial fixed points. All higher dimensional weighted projective spaces can be constructed in the same basic way.

Now, how do we represent a hypersurface in such a toric variety? In our discussion we shall follow [14]. A hypersurface is given by a homogeneous polynomial of degree d in the homogeneous weighted projective space coordinates. Recall that points in the M lattice correspond to monomials in the *local* coordinates associated to the particular patch in which the point resides. Consider first the subspace of M in which all lattice coordinates are positive. We specify the *family* of degree d hypersurfaces by drawing a polyhedron P defined as the minimal convex polyhedron that surrounds all lattice points corresponding to (the local representation of) monomials of degree d . By sliding this polyhedron along the coordinate axes of M such that one vertex of M is placed at the origin, we get the representation of these monomials in the other weighted projective space patches — a different patch for each vertex. To specify a particular hypersurface (i.e. a particular degree d equation) one would need to give more data than is encoded in this lattice formalism — the values of the *coefficients* of each degree d monomial in the defining

equation of the hypersurface would have to be specified. However, the toric framework is particularly well suited to studying the whole family of such hypersurfaces.

As a simple example of this, consider the cubic hypersurface in \mathbb{P}^2 which has homogeneous coordinates $[z_1, z_2, z_3]$. In local coordinates, say $x = z_1/z_3$ and $y = z_2/z_3$ (the patch in which $z_3 \neq 0$) the homogeneous cubic monomials are $1, x, y, x^2, y^2, xy, x^3, y^3, x^2y, xy^2$. (One multiplies each of these by suitable powers of z_3 to make them homogeneous of degree three.) These monomials all reside in the polyhedral region of M as shown in figure 10.

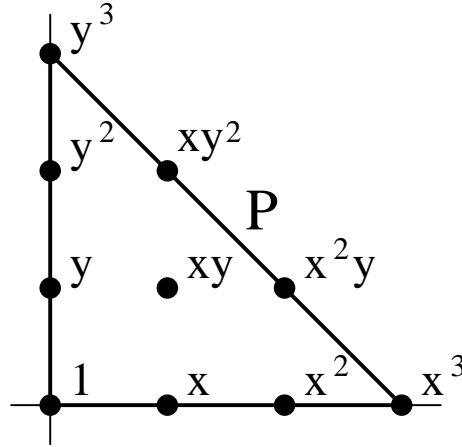

Figure 10. The polyhedron of monomials.

As shown in [14], there is a simple condition on P to ensure that the resulting hypersurface is Calabi-Yau. This condition consists of two parts. First, P must contain precisely one interior point. Second, if we call this interior point m_0 then it must be the case that P is *reflexive* with respect to M and m_0 . This means the following. Given $P \subset M_{\mathbb{R}}$ we can construct the *polar polyhedron* $P^\circ \subset N_{\mathbb{R}}$ as

$$P^\circ = \{(x_1, \dots, x_n) \in N_{\mathbb{R}}; \sum_{i=1}^n x_i y_i \geq -1 \text{ for all } (y_1, \dots, y_n) \in P\}, \quad (3.25)$$

where we have shifted the position of P in M so that m_0 has coordinates $(0, \dots, 0)$. If the vertices of P° lie in N then P is called reflexive. The origin O of N will then be the unique element of N in the interior of P° .

Also note that given a reflexive $P^\circ \subset N_{\mathbb{R}}$ we can construct Δ by building the fan comprising the cones over the faces, edges and vertices of P° based on O . In general such a fan may contain cones of volume > 1 . However all the other points in $P^\circ \cap N$, except

O , are on faces and edges of P° and can thus be used to resolve the singularities of V without affecting the canonical class. The exceptional divisors introduced into V by this resolution of singularities can intersect the hypersurface to produce exceptional divisors in the Calabi-Yau manifold. (However, this does not necessarily happen in all cases. If we consider a point in the interior of a codimension one face of P° then the exceptional divisor induced in V would not intersect the hypersurface and therefore would give no contribution to the Calabi-Yau manifold.)

To finish specifying Δ we must say which sets of the one-dimensional cones are to be used as the set of edges of a larger cone. Phrased in terms of the relevant lattice points in $P^\circ \cap N$, what we need to specify is *a triangulation of P° , with vertices in $P^\circ \cap N$, each simplex of which includes O* . Replacing each simplex with the corresponding cone whose vertex lies at O , we produce the fan Δ . Conversely, if we are given Δ then intersecting the cones of Δ with the polyhedron P° produces a triangulation of P° .

3.6. Kähler and Complex Structure Moduli

Having seen how Calabi-Yau hypersurfaces in a weighted projective space are described in the language of toric geometry we now indicate how the complex structure and Kähler structure moduli on these spaces are represented.

In general, not all such moduli have a representation in toric geometry. Let's begin with complex structure moduli. As discussed in subsection 2.3, such moduli are associated to elements in $H^{d-1,1}(X)$, where X is the Calabi-Yau space, and under favorable circumstances [22] some of these can be represented by monomial perturbations of the same degree of homogeneity as X . By our discussion of the previous subsection, these are the lattice points contained within P . Thus, those complex structure deformations with a monomial representation have a direct realization in the toric description of X .

The other set of moduli are associated with the Kähler structure of X . Note that an arbitrary element of $H^{1,1}(X)$ can, by Poincare duality, be represented as a $(2d - 2)$ -cycle in $H_{2d-2}(X)$. As explained in subsection 3.4 and above, divisors in X are given by some of the one-dimensional cones in Δ which, in turn, correspond to points in $P^\circ \cap N$. To be more precise, by this method, every point in $P^\circ \cap N$ except O and points in codimension one faces of P° gives a (not necessarily distinct) class in $H_{2d-2}(X)$.

Unfortunately it does not follow that $H_{2d-2}(X)$ is generated by such points in P° . In general an exceptional divisor in V may intersect X in several isolated regions. This leads to many classes in $H_{2d-2}(X)$ being identified with the same point in P° . If we define the

Kähler form on X in terms of the cohomology of V we thus restrict to only part of the moduli space of Kähler forms on X . We will do this in the next subsection, and study Kähler forms directly on V ; these always induce Kähler forms on X ¹⁷, and will produce only part of the Kähler moduli space of X . As we will see however, restricting to this part of the moduli space will not cause any problems for our analysis of the mirror property.

3.7. Holomorphic Quotients

There are two other related ways of building a toric variety V from a fan Δ , in addition to the method we have discussed to this point. For a more detailed discussion of the approach of this subsection the reader is referred to [39]. In this paper we will concern ourselves only with the holomorphic quotient although another method, the symplectic quotient, is also quite relevant.

An n -dimensional toric variety V can be realized as

$$((\mathbb{C})^{n+h^{1,1}(V)} - F_\Delta)/(\mathbb{C}^*)^{h^{1,1}(V)} \quad (3.26)$$

where F_Δ is a subspace of $(\mathbb{C})^{n+h^{1,1}(V)}$ determined by Δ . One might wonder why the particular form in (3.26) arises. We shall explain this shortly, however, we note that first, being a toric variety, V contains a $(\mathbb{C}^*)^n$ as a dense open set (as in (3.26)) and second, without removing F_Δ the quotient is badly behaved (for example it may not be Hausdorff). For a clear discussion of the latter issue we refer the reader to pages 190–193 of [12]. This is called a holomorphic quotient. Alternatively, the quotient in (3.26) can be carried out in two stages: one can first restrict to one of the level sets of the “moment map” $\mu : (\mathbb{C})^{n+h^{1,1}(V)} \rightarrow (\mathbb{R})^{h^{1,1}(V)}$, and then take the quotient by the remaining $(S^1)^{h^{1,1}(V)}$. (There is a way to determine which fan Δ corresponds to each specified value of the moment map—see for example [40].) This latter construction is referred to as taking the symplectic quotient.

The groups $(\mathbb{C}^*)^k$ by which we take quotients are often constructed out of a lattice of rank k . If L is such a lattice, we let $L_{\mathbb{C}}$ be the complex vector space constructed from L by allowing complex coefficients. The quotient space $L_{\mathbb{C}}/L$ is then an algebraic group isomorphic to $(\mathbb{C}^*)^k$. A convenient way to implement the quotient by L is to exponentiate vectors componentwise (after multiplying by $2\pi i$). For this reason, we adopt the notation $\exp(2\pi i L_{\mathbb{C}})$ to indicate this group $L_{\mathbb{C}}/L$.

¹⁷ This is not completely obvious when V is singular, but it is verified in [37].

Let us consider the holomorphic quotient in greater detail. To do so we need to introduce a number of definitions. Let \mathcal{A} be the set of points in $P^\circ \cap N$. We assume henceforth that \mathcal{A} contains no point which lies in the interior of a codimension one face of P° . (The more general case is treated in [37].) Denote by r the number of points in \mathcal{A} . Let Ξ be the set \mathcal{A} with O removed which is isomorphic to the set of one dimensional cones in the fully resolved fan Δ . To every point $\rho \in \Xi$ associate a formal variable x_ρ . Let $\mathbb{C}^\Xi = \text{Spec } \mathbb{C}[x_\rho, \rho \in \Xi]$. \mathbb{C}^Ξ is simply \mathbb{C}^{r-1} . Let us define the polynomial ideal B_0 to be generated by $\{x^\sigma, \sigma \text{ a cone in } P^\circ\}$ with x^σ defined as $\prod_{\rho \notin \sigma} x_\rho$. Let us introduce the lattice $A_{n-1}(V)$ of divisors modulo linear equivalence on V . (On a smooth toric variety, linear equivalence is the same thing as homological equivalence. See, for example, [35], p.64, for a fuller explanation.) This group may also be considered as $H_{2d-2}(V, \mathbb{Z})$ if V is compact and smooth which we will assume for the rest of this section. Finally, define

$$G = \text{Hom}(A_{n-1}(V), \mathbb{C}^*) \cong \exp(2\pi i A_{n-1}(V)^\vee) \cong (\mathbb{C}^*)^{h^{1,1}(V)} \quad (3.27)$$

where $A_{n-1}(V)^\vee$ denotes the dual lattice of $A_{n-1}(V)$. Then, it can be shown that V can be realized as the holomorphic quotient

$$V \cong (\mathbb{C}^\Xi - F_\Delta)/G \quad (3.28)$$

where F_Δ is the vanishing locus of the elements in the ideal B_0 .

To give an idea of where this representation of V comes from, consider the exact sequence

$$0 \longrightarrow M \longrightarrow \mathbb{Z}^\Xi \longrightarrow A_{n-1}(V) \longrightarrow 0 \quad (3.29)$$

where \mathbb{Z}^Ξ is the free group over \mathbb{Z} generated by the points (i.e. toric divisors) in Ξ . To see why this is exact, we explicitly consider the maps involved. Elements in \mathbb{Z}^Ξ may be associated with integer valued functions defined on the points in Ξ . Any such function, f , is given by its value on the $r - 1$ points in Ξ . The map from $\mathbb{Z}^\Xi \rightarrow A_{n-1}(V)$ consists of

$$f \mapsto \sum_{\rho \in \Xi} f(\rho) D_\rho \quad (3.30)$$

where D_ρ is the divisor class in V associated to the point ρ in Δ . Clearly, every toric divisor can be so written. It is known [35] that the toric divisors generate all of $A_{n-1}(V)$, and hence this map is surjective.

Any element $m \in M$ is taken into \mathbb{Z}^Ξ by the mapping

$$m \mapsto \langle \bullet, m \rangle. \quad (3.31)$$

This map is injective as any two linear functions which agree on Ξ agree on N (by our assumption that the points of Ξ span N). M is the kernel of the second map because the points $m \in M$ correspond to global meromorphic functions (by their group characters, i.e., monomials as discussed in subsection 3.2) and hence give rise to divisors linearly equivalent to 0.

Taking the exponential of the dual of (3.29) we have

$$1 \longrightarrow (\mathbb{C}^*)^{h^{1,1}(V)} \longrightarrow (\mathbb{C}^*)^\Xi \longrightarrow \exp(2\pi i N_{\mathbb{C}}) \longrightarrow 1. \quad (3.32)$$

Notice that $\exp(2\pi i N_{\mathbb{C}}) = N_{\mathbb{C}}/N$ is the algebraic torus T from which V is obtained by partial compactification. We have now seen that T arises as a holomorphic quotient of

$$(\mathbb{C}^*)^\Xi \quad (3.33)$$

by

$$(\mathbb{C}^*)^{h^{1,1}(V)}. \quad (3.34)$$

To represent V in a similar manner, therefore, we need to partially compactify this quotient. The data for so doing, of course, is contained in the fan Δ (just as it was in our earlier approach to building V). As shown in [39], the precise way in which this partial compactification is realized in the present setting is to use Δ to replace (3.33) by the numerator on the right hand side of (3.28).

3.8. Toric Geometry of the Partially Enlarged Kähler Moduli Space

The orientation of our discussion of toric geometry to this point has been to describe the structure of certain Calabi-Yau hypersurfaces. It turns out that the *moduli* spaces of these Calabi-Yau hypersurfaces are themselves realizable as toric varieties. Hence, we can make use of the machinery we have outlined to not only describe the target spaces of our nonlinear σ -model conformal theories but also their associated moduli spaces.

In this subsection we shall outline how the partially enlarged Kähler moduli space is realized as a toric variety and in the next subsection we will do the same for the complex structure moduli space.

First we require a definition for the partially enlarged moduli space. The region of moduli space we are interested in is the region where one approaches a large radius limit. Let us therefore partially compactify our moduli space of complexified Kähler forms by adding points corresponding to large radius limits.

In the discussion above we showed how a toric variety could be associated to a fan Δ . If the moduli space of the toric variety is also a toric variety itself then we can describe it in terms of another fan (in a different space). This is called the *secondary fan* and will be denoted Σ . Σ is a complete fan and thus describes a compact moduli space. At first we will not study the full fan Σ but rather the fan $\Sigma' \subset \Sigma$, the *partial secondary fan*; we describe this fan in detail below. This fan will specify our partially enlarged moduli space which we will from now on denote by $\mathcal{M}_{\Sigma'}$.

Recall the exact sequence we had for the group $A_{n-1}(V)$ of divisors on V modulo linear equivalence:

$$0 \longrightarrow M \longrightarrow \mathbb{Z}^{\Xi} \longrightarrow A_{n-1}(V) \longrightarrow 0. \quad (3.35)$$

By taking the dual and exponentiating we obtained (3.32) and thus realized V as a holomorphic quotient. Suppose we repeat this process with (3.35) except this time we *do not* take the dual. This will lead to an expression of our toric variety, $\mathcal{M}_{\Sigma'}$, as a compactification of $(\mathbb{C}^*)^{\Xi}/(\mathbb{C}^*)^n \cong (\mathbb{C}^*)^{h^{1,1}(V)}$. This is just the right form for a moduli space of “complexified Kähler forms” as discussed earlier in subsection 2.4.

To actually specify the compactification of the above dense open subset of $\mathcal{M}_{\Sigma'}$, we recall our discussion of subsection 3.2. There we indicated that compactifications in toric geometry are specified by following particular families of one parameter paths out towards infinity. The limit points of such paths become part of the compactifying set. The families of paths to be followed are specified by cones in the associated fan, as we have discussed. This formalism presents us with a tailor made structure for compactifying the (partially) enlarged Kähler moduli space: take the cones in the associated fan Σ' to be the Kähler cone of V adjoined with the Kähler cones of its neighbours related by flops. The interior of each such cone, now interpreted as a component of Σ' , gives rise to one point in the compactification of the partially enlarged Kähler moduli space. This point is clearly the infinite radius limit of the Calabi-Yau space corresponding to the chosen Kähler cone. These are the marked points in figure 3.

The final point of discussion, therefore, is the construction of the Kähler cone of V and its flopped neighbours. Now, in all of the applications we shall study, these various

birational models will all arise as different desingularizations of a single underlying singular variety V_s . As discussed in subsection 3.3, these desingularizations can be associated with different fans, Δ , and are all related by flops of rational curves. Furthermore, from subsection 3.5, the construction of Δ amounts to a triangulation of P° with vertices lying in the set Ξ . Thus, we expect that the cones in Σ' will be in some kind of correspondence with the triangulations based in Ξ . We will now describe the precise construction of Σ' .

To understand the construction of the partial secondary fan, we will need one technical result which we now state without proof after some preliminary definitions. (The proofs can be found in [34,35] in the smooth case, and in [37] in the singular case.) We can consider the intersection of the fan Δ with P° to determine a triangulation of P° , with vertices taken from the set of points $P^\circ \cap N$. We recall that this is a special kind of triangulation (this point will be important later in this paper). That is, there is a point, O , in the interior of P which is a vertex of every simplex in the triangulation. For each n -dimensional simplex β in Δ we define a real linear function by specifying its value at each of the n vertices of β except for O . The linear function vanishes at O . Let us denote by ψ_β such a function defined on $\beta \in \Delta$. We can extend ψ_β by linearity to a smooth function on all of $N_{\mathbb{R}}$ which we shall denote by the same symbol. Now, we can also define a continuous (but generally not smooth) function $\psi_\Delta : N_{\mathbb{R}} \rightarrow \mathbb{R}$ simply by assigning a real number to each point in $\Delta \cap N$ except O and within each cone over a simplex, β , defining the value of ψ_Δ to be ψ_β extended beyond P by linearity. In general this construction will yield ‘‘corners’’ in ψ_Δ at the boundaries between cones.

We say that ψ_Δ is *convex* if the following inequality holds:

$$\psi_\beta(p) \geq \psi_\Delta(p) \tag{3.36}$$

for all points $p \in N_{\mathbb{R}}$. Similarly, ψ_Δ is *strictly convex* if the equality is true only for points within the cone containing β . The theorem alluded to above which we shall need states that

$$\text{Space of Kähler forms on } V_\Delta \cong \frac{\text{Space of strictly convex } \psi_\Delta}{\text{Space of smooth } \psi_\Delta}. \tag{3.37}$$

When V_Δ is singular we must interpret the ‘‘Kähler forms’’ in this theorem in an orbifold sense [37].

This theorem can also be used to determine whether V_Δ is Kähler or not. If V_Δ is not Kähler then its Kähler cone will be empty. Thus

$$V_\Delta \text{ is Kähler} \Leftrightarrow \Delta \text{ admits a strictly convex } \psi_\Delta. \tag{3.38}$$

Such a fan is called *regular*.

Given Δ , then, we can in principle determine the structure of the Kähler cone ξ_Δ associated to this particular desingularization. Now consider two smooth toric varieties X_{Δ_1} and X_{Δ_2} which are obtained from two different fans Δ_1 and Δ_2 whose intersections with P° give triangulations based on the same set Ξ . This will give two cones ξ_{Δ_1} and ξ_{Δ_2} within the space $A_{n-1}(V)_\mathbb{R}$. A function which is strictly convex over Δ_1 cannot be strictly convex over Δ_2 and so ξ_{Δ_1} and ξ_{Δ_2} can only intersect at their boundaries. Thus, the Kähler cones of different birational models fill out different regions of $A_{n-1}(V)_\mathbb{R}$ [41]. We can define the partial secondary fan Σ' to consist of all such cones ξ_Δ , together with all of their faces.

If we take X_{Δ_1} and X_{Δ_2} to be related by a flop then ξ_{Δ_1} and ξ_{Δ_2} touch each other on a codimension 1 wall. One can persuade oneself of this fact by carefully studying figure 11. The base of the polytope in each case in this figure is a section of the fan and the value of ψ_Δ is mapped out over this base. The condition that ψ_Δ is convex is simply the statement that the resultant surface is convex in the usual sense. One can move through the space $A_{n-1}(V)_\mathbb{R}$ by varying the heights of the solid dots above the base. Note that the flop transition can be achieved by changing the value of ψ_Δ at just one of the points in Ξ . (One can mod out by smooth affine functions by fixing the solid dots at the edge of the base to be at height zero.)

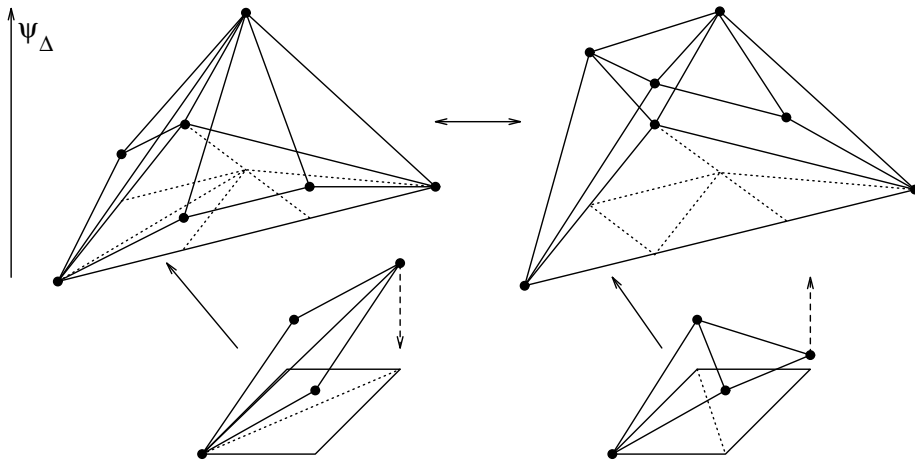

Figure 11. A flop in terms of the function ψ_Δ .

This shows that the smooth resolutions of V_s correspond to cones in $A_{n-1}(V)_{\mathbb{R}}$ touching each other along codimension 1 walls if they are related by flops. We now want to explicitly find these cones. In practice, the authors of [41,42] have given a simple algorithm for carrying out this procedure:

Define an $n \times (r - 1)$ matrix A whose columns are the coordinates of the elements of Ξ in N . Define an integer matrix B as a matrix whose columns span the kernel of A . We will denote the row vectors of B as b_i , $i = 1 \dots r - 1$. These vectors are vectors in the lattice $A_{n-1}(V)$.

Each big cone $\sigma \in \Delta$ is specified by its one-dimensional subcones and thus n elements of Ξ , say ρ_i , $i \in I$. We can then specify a big cone ξ_σ in $A_{n-1}(V)_{\mathbb{R}}$ as the cone which has one-dimensional edges given by $\{b_j\}$ where j runs over the *complement* of the set I . We then describe the cone ξ_Δ associated to Δ as

$$\xi_\Delta = \bigcap_{\sigma \in \Delta} \xi_\sigma. \quad (3.39)$$

The cones ξ_Δ for different resolutions of singularities fit together to form a fan — the partial secondary fan. As its name suggests this fan is not complete and thus does not yield a compact moduli space. We will explicitly carry out this procedure for a particular example in section V.

3.9. Toric Geometry of the Complex Structure Moduli Space

Let us consider the moduli space of complex structures on a hypersurface within a weighted projective space. We will use the $n + 1$ homogeneous coordinates $[z_0, \dots, z_n]$. If we write down the most general form of the equation defining the hypersurface (i.e., include all terms compatible with the weight of each coordinate) we obtain something like

$$p = a_0 z_0 z_1 \dots z_n + \dots + a_s z_0^{p_0} + a_{s+1} z_1^{p_1} + \dots + a_d z_d^{n_d} + \dots + a_i z_1^{n_1^i} z_2^{n_2^i} + \dots = 0. \quad (3.40)$$

Let k be the number of terms in this polynomial. As we vary the complex coefficients a_i we may or may not vary the complex structure of the hypersurface. Some of the variations in a_i give nothing more than reparametrizations of the hypersurface and so cannot affect the complex structure. (Moreover, sometimes not all of the possible deformations of complex structure can be achieved by deformations of the above type. This always happens for K3 surfaces for example and can happen in complex dimension 3 if the algebraic variety has

not been embedded in a large enough ambient space [22].) A simple reparametrization of the hypersurface is given by the $(\mathbb{C}^*)^{n+1}$ action

$$(\mathbb{C}^*)^{n+1} : (z_0, z_1, \dots, z_n) \rightarrow (\alpha_0 z_0, \alpha_1 z_1, \dots, \alpha_n z_n), \quad \alpha_i \in \mathbb{C}^*. \quad (3.41)$$

We will consider the case where the only local deformations¹⁸ of the polynomial (3.40) which fail to give a deformation of complex structure are deformations which amount to a reparametrization of the form (3.41). One should note that this is quite a strong requirement and excludes, for example, the quintic hypersurface in \mathbb{P}^4 which has a group of reparametrizations isomorphic to $Gl(5, \mathbb{C})$ rather than $(\mathbb{C}^*)^5$. Also, if some of the deformations of complex structure are obstructed in the sense of [22] (as indeed will happen in our example) then we only recover a lower dimensional subspace of the moduli space.

If we first assume that none of the a_i 's vanish then we describe an open subset \mathcal{M}_0 of our moduli space of the form $(\mathbb{C}^*)^k / (\mathbb{C}^*)^{n+1} \cong (\mathbb{C}^*)^{k-n-1}$. By allowing some of the a_i 's to vanish we can (partially) compactify this space. It would thus appear that our moduli space is a toric variety.

It turns out that to exhibit mirror symmetry most straight-forwardly we need to modify the above analysis slightly. Let us impose the condition

$$a_0 = 1. \quad (3.42)$$

This reduces the $(\mathbb{C}^*)^{n+1}$ invariance to $(\mathbb{C}^*)^n$ — we have used the other \mathbb{C}^* to rescale the entire equation, in setting $a_0 = 1$. Now as explained earlier, each monomial in (3.41) is represented by a point in P in the lattice M . The condition that all reparametrizations are given by (3.41) may be stated in the form that there are no points from $P \cap M$ in the interior of codimension one faces on P . It can be seen that the $(\mathbb{C}^*)^n$ action on any monomial is given by the coordinates of this point in M . This gives rise to the following exact sequence

$$1 \longrightarrow \exp(2\pi i N_{\mathbb{C}}) \longrightarrow (\mathbb{C}^*)^{k-1} \longrightarrow \mathcal{M}_0 \longrightarrow 1 \quad (3.43)$$

which gives another description of \mathcal{M}_0 . The $(\mathbb{C}^*)^{k-1}$ is the space of polynomials with non-zero coefficients and \mathcal{M}_0 is the resultant open subset of the moduli space in which no coefficient vanishes. This open set can then be compactified by adding suitable regions derived from places where some of the coefficients vanish. Thus we have again arrived at something resembling a toric variety.

¹⁸ Note that we have left open the possibility that there are other, more global deformations which do not affect the complex structure. These would take the form of discrete symmetries preserving the equation (3.40). We shall ignore such symmetries for the purposes of this paper; their effects on the analysis of the moduli space are discussed in detail in [37].

4. Mirror Manifolds and Toric Geometry

In the previous section we have given some background on how one realizes certain families of Calabi-Yau spaces in the formalism of toric geometry. As is clear from that discussion, many of the detailed properties and desired manipulations of these spaces are conveniently encoded in combinatorial lattice data. We now describe how aspects of mirror symmetry can also be formulated using toric methods.

4.1. Toric Approach to Mirror Manifolds

It was originally discovered by S-S. Roan [13] that the mirror manifold construction of [5] has a simple and natural description in toric geometry. Roan found that when the orbifolding occurring in [5] was described in toric terms, it led to an identification between the N lattice of X and the M lattice of its mirror Y . From this, he could show mathematically that the Hodge numbers of the pairs constructed in [5] satisfy the appropriate equalities. The results of Roan, therefore, indicate that toric methods provide the correct mathematical language to discuss mirror symmetry.

After Roan's work, Batyrev [14] has further pursued the application of toric methods to mirror symmetry and successfully generalized Roan's results. Batyrev's idea is based on the fact, discussed in section III, that for a Calabi-Yau hypersurface in a toric variety the polyhedron P in the M lattice contains the data associated with the complex structure deformations and the polar polyhedron P° in the N lattice contains data associated with the Kähler structure. Since mirror symmetry interchanges these data it is natural to suspect that if X and Y are a mirror pair, and if each has a realization as a toric hypersurface, then the polyhedron P associated to X , say P_X , and its polar P_X° should be isomorphic to P_Y° and P_Y , respectively. In fact, Batyrev has shown that for any Calabi-Yau hypersurface X in a toric variety described by the polyhedra P and P° in M and N respectively, if we construct a new hypersurface Y by interchanging the roles of P and P° then the result is also Calabi-Yau and furthermore has Hodge numbers consistent with Y being the mirror of X . This result of Batyrev agrees with that of Roan in the special case of quotients of Fermat-type hypersurfaces X and Y being related by orbifolding, but goes well beyond this class of examples. It must be borne in mind, though, that true mirror symmetry involves much more than these equalities between Hodge numbers. While it seems quite possible that the new pairs constructed by Batyrev are mirrors, establishing this would require showing that both members of a proposed pair correspond to isomorphic conformal theories. This, as yet, has not been done. We therefore confine our attention to the use of toric methods for those examples in which the latter conformal field theory requirement has been established — namely those of [5].

4.2. Complex Structure vs. Kähler Moduli Space: A Puzzle

In subsections 3.8 and 3.9 we described the Kähler and complex structure moduli spaces of a Calabi-Yau hypersurface in a toric variety using toric geometry, as these moduli spaces themselves are toric. If X and Y are a mirror pair, then the Kähler moduli space of X must be isomorphic to the complex structure moduli space of Y and vice versa. This statement, however, immediately presents us with the puzzle discussed in subsection 2.5. Namely, the Kähler moduli space is partitioned into cells with the walls of the partitions corresponding to singular geometrical configurations in which a curve has been blown down to a point. From the point of view of toric geometry, these cells correspond to the different cones in the partial secondary fan of subsection 3.8. The locus of points in the complex structure moduli space which correspond to singular geometrical configurations, however, has a very different character. Rather than being real codimension one, and hence partitioning the moduli space, they are complex codimension one and hence can generically be avoided when traversing a path between any two points in the moduli space. How, therefore, can the two spaces of figures 1 and 3 be isomorphic?

There are two possible answers to this question:

1) It might be that only one region of figure 1 has a physical interpretation and, under mirror symmetry, corresponds to the whole complex structure moduli space. This helps to resolve the puzzle as we can traverse a nonsingular path between any two points in a given Kähler region just as we could in the complex structure moduli space. Such a resolution of this puzzle would imply that flops have no physical interpretation, that the string somehow picks out one of the many possible resolutions of singularities and that, unfortunately, topology change in string theory cannot be realized in this manner.

2) The second possible resolution is that *all* of the regions in figure 1 have a physical realization and that a generic point on a cell wall (which corresponds under mirror symmetry to a perfectly smooth complex structure on Y) although geometrically singular, is physically smooth. This resolution of the puzzle would therefore imply that flops have a physical realization and, in fact, would provide us with an operation for changing the topology of spacetime in a physically smooth manner.

The purpose of [8] and the present work is to present strong evidence that resolution number two is correct. Let us, therefore, elaborate on this possibility.

We recall from our discussion in section II that the mathematical descriptions we have given for the complex and Kähler moduli spaces in general are lowest order approximations

to the true conformal field theory moduli spaces. Therefore, a more precise statement of the isomorphism of moduli spaces following from mirror symmetry is: the sector of the conformal field theory moduli space whose lowest order description is given by the Kähler moduli space of X is isomorphic to the sector of the conformal field theory moduli space whose lowest order description is given by the complex structure of Y , and vice versa. Now, due to certain nonrenormalization theorems [43,44], the complex structure moduli space actually describes the corresponding sector of conformal field theory moduli space exactly. Even without such a result, we can always focus on a regime in which the volume of Y is large (corresponding to a point of large complex structure on X) and hence be able to trust quantum field theory perturbation theory. The latter assures us that nonsingular choices for the complex structure of Y yield physically well behaved conformal field theories. On the other hand, near a wall within the Kähler moduli space of X perturbation theory becomes an increasingly poor guide to the physics as the volume of certain rational curves becomes small. Thus, we cannot trust the classical result that the manifold becomes singular at the wall to necessarily indicate that the physics becomes singular as well. Resolution number two exploits this possibility to the fullest.

How can we choose between these two possible solutions to the issue we have raised? There is a very delicate prediction which emerges from solution (2) but not from (1): solution (2) implies that each point in figure 3 corresponds, under mirror symmetry, to some point in the complex structure moduli space of Y (we imagine keeping the complex structure of X and the Kähler structure of Y fixed). Correlation functions calculated in the two corresponding nonlinear σ -models should therefore be identically equal (if the corresponding operators have been normalized identically). Thus, a sensitive test of solution (2) is to calculate a set of correlation functions at a particular point in each of the cells of the Kähler moduli space and show that there are corresponding points in the complex structure moduli space of the mirror such that correlation functions of corresponding observables (under the identifications following from mirror symmetry) give identical answers. A specific example of an equality which follows from this reasoning is given in eqn (2.6).

Ideally, to carry out this important test we would understand the precise map between points in the Kähler moduli space of X to points in the complex structure moduli space of Y (the “mirror map”) and also the precise map between observables in the theory based on X to those of the theory based on Y . In reality, though, we can carry out this test without such precise knowledge of the mirror map, so long as we carefully choose the points in the Kähler moduli space around which we do our calculation. Namely, if we choose the

large radius points in each of the Kähler cells (corresponding to large radius Calabi-Yau manifolds which are birationally equivalent but topologically distinct) then toric geometry, as we shall now discuss, provides us with a tool for locating the corresponding “large complex structure” points on the mirror and also for mapping between observables in the two models. We emphasize that solution (2), in contrast with (1), implies that the equalities of correlation functions we have mentioned follows for *any and all* choices of points in the partially enlarged Kähler moduli space (that is, including all of the bordering regions we have been discussing). Our choice to work near large radius points is therefore one of convenience (calculations are easier there) and in no way compromises or yields an approximate result.

4.3. Asymptotic Mirror Symmetry and The Monomial-Divisor Mirror Map

Given a specific manifold X at some large radius limit our aim is to determine precisely which “large complex structure limit” its mirror partner Y has attained. This can be achieved if we can find the mirror map between the complexified Kähler moduli space of X and the moduli space of complex structures of Y . We have already seen in the preceding sections that in the cases we are considering, both these spaces are isomorphic to toric varieties which are (compactifications of) $(\mathbb{C}^*)^\Xi/(\mathbb{C}^*)^n$.

In the case of the moduli space of complexified Kähler forms on X , Ξ represented the set of toric divisors on X . The $(\mathbb{C}^*)^n$ action represents linear equivalence and is determined by the arrangement of the points corresponding to Ξ in the lattice N . In the case of the moduli space of complex structures on Y , using the results of subsections 3.9 and 4.1, Ξ now represents the set of monomials in the defining equation for Y (with the exception of the a_0 term) and the $(\mathbb{C}^*)^n$ action represents reparametrizations determined by the arrangement of the points of Ξ in the lattice N .

We have thus arrived at a natural proposal for the mirror map, namely to simply identify the divisors of X given by $\Xi \subset N$ with the monomials of Y also given by $\Xi \subset N$. The induced map between the moduli spaces is called the *monomial-divisor map*, and it is unique up to symmetries of the point set $\Xi \subset N$. However, it turns out that although this proposal for a mirror map has the correct asymptotic behavior near the large radius limit points, it unfortunately differs from the actual mirror map away from large radius limits. More will be explained concerning this point in [45]. This problem was also observed from a different view-point in [12] where extra small-scale instantons appeared in the “A-model”. Fortunately our only concern in this paper is with large radius limits and so we may take

this naïve identification of the two moduli spaces as an approximation of the true mirror map which is adequate for our purposes. For a more mathematical discussion of these points see [37].

In order to determine the large radius limits of X we now consider compactifications of $(\mathbb{C}^*)^\Xi/(\mathbb{C}^*)^n$. In terms of the Kähler form, J , on X we are studying a limit in which $e^{2\pi i(B+iJ)} \rightarrow 0$ by taking $J \rightarrow \infty$ inside the Kähler cone, ξ_X , of X .¹⁹ In the language of toric geometry, this point added to the moduli space is given by the cone $\xi_X \subset A_{n-1}(V)_\mathbb{R}$. In this way we determine a compactification of the space of complexified Kähler forms on X which includes all large radius limits. It is the toric variety given by the Kähler cone of X and its neighbours with respect to the lattice $A_{n-1}(V)$.

A large radius limit of X can now be translated into a large complex structure limit of Y . The fact that J remains within ξ_X dictates the relative growth of the coefficients a_i of the monomials as they are taken to ∞ (or 0). Any path in the moduli space with the property that the coefficients of the corresponding family of hypersurfaces obey these growth properties will approach the large complex structure limit point specified by ξ_X . We will now demonstrate how this can be done explicitly by an example.

5. An Example

In the previous section we described the application of toric geometry to mirror symmetry and showed how these methods could be used to verify or disprove our claim that the mathematical operation of flopping rational curves — which can result in the change of topology of the underlying space — is physically realized and perfectly well behaved. We will now carry out this procedure in a specific example. We emphasize that although we work in a specific example of a particular Calabi-Yau and its mirror (chosen for their relative calculational simplicity) our results are certainly general. Namely, the operation of flopping is a local operation which is insensitive to global properties of the space. If we can show that flopping is physically sensible and realizable in a specific example, it will certainly have these desired properties in any other example as the local description and hence physical phenomenon will be the same.

¹⁹ More precisely, ξ_X represents that part of the Kähler cone of X which comes from the ambient space V — it is in reality the Kähler cone of V that we study.

5.1. A Mirror Pair of Calabi-Yau Spaces

We require an example sufficiently complicated to exhibit flops. We also imposed a condition in subsection 3.9 to obtain a toric structure for the moduli space. That is, we require the group of reparametrizations of the hypersurface equation to be $(\mathbb{C}^*)^5$. The following example is one of the simplest cases meeting these requirements.

Let X_s be a hypersurface in $V \cong \mathbb{P}_{\{6,6,3,2,1\}}^4$ given by

$$f = z_0^3 + z_1^3 + z_2^6 + z_3^9 + z_4^{18} = 0. \quad (5.1)$$

This space has quotient singularities inherited from $\mathbb{P}_{\{6,6,3,2,1\}}^4$. Namely, there are two curves of \mathbb{Z}_2 and \mathbb{Z}_3 singularities respectively and these intersect at three points which locally have the form of \mathbb{Z}_6 singularities. These singularities are the same as the singularities studied in [18]. Any blow-up of these singularities to give a smooth X gives an exceptional divisor with 6 irreducible components, thus $h^{1,1}(X) = 7$. When one resolves the singularities in $\mathbb{P}_{\{6,6,3,2,1\}}^4$ one only obtains an exceptional set with 4 components. One of these components intersects X in regions around the 3 former \mathbb{Z}_6 quotient singularities. Thus 3 elements of $H^2(X)$ are being produced by a single element of $H^2(V)$.

In terms of Kähler form moduli space one can picture this as follows. Each of the three \mathbb{Z}_6 quotient singularities contributes a component of the exceptional divisor. As far as the Kähler cone of X is concerned the volume of these three divisors can be varied independently. If we wish to describe the Kähler form on X in terms of a Kähler form on V however, these three volumes had better be the same since they all come from one class in $H^2(V)$. Thus we are restricting to the part of the moduli space of Kähler forms on X where these three volumes are equal. An important point to notice is that even though we are ignoring some directions in moduli space, we can still get to a large radius limit where *all* components of the exceptional divisor in X are large.

The toric variety $\mathbb{P}_{\{6,6,3,2,1\}}^4$ is given by complete fan around O whose one dimensional cones pass through the points

$$\begin{aligned} \alpha_5 &= (1, 0, 0, 0) \\ \alpha_6 &= (0, 1, 0, 0) \\ \alpha_7 &= (0, 0, 1, 0) \\ \alpha_8 &= (0, 0, 0, 1) \\ \alpha_9 &= (-6, -6, -3, -2). \end{aligned} \quad (5.2)$$

This data uniquely specifies the fan in this case. (The reason for the curious numbering scheme will become apparent.) This fan is comprised of five big cones most of which have volume > 1 . For example, the cone subtended by $\{\alpha_5, \alpha_7, \alpha_8, \alpha_9\}$ has volume 6. The sum of the volumes of these 5 cones is 18 and thus we need to subdivide these 5 cones into 18 cones to obtain a smooth Calabi-Yau hypersurface. The extra points on the boundary of P° which are available to help us do this are

$$\begin{aligned}
 \alpha_1 &= (-3, -3, -1, -1) \\
 \alpha_2 &= (-2, -2, -1, 0) \\
 \alpha_3 &= (-4, -4, -2, -1) \\
 \alpha_4 &= (-1, -1, 0, 0).
 \end{aligned}
 \tag{5.3}$$

Note that, as required, none of these points lies in the interior of a codimension one face of P° . Any complete fan Δ of simplicial cones having *all* of the lines through $\{\alpha_1, \dots, \alpha_9\}$ as its set of one-dimensional cones will consist of 18 big cones and specify a smooth Calabi-Yau hypersurface, but the data $\{\alpha_1, \dots, \alpha_9\}$ does not uniquely specify this fan.

A little work shows that there are 5 possible fans consistent with this data, all of which are regular. That is, all 5 possible toric resolutions of $\mathbb{P}^4_{\{6,6,3,2,1\}}$ are Kähler. We can uniquely specify the fan Δ just by specifying the resulting triangulation of the face $\{\alpha_7, \alpha_8, \alpha_9\}$. The possibilities are shown in figure 12 and in figure 13 the three-dimensional simplices are shown for resolution Δ_1 .

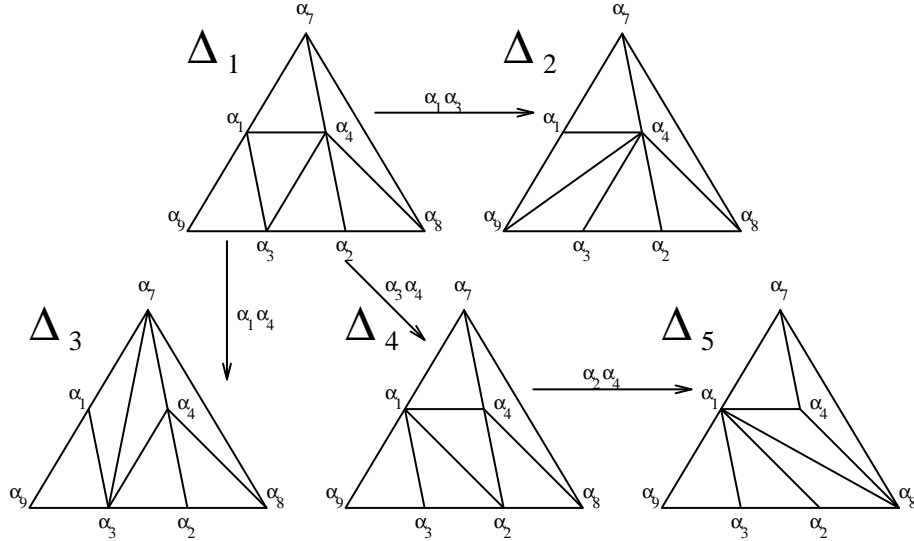

Figure 12. The five smooth models.

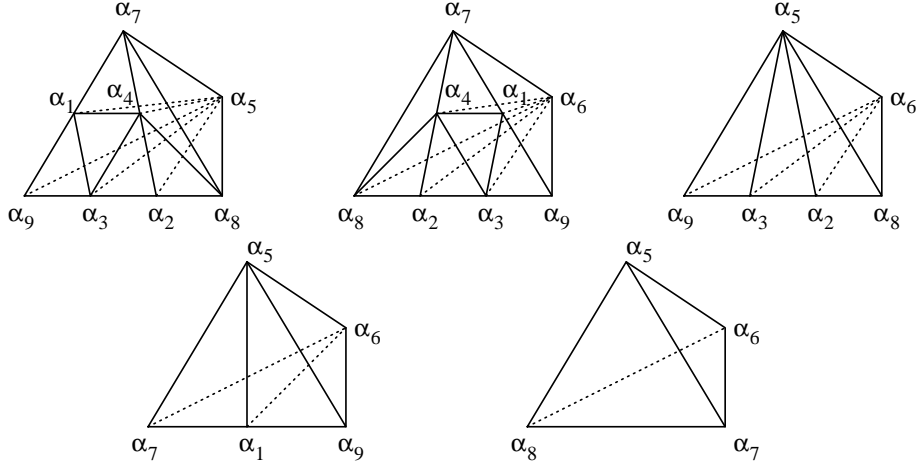

Figure 13. The tetrahedra in resolution Δ_1 .

To obtain Y as a mirror of X , we divide X by the largest “phase” symmetry consistent with the trivial canonical bundle condition [5]. This is given by the following generators:

$$\begin{aligned}
 [z_0, z_1, z_2, z_3, z_4] &\rightarrow [\omega z_0, z_1, z_2, z_3, \omega^2 z_4] \\
 [z_0, z_1, z_2, z_3, z_4] &\rightarrow [z_0, \omega z_1, z_2, z_3, \omega^2 z_4] \\
 [z_0, z_1, z_2, z_3, z_4] &\rightarrow [z_0, z_1, \omega z_2, z_3, \omega^2 z_4],
 \end{aligned} \tag{5.4}$$

where $\omega = \exp(2\pi i/3)$. This produces a whole host of quotient singularities but since we are only concerned with the complex structure of Y we can ignore this fact.

In light of the results of [12] and the discussion in section VI, we should actually be more careful in our use of language here. To be more precise, given the *Landau-Ginzburg* model X_{LG} whose superpotential is specified in (5.1), we can construct another Landau-Ginzburg theory Y_{LG} as the orbifold of X_{LG} by the group generated by (5.4) and having the same superpotential (5.1). Y_{LG} is the mirror of X_{LG} . Up to now however, we had assumed that X and Y were smooth Calabi-Yau manifolds. As shown in [12] and as will become clear in section VI, the smooth Calabi-Yau manifolds occupy a different region of the same moduli space as the Landau-Ginzburg theory. Thus if we deform *both* of our mirror pair X_{LG} and Y_{LG} , then we can obtain two smooth mirror manifolds X and Y . If we wanted to compare all correlation functions of the conformal field theories of X and Y then we would have to do this. All we are going to do in this section however is to compare information concerning the Kähler sector of X with the complex structure sector of Y . Information concerned with the complex structure of Y as a smooth manifold is isomorphic to that of

Y_{LG} . Thus, there is no real need to deform Y_{LG} into a smooth Calabi-Yau manifold. In figure 14 we show very roughly the slice in which we do the calculation in this section. Note that this figure is very oversimplified since the moduli space typically splits into many more regions and indeed the whole point of this calculation is to show that the area concerned spans more than one region.

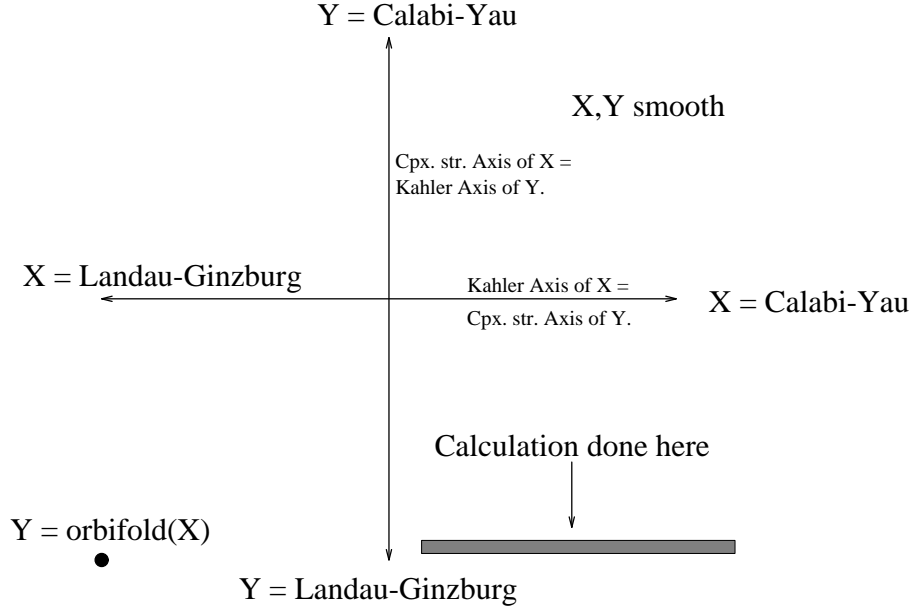

Figure 14. Area of Kähler sector of X and Y where we perform calculation.

The most general deformation of (5.1) consistent with this $(\mathbb{Z}_3)^3$ symmetry group is

$$\begin{aligned}
 W = a_0 z_0 z_1 z_2 z_3 z_4 + a_1 z_2^3 z_4^9 + a_2 z_3^6 z_4^6 + a_3 z_3^3 z_4^{12} + a_4 z_2^3 z_3^3 z_4^3 \\
 + a_5 z_0^3 + a_6 z_1^3 + a_7 z_2^6 + a_8 z_3^9 + a_9 z_4^{18} = 0.
 \end{aligned}
 \tag{5.5}$$

One can show that $h^{2,1}(Y) = 7$. The group of reparametrizations of (5.5) is indeed $(\mathbb{C}^*)^5$ as required which shows that we obtain 5 deformations of complex structure induced by deformations of (5.5). Note that for both X and Y we had 7 deformations of which only 5 will be analyzed via toric geometry. It is no coincidence that these numbers match — it follows from the monomial-divisor mirror map.

5.2. The Moduli Spaces

Let us now build the cones in $A_{n-1}(V)_{\mathbb{R}}$ to form the partial secondary fan. The method was outlined in subsection 3.8. We first build the 4×9 matrix A with columns

$\alpha_1, \dots, \alpha_9$. From this we build the 9×5 matrix B whose columns span the kernel of A . The rows of B give vectors in $A_{n-1}(V)_{\mathbb{R}}$. Note that a change of basis of the kernel of A thus corresponds to a linear transformation on $A_{n-1}(V)_{\mathbb{R}}$. In order for us to translate the coordinates in $A_{n-1}(V)_{\mathbb{R}}$ into data concerning the coefficients a_i in the complex structure of Y we need to chose a specific basis in $A_{n-1}(V)_{\mathbb{R}}$.

We have already fixed $a_0 = 1$. We still have a $(\mathbb{C}^*)^4$ action on the other a_1, \dots, a_9 by which can fix 4 of these coefficients equal to one. Let us choose $a_5 = a_6 = a_7 = a_8 = 1$ and denote the matrix that corresponds to this choice as B_1 . Our 5 degrees of freedom are given by $\{a_1, a_2, a_3, a_4, a_9\}$. We want that a point with coordinates $(b_1, b_2, b_3, b_4, b_5)$ in $A_{n-1}(V)_{\mathbb{R}}$ corresponds to $\{a_1 = e^{2\pi i(c_1+ib_1)}, a_2 = e^{2\pi i(c_2+ib_2)}, \dots, a_9 = e^{2\pi i(c_5+ib_5)}\}$ for some value of the B -field (c_1, \dots, c_5) . This means our matrix B_1 should be of the form

$$B_1 = \begin{pmatrix} 1 & 0 & 0 & 0 & 0 \\ 0 & 1 & 0 & 0 & 0 \\ 0 & 0 & 1 & 0 & 0 \\ 0 & 0 & 0 & 1 & 0 \\ B_{5,1} & B_{5,2} & B_{5,3} & B_{5,4} & B_{5,5} \\ B_{6,1} & B_{6,2} & B_{6,3} & B_{6,4} & B_{6,5} \\ B_{7,1} & B_{7,2} & B_{7,3} & B_{7,4} & B_{7,5} \\ B_{8,1} & B_{8,2} & B_{8,3} & B_{8,4} & B_{8,5} \\ 0 & 0 & 0 & 0 & 1 \end{pmatrix}.$$

B_1 is now completely determined by the condition that its columns span the kernel of A .

For the actual calculation below, we use a slightly different set of coordinates, choosing $\{a_0, a_1, a_2, a_3, a_4\}$ as the 5 degrees of freedom and setting $a_5 = a_6 = a_7 = a_8 = a_9 = 1$. (We do this to express (5.5) in the form: ‘‘Fermat + perturbation’’, in order to more easily apply the calculational techniques of [33].) The new basis can be obtained from B_1 by using a \mathbb{C}^* action $\lambda : z_4 \rightarrow \lambda z_4$. We obtain the following matrix:

$$B = \begin{pmatrix} 0 & 1 & 0 & 0 & 0 \\ 0 & 0 & 1 & 0 & 0 \\ 0 & 0 & 0 & 1 & 0 \\ 0 & 0 & 0 & 0 & 1 \\ -\frac{1}{3} & 0 & 0 & 0 & 0 \\ -\frac{1}{3} & 0 & 0 & 0 & 0 \\ -\frac{1}{6} & -\frac{1}{2} & 0 & 0 & -\frac{1}{2} \\ -\frac{1}{9} & 0 & -\frac{2}{3} & -\frac{1}{3} & -\frac{1}{3} \\ -\frac{1}{18} & -\frac{1}{2} & -\frac{1}{3} & -\frac{2}{3} & -\frac{1}{6} \end{pmatrix}.$$

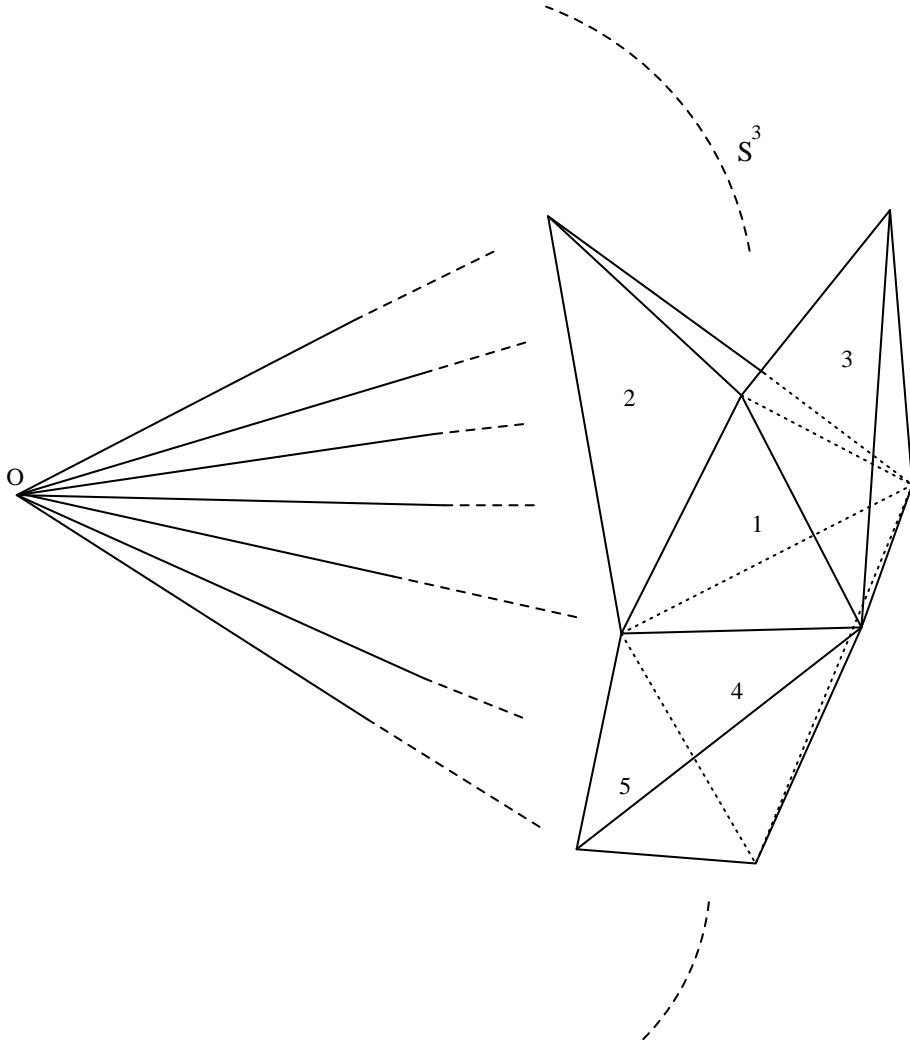

Figure 15. The partial secondary fan.

For each of the resolutions $\Delta_1, \dots, \Delta_5$ we can now construct the corresponding cone in Σ' following the method in subsection 3.8 using the B matrix above. These five cones are shown schematically in figure 15 and the explicit coordinates in table 1.

Note that as expected the fan we generate, Σ' , is not a complete fan and does not therefore correspond to a compact Kähler moduli space.

We now wish to translate this moduli space of Kähler forms into the equivalent structure in the moduli space of complex structures on Y . The way that we picked the basis in the B matrix in this section tells us exactly how to proceed. For a point (u_0, u_1, \dots, u_4) in $A_{n-1}(V)_{\mathbb{R}}$ we define

$$w_k = e^{2\pi i(c_k + iu_k)} \tag{5.6}$$

v_1	$(-\frac{1}{3}, 0, 0, 0, 0)$
v_2	$(-\frac{7}{18}, -\frac{1}{2}, -\frac{1}{3}, -\frac{2}{3}, -\frac{1}{6})$
v_3	$(-\frac{1}{6}, -\frac{1}{2}, 0, 0, -\frac{1}{2})$
v_4	$(-\frac{2}{9}, 0, -\frac{1}{3}, -\frac{2}{3}, -\frac{2}{3})$
v_5	$(-\frac{1}{9}, 0, -\frac{2}{3}, -\frac{1}{3}, -\frac{1}{3})$

Table 1a: Generators for first cone

Resolution	Generators
Δ_1	v_1, v_2, v_3, v_4, v_5
Δ_2	$v_1, v_1 - v_2 + v_3 + v_4, v_3, v_4, v_5$
Δ_3	$v_1, v_2, v_2 - v_3 + v_4, v_4, v_5$
Δ_4	$v_1, v_2, v_3, v_2 + v_3 - v_4 + v_5, v_5$
Δ_5	$v_1, v_2, v_3, v_2 + v_3 - v_4 + v_5,$ $v_3 + (v_2 + v_3 - v_4 + v_5) - v_5$

Table 1b: Generators for all cones

for any real c_k 's. This is then mapped to (5.5) by

$$\begin{aligned}
 a_i &= w_i^{-1}, \quad i = 0, \dots, 4 \\
 a_i &= 1, \quad i = 5, \dots, 9.
 \end{aligned}
 \tag{5.7}$$

5.3. Results

We have now done enough work to achieve one of our original goals, i.e., given a specific topology of X we can determine which direction in the moduli space of Y should be taken to find the intersection numbers of X . All we do is take a direction going out to infinity within the interior of the corresponding cone in Σ' and convert this limit by (5.6).

Just as was done in [33], it is easiest to compare intersection numbers from the two methods by computing ratios which would be invariant under rescaling of the monomials in (5.5). There are many such ratios although we will only consider 4 here for brevity. As explained earlier, all intersection numbers are determined by the data in Δ although we only outlined how to calculate the intersection number of three homologically distinct cycles. For the exact method of determining self-intersections we refer to [46] or the method

using the ‘‘Stanley-Reisner ideal’’ in [34]. Some ratios of intersection numbers are given in table 2. In this table, H refers to the proper transform of the hyperplane in $\mathbb{P}^4_{\{6,6,3,2,1\}}$. This can be identified with the point O in P° and thus the monomial with coefficient a_0 . More will be said about this in the next section.

Resolution	Δ_1	Δ_2	Δ_3	Δ_4	Δ_5
$\frac{(D_1^3)(D_4^3)}{(D_1^2 D_4)(D_1 D_4^2)}$	-7	0/0	0/0	∞	9
$\frac{(D_2^2 D_4)(D_3^2 D_4)}{(D_2 D_3 D_4)(D_2^2 D_3 D_4)}$	2	4	0	0/0	0/0
$\frac{(D_2 D_3 D_4)(H D_2^2)}{(D_2^2 D_4)(H D_2 D_3)}$	1	1	1	0	0/0
$\frac{(D_2 D_3 D_4)(H D_1^2)}{(D_1^2 D_4)(H D_2 D_3)}$	2	1	∞	0/0	0

Table 2: Ratios of intersection numbers

We now calculate the corresponding ratios for Y choosing a direction in the secondary fan space along the middle of the cone ξ_Δ . The value of the B field is unimportant and we set it equal to zero. Thus for a direction $(\lambda u_0, \dots, \lambda u_4)$ we take the limit

$$a_i = \lim_{s \rightarrow \infty} s^{u_i}, \quad \text{with } s = e^{2\pi\lambda} \quad (5.8)$$

with a_5, \dots, a_9 set equal to 1. The 3-point functions are determined (up to an overall factor) by using the simple structure of the ring of chiral primary fields. This method was introduced in [47]. It can be shown from the $N = 2$ superconformal algebra [48] that the monomials are members of the ring

$$\mathcal{R} = \frac{\mathbb{C}[z_0, \dots, z_4]}{\left(\frac{\partial W}{\partial z_0}, \dots, \frac{\partial W}{\partial z_4}\right)}, \quad (5.9)$$

where the denominator on the right-hand side denotes the ideal generated by the partial derivatives of W . If the hypersurface generated by $W = 0$ is smooth, i.e., if we are away from the discriminant locus, then this ring structure determines the desired couplings up to an overall factor. The calculational method is that of [33]; the results are shown in table 3. We use the symbol φ_i to denote the field represented by the monomial with coefficient a_i (the factor a_i is included). As expected the results are in full agreement with the predictions in table 2²⁰.

²⁰ We emphasize that the predicted equalities result from our general analysis of the previous sections and are not special to this illustrative example. In fact, Batyrev [49] has recently generalized the calculation of [8] (which we have just reviewed) and shown that the predicted equalities [8] are true for the case of Calabi-Yau’s and mirrors realized as hypersurfaces in toric varieties.

Resolution	Δ_1	Δ_2	Δ_3	Δ_4	Δ_5
Direction	$(\frac{11}{9}, 1, \frac{4}{3}, \frac{5}{3}, \frac{5}{3})$	$(\frac{7}{6}, \frac{1}{2}, 1, 1, \frac{5}{2})$	$(\frac{3}{2}, \frac{1}{2}, 2, 3, \frac{3}{2})$	$(\frac{13}{9}, 2, \frac{5}{3}, \frac{4}{3}, \frac{4}{3})$	$(\frac{11}{6}, \frac{7}{2}, 1, 1, \frac{3}{2})$
$\frac{\langle \varphi_1^3 \rangle \langle \varphi_4^3 \rangle}{\langle \varphi_1^2 \varphi_4 \rangle \langle \varphi_1 \varphi_4^2 \rangle}$	$-7 - 181s^{-1} + \dots$			$-\frac{2}{5}s^2 - \frac{129}{250}s + \dots$	$9 + 289s^{-1} + \dots$
$\frac{\langle \varphi_2^2 \varphi_4 \rangle \langle \varphi_3^2 \varphi_4 \rangle}{\langle \varphi_2 \varphi_3 \varphi_4 \rangle \langle \varphi_2 \varphi_3 \varphi_4 \rangle}$	$2 - 5s^{-1} + \dots$	$4 - 22s^{-1} + \dots$	$0 + 2s^{-1} + \dots$		
$\frac{\langle \varphi_2 \varphi_3 \varphi_4 \rangle \langle \varphi_0 \varphi_2^2 \rangle}{\langle \varphi_2^2 \varphi_4 \rangle \langle \varphi_0 \varphi_2 \varphi_3 \rangle}$	$1 + \frac{1}{2}s^{-1} + \dots$	$1 + \frac{3}{2}s^{-2} + \dots$	$1 + 4s^{-1} + \dots$	$0 - 2s^{-1} + \dots$	
$\frac{\langle \varphi_2 \varphi_3 \varphi_4 \rangle \langle \varphi_0 \varphi_1^2 \rangle}{\langle \varphi_1^2 \varphi_4 \rangle \langle \varphi_0 \varphi_2 \varphi_3 \rangle}$	$2 + 27s^{-1} + \dots$	$1 - \frac{1}{2}s^{-1} + \dots$	$-2s - 33 + \dots$		$0 + 4s^{-2} + \dots$

Table 3: Asymptotic ratios of 3-point functions

The monomial-divisor mirror map [37] allows us to make more specific comparisons. In general one might think that mirror symmetry gives some correspondence in the large-radius limit only up to some factors. For example, we might have

$$D_2 \sim \lambda_2 a_2 z_3^6 z_4^6, \quad (5.10)$$

and similar expressions for the other monomials and divisors, with some constants λ_i being needed to specify the precise correspondence. The invariant ratios calculated in table 3 are designed so that the λ_i factors cancel. The monomial-divisor mirror map asserts however that $\lambda_i = 1$. Thus we should only have one overall scale factor undetermined. (This one scale factor comes from the undetermined factor implicit in using the ring \mathcal{R} to calculate couplings.) As an example, in resolution Δ_1 we have intersection numbers:

$$\begin{aligned} D_1^3 &= -3 \\ D_4^3 &= 21 \\ D_2^2 D_4 &= -6 \\ D_3^2 D_4 &= -3. \end{aligned} \quad (5.11)$$

On Y , we fix the overall constant by demanding that $\langle \varphi_0^3 \rangle = 1$. We then calculate

$$\begin{aligned} \langle \varphi_1^3 \rangle &= -\frac{1}{486}(-3 - \frac{195}{2}s^{-9} + \dots) \\ \langle \varphi_4^3 \rangle &= -\frac{1}{486}(21 + \frac{183}{2}s^{-9} + \dots) \\ \langle \varphi_2^2 \varphi_4 \rangle &= -\frac{1}{486}(-6 - 54s^{-9} + \dots) \\ \langle \varphi_3^2 \varphi_4 \rangle &= -\frac{1}{486}(-3 - \frac{45}{2}s^{-9} + \dots) \end{aligned} \quad (5.12)$$

This verifies the prediction made by the monomial-divisor mirror map that, up to a single overall factor, (5.12) should agree with (5.11) to leading order.

5.4. Discussion

Let us recapitulate what we learn from this example. In subsection 4.2 we presented a puzzle regarding the apparent asymmetry between complex and Kähler moduli spaces. We presented the two possible resolutions of this puzzle and a method of adjudicating between them. In the context of the present example, we have explicitly carried out this distinguishing test and shown that the second resolution of subsection 4.2 is verified. Namely, under mirror symmetry (part of) the complex structure moduli space of Y is isomorphic to the (partially) *enlarged* Kähler moduli space of X (and vice versa)²¹. We have shown this by explicitly verifying that distinct points in the complex structure moduli space of Y are mapped to points in *distinct regions* in the (partially) enlarged Kähler moduli space of X .

Although we have carried out this analysis in the context of a specific example, we want to emphasize that our picture of the enlarged Kähler moduli space, its toric geometric description and its relation to the complex structure moduli space of the mirror, as presented in previous sections, is completely general. The present example has served as an explicit verification.

6. The Fully Enlarged Kähler Moduli Space

The analysis of the moduli spaces thus far leaves unanswered the following interesting question. As the fan Σ' is not complete we can inquire as to what happens if we take a limiting complex structure on Y given by a direction not contained in Σ' . Up to this point, we would be unable to give a corresponding mirror space X for such a limit. The reader might also have noticed the rather asymmetric way we treated the point O in P° and thus the monomial corresponding to a_0 . As we will see, a more symmetric treatment of the polytope P° will open up the other regions of the Kähler moduli space and yield a rich structure. It will turn out that these other regions of moduli space will not have interpretations as smooth Calabi-Yau manifolds and are thus missed by classical σ -model ideas. Thus this rich structure is one example of the differences between classical and quantum geometry.

²¹ In the next section we will consider the fully enlarged Kähler moduli space and show it to be isomorphic to the full moduli space of complex structures on Y .

First let us reconsider the moduli space of complex structures on a hypersurface within a weighted projective space. In (3.42) we artificially singled out a_0 amongst the coefficients so that we could reduce the $(\mathbb{C}^*)^{n+1}$ action on the homogeneous coordinates to the required $(\mathbb{C}^*)^n$ action to obtain a toric variety for the moduli space compatible with the moduli space of Kähler forms. As explained earlier, each monomial in (3.41) is represented by a point in P in the lattice M . Let us introduce a lattice M^+ of dimension $n + 1$ obtained by adding one further generator to the generators of M in an orthogonal direction. Thus P lies in a hyperplane within $M_{\mathbb{R}}^+$. It can be seen that the $(\mathbb{C}^*)^{n+1}$ action on any monomial is given by the coordinates of this point in M^+ . This now gives rise to the following exact sequence

$$1 \longrightarrow \exp(2\pi i M_{\mathbb{C}}^{+*}) \longrightarrow (\mathbb{C}^*)^k \longrightarrow \mathcal{M}_0 \longrightarrow 1. \quad (6.1)$$

The $(\mathbb{C}^*)^k$ is the space of polynomials with non-zero coefficients and \mathcal{M}_0 is the resultant open subset of the moduli space. This process is of course entirely equivalent to (3.43). The difference now comes when we compactify this space. The fact that we can now let $a_0 \rightarrow 0$ opens up new possibilities reflected by the fact that some of the dimensions of the vector spaces in the above exact sequence have increased.

Now let us reconsider the space of Kähler forms on a toric variety specified by a fan Δ , describing it in terms of the triangulation of P° determined by Δ . Consider a simplex in n -dimensions with $n + 1$ vertices. If we attach a real number to each vertex then we have specified an affine function on the simplex whose value at each vertex is the number we specify. Indeed the space of affine functions on this simplex can be given by the space \mathbb{R}^{n+1} of numbers on the vertices. Consider now attaching a real number to each point in the set $\mathcal{A} = P^\circ \cap N$. This can be taken to define a continuous (but not necessarily smooth) function $\Psi_\Delta : N_{\mathbb{R}} \rightarrow \mathbb{R}$ which is a smooth *affine* function in each simplex. The space of all such functions is isomorphic to \mathbb{R}^r , where r is the number of points in $P^\circ \cap N$.

We have previously described the Kähler forms on V_Δ in terms of functions which are linear on each cone; we now modify this to a description in terms of functions which are affine on each simplex. The space of smooth linear functions on $N_{\mathbb{R}}$ is the dual vector space $N_{\mathbb{R}}^*$. We can go to the space of smooth affine functions if we add an extra dimension to get $N_{\mathbb{R}}^{+*}$. We can then write down the following exact sequence

$$0 \longrightarrow N_{\mathbb{R}}^{+*} \longrightarrow \mathbb{R}^r \longrightarrow A_{n-1}(V)_{\mathbb{R}} \longrightarrow 0, \quad (6.2)$$

where the space \mathbb{R}^r is interpreted as the space of functions Ψ_Δ . The Kähler forms are now specified by a convexity condition. In fact, we have the following analogue of (3.37):

$$\text{Space of Kähler forms on } V_\Delta \cong \frac{\text{Space of strictly convex } \Psi_\Delta}{\text{Space of smooth } \Psi_\Delta} \quad (6.3)$$

where this time we take Ψ_Δ from the space \mathbb{R}^r of continuous functions which are affine on each simplex. of Kähler forms on X_Σ will be a subspace of $A_{n-1}(V)_\mathbb{R}$.

We can now repeat the construction of cones in the partial secondary fan in a slightly extended version of the algorithm in subsection 3.8: Extend the coordinates of the r points in \mathcal{A} to coordinates in the $(n+1)$ -dimensional space $N_\mathbb{R}^+$ simply by adding a “1” in the $(n+1)$ th place and take A^+ to be the $(n+1) \times r$ matrix of these column vectors. Denote the columns of A^+ as $a_i, i = 1 \dots r$. Let the kernel of A^+ be spanned by the columns of the $n \times (r-n-1)$ matrix B^+ . Let $b_i^+, i = 1 \dots r$ be the resulting vectors in $A_{n+1}(V)_\mathbb{R}$ whose coordinates are given by the rows of B^+ .

Now each maximal simplicial cone, $\sigma \in \Delta$, is specified by $n+1$ elements of \mathcal{A} , one of the elements being O . Thus when we consider the complimentary set of b_j 's, we never include b_0 . Thus we build precisely the same cone ξ_Δ in the partial secondary fan as we did in subsection 3.8.

We know that this does not fill out the whole of the secondary fan. It is known however that if we consider the set of cones corresponding to all possible triangulations based in \mathcal{A} consistent with the convexity of Ψ_Δ then these do indeed fill out the whole of $A_{n-1}(V)_\mathbb{R}$ [42]. One should note that by all possible triangulations, we include triangulations which may ignore some of the points in \mathcal{A} (although not the points on the vertices of P°). The process of ignoring an interior point and the way it relates to Ψ_Δ is shown in figure 16 (cp. the flop shown in figure 11). We will refer to removing a point in this way as a *star-unsubdivision* (since the inverse process is often known as a star-subdivision). Star unsubdivisions at an arbitrary point are not necessarily allowed since the resultant network might not be a triangulation but when they are allowed, they correspond to a codimension 1 wall of two neighbouring cones in much the same way as a flop did.

In general not all possible triangulations based in \mathcal{A} admit a strictly convex function. A toric variety from such a triangulation does not admit a Kähler metric [41]. It turns out that in our example there are no such triangulations. In more complicated examples however one might have the situation where a smooth Kähler manifold could be flopped

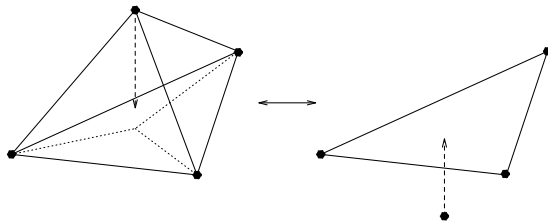

Figure 16. A star-unsubdivision in terms of the function Ψ_{Δ} .

into a smooth non-Kähler manifold. In such a case the non-Kähler manifold would *not* be represented in the space $A_{n-1}(V)_{\mathbb{R}}$.

In our original construction the fan Δ corresponds to a toric variety of complex dimension n in which the Calabi-Yau lives as a hypersurface. A triangulation based in a set of points only determines a fan if there is a point which is a vertex of every maximal-dimension simplex. This point, which is the origin in N , has coordinates $(0, 0, \dots, 0, 1)$ in N^+ . Since we now want to consider all triangulations we will have cases where the triangulation does not determine a fan. There is no obvious way of associating a complex n -fold with many of the cones in the secondary fan. As we are now working in N^+ however, there is an extra dimension which offers the possibility of building a new fan Δ^+ . This fan is shown in figure 17. Define the point O^+ in N^+ with coordinates $(0, 0, \dots, 0, 0)$. Take every simplex in the triangulation of \mathcal{A} and use it as the base of a cone with vertex O^+ . We now have all the necessary ingredients to build a toric $(n+1)$ -fold associated to *every* cone in the secondary fan. Since all the points in \mathcal{A} lie in a hyperplane at distance one from the origin, this $(n+1)$ -fold will have trivial canonical class. It will also be non-compact.

First take the example where Δ is a fan and so we have a toric n -fold V_{Δ} . In this case it can be shown that the toric $(n+1)$ -fold, V_{Δ^+} , has a map

$$\pi : V_{\Delta^+} \rightarrow V_{\Delta}, \tag{6.4}$$

such that our new space is simply a holomorphic line bundle over V_{Δ} . Toric geometry also tells us that V_{Δ^+} has vanishing first Chern class. *It follows that V_{Δ^+} is the total space of the canonical line bundle of V_{Δ} .*

At the other extreme we can take $\Delta \cap P^{\circ}$ to consist of one single simplex, namely P° . In this case V_{Δ^+} is the space \mathbb{C}^{n+1}/G for some abelian group G . In our example we would obtain $\mathbb{C}^5/\mathbb{Z}_{18}$. This is the target space for the Landau-Ginzburg model. We have thus obtained the secondary fan version of the argument in [12], where it was shown that

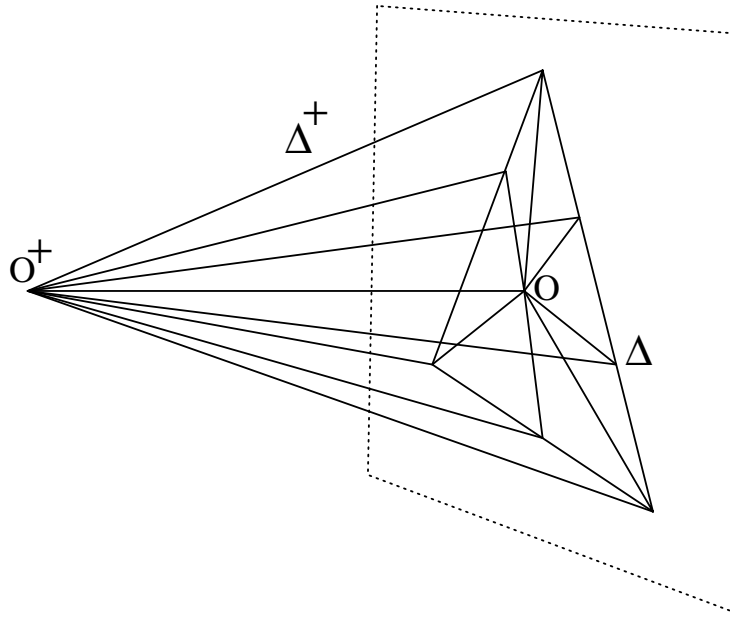

Figure 17. The fan Δ^+ .

a Calabi-Yau σ -model theory and a Landau-Ginzburg theory occupy different regions of the same moduli space.

We should be more specific about the above constructions for Calabi-Yau manifolds and Landau-Ginzburg theories so that we will be able to understand the more complicated examples that follow. The reader should consult [12] for a more detailed discussion of these issues. We have a function $W : V_{\Delta^+} \rightarrow \mathbb{C}$ (the superpotential) which is used to define our theory. This superpotential can be lifted to the space $\mathbb{C}^{\mathcal{A}}$ from which V_{Δ^+} is obtained as a holomorphic quotient. One also knows that V_{Δ^+} is noncompact but will generally have compact submanifolds algebraically embedded within it. The general idea is that the space of vacua of the theory is the critical point set of W in $\mathbb{C}^{\mathcal{A}}$ with the suitable quotient being taken. If the superpotential W is generic, the resulting quotient is the intersection of the compact part(s) of V_{Δ^+} with the locus $W = 0$. In the case of the regions studied in section V the compact part is the smooth toric n -fold and the locus $W = 0$ gives the Calabi-Yau manifold itself. In the case of the Landau-Ginzburg model the compact part is simply the point at the origin and so is contained in $W = 0$ anyway. We also need to consider fluctuations about the vacuum. The potential for such fluctuations is $|\partial W|^2$. In the case of the Calabi-Yau manifold, smoothness tells us that fluctuations normal to the Calabi-Yau manifold will be massive (i.e., have quadratic potential) [12]. Thus, the target

space is precisely the Calabi-Yau manifold. In the case of the Landau-Ginzburg theory these fluctuations are massless and are analyzed in the usual way from the superpotential W .

In addition to σ -models and Landau-Ginzburg theories, there are many other possibilities. In our example, the secondary fan is divided up into 100 cones. That is, there are 100 different triangulations with vertices in the point set $P^\circ \cap N$. Five of these give smooth Calabi-Yau manifolds and one of these is the Landau-Ginzburg theory. There are 94 other regions to explain!

Let us begin by analyzing the structure of the singularities of V_{Δ^+} . In our example, for every cone in the secondary fan the corresponding Δ^+ turns out to be simplicial. Thus, each cone σ spanning p dimensions in Δ^+ is defined by the coordinates of the p vertices of the simplex $\sigma \cap N_{\mathbb{R}}$ at the base of the cone. The volume of that cone is then the volume of the polyhedron spanned by O^+ and that simplex. Volumes are normalized so that the unit simplex in $\mathbb{R}^p = \text{span}(\sigma)$ (with respect to the lattice $N \cap \mathbb{R}^p$) has volume 1. (If we had normalized to make the unit *cube* have volume 1, as is perhaps more common, then we would have needed to multiply by $p!$ to obtain this “simplicial” volume.) The cone represents a smooth part of the toric variety iff this volume is 1. That is, if the volume of a p -cone is greater than 1 then it represents a singularity along a $(n + 1 - p)$ -dimensional subvariety of V_{Δ^+} . The fact that each cone is a cone over a simplex tells us that the singularities in question are quotient singularities. That is, a p -cone of volume v represents a quotient singularity locally of the form \mathbb{C}^p/G where G has order v . This gives the general statement about the correspondence between Landau-Ginzburg models and Calabi-Yau manifolds. The minimal triangulation based in $P^\circ \cap N$ consisting of the single simplex P° is a target space of the form \mathbb{C}^{n+1}/G whereas a maximal triangulation consisting of $|G|$ $(n + 1)$ -cones gives a smooth manifold.

Consider now taking a triangulation corresponding to a smooth Calabi-Yau manifold and star unsubdividing at a point such that O is still a vertex of each simplex of the triangulation. The $(n + 1)$ -dimensional toric variety V_{Δ^+} can still be thought of as the canonical sheaf of V_{Δ} but now V_{Δ} has acquired quotient singularities. That is, V_{Δ} is an orbifold²². This leads to a rather striking conclusion as follows. Geometrically speaking, the orbifolds that arise in the subject of superstring compactification can just be thought of as special cases of Calabi-Yau manifolds. Any quotient singularity arising from an abelian

²² By “orbifold” we mean a space whose only singularities are locally quotient singularities.

group action in three dimensions preserving the holomorphic 3-form can be resolved to give a smooth Calabi-Yau manifold. In this sense orbifolds appear to live *within* the walls of the Kähler cone of a Calabi-Yau manifold. The reverse process to resolution, i.e., the *blowing-down* of a divisor within the Calabi-Yau manifold, appears as a path beginning in the interior of the Kähler cone and ending on the boundary. In this “classical” setting Calabi-Yau manifolds are more general than orbifolds in the sense that they occupy a larger dimensional region of moduli space than do orbifolds. In the light of our preceding discussion it appears that within quantum algebraic geometry one has to modify this viewpoint. Orbifolds now appear to occupy a region of moduli space equal in dimension to that of the Calabi-Yau manifold. One should think of orbifolds as not living within the walls of the Kähler cone of a smooth Calabi-Yau manifold but occupying their own Kähler cone on the other side of the wall!

In our example 27 of the regions correspond to orbifolds. The possible singularities encountered are \mathbb{Z}_2 , \mathbb{Z}_3 , $\mathbb{Z}_2 \times \mathbb{Z}_2$, \mathbb{Z}_4 and \mathbb{Z}_6 quotients.

In these orbifold regions as well as in the smooth Calabi-Yau region, the space V_{Δ^+} may be thought of as a bundle (in some generalized sense to include singularities) over a compact space. This also holds for Landau-Ginzburg theory. In the case of the Landau-Ginzburg theory this compact space is a point and in the Calabi-Yau manifold and orbifold cases this space is a toric d -fold. The other 67 regions of the secondary fan correspond to spaces intermediate between these. The dimension of the compact space may be determined as follows. Within the any particular triangulation based in $P^\circ \cap N$ we may look for complete fans. Any complete fan spanning \mathbb{R}^p corresponds to a toric p -fold. Thus, the maximal p for which a complete fan can be found will give us the dimension of the complex space. The resultant space is not necessarily irreducible however.

Figure 18 shows examples of spaces of intermediate dimension in the case $d = 2$. In example (a) there is no complete fan of dimension 2 in $N_{\mathbb{R}}$ but there is the fan as shown of dimension 1. Thus the dimension of the compact part of the toric variety has gone down by 1 from the smooth Calabi-Yau case. In figure (b) there is a dimension 2 fan (shown as Δ_2) but not all cones are elements of this fan. Another fan, Δ_1 is required to complete the triangulation. This should be interpreted as follows: Δ_1 represents a 1-dimensional space and Δ_2 represents a 2-dimensional space. They intersect at a point since they share one 2-dimensional cone. Example (a) is irreducible but (b) is reducible into two irreducible components.

We are now in a position to associate a $(n + 1)$ -dimensional toric variety with each of the 100 regions for our example. Each 5-dimensional cone in the secondary fan shares a codimension 1 wall with another 5-dimensional cone. We will refer to these regions as *neighbouring*. As it would be laborious to list a detailed explanation of all 100 regions we will just look at the ones neighbouring the examples we already know.

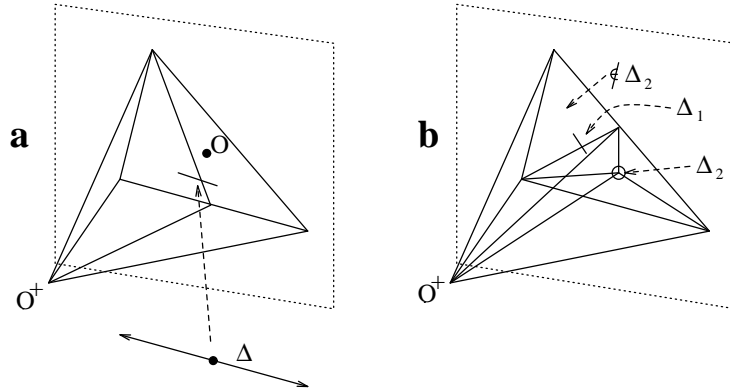

Figure 18. Intermediate fans.

Consider first resolution Δ_1 . This has 3 flops to other smooth Calabi-Yau's and so this accounts for 3 of the 5 neighbours. Another possibility is a star-unsubdivision on the point α_2 . This has the effect of producing a curve of \mathbb{Z}_2 quotient singularities within the Calabi-Yau. Star subdivisions on any other point do not give triangulations. The fifth neighbour of resolution Δ_1 is obtained from the triangulation associated to resolution Δ_1 in the following way. Remove all simplices containing the point α_9 (this removes four 4-plexes). Add in the 4-plexes with vertices $\{\alpha_1, \alpha_3, \alpha_5, \alpha_6, \alpha_9\}$ and $\{\alpha_0, \alpha_1, \alpha_3, \alpha_5, \alpha_6\}$. These simplices have volume 3 and 1 respectively. V_{Δ^+} in this case then refers to a variety with a \mathbb{Z}_3 quotient singularity at a point and it contains a reducible subspace as the compact set. One part of this set is given by the fan we still have around O that corresponds to a 4-fold. This fan does not cover P° however. The two 4-plexes that we added form the fan of a \mathbb{P}^1 touching the 4-fold at one point. The only singularity of V_{Δ^+} lies on the \mathbb{P}^1 .

This resultant model has many interesting features. First note that we have a \mathbb{Z}_3 quotient singularity but it cannot be blown up and maintain the trivial canonical sheaf condition. That is we cannot perform a star subdivision of Δ^+ on a point in N to obtain a smooth variety. Such a singularity is known as a terminal singularity and only exists in 4 complex dimensions and higher. In orbifold compactification one is accustomed to having

twist fields associated to quotient singularities which can be used as marginal operators. No such field exists here.

In the case of the Calabi-Yau model, intersecting the compact space with $W = 0$ lowered the dimension from 4 to 3. In contrast the condition $W = 0$ had no effect on the Landau-Ginzburg theory as its compact space (i.e., the point at the origin) was already contained in this locus. We should now address the question of what happens to the \mathbb{P}^1 which has appeared stuck onto the side of the toric 4-fold. Will the $W = 0$ condition intersect this curve at a point or will it contain the whole curve? Figure 19 and the following argument shows the latter is the case.

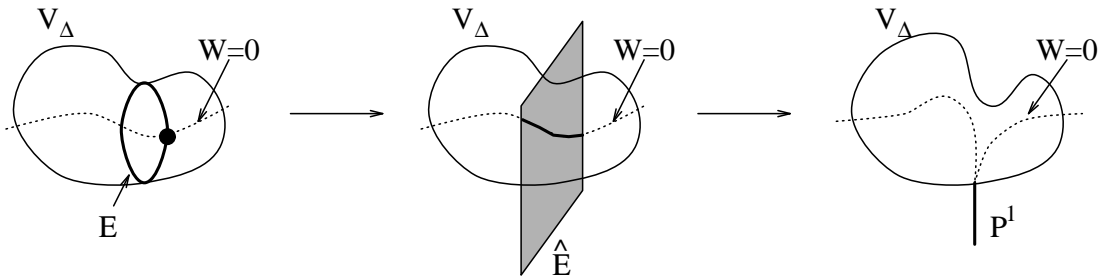

Figure 19. An Exoflop.

The transition from resolution Δ_1 to the model in question is similar to a flop. The main difference is that in this new transition, the new \mathbb{P}^1 appears external to the Calabi-Yau manifold. We will thus term it an *exoflop*. The fan we described above was obtained from the fan for the smooth Calabi-Yau manifold by first removing cones from the fan and then adding others in. This amounts to blowing down along some point set in the original model and then blowing up in a different way to obtain the new model. We could also blow-up first and then blow-down afterwards to achieve the same transition. In the case of a flop one blows up along a \mathbb{P}^1 to obtain $\mathbb{P}^1 \times \mathbb{P}^1$ and then blows the other \mathbb{P}^1 down to obtain a \mathbb{P}^1 not isomorphic to the original. In our example we blow up V_{Δ^+} along a 3-fold, E , which lives inside the compact 4-fold V_Δ for resolution Δ_1 . This gives a 4-fold, \hat{E} , which looks locally like $E \times \mathbb{P}^1$. \hat{E} is then blown-down to \mathbb{P}^1 . The $W = 0$ locus intersects E along a 2-fold and \hat{E} along a 3-fold. Note that if p was contained in the $W = 0$ locus in E then $\mathbb{P}^1 \times p$ is contained in the $W = 0$ locus in \hat{E} . Thus, when we blow down \hat{E} to \mathbb{P}^1 , the whole of \mathbb{P}^1 is contained in the $W = 0$ locus. Even though the 4-fold part of V_Δ does not acquire any singularities during this process, the $W = 0$ locus, and hence the Calabi-Yau space, does become singular as shown schematically in figure 19.

The Calabi-Yau part of this model has no massless modes associated it except in the tangent directions just as in the case of the more usual Calabi-Yau manifold. There are deformations over the \mathbb{P}^1 however which lead to $|\partial W|^2$ having higher than quadratic terms. Thus we have a kind of Landau-Ginzburg type theory over this \mathbb{P}^1 as in [12].

Actually this is a generic feature of the 67 regions which are not Landau-Ginzburg orbifolds, smooth Calabi-Yau 3-folds or 3-dimensional orbifolds. Namely, at least part of the target space has a kind of Landau-Ginzburg fiber over it. These theories are referred to as “hybrid” models.

To sum up the results of the last few paragraphs the geometric interpretation of the fifth neighbour of resolution Δ_1 is as follows. We have a reducible space with 2 irreducible components. One of these components is a Calabi-Yau space with a singularity where it touches the other component. The other component is a V-bundle (i.e., a bundle with quotient singularities in the fiber) over a \mathbb{P}^1 with a Landau-Ginzburg type theory in the bundle. The \mathbb{P}^1 touches the Calabi-Yau space at one point.

The five neighbours of resolutions Δ_3 , Δ_4 and Δ_5 are similar to the case of resolution Δ_1 . The only possibilities are (a) flops, (b) blow-downs to give Calabi-Yau spaces with quotient singularities, and (c) in each case one wall corresponds to an exoflop. Resolution Δ_2 has neighbours corresponding to flops and blow-downs but the fifth wall is not an exoflop. In this case the fifth possibility is a star-unsubdivision on the point O . This results in there being no 4-dimensional complete fans within Δ^+ . The structure of Δ^+ is that of a 2-dimensional complete fan consisting of 6 cones around the plane containing $\{\alpha_4, \alpha_5, \alpha_6\}$. The resultant compact variety from this fan is \mathbb{P}^2 with 3 points blown up. This space is completely contained within the $W = 0$ locus and thus is the vacuum space for this theory. There are massless modes around this vacuum so we obtain a Landau-Ginzburg type theory in a V-bundle over a \mathbb{P}^2 with 3 points blown up.

We can generalize the concept of blowing down and its relation to star-unsubdivisions for this example. As the point on which we have unsubdivided the triangulation was the vertex of a complete fan in 4 dimensions, we have blown down a toric 4-fold. Hence, after intersecting with $W = 0$ we appear to have shrunk down the whole Calabi-Yau manifold. There were exceptional divisors within the Calabi-Yau manifold however which had come from resolving quotient singularities. We did not star-unsubdivide on these and so these retain their dimension. Recall that these exceptional divisors corresponded to three surfaces (treated as one for the purposes of toric geometry) contained in the neighbourhood of the original 3 points corresponding to \mathbb{Z}_6 quotient singularities, as well

as three divisors generally of the form $\mathbb{P}^1 \times (\text{curve})$ coming from the non-isolated \mathbb{Z}_2 and \mathbb{Z}_3 singularities. When we do the “blow-down” corresponding to the star-unsubdivision at α_0 we set to zero all distances within the Calabi-Yau manifold that did not arise from resolving singularities. Thus, the three surfaces become one since they are now zero distance apart and the three divisors of the form $\mathbb{P}^1 \times (\text{curve})$ become \mathbb{P}^1 's. These \mathbb{P}^1 's are simply the 3 points blown up on the \mathbb{P}^2 . This process is depicted in figure 20.

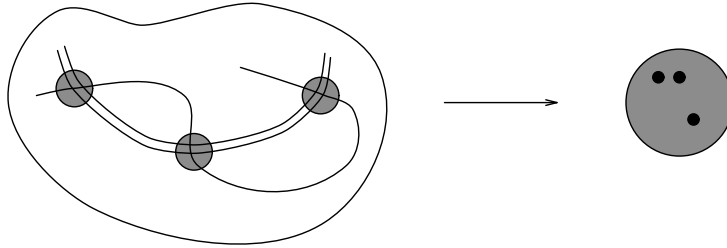

Figure 20. Blowing down the whole Calabi-Yau.

The above theory should be thought of as a natural step in the general process of moving from a Calabi-Yau manifold to a Landau-Ginzburg theory. Whereas in the simpler case studied in [12] there was a direct transition from a Calabi-Yau 3-fold immediately down to a point giving a Landau-Ginzburg theory, our example appears to proceed more naturally by steps. The original Calabi-Yau 3-fold moves down to a 2-fold and then one can show there are models corresponding to 1-folds between this and the Landau-Ginzburg point model.

The analysis of subsection 4.3 can now be repeated for the whole secondary fan. That is, for each cone we take a “large radius limit” by following a line out to ∞ within a cone. In the case of the 95 cones that do not give smooth Calabi-Yau manifolds this will not, in fact, be a purely large radius limit but rather some kind of generalized geometric limit. That is, it is the limit where the geometrical interpretation becomes exact. If this limit is not taken then there are some kind of instanton (or anti-instanton) corrections in the sense of [12]. If a generic value of the B -field is taken, then transitions from one cone to another have no singularities. Thus, transitions between all the bizarre geometrical interpretations we have described in this section are just as smooth as flop transitions in conformal field theory.

7. Conclusions

A fascinating aspect of string theory is the interplay between operations and constructs on the world-sheet and their corresponding manifestations in spacetime. Familiar examples include the relationship between world-sheet and spacetime supersymmetry and the connection between world-sheet Kač-Moody symmetries and spacetime gauge symmetries. Part of the purpose of the present work has been to show another, rather striking, correspondence. Namely, the world-sheet operation of deformation by a truly marginal operator can, in certain circumstances, have a macroscopic interpretation as a change in the topology of spacetime. We have thus shown the truth of the long held suspicion that in string theory there are physical processes leading to a change in the topology of spacetime. In fact, we have shown that these processes are in no way special or exotic — as they correspond to changing the expectation value of a truly marginal operator, these processes are amongst the most basic phenomena in conformal field theory.

More generally, the present work has set out to elucidate the structure of Calabi-Yau moduli space from a more global perspective than has previously been undertaken. We have seen that such a vantage point uncovers a wealth of rich and unexpected structure. The geometrical interpretation of conformal field theory moduli space requires that we augment the traditional Kähler moduli space associated with a Calabi-Yau space of a fixed topological type to the enlarged Kähler moduli. The latter, as we have discussed, is a space consisting of numerous regions adjoined along common walls. These regions consist of the Kähler moduli spaces for: topologically distinct Calabi-Yau manifolds related by flops, singular orbifolds of smooth Calabi-Yau manifolds, Landau-Ginzburg conformal models and also the exotic “hybrid” conformal field theories we have encountered. Moreover, we have shown that one can pass in a physically smooth manner between these regions. In fact, under mirror symmetry, the whole enlarged Kähler moduli space corresponds to the (ordinary) complex structure moduli space of the mirror Calabi-Yau space. Thus, passing between regions in the Kähler moduli space generically corresponds to nothing more than a smooth change in the complex structure of the mirror manifold.

In addition to learning that spacetime topology change can be realized in string theory, the need to pass to the enlarged Kähler moduli space has resolved two important questions in mirror symmetry and shed new light on the nature of orbifolds in string theory. For the former we have seen that the work presented here resolves the apparent asymmetry between complex and Kähler moduli spaces and also shows how the string deals with singularities

admitting distinct resolutions thereby clarifying the global picture of mirror symmetry. For the latter we have seen that notion of orbifolds as boundary points in the walls of the Kähler cone of the Calabi-Yau needs modification in the context of conformal field theory/quantum algebraic geometry. Rather, orbifold theories occupy their own regions in the enlarged Kähler moduli space and hence stand on equal footing with smooth Calabi-Yau manifolds.

We confined most of our detailed discussion in section VI to those regions in the enlarged Kähler moduli space corresponding to well studied theories such as Calabi-Yau and orbifold backgrounds. It is interesting and important to gain an equally comprehensive understanding of the regions corresponding to the less familiar hybrid theories. In fact, if the example studied in section V is any indication, the *majority* of moduli space corresponds to such theories! Their investigation is therefore of obvious merit and we intend to report on such studies shortly.

Acknowledgements

We thank R. Plesser for important contributions at the inception and early stages of this work. We gratefully acknowledge numerous invaluable discussions we have had with E. Witten regarding both the present study and his closely related work [12]. We also thank S. Katz, S.-S. Roan, and R. Wentworth for discussions. B.R.G. thanks S.-T. Yau for suggesting the importance of studying flops in conformal field theory. The work of P.S.A. was supported by DOE grant DE-FG02-90ER40542, the work of B.R.G. was supported by the Ambrose Monell Foundation, by a National Young Investigator award and by the Alfred P. Sloan foundation, and the work of D.R.M. was supported by NSF grant DMS-9103827 and by an American Mathematical Society Centennial Fellowship.

References

- [1] L. Dixon, J. Harvey, C. Vafa and E. Witten, Nucl. Phys. **B261** (1985) 678; Nucl. Phys. **B274** (1986) 285.
- [2] L. Dixon, in *Superstrings, Unified Theories and Cosmology 1987* (G. Furlan et al., eds.), World Scientific, 1988, p. 67.
- [3] W. Lerche, C. Vafa and N. Warner, Nucl. Phys. **B324** (1989) 427.
- [4] P. Candelas, M. Lynker and R. Schimmrigk, Nucl. Phys. **B341** (1990) 383.
- [5] B.R. Greene and M.R. Plesser, Nucl. Phys. **B338** (1990) 15.
- [6] P. Candelas and X.C. De La Ossa, Nucl. Phys. **B355** (1991) 455;
A. Strominger, Commun. Math. Phys. **133** (1990) 163;
S. Cecotti, S. Ferrara and L. Girardello, Phys. Lett. **213B** (1989) 443.
- [7] E. Viehweg, Invent. Math. **101** (1990) 521.
- [8] P.S. Aspinwall, B.R. Greene and D.R. Morrison, Phys. Lett. **303B** (1993) 249.
- [9] G. Tian and S.-T. Yau, in *Mathematical Aspects of String Theory* (S.-T. Yau, ed.), World Scientific, 1987, p. 543.
- [10] J. Kollár, Nagoya Math. J. **113** (1989) 15.
- [11] P. Candelas, P. Green and T. Hübsch, Nucl. Phys. **B330** (1990) 49.
- [12] E. Witten, Nucl. Phys. **B403** (1993) 159.
- [13] S.-S. Roan, Internat. J. Math. **2** (1991) 439; “Topological Properties of Calabi-Yau Mirror Manifolds”, Max-Planck-Institut preprint, 1992.
- [14] V. Batyrev, “Dual Polyhedra and Mirror Symmetry for Calabi-Yau Hypersurfaces in Toric Varieties”, Essen preprint, November 18, 1992.
- [15] D. Gepner, Phys. Lett. **199B** (1987) 380.
- [16] B. Greene, C. Vafa and N. Warner, Nucl. Phys. **B324** (1989) 371.
- [17] E. Martinec, in *V.G. Knizhnik Memorial Volume* (L. Brink et al., eds.), World Scientific, 1990, p. 389; Phys. Lett. **217B** (1989) 431.
- [18] P.S. Aspinwall, Commun. Math. Phys. **128** (1990) 593.
- [19] P.S. Aspinwall and C.A. Lütken, Nucl. Phys. **B355** (1991) 482.
- [20] S.-T. Yau, Proc. Nat. Acad. Sci. U.S.A. **74** (1977) 1798.
- [21] F.A. Bogomolov, Dokl. Akad. Nauk SSSR **243** (1978), no. 5, 1101;
G. Tian, in *Mathematical Aspects of String Theory* (S.-T. Yau, ed.), World Scientific, 1987, p. 629;
A. Todorov, Commun. Math. Phys. **126** (1989) 325.
- [22] P. Green and T. Hübsch, Commun. Math. Phys. **113** (1987) 505.
- [23] P. Candelas and X.C. de la Ossa, Nucl. Phys. **B342** (1990) 246.
- [24] V. Guillemin and S. Sternberg, Invent. Math. **97** (1989) 485.
- [25] R. Friedman, Proc. Symp. Pure Math. **53** (1991) 103.
- [26] A. Strominger and E. Witten, Commun. Math. Phys. **101** (1985) 341.

- [27] A. Strominger, Phys. Rev. Lett. **55** (1985) 2547.
- [28] M. Dine, N. Seiberg, X.-G. Wen, and E. Witten, Nucl. Phys. **B278** (1987) 769; Nucl. Phys. **B289** (1987) 319.
- [29] P. Candelas, X.C. de la Ossa, P.S. Green, and L. Parkes, Phys. Lett. **258B** (1991) 118; Nucl. Phys. **B359** (1991) 21.
- [30] P.S. Aspinwall and D.R. Morrison, Commun. Math. Phys. **151** (1993) 245.
- [31] D.R. Morrison, J. Amer. Math. Soc. **6** (1993) 223.
- [32] D.R. Morrison, in *Essays on Mirror Manifolds* (S.-T. Yau, ed.), International Press, 1992, p. 241;
 A. Font, Nucl. Phys. **B391** (1993) 358;
 A. Klemm and S. Theisen, Nucl. Phys. **B389** (1993) 153;
 A. Libgober and J. Teitelbaum, Int. Math. Res. Notices (1993) 15;
 V. Batyrev and D. van Straten, “Generalized Hypergeometric Functions and Rational Curves on Calabi-Yau Complete Intersections in Toric Varieties”, Essen preprint, 1993;
 P. Candelas, X. de la Ossa, A. Font, S. Katz and D.R. Morrison, “Mirror Symmetry for Two Parameter Models – I”, CERN preprint CERN-TH.6884/93;
 S. Hosono, A. Klemm, S. Theisen and S.-T. Yau, “Mirror Symmetry, Mirror Map and Applications to Calabi-Yau Hypersurfaces”, Harvard preprint HUTMP-93/0801.
- [33] P.S. Aspinwall, C.A. Lütken, and G.G. Ross, Phys. Lett. **241B** (1990) 373.
- [34] T. Oda, *Convex Bodies and Algebraic Geometry*, Springer-Verlag, 1988.
- [35] W. Fulton, *Introduction to Toric Varieties*, Annals of Math. Studies, vol. 131, Princeton University Press, 1993.
- [36] M. Reid, in *Journées de géométrie algébrique d’Angers* (A. Beauville, ed.), Sijthoff & Noordhoff, 1980, p. 273.
- [37] P.S. Aspinwall, B.R. Greene and D.R. Morrison, “The Monomial-Divisor Mirror Map”, IASSNS-HEP-93/43.
- [38] S.-S. Roan, Internat. J. Math. **1** (1990) 211.
- [39] D.A. Cox, “The Homogeneous Coordinate Ring of a Toric Variety”, Amherst preprint, 1992.
- [40] M. Audin, *The Topology of Torus Actions on Symplectic Manifolds*, Progress in Math., vol. 93, Birkhäuser, 1991.
- [41] T. Oda and H.S. Park, Tôhoku Math. J. **43** (1991) 375.
- [42] L.J. Billera, P. Filliman, and B. Sturmfels, Adv. Math. **83** (1990) 155.
- [43] E. Witten, Nucl. Phys. **B268** (1985) 79; in *Essays on Mirror Manifolds*, (S.-T. Yau, ed.), International Press Co., 1992, p. 120.
- [44] J. Distler and B. Greene, Nucl. Phys. **B309** (1988) 295.
- [45] P.S. Aspinwall, B.R. Greene and D.R. Morrison, “Limit Points in the Moduli Space of N=2 Conformal Sigma Models”, IASSNS-HEP-93/49, in preparation.

- [46] D. Markushevich, M. Olshanetsky and A. Perelomov, Commun. Math. Phys. **111** (1987) 247.
- [47] P. Candelas, Nucl. Phys. **B298** (1988) 458.
- [48] C. Vafa and N. Warner, Phys. Lett. **218B** (1989) 51.
- [49] V. Batyrev, *Quantum cohomology rings of toric manifolds*, MSRI preprint, 1993.