

Z' INVESTIGATIONS AT FUTURE LEPTON COLLIDERS ^aT.G. RIZZO ^b

*Stanford Linear Accelerator Center,
Stanford University, Stanford, CA 94309, USA
E-mail: rizzo@slacvx.slac.stanford.edu*

In this talk I summarize the capability of future lepton colliders to indirectly discover a new Z' and to determine its couplings to the fermions of the Standard Model. The physics associated with sitting on the Z' -pole is also briefly discussed. This analysis is based on the results presented in the Snowmass 1996 New Gauge Boson Working Group report.

1 Introduction

One of the primary goals of present and future collider searches is to ascertain the gauge group which describes the electroweak and strong interactions. There are many scenarios in the literature wherein the Standard Model(SM) gauge group is augmented by at least an additional $U(1)$ factor, implying the existence ¹ of a new neutral gauge boson, Z' . In such scenarios the apparent success of the SM at low energies ² is essentially due to decoupling arguments associated with the observation that new gauge bosons must most likely be an order of magnitude heavier than their SM counterparts. Indeed collider searches ^{3,4} indicate that a canonical Z' with couplings to both quarks and leptons is probably more massive than about 600 GeV. (The reader should, however, remember the caveats associated with such strong statements since the number and type of Z' models in the literature is quite enormous.) If true, this implies that that a Z' will be beyond the direct search reach of a first generation lepton collider whose center of mass energy is expected to be 500 GeV or less.

Extended Gauge Models(EGMs) can be divided into two very broad classes depending upon whether or not they originate from a GUT group, such as $SO(10)$ or E_6 . *Generally*, the new gauge bosons from GUT-inspired scenarios have generation-independent couplings (in the same sense as the W and Z of the SM), whereas this need not be true for non-unifiable models. Also, *generally*, the extension of the SM group structure induces additional anomalies which cannot be cancelled by using the conventional SM fermions alone. This implies the almost all EGMs also contain additional exotic matter particles, such as leptoquarks, with masses comparable to

^aTo appear in the *Proceedings of the 2nd International Workshop on e^-e^- Interactions at TeV Energies*, Santa Cruz, CA, 22-24 September 1997

^bWork supported by the Department of Energy, Contract DE-AC03-76SF00515

those of the new gauge bosons themselves. The search reach at a collider for new gauge bosons is somewhat model dependent due to the rather large variations in their couplings to the SM fermions which are present in extended gauge theories currently on the market. This implies that any overview of the subject is necessarily incomplete. Hence, we will be forced to limit ourselves to a few representative models. In what follows, we chose as examples the set of models recently discussed by Cvetič and Godfrey¹ so that we need to say very little here about the details of the coupling structure of each scenario. To be specific we consider (i) the E_6 effective rank-5 model(ER5M), which predicts a Z' whose couplings depend on a single parameter $-\pi/2 \leq \theta \leq \pi/2$ (with models ψ , χ , I , and η denoting specific θ values); (ii) the Sequential Standard Model(SSM) wherein the new W' and Z' are just heavy versions of the SM particles (of course, this is not a true model in the strict sense but is commonly used as a guide by experimenters); (iii) the Un-unified Model(UUM), based on the group $SU(2)_\ell \times SU(2)_q \times U(1)_Y$, which has a single free parameter $0.24 \leq s_\phi \leq 1$; (iv) the Left-Right Symmetric Model(LRM), based on the group $SU(2)_L \times SU(2)_R \times U(1)_{B-L}$, which also has a free parameter $\kappa = g_R/g_L$ of order unity which is just the ratio of the gauge couplings and, lastly, (v) the Alternative Left-Right Model(ALRM), based on the same extended group as the LRM but now arising from E_6 , wherein the fermion assignments are modified in comparison to the LRM due to an ambiguity in how they are embedded in the **27** representation.

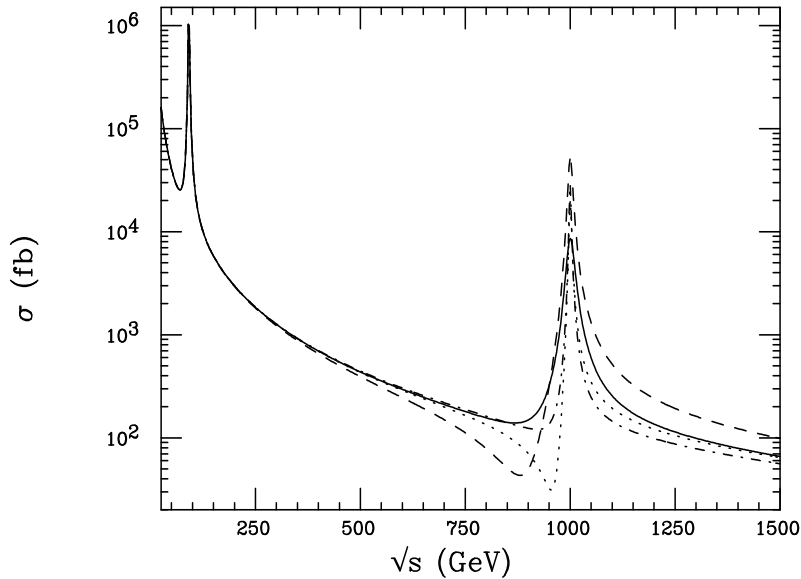

Figure 1: Cross section for $e^+e^- \rightarrow \mu^+\mu^-$ in the presence of a 1 TeV Z' that couples only to SM fermions. The solid(dash-dotted, dashed, dotted) curve corresponds to the LRM with $\kappa = 1(\psi, \chi, \eta)$. ISR has not been included.

2 On The Z' Peak

It is quite possible that the LHC may find a Z' in the TeV region before the NLC turns on. (As will be seen below, the LHC reach for a canonical Z' is 4-5 TeV.) In fact, several arguments suggest, at least in some string-motivated SUSY models, that the Z' mass cannot be far above 1 TeV⁵ as it is naturally linked to the scale of electroweak symmetry breaking. As was discussed by Cvetič and Godfrey¹ and in the more recent analyses presented at Snowmass 1996⁶, it will not be easy for the LHC to uniquely determine the couplings of a Z' if its mass is too far above 1 TeV due to a lack of robust observables. Even for masses as low as 1 TeV it remains unclear just how well a real LHC detector can do in this regard and detailed studies have yet to be performed. Of course if we are lucky to have a ~ 1 TeV Z' this will be an ideal opportunity for a lepton collider although this possibility has gotten little attention. Fig.1 shows the cross section for $e^+e^- \rightarrow \mu^+\mu^-$ in the presence of a 1 TeV Z' for several different EGMs. We see that with an integrated luminosity of $100 fb^{-1}$, hundreds of thousands of μ -pair events will be collected on the peak even after ISR is accounted for. This suggests that in this case the NLC will essentially repeat the analyses of SLC/LEP to determine the Z' couplings to the SM fermions, as well as to other exotic final states which are kinematically accessible.

Fig.2 shows that by using leptonic, b , and $c(t)$ final states it will be quite trivial to distinguish among the more popular models. We note that the anticipated size of the errors associated with any of these observables, given the large statistics available and the expected performance of an NLC detector, will be comparable to the thickness of one of the lines on these plots! We further note that none of the chosen observables depend upon the possibility that the Z' may have decays to other than SM particles. A Z' in the TeV range will provide an excellent object for study at a lepton collider.

3 Indirect Searches

It is more than likely that we will be unlucky and a Z' will be too massive to be produced directly at the first generation of new lepton colliders. Thus searches at such machines will be indirect and will consist of looking for deviations in the predictions of the SM in as many observables as possible. (That such deviations are observable below the Z' peak is obvious from Fig.1.) As is well known, in general analyses of this kind the following standard set of observables are employed: σ_f , A_{FB}^f , A_{LR}^f , $A_{pol}^{FB}(f)$ where f labels the fermion in the final state and, special to the case of the tau, $\langle P_\tau \rangle$ and P_τ^{FB} . Note that beam polarization plays an important role in this list of observables, essentially doubling its length. Layssac *et al.* and, more recently, Renard and Verzegnassi⁷ have shown that the deviations in the leptonic observables due to the existence of a Z' are rather unique and differ from other new virtual effects as shown in Fig.3.

Fig.4 from⁶ shows the resulting search reach from this kind of analysis for the 500 GeV NLC assuming a Z' in either the ER5M or the LRM employing observables from l, b, c and t final states including systematic effects, detector cuts, ISR, *etc.* 90% beam polarization was assumed. Here we can directly see the importance of

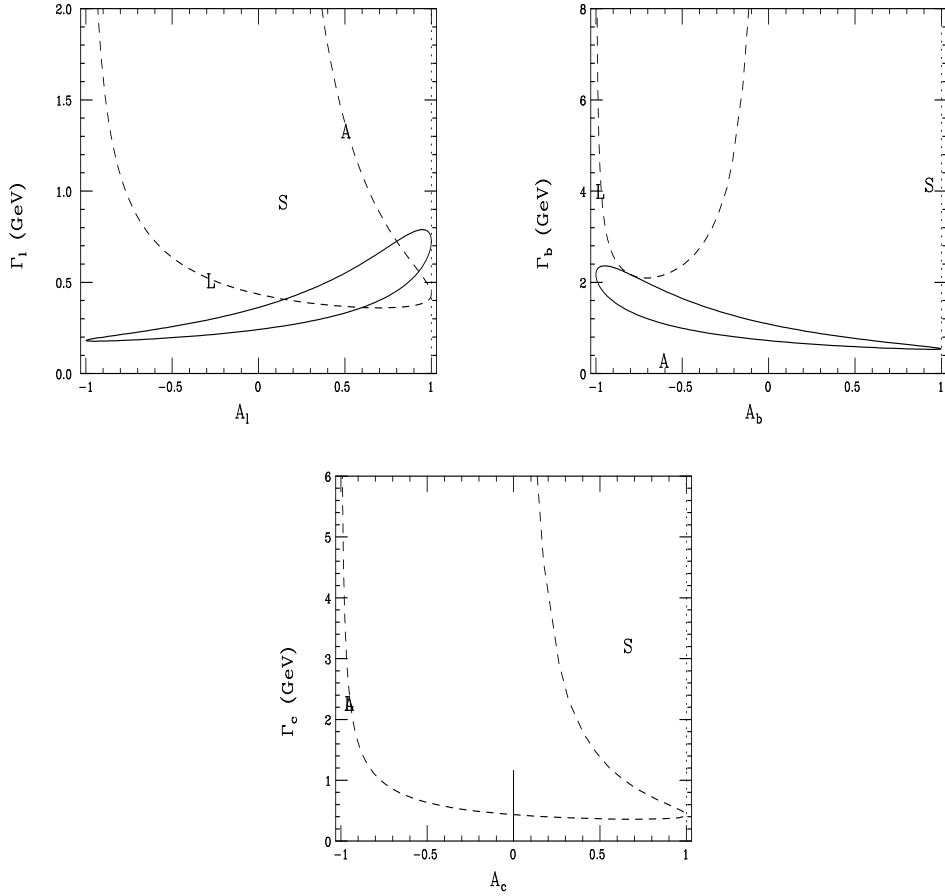

Figure 2: Partial decay widths versus the corresponding asymmetry parameters for the ℓ , b and c final states in Z' decays in E_6 models(solid), LRM(dashed), UUM(dash-dotted) as well as for the ALRM(A), the SSM(S) and the LRM with $\kappa = 1$ (L). The Z' is assumed to have a mass of 1 TeV. $A_f = 2v_f a_f / (v_f^2 + a_f^2)$, where v_f, a_f are the Z' couplings to fermion f .

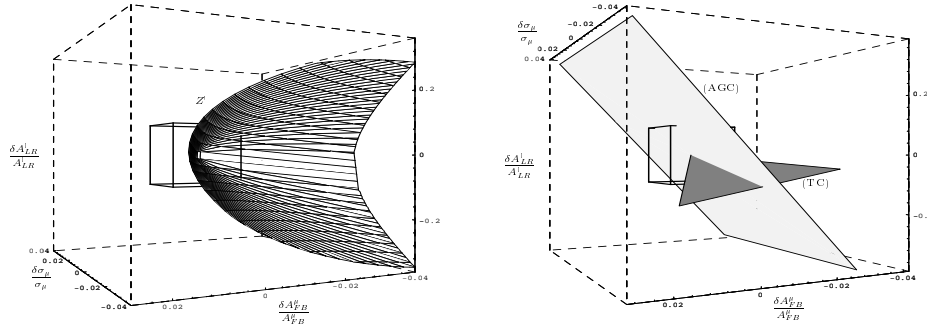

Figure 3: Relative shifts in σ_l , A_{FB}^l and A_{LR}^l due to a general Z' (left) compared to models with anomalous gauge couplings(light grey) or Technicolor models(dark grey) at a 500 GeV NLC taken from the analysis of Renard and Verzeqnessi ⁷.

employing as many final states as possible. Table 1 shows the corresponding results for several lepton colliders, *i.e.*, e^+e^- colliders with $\sqrt{s}= 0.5, 1, 1.5$ and 5 TeV as well as a 4 TeV muon collider, in comparison to the direct LHC search reaches from ⁶. A very interesting analysis describing the scaling behaviour of Z' reaches at lepton colliders with both energy and luminosity was quite recently performed by Leike ⁸ to which we refer the interested reader.

As has been discussed by Cuypers ⁹, e^-e^- collisions offer a unique advantage for Z' hunting in comparison to e^+e^- in that greater statistics are available and that both beams can be polarized. The disadvantage of e^-e^- is the lack of a Z' tail in the s -channel. The Cuypers analysis ⁹ demonstrated that, using leptonic modes only, e^-e^- generally has a superior Z' search reach than does e^+e^- . The same analysis also shows that the *ratio* of e^-e^- to e^+e^- search reaches was essentially independent of ISR. A comparison of the Z' search reaches in the $e^+e^- \rightarrow \mu^+\mu^-$, $e^+e^- \rightarrow e^+e^-$, and $e^-e^- \rightarrow e^-e^-$ channels by Cuypers is shown in Fig.5.

Table 2 from ⁶ shows the ratio of e^-e^- to e^+e^- Z' search reaches at a 500 GeV collider as different final states are added in the e^+e^- case. It confirms the result that if only leptonic observables are employed then the e^-e^- reach is superior to e^+e^- . However, as soon as one adds the additional information from the quark sector, e^+e^- regains the lead in terms of Z' mass reach. Combining the leptonic and quark data together in the e^+e^- case always results in a small value for the reach ratio.

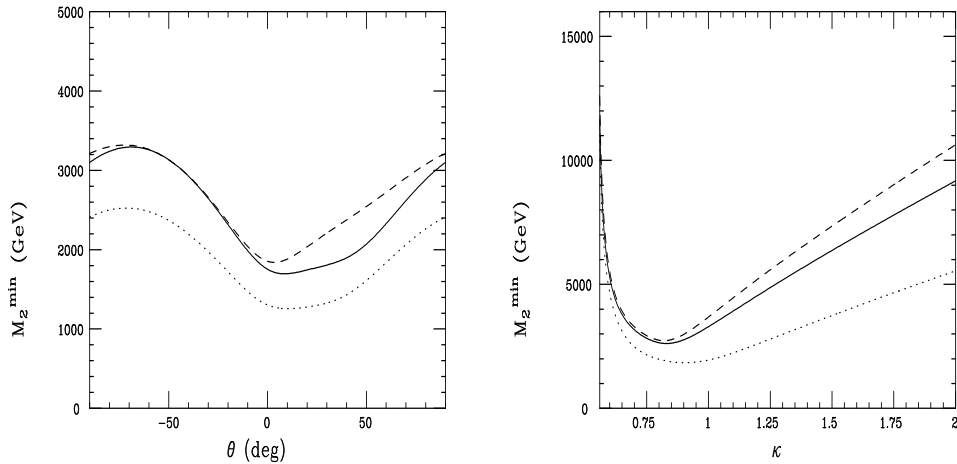

Figure 4: Indirect Z' search reaches at the 500 GeV NLC for E_6 models as a function of θ and the LRM as a function of κ including initial state radiation. The dotted(solid, dashed) curve corresponds to the values obtained using leptonic(leptonic plus b -quark, all) observables. A luminosity of $50 fb^{-1}$ has been assumed.

Table 1: Indirect Z' search reaches of lepton colliders in TeV employing all observables including the effects of cuts, ISR, *etc.* The integrated luminosities of the NLC500, NLC1000, NLC1500, NNLC and the Large Muon Collider are assumed to be 50, 100, 100, 1000 and 1000 fb^{-1} , respectively. In the last column we show the corresponding direct search reach for the LHC assuming an integrated luminosity of 100 fb^{-1} and Z' decays to only SM fermions.

Model	NLC500	NLC1000	NLC1500	NNLC 5 TeV	LMC 4 TeV	LHC
χ	3.21	5.46	8.03	23.2	18.2	4.49
ψ	1.85	3.24	4.78	14.1	11.1	4.14
η	2.34	3.95	5.79	16.6	13.0	4.20
I	3.17	5.45	8.01	22.3	17.5	4.41
SSM	3.96	6.84	10.1	29.5	23.2	4.88
ALRM	3.83	6.63	9.75	28.4	22.3	5.21
LRM	3.68	6.28	9.23	25.6	20.1	4.52
UUM	4.79	8.21	12.1	34.7	27.3	4.55

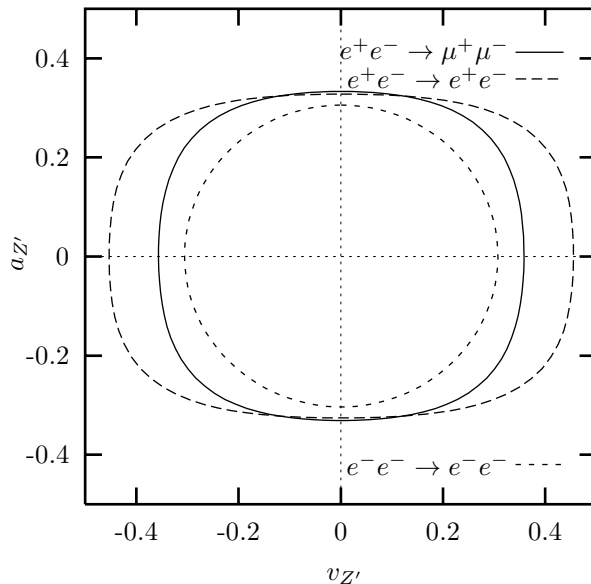

Figure 5: Contours of observability at 95% CL for the reduced Z' couplings including the effects of ISR, polarization and luminosity uncertainties, as well as the angular resolution of the detector. These results are for a 500 GeV NLC with $P = 90\%$ with a luminosity of $50(25) fb^{-1}$ in the $e^+e^-(e^-e^-)$ mode.

Table 2: Ratio of e^-e^- to e^+e^- indirect Z' search reaches at a 500 GeV NLC with an integrated luminosity of $50 fb^{-1}$ in either collision mode. ISR has been ignored. The columns label the set of the final state fermions used in the e^+e^- analysis.

Model	ℓ	$\ell + b$	$\ell + b, c, t$
χ	1.10	0.900	0.896
ψ	1.20	0.711	0.673
η	1.07	0.813	0.650
I	1.06	0.813	0.813
SSM	1.30	0.752	0.667
ALRM	1.20	1.12	0.909
LRM	1.02	0.483	0.432
UUM	0.891	0.645	0.496

4 Coupling Determinations

If the Z' is not too massive in comparison to \sqrt{s} , then sufficient statistical power may be available to not only indirectly see the effects of the Z' but also to extract coupling information. For example, Riemann¹⁰ has recently analyzed the capability of future e^+e^- colliders operating below the Z' resonance to measure the $Z'\bar{f}f$ couplings, where $f = \ell, b, c$. Her analysis implicitly assumed that the mass of the Z' was already known (from the LHC) and was explicitly used as an input into the numerical extraction of couplings. Fig. 6 shows the capability of the NLC running at different energies to measure the leptonic couplings of the Z' in the LRM and ER5M χ as the gauge boson mass is varied. It's clear from this analysis that with reasonable luminosities the NLC will be able to extract leptonic coupling information for Z' masses up to $2 - 3\sqrt{s}$. (We recall that the *search reach* was found to be $6 - 10\sqrt{s}$.) Riemann further showed that it was also possible to constrain the c and b quark couplings of the Z' . As the author correctly points out, the size of the systematic errors for the measurements on these final states is rather critical to this program. For example, for a $Z_\chi(Z_\psi)$ with a 1 TeV mass, the size of the allowed region in the $v'_b - a'_b(v'_c - a'_c)$ plane approximately doubles at a 500 GeV NLC with a luminosity of $50 fb^{-1}$ if a systematic error of 1(1.5)% is added to all relevant observables. However, as Riemann has shown, the NLC will still be able to extract coupling information and distinguish various models using the c, b final states.

A more complex situation arises in the case when the Z' mass is not known *a priori*. It is clear in this circumstance that measurements taken at a single value of \sqrt{s} will not be able to disentangle Z' mass and coupling information. The reason is straightforward: to leading order in $s/M_{Z'}^2$, rescaling all of the couplings and the value of Z' mass by a common factor would leave all of the observed deviations from the SM invariant. In this approximation, the Z' exchange appears only as a contact interaction. The only potential solution to this problem lies in obtaining data on the deviations from the SM predictions at several different values of \sqrt{s} and combining them together in a single fit. A first analysis of this kind was performed for Snowmass 1996⁶, in which data from different values of \sqrt{s} are combined. Only the leptonic and b -quark couplings to the Z' were considered. For Z' masses in the 1.5-2 TeV range which were *a priori* unknown, this analysis found that combining data taken at 500, 750 and 1000 GeV was sufficient to determine the 4 unknown couplings as well as the Z' mass. To insure model-independence, the mass and couplings were chosen *randomly* and *anonymously* from rather large ranges.

A sample result of this procedure is shown in Fig. 7. The three figures correspond to two-dimensional projections of the full five dimensional $(v'_l, a'_l, v'_b, a'_b, M_{Z'})$ 95% CL fit. The following standard set of observables were employed: $\sigma_f, A_{FB}^f, A_{LR}^f, A_{pol}^{FB}(f)$ where $f = \ell, b$ labels the fermion in the final state and, special to the case of the tau, $\langle P_\tau \rangle$ and P_τ^{FB} . Universality amongst the generations was also assumed. While none of the couplings are extremely well determined we learn enough to rule out all conventional extended gauge models as the origin of this particular Z' . Note that knowledge of both the leptonic and b -quarks couplings was required to rule out the case of an E_6 Z' .

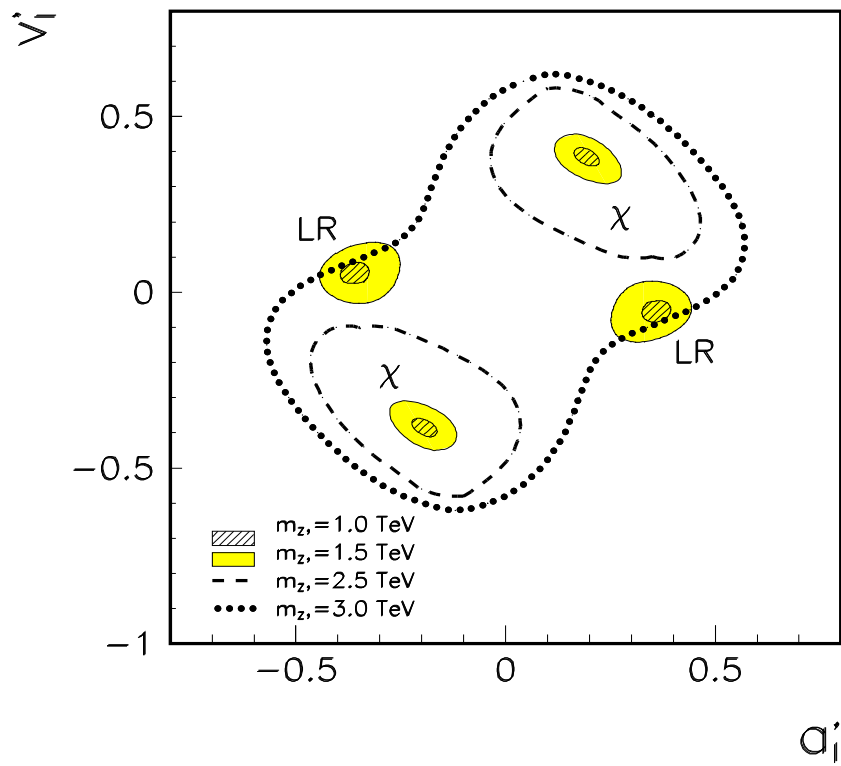

Figure 6: 95% CL contours for v'_i and a'_i for a 500 GeV NLC with a luminosity of $50fb^{-1}$. The Z' is taken to be in the χ or LRM with a 1(1.5) TeV mass corresponding to the hatched(shaded) area. The dashed(dotted) contours are 95% CL limits on the $Z'u$ couplings for the χ case and a mass of 2.5(3) TeV. A beam polarization of 80% has been assumed.

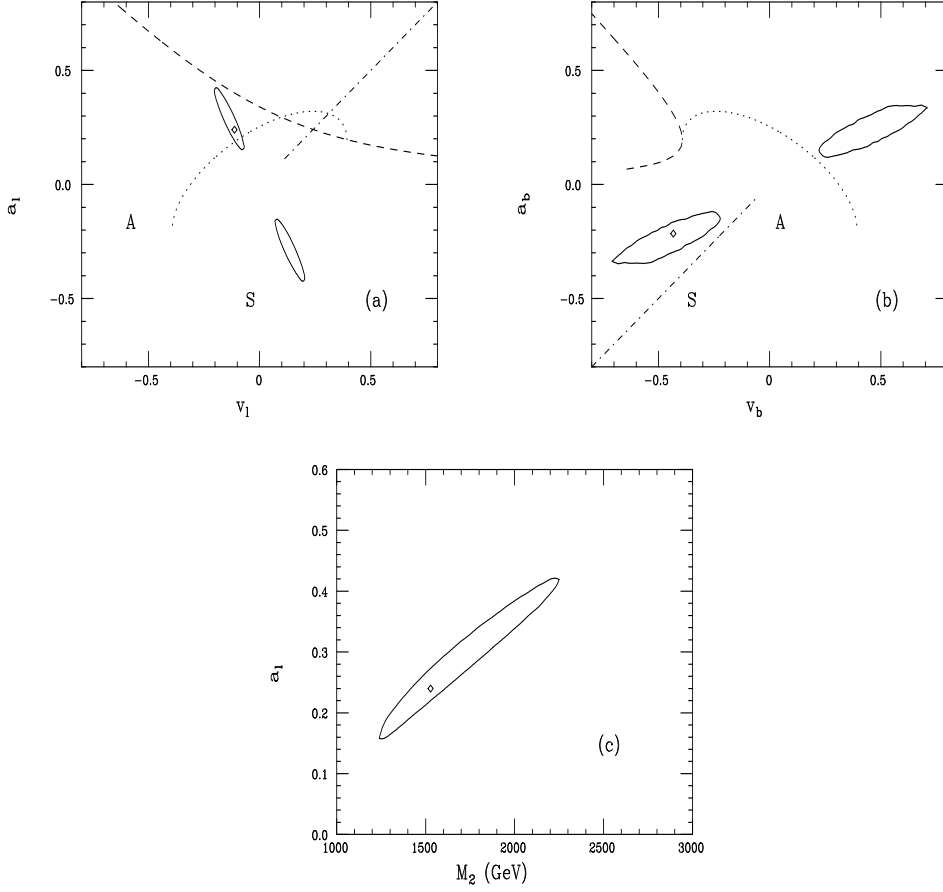

Figure 7: 95% CL allowed regions for the extracted values of the (a) lepton and (b) b -quark couplings for a Z' with randomly generated mass and couplings compared with the predictions of the E_6 model(dotted), the Left-Right Model(dashed), and the Un-unified Model(dash-dot), as well as the Sequential SM and Alternative LR Models(labeled by ‘S’ and ‘A’, respectively.) (c) Extracted Z' mass; only the $a_\ell > 0$ branch is shown. In all cases the diamond represents the corresponding input values. Here we see that the couplings of this Z' do not correspond to those of any of our favorite models.

5 Summary and Outlook

The phenomenology of extended gauge sectors is particularly rich. Analyses have evolved in sophistication to the point where detector considerations are becoming increasingly important. Many of the problems associated with the determination of the couplings of new gauge bosons now have to be faced with specific detector capabilities in mind. Although much work has been done, there is still a lot of work to be done in the future. Hopefully some of this will be completed before new gauge bosons are discovered.

References

1. For a complete set of references and a recent review of the physics of new electroweak gauge bosons see, M. Cvetič and S. Godfrey, Carleton University report OCIP/C-95-2, 1995, a part of the DPF long-range planning study, published in *Electroweak Symmetry Breaking and Physics Beyond the Standard Model*, eds. T. Barklow, S. Dawson, H. Haber, and J. Seigrist (World Scientific 1996). See also, A. Djouadi, talk given at the *Workshop on Physics and Experiments with Linear Colliders*, Morioka-Appi, Japan, Sept. 8-12, 1995, hep-ph/9512311; J. Layssac *et al.*, hep-ph/9602327; A. Leike and S. Riemann, to appear in the *Proceedings of the Physics with e^+e^- Linear Colliders Workshop*, Annecy-Gan Sasso-Hamburg, 1995, ed. P. Zerwas, hep-ph/9604321 and hep-ph/9607306; J.L. Hewett and T.G. Rizzo, Phys. Rep. **183**, 193 (1989).
2. J. Timmermans and Y.Y. Kim, talks given at the *XVIII International Symposium on Lepton and Photon Interactions*, July 28-August 1, 1997, Hamburg, Germany.
3. F. Abe *et al.*, CDF Collaboration, Fermilab-Pub-97-122-E, 1997; C. Gerber, D0 Collaboration, talk given at the *1996 Division of Particles and Fields Meeting*, Minneapolis, MN, 10-15 August 1996.
4. See, for example, M. Besançon, DELPHI Collaboration, talk given at the *International Europhysics Conference on High Energy Physics*, Jerusalem, August 19-26, 1997.
5. M. Cvetič and P. Langacker, Phys. Rev. **D54**, 3570 (1996); Int. J. Mod. Phys. **A11**, 1246 (1996) and hep-ph/9707451; J.D. Lykken, hep-ph/9610218.
6. See T.G. Rizzo in the *Proceedings of the 1996 DPF/DPB Summer Study on New Directions for High Energy Physics-Snowmass96*, Snowmass, CO, 25 June-12 July, 1996.
7. G. Montagna *et al.*, Phys. Lett. **B371**, 277 (1996); F.M. Renard and C. Verzegnassi, hep-ph/9709403.
8. A. Lieke, hep-ph/9708337 and hep-ph/9708436.
9. See F. Cuypers in the *Proceedings of the 1996 DPF/DPB Summer Study on New Directions for High Energy Physics-Snowmass96*, Snowmass, CO, 25 June-12 July, 1996, and references therein.
10. See S. Riemann, *ibid.*