

Prospects for mass unification at low energy scales

R. R. Volkas¹*Research Centre for High Energy Physics, School of Physics,
University of Melbourne, Parkville 3052, Australia.²**and**Department of Applied Mathematics and Theoretical Physics,
University of Cambridge, Silver Street, Cambridge, England CB3 9EW*

Abstract

A simple Pati-Salam SU(4) model with a low symmetry breaking scale of about 1000 TeV is presented. The analysis concentrates on calculating radiative corrections to tree-level mass relations for third generation fermions. The tree-level relation $m_b/m_\tau = 1$ predicted by such models can receive large radiative corrections up to about 50% due to threshold effects at the mass unification scale. These corrections are thus of about the same importance as those that give rise to renormalisation group running. The high figure of 50% can be achieved because 1-loop graphs involving the physical charged Higgs boson give corrections to $m_\tau - m_b$ that are proportional to the large top quark mass. These corrections can either increase or decrease m_b/m_τ depending on the value of an unknown parameter. They can also be made to vanish through a fine-tuning. A related model of tree-level t - b - τ unification which uses the identification of SU(2)_R with custodial SU(2) is then discussed. A curious relation $m_b \simeq \sqrt{2}m_\tau$ is found to be satisfied at tree-level in this model. The overall conclusion of this work is that the tree-level relation $m_b = m_\tau$ at low scales such as 1000 TeV or somewhat higher can produce a successful value for m_b/m_τ after corrections, but one must be mindful that radiative

¹rrv@physics.unimelb.edu.au, U6409503@hermes.ucs.unimelb.edu.au²Permanent address.

corrections beyond those incorporated through the renormalisation group can be very important. This motivates that an on-going search for the rare decays $K_L^0 \rightarrow \mu^\pm e^\mp$ be maintained.

1. Introduction

The fermion mass problem may be usefully divided into four sub-problems: Why do weak isospin partners have different masses? Why are quark and lepton masses split? Why is there a mass hierarchy between generations, and why is there a mixing angle hierarchy? The Standard Model (SM) answer is that the gauge group $G_{SM} = SU(3)_c \otimes SU(2)_L \otimes U(1)_Y$ permits a different Yukawa coupling constant to set each fermion mass and mixing angle. It is productive to suppose that this is really no answer at all, thus motivating us to seek extensions of the SM that are less accommodating.

Indeed, the multiplet structure of the SM strongly suggests that these four patterns within the fermionic parameter spectrum should be correlated with the breakdown of a symmetry group larger than G_{SM} . Recall that each generation of quarks and leptons is placed in the multiplet pattern given below:

$$\begin{aligned} q_L &\sim (3, 2)(1/3), & d_R &\sim (3, 1)(-2/3), & u_R &\sim (3, 1)(4/3), \\ \ell_L &\sim (1, 2)(-1), & e_R &\sim (1, 1)(-2), & \nu_R &\sim (1, 1)(0). \end{aligned} \tag{1}$$

The right-handed neutrino ν_R is optional, and I exercise this option here.

Weak-isospin partners have different masses in the SM because the associated right-handed states are not related by any symmetry. However, the right-handed fermions can be assembled into doublets of a right-handed weak-isospin gauge group $SU(2)_R$. This extended symmetry is powerful enough to force isospin partners to be degenerate [1].

Quark and lepton masses are unrelated in the SM because quarks and leptons are not transformed into each other by any symmetry. However, quarks and leptons can be placed in quadruplets of the Pati-Salam $SU(4)$ gauge group [2]. Alternatively, quarks and leptons can be related by a discrete symmetry if a spontaneously broken $SU(3)_\ell$ colour group for leptons is introduced [3]. Both of these extended symmetries are powerful enough to force quarks and leptons to be degenerate.

Corresponding fermions in different generations have unrelated masses in the SM because there are no symmetries that act horizontally. This also means the Kobayashi-Maskawa mixing angles are *a priori* arbitrary. Again, it is possible to place generations into horizontal multiplets in such a way that masses and mixing angles become related.

In this paper I am going to explore how Pati-Salam $SU(4)$ and right-handed isospin $SU(2)_R$ might be lurking behind the measured spectrum of fermion masses. Furthermore, I will explore the interesting possibility that these gauge symmetries are spontaneously broken at a relatively low scale. There are several very good reasons for performing this analysis:

(i) One indication in favour of a low scale SU(4) symmetry may be the observation that the b quark and τ lepton masses merge at around 1000 TeV if one assumes that only the SM particles contribute to their renormalisation group evolution. This fact is of great physical relevance provided that radiative corrections to the relation $m_b = m_\tau$ due to threshold effects at either the high mass unification scale or the low electroweak scale are not too large. In this paper I will calculate these threshold effects explicitly. I will find that high mass scale threshold effects from diagrams involving the physical charged Higgs boson can be about as important as renormalisation group evolution, so that $m_b = m_\tau$ at 1000 TeV need not be the correct boundary condition to use when solving the renormalisation group equations for m_b and m_τ . (The precise value of this threshold correction will of course depend on parameter choices.)

(ii) There is on-going interest in the phenomenology of Pati-Salam models (see for instance [4]). It is pertinent to note that the phenomenological lower bound on Pati-Salam SU(4) breaking is about 1000 TeV, which is roughly the same scale as that at which renormalisation group evolution merges m_b with m_τ . This means that if unification of m_b with m_τ occurs at about 1000 TeV, then the resulting model should be testable in the foreseeable future via indirect effects (principally $K_L^0 \rightarrow \mu^\pm e^\mp$). Calculation of the threshold corrections will then tell us how close to 1000 TeV the mass unification can occur. For instance, if these corrections turn out to imply that $m_b < m_\tau$ then we know that we will have to run the masses for longer in order to obtain agreement with experiment. This will in turn imply that the mass unification scale is higher than 1000 TeV.

(iii) Quite apart from the above observation, it is very important to study the fermion mass relation problem in Pati-Salam theory if one is serious about searching for experimental signatures of the model. Although there is great interest in these experimental searches, it is not as yet clear which version of Pati-Salam theory they should be based on because of the fermion mass issue. One should really look for experimental evidence for a realistic theory, and Pati-Salam theory cannot be realistic until the fermion mass relation problem is solved. The present paper aims to contribute to this study.

(iv) The indirect signatures of Pati-Salam theory are enhanced if the SU(4) breaking scale is relatively low. It is therefore important to specifically re-examine the theory when a low symmetry breaking scale is used. Low scale breaking has different implications for the construction of the model compared with the oft considered scenario of SU(4) being broken at grand unified energies. Indeed, in general terms the approach pursued here should be contrasted with the use of grand unified gauge groups in relating fermionic parameters. The desire in that case to also unify gauge coupling constants forces an enormously high symmetry breaking scale of 10^{16} GeV upon us, thereby reducing the testability of the models considerably. I wish to emphasise that

it is not necessary to unify both gauge and Yukawa coupling constants simultaneously. It is easy to unify the latter without unifying the former, as I will show. This has the interesting consequence of freeing us from the need to do physics at 10^{16} GeV. I will provide a framework for addressing the fermion mass problem with physics at 1000 TeV. One should bear in mind that the unification of Yukawa coupling constants is in no way a lesser goal than the unification of gauge coupling constants, and indeed may even be more important since there are more of them. Gauge coupling constant unification must occur at 10^{16} GeV if it occurs at all. It would be pleasing to discover that Yukawa coupling constant unification occurs at a much lower scale.

Having motivated the present study, it is important to understand its scope. The fermion mass problem is an issue of some complexity. My goal here is to attack the subproblems of isospin and quark-lepton splitting only. This means I will concentrate on trying to explain why the top quark, bottom quark, tau lepton and tau neutrino have their observed mass pattern. It has long been realised that this is a sensible place to start because the lighter generations are more liable to receive complicated higher-order corrections thus making their analysis much more difficult. Nevertheless I will comment in due course on how a horizontal structure might be superimposed on the scheme.

The remainder of this paper is structured as follows: In the next section I concentrate on deriving the b - τ mass splitting from spontaneously broken SU(4). I discuss how the Pati-Salam model should be configured in order to have its breaking scale set as low as about 1000 TeV. This motivates the use of a different and simpler Higgs sector from that usually employed, and a different see-saw mechanism for neutrinos. I then analyse both the renormalisation group evolution of $m_{b,\tau}$ as well as important radiative corrections due to the high mass threshold. The core of the paper is an explicit and detailed calculation of these threshold corrections. They can be large because some of them are proportional to m_t rather than m_b . Section 3 is then devoted to the use of SU(2)_R in conjunction with SU(4) to achieve unification of t , b , τ and ν_τ masses at 1000 TeV. The hierarchy between m_t and $m_{b,\tau}$ is then constructed to be due to a type of see-saw mechanism. I also find in this case that the tree-level relationship between b and τ is $m_b \simeq \sqrt{2}m_\tau$ rather than the more familiar relation $m_b = m_\tau$. I argue that this model can probably deliver a realistic value for m_b/m_τ through a combination of renormalisation group evolution and large threshold corrections, although an explicit calculation of the relevant diagrams is beyond the scope of this article. I conclude in Sec.4. An Appendix provides details of the computation of the finite radiative corrections to m_b/m_τ in the model of Sec.2.

2. Low scale Pati-Salam SU(4) and the $b - \tau$

mass splitting

2.1 Basics

The Pati-Salam gauge group G_{PS} given by

$$G_{PS} = \text{SU}(4)_c \otimes \text{SU}(2)_L \otimes \text{SU}(2)_R \quad (2)$$

assembles the rather unruly multiplet structure of the SM as given in Eq. (1) into the simple pattern,

$$f_L \sim (4, 2, 1), \quad f_R \sim (4, 1, 2). \quad (3)$$

Quarks and leptons are identified by breaking $\text{SU}(4)$ down to its maximal subgroup $\text{SU}(3) \otimes \text{U}(1)$, where the first factor is identified with colour and the second with $B - L$. Under this breakdown the $\mathbf{4}$ of $\text{SU}(4)$ decomposes to $\mathbf{3}(1/3) \oplus \mathbf{1}(-1)$ which clearly identifies the quark and lepton components of the f 's.

The mass relations which result from G_{PS} depend crucially on how simple one makes the electroweak Higgs sector. The minimal electroweak Higgs multiplet is actually a *real* bidoublet $\Phi = \Phi^c \sim (1, 2, 2)$ where $\Phi^c \equiv \tau_2 \Phi^* \tau_2$. Use of this minimal multiplet forces mass equality between isospin partners. I defer discussion of this possibility until the next section. The next simplest multiplet is a *complex* bidoublet $\Phi \neq \Phi^c$. This is the one most commonly used in the literature when discussing either the Pati-Salam model or the left-right symmetric model, because the issue of isospin mass splitting is usually avoided. However, it is important to realise that this is a non-minimal choice, akin to choosing two Higgs doublets in the SM. Nevertheless I make this choice in this section because it is sensible to concentrate on b - τ splitting first.

The electroweak Yukawa Lagrangian is then

$$\mathcal{L}_{\text{Yuk}} = \lambda_1 \text{Tr}(\bar{f}_L \Phi f_R) + \lambda_2 \text{Tr}(\bar{f}_L \Phi^c f_R) + \text{H.c.} \quad (4)$$

The gauge transformation rules for the fields are written as

$$f_L \rightarrow U_L f_L U_4^T, \quad f_R \rightarrow U_R f_R U_4^T \quad \text{and} \quad \Phi \rightarrow U_L \Phi U_R^\dagger, \quad (5)$$

where $U_{L,R,4}$ are special unitary matrices for $\text{SU}(2)_L$, $\text{SU}(2)_R$ and $\text{SU}(4)$ respectively. (The fields $f_{L,R}$ are 2×4 matrices, while Φ is a 2×2 matrix.) Electroweak symmetry breakdown is caused by a nonzero vacuum expectation value (VEV) for Φ of the form

$$\langle \Phi \rangle = \begin{pmatrix} u_1 & 0 \\ 0 & u_2 \end{pmatrix}. \quad (6)$$

Inputting this into \mathcal{L}_{Yuk} rewritten in terms of the quark and lepton components reveals that

$$m_b = m_\tau \quad \text{and} \quad m_t = m_{\nu_3}^{\text{Dirac}}, \quad (7)$$

where I have taken the f 's to be third generation fields. I have denoted the neutrino field as ν_3 instead of ν_τ for a reason to be explained shortly. The goal is now to see how these mass relations can be corrected into phenomenologically acceptable ones. As I have already discussed, renormalisation group evolution of m_b and m_τ should be used in conjunction with the radiative corrections to $m_b - m_\tau$ due to mass thresholds. In order to calculate these threshold corrections, I must describe the whole model.

The first issue is how to break G_{PS} down to G_{SM} . I want this breakdown to occur at as low a scale as experiment allows. A recent analysis shows that the SU(4) gauge bosons which mediate transitions between quarks and leptons must be heavier than 1400 TeV [4]. I will therefore adopt 1000 TeV as the generic scale for G_{PS} breaking. (The difference between 1400 TeV and 1000 TeV will not be important, and I adopt the latter for simplicity.) This immediately implies that I definitely do not want to impose a discrete symmetry between the SU(2)_L and SU(2)_R sectors. Such a discrete symmetry, be it parity or charge conjugation, is supported by the multiplet structure of Eq. (3) and is often imposed in addition to the gauge symmetry G_{PS} . This has the effect of equating the gauge coupling constants of the two isospin groups, resulting in a partial gauge unification. (The number of gauge coupling constants is reduced from three to two rather than all the way to one as in grand unified theories.) A renormalisation group analysis of the running of the gauge coupling constants then reveals that the Pati-Salam breaking scale must be chosen to be about 10^{12} GeV in order to be consistent with low-energy measurements of α_{em} , α_s and $\sin^2 \theta_W$ [5]. If the discrete symmetry is not imposed, then the breaking scale can be reduced to 1000 TeV.

The absence of discrete left-right symmetry also frees us from having to pair every multiplet up with its putative discrete symmetry partner, although we can still do so if we wish. The lack of left-right symmetry can either be taken as fundamental, or perhaps indicative of a separate and higher symmetry breaking scale where the discrete symmetry is broken but not G_{PS} . (This can be achieved by a parity-odd gauge singlet Higgs field, for instance [6].)

It is attractive to connect the breakdown of G_{PS} with a see-saw mechanism for explaining why neutrinos are so light. This will immediately solve the problem of explaining how the observed light neutrinos can be consistent with $m_u = m_\nu^{\text{Dirac}}$. To this end, a Higgs multiplet Δ in the (10, 1, 3) representation of G_{PS} is often employed. It can break SU(4) \otimes SU(2)_R down to SU(3)_c \otimes U(1)_Y while simultaneously imparting large Majorana masses to right-handed neutrinos through the Yukawa term $\bar{f}_R (f_R)^c \Delta$. This sets up the see-saw form for the neutrino mass matrix, and the light neutrino

eigenstates become Majorana particles of mass $\sim m_u^2/\langle\Delta\rangle$ [7].

However, this Higgs multiplet is not appropriate for my stated purpose. Hot Big Bang cosmology indicates that the sum of the masses of stable neutrinos should not exceed about 30 eV in order to avoid conflict with the observed longevity of the universe. Equating $m_u^2/\langle\Delta\rangle$ with 30 eV and using $m_u = m_t \simeq 175$ GeV shows that $\langle\Delta\rangle$ must be at least 10^{12} GeV. This is inimical to having a 1000 TeV Pati-Salam breaking scale.

Fortunately, there is a very elegant way out of this apparent impasse. The field Δ is not used but instead I introduce into the model a massless gauge singlet fermion N_L and the Higgs multiplet χ where

$$\chi \sim (4, 1, 2). \quad (8)$$

Note that χ is in a much simpler representation than is Δ . In fact, χ is the simplest multiplet that can simultaneously break $SU(4)$ and $SU(2)_R$. The non-electroweak Yukawa Lagrangian

$$\mathcal{L}_{\text{Yuk}} = n\bar{N}_L \text{Tr}(\chi^\dagger f_R) + \text{H.c.} \quad (9)$$

delivers the neutrino mass matrix

$$\mathcal{L}_{\nu\text{mass}} = \frac{1}{2} \left[\begin{array}{ccc} \overline{(\nu_L)^c} & \bar{\nu}_R & \overline{(N_L)^c} \end{array} \right] \left(\begin{array}{ccc} 0 & m_t & 0 \\ m_t & 0 & nv \\ 0 & nv & 0 \end{array} \right) \left[\begin{array}{c} \nu_L \\ (\nu_R)^c \\ N_L \end{array} \right] + \text{H.c.} \quad (10)$$

where v is defined through

$$\langle\chi\rangle = \left(\begin{array}{cccc} 0 & 0 & 0 & v \\ 0 & 0 & 0 & 0 \end{array} \right). \quad (11)$$

This mass matrix may be diagonalised to yield

$$\mathcal{L}_{\nu\text{mass}} = m_s \bar{s}_R s_L + \text{H.c.} \quad (12)$$

where

$$m_s \equiv \sqrt{M^2 + m_t^2} \quad (13)$$

with $M \equiv nv$. The neutral fermion s given by

$$s_L \equiv \sin\theta\nu_L + \cos\theta N_L \quad \text{and} \quad s_R \equiv \nu_R \quad (14)$$

where

$$\tan\theta \equiv m_t/M. \quad (15)$$

is a Dirac particle of mass m_s . The field orthogonal to s_L ,

$$\nu_{\tau L} = \cos \theta \nu_L - \sin \theta N_L, \quad (16)$$

is identified as the massless tau neutrino. In the limit that $M \gg m_t$, $\nu_{\tau L} \simeq \nu_L - m_t N_L / M$, which means that $\nu_{\tau L}$ has SM couplings to left-sector electroweak gauge bosons to a very good approximation.

The massless nature of $\nu_{\tau L}$ may be traced back to the choice of no diagonal Majorana mass $M_N \overline{(N_L)^c} N_L$ for N_L . This choice introduces the global symmetry $N_L \rightarrow e^{i\alpha} N_L$, $\chi \rightarrow e^{-i\alpha} \chi$ into the model. After χ develops a VEV, this global symmetry gets rotated into an exact global lepton number invariance which protects $\nu_{\tau L}$ from obtaining a Majorana mass. (It cannot gain a Dirac mass because there is no right-handed state with which it can pair up.) An acceptable nonzero Majorana mass for $\nu_{\tau L}$ may be introduced by making M_N nonzero but small. In this case the smallest eigenvalue is approximately $(m_t^2/nv)(M_N/nv)$. The standard see-saw value m_t^2/nv thus receives an extra suppression from M_N/nv , allowing the cosmological impasse to be overcome even with a massive $\nu_{\tau L}$. Although a small value for M_N would be technically natural because setting it to zero increases the symmetry group of the theory, I would expect that a satisfactory version of the theory with massive neutrinos would attempt to provide a good reason for M_N being small. It could, for instance, be radiatively generated. I will for simplicity suppose that $M_N = 0$ in this paper. Small values for M_N will not alter the results.

There is an auxiliary reason why χ might be preferred to Δ . With three generations of fermions and Δ , the $SU(2)_R$ gauge coupling constant is not asymptotically free. However, it is asymptotically free with three generations plus a χ field. This fact should not be accorded undue importance, because the scale at which the $SU(2)_R$ coupling constant would blow-up is well above the Planck mass. Nevertheless, it is pleasing that all of the gauge interactions are asymptotically free and thus well-defined at all scales when χ is used instead of Δ . All in all, χ is a very simple and elegant alternative to Δ .

I now need to further discuss the physical effects of $\langle \chi \rangle$. The VEV pattern for χ given by Eq. (11) breaks $SU(4) \otimes SU(2)_R$ down to $SU(3)_c \otimes U(1)_Y$, where

$$Y = 2I_R + (B - L). \quad (17)$$

The symbol I_R denotes the diagonal generator of $SU(2)_R$ normalised so that $\text{Tr}(I_R^2) = 1/2$ for the fundamental representation.

The right-sector W bosons, a Z' boson and a colour triplet, charge $+2/3$ gauge boson I will call X gain mass from $\langle \chi \rangle$. Denoting the $SU(2)_R$ coupling constant by g_R

these masses are,

$$m_{W_R}^2 = \frac{1}{2}g_R^2v^2, \quad m_{Z'}^2 = \frac{1}{2}(g_R^2 + \frac{3}{2}g_s^2)v^2 \quad \text{and} \quad m_X^2 = \frac{1}{2}g_s^2v^2, \quad (18)$$

where the SU(4) coupling constant is of course equal to g_s .

The W_R bosons couple to quarks and leptons via

$$\mathcal{L}_R = \frac{g_R}{\sqrt{2}}(\bar{s}_R\gamma^\mu W_{R\mu}^+\tau_R + \bar{t}_R\gamma^\mu W_{R\mu}^+b_R) + \text{H.c.} \quad (19)$$

while the interaction of X with fermions is given by

$$\mathcal{L}_X = \frac{g_s}{\sqrt{2}}(\sin\theta\bar{t}_L\gamma^\mu X_\mu s_L + \cos\theta\bar{t}_L\gamma^\mu X_\mu\nu_{\tau L} + \bar{t}_R\gamma^\mu X_\mu s_R + \bar{b}\gamma^\mu X_\mu\tau) + \text{H.c.} \quad (20)$$

The Z' field is a linear combination of the gauge bosons associated with I_R and $B - L$. The orthogonal field B couples to weak hypercharge Y . The interaction Lagrangian is

$$\begin{aligned} \mathcal{L}_{Z',B} &= \frac{1}{\sqrt{g_R^2 + \frac{3}{2}g_s^2}} \sum_{\psi} \bar{\psi} \left(\gamma^\mu Z'_\mu \left[g_R^2 I_R P_R - \frac{3}{4} g_s^2 (B - L) \right] \right. \\ &\quad \left. + \gamma^\mu B_\mu \sqrt{\frac{3}{2}} g_R g_s \left[I_R P_R + \frac{B - L}{2} \right] \right) \psi, \end{aligned} \quad (21)$$

where $\psi = t, b, \tau, \nu$ and $P_R \equiv (1 + \gamma_5)/2$. The coupling constant for B is identified with $g_L \tan\theta_W$, where g_L is the usual SU(2)_L coupling constant. This allows us to calculate g_R in terms of the measured values of g_L , $\cos\theta_W$ and g_s .

When Φ develops a nonzero VEV, B and the neutral gauge boson of SU(2)_L form into the massless photon and the massive Z boson. The latter also mixes with Z' . The left-sector W boson acquires its standard mass $m_{W_L}^2 = g_L(u_1^2 + u_2^2)/2$, and it also mixes with the right-sector W_R .

I will also need to display the Yukawa couplings of both the physical and unphysical Higgs bosons. Writing

$$\Phi = \begin{pmatrix} \phi_1^0 & \phi_2^+ \\ \phi_1^- & \phi_2^0 \end{pmatrix} \quad (22)$$

the electroweak Yukawa Lagrangian is rewritten as

$$\begin{aligned} \mathcal{L}_{\text{Yuk}} &= \lambda_1(\bar{t}_L t_R \phi_1^0 + \bar{t}_L b_R \phi_2^+ + \bar{b}_L t_R \phi_1^- + \bar{b}_L b_R \phi_2^0 \\ &\quad + \bar{\nu}_L \nu_R \phi_1^0 + \bar{\nu}_L \tau_R \phi_2^+ + \bar{\tau}_L \nu_R \phi_1^- + \bar{\tau}_L \tau_R \phi_2^0) \\ &\quad + \lambda_2(\bar{t}_L t_R \phi_2^{0*} - \bar{t}_L b_R \phi_1^+ - \bar{b}_L t_R \phi_2^- + \bar{b}_L b_R \phi_1^{0*} \\ &\quad + \bar{\nu}_L \nu_R \phi_2^{0*} - \bar{\nu}_L \tau_R \phi_1^+ - \bar{\tau}_L \nu_R \phi_2^- + \bar{\tau}_L \tau_R \phi_1^{0*}) + \text{H.c.} \end{aligned} \quad (23)$$

Then writing

$$\chi = \begin{pmatrix} \chi^u & \chi^0 \\ \chi^d & \chi^- \end{pmatrix} \quad (24)$$

I find that the non-electroweak Yukawa Lagrangian is

$$\mathcal{L}_{\text{Yuk}} = n(\overline{N}_L t_R \chi^{u\dagger} + \overline{N}_L b_R \chi^{d\dagger} + \overline{N}_L \tau_R \chi^+ + \overline{N}_L s_R \chi^{0*}) + \text{H.c.}, \quad (25)$$

where χ^u and χ^d are 1×3 row matrices denoting the three colour components of these fields.

I now describe the gastronomy of the model. The field χ^u is eaten by the X boson, while χ^d is a physical colour triplet Higgs boson. In the limit that $v \gg u_1, u_2$, the field χ^- is eaten by W_R^- , while

$$g^- \equiv \cos \omega \phi_1^- - \sin \omega \phi_2^- \quad (26)$$

where $\tan \omega \equiv u_2/u_1$ is eaten by W_L^- . The orthogonal field

$$H^- \equiv \sin \omega \phi_1^- + \cos \omega \phi_2^- \quad (27)$$

is a physical charged Higgs boson. For the case where spontaneous CP-violation does not occur, the real components of ϕ_1^0, ϕ_2^0 and χ^0 mix to yield three physical fields. Two of the imaginary components are eaten by the Z' and Z . In the limit $v \gg u_1, u_2$, the imaginary component of χ^0 is eaten by the Z' , while $\sqrt{2}[\cos \omega \text{Im}(\phi_1^0) + \sin \omega \text{Im}(\phi_2^0)]$ is eaten by the Z , leaving the orthogonal field as a physical CP-odd neutral Higgs boson. I will need the interaction Lagrangian between g^-, H^- and the fermions. It is

$$\begin{aligned} \mathcal{L}_{\text{Yuk}}^+ &= a_g \overline{t}_L b_R g^+ + b_g \overline{b}_L t_R g^- + a_g \cos \theta \overline{\nu}_{\tau L} \tau_R g^+ + a_g \sin \theta \overline{s}_L \tau_R g^+ + b_g \overline{\tau}_L s_R g^- \\ &+ a_H \overline{t}_L b_R H^+ + b_H \overline{b}_L t_R H^- + a_H \cos \theta \overline{\nu}_{\tau L} \tau_R H^+ + a_H \sin \theta \overline{s}_L \tau_R H^+ \\ &+ b_H \overline{\tau}_L s_R H^- + \text{H.c.} \end{aligned} \quad (28)$$

where

$$\begin{aligned} a_g &\equiv -\frac{m}{\sqrt{u_1^2 + u_2^2}}, \\ b_g &\equiv \frac{m_t}{\sqrt{u_1^2 + u_2^2}}, \\ a_H &\equiv \frac{1}{\cos 2\omega} \frac{m_t - m \sin 2\omega}{\sqrt{u_1^2 + u_2^2}}, \\ b_H &\equiv \frac{1}{\cos 2\omega} \frac{m_t \sin 2\omega - m}{\sqrt{u_1^2 + u_2^2}} \end{aligned} \quad (29)$$

as can be easily seen from Eq. (23). The quantity m is the common tree-level mass for b and τ .

The primary task now is to discuss how radiative effects modify the tree-level relation $m_b = m_\tau$. Before doing so, I will make a brief comment about a cosmological implication of the model. Because the unbroken symmetry group contains no $U(1)$ factors while the broken group does, monopoles will be created during the G_{PS} symmetry breaking phase transition in the early universe. However, a simple calculation shows that monopoles produced at a temperature of 1000 TeV are cosmologically innocuous [8]. The number density of monopoles n_M in the visible universe today depends on how many causally disconnected regions at $T = 1000$ TeV made up the spacetime that subsequently evolved into the present day visible universe. A rough order of magnitude estimate shows that $n_M/s \sim (1000 \text{ TeV}/M_{\text{Planck}})^3$ where s is entropy density at the time of monopole creation. If there is negligible monopole annihilation then this ratio should remain roughly constant. Using this to calculate the fraction of critical density existing as monopoles I find $\rho_M/\rho_{\text{cr}} \sim 10^{14}(n_M/s)(m_M/10^3\text{TeV})$ where m_M is the monopole mass and is roughly 1000 TeV. Because 1000 TeV is much smaller than $M_{\text{Planck}} \sim 10^{16}$ TeV, I find that $\rho_M/\rho_{\text{cr}} \sim 10^{-26}$. I conclude that looking for relic monopoles would be a very bad way to test for a low-scale Pati-Salam symmetry breaking phase transition.

2.2 Renormalisation and m_b/m_τ .

The tree-level relation $m_b/m_\tau = 1$ holds at the Pati-Salam symmetry breaking scale, which I will take to be about 1000 TeV. If radiative corrections due to threshold effects at either the high symmetry breaking scale or the low electroweak scale are ignored, then the change in this ratio can be summarised by renormalisation group evolution. This means that the renormalisation group equations are integrated from 1000 TeV to the b and τ mass scale of a few GeV [9] using the boundary condition $m_b = m_\tau$ at 1000 TeV. The result of this evolution is that

$$m_b(m_b) = 4.11 \text{ GeV} \tag{30}$$

having chosen m_τ to come out correctly. (A top mass of 174 GeV was used to derive this.) This would be a very pleasing result if it could be believed. It would mean that Pati-Salam theory predicts the correct b mass provided the symmetry breaking scale is not too different from 1000 TeV. Scales lower than 1000 TeV are phenomenologically disallowed, and they seemingly predict too small a value for m_b anyway. Scales much higher than 1000 TeV generate an overweight bottom. Therefore the theory would predict that observation of the rare decays $K_L^0 \rightarrow \mu^\pm e^\mp$ should occur in the not too distant future, as it is precisely these decays that set the lower limit of about 1000

TeV on m_X [4]. Furthermore, these decays seem to be the most sensitive probe of the Pati-Salam model, so no other rare decays should be observed during this same time scale. The model could therefore either be ruled out, or dramatic evidence gathered in its favour.

However, radiative corrections due to threshold effects *can be extremely important* for a reason I now discuss. (This class of radiative correction is not taken care of through renormalisation group evolution.) The point is that some of the threshold corrections to $m_\tau - m_b$ can be proportional to a large mass in the theory, rather than m_b or m_τ itself. In the present theory, the top quark and the heavy neutrino mass eigenstates are all very massive particles. It will turn out that charged Higgs boson graphs produce a high mass scale threshold correction in this theory that is proportional to the top quark mass. Note that a top quark mass of, say, 180 GeV will completely counteract the $1/16\pi^2$ loop suppression factor.

I now identify those 1-loop self-energy graphs that contribute to $m_b - m_\tau$. These are displayed in Figs.1-7. Figure 1 shows the contributions from the neutral gauge bosons in the model (the photon, the gluons, the Z , and the Z') together with that due to the coloured gauge particle X . Figures 2 and 3 display the contributions due to the electroweak charged Higgs bosons H^- and g^- (I will work in an unphysical gauge). Figures 4 and 5 contain the graphs involving the charged W bosons in both the left- and right-handed sectors, while Fig.6 features graphs containing components of χ . Lastly, Fig.7 assembles all the graphs that arise through mixing between the light and heavy sectors of the theory.

It is sensible to group the graphs in the above manner because of the way the divergences cancel to give a finite $m_\tau - m_b$. All of the individual graphs in Figs.1-6 are logarithmically divergent³, but these divergences cancel within each class of diagrams depicted in the separate figures. The graphs in Fig.7 are all separately finite.

The quantity $m_b - m_\tau$ will now be calculated using these graphs. The charged Higgs boson graphs of Fig.2 will be of most interest. However, I will first discuss the evaluation of the set of graphs in Fig.1 in detail, since this will illuminate how threshold corrections and large logarithmic corrections associated with the renormalisation group coexist. This calculation will also demonstrate the relative unimportance of threshold corrections that are not proportional to a large mass. Following this, I evaluate the important threshold corrections arising from Fig.2. The Appendix provides full details of these evaluations, together with a summary of the contributions from Figs.3-7.

The result for Fig.1 is given by Eq. (71) of the Appendix which I reproduce here

³Actually they are superficially linearly divergent, but the linear part is zero.

for convenience:

$$m_\tau - m_b|_G \simeq -m \frac{\alpha_s}{16\pi} \left(3 \frac{2m_{Z'}^2 + 5m_X^2}{m_{Z'}^2} \ln \frac{m_{Z'}^2}{m^2} + 12 \ln \frac{m_X^2}{m_{Z'}^2} + \frac{3}{2} \frac{2m_{Z'}^2 + 5m_X^2}{m_{Z'}^2} \right). \quad (31)$$

This expression contains both a large logarithm $\ln(m_{Z'}^2/m^2)$, which depends on the hierarchy between the Pati-Salam and electroweak breaking scales, and additional pieces which depend only on mass ratios involving the high mass sector. The large logarithm is associated with those radiative corrections which can be accounted for using the renormalisation group. The additional terms are the sought after threshold corrections.

Let me discuss this distinction a little further: The set of graphs in Fig.1 produce a finite correction to $m_\tau - m_b$; the logarithmic divergences of the individual graphs exactly cancel between the graphs. Since the cancellation occurs between graphs containing light gauge bosons and those containing heavy gauge bosons, there emerges by necessity a large logarithm. If only the light gauge bosons of the SM were included, then $m_\tau - m_b$ would diverge. However, because the heavy sector of the theory “knows” about the physics which is trying to maintain $m_\tau = m_b$, the heavy gauge boson graphs effectively act as an ultraviolet regulator for the logarithmic divergence produced by the light gauge boson graphs. The logarithmic divergence is turned into a large logarithm. The presence of this large dimensionless quantity calls into question the usefulness of 1-loop perturbation theory, because the effective expansion parameter is not the square of a coupling constant but rather the square of a coupling constant multiplied by the large logarithm. This means that higher order graphs may well provide numerically important corrections to the 1-loop expression. The task of calculating these corrections can, fortunately, be elegantly performed by solving the renormalisation group equations, a process that is tantamount to summing these large logarithms to all orders.

I therefore simply omit the large logarithmic term obtained from Fig.1, knowing that its effects will be incorporated by solving the renormalisation group equations. The remaining terms, however, cannot be accounted for in this manner. These threshold corrections, so-called because they depend on heavy mass ratios only, can be viewed as setting up the boundary condition on $m_\tau - m_b$ at the Pati-Salam breaking scale that one must use to solve the renormalisation group equations.

Note that there is an ambiguity in how to separate the large logarithmic term from the threshold corrections. Should the large mass in the logarithm be $m_{Z'}$ as shown above, or m_X instead? In other words, should the running start from the mass $m_{Z'}$ or the mass m_X ? This ambiguity will not be numerically important in this paper, because the large threshold corrections I will obtain from Fig.2 will not need to be separated from a large logarithmic term.

Let us now obtain a numerical estimate for the size of the threshold corrections. They depend through the heavy mass ratios on the coupling constants of $SU(3)_c$ and $SU(2)_R$ (the VEV of χ cancels out). Renormalisation evolution for α_s shows that

$$\alpha_s(\Lambda) = \frac{\alpha_s(m_Z)}{1 + \frac{7}{2\pi}\alpha_s(m_Z)\ln(\Lambda/m_Z)}. \quad (32)$$

Inputting $\alpha_s(m_Z) = 0.118$ produces

$$\alpha_s(1000 \text{ TeV}) = 0.053. \quad (33)$$

The right-handed $SU(2)$ coupling constant is given by

$$\frac{1}{\alpha_R} = \frac{1}{\alpha_Y} - \frac{2}{3\alpha_3}, \quad (34)$$

and renormalisation group evolution implies that

$$\alpha_R(\Lambda) = \frac{3\alpha_Y(m_Z)\alpha_s(m_Z)}{3\alpha_s(m_Z) - 2\alpha_Y(m_Z) - \frac{35}{2\pi}\alpha_Y(m_Z)\alpha_s(m_Z)\ln(\Lambda/m_Z)}. \quad (35)$$

Using $\alpha_Y(m_Z) = 0.0101$ yields

$$\alpha_R(1000 \text{ TeV}) = 0.013. \quad (36)$$

Inputting these values into the last two terms of Eqn. (31) shows that the threshold corrections produce $m_\tau - m_b \simeq 10$'s of MeV. Since renormalisation group evolution alters this quantity by a few GeV, these threshold terms can be safely neglected.

However, the graphs of Fig.2 produce much larger threshold corrections due to the presence of the top quark in the loop and the top-quark mass in the vertices involving the physical charged Higgs boson. Note first of all that it is natural to take the mass m_H of H^- to be of the order of the Pati-Salam breaking scale. The point is that the linear combination that contains H^- of the two $SU(2)_L$ doublets embedded in Φ has zero VEV. This linear combination therefore plays no role in setting the scale of electroweak symmetry breakdown, and the masses of the component fields may take on ‘‘natural’’ values of the order of the high symmetry breaking scale. This is phenomenologically useful because it means that the effective neutral flavour-changing effects that H^- produces at 1-loop order and above are very suppressed [10]. Furthermore, it is clear that no large logarithm will arise for these graphs because they do not separate into a SM subset and a Pati-Salam subset that cancel each others logarithmic divergences.

The physical charged Higgs boson graphs in Fig.2 yield

$$m_\tau - m_b|_H \simeq -\frac{1}{16\pi^2} \frac{m_s^2 - m_t^2}{m_H^2 - m_s^2} \frac{m_t(m_t - m \sin 2\omega)(m_t \sin 2\omega - m)}{(u_1^2 + u_2^2) \cos^2 2\omega} \ln \left(\frac{m_s^2}{m_H^2} \right) \quad (37)$$

in the limit that $m_s, m_H \gg m_t$. I have also assumed in the approximate expression given above that there is no accidental cancellation between $m_t \sin 2\omega$ and m . This threshold correction can clearly produce a mass difference between m_τ and m_b of the order of a GeV, provided this accidental cancellation does not occur. The “common” mass m of τ and b at the Pati-Salam breaking scale must be about the same as the measured m_τ , namely about 1.8 GeV, because m_τ does not evolve strongly under the renormalisation group. The above threshold effect can therefore alter the initial ratio m_b/m_τ by up to 50%. This correction is thus as numerically significant as those incorporated through the renormalisation group. The sign of the correction depends on the unknown parameter ω , and therefore cannot be predicted. It can either raise or lower the mass ratio by up to 50%. Interestingly, the sign does not depend on which of m_s and m_H is larger (although the magnitude of the correction is strongly dependent on these masses).

2.3 Discussion

The calculation demonstrates that generally speaking one must take care in the use of renormalisation group evolution to predict low-energy masses. It is quite possible for low-energy masses to be very sensitive to unknown details surrounding the high symmetry breaking sector, through threshold corrections that are enhanced by a large mass. In the particular model I analysed, the large threshold corrections were produced by graphs involving the physical charged Higgs boson only. It is possible that most models lacking such a particle will also lack large threshold corrections. For instance, one may choose to gauge only the U(1) subgroup of $SU(2)_R$ rather than whole right-handed weak-isospin group. One could then try to construct a model with a single electroweak Higgs doublet rather than the two doublets that are effectively contained within Φ . A physical charged Higgs boson would then be absent, and perhaps also large threshold effects.

It is interesting that the sign of the large threshold correction depends crucially on ω which in turn depends on the relative sign between the two electroweak VEVs u_1 and u_2 . If the correction produces $m_b > m_\tau$ at 1000 TeV, then renormalisation group evolution will produce an overly massive bottom quark. This would necessitate that the accidental cancellation between $m_t \sin 2\omega$ and m occur to some extent. If the correction produces $m_b < m_\tau$, then the masses will need to be evolved for a longer period in order to produce a phenomenologically acceptable outcome. This would mean

that the Pati-Salam breaking scale should be higher than the nominal value of 1000 TeV that I have been considering.

It would be interesting to extend this analysis to a three generation model. Are radiative corrections in the three generation of the model able to accomodate s - μ and d - e mass splitting? This may be possible, given enough freedom to combine renormalisation group evolution and potentially large threshold corrections. It is, however, not obvious that this will work because one would generically expect Higgs boson effects to be less important for lower generations.

However, it is perhaps more worthwhile to think of some horizontal structure that may increase the predictivity of the model. A question in this context is whether or not it would be interesting to invoke a Georgi-Jarlskog texture via a $(15, 2, 2)$ Higgs boson [13], or whether such a tree-level texture would be wiped out by radiative corrections. The important issue of predictivity also raises the question of how to reduce the freedom one has in moulding the size of threshold corrections by unknown details of the heavy sector of the theory. It would clearly be interesting to construct the heavy sector in the simplest possible manner in order to reduce the number of experimentally unknowable parameters.

3. Towards t - b - τ unification

As mentioned in the previous section, if the electroweak bidoublet Φ is chosen to be real then mass equality between isospin partners occurs at tree-level. With $\Phi = \Phi^c$ we have that

$$\Phi = \begin{pmatrix} \phi^0 & -\phi^+ \\ \phi^- & \phi^{0*} \end{pmatrix} \quad (38)$$

and the Yukawa Lagrangian

$$\mathcal{L}_{\text{Yuk}} = \lambda \text{Tr}(\bar{f}_L \Phi f_R) + \text{H.c.} \quad (39)$$

produces

$$m_t = m_b = m_\tau = m_\nu^{\text{Dirac}} = \lambda u, \quad (40)$$

having used

$$\langle \Phi \rangle = \begin{pmatrix} u & 0 \\ 0 & u \end{pmatrix}. \quad (41)$$

The full power of G_{PS} to relate masses is thus evident. A useful way to view the above phenomenon is that custodial $SU(2)$ has been gauged and upgraded to an exact symmetry of the Lagrangian by its identification with $SU(2)_R$.

I have demonstrated that radiative corrections can alter mass ratios dramatically. However, the measured ratio m_t/m_τ is about 100 and thus threshold corrections cannot plausibly be used to fix up $m_t = m_\tau$, unless the large mass used to enhance the correction is very much larger than m_t [11]. One may speculate that the neutrino sector of a theory may produce such an effect, although this did not happen in the Pati-Salam model considered in the previous Section.

The obvious alternative is to use some form of see-saw mechanism to depress m_τ and m_b relative to m_t , just as one may do in the neutrino sector. In other words, mixing effects rather than radiative corrections can be relied upon to explain why $m_{\nu_\tau} \ll m_{\tau,b} \ll m_t$, while radiative corrections only are used to accomodate the ratio m_b/m_τ .

It is therefore rather interesting to observe that the **10** of SU(4) has the branching rule

$$\mathbf{10} \rightarrow \mathbf{6}\left(\frac{2}{3}\right) \oplus \mathbf{3}\left(-\frac{2}{3}\right) \oplus \mathbf{1}(-2) \quad (42)$$

to $SU(3) \otimes U(1)_{B-L}$. The colour triplet component has electric charge $-1/3$, while the colour singlet has electric charge -1 . Within this one irreducible representation lie the correct states that can mix with b and τ in a see-saw manner. Furthermore, the electric charge $+2/3$ state is absent. One can therefore arrange for m_b and m_τ to be lowered with respect to m_t . In addition, a fermion in the $(10, 1, 1)$ representation of G_{PS} can mix with f_R via Yukawa coupling with χ . All the ingredients are there within the group theory of SU(4) to do exactly what I want to do. I find this to be a rather striking fact.

So, I write down a new Pati-Salam model that contains the fermions

$$f_L \sim (4, 2, 1), \quad f_R \sim (4, 1, 2), \quad F_L \sim (10, 1, 1), \quad F_R \sim (10, 1, 1), \quad N_L \sim (1, 1, 1) \quad (43)$$

and the Higgs bosons

$$\Phi = \Phi^c \sim (1, 2, 2) \quad \text{and} \quad \chi \sim (4, 1, 2). \quad (44)$$

The full Yukawa Lagrangian is

$$\mathcal{L}_{\text{Yuk}} = \lambda \text{Tr}(\bar{f}_L \Phi f_R) + h \text{Tr}(\bar{F}_L \chi^T i\tau_2 f_R) + n \bar{N}_L \text{Tr}(\chi^\dagger f_R) + M_F \text{Tr}(\bar{F}_L F_R) + \text{H.c.} \quad (45)$$

where $F_{L,R}$ have been written as symmetric 4×4 matrices which undergo the SU(4) transformation $F_{L,R} \rightarrow U_4 F_{L,R} U_4^T$. In component form,

$$F = \begin{pmatrix} S & \frac{B}{\sqrt{2}} \\ \frac{B^T}{\sqrt{2}} & E \end{pmatrix} \quad (46)$$

where S is a 3×3 symmetric matrix representing the colour sextet, B is a 3×1 column matrix representing the colour triplet and E is the colour singlet. The $\sqrt{2}$ in this equation is required in order to normalise the kinetic energy terms for B and E consistently.

The top and Dirac neutrino masses are simply

$$m_t = m_\nu^{\text{Dirac}} = \lambda u. \quad (47)$$

However, bottom and tau now have 2×2 mass matrices given by

$$\mathcal{L}_b = \begin{pmatrix} \bar{b}_L & \bar{B}_L \end{pmatrix} \begin{pmatrix} m_t & 0 \\ m_B & M_F \end{pmatrix} \begin{pmatrix} b_R \\ B_R \end{pmatrix} + \text{H.c.} \quad (48)$$

and

$$\mathcal{L}_\tau = \begin{pmatrix} \bar{\tau}_L & \bar{E}_L \end{pmatrix} \begin{pmatrix} m_t & 0 \\ \sqrt{2}m_B & M_F \end{pmatrix} \begin{pmatrix} \tau_R \\ E_R \end{pmatrix} + \text{H.c.} \quad (49)$$

where $m_B \equiv hv/\sqrt{2}$. The $\sqrt{2}$ in the τ mass matrix comes from the $\sqrt{2}$ in Eq. (46).

Since $v \gg u$, we expect that $m_B \gg m_t$, unless the Yukawa coupling constant h is very small. One large eigenvalue and one small eigenvalue is thus expected from each mass matrix, provided the bare mass M_F is not too large. In fact, if $M_F \ll m_B$ (but not necessarily small compared to m_t) the smallest eigenvalues are roughly $\sqrt{2}m_t M_F/m_B$ for the b system, and $m_t M_F/m_B$ for the τ -system. This shows that mixing between f and F can indeed suppress m_b and m_τ with respect to m_t . So, the small eigenvalues are identified with m_b and m_τ , while I will call the large eigenvalues $m_{b'}$ and $m_{\tau'}$.

The two mass matrices produce four eigenvalues in terms of three parameters. This means there is one relation connecting them. The relation can be written most usefully in the form

$$\frac{m_b}{m_\tau} = \left[\frac{2 - \frac{m_t^2}{m_{b'}^2} - \frac{m_\tau^2}{m_{b'}^2}}{1 + \frac{m_\tau^2}{m_t^2} - 2\frac{m_\tau^2}{m_{b'}^2}} \right]^{\frac{1}{2}} \quad (50)$$

where I have chosen m_t rather than $m_{\tau'}$ as one of the mass parameters on the right-hand side. (Note that $m_{\tau'} = m_{b'} m_b / m_\tau$.) Since $m_\tau \ll m_t$, $m_{b'}$ is required,

$$\frac{m_b}{m_\tau} \simeq \sqrt{2 - \frac{m_t^2}{m_{b'}^2}} \quad (51)$$

must hold so that $m_b \rightarrow \sqrt{2}m_\tau$ as $m_{b'} \rightarrow \infty$.

For the interesting case where $m_t \ll M_F \ll m_B$, the light mass eigenstate fields \tilde{b} and $\tilde{\tau}$ are

$$\tilde{b}_L \simeq b_L - \frac{m_t}{m_B} B_L, \quad \tilde{b}_R \simeq B_R - \frac{M_F}{m_B} b_R \quad (52)$$

and

$$\tilde{\tau}_L \simeq \tau_L - \frac{m_t}{\sqrt{2}m_B} E_L, \quad \tilde{\tau}_R \simeq E_R - \frac{M_F}{\sqrt{2}m_B} \tau_R. \quad (53)$$

Thus the left-handed mass eigenstates b and τ are predominantly in f_L , while their right-handed projections are mostly in F_R . This is important because it means the light mass eigenstates will feel the standard left-handed weak interactions to a higher degree of accuracy, as is phenomenologically required. The right-handed states will, however, have their couplings to right-sector weak bosons suppressed by M_F/m_B . This behaviour is similar to Ma's alternative formulation of left-right symmetry [12]. Because $m_b \ll M_F, m_B$ is phenomenologically necessary, $m_b \simeq \sqrt{2}m_\tau$ must hold to a good level of approximation at tree-level.

So, I have shown that mixing effects can induce the pattern $m_{\nu_\tau} = 0 \ll m_b, m_\tau \ll m_t$ provided M_F is not too large. (The neutrino sector here is identical to that of the Sec.II.) It remains to be seen whether or not radiative effects can provide a successful value for m_b/m_τ . The explicit calculation of the necessary diagrams is beyond the scope of this paper, although experience with the previous model suggests that there may be large threshold corrections due to Higgs boson graphs that can be arranged to produce a phenomenological successful mass pattern for the third family, particularly given the involvement of the heavy fermions in some relevant diagrams. It may be that the additional factor of roughly $\sqrt{2}$ in the tree-level value of m_b/m_τ can be negated by a threshold correction, with the ensuing boundary condition $m_\tau \simeq m_b$ at 1000 TeV then producing successful low-energy values.

4. Conclusion

The idea that Pati-Salam SU(4) might be broken at a relatively low energy such as 1000 TeV is a very appealing one. I have shown in this work how the model ought to be constructed in order to achieve this in a way consistent with Hot Big Bang cosmology and particle phenomenology. I pointed out that a different and simpler Higgs sector to that usually employed to break SU(4) is required. The simplest version of this model predicts massless neutrinos, although massive neutrinos are not difficult to incorporate.

The core of the paper was then a calculation of the radiative corrections to the tree-level mass relation $m_b = m_\tau$ induced by mass thresholds. I found that the set of graphs involving the charged Higgs boson produces a generically large correction, enhanced by m_t/m_τ . This can alter the ratio m_b/m_τ by up to about 50%. Whether

this correction increases or decreases the ratio depends on the relative sign between the two VEVs that break the electroweak group. If the ratio is increased, then the combined effect of the threshold correction and renormalisation group evolution tends to produce an overly massive bottom quark. If the ratio is decreased, then the scale of Pati-Salam symmetry breaking needs to be raised in order to allow the masses to run for longer under the renormalisation group. In either case, the generically large threshold correction can be reduced by a fine-tuning of parameters.

It was then demonstrated that the identification of $SU(2)_R$ with custodial $SU(2)$ can yield t - b - τ unification at tree-level when combined with Pati-Salam $SU(4)$. I showed how the hierarchy $m_{\nu_\tau} \ll m_{b,\tau} \ll m_t$ can arise due to two different see-saw mechanisms, and I conjectured that the b - τ splitting can possibly be accommodated within the theory.

I am therefore able to reach the important conclusion that the observed mass pattern of the third generation of quarks and leptons can be reproduced by a Pati-Salam $SU(4)$ theory far below a hypothetical GUT scale. This scale could be just above the current lower bound of about 1000 TeV. However, one must be mindful that large threshold corrections be incorporated (or cancelled off as the case might be), as well as renormalisation group effects. This motivates that an on-going search for rare processes such as $K_L^0 \rightarrow \mu^\pm e^\mp$ be maintained. The detection of such a process may provide the first experimental clue to the physics behind the fermion mass problem and the relationship between quarks and leptons.

Note Added

After these calculations were substantially complete, a somewhat similar model was considered in Ref.[14]. It was shown here that threshold corrections can induce mass corrections of the order of several GeV, which lends further support to the idea that a combination of renormalisation group evolution and large threshold corrections may be interesting for the fermion mass problem in theories with new physics far below 10^{16} GeV. Although this paper explicitly considers a GUT-scale theory, the effects found can also occur in lower scale physics, as was noted in the manuscript.

Acknowledgements

The author is indebted to K. S. Babu for his collaboration on portions of this

work, and in particular for checking some of the calculations. (Any errors in the manuscript are the sole responsibility of the author, however). He would like to thank Professor J. C. Taylor and the theoretical particle physics group in the Department of Applied Mathematics and Theoretical Physics at the University of Cambridge for kind hospitality while this work was performed. He would also like to thank R. B. Mann and R. Thorne for some brief but useful discussions, and R. Foot for a helpful piece of correspondence. This work was partially supported by the Australian Research Council and partially by the University of Melbourne.

Appendix

In this Appendix I will calculate the graphs displayed in Figs.1-7, working in Feynman gauge for all of the gauge interactions. A highly non-trivial consistency check on the calculation will be that all of the divergences should cancel in $m_\tau - m_b$.

A pragmatic approach to the regularisation of the various integrals will be adopted, employing either dimensional regularisation or Pauli-Villars regularisation depending on what happens to be convenient. Since I am calculating a finite quantity, no inconsistency is introduced by employing two different regularisation procedures.

A.1 Graphs in Figure 1

In this first subsection I will calculate the contribution of the diagrams in Fig.1 To simplify the task, the mass of the Z -boson will be set to zero, thus making it degenerate with the photon. Everything can then be rewritten in terms of B and W_L^0 , the latter being the neutral gauge boson of $SU(2)_L$. But then the W_L^0 boson graph need not be considered, since it couples universally to b and τ . Since I am interested in threshold corrections due to heavy sector masses, my neglect of m_Z will be of no numerical significance.

It is useful to first consider a general gauge interaction of the form

$$\mathcal{L}(x, y) = \bar{f}_1 \gamma^\mu (x + y\gamma_5) f_2 A_\mu \quad (54)$$

where $f_{1,2}$ both have mass m , A has mass M and where f_1 and f_2 may be the same field. The 1-loop self-energy generated by $\mathcal{L}(x, y)$ is

$$-i\Sigma_F = - \int \frac{d^4k}{(2\pi)^4} \frac{\gamma^\mu (x + y\gamma_5) (\hat{p} + \hat{k} + m) \gamma_\mu (x + y\gamma_5)}{[(k+p)^2 - m^2](k^2 - M^2)}, \quad (55)$$

where the symbol \hat{k} means $\gamma^\mu k_\mu$.

These terms contain both wave-function renormalisation constants as well as mass shifts, and I seek only the latter. A general fermion self-energy Σ may be written in the form

$$\Sigma = A(\hat{p} - m) + B(\hat{p} - m)\gamma_5 + C\gamma_5(\hat{p} - m) + \delta m, \quad (56)$$

where A , B and C contribute to wave-function renormalisation while δm is the mass shift. The γ_5 dependence shown above is required because of the complication that the gauge interactions I consider are chiral. It is important to realise that the coefficient of γ_5 in the self-energy contributes only to wave-function renormalisation. One might fear that this cannot be the case because in general Σ should have a term of the form

$\delta\mu\gamma_5$, which looks like a peculiar γ_5 -dependent contribution to the mass. However, the identity

$$\gamma_5 = -\frac{(\hat{p} - m)\gamma_5 + \gamma_5(\hat{p} - m)}{2m} \quad (57)$$

shows that such a term can always be subsumed into the B and C terms in Eq. (56). Since these terms cannot shift the pole away from $\hat{p} = m$, they do not contribute to mass renormalisation. In practice then, the mass shift is isolated by setting $\hat{p} = m$, $p^2 = m^2$ and dropping the contribution proportional to γ_5 .

To proceed I first regularise the divergent integrals by continuing to n -dimensions. Although $m_\tau - m_b$ will be a finite quantity, it is the sum of integrals that are separately divergent. In order to be certain that no errors are introduced by a naive cancellation of infinite quantities, I feel it prudent to regularise the integrals first.⁴ This may seem like pedantry because the answer turns out to be identical to that obtained by just such a naive cancellation. However, I view the cancellation of regularised divergences as a justification for veracity of the naive method.

To avoid n -dimensional γ -matrix algebra involving γ_5 , the positions of all the γ -matrices in the numerator are frozen. Since the integral is now finite, all ordinary manipulations except for Dirac algebra can be performed. Equations 20 and 21 are now used in conjunction with the familiar gluon interaction with quarks to obtain the x and y parameters for each diagram. The contributions are then summed with the appropriate colour factors for the X boson and gluon graphs inserted.

The self-energies for τ and b are

$$-i\Sigma(f) = -\int \frac{d^n k}{(2\pi)^n} \frac{N(f)}{(k+p)^2 - m^2} \quad (58)$$

where $f = \tau, b$ and

$$\begin{aligned} N(\tau) &= \frac{3}{8} \frac{g_R^2 g_s^2}{g_R^2 + \frac{3}{2}g_s^2} \frac{\gamma^\mu(1 + P_R)(\hat{p} + \hat{k} + m)\gamma_\mu(1 + P_R)}{k^2} \\ &+ \frac{1}{16} \frac{1}{g_R^2 + \frac{3}{2}g_s^2} \frac{\gamma^\mu(3g_s^2 - 2g_R^2 P_R)(\hat{p} + \hat{k} + m)\gamma_\mu(3g_s^2 - 2g_R^2 P_R)}{k^2 - m_{Z'}^2} \\ &+ \frac{3g_s^2}{2} \frac{\gamma^\mu(\hat{p} + \hat{k} + m)\gamma_\mu}{k^2 - m_X^2}. \end{aligned} \quad (59)$$

⁴ By “naive” I mean the combining of the integrands of Feynman integrals using a common denominator after having simplified the numerators using 4-dimensional Dirac algebra.

The three terms in this equation come from the B graph, the Z' graph and the X graph, respectively. The corresponding expression for b is

$$\begin{aligned}
N(b) &= \frac{1}{24} \frac{g_R^2 g_s^2}{g_R^2 + \frac{3}{2} g_s^2} \frac{\gamma^\mu (1 - 3P_R)(\hat{p} + \hat{k} + m)\gamma_\mu (1 - 3P_R)}{k^2} \\
&+ \frac{1}{16} \frac{1}{g_R^2 + \frac{3}{2} g_s^2} \frac{\gamma^\mu (g_s^2 + 2g_R^2 P_R)(\hat{p} + \hat{k} + m)\gamma_\mu (g_s^2 + 2g_R^2 P_R)}{k^2 - m_{Z'}^2} \\
&+ \frac{g_s^2}{2} \frac{\gamma^\mu (\hat{p} + \hat{k} + m)\gamma_\mu}{k^2 - m_X^2} \\
&+ \frac{4g_s^2}{3} \frac{\gamma^\mu (\hat{p} + \hat{k} + m)\gamma_\mu}{k^2}, \tag{60}
\end{aligned}$$

where the fourth term is due to the gluon graph. Expanding the numerators above, without commuting any of the Dirac matrices through each other, and subtracting the b term from the τ term I find that

$$-i(\Sigma_\tau - \Sigma_b) = -\frac{1}{g_R^2 + \frac{3}{2} g_s^2} \int \frac{d^n k}{(2\pi)^n} \frac{N}{(k+p)^2 - m^2} \tag{61}$$

where

$$\begin{aligned}
N &= \frac{g_R^2 g_s^2 [\frac{1}{3} \gamma^\mu (\hat{p} + \hat{k} + m)\gamma_\mu + \frac{1}{2} \gamma^\mu P_R (\hat{p} + \hat{k} + m)\gamma_\mu + \frac{1}{2} \gamma^\mu (\hat{p} + \hat{k} + m)\gamma_\mu P_R]}{k^2} \\
&+ \frac{g_s^2 [\frac{1}{2} g_s^2 \gamma^\mu (\hat{p} + \hat{k} + m)\gamma_\mu - \frac{1}{2} g_R^2 \gamma^\mu P_R (\hat{p} + \hat{k} + m)\gamma_\mu - \frac{1}{2} g_R^2 \gamma^\mu (\hat{p} + \hat{k} + m)\gamma_\mu P_R]}{k^2 - m_{Z'}^2} \\
&+ \frac{g_s^2 (g_R^2 + \frac{3}{2} g_s^2) \gamma^\mu (\hat{p} + \hat{k} + m)\gamma_\mu}{k^2 - m_X^2} \\
&- \frac{\frac{4}{3} g_s^2 (g_R^2 + \frac{3}{2} g_s^2) \gamma^\mu (\hat{p} + \hat{k} + m)\gamma_\mu}{k^2}. \tag{62}
\end{aligned}$$

The cancellation of the divergences is evident in this expression. The individually divergent pieces may be isolated by temporarily setting $m_{Z'} = m_X = 0$. The terms containing P_R cancel between the B and Z' graphs, while all four graphs are required to see the cancellation in the P_R -independent terms. Since $-i(\Sigma_\tau - \Sigma_b)$ is finite, the integral can now be continued back to 4-dimensions and Dirac algebra used.

This result illustrates the general phenomenon that the heavy particles act effectively as ultraviolet cutoffs for the self-energy graphs involving SM particles only. If only the B boson and gluon graphs are included, then $-i(\Sigma_\tau - \Sigma_b)$ is divergent. This

is as expected because the low-energy effective theory is the SM which requires a counterterm to absorb such a divergence. When all four graphs are included, the full SU(4) symmetry of the underlying Lagrangian is felt by $-i(\Sigma_\tau - \Sigma_b)$ and it is revealed as a finite quantity.

Equation 61 may be rewritten more compactly as

$$\begin{aligned} -i(\Sigma_\tau - \Sigma_b) &= \frac{g_s^2}{2}(9m_X^2 - 2m_{Z'}^2) \int \frac{d^4k}{(2\pi)^4} \frac{\hat{p} + \hat{k} - 2m}{D} \\ &- \frac{g_s^2}{2}m_X^2(5m_X^2 + 2m_{Z'}^2) \int \frac{d^4k}{(2\pi)^4} \frac{\hat{p} + \hat{k} - 2m}{Dk^2} + (\gamma_5 \text{ term}), \end{aligned} \quad (63)$$

where

$$D \equiv [(k+p)^2 - m^2](k^2 - m_{Z'}^2)(k^2 - m_X^2). \quad (64)$$

The γ_5 term is now dropped, and the remaining integrals have to be evaluated further to isolate the mass shift.

The required integrals are

$$I_3 = \int \frac{d^4k}{(2\pi)^4} \frac{1}{D}, \quad I_4 = \int \frac{d^4k}{(2\pi)^4} \frac{1}{Dk^2}, \quad (65)$$

and

$$\hat{I}_3 = \int \frac{d^4k}{(2\pi)^4} \frac{\hat{k}}{D}, \quad \hat{I}_4 = \int \frac{d^4k}{(2\pi)^4} \frac{\hat{k}}{Dk^2}. \quad (66)$$

I now approximately evaluate these integrals with $p^2 = m^2$ under the condition that $m_X^2 \sim m_{Z'}^2 \gg m^2$.

The results are,

$$I_3 \simeq \frac{i}{16\pi^2} \frac{1}{m_{Z'}^2 - m_X^2} \ln \left(\frac{m_X^2}{m_{Z'}^2} \right); \quad (67)$$

$$I_4 \simeq \frac{i}{16\pi^2} \frac{1}{m_X^2} \left[\frac{1}{m_{Z'}^2} \ln \left(\frac{m_{Z'}^2}{m^2} \right) + \frac{1}{m_{Z'}^2} + \frac{1}{m_{Z'}^2 - m_X^2} \ln \left(\frac{m_X^2}{m_{Z'}^2} \right) \right]; \quad (68)$$

$$\hat{I}_3 \simeq -\frac{\hat{p}}{2} I_3; \quad (69)$$

$$\hat{I}_4 \simeq \frac{i}{32\pi^2} \frac{\hat{p}}{m_X^2} \left[-\frac{1}{m_{Z'}^2} \ln \left(\frac{m_{Z'}^2}{m^2} \right) + \frac{1}{2m_{Z'}^2} + \frac{1}{m_X^2 - m_{Z'}^2} \ln \left(\frac{m_X^2}{m_{Z'}^2} \right) \right]. \quad (70)$$

Note that I_4 and \hat{I}_4 contain the large logarithms associated with the renormalisation group.

Substituting these expressions into Eqn. (63) and replacing \hat{p} by m to extract the mass shift part only, I find that

$$m_\tau - m_b|_G \simeq -m \frac{\alpha_s}{16\pi} \left(3 \frac{2m_{Z'}^2 + 5m_X^2}{m_{Z'}^2} \ln \frac{m_{Z'}^2}{m^2} + 12 \ln \frac{m_X^2}{m_{Z'}^2} + \frac{3}{2} \frac{2m_{Z'}^2 + 5m_X^2}{m_{Z'}^2} \right). \quad (71)$$

where I have kept only the large logarithmic terms followed by the largest threshold corrections.

A.2 Graphs in Figure 2

By contrast with the previous subsection, I will not employ dimensional regularisation but rather Pauli-Villars regularisation in this subsection. This is convenient because all of the graphs in Fig.2 have the same boson H^- in the loop, and so the Pauli-Villars cut-off Λ is necessarily the same for all the graphs. In Fig.1 all of the bosons are different and therefore in principle one could employ different cut-off masses for each of the bosons. This would cloud the issue of divergence cancellation between the graphs, although it could still be demonstrated in the limit that all of the regulating masses were simultaneously large. Furthermore, once the Pauli-Villars regulator is introduced for the graphs in Fig.2 I am free to use 4-dimensional Dirac algebra immediately. This is very convenient.⁵

Please be aware that I will calculate the graphs in Figs.2-6 with the neglect of mixing between the heavy and light sectors. I will comment in Sec.A.7 of this Appendix on the additional contributions due to mixing.

The three graphs in Fig.2 combine to yield

$$\begin{aligned} -i(\Sigma_\tau - \Sigma_b)|_H &= \int \frac{d^4k}{(2\pi)^4} \left[\frac{(a_H \sin \theta P_R + b_H P_L)(\hat{p} + \hat{k} + m_s)(a_H \sin \theta P_L + b_H P_R)}{[(k+p)^2 - m_s^2]} \right. \\ &+ \frac{a_H^2 \cos^2 \theta P_R(\hat{p} + \hat{k})P_L}{(k+p)^2} \\ &\left. - \frac{(a_H P_R + b_H P_L)(\hat{p} + \hat{k} + m_t)(a_H P_L + b_H P_R)}{[(k+p)^2 - m_t^2]} \right] \times \\ &\times \left(\frac{1}{k^2 - m_H^2} - \frac{1}{k^2 - \Lambda^2} \right). \end{aligned} \quad (72)$$

Each of the three terms in this expression are finite because of the Pauli-Villars regularisation.

⁵In fact, the calculations show that you cannot demonstrate the cancellation of the divergences for Fig.2 without having to pass a γ_5 through a γ_μ . This is curiously different from the situation in Fig.1.

Inspection of this equation reveals that the potentially divergent part has an integrand proportional to div_H where

$$\begin{aligned}\text{div}_H &= [a_H^2 \sin^2 \theta (\hat{p} + \hat{k}) P_L + b_H^2 P_R + m_s \sin \theta a_H b_H] \\ &+ [a_H^2 \cos^2 \theta (\hat{p} + \hat{k}) P_L] \\ &- [a_H^2 (\hat{p} + \hat{k}) P_L + b_H^2 P_R + m_t a_H b_H].\end{aligned}\quad (73)$$

Dirac algebra has been used to simplify this expression, and the three terms in square brackets above correspond to the three integrals in Eq. (72). Using $m_s \sin \theta = m_t$ we see that $\text{div}_H = 0$.

Taking $\Lambda \rightarrow \infty$ now that the divergences have disappeared, and isolating the γ_5 part, I find that

$$\begin{aligned}-i(\Sigma_\tau - \Sigma_b)|_H &= M^2 \int \frac{d^4 k}{(2\pi)^4} \frac{\frac{1}{2} b_H^2 \hat{k} + m_t a_H b_H}{[(k-p)^2 - m_H^2](k^2 - m_s^2)(k^2 - m_t^2)} \\ &+ \frac{1}{2} m_t^2 M^2 a_H^2 \int \frac{d^4 k}{(2\pi)^4} \frac{\hat{k}}{[(k-p)^2 - m_H^2] k^2 (k^2 - m_s^2)(k^2 - m_t^2)} \\ &+ (\gamma_5 \text{ part})\end{aligned}\quad (74)$$

Integration variables have also been changed in this expression.

The integrals required above are the same as I_3 , \hat{I}_3 and I_4 introduced in the Sec.A.1 but with $\hat{p} \rightarrow -\hat{p}$. They approximately evaluate to

$$I_3 \simeq \frac{i}{16\pi^2} \frac{1}{m_H^2 - m_s^2} \ln \left(\frac{m_s^2}{m_H^2} \right), \quad (75)$$

$$\hat{I}_3 \simeq \frac{i}{32\pi^2} \frac{\hat{p}}{m_s^2 - m_H^2} \left[1 + \frac{m_s^2}{m_H^2 - m_s^2} \ln \left(\frac{m_s^2}{m_H^2} \right) \right], \quad (76)$$

$$\hat{I}_4 \simeq \frac{1}{m_s^2} \hat{I}_3, \quad (77)$$

under the condition that $m_H^2 \sim m_s^2 \gg m_t^2 \gg p^2 = m^2$.

The contributions to Eqn. (74) involving \hat{I}_3 and \hat{I}_4 will generically be much smaller than that involving I_3 . The \hat{k} in the integrand produces a \hat{p} after integration which in turn becomes an m after the mass shift part is isolated. This overall factor of m is not cancelled off, as is evident from the integral evaluations above, so this suppresses the \hat{I} terms relative to the $M^2 m_t a_H b_H I_3$ term. It is possible to cancel the generically dominant term if $m_t \sin 2\omega \simeq m$.

Assuming this accidental cancellation does not occur, I find that

$$m_\tau - m_b|_H \simeq -\frac{1}{16\pi^2} \frac{m_s^2 - m_t^2}{m_H^2 - m_s^2} \frac{m_t(m_t - m \sin 2\omega)(m_t \sin 2\omega - m)}{(u_1^2 + u_2^2) \cos^2 2\omega} \ln \left(\frac{m_s^2}{m_H^2} \right). \quad (78)$$

A.3 Graphs in Figure 3

Using Pauli-Villars regularisation and working in Feynman gauge, the graphs of Fig.3 yield

$$\begin{aligned} -i(\Sigma_\tau - \Sigma_b) &= \int \frac{d^4k}{(2\pi)^4} \frac{m_{WL}^2 - \Lambda^2}{(k^2 - m_{WL}^2)(k^2 - \Lambda^2)} \left[-\frac{(\hat{k} + \hat{p})(a_g^2 P_R + b_g^2 P_L) + a_g b_g m_t}{(k+p)^2 - m_t^2} \right. \\ &+ \frac{(\hat{k} + \hat{p})a_g^2 \cos^2 \theta P_R}{(k+p)^2} \\ &+ \left. \frac{(\hat{k} + \hat{p})(a_g^2 \sin^2 \theta P_R + b_g^2 P_L) + a_g b_g m_t}{(k+p)^2 - m_s^2} \right], \end{aligned} \quad (79)$$

where the three terms above correspond to the three graphs. Dirac algebra simplification and $m_t = m_s \sin \theta$ have been used here.

The potentially divergent piece has an integrand proportional to div_g where

$$\begin{aligned} \text{div}_g &= [-(\hat{k} + \hat{p})(a_g^2 P_R + b_g^2 P_L) - a_g b_g m_t] + [(\hat{k} + \hat{p})a_g^2 \cos^2 \theta P_R] \\ &+ [(\hat{k} + \hat{p})(a_g^2 \sin^2 \theta P_R + b_g^2 P_L) + a_g b_g m_t]. \end{aligned} \quad (80)$$

The three terms in square brackets correspond to the three graphs. Note that the divergences cancel.

Taking the cut-off to infinity, discarding the γ_5 term and changing integration variables reveals that

$$\begin{aligned} -i(\Sigma_\tau - \Sigma_b) &= M^2 \int \frac{d^4k}{(2\pi)^4} \frac{\frac{1}{2}b_g^2 \hat{k} + a_g b_g m_t}{[(k-p)^2 - m_{WL}^2](k^2 - m_t^2)(k^2 - m_s^2)} \\ &+ \frac{1}{2}a_g^2 m_t^2 M^2 \int \frac{d^4k}{(2\pi)^4} \frac{1}{[(k-p)^2 - m_{WL}^2]k^2(k^2 - m_t^2)(k^2 - m_s^2)} \\ &+ (\gamma_5 \text{ term}). \end{aligned} \quad (81)$$

From the experience gained with the explicit evaluation of Figs.1 and 2 the qualitative behaviour of this expression can now be ascertained without explicit computation.

In the limit $M^2 \rightarrow \infty$, the first term above gives a large logarithm while the second does not. The first term thus contributes to renormalisation group running (plus residual threshold effects) while the second term contains threshold effects only. By contrast with Figs.1 and 2, however, the threshold effects will involve the mass ratios of W_L and t which are relatively light particles.

None of these threshold terms are enhanced by m_t , however. The potential m_t^3 term disappears because of the chiral structure of the graphs. To obtain such a term, a $m_t b_g^2$ piece in the integrand would be needed. There is no such term because it is proportional to $P_R P_L = 0$. The potentially enormous $m_s m_t^2$ term is zero for the same reason. I conclude therefore, that the low mass scale threshold corrections from Fig.3 are numerically small compared to the m_t enhanced effects from Fig.2.

A.4 Graphs in Figure 4

The three graphs in Fig.4 imply that

$$\begin{aligned}
-i(\Sigma_\tau - \Sigma_b)|_{W_L} &= \frac{g_L^2}{2} \int \frac{d^4 k}{(2\pi)^4} \frac{m_{W_L}^2 - \Lambda^2}{(k^2 - \Lambda^2)(k^2 - m_{W_L}^2)} \left[\frac{\cos^2 \theta \gamma^\mu (\hat{k} + \hat{p}) \gamma_\mu P_L}{(k+p)^2} \right. \\
&\quad \left. + \frac{\sin^2 \theta \gamma^\mu (\hat{k} + \hat{p}) \gamma_\mu P_L}{(k+p)^2 - m_s^2} - \frac{\gamma^\mu (\hat{k} + \hat{p}) \gamma_\mu P_L}{(k+p)^2 - m_t^2} \right] \quad (82)
\end{aligned}$$

where again Pauli-Villars regularisation has been used, followed by Dirac algebra simplification. The three terms above correspond to the three graphs in Fig.4.

It is easy to see by inspection that the potential divergence cancels, giving that

$$-i(\Sigma_\tau - \Sigma_b)|_{W_L} = \frac{g_L^2}{2} m_t^2 M^2 \int \frac{d^4 k}{(2\pi)^4} \frac{\gamma^\mu \hat{k} \gamma_\mu P_L}{[(k-p)^2 - m_{W_L}^2] k^2 (k^2 - m_s^2) (k^2 - m_t^2)}. \quad (83)$$

The cut-off has been taken to infinity and integration variables changed to obtain this expression. As $M^2 \rightarrow \infty$, this contribution remains finite. Therefore it does not generate a large logarithm; it is purely a (light mass scale) threshold effect. The physical reason for this is that the divergence cancellation cannot fail when the ν_R state is removed from the physical spectrum by taking $M^2 \rightarrow \infty$. The left-sector W bosons couple to ν_L , so the absence of ν_R does not affect the cancellation of divergences. There is also no enhancement due to m_t , because the m_t term in the numerator disappears through $P_L P_R = 0$ and because the vertices are not proportional to m_t .

A.5 Graphs in Figure 5

The two graphs involving the W_R boson lead to

$$-i(\Sigma_\tau - \Sigma_b)|_{W_R} = \frac{g_R^2}{2} \int \frac{d^4 k}{(2\pi)^4} \frac{m_{W_R}^2 - \Lambda^2}{(k^2 - \Lambda^2)(k^2 - m_{W_R}^2)} \times$$

$$\times \left[-\frac{\gamma^\mu(\hat{p} + \hat{k})\gamma_\mu P_R}{(k+p)^2 - m_s^2} + \frac{\gamma^\mu(\hat{p} + \hat{k})\gamma_\mu P_R}{(k+p)^2 - m_t^2} \right] \quad (84)$$

where, again, Pauli-Villars regularisation and Dirac algebra simplification have been used.

It is obvious that the potential divergence cancels between the two graphs. Therefore it is clear that

$$-i(\Sigma_\tau - \Sigma_b)|_{W_R} = -\frac{g_R^2}{2} M^2 \int \frac{d^4 k}{(2\pi)^4} \frac{\gamma^\mu \hat{k} \gamma_\mu P_R}{[(k-p)^2 - m_{W_R}^2](k^2 - m_t^2)(k^2 - m_s^2)}. \quad (85)$$

The cut-off has been taken to infinity and a change of integration variables has been performed.

As the Pati-Salam breaking scale is taken to infinity, both M and m_{W_R} go to infinity. In this limit then,

$$-i(\Sigma_\tau - \Sigma_b)|_{W_R} \rightarrow -\frac{g_R^2}{2} \frac{1}{m_{W_R}^2} \int \frac{d^4 k}{(2\pi)^4} \frac{\gamma^\mu \hat{k} \gamma_\mu}{k^2 - m_t^2} \quad (86)$$

which integrates to zero because the integrand tends to an odd function of k . Therefore no large logarithms are generated by separating the two symmetry breaking scales and the terms that remain nonzero for large but finite high scale masses are small.

A.6 Graphs in Figure 6

I now turn to the diagrams involving the heavy Higgs bosons χ . I will again be able to demonstrate that the divergences cancel without having to rearrange the Dirac matrices, so I work in n -dimensions from the start. The contribution of the unphysical Higgs boson χ^- is

$$-i\Sigma_\tau|_{\chi^-} = n^2 \int \frac{d^n k}{(2\pi)^n} \frac{1}{k^2 - m_{W_R}^2} \left[\frac{\sin^2 \theta P_L(\hat{p} + \hat{k})P_R}{(k+p)^2} + \frac{\cos^2 \theta P_L(\hat{p} + \hat{k})P_R}{(k+p)^2 - m_s^2} \right] \quad (87)$$

where the n -dimensional result $P_L P_R = 0$ has been used.

The coloured boson χ^d on the other hand has a contribution given by

$$-i\Sigma_b|_{\chi^d} = n^2 \int \frac{d^n k}{(2\pi)^n} \frac{1}{k^2 - m_{\chi^d}^2} \left[\frac{\sin^2 \theta P_L(\hat{p} + \hat{k})P_R}{(k+p)^2} + \frac{\cos^2 \theta P_L(\hat{p} + \hat{k})P_R}{(k+p)^2 - m_s^2} \right], \quad (88)$$

where again $P_L P_R = 0$ has been used and nothing more.

It is clear that the divergences cancel when the b contribution is subtracted from the τ contribution. Deleting the γ_5 part I find that

$$\begin{aligned}
-i(\Sigma_\tau - \Sigma_b)|_\chi &= \frac{n^2}{2}(m_{W_R}^2 - m_{\chi_d}^2) \left[\sin^2 \theta \int \frac{d^4 k}{(2\pi)^4} \frac{\hat{k} + \hat{p}}{(k^2 - m_{W_R}^2)(k^2 - m_{\chi_d}^2)(k+p)^2} \right. \\
&\quad \left. + \cos^2 \theta \int \frac{d^4 k}{(2\pi)^4} \frac{\hat{k} + \hat{p}}{(k^2 - m_{W_R}^2)(k^2 - m_{\chi_d}^2)[(k+p)^2 - m_s^2]} \right]. \quad (89)
\end{aligned}$$

It is clear by inspection that these graphs produce high mass scale threshold corrections, and that they are not enhanced by m_t .

A.7 Graphs in Figure 7

All of the graphs in Fig.7 arise from mixing between the bosons of the heavy sector with those of the light sector. They are all individually finite. A general argument shows that they cannot contribute unsuppressed large logarithmic terms because they are proportional to mixing angles between the heavy and light sectors.

Consider, for instance, a general Yukawa interaction of the form

$$\mathcal{L} = \lambda_1 \bar{F} f S_1 + \lambda_2 \bar{f} F S_2 + \text{H.c.} \quad (90)$$

If the scalar bosons S_1 and S_2 do not mix, then they each contribute separately to fermion self-energies via the individually divergent diagrams I have been considering. However, if they mix with a mixing angle ζ , then

$$\mathcal{L} = \lambda_1 \bar{F} f (\cos \zeta S'_1 + \sin \zeta S'_2) + \lambda_2 \bar{f} F (-\sin \zeta S'_1 + \cos \zeta S_2) + \text{H.c.} \quad (91)$$

where the primed fields denote the new mass eigenstates. This gives rise to a new contribution proportional to the mixing parameters.⁶ For instance, the self-energy of f receives an additional finite contribution given by

$$\begin{aligned}
-i\Sigma_f &= -\lambda_1 \lambda_2 \sin \zeta \cos \zeta \int \frac{d^4 k}{(2\pi)^4} \left(\frac{1}{k^2 - m_1^2} - \frac{1}{k^2 - m_2^2} \right) \frac{\hat{k} + \hat{p} + m_F}{(k+p)^2 - m_F^2} \\
&= -\lambda_1 \lambda_2 \sin \zeta \cos \zeta (m_1^2 - m_2^2) \times \\
&\quad \times \int \frac{d^4 k}{(2\pi)^4} \frac{\hat{k} + \hat{p} + m_F}{(k^2 - m_1^2)(k^2 - m_2^2)[(k+p)^2 - m_F^2]} \quad (92)
\end{aligned}$$

⁶Note that when mixing is considered the graphs I have already calculated which do not require mixing to exist will be multiplied by $\cos^2 \zeta \simeq 1$ factors.

where $m_{1,2}$ is the mass of $S'_{1,2}$, and m_F is the mass of F . Suppose the heavy scalar to be S'_2 . In the limit that $m_2 \rightarrow \infty$,

$$-i\Sigma_f \rightarrow -\lambda_1\lambda_2 \sin \zeta \cos \zeta \int \frac{d^4k}{(2\pi)^4} \frac{\hat{k} + \hat{p} + m_F}{(k^2 - m_1^2)[(k+p)^2 - m_F^2]}. \quad (93)$$

The integral above is logarithmically divergent and thus there will be a large logarithm in the heavy mass m_2 . However, the self-energy is also proportional to $\sin \zeta \cos \zeta$, which goes to zero as the heavy scale is taken to infinity. Generically, mixing angles between heavy and light scalars go as at most $m_{\text{light}}/m_{\text{heavy}}$ as the heavy mass goes to infinity. Therefore the large logarithm above will always be suppressed by m_1/m_2 and thus it will be ineffective.

Note that the statement that the mixing angle will generically go as $m_{\text{light}}/m_{\text{heavy}}$ is not the same as the statement that we always want one light eigenstate and one heavy eigenstate. For instance, a “democratic” 2×2 mass matrix (which has each entry as 1) will yield one zero and one nonzero eigenvalue but with a mixing angle of $\pi/4$. However, in this case there is no clear separation of the unmixed fields into a heavy and a light sector. One must make sure that the model does not produce this type of situation. This means that a scalar mass hierarchy must be put into the theory by hand and then preserved to all orders of perturbation theory (at least). This is of course just a manifestation of the gauge hierarchy problem for scalar bosons.

The argument above may be easily repeated for graphs dependent on gauge boson mixing instead of scalar boson mixing.

References

- [1] This group theoretic idea was noted in a slightly different context long ago. See S. Weinberg, Phys. Rev. Lett. **29**, 388 (1972).
- [2] J. C. Pati and A. Salam, Phys. Rev. **D8**, 1240 (1973); *ibid.* **D10**, 275 (1974).
- [3] R. Foot and H. Lew, Phys. Rev. **D41**, 3052 (1990); R. Foot, H. Lew and R. R. Volkas, *ibid.* **D44**, 1531 (1991); R. R. Volkas, *ibid.* **D50**, 4625 (1994).
- [4] G. Valencia and S. Willenbrock, Phys. Rev. **D50**, 6845 (1994).
- [5] See, for instance, R. N. Mohapatra, *Unification and Supersymmetry*, (Springer-Verlag, New York, 1986).
- [6] D. Chang, R. N. Mohapatra and M. K. Parida, Phys. Rev. Lett. **52**, 1072 (1984).
- [7] T. Yanagida, in *Proceedings of the Workshop on Unified Theory and Baryon Number of the Universe*, edited by O. Sawada and A. Sugamoto (KEK, Tsukuba, Japan, 1979); M. Gell-Mann, P. Ramond and R. Slansky, in *Supergravity*, edited by P. Van Nieuwenhuizen and D. Freedman (North-Holland, Amsterdam, 1980); R. N. Mohapatra and G. Senjanovic, Phys. Rev. Lett. **44**, 912 (1980).
- [8] See, for instance, p. 239 of E. W. Kolb and M. S. Turner, *The Early Universe*, (Addison-Wesley, Redwood City, 1990).
- [9] H. Arason et al., Phys. Rev. **D46**, 3945 (1992).
- [10] See, for instance, K. S. Babu, K. Fujikawa and A. Yamada, Phys. Lett. **B333**, 196 (1994).
- [11] See D. Chang, R. N. Mohapatra, P. B. Pal and J. C. Pati, Phys. Rev. Lett. **55**, 2756 (1985) for a discussion of such a possibility when the top quark was thought to be much lighter.
- [12] E. Ma, Phys. Rev. **D36**, 271 (1987); K. S. Babu, X.-G. He and E. Ma, *ibid.* **D36**, 878 (1987).
- [13] H. Georgi and C. Jarlskog, Phys. Lett. **B86**, 297 (1979).
- [14] M. Worah, Enrico Fermi Institute report EFI-95-04 (unpublished), hep-ph/9502222.

Figure Captions

Figure 1: Feynman graphs contributing to $m_\tau - m_b$ which involve the photon γ , the Z , Z' and X bosons and the gluons G . The logarithmic divergences of the individual self energies cancel in $m_\tau - m_b$ between these graphs. The external fermion line is either τ or b for the γ , Z , Z' and X graphs, while the external fermion for the gluon graph is b only. The internal fermion for the γ , Z and Z' graphs is the same as the external fermion. For the X graph, the internal fermion is a $\tau(b)$ if the external fermion is a $b(\tau)$. The internal fermion for the gluon graph is a b . In section A.1 of the Appendix, I calculate $m_\tau - m_b$ under the approximation that $m_Z = 0$. This allows a change from the (γ, Z) basis to the (W^0, B) basis. The W^0 boson graph does not contribute to $m_\tau - m_b$ because W^0 couples universally to b and τ . In the text I therefore actually calculate the four diagrams involving a massless B boson, the Z' and X bosons, and the gluons.

Figure 2: Feynman graphs involving the physical charged Higgs boson H^- . The individual divergences cancel in $m_\tau - m_b$ between these graphs.

Figure 3: Feynman graphs involving the unphysical charged Goldstone boson g^- . The individual divergences cancel in $m_\tau - m_b$ between these graphs.

Figure 4: Feynman graphs involving the left-sector gauge boson W_L^- . The individual divergences cancel in $m_\tau - m_b$ between these graphs.

Figure 5: Feynman graphs involving the right-sector gauge boson W_R^- . The divergences cancel in $m_\tau - m_b$ between these two graphs.

Figure 6: Feynman graphs involving components of χ . The divergences cancel in $m_\tau - m_b$ between these two graphs.

Figure 7: The first two Feynman graphs contribute to $m_\tau - m_b$ when $W_L^- - W_R^-$ mixing is switched on. The third graph contributes when $Z - Z'$ mixing is included. The fourth graph denotes the fact that the Goldstone bosons eaten by W_R^- and W_L^- are actually linear combinations of χ^- and g^- .

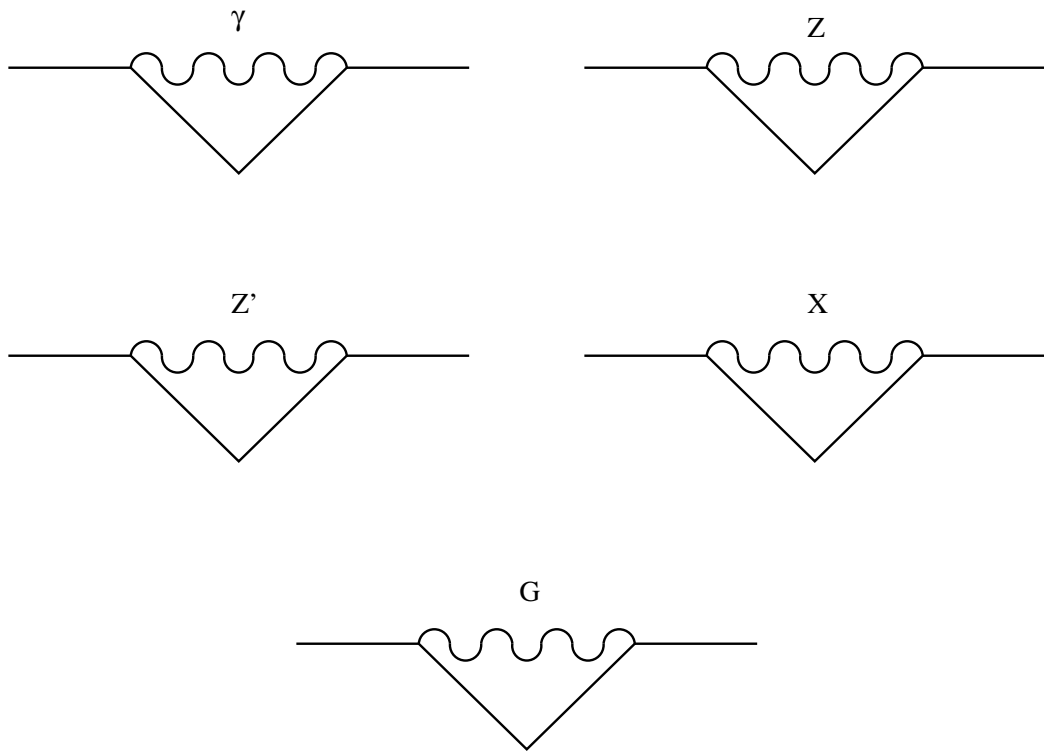

FIGURE 1

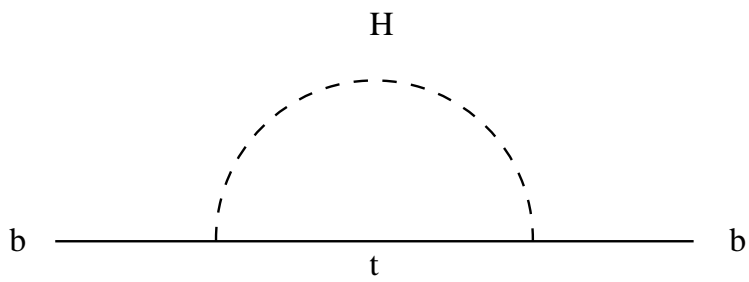
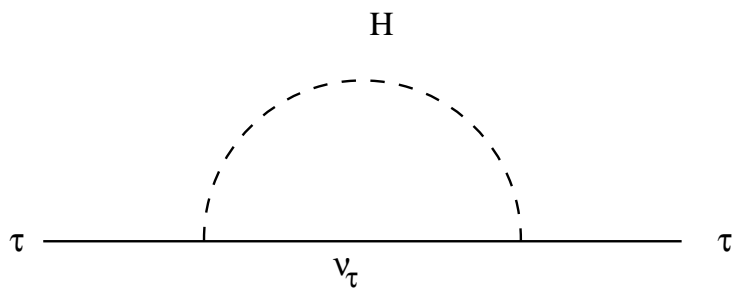
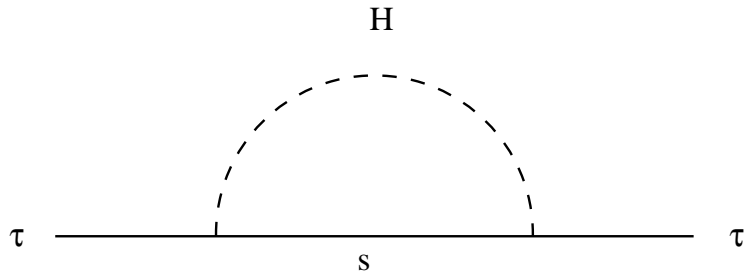

FIGURE 2

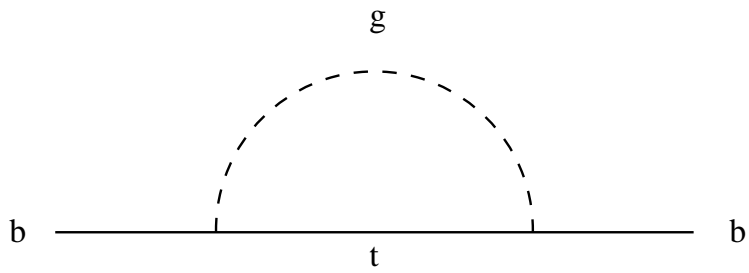
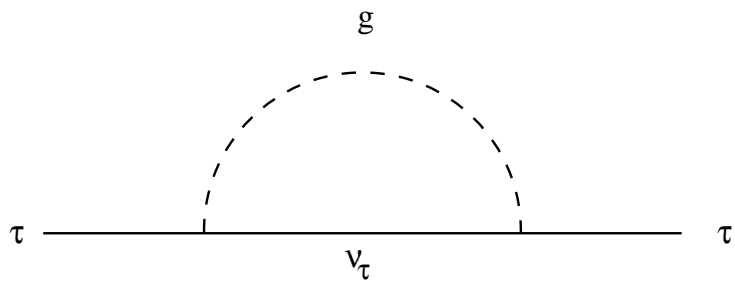
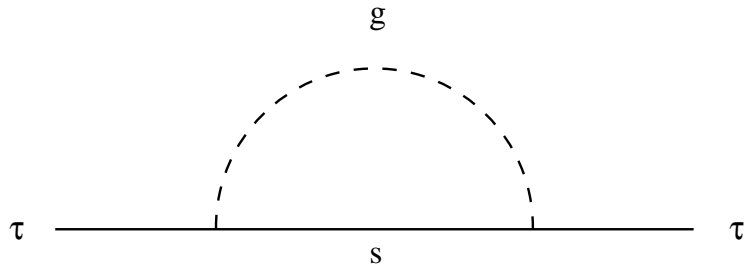

FIGURE 3

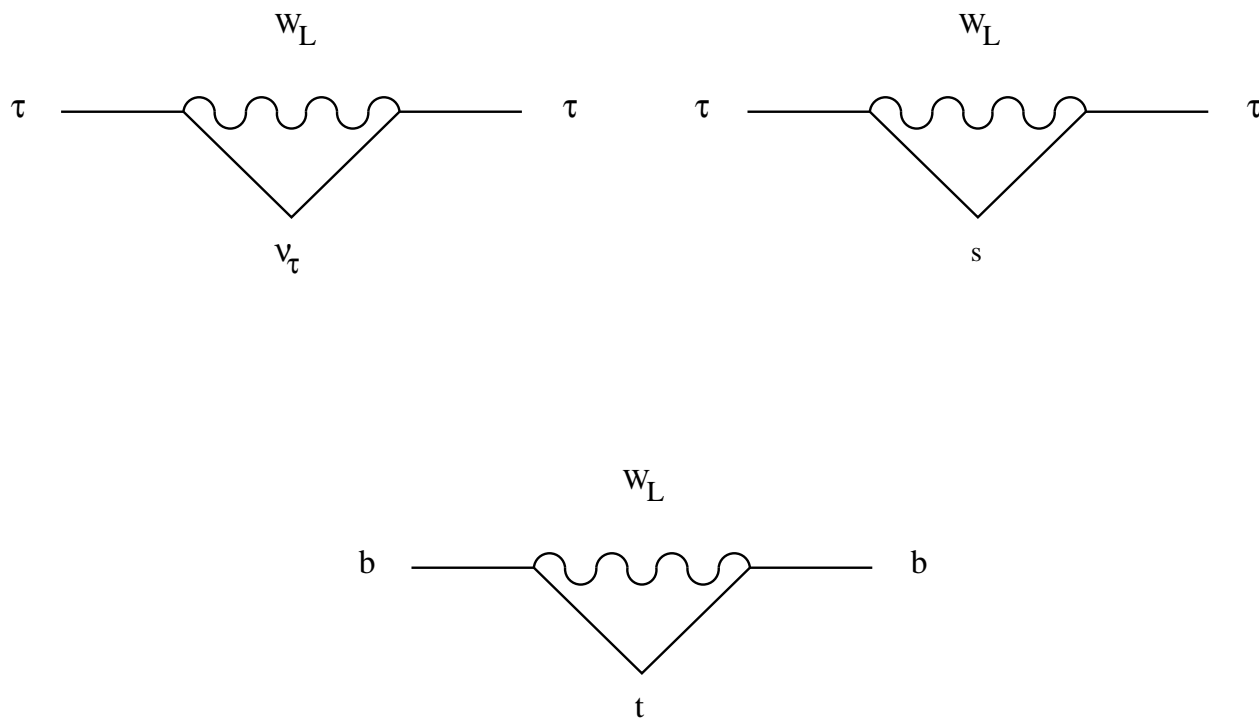

FIGURE 4

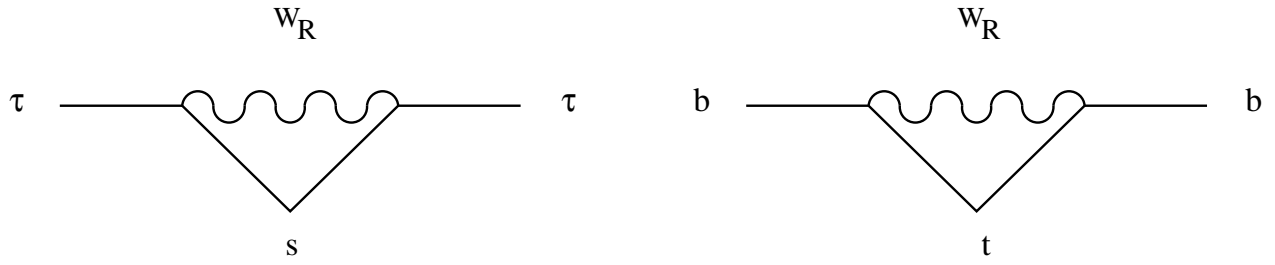

FIGURE 5

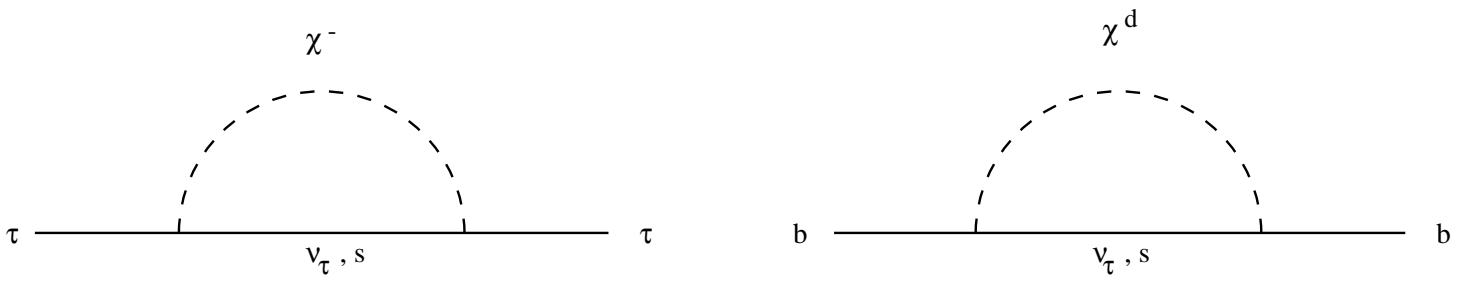

FIGURE 6

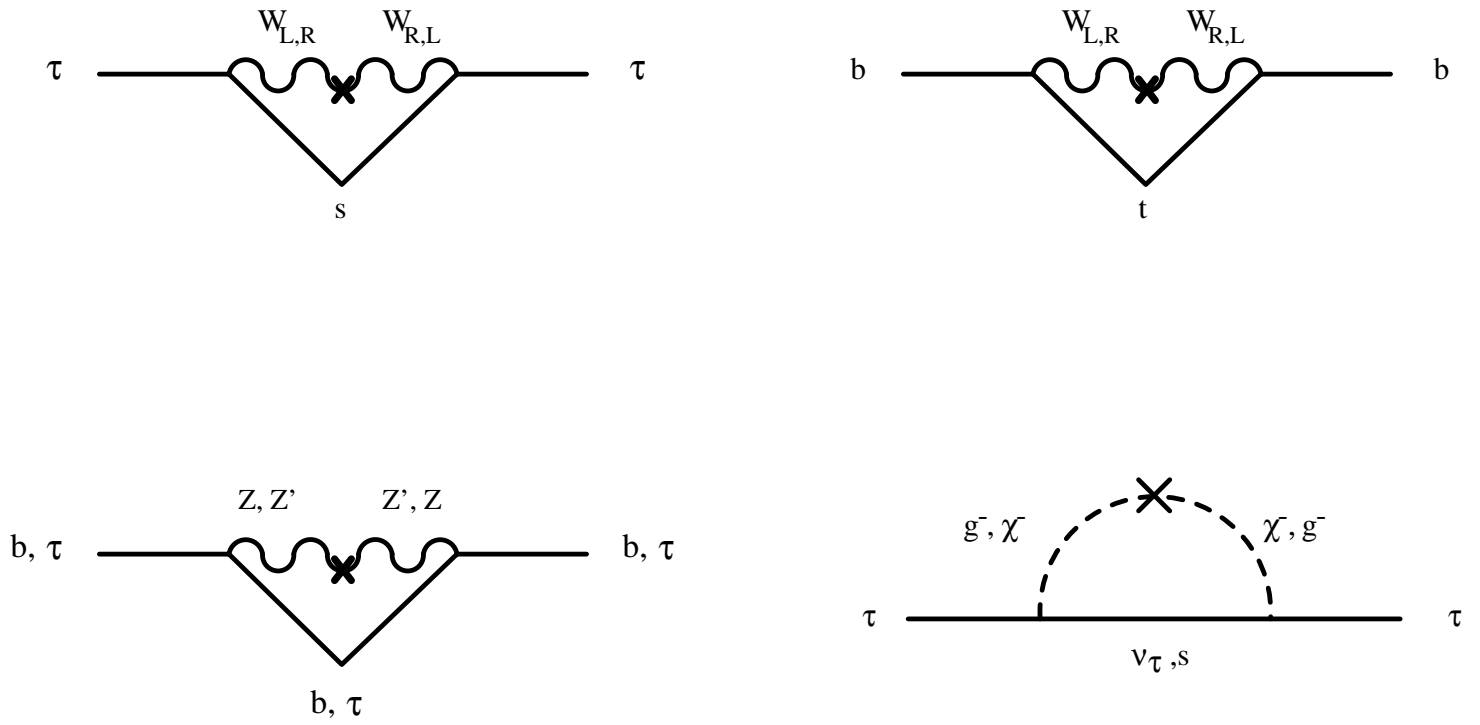

FIGURE 7