

BARYOGENESIS

James M. Cline

McGill University, Dept. of Physics, Montreal, Qc H3A 2T8, Canada

Photo: width 7.5cm height 11cm

Contents

1. Observational evidence for the BAU	5
2. Sakharov's Conditions for Baryogenesis	9
2.1. B violation	10
2.2. Loss of thermal equilibrium	11
2.3. C, CP violation	11
2.4. Examples of CP violation	13
2.5. More history	17
3. Example: GUT baryogenesis	17
3.1. Washout Processes	22
4. B and CP violation in the Standard Model	24
4.1. CP violation in the SM	28
5. Electroweak Phase Transition and Electroweak Baryogenesis	30
5.1. Strength of the phase transition	34
5.2. EWPT in the MSSM	39
6. A model of Electroweak Baryogenesis: 2HDM	42
6.1. EDM constraints	51
7. EWBG in the MSSM	53
8. Other mechanisms; Leptogenesis	56
References	60

1. Observational evidence for the BAU

In everyday life it is obvious that there is more matter than antimatter. In nature we see antimatter mainly in cosmic rays, *e.g.*, \bar{p} , whose flux expressed as a ratio to that of protons, is

$$\frac{\bar{p}}{p} \sim 10^{-4} \quad (1.1)$$

consistent with no ambient \bar{p} 's, only \bar{p} 's produced through high energy collisions with ordinary matter. On earth, we need to work very hard to produce and keep e^+ (as in the former LEP experiment) or \bar{p} (as at the Tevatron).

We can characterize the asymmetry between matter and antimatter in terms of the baryon-to-photon ratio

$$\eta \equiv \frac{n_B - n_{\bar{B}}}{n_\gamma} \quad (1.2)$$

where

$$\begin{aligned} n_B &= \text{number density of baryons} \\ n_{\bar{B}} &= \text{number density of antibaryons} \\ n_\gamma &= \text{number density of photons} \\ &\equiv \frac{\zeta(3)}{\pi^2} g_* T^3, \quad g_* = 2 \text{ spin polarizations} \end{aligned} \quad (1.3)$$

and $\zeta(3) = 1.20206 \dots$. This is a useful measure because it remains constant with the expansion of the universe, at least at late times. But at early times, and high temperatures, many heavy particles were in thermal equilibrium, which later annihilated to produce more photons but not baryons. In this case, the entropy density s is a better quantity to compare the baryon density to, and it is convenient to consider

$$\frac{n_B - n_{\bar{B}}}{s} = \frac{1}{7.04} \eta \quad (1.4)$$

where the conversion factor $1/7$ is valid in the present universe, since the epoch when neutrinos went out of equilibrium and positrons annihilated.

Historically, η was determined using big bang nucleosynthesis. Abundances of ^3He , ^4He , D , ^6Li and ^7Li are sensitive to the value of η ; see the Particle Data Group [1] for a review. The theoretical predictions and experimental measurements are summarized in figure 1, similar to a figure in [2]. The boxes represent the regions which are consistent with experimental determinations, showing that different measurements obtain somewhat different values. The smallest error bars are for the deuterium (D/H) abundance, giving

$$\eta = 10^{-10} \times \begin{cases} 6.28 \pm 0.35 \\ 5.92 \pm 0.56 \end{cases} \quad (1.5)$$

for the two experimental determinations which are used. These values are consistent with the ^4He abundance, though marginally inconsistent with ^7Li (the ‘‘Lithium problem’’).

In the last few years, the Cosmic Microwave Background has given us an independent way of measuring the baryon asymmetry [3]. The relative sizes of the Doppler peaks of the temperature anisotropy are sensitive to η , as illustrated in fig. 2. The Wilkinson Microwave Anisotropy Probe first-year data fixed the combination $\Omega_b h^2 = 0.0224 \pm 0.0009$, corresponding to [2]

$$\eta = (6.14 \pm 0.25) \times 10^{-10} \quad (1.6)$$

which is more accurate than the BBN determination. Apart from the Lithium problem, this value is seen to be in good agreement with the BBN value. The CMB-allowed range is shown as the vertical band in figure 1.

We can thus be confident in our knowledge of the baryon asymmetry. The question is, why is it not zero? This would be a quite natural value; a priori, one might expect the big bang—or in our more modern understanding, reheating following inflation—to produce equal numbers of particles and antiparticles.

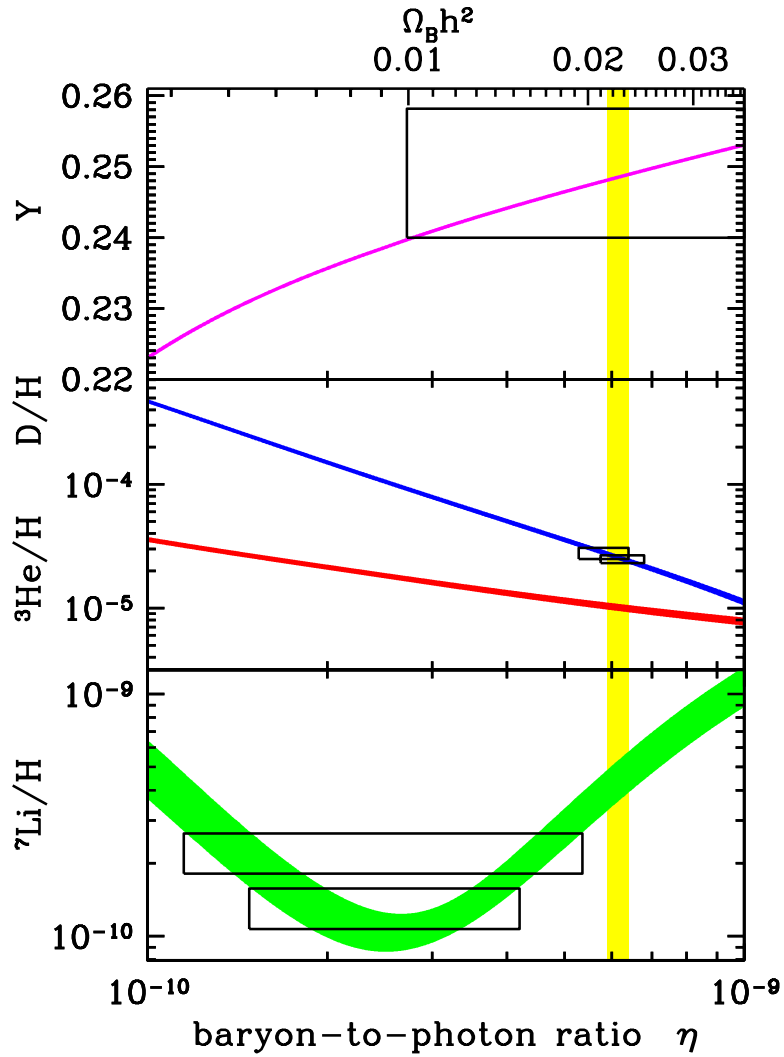

Fig. 1. Primordial abundances versus η , courtesy of R. Cyburt

One might wonder whether the universe could be baryon-symmetric on very large scales, and separated into regions which are either dominated by baryons or antibaryons. However we know that even in the least dense regions of the universe there are hydrogen gas clouds, so one would expect to see an excess of gamma rays in the regions between baryon and antibaryon dominated regions, due to annihilations. These are not seen, indicating that such patches should be

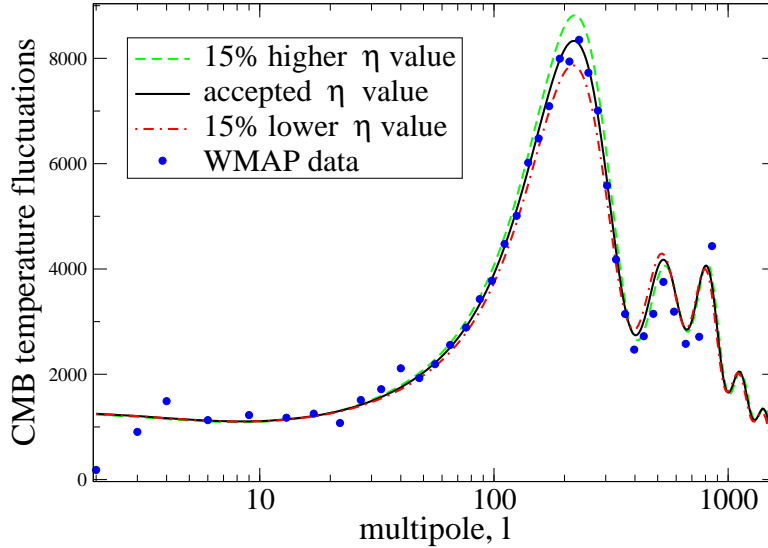

Fig. 2. Dependence of the CMB Doppler peaks on η .

as large as the presently observable universe. There seems to be no plausible way of separating baryons and antibaryons from each other on such large scales.

It is interesting to note that in a homogeneous, baryon-symmetric universe, there would still be a few baryons and antibaryons left since annihilations aren't perfectly efficient. But the freeze-out abundance is

$$\frac{n_B}{n_\gamma} = \frac{n_{\bar{B}}}{n_\gamma} \approx 10^{-20} \quad (1.7)$$

(see ref. [4], p. 159), which is far too small for the BBN or CMB.

In the early days of big bang cosmology, the baryon asymmetry was considered to be an initial condition, but in the context of inflation this idea is no longer tenable. Any baryon asymmetry existing before inflation would be diluted to a negligible value during inflation, due to the production of entropy during reheating.

It is impressive that A. Sakharov realized the need for dynamically creating the baryon asymmetry in 1967 [5], more than a decade before inflation was invented. The idea was not initially taken seriously; in fact it was not referenced again, with respect to the idea of baryogenesis, until 1979 [6]. Now it has 1040 citations (encouragement to those of us who are still waiting for our most interesting papers to be noticed!). It was only with the advent of grand unified theories,

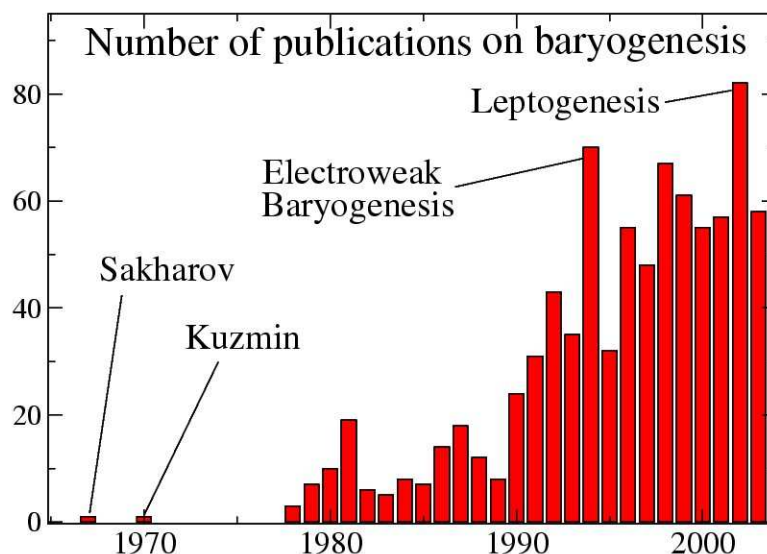

Fig. 3. Number of publications on baryogenesis as a function of time.

which contained the necessary ingredients for baryogenesis, that interest in the subject started to grow dramatically. I have documented the rate of activity in the field from 1967 until now in figure 3.

2. Sakharov's Conditions for Baryogenesis

It is traditional to start any discussion of baryogenesis with the list of three necessary ingredients needed to create a baryon asymmetry where none previously existed:

1. B violation
2. Loss of thermal equilibrium
3. C, CP violation

Although these principles have come to be attributed to Sakharov, he did not enunciate them as clearly in his three-page paper as one might have been led to think, especially the second point. (Sakharov describes a scenario where a universe which was initially contracting and with equal and opposite baryon asymmetry to that existing today goes through a bounce at the singularity and reverses

the magnitude of its baryon asymmetry.) It is easy to see why these conditions are necessary. The need for B (baryon) violation is obvious. Let's consider some examples of B violation.

2.1. B violation

In the standard model, B is violated by the triangle anomaly, which spoils conservation of the left-handed baryon + lepton current,

$$\partial_\mu J_{B_L+L_L}^\mu = \frac{3g^2}{32\pi^2} \epsilon_{\alpha\beta\gamma\delta} W_a^{\alpha\beta} W_a^{\gamma\delta} \quad (2.1)$$

where $W_a^{\alpha\beta}$ is the SU(2) field strength. As we will discuss in more detail in section 4, this leads to the nonperturbative sphaleron process pictured in fig. 4. It involves 9 left-handed (SU(2) doublet) quarks, 3 from each generation, and 3 left-handed leptons, one from each generation. It violates B and L by 3 units each,

$$\Delta B = \Delta L = \pm 3 \quad (2.2)$$

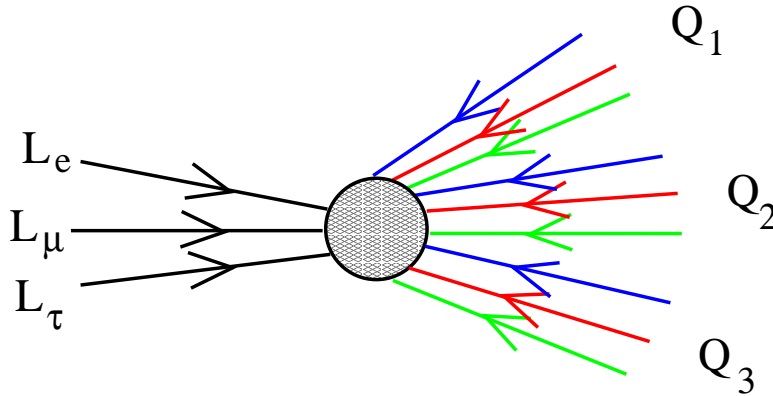

Fig. 4. The sphaleron.

In grand unified theories, like SU(5), there are heavy gauge bosons X^μ and heavy Higgs bosons Y with couplings to quarks and leptons of the form

$$Xqq, \quad X\bar{q}\bar{l} \quad (2.3)$$

and similarly for Y . The simultaneous existence of these two interactions imply that there is no consistent assignment of baryon number to X^μ . Hence B is violated.

In supersymmetric models, one might choose not to impose R-parity. Then one can introduce dimension-4 B-violating operators, like

$$\tilde{t}_R^a b_R^b s_R^c \epsilon_{abc} \quad (2.4)$$

which couple the right-handed top squark to right-handed quarks. One usually imposes R-parity to forbid proton decay, but the interaction (2.4) could be tolerated if for some reason lepton number was still conserved, since then the decay channels $p \rightarrow \pi^+ \nu$ and $p \rightarrow \pi^0 e^+$ would be blocked.

2.2. Loss of thermal equilibrium

The second condition of Sakharov (as I am numbering them), loss of thermal equilibrium, is also easy to understand. Consider a hypothetical process

$$X \rightarrow Y + B \quad (2.5)$$

where X represents some initial state with vanishing baryon number, Y is a final state, also with $B = 0$, and B represents the excess baryons produced. If this process is in thermal equilibrium, then by definition the rate for the inverse process, $Y + B \rightarrow X$, is equal to the rate for (2.5):

$$\Gamma(Y + B \rightarrow X) = \Gamma(X \rightarrow Y + B) \quad (2.6)$$

No net baryon asymmetry can be produced since the inverse process destroys B as fast as (2.5) creates it.

The classic example is out-of-equilibrium decays, where X is a heavy particle, such that $M_X > T$ at the time of decay, $\tau = 1/\Gamma$. In this case, the energy of the final state $Y + B$ is of order T , and there is no phase space for the inverse decay: $Y + B$ does not have enough energy to create a heavy X boson. The rate for $Y + B \rightarrow X$ is Boltzmann-suppressed, $\Gamma(Y + B \rightarrow X) \sim e^{-M_X/T}$.

2.3. C, CP violation

The most subtle of Sakharov's requirements is C and CP violation. Consider again some process $X \rightarrow Y + B$, and suppose that C (charge conjugation) is a symmetry. Then the rate for the C-conjugate process, $\bar{X} \rightarrow \bar{Y} + \bar{B}$, is the same:

$$\Gamma(\bar{X} \rightarrow \bar{Y} + \bar{B}) = \Gamma(X \rightarrow Y + B) \quad (2.7)$$

The net rate of baryon production goes like the difference of these rates,

$$\frac{dB}{dt} \propto \Gamma(\bar{X} \rightarrow \bar{Y} + \bar{B}) - \Gamma(X \rightarrow Y + B) \quad (2.8)$$

and so vanishes in the case where C is a symmetry.

However, even if C is violated, this is not enough. We also need CP violation. To see this, consider an example where X decays into two left-handed or two right-handed quarks,

$$X \rightarrow q_L q_L, \quad X \rightarrow q_R q_R \quad (2.9)$$

Under CP,

$$CP : \quad q_L \rightarrow \bar{q}_R \quad (2.10)$$

where \bar{q}_R is the antiparticle of q_R , which is *left*-handed (in my notation, L and R are really keeping track of whether the fermion is an SU(2) doublet or singlet), whereas under C,

$$C : \quad q_L \rightarrow \bar{q}_L \quad (2.11)$$

Therefore, even though C violation implies that

$$\Gamma(X \rightarrow q_L q_L) \neq \Gamma(\bar{X} \rightarrow \bar{q}_L \bar{q}_L) \quad (2.12)$$

CP conservation would imply

$$\Gamma(X \rightarrow q_L q_L) = \Gamma(\bar{X} \rightarrow \bar{q}_R \bar{q}_R) \quad (2.13)$$

and also

$$\Gamma(X \rightarrow q_R q_R) = \Gamma(\bar{X} \rightarrow \bar{q}_L \bar{q}_L) \quad (2.14)$$

Then we would have

$$\Gamma(X \rightarrow q_L q_L) + \Gamma(X \rightarrow q_R q_R) = \Gamma(\bar{X} \rightarrow \bar{q}_R \bar{q}_R) + \Gamma(\bar{X} \rightarrow \bar{q}_L \bar{q}_L) \quad (2.15)$$

As long as the initial state has equal numbers of X and \bar{X} , we end up with no net asymmetry in quarks. The best we can get is an asymmetry between left- and right-handed quarks, but this is not a baryon asymmetry.

Let us recall exactly how C, P and CP operate on scalar fields, spinors, and vector fields. For complex scalars,

$$\begin{aligned} C : \quad & \phi \rightarrow \phi^* \\ P : \quad & \phi(t, \vec{x}) \rightarrow \pm \phi(t, -\vec{x}) \\ CP : \quad & \phi(t, \vec{x}) \rightarrow \pm \phi^*(t, -\vec{x}) \end{aligned} \quad (2.16)$$

For fermions,

$$\begin{aligned} C : \quad & \psi_L \rightarrow i\sigma_2 \psi_R^*, \quad \psi_R \rightarrow -i\sigma_2 \psi_L^*, \quad \psi \rightarrow i\gamma^2 \psi^* \\ P : \quad & \psi_L \rightarrow \psi_R(t, -\vec{x}), \quad \psi_R \rightarrow \psi_L(t, -\vec{x}), \quad \psi \rightarrow \gamma^0 \psi(t, -\vec{x}) \\ CP : \quad & \psi_L \rightarrow i\sigma_2 \psi_R^*(t, -\vec{x}), \quad \psi_R \rightarrow -i\sigma_2 \psi_L^*(t, -\vec{x}), \quad \psi \rightarrow i\gamma^2 \psi^*(t, -\vec{x}) \end{aligned} \quad (2.17)$$

For vectors,

$$\begin{aligned}
 C : \quad & A^\mu \rightarrow -A^\mu \\
 P : \quad & A^\mu(t, \vec{x}) \rightarrow (A^0, -\vec{A})(t, -\vec{x}) \\
 CP : \quad & A^\mu(t, \vec{x}) \rightarrow (-A^0, \vec{A})(t, -\vec{x})
 \end{aligned}
 \tag{2.18}$$

To test your alertness, it is amusing to consider the following puzzle. Going back to the example of $X \rightarrow qq$, let us suppose that C and CP are both violated and that

$$\Gamma(X \rightarrow qq) \neq \Gamma(\bar{X} \rightarrow \bar{q}\bar{q}) \tag{2.19}$$

where now we ignore the distinction between q_R and q_L . An astute reader might object that if all X 's decay into qq and all \bar{X} 's decay into $\bar{q}\bar{q}$, with $n_X = n_{\bar{X}}$ initially, then eventually we will still have equal numbers of q and \bar{q} , even though there was temporarily an excess. To avoid this outcome, there must exist at least one competing channel, $X \rightarrow Y$, $\bar{X} \rightarrow \bar{Y}$, such that

$$\Gamma(X \rightarrow Y) \neq \Gamma(\bar{X} \rightarrow \bar{Y}) \tag{2.20}$$

and with the property that Y has a different baryon number than qq . One can then see that a baryon asymmetry will develop by the time all X 's have decayed. Why is it then, that we do not have an additional fourth requirement, that a competing decay channel with the right properties exists? The reason is that this is guaranteed by the CPT theorem, combined with the requirement of B violation. CPT assures us that the total rates of decay for X and \bar{X} are equal, which in the present example means

$$\Gamma(X \rightarrow qq) + \Gamma(X \rightarrow Y) = \Gamma(\bar{X} \rightarrow \bar{q}\bar{q}) + \Gamma(\bar{X} \rightarrow \bar{Y}) \tag{2.21}$$

The stipulation that B is violated tells us that Y has different baryon number than qq . Otherwise we could consistently assign the baryon number $2/3$ to X and there would be no B violation.

2.4. Examples of CP violation

We now consider the conditions under which a theory has CP violation. Generally CP violation exists if there are complex phases in couplings in the Lagrangian which can't be removed by field redefinitions. Let's start with scalar theories. For example

$$\begin{aligned}
 \mathcal{L} &= |\partial\phi|^2 - m^2|\phi|^2 - \lambda|\phi|^4 \\
 &- (\mu^2\phi^2 + g\phi^4 + \text{h.c.})
 \end{aligned}
 \tag{2.22}$$

where the top line is CP conserving, and the bottom line is (potentially) CP-violating. This can be seen by applying the CP transformation $\phi \rightarrow \phi^*$ and observing that the bottom line is not invariant:

$$\mathcal{L}_{CPV} \rightarrow -(\mu^2 \phi^{*2} + g \phi^{*4} + \text{h.c.}) \quad (2.23)$$

Of course, this lack of invariance only occurs if μ^2 and g are not both real. Parametrize

$$\mu^2 = |\mu|^2 e^{i\phi_\mu}, \quad g = |g| e^{i\phi_g} \quad (2.24)$$

We can perform a field redefinition to get rid of one of these phases, *e.g.* ϕ_μ , by letting

$$\phi \rightarrow e^{-i\phi_\mu/2} \phi \quad (2.25)$$

so that

$$\mathcal{L}_{CPV} = -(|\mu|^2 |\phi|^2 + |g| e^{i(\phi_g - 2\phi_\mu)} \phi^4 + \text{h.c.}) \quad (2.26)$$

Now under CP, only the ϕ^4 term changes. We can see that it is only the combination

$$\phi_{\text{inv}} = \phi_g - 2\phi_\mu = \text{"invariant phase"} \quad (2.27)$$

which violates CP, and which is independent of field redefinitions. If $\phi_{\text{inv}} = 0$, the theory is CP-conserving. We can also write

$$\phi_{\text{inv}} = \arg \left(\frac{g}{\mu^4} \right) \quad (2.28)$$

No physical result can depend on field redefinitions, since these are arbitrary. Therefore any physical effect of CP violation must manifest itself through the combination ϕ_{inv} . This can sometimes provide a valuable check on calculations.

An equivalent way of thinking about the freedom to do field redefinitions is the following. One can also define the CP transformation with a phase $\phi \rightarrow e^{i\alpha} \phi^*$. As long as there exists any value of α for which this transformation is a symmetry, we can say that this is the real CP transformation, and CP is conserved.

Next let's consider an example with fermions. We can put a complex phase into the mass of a fermion (here we consider Dirac),

$$\begin{aligned} \mathcal{L} &= \bar{\psi} (i\partial - m(\cos\theta + i\sin\theta\gamma_5)) \psi \\ &= \bar{\psi} (i\partial - m e^{i\theta\gamma_5}) \psi \end{aligned} \quad (2.29)$$

[In Weyl components, the mass term has the form $m(\bar{\psi}_L e^{i\theta} \psi_R + \bar{\psi}_R e^{-i\theta} \psi_L)$.] Under CP,

$$\begin{aligned}\psi &\rightarrow i\gamma^2\gamma^0\psi^*, & \psi^* &\rightarrow -i(-\gamma^2)\gamma^0\psi, \\ \psi^\dagger &\rightarrow \psi^T\gamma^0(-\gamma^2)(-i), \\ \psi^T &\rightarrow \psi^\dagger\gamma^0\gamma^2i = \bar{\psi}\gamma^2i\end{aligned}\quad (2.30)$$

Also, by transposing the fields, $\bar{\psi}e^{i\theta\gamma_5}\psi = -\psi^T e^{i\theta\gamma_5}\gamma^0\psi^*$. Putting these results together, we find that the complex mass term transforms under CP as

$$\begin{aligned}\bar{\psi}e^{i\theta\gamma_5}\psi &\rightarrow -\bar{\psi}\gamma^2ie^{i\theta\gamma_5}\gamma^0i\gamma^2\gamma^0\psi \\ &= -\bar{\psi}\gamma^2e^{i\theta\gamma_5}\gamma^2\psi \\ &= \bar{\psi}e^{-i\theta\gamma_5}\psi\end{aligned}\quad (2.31)$$

So ostensibly θ is CP-violating. However, we can remove this phase using the chiral field redefinition

$$\psi \rightarrow e^{-i(\theta/2)\gamma_5}\psi \quad (2.32)$$

To get an unremovable phase, we need to consider a more complicated theory. For example, with two Dirac fermions we can have

$$\mathcal{L} = \sum_{i=1}^2 \bar{\psi}_i(i\partial - m_i e^{i\theta_i\gamma_5})\psi_i + \mu(\bar{\psi}_1 e^{i\alpha\gamma_5}\psi_2 + \text{h.c.}) \quad (2.33)$$

After field redefinitions we find that

$$\mathcal{L} \rightarrow \sum_{i=1}^2 \bar{\psi}_i(i\partial - m_i)\psi_i + \mu(\bar{\psi}_1 e^{i(\alpha - \theta_1/2 - \theta_2/2)\gamma_5}\psi_2 + \text{h.c.}) \quad (2.34)$$

so the invariant phase is $\alpha - \frac{1}{2}(\theta_1 + \theta_2)$.

It is also useful to think about this example in terms of 2-component Weyl spinors, where the mass term takes the form

$$\sum_{i=1}^2 \psi_{L,i}^\dagger e^{i\theta_i} \psi_{R,i} + \mu \psi_{L,1}^\dagger e^{i\alpha} \psi_{R,2} + \text{h.c.} \quad (2.35)$$

One might have thought that there are 4 field redefinitions, corresponding to independent rephasings of $\psi_{L,i}$ and $\psi_{R,i}$, so there would be enough freedom to remove all the phases. However, it is only the axial vector transformations, where L and R components are rotated by equal and opposite phases, that can be used to remove θ_i . Half of the available field redefinitions are useless as far as removing phases from the mass terms. We might more accurately state the general

rule as “the number of invariant phases equals the total number of phases in the Lagrangian parameters, minus the number of *relevant* field redefinitions which can be done.”

A third example of CP violation is the famous θ term in QCD,

$$\theta_{QCD} F_{\mu\nu}^a \tilde{F}^{a,\mu\nu} = \frac{1}{2} \theta_{QCD} \epsilon^{\mu\nu\alpha\beta} F_{\mu\nu}^a F_{\alpha\beta}^a = -2\theta_{QCD} \vec{E}^a \cdot \vec{B}^a \quad (2.36)$$

This combination is P-odd and C-even, thus odd under CP. Its smallness is the strong CP problem of QCD: if $\theta_{QCD} \gtrsim 10^{-10}$, the electric dipole moment of the neutron would exceed experimental limits. The EDM operator is

$$\begin{aligned} \text{EDM} = -\frac{i}{2} d_n \bar{n} \sigma_{\mu\nu} \gamma_5 F^{\mu\nu} n &= d_n \left(n_L^\dagger \vec{\sigma} \cdot \vec{E} n_R + n_R^\dagger \vec{\sigma} \cdot \vec{E} n_L \right. \\ &\quad \left. + i(n_L^\dagger \vec{\sigma} \cdot \vec{B} n_R - n_R^\dagger \vec{\sigma} \cdot \vec{B} n_L) \right) \end{aligned} \quad (2.37)$$

which is mostly $\vec{\sigma} \cdot \vec{E}$, since there is a cancellation between left and right components in the bottom line. Contrast this with the magnetic dipole moment operator,

$$\begin{aligned} \text{MDM} = \frac{1}{2} \mu_n \bar{n} \sigma_{\mu\nu} F^{\mu\nu} n &= \mu_n \left(n_L^\dagger \vec{\sigma} \cdot \vec{B} n_R + n_R^\dagger \vec{\sigma} \cdot \vec{B} n_L \right. \\ &\quad \left. + i(n_L^\dagger \vec{\sigma} \cdot \vec{E} n_R - n_R^\dagger \vec{\sigma} \cdot \vec{E} n_L) \right) \end{aligned} \quad (2.38)$$

which is mostly $\vec{\sigma} \cdot \vec{B}$. To verify the CP properties of these operators, notice that under CP, $\vec{\sigma} \rightarrow \vec{\sigma}$, $L \leftrightarrow R$, $\vec{E} \rightarrow -\vec{E}$, $\vec{B} \rightarrow \vec{B}$. EDM's will play an important role in constraining models of baryogenesis, since the phases needed for one can also appear in the other. The current limit on the neutron EDM is [7]

$$|d_n| < 3 \times 10^{-26} \text{ ecm} \quad (2.39)$$

In 1979 it was estimated that [8]

$$d_n = 5 \times 10^{-16} \theta_{QCD} \text{ ecm} \quad (2.40)$$

leading to the stringent bound on θ_{QCD} .

Other particle EDM's provide competitive constraints on CP violation. The electron EDM is constrained [9],

$$|d_e| < 1.6 \times 10^{-27} e \cdot \text{cm} \quad (2.41)$$

as well those of Thallium and Mercury atoms [10],

$$\begin{aligned} |d_{Tl}| &< 9 \times 10^{-25} \text{ ecm} \\ |d_{Hg}| &< 2 \times 10^{-28} \text{ ecm} \end{aligned} \quad (2.42)$$

2.5. More history

I conclude this section on “Sakharov’s Laws” with a bit more about the early history of baryogenesis. The earliest papers on baryogenesis from the era when GUT’s were invented were not at first aware of Sakharov’s contribution. Yoshimura was the first to attempt to get baryogenesis from the SU(5) theory, in 1978 [11]. However, this initial attempt was flawed because it used only scatterings, not decays, and therefore did not incorporate the loss of thermal equilibrium. This defect was pointed out by Barr [6], following work of Toussaint *et al.* [12], and corrected by Dimopoulos and Susskind [13], who were the first to use the out-of-equilibrium decay mechanism. None of these authors knew about the Sakharov paper. Weinberg [14] and Yoshimura [15] quickly followed Dimopoulos and Susskind with more quantitative calculations of the baryon asymmetry in GUT models.

The first paper to attribute to Sakharov the need for going out of equilibrium, by Ignatiev *et al.*, [16] was not in the context of GUTS. They constructed a lower-energy model of baryogenesis, having all the necessary ingredients, by a modification of the electroweak theory. Their idea was not as popular as GUT baryogenesis, but it did make people aware of Sakharov’s early paper.

3. Example: GUT baryogenesis

I will now illustrate the use of Sakharov’s required ingredients in the SU(5) GUT theory [17]. This is no longer an attractive theory for baryogenesis because it requires a higher reheating temperature from inflation than is desired, from the point of view of avoiding unwanted relics, like monopoles and heavy gravitinos. Nevertheless, it beautifully illustrates the principles, and it is also useful for understanding leptogenesis, since the two approaches are mathematically quite similar.

In SU(5) there exist gauge bosons X^μ whose SU(3), SU(2) and U(1)_y quantum numbers are $(3, 2, -\frac{5}{6})$, as well as Higgs bosons Y with quantum numbers $(3, 1, \frac{1}{3})$, and whose couplings are similar to those of the vectors. The couplings to quarks and leptons are shown in figure 5. We see that the requirement of B violation is satisfied in this theory, and the CP-violating decays of any of these scalars can lead to a baryon asymmetry. To get CP violation, we need the matrix Yukawa couplings h_{ij}, y_{ij} to be complex, where i, j are generation indices. It will become apparent what the invariant phases are.

Let’s consider the requirement for X^μ or Y to decay out of equilibrium. The decay rate is

$$\Gamma_D \cong \alpha m N / \gamma \quad (3.1)$$

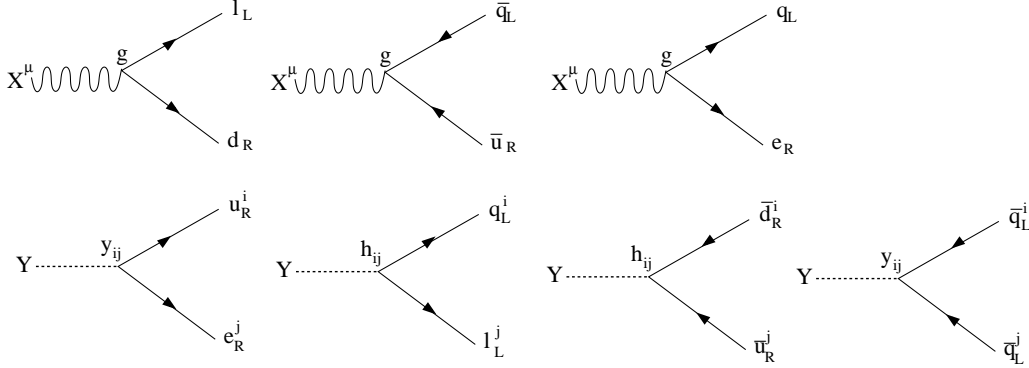

Fig. 5. GUT couplings

where $\alpha = g^2/(4\pi)$ or $\sim (y+h)^2/(4\pi)$, for X^μ or Y , respectively, m is the mass, N is the number of decay channels, and the Lorentz gamma factor can be roughly estimated at high temperature as

$$\gamma = \frac{\langle E \rangle}{m} \cong (1 = 9T^2/m^2)^{1/2} \quad (3.2)$$

considering that $\langle E \rangle \cong 3T$ for highly relativistic particles. The γ factor will actually not be necessary for us, because we are interested in cases where the particle decays at low temperatures compared to its mass, so that the decays will occur out of equilibrium. Thus we can set $\gamma = 1$. The age of the universe is $\tau \equiv 1/H = 1/\Gamma_D$ at the time of the decay, so we set

$$\begin{aligned} \Gamma_D &= H \cong \sqrt{g_*} \frac{T^2}{M_p} = \alpha m N \\ &\longrightarrow (\alpha N m M_p / \sqrt{g_*})^{1/2} \ll m \end{aligned} \quad (3.3)$$

where g_* is the number of relativistic degrees of freedom at the given temperature. Therefore we need $\alpha \ll (m/M_p)(\sqrt{g_*}/N)$. Let us first consider the decays of the X gauge boson. Since it couples to everything, the number of decay channels N is of the same order as g_* , and we get

$$\frac{g^2}{4\pi} \ll \frac{m}{M_p \sqrt{g_*}} \quad (3.4)$$

But unification occurs at the scale $m \cong 10^{16}$ GeV, for values of g^2 such that $\alpha \cong 1/25$, so this condition cannot be fulfilled. On the other hand, for the Higgs

bosons, Y , we get the analogous bound

$$\frac{h^2 \text{ or } y^2}{4\pi} \ll \frac{m}{M_p \sqrt{g_*}} \quad (3.5)$$

which can be satisfied by taking small Yukawa couplings. Therefore the Higgs bosons are the promising candidates for decaying out of equilibrium.

For clarity, I will now focus on a particular decay channel, $Y \rightarrow u_R e_R$, whose interaction Lagrangian is

$$y_{ij} Y^a \bar{u}_{R,a,i} e_{R,j}^c + \text{h.c.} \quad (3.6)$$

At tree level, we cannot generate any difference between the squared matrix elements, and we find that

$$|\mathcal{M}_{Y \rightarrow e_R u_R}|^2 = |\mathcal{M}_{\bar{Y} \rightarrow \bar{e}_R \bar{u}_R}|^2 \quad (3.7)$$

The complex phases are irrelevant at tree level. To get a CP-violating effect, we need interference between the tree amplitude and loop corrections, as shown in figure 6.

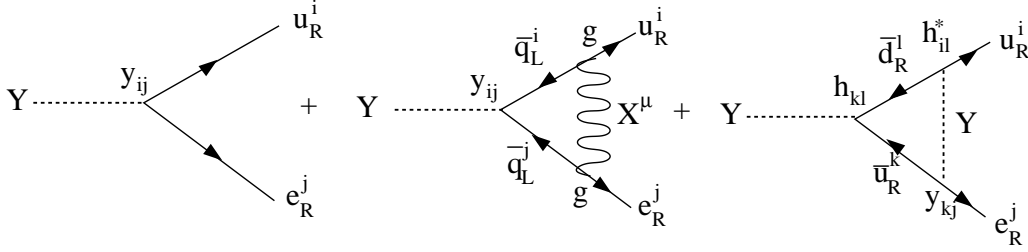

Fig. 6. Tree plus 1-loop contributions to $Y \rightarrow e_R u_R$

The one-loop diagrams develop imaginary parts which interfere with the phase of the tree diagram in a CP-violating manner. We can write the amplitude as

$$-i\mathcal{M} = -i(y_{ij} + y_{ij} F_X(M_X^2/p^2)) + (h^* H^T y)_{ij} F_Y(M_X^2/p^2) \quad (3.8)$$

where p is the 4-momentum of the decaying Y boson,

$$\begin{aligned} F_Y &= i^5 \int \frac{d^4 q}{(2\pi)^4} \frac{1}{q^2 - M_Y^2} \frac{1}{q + \frac{1}{2} \not{p} + i\epsilon} \frac{1}{q - \frac{1}{2} \not{p} + i\epsilon} \\ &\equiv R_Y + iI_Y \end{aligned} \quad (3.9)$$

and F_X is similar, but with $M_Y \rightarrow M_X$ and γ_μ factors in between the propagators. (It will turn out that the X exchange diagram does not contribute to the

CP-violating interference.) In the second line we have indicated that the loop integral has real and imaginary parts. The latter arise as a consequence of unitarity,

$$-i [\mathcal{M}(p_i \rightarrow p_f) - \mathcal{M}^*(p_f \rightarrow p_i)] = \sum_a d\Pi_a \mathcal{M}(p_i \rightarrow p_a) \mathcal{M}^*(p_f \rightarrow p_a) \quad (3.10)$$

where the sum is over all possible on-shell intermediate states and $d\Pi_a$ is the Lorentz-invariant phase space measure. If $\mathcal{M}^*(p_f \rightarrow p_i) = \mathcal{M}^*(p_i \rightarrow p_f)$, then the left-hand-side is the imaginary part of \mathcal{M} . The right-hand-side implies that an imaginary part develops if intermediate states can go on shell:

$$\text{Im} \dots = \dots = \int d\Pi \left(\dots \right) \times \left(\dots \right)$$

This will be the case as long as the decaying particle is heavier than the intermediate states.

To see how a rate asymmetry comes about, schematically we can write

$$\begin{aligned} \mathcal{M}(Y \rightarrow eu) &= y + yF_X + \tilde{y}F_Y \\ \mathcal{M}(\bar{Y} \rightarrow \bar{e}\bar{u}) &= y^* + y^*F_X + \tilde{y}^*F_Y \end{aligned} \quad (3.11)$$

where $\tilde{y} \equiv h^* h^T y$. Then the difference between the probability of decay of Y and \bar{Y} goes like

$$\begin{aligned} |\mathcal{M}_{Y \rightarrow eu}|^2 - |\mathcal{M}_{\bar{Y} \rightarrow \bar{e}\bar{u}}|^2 &= [y^*(1 + F_X^*) + \tilde{y}^*F_Y^*] [y(1 + F_X) + \tilde{y}F_Y] \\ &\quad - [y(1 + F_X^*) + \tilde{y}F_Y^*] [y^*(1 + F_X) + \tilde{y}^*F_Y] \\ &= y^* \tilde{y} F_Y + \tilde{y}^* y F_Y^* - y \tilde{y}^* F_Y - \tilde{y} y^* F_Y^* \\ &= [\tilde{y} y^* - \tilde{y}^* y] 2i I_Y \\ &= -4 \text{Im}[\tilde{y} y^*] I_Y \\ &= -4 \text{Im} \text{tr}(h^* h^T y y^\dagger) I_y \end{aligned} \quad (3.12)$$

(You can check that the F_X term does not contribute to this difference, since g is real.) Now, unfortunately, it is easy to see using the properties of the trace that $\text{tr}(h^* h^T y y^\dagger)$ is purely real, so this vanishes. However, there is a simple generalization which allows us to get a nonvanishing result. Suppose there are two or more Y bosons with different Yukawa matrices; then we get

$$|\mathcal{M}_{Y_A \rightarrow eu}|^2 - |\mathcal{M}_{\bar{Y}_A \rightarrow \bar{e}\bar{u}}|^2 = -4 \sum_B \text{Im} \text{tr}(h_B^* h_A^T y_B y_A^\dagger) I_y \left(\frac{M_B^2}{M_A^2} \right) \quad (3.13)$$

which no longer vanishes. The function I_Y can be found in [17], who estimate it to be of order $10^{-2} - 10^{-3}$ for typical values of the parameters.

Let us now proceed to estimate the baryon asymmetry. Define the rate asymmetry

$$r_A = \frac{|\mathcal{M}_{Y_A \rightarrow eu}|^2 - |\mathcal{M}_{\bar{Y}_A \rightarrow \bar{e}\bar{u}}|^2}{\sum_f |\mathcal{M}_{Y_A \rightarrow f}|^2} \quad (3.14)$$

which is the fraction of decays that produce a baryon excess. The sum in the denominator is over all possible final states. The resulting baryon density is

$$n_B - n_{\bar{B}} = \sum_A n_{Y_A} r_A B_q \quad (3.15)$$

where B_q is the amount of baryon number produced in each decay ($B_q = 1/3$ for the channel we have been considering). Of course, we should also add the corresponding contributions from all the competing B -violating decay channels, as was emphasized in the previous section. For simplicity we have shown how it works for one particular decay channel. Up to factors of order unity, this channel by itself gives a good estimate of the baryon asymmetry.

To compute the baryon asymmetry, it is convenient to take the ratio of baryons to entropy first, since as we have noted in section 1, entropy density changes in the same way as baryon density as the universe expands.

$$\frac{n_B - n_{\bar{B}}}{s} = \frac{\frac{1}{3} n_Y \sum_A r_A}{\frac{4\pi^2}{45} g_* T^2} = \frac{90\zeta(3)}{4\pi^4 g_*} \sum_A r_A \quad (3.16)$$

where we used $n_Y = (2\zeta(3)/\pi^2)T^3 \times 3$, the final factor of 3 counting the color states of Y . The number of degrees of freedom is

$$\begin{aligned} g_* &= \left(\sum_{\text{bosons}} + \frac{7}{8} \sum_{\text{fermions}} \right) (\text{spin states}) \\ &= \left\{ \begin{array}{ll} 106.75 & \text{standard model} \\ 160.75 & \text{SU}(5) \end{array} \right\} \times (\sim 2 \text{ if SUSY}) \end{aligned} \quad (3.17)$$

(these numbers can be found in the PDG Big Bang Cosmology review [1]). We can now use (1.4) to convert this to η , by multiplying by a factor of 7. Suppose we have SUSY SU(5); then

$$\eta \cong \frac{1.2}{320} \sum r_A \cong 10^{-2} \sum r_A \quad (3.18)$$

Thus we only need $\sum r_A \cong 6 \times 10^{-8}$, a quite small value, easy to arrange since

$$r_A \sim \frac{y^2 h^2}{y^2 + h^2} \epsilon I_y \quad (3.19)$$

where ϵ is the CP violating phase, and we noted that $I_Y \sim 10^{-2} - 10^{-3}$. According to our estimate of the size of y or h needed to decay out of equilibrium, $y^2 \sim 4\pi \times (10^{-4} - 10^{-6})$. We can easily make η large enough, or even too large.

3.1. Washout Processes

The foregoing was the first quantitative estimate of the baryon asymmetry, but it is missing an important ingredient which reduces η : B-violating rescattering and inverse decay processes. We have ignored diagrams like

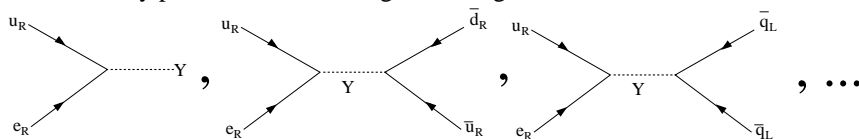

The first of these, inverse decay, was assumed to be negligible by our assumption of out-of-equilibrium decay, but more generally we could include this process and quantify the degree to which it is out of equilibrium. Any of the washout processes shown would cause the baryon asymmetry to relax to zero if they came into equilibrium.

To quantify these effects we need the Boltzmann equation for the evolution of baryon number. This was first carried out by Kolb and Wolfram [18], who were at that time postdoc and graduate student, respectively, at Caltech. The form of the Boltzmann equations is

$$\begin{aligned} \frac{dn_{u_R}}{dt} + 3Hn_{u_R} &\cong \int d\Pi_i (f_Y |\mathcal{M}(Y \rightarrow ue)|^2 - f_u f_e |\mathcal{M}(ue \rightarrow Y)|^2) \\ &+ \int d\Pi_i [f_{q_L} f_{q_L} |\mathcal{M}(qq \rightarrow ue)|^2 - f_u f_e |\mathcal{M}(ue \rightarrow qq)|^2] + \dots \end{aligned} \quad (3.20)$$

where f_x is the distribution function for particle x , $\int d\Pi_i$ is the phase space integral over all final and initial particles,

$$\prod_i d\Pi_i \equiv \left[\prod_i \left(\frac{d^4 p_i}{(2\pi)^3} \delta(p_i^2 - m_i^2) \right) \right] \times (2\pi)^4 \delta^{(4)} \left(\sum_{\text{final}} p_a - \sum_{\text{initial}} p_a \right) \quad (3.21)$$

and I have ignored final-state Pauli-blocking or Bose-enhancement terms, $(1 \pm f)$. We should include similar equations for any other particles which are relevant for the baryon asymmetry (X^μ , Y , quarks, leptons), and solve the coupled equations numerically to determine the final density of baryons. Depending on the strength of the scattering, the washout effect can be important. We can estimate its significance without solving the Boltzmann equations numerically.

Define the abundance $Y_i \equiv n_i/n_\gamma$ and consider a simplified model where $X \rightarrow bb, \bar{b}\bar{b}$ (baryons or antibaryons), with

$$\begin{aligned}\Gamma_{X \rightarrow bb} &\equiv \frac{1}{2}(1 + \epsilon)\Gamma_X \\ \Gamma_{X \rightarrow \bar{b}\bar{b}} &\equiv \frac{1}{2}(1 - \epsilon)\Gamma_X \\ \Gamma_{\bar{X} \rightarrow bb} &\equiv \frac{1}{2}(1 - \bar{\epsilon})\Gamma_X \\ \Gamma_{\bar{X} \rightarrow \bar{b}\bar{b}} &\equiv \frac{1}{2}(1 + \bar{\epsilon})\Gamma_X\end{aligned}\quad (3.22)$$

Kolb and Wolfram found that the time rate of change of the baryon abundance (which we could also have called $\dot{\eta}$) is

$$\dot{Y}_B = \Gamma_X(\epsilon - \bar{\epsilon})[Y_X - Y_{\text{eq}}] - 2Y_B[\Gamma_X Y_{X,\text{eq}} + \Gamma_{bb \leftrightarrow \bar{b}\bar{b}}] \quad (3.23)$$

On the right-hand-side, the first term in brackets represents baryon production due to CP-violating decays, while the second term is due to the washout induced by inverse decays and scatterings. The scattering term is defined by the thermal average

$$\Gamma_{bb \leftrightarrow \bar{b}\bar{b}} = n_\gamma (\langle v\sigma_{bb \rightarrow \bar{b}\bar{b}} \rangle + \langle v\sigma_{\bar{b}\bar{b} \rightarrow bb} \rangle) \quad (3.24)$$

In the treatment of Nanopoulos and Weinberg, the effect of $\Gamma_{bb \leftrightarrow \bar{b}\bar{b}}$ was neglected, but we can estimate it using dimensional analysis as

$$\Gamma_{bb \leftrightarrow \bar{b}\bar{b}} \sim \frac{\alpha^2 T^5}{(M_X^2 + 9T^2)^2} \quad (3.25)$$

(considering s -channel exchange of the X boson), again using $\langle E \rangle \sim 3T$. Then if we imagine the initial production of the baryon asymmetry happens quickly (by the time $t \equiv 0$), followed by gradual relaxation, then

$$Y_B(t) \sim Y_B(0) e^{-\int \Gamma_{bb \leftrightarrow \bar{b}\bar{b}} dt} \quad (3.26)$$

Using $H \sim 1/t \sim g_* T^2/M_p$, $dt \sim (M_p/g_*)(dT/T^3)$,

$$\int \Gamma dt \sim \frac{M_p}{g_*} \int \Gamma \frac{dT}{T^3} \cong \frac{\pi\alpha^2 M_p}{100M_X} \quad (3.27)$$

so the maximum BAU gets diluted by a factor $\sim e^{-(\pi\alpha^2 M_p/(100M_X))}$. We thus need $\alpha^2 \lesssim 30M_X/M_p$, hence $\alpha \lesssim 0.05$, using $M_X/M_p \sim 10^{-4}$. This agrees with the quantitative findings of Kolb and Turner, schematically shown in figure

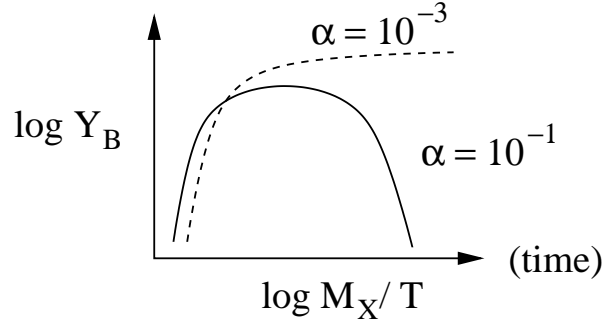

Fig. 7. Evolution of baryon asymmetry with with B-violating rescattering processes included.

7. Notice that this value of α is consistent with the unification value, so GUT baryogenesis works.

This concludes our discussion of GUT baryogenesis. As noted earlier, it is disfavored because it needs a very high reheat temperature after inflation, which could introduce monopoles or gravitinos as relics that would overclose the universe. Another weakness, shared by many theories of baryogenesis, is a lack of testability. There is no way to distinguish whether baryogenesis happened via GUT's or some other mechanism. We now turn to the possibility of baryogenesis at lower temperatures, with greater potential for testability in the laboratory.

4. B and CP violation in the Standard Model

During the development of GUT baryogenesis, it was not known that the standard model had a usable source of B violation. In 1976, 't Hooft showed that the triangle anomaly violates baryon number through a nonperturbative effect [19]. In (2.1) we saw that the baryon current is not conserved in the presence of external W boson field strengths. However this violation of B is never manifested in any perturbative process. It is associated with the vacuum structure of $SU(N)$ gauge theories with spontaneously broken symmetry. To explain this, we need to introduce the concept of Chern-Simons number,

$$N_{CS} = \int d^3x K^0 \quad (4.1)$$

where the current K^μ is given by

$$K^\mu = \frac{g^2}{32\pi^2} \epsilon^{\mu\nu\alpha\beta} \left(F_{\nu\alpha}^a A_\beta^a - \frac{g}{3} \epsilon_{abc} A_\nu^a A_\alpha^b A_\beta^c \right) \quad (4.2)$$

(note: there are a number of references [20, 21] in which the factor $g/3$ is incorrectly given as $2g/3$; this seems to be an error that propagated without being checked). This current has the property that

$$\partial_\mu K^\mu = \frac{g^2}{32\pi^2} F_{\mu\nu}^a \tilde{F}^{a,\mu\nu} \quad (4.3)$$

Chern-Simons number has a topological nature which can be seen when considering configurations which are pure gauge at some initial and final times, t_0 and t_1 . It can be shown that

$$N_{CS}(t_1) - N_{CS}(t_0) = \int_{t_0}^{t_1} dt \int d^3x \partial_\mu K^\mu = \nu \quad (4.4)$$

an integer, which is a winding number. The gauge field is a map from the physical space to the manifold of the gauge group. If we consider an $SU(2)$ subgroup of $SU(N)$, and the boundary of 4D space compactified on ball, both manifolds are 3-spheres, and the map can have nontrivial homotopy.

We are interested in the vacuum structure of $SU(2)$ gauge theory. Consider a family of static gauge field configurations with continuously varying N_{CS} . Those configuration with integer values turn out to be pure gauge everywhere, hence with vanishing field strength and zero energy. But to interpolate between two such configurations, one must pass through other configurations whose field strength and energy are nonvanishing. The energy versus Chern-Simons number has the form shown in figure 8.

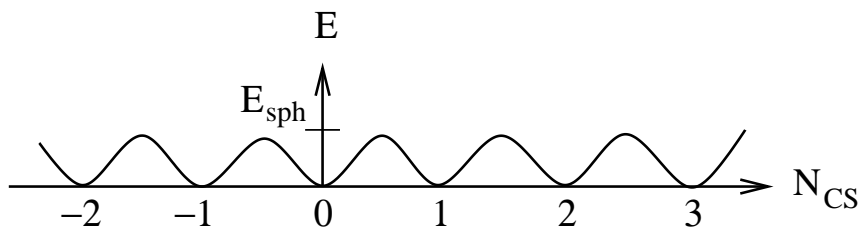

Fig. 8. Energy of gauge field configurations as a function of Chern-Simons number.

Each minimum is a valid perturbative vacuum state of the theory. They are called n -vacua. The height of the energy barrier is

$$E_{\text{sph}} = f\left(\frac{\lambda}{g^2}\right) \frac{4\pi v}{g} \cong \frac{8\pi v}{g} = \frac{2M_W}{\alpha_W} f\left(\frac{\lambda}{g^2}\right) \quad (4.5)$$

where $v = 174$ GeV is the Higgs field VEV, λ is the Higgs quartic coupling, $\alpha_W = g^2/4\pi \cong 1/30$, and the function f ranges between $f(0) = 1.56$ and $f(\infty) = 2.72$.

't Hooft discovered that tunneling occurs between n -vacua through field configurations now called instantons (Physical Review tried to suppress that name at first, so the term “pseudoparticle” appears in the early literature, but it soon succumbed to the much more popular name.) The relevance of this for B violation is through the relation between the divergence of the left-handed baryon plus lepton current to the divergence of K^μ :

$$\partial_\mu J_{B+L}^\mu = N_f \partial_\mu K^\mu \quad (4.6)$$

where $N_f = 3$ is the number of families. Integrating this relation over space and time, the spatial divergence integrates to zero and we are left with

$$3 \frac{d}{dt} N_{CS} = \frac{d}{dt} B = \frac{d}{dt} L \quad (4.7)$$

Hence each instanton transition violates B and L by 3 units each—there is spontaneous production of 9 quarks and 3 leptons, with each generation represented equally.

However, the tunneling amplitude is proportional to

$$\mathcal{A} \sim e^{-8\pi^2/g^2} \sim 10^{-173} \quad (4.8)$$

which is so small as to never have happened during the lifetime of the universe. For this reason, anomalous B violation in the SM was not at first considered relevant for baryogenesis. But in 1985, Kuzmin, Rubakov and Shaposhnikov realized that at high temperatures, these transitions would become unsuppressed, due to the availability of thermal energy to hop over the barrier, instead of tunneling through it [23]. This occurs when $T \gtrsim 100$ GeV. The finite- T transitions are known as sphaleron processes, a term coined by Klinkhamer and Manton from the Greek, meaning “ready to fall:” it is the field configuration of Higgs and W^μ which sits at the top of the energy barrier between the n -vacua [20]. A thermal transition between n -vacua must pass through a configuration which is close to the sphaleron, unless $T \gg E_{\text{sph}}$. The sphaleron is a static, saddle point solution to the field equations.

Evaluating the path integral for a sphaleron transition semiclassically, one finds that the amplitude goes like

$$\mathcal{A} \sim e^{-E_{\text{sph}}/T} \quad (4.9)$$

To find the actual rate of transitions, one must do a more detailed calculation including the fluctuation determinant around the saddle point [21]. Khlebnikov and Shaposhnikov obtained the rate per unit volume of sphaleron transitions

$$\frac{\Gamma}{V} = \text{const} \left(\frac{E_{\text{sph}}}{T} \right)^3 \left(\frac{m_W(T)}{T} \right)^4 T^4 e^{-E_{\text{sph}}/T} \quad (4.10)$$

where the constant is a number of order unity and $m_W(T)$ is the temperature dependent mass of the W boson. But this formula is only valid at temperatures $T < E_{\text{sph}}$. In fact, at $T \gtrsim m_W$, electroweak symmetry breaking has not yet occurred, and $m_W(T) = 0$. The Higgs VEV vanishes in this symmetry-restored phase, and $E_{\text{sph}} = 0$. There is no longer any barrier between the n -vacua at these high temperatures.

The rate of sphaleron interactions above the electroweak phase transition (EWPT) cannot be computed analytically; lattice computations are required. For many years it was believed that the parametric dependence was of the form

$$\frac{\Gamma}{V} = c\alpha_w^4 T^4 \quad (4.11)$$

with $c \sim 1$ and $\alpha_w = g_2^4/(4\pi) \cong 1/30$. This is based on the idea that the transverse gauge bosons acquire a magnetic thermal mass of order $g^2 T$, which is the only relevant scale in the problem, and therefore determines (4.11) by dimensional analysis. The origin of this scale can be readily understood [25] by the following argument. We are looking for field configurations with $N_{CS} \sim 1$, so using the definition of Chern-Simons number,

$$\int d^3x (g^2 F A \text{ or } g^3 A^3) \sim 1 \quad (4.12)$$

but the energy of the configuration is determined by the temperature,

$$\int d^3x F^2 \sim T \quad (4.13)$$

We can therefore estimate for a configuration of size R that

$$\begin{aligned} R^3 \left(g^2 \frac{A^2}{R^2} \text{ or } g^3 A^3 \right) &\sim 1 \\ R^3 \frac{A^2}{R^2} &\sim T \end{aligned} \quad (4.14)$$

which fixes the size of A and R , giving $R \sim 1/(g^2 T)$. Hence the estimate that $\Gamma/V \sim (g^2 T)^4$. However it was later shown [26] that this is not quite right—the time scale for sphaleron transitions is actually $g^4 T$, not $g^2 T$, giving $\Gamma/V \sim \alpha_w^5 T^4$. Careful measurements in lattice gauge theory fixed the dimensionless coefficient to be [27] $\Gamma/V = (29 \pm 6)\alpha_w^5 T^4$, and more recently [28]

$$\frac{\Gamma}{V} = (25.4 \pm 2.0)\alpha_w^5 T^4 = (1.06 \pm 0.08) \times 10^{-6} T^4 \quad (4.15)$$

Ironically the prefactor is such that the old $\alpha_w^4 T^4$ estimate was good using $c = 1$.

We can now determine when sphalerons were in thermal equilibrium in the early universe. To compute a rate we must choose a relevant volume. We can take the thermal volume, $1/T^3$, which is the average space occupied by a particle in the thermal bath. Then

$$\Gamma = 10^{-6}T \quad (4.16)$$

which must be compared to the Hubble rate, $H \sim \sqrt{g_*}T^2/M_p$. At very high temperatures, sphalerons are *out* of equilibrium, as illustrated in figure 9. They come into equilibrium when

$$\begin{aligned} \Gamma = H &\Rightarrow 10^{-6}T = \sqrt{g_*} \frac{T^2}{M_p} \\ T &= 10^{-6}g_*^{-1/2}M_p \sim 10^{-5}M_p \sim 10^{13}\text{GeV} \end{aligned} \quad (4.17)$$

Hence GUT baryogenesis is affected by sphalerons, after the fact. Of course when T falls below the EWPT temperature ~ 100 GeV, the sphaleron rate again falls below H .

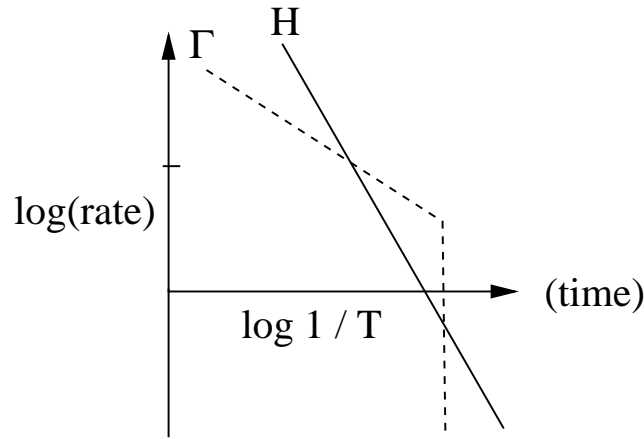

Fig. 9. Sphaleron rate and Hubble rate versus time. The sharp drop in the sphaleron rate occurs at the EWPT.

4.1. CP violation in the SM

Since the SM provides such a strong source of B violation, it is natural to wonder whether baryogenesis is possible within the SM. We must investigate whether the other two criteria of Sakharov can be fulfilled.

It is well known that CP violation exists in the CKM matrix of the SM,

$$V_{CKM} = \begin{pmatrix} V_{ud} & V_{us} & V_{ub} \\ V_{cd} & V_{cs} & V_{cb} \\ V_{td} & V_{ts} & V_{tb} \end{pmatrix} = \begin{pmatrix} c_1 & -s_1 c_3 & -s_1 s_3 \\ s_1 c_2 & \frac{c_1 c_2 c_3}{-s_2 s_3 e^{i\delta}} & \frac{c_1 c_2 s_3}{+s_2 c_3 e^{i\delta}} \\ s_1 s_2 & \frac{c_1 s_2 c_3}{+c_2 s_3 e^{i\delta}} & \frac{c_2 s_2 s_3}{-c_2 c_3 e^{i\delta}} \end{pmatrix} \quad (4.18)$$

This is the original parametrization, whereas in the Wolfenstein parametrization, V_{ub} and V_{td} contain the CP-violating phase. Where the phase resides in the CKM matrix can be changed by field redefinitions. How do we express the invariant phase? There is no unique answer: it depends upon which physical process is manifesting the CP violation. However C. Jarlskog tried to address the question in a rather general way [29]. She showed that one possible invariant is the combination

$$\begin{aligned} J &= (m_t^2 - m_c^2)(m_t^2 - m_u^2)(m_c^2 - m_u^2) \\ &\quad (m_b^2 - m_s^2)(m_b^2 - m_d^2)(m_s^2 - m_d^2) K \\ \text{where } K &= s_1^2 s_2 s_3 c_1 c_2 c_3 \sin \delta \\ &= \text{Im } V_{ii} V_{jj} V_{ij}^* V_{ji}^* \text{ for } i \neq j \end{aligned} \quad (4.19)$$

This is derived by computing the determinant of the commutator of the up- and down-type quark mass matrices (squared):

$$J = \det [m_u^2, m_d^2] \quad (4.20)$$

and therefore is invariant under rotations of the fields.

The form of J has been used to argue that CP violation within the standard model cannot be large enough for baryogenesis. One should find a dimensionless measure of the strength of CP violation, using the relevant temperature of the universe, which must be at least of order 100 GeV for sphalerons to be effective. One then finds that

$$\frac{J}{(100 \text{ GeV})^{12}} \sim 10^{-20} \quad (4.21)$$

which is much too small to account for $\eta \sim 10^{-10}$.

One might doubt whether this argument is really robust. For example, in the original PRL of Jarlskog [29], J was defined in terms of the linear quark mass matrices, which yielded a formula like (4.19), but with linear rather than squared mass differences. In the subsequent paper it was argued that actually the sign of a fermion mass has no absolute physical significance, so any physical quantity should depend on squares of masses. However, this seems to have no bearing on the mathematical fact that the original linear-mass definition of J is a valid

invariant characterization of the CP phase. If this were the physically correct definition, then (4.21) would be revised to read $J \sim 10^{-10}$, which is in the right ballpark.

A more specific criticism of the argument was given in [30], who noted that the argument cannot be applied to $K\bar{K}$ mixing in the neutral kaon system, coming from the box diagram

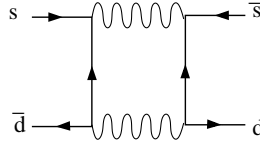

Farrar and Shaposhnikov point out that this CP-violating effect is not proportional to J , and that the relevant scale is much smaller than 100 GeV—it is the mass of K^0 . The idea that J/T^{12} is the correct measure of CP violation only makes sense if all the ratios of mass to temperature can be treated as perturbatively small. This is clearly not the case for the ratio of the top quark mass to the K^0 mass. Could there not also be some scale lower than 100 GeV playing a role in the baryogenesis mechanism? Ref. [30] attempted to construct such a mechanism within the SM, which was refuted by [31]. There is no theorem proving that it is impossible to find some other mechanism that does work, but so far there are no convincing demonstrations, and most practitioners of baryogenesis agree that CP violation in the SM is too weak; one needs new sources of CP violation and hence new physics beyond the SM. We will see that it is rather easy to find such new sources; for example the MSSM has many new phases, such as in the term $W = \mu H_1 H_2$ in the superpotential, and in the gaugino masses.

5. Electroweak Phase Transition and Electroweak Baryogenesis

In the previous section we showed that B violation is present in the standard model, and new sources of CP violation are present in low-energy extensions of the SM. But the remaining requirement, going out of thermal equilibrium, is not so easy to achieve at low energies. Recall the condition for out-of-equilibrium decay, (3.4),

$$\alpha \ll \frac{m}{M_p} \quad (5.1)$$

If $m \sim 100$ GeV, we require extraordinarily weak couplings which are hard to justify theoretically, and which would also be hard to verify experimentally.

But the EWPT can provide a departure from thermal equilibrium if it is sufficiently strongly first order. The difference between first and second order is

determined by the behavior of the Higgs potential at finite temperature, as shown in figure 10. In a first order transition, the potential develops a bump which separates the symmetric and broken phases, while in a second order transition or a smooth cross-over there is no bump, merely a change in sign of the curvature of the potential at $H = 0$. The critical temperature T_c is defined to be the temperature at which the two minima are degenerate in the first order case, or the temperature at which $V''(0) = 0$ in the second order case.

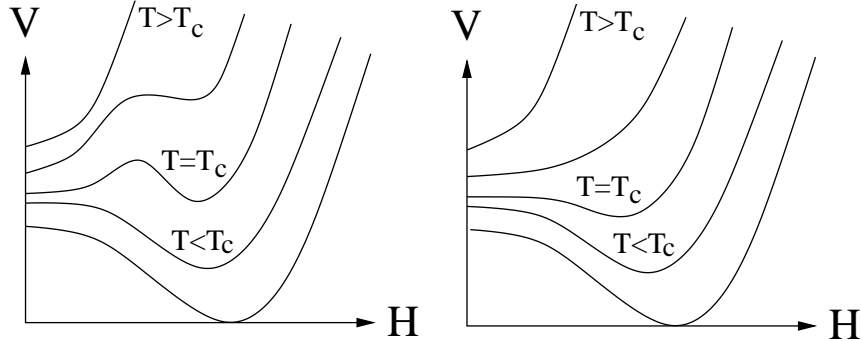

Fig. 10. Schematic illustration of Higgs potential evolution with temperature for first (left) and second (right) order phase transition.

A first order transition proceeds by bubble nucleation (fig. 11), where inside the bubbles the Higgs VEV and particle masses are nonzero, while they are still vanishing in the exterior symmetric phase. The bubbles expand to eventually collide and fill all of space. If the Higgs VEV v is large enough inside the bubbles, sphalerons can be out of equilibrium in the interior regions, while still in equilibrium outside of the bubbles. A rough analogy to GUT baryogenesis is that sphalerons outside the bubbles correspond to B-violating Y boson decays, which are fast, while sphalerons inside the bubbles are like the B-violating inverse Y decays. The latter should be slow; otherwise they will relax the baryon asymmetry back to zero.

In a second order EWPT, even though the sphalerons go from being in equilibrium to out of equilibrium, they do so in a continuous way, and uniformly throughout space. To see why the difference between these two situations is important, we can sketch the basic mechanism of electroweak baryogenesis, due to Cohen, Kaplan and Nelson [32]. The situation is illustrated in figure 12, which portrays a section of a bubble wall moving to the right. Because of CP-violating interactions in the bubble wall, we get different amounts of quantum mechanical reflection of right- and left-handed quarks (or of quarks and antiquarks). This leads to a chiral asymmetry in the vicinity of the wall. There is an excess of

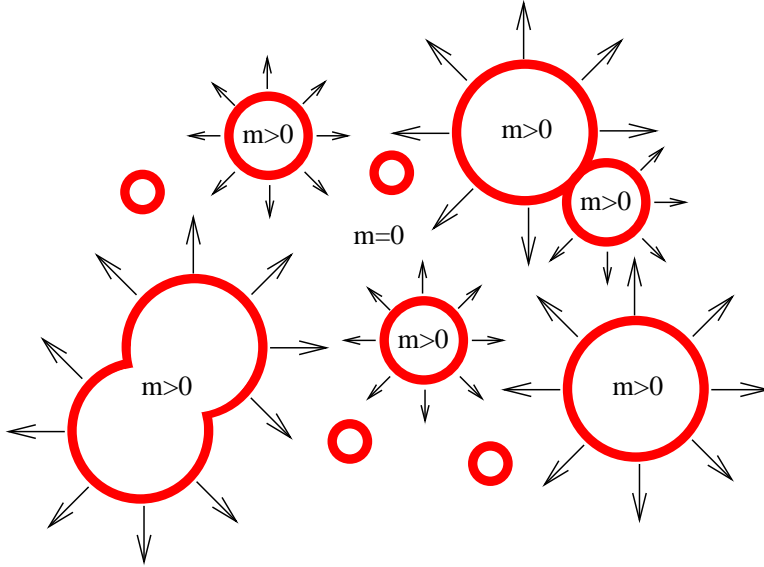
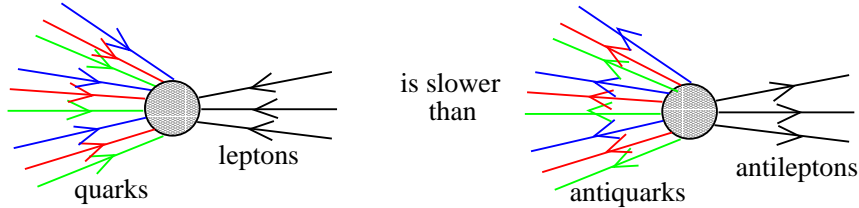

Fig. 11. Bubble nucleation during a first-order EWPT.

$q_L + \bar{q}_R$ relative to $q_R + \bar{q}_L$ in front of the wall, and a compensating deficit of this quantity on the other side of the wall. This CP asymmetry is schematically shown in figure 13.

Sphalerons interact only with q_L , not q_R , and they try to relax the CP-asymmetry to zero. Diagrammatically,



simply because there are more \bar{q}_L than q_L in front of the wall. But the first interaction violates baryon number by -3 units while the second has $\Delta B = 3$. Therefore the CP asymmetry gets converted into a baryon asymmetry in front of the wall (but not behind, since we presume that sphaleron interactions are essentially shut off because of the large Higgs VEV). Schematically the initial baryon asymmetry takes the form of figure 14.

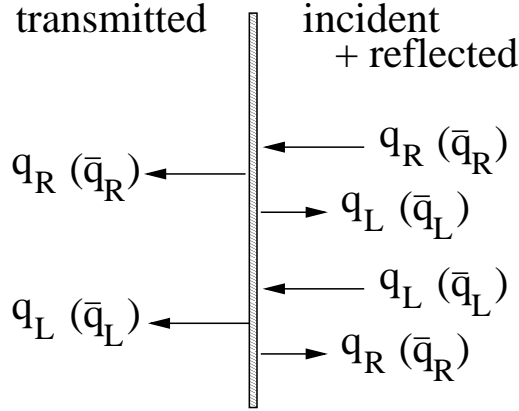

Fig. 12. CP-violating reflection and transmission of quarks at the moving bubble wall.

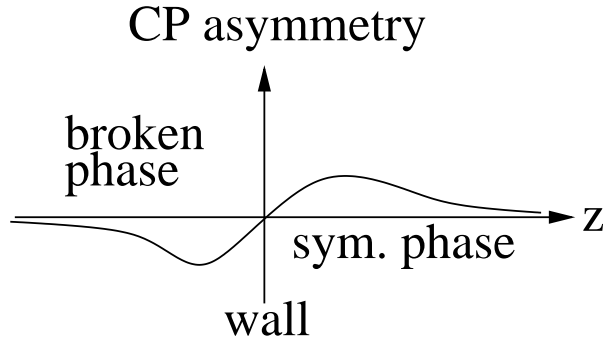

Fig. 13. The CP asymmetry which develops near the bubble wall.

If the baryon asymmetry remained in front of the wall, eventually sphalerons would cause it to relax to zero, because there are other processes besides sphalerons in the plasma which can relax the CP asymmetry, for example *strong* SU(3) sphalerons which change chirality Q_5 by 12 units, 2 for each flavor, as shown in figure 15. (See [33] for a lattice computation of the strong sphaleron rate.) The combination of weak and strong sphalerons would relax Q_5 and $B + L$ to zero if the wall was not moving. But due to the wall motion, there is a tendency for baryons to diffuse into the broken phase, inside the bubble. If E_{sph}/T is large enough, Γ_{sph} is out of equilibrium and B violation is too slow to relax B to zero. This is the essence of electroweak baryogenesis.

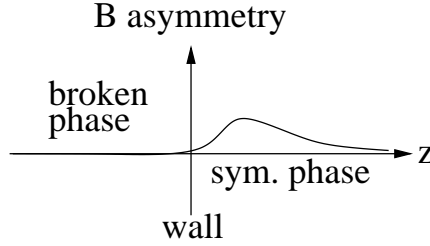

Fig. 14. The B asymmetry which initially develops in front of the bubble wall.

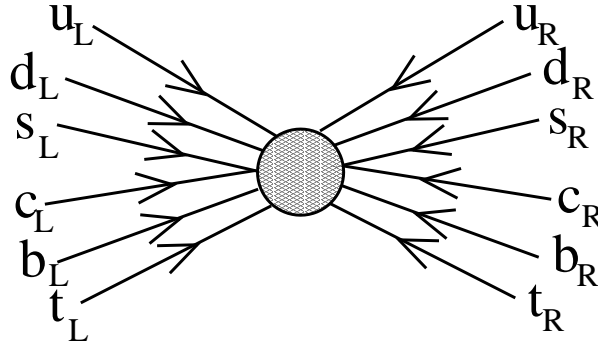

Fig. 15. The strong sphaleron.

5.1. Strength of the phase transition

Now that we appreciate the importance of the first order phase transition, we can try to compute whether it occurs or not. The basic tool for doing so is the finite-temperature effective potential of the Higgs field, defined by the path integral

$$e^{-\beta \int d^3x V_{\text{eff}}(H)} = \int \prod_i \mathcal{D}\phi_i e^{-\int_0^\beta d\tau \int d^3x \mathcal{L}[H, \phi_i]} \quad (5.2)$$

where $\beta = 1/T$, H is the background Higgs field, and ϕ_i are fluctuations of all fields which couple to the Higgs, including H itself. Here τ is imaginary time and the fields are given periodic (antiperiodic) boundary conditions between $\tau = 0$ and β if they are bosons (fermions). For a compact introduction to field theory at finite temperature, see ref. [34].

To evaluate V_{eff} , we can use perturbation theory. Since there are no external legs, V_{eff} is given by a series of vacuum bubbles,

$$\mathbf{V}_{\text{eff}} = \bigcirc + \{ \bigcirc\bigcirc + \bigcirc \! \! \! \bigcirc \} + \dots$$

The one-loop contribution has a familiar form,

$$V_{1\text{-loop}} = T \sum_i \pm \int \frac{d^3p}{(2\pi)^3} \ln \left(1 \mp e^{-\beta\sqrt{p^2+m_i^2(H)}} \right) \begin{cases} \text{bosons} \\ \text{fermions} \end{cases} \quad (5.3)$$

This is the free energy of a relativistic gas of bosons or fermions. Recall that the partition function for a free nonrelativistic gas of N particles in a volume V is

$$\begin{aligned} F &= -T \ln Z; \\ Z &= \left(\frac{V}{h} \int d^3p e^{-\beta p^2/2m} \right)^N \end{aligned} \quad (5.4)$$

Eq. (5.3) is the relativistic generalization, taking into account that a fermion loop comes with a factor of -1 . The nontrivial aspect is that we must evaluate the particle masses as a function of the Higgs VEV H .

In the standard model, the important particles contributing to the thermal partition function, and their field-dependent masses, are

$$\text{top quark: } m_t = yH \quad (5.5)$$

$$\text{gauge bosons, } W^\pm, W^3, B : m^2 = \frac{1}{2}H^2 \begin{pmatrix} g^2 & & & \\ & g^2 & & \\ & & g^2 & gg' \\ & & gg' & g^2 \end{pmatrix} \quad (5.6)$$

(One must of course find the eigenvalues of the gauge boson mass matrix.) For the Higgs bosons, we need to refer to the tree-level Higgs potential

$$V = \lambda \left(|H|^2 - \frac{1}{2}v^2 \right)^2 = \frac{1}{4}\lambda \left(\phi^2 + \sum_i \chi_i^2 - v^2 \right)^2 \quad (5.7)$$

where the real components of the Higgs doublet are $H = \frac{1}{\sqrt{2}}(\phi + i\chi_1, \chi_2 + i\chi_3)$. ϕ is the massive component, while χ_i are the Goldstone bosons which get “eaten” by the W gauge bosons. In the effective potential, we set $\chi_i = 0$ so that the VEV is given by $H = \frac{1}{\sqrt{2}}\phi$, but to find the masses of the Goldstone bosons, we must temporarily include their field-dependence in H , take derivatives with respect to χ_i , and then set $\chi_i = 0$. Then

$$\text{Higgs boson, } H : m_H^2 = \frac{\partial^2 V}{\partial \phi^2} = \lambda(3\phi^2 - v^2) = \lambda(6H^2 - v^2) \quad (5.8)$$

$$\text{Goldstone bosons, } \chi_i : m_i^2 = \frac{\partial^2 V}{\partial \chi_i^2} = \lambda(\phi^2 - v^2) = \lambda(2H^2 - v^2) \quad (5.9)$$

We must use these field-dependent masses in the 1-loop thermal effective potential. Unfortunately the momentum integrals cannot be done in any enlightening closed form, except in the high- or low-temperature limits. We will be interested in the high- T case, where $V_{1\text{-loop}}$ can be expanded as

$$V_{1\text{-loop}} = \sum_{i \in B, F} \frac{m_i^2 T^2}{48} \times \left\{ \begin{array}{l} 2, \text{ each real B} \\ 4, \text{ each Dirac F} \end{array} \right\} - \frac{m_i^3 T}{12\pi} \left\{ \begin{array}{l} 1, \text{ B} \\ 0, \text{ F} \end{array} \right\} \\ + \frac{m_i^4}{64\pi^2} \left(\ln \frac{m_i^2}{T^2} - c_i \right) \times \left\{ \begin{array}{l} -1, \text{ B} \\ +4, \text{ Dirac F} \end{array} \right\} + O\left(\frac{m_i^5}{T}\right) \quad (5.10)$$

where

$$c_i = \left\{ \begin{array}{l} \frac{3}{2} + 2 \ln 4\pi - 2\gamma_E \cong 5.408, \text{ B} \\ c_B - 2 \ln 4 \cong 2.635, \text{ F} \end{array} \right. \quad (5.11)$$

Let's examine the effects of these terms, starting with the term of order $m_i^2 T^2$. This is the source of a T -dependent squared mass for the Higgs boson, and explains why $V''(0) > 0$ at high T . Focusing on just the H^2 terms, the contributions to the potential are

$$V_{1\text{-loop}} = H^2 T^2 \left[\frac{1}{2} \lambda + \frac{3}{16} (3g^2 + g'^2) + \frac{1}{4} y^2 \right] + O(H^3) \\ \equiv a T^2 H^2 + O(H^3) \quad (5.12)$$

$$V_{\text{tree}} = -\lambda v^2 H^2 + O(H^4) \quad (5.13)$$

Putting these together, we infer that the T -dependent Higgs mass is given by

$$m_H^2(T) = -\lambda v^2 + a T^2 \quad (5.14)$$

and we can find the critical temperature of the phase transition (if it was second order) by solving for $m_H^2 = 0$:

$$T_c = \sqrt{\frac{\lambda}{a}} v \cong 2 \frac{\sqrt{\lambda}}{y} v \quad (5.15)$$

If the transition is first order, it is due to the ‘‘bump’’ in the potential, which can only come about because of the H^3 term in $V_{1\text{-loop}}$. The cubic term is

$$V_{\text{cubic}} \cong -\frac{TH^3}{12\sqrt{2}\pi} \left(3g^3 + \frac{3}{2}(g^2 + g'^2)^{3/2} + O(\lambda) \right) \equiv -ETH^3 \quad (5.16)$$

where the $O(\lambda)$ contributions have been neglected, since we will see that $\lambda \ll g^2$ is necessary for having a strongly first order phase transition.

With the cubic term, the potential takes the form

$$V_{\text{tot}} \cong m_H^2(T)H^2 - ETH^3 + \lambda H^4 \quad (5.17)$$

and at the critical temperature it becomes

$$V_{\text{tot}} = \lambda H^2 \left(H - \frac{v_c}{\sqrt{2}} \right)^2 \quad (5.18)$$

since this is the form which has degenerate minima at $H = 0$ and $H = v_c$. Notice that the VEV at the critical temperature, v_c , is not the same as the zero-temperature VEV, v . By comparing (5.17) and (5.18) we find that

$$m^2(T) = \frac{1}{2}\lambda v_c^2, \quad ET_c = \sqrt{2}\lambda v_c \quad (5.19)$$

which allows us to solve for v_c and T_c . The result is

$$T_c = \frac{\lambda v}{\sqrt{a\lambda - \frac{1}{4}E^2}} \quad (5.20)$$

and

$$\frac{v_c}{T_c} = \frac{E}{2\sqrt{\lambda}} \cong \frac{3g^3}{16\pi\lambda} \quad (5.21)$$

The ratio v_c/T_c is a measure of the strength of the phase transition. It determines how strongly the sphalerons are suppressed inside the bubbles. Recall that

$$\frac{E_{\text{sph}}}{T} \sim \frac{8\pi}{g} \left(\frac{v}{T} \right) \quad (5.22)$$

appears in $\Gamma_{\text{sph}} \sim e^{-E_{\text{sph}}/T}$, so the bigger v/T is at the critical temperature, the less washout of the baryon asymmetry will be caused by sphalerons. The total dilution of the baryon asymmetry inside the bubbles is the factor

$$e^{-\int_{t_c}^{\infty} \Gamma_{\text{sph}} dt} \quad (5.23)$$

where t_c is the time of the phase transition. Requiring this to be not too small gives a bound [35]

$$\frac{v_c}{T_c} \gtrsim 1 \quad (5.24)$$

which we can use to infer a bound on the Higgs mass [36], by combining (5.21) and (5.24). Given that

$$\alpha_w = \frac{g^2}{4\pi} \cong \frac{8M_w^2 G_F}{4\sqrt{2}\pi} \cong \frac{1}{29.5} \quad (5.25)$$

the weak coupling constant is $g = 0.65$, so (5.24) implies $\lambda < 3g^3/16\pi = 0.128$, and therefore

$$m_H = \sqrt{\frac{\lambda}{2}} v < 32 \text{ GeV} \quad (5.26)$$

This is far below the current LEP limit $m_H > 115 \text{ GeV}$, so it is impossible to have a strongly first order electroweak phase transition in the standard model.

The expressions we have derived give the impression that, regardless of the value of the Higgs mass, the phase transition is first order, even if very weakly. This is not the case, as explained by P. Arnold [37]: at high temperatures, the perturbative expansion parameter is not just made from dimensionless couplings, but rather

$$\frac{g^2 T}{m_W} \sim \frac{\lambda}{g^2} \sim \frac{m_H^2}{m_W^2} \Big|_{T=0} \quad (5.27)$$

due to the fact that the high- T theory is effectively 3-dimensional, and is more infrared-sensitive to the gauge boson masses than is the 4D ($T = 0$) theory. In the regime of large λ , nonperturbative lattice methods must be used to study the phase transition. It was found in [38] that in the T - m_H phase diagram, there is a line of 1st order phase transitions ending at a critical point with a 2nd order transition at $m_H = 75 \text{ GeV}$. For larger m_H , there is no phase transition at all, but only a smooth crossover. This is illustrated in figure 16.

Most attempts to improve this situation have relied on new scalar particles coupling to the Higgs field. Ref. [39] considered a singlet field S with potential

$$V = 2\zeta^2 |H|^2 |S|^2 + \mu^2 |S|^2 \quad (5.28)$$

including a large coupling to the Higgs field, so

$$m_s^2 = \mu^2 + 2\zeta^2 |H|^2 \quad (5.29)$$

If μ^2 is not too large ($\mu \lesssim 90 \text{ GeV}$) then the cubic term $-\frac{1}{12\pi} T(\mu^2 + 2\zeta^2 H^2)^{3/2}$ is sufficiently enhanced so that $v/T \sim 1$ for heavy Higgs. If μ^2 is too large, this does not function as a cubic term, since it can be Taylor-expanded in H^2 .

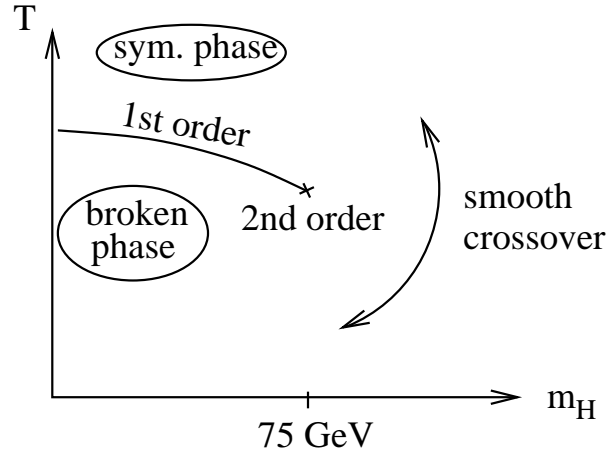
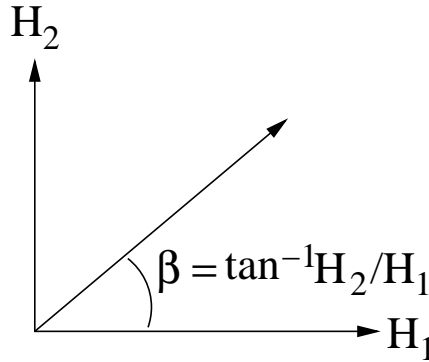

Fig. 16. Phase diagram for the EWPT, from ref. [38]

5.2. EWPT in the MSSM

It is possible to implement this mechanism in the MSSM because top squarks (stops) couple strongly to the Higgs [40]. The MSSM is a model with two Higgs doublets, H_1 and H_2 , of which one linear combination is relatively light, and plays the role of the SM Higgs, as illustrated in figure 17.

 Fig. 17. Light effective Higgs direction in the MSSM (in the limit where the A^0 is very heavy).

The stops come in two kinds, \tilde{t}_L and \tilde{t}_R , and have mass matrix

$$m_{\tilde{t}}^2 \cong \begin{pmatrix} m_Q^2 + y^2 H_2^2 & y(A_t^* H_2^* + \mu H_1) \\ y(A_t H_2 + \mu^* H_1^*) & m_U^2 + y^2 H_2^2 \end{pmatrix} \quad (5.30)$$

where m_Q^2 , m_U^2 and A_t are soft SUSY-breaking parameters. If we ignore the off-diagonal terms (possible if we choose $A_t \tan \beta = \mu$) it is easier to see what is happening—there are two unmixed bosons coupling to H . However, we cannot make both of them light. This is because m_H^2 gets major contributions from stops at 1 loop, from the diagrams shown in fig. 18.

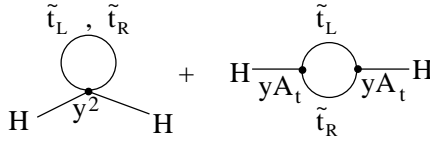

Fig. 18. Stop loop contributions to the Higgs mass.

These give

$$m_H^2 \cong m_Z^2 + c \frac{m_t^4}{v^2} \ln \left(\frac{m_{\tilde{t}_L} m_{\tilde{t}_R}}{m_t^2} \right) \quad (5.31)$$

If both \tilde{t}_L and \tilde{t}_R are light, it is impossible to make the Higgs heavy enough to satisfy the LEP constraint. Precision electroweak constraints dictate that \tilde{t}_L should be the heavy one. Otherwise corrections to the ρ parameter,

$$\Delta\rho = W \text{ (loop) } W - Z \text{ (loop) } Z$$

are too large, since \tilde{t}_L couples more strongly to W and Z than does \tilde{t}_R .

Although we have only discussed thermal field theory at one loop, two-loop effects are also important in the MSSM. The \tilde{t}_R diagrams

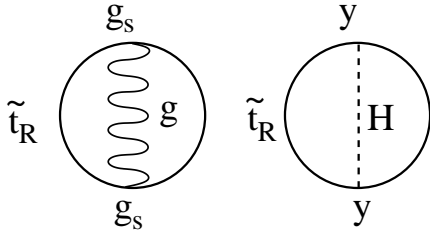

with gluon and Higgs exchange give a contribution of the form

$$\Delta V_{\text{eff}} = -cT^2 H^2 \ln \frac{H}{T} \quad (5.32)$$

which is different from any arising at one loop, and which shift the value of v_c/T_c

by

$$\frac{v_c}{T_c} = \frac{E}{2\sqrt{2}\lambda} + \sqrt{\frac{E^2}{8\lambda^2} + \frac{2c}{\lambda}} \quad (5.33)$$

Detailed studies of the strength of the phase transition have been done using dimensional reduction [41], two-loop perturbation theory (see for example [42]) and lattice gauge theory [43] which show that *negative* values of m_U^2 (the soft SUSY-breaking mass parameter for \tilde{t}_R) are required. This may seem strange; why would we want a cubic term of the form

$$\mathcal{L}_{\text{cubic}} \sim -\frac{T}{6\pi} (-|m_U^2| + y^2|H_2|^2)^{3/2} ? \quad (5.34)$$

To understand this, we must consider thermal corrections to the *squark* mass as well,

$$m_{\tilde{t}_R}^2 = -|m_U^2| + y^2|H_2|^2 + c_R T^2 \quad (5.35)$$

where $c_R = \frac{4}{9}g_s^2 + \frac{1}{6}y^2(1 + \sin^2\beta)$, which can be computed similarly to the thermal Higgs mass: one must calculate $V_{\text{eff}}(H, \tilde{t}_R)$. The insertion of 1-loop thermal masses into the cubic term corresponds to resumming a class of diagrams called daisies:

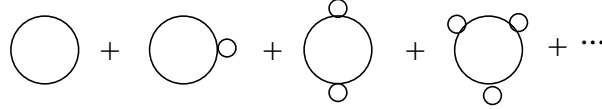

The most prominent effect for strengthening the phase transition comes when $-|m_U^2| + c_R T^2 \cong 0$. The negative values of m_U^2 correspond to a light stop, $m_{\tilde{t}_R} < 172$ GeV.

It is often said that a relatively light Higgs is also needed for a strong phase transition, but this is just an indirect effect of eq. (5.31). If we were willing to make m_Q arbitrarily heavy, we could push m_H to higher values. The relation is [42]

$$m_Q \cong 100 \text{ GeV} \exp \left[\frac{1}{9.2} \left(\frac{m_H}{\text{GeV}} - 85.9 \right) \right] \quad (5.36)$$

For example, for $m_H = 120$ GeV, $m_Q = 4$ TeV. This is unnaturally high since SUSY should be broken near the 100 GeV scale to avoid fine-tuning. And it looks strange to have $m_Q \gg |m_U|$.

The conclusion is that it is possible, but not natural, to get a strong enough phase transition in the MSSM. However it is easy in the NMSSM, which includes an additional singlet Higgs, with superpotential

$$W = \mu H_1 H_2 + \lambda S H_1 H_2 + \frac{k}{3} S^3 + r S \quad (5.37)$$

giving a potential

$$V = \sum_i \left| \frac{\partial W}{\partial H_i} \right|^2 + \left| \frac{\partial W}{\partial S} \right|^2 + \text{soft SUSY-breaking terms} \quad (5.38)$$

Ref. [44] finds large regions of parameter space where the phase transition is strong enough.

Similar studies have been done for the general 2-Higgs doublet model (2HDM) [45, 46], with

$$\begin{aligned} V = & -\mu_1^2 |H_1|^2 - \mu_2^2 |H_2|^2 - (\mu_3^2 H_1^\dagger H_2 + \text{h.c.}) + \frac{1}{2} \lambda_1 |H_1|^4 + \frac{1}{2} \lambda_2 |H_2|^4 \\ & + \lambda_3 |H_1|^2 |H_2|^2 + \lambda_4 |H_1^\dagger H_2|^2 + \frac{1}{2} \lambda_5 [(H_1^\dagger H_2)^2 + \text{h.c.}] \end{aligned} \quad (5.39)$$

There are several extra scalar degrees of freedom coupling to the light Higgs in this model, giving a large region of parameter space where the EWPT is strong.

A model-independent approach to increasing the strength of the EWPT has been presented in [47], where the effects of heavy particles interacting with the Higgs are parametrized by a low-energy effective potential,

$$V = \lambda \left(|H|^2 - \frac{v^2}{2} \right)^2 + \frac{1}{\Lambda^2} |H|^6 \quad (5.40)$$

It is found that $v/T > 1$ is satisfied in a sizeable region of parameter space, as roughly depicted in figure 19. This could provide another way of understanding the enhancement of the strength of the phase transition in models like the NMSSM or the 2HDM, in cases where the new particles coupling to H are not as light as one might have thought, based on the idea of increasing the cubic coupling.

6. A model of Electroweak Baryogenesis: 2HDM

Let us now go through a detailed example of how electroweak baryogenesis could work. The simplest example is the two Higgs doublet model, just mentioned in the previous section, where it is assumed that the top quark couples only to

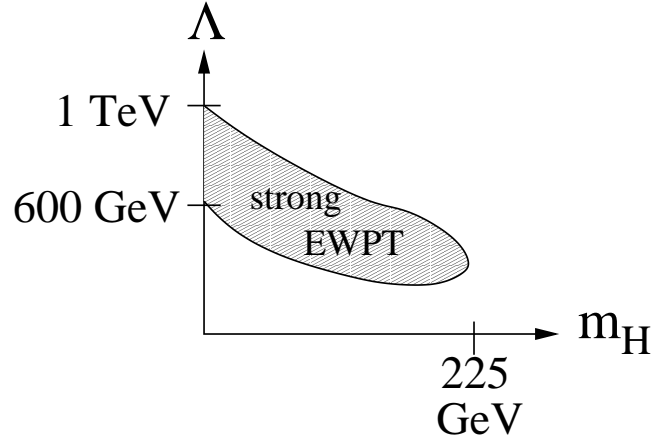

Fig. 19. Region of strong EWPT with a $|H|^6/\Lambda^2$ operator.

one of the Higgs fields. This assumption is useful for avoiding unwanted new contributions to flavor-changing neutral currents (FCNC's).

The basic idea is as follows. There are phases in the potential (5.39), in the complex parameters μ_3^2 and λ_5 . One of these can be removed by a field redefinition, leaving an invariant phase

$$\phi \equiv \arg \left(\frac{\mu_3^2}{\lambda_5^{1/2}} \right) \quad (6.1)$$

The bubble wall will be described by a Higgs field profile sketched in figure 20,

$$H_i(z) = \frac{1}{\sqrt{2}} h_i(z) e^{i\theta_i(z)} \quad (6.2)$$

where

$$\begin{aligned} h_i(z) &\cong \begin{pmatrix} \cos \beta \\ \sin \beta \end{pmatrix} h(z), \\ h(z) &\cong \frac{v_c}{2} \left(1 - \tanh \left(\frac{z}{L} \right) \right) \end{aligned} \quad (6.3)$$

This shape can be understood by considering the SM, where

$$\mathcal{L} = |\partial H|^2 - \lambda \left(|H|^2 - \frac{v^2}{2} \right)^2$$

$$E = \frac{1}{2}(\partial_z h)^2 + \begin{cases} \frac{\lambda}{4}(h^2 - v^2)^2 & \text{at } T = 0 \\ \frac{\lambda}{4}h^2(h - v_c)^2 & \text{at } T = T_c \end{cases} \quad (6.4)$$

At the critical temperature, the energy is minimized when

$$\partial_z^2 h = 2\lambda h(h - v_c)(2h - v_c) \quad (6.5)$$

Substituting the ansatz (6.3) for h into (6.5), one finds that it is a solution provided that

$$L = \frac{1}{\sqrt{\lambda v_c}} \sim \frac{1}{m_h} \quad (6.6)$$

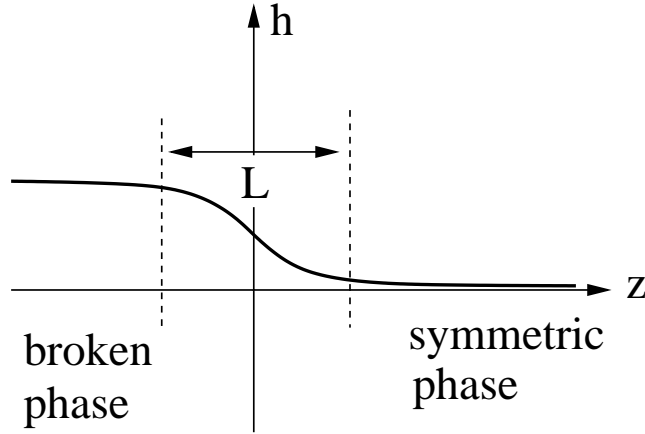

Fig. 20. Shape of Higgs field in the bubble wall.

We can also solve for the phases θ_i . In fact, only the difference

$$\theta = -\theta_1 + \theta_2 \quad (6.7)$$

appears in the potential (5.39), due to $U(1)_y$ gauge invariance; it can be rewritten as

$$\begin{aligned} V(h_1, h_2, \theta) &= -\frac{1}{2} \sum_i \mu_i^2 h_i^2 - \mu_3^2 \cos(\theta + \phi) h_1 h_2 \\ &= \frac{1}{8} \sum_i \lambda_i h_i^4 + \frac{1}{4} (\lambda_3 + \lambda_4 + \lambda_5 \cos 2\theta) h_1^2 h_2^2 \end{aligned} \quad (6.8)$$

where now all parameters are real, and the invariant CP phase ϕ has been shown explicitly. (Of course, we could move it into the λ_5 term if we wanted to, by shifting $\theta \rightarrow \theta - \phi$.) If $h_i = \begin{pmatrix} c_\beta \\ s_\beta \end{pmatrix} h$, then

$$\begin{aligned} c_\beta^2 \partial_z (h^2 \partial_z \theta_1) &= \frac{\partial V}{\partial \theta_1} \\ s_\beta^2 \partial_z (h^2 \partial_z \theta_2) &= \frac{\partial V}{\partial \theta_2} = -\frac{\partial V}{\partial \theta_1} \end{aligned} \quad (6.9)$$

and $c_\beta^2 \theta_1 + s_\beta^2 \theta_2 = 0$, while $\partial_z (h^2 \partial_z \theta) = (c_\beta^{-2} + s_\beta^{-2}) \frac{\partial V}{\partial \theta}$. These equations allow us to solve for θ_1 and θ_2 in the vicinity of the bubble wall. Notice that the trivial solution $\theta = \text{constant}$ is prevented if $\phi \neq 0$ since

$$\frac{\partial V}{\partial \theta} = \mu_3^2 h_1 h_2 \sin(\theta + \phi) - \frac{1}{2} \lambda_5 \sin 2\theta h_1^2 h_2^2 \quad (6.10)$$

vanishes at different values of θ depending on the value of z . In fact, as $z \rightarrow \infty$, $\theta \rightarrow -\phi$, while for $z \rightarrow -\infty$, θ approaches a different value due to the nonvanishing of the quartic term in the broken phase. This guarantees that there will be a nontrivial profile for θ as well as h in the bubble wall.

The result is a complex phase for the masses of the quarks inside the wall. Focusing on the top quark since it couples most strongly to the Higgs, this mass term is given by

$$\frac{y}{\sqrt{2}} h_2(z) \bar{t} e^{i\theta_2 \gamma_5} t = \frac{y}{\sqrt{2}} h_2(z) \bar{t} (\cos \theta + i \gamma_5 \sin \theta_2) t \quad (6.11)$$

This means that the propagation of the quark inside the wall will have CP violating effects. We can no longer remove θ_2 by a field redefinition, as we did in section 2, because θ_2 is a function of z , not just a constant. If we try to remove it using $t \rightarrow e^{-i\theta_2 \gamma_5 / 2} t$, although this removes θ_2 from the mass term, it also generates a new interaction from the kinetic term,

$$\bar{t} i \partial t \rightarrow \bar{t} i \partial t + \frac{1}{2} \bar{t} \partial \theta_2 \gamma_5 t \quad (6.12)$$

Any physics we derive must be the same using either description, but we will keep the phase in the mass term as this has a clearer interpretation.

Now let's consider the Dirac equation, which can be written with the help of the chiral projection operators $P_{L,R} = \frac{1}{2}(1 \mp \gamma_5)$ as

$$(i \partial - m P_L - m^* P_R) \psi = 0 \quad (6.13)$$

using the complex mass

$$m = \frac{y}{\sqrt{2}} h_2(z) e^{i\theta_2(z)} \quad (6.14)$$

Decompose the Dirac spinor into its chiral components as

$$\psi = e^{-iEt} \begin{pmatrix} R_s \\ L_s \end{pmatrix} \otimes \chi_s \quad (6.15)$$

where χ_s is a 2-component spinor and $s = \pm 1$ labels spin up and down along the direction of motion, which we can take to be \hat{z} . The Dirac equation becomes two coupled equations,

$$\begin{aligned} (E - is\partial_z)L_s &= mR_s \\ (E + is\partial_z)R_s &= m^*L_s \end{aligned} \quad (6.16)$$

These can be converted to uncoupled second-order equations,

$$\begin{aligned} \left[(E + is\partial_z) \frac{1}{m} (E - is\partial_z) \right] L_s &= 0 \\ \left[(E - is\partial_z) \frac{1}{m^*} (E + is\partial_z) \right] R_s &= 0 \end{aligned} \quad (6.17)$$

We see that the LH and RH components can propagate differently in the bubble wall—a signal of CP violation. We can think of it as quantum mechanical scattering,

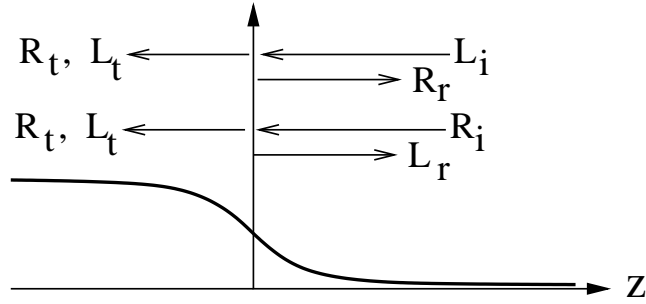

where left-handed components incident from the symmetric phase reflect into right-handed components and vice-versa. One can see that as $z \rightarrow \infty$, $m \rightarrow 0$, so it is consistent to have RH and LH components moving in opposite directions. On the broken-phase side of the wall, both components must be present because the mass mixes them.

However, quantum mechanical (QM) reflection is only a strong effect if the potential is sharp compared to the de Broglie wavelength. In our case,

$$\lambda \sim \frac{1}{3T}, \quad L \sim \frac{1}{m_h} \quad (6.18)$$

while for strong scattering we need

$$\frac{L}{\lambda} = \frac{3T}{m_h} < 1 \quad (6.19)$$

which is not true, except in low-energy part of the particle distribution functions. Thus only some low-momentum fraction of the quarks in the thermal plasma will experience significant QM scattering. However there is a classical effect which applies to the dominant momentum components with $p \sim 3T$: a CP-violating force. It can be deduced by solving the Dirac equation in the WKB approximation. Making the ansatz

$$L_s = A_s(z) e^{i \int^z p(z') dz' - iEt} \quad (6.20)$$

and substituting it into the equation of motion, we can solve for $p(z)$ in an expansion in derivatives of the background fields $|m(z)|$ and $\theta(z)$. This approach was pioneered in ref. [48] and refined in [49]. We find that the canonical momentum is given by

$$p(z) \cong p_0 + s_c \frac{sE \pm p_0}{2p_0} \theta' + O\left(\frac{d^2}{dz^2}\right) \quad (6.21)$$

where

$$p_0 = \text{sign } p \sqrt{E^2 - |m^2(z)|} \quad (6.22)$$

is the kinetic momentum, $s_c = +1$ (-1) for particles (antiparticles), and the \pm in (6.21) is $+$ for LH and $-$ for RH states—but it will be shown that this term has no physical significance.

The dispersion relation corresponding to (6.21) is

$$E = \sqrt{(p \pm s_c \theta'/2)^2 + |m|^2} - \frac{1}{2} s s_c \theta' \quad (6.23)$$

and the group velocity is

$$v_g = \left(\frac{\partial E}{\partial p}\right)_z = \frac{p_0}{E} \left(1 + s s_c \frac{|m|^2 \theta'}{2E^3}\right) \quad (6.24)$$

This is a physically meaningful result: particles with different spin or s_c are speeded up or slowed down due to the CP-violating effect. Notice that the effect

vanishes if $\theta' = 0$ or $m = 0$. Furthermore the effect of the $\pm\theta'/2$ term in (6.21) has dropped out, showing that indeed it is unphysical. It can be thought of as a being like a gauge transformation. One can understand this from the fact that it has no dependence on m . In the limit that $m \rightarrow 0$, the phase θ has no meaning, so any physical effects of θ must be accompanied by powers of m . The same can be said concerning derivatives of θ . We know that if θ is constant, it can be removed by a field redefinition, hence any physical effects can only depend on θ' or higher derivatives.

We can furthermore identify a CP-violating force which is responsible for the above effect. The Hamilton equation which gives the force is

$$\dot{p} = - \left(\frac{\partial E}{\partial z} \right)_p = - \frac{(m^2)^2}{2E} + s s_c \frac{(m^2 \theta)'}{2E^2} \quad (6.25)$$

The first term on the r.h.s. is the CP-conserving force due to the spatial variation of the mass, while the second term is the CP-violating force. This is the main result which allows us to compute the baryon asymmetry, since \dot{p} appears in the Boltzmann equation,

$$\frac{\partial f}{\partial t} + \frac{p}{m} \frac{\partial f}{\partial z} + \dot{p} \frac{\partial f}{\partial p} = \text{collision terms} \quad (6.26)$$

To set up the Boltzmann equations we make an ansatz for the distribution function of particle species i , in the rest frame of the bubble wall,

$$f_i = \frac{1}{e^{\beta(\gamma(E_i + v_w p_z) - \mu_i)} \pm 1} + \delta f_i \quad (6.27)$$

which can be understood as follows. $\gamma(E_i + v_w p_z)$ is the Lorentz transformation of the energy when we go to the rest frame of the wall, which is moving at speed v_w , and μ_i is the chemical potential. The first term in (6.27) tells us about the departure from chemical equilibrium induced by the CP violating force, while the term δf_i is included to parametrize the departure from kinetic equilibrium. We are free to impose the constraint

$$\int d^3x \delta f_i = 0 \quad (6.28)$$

since μ_i already accounts for the change in the overall normalization of f_i .

The idea is to make a perturbative expansion where

$$\mu_i \sim \delta f_i \sim m^2 \theta' \quad (6.29)$$

We will thus linearize the Boltzmann equations in μ_i and δf_i , and take the differences between particles and antiparticles. The next step is to make a truncation of the full Boltzmann equations (BE) by taking the first two moments,

$$\int d^3p (BE) \quad \text{and} \quad \int d^3p p_z (BE) \quad (6.30)$$

The reason for taking two moments is that we have two functions to determine, $\mu(t, z)$ and $\delta f(t, z)$; a more accurate treatment would involve more parameters in the ansatz for the distribution functions and taking higher moments of the BE. In any case, the truncation is necessary because the full BE is an integro-differential equation, which we do not know how to solve, whereas the moments are conventional first-order PDE's. Moreover in the rest frame of the wall, the equations no longer depend on time and therefore become ODE's. We can solve for δf in terms of μ and further convert the coupled first-order ODE's into uncoupled second-order ODE's for the chemical potentials. These are known as diffusion equations, and they have the form

$$- (D_i \xi_i'' + v_w \xi_i') + \sum_k \Gamma_k (\pm \xi_i \pm \xi_j \pm \dots) + \dots = S_i \quad (6.31)$$

where D_i is the diffusion constant, defined in terms of the total scattering rate Γ_i for particle i (in the thermal plasma) as

$$D_i = \frac{\langle v_z^2 \rangle}{\Gamma_i} \quad (6.32)$$

with the thermal average $\langle \cdot \rangle$ applied to the z -component of the particle's squared velocity; v_w is the wall velocity, usually in the range 0.1 – 0.01 depending on details of the model; ξ_i is the rescaled chemical potential

$$\xi_i = \frac{\mu_i(z)}{T} \quad (6.33)$$

related to the particle densities by

$$n_i - n_{\bar{i}} = \frac{T^3}{6} \xi \begin{cases} 1, & \text{fermions} \\ 2, & \text{bosons} \end{cases} \quad (6.34)$$

and Γ_k is the k th reaction rate for particle in which the particle i is either produced or consumed—for example, if $i + j \rightarrow l + m$, then we would write $\Gamma_k(\xi_l + \xi_m - \xi_i - \xi_j)$; and S_i is the source term due to the CP violating force, which turns out to be

$$S_i \cong \frac{v_w D_i}{\langle v_z^2 \rangle T} \left\langle v_z \frac{(m^2 \theta')'}{2E^2} \right\rangle' \quad (6.35)$$

The source term has an asymmetric shape similar to figure 21, when $m(z)$ and $\theta(z)$ have kink-like profiles.

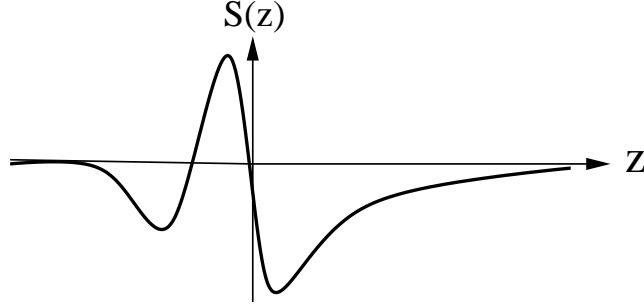

Fig. 21. Typical shape of source term in diffusion equation.

We can solve the diffusion equation using Green's functions,

$$\left(D \frac{d^2}{dz^2} + v_w \frac{d}{dz} + \Gamma \right) G(z - z_0) = \delta(z - z_0) \quad (6.36)$$

where

$$G(x) = \frac{D^{-1}}{k_+ - k_-} \begin{cases} e^{-k_+ x}, & x > 0, \\ e^{-k_- x}, & x < 0 \end{cases} \quad (6.37)$$

$$k_{\pm} = \frac{v_w}{2D} \left(1 \pm \sqrt{1 + \frac{2\Gamma D}{3v_w^2}} \right)$$

so

$$\xi(z) = \int_{-\infty}^{\infty} dz_0 G(z - z_0) S(z_0) \quad (6.38)$$

This tells us the asymmetry in one helicity of t quarks, say (+), which must be equal and opposite to that for the other helicity (-). So far we have calculated the CP asymmetry near the wall. It has a shape similar to that shown in figure 22.

The final step is to compute the baryon asymmetry. Since the q_L asymmetry biases sphalerons, we get

$$\frac{dn_B}{dt} \sim 3\Gamma_{\text{sph}}\xi - c\Gamma_{\text{sph}}\frac{n_B}{T^2} \quad (6.39)$$

where $3\Gamma_{\text{sph}}\xi$ is the term which causes the initial conversion of the CP asymmetry into a baryon asymmetry, and $-c\Gamma_{\text{sph}}n_B/T^2$ is the washout term, which

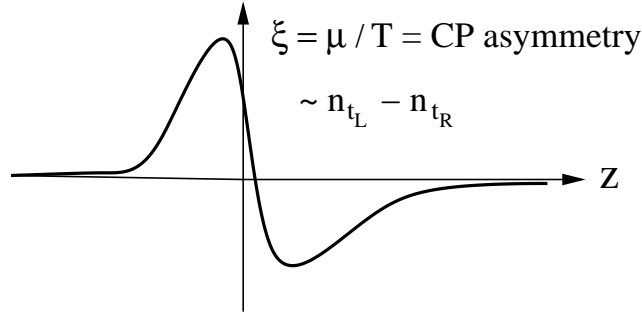

Fig. 22. Typical shape of the CP asymmetry from solving the diffusion equations.

would eventually relax B to zero if sphalerons did not go out of equilibrium inside the bubbles. In this equation, we should think of Γ_{sph} as being a function of t and z , which at any given position z abruptly decreases at the time t when the wall passes z , so the position of interest goes from being in the symmetric phase to being in the broken phase. (The constant c is approximately 10.) In the approximation that the sphaleron rate is zero in the broken phase, and ignoring the washout term, we should integrate (6.39) at a given point in space until the moment t_w when the wall passes. Trading the time integral for an integral over z , we get

$$n_B = \int_{-\infty}^{t_w} dt \frac{dn_B}{dt} = \int_0^{\infty} dz \frac{1}{\dot{z}} \frac{dn_B}{dt} = \frac{3\Gamma_{\text{sph}}}{v_w} \int_0^{\infty} \xi(z) \quad (6.40)$$

This can be generalized to the case where the washout term is not ignored, giving an additional factor $e^{-z(c/v_w)(\Gamma_{\text{sph}}/T^2)}$ in the integrand. The entire analysis for the 2HDM has been carried out in [46].

The above derivation of the transport equations gives a clear intuitive picture of the physics, but more rigorous treatments have been given in [50].

6.1. EDM constraints

An interesting experimental prediction is that CP violation in EWBG should also lead to an observable EDM for the neutron and perhaps other particles. One needs the invariant CP phase ϕ to be in the range $10^{-2} - 1$ for sufficient baryogenesis, which leads to mixing between CP-even and odd Higgs bosons (scalars and pseudoscalars). Weinberg [51] notes that if any of the propagators $\langle H_2^+ H_1^{+*} \rangle$, $\langle H_2^+ H_1^{+*} \rangle$, $\langle H_2^+ H_1^{+*} \rangle$, $\langle H_2^+ H_1^{+*} \rangle$ have imaginary parts then CP is violated, giving rise to quark EDM's at one loop, through the diagram

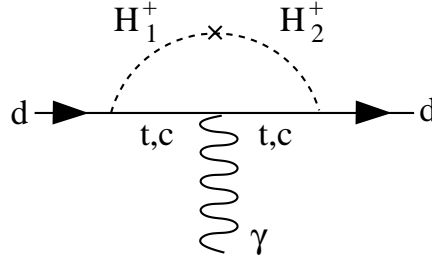

The CP-violating propagators occur because the invariant phase ϕ appears in the mass matrix of the Higgs bosons. However this diagram with charged scalars requires 3 or more Higgs doublets since one of the charged fields is a Goldstone boson, and can be set to zero by going to unitary gauge. A similar diagram with neutral Higgs exchange could work, but it is suppressed for the relevant quarks (u and d , which are valence quarks of the neutron) because the Yukawa couplings are small. Moreover we should avoid coupling H_1 and H_2 to the same flavor of quarks because this tends to give large FCNC contributions.

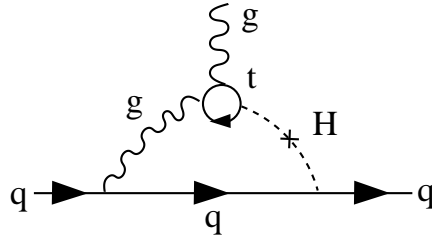

Fig. 23. The Barr-Zee [53] contribution to the neutron EDM.

It was realized that two-loop diagrams give the largest contribution (see [52], following work of [53]), which look like figure 23, where the cross on the Higgs line is the CP-violating mass insertion. These contribute to the *chromoelectric* dipole moment of the quark,

$$\text{CEDM} = -\frac{i}{2} g_q^g \bar{q} \sigma_{\mu\nu} \gamma_5 G^{\mu\nu} q \quad (6.41)$$

where $G^{\mu\nu}$ is the gluon field strength. The quark CEDM's in turn contribute to the neutron EDM

$$d_n = (1 \pm 0.5)(0.55e d_u^g + 1.1e d_d^g) + O(d_u^r, d_d^r) \quad (6.42)$$

where the factor (1 ± 0.5) is due to hadronic uncertainties. There are various ways of estimating the quark contribution to the neutron EDM; (6.42) uses QCD sum rules. See [54] for a review.

Ref. [46] finds that the experimental limit on d_n is close to being saturated for values of ϕ which give enough baryogenesis: $d_n = (1.2 - 2.2) \times 10^{-26} e \text{ cm}$, which should be compared to the experimental limit $|d_n| < 3 \times 10^{-26} e \text{ cm}$.

There are extra Higgs particles with masses $\sim 300 \text{ GeV}$ whose strong couplings to the light Higgs give rise to a first order phase transition, as we have discussed in the previous section. These are not CP eigenstates, so they have interactions which could distinguish them from the Higgs sector of the MSSM.

7. EWBG in the MSSM

We have already discussed how a light \tilde{t}_R can give a strongly first order EWPT in the MSSM. But what is the mechanism for baryogenesis? We cannot use the same one as in the 2HDM because in the MSSM, the Higgs Lagrangian has no $(H_1^\dagger H_2)^2$ coupling at tree level. Although such a coupling is generated at one loop, its coefficient is too small to get enough baryon production.

The principal mechanism which has been considered is chargino-wino reflection at the bubble wall. The first computation of this effect using the WKB approach, described in the previous section, was done by ref. [55]. (For earlier approaches, based on quantum mechanical scattering or the quantum Boltzmann equation, see [56] or [57], respectively.) The WKB method has been carefully scrutinized and verified by [44] and a number of other papers [58]. Charginos/winos have a 2×2 Dirac mass term

$$\left(\overline{\widetilde{W}_R^+}, \overline{\tilde{h}_{1,R}^+} \right) \begin{pmatrix} \tilde{m}_2 & gH_2(z) \\ gH_1(z) & \mu \end{pmatrix} \begin{pmatrix} \widetilde{W}_L^+ \\ \tilde{h}_{2,L}^+ \end{pmatrix} + \text{h.c.} \quad (7.1)$$

where μ and \tilde{m}_2 are complex. Denoting the 2×2 Dirac mass matrix by \mathcal{M} , we diagonalize \mathcal{M} locally in the bubble wall using a z -dependent similarity transformation

$$U^\dagger \mathcal{M} V = \begin{pmatrix} m_+ e^{i\theta_+(z)} & \\ & m_- e^{i\theta_-(z)} \end{pmatrix} \quad (7.2)$$

so similarly to the top quark in the 2HDM, charginos and winos experience a CP-violating force in the wall, where

$$m_\pm^2 \partial_z \theta_\pm = \pm g^2 \frac{\text{Im}(\tilde{m}_2 \mu)}{m_+^2 - m_-^2} \frac{\partial}{\partial z} (H_1(z) H_2(z)) \quad (7.3)$$

However the resulting chiral asymmetry in \tilde{h} or \widetilde{W} does not have a direct effect on sphalerons. Instead, we must take into account decays and scatterings such as

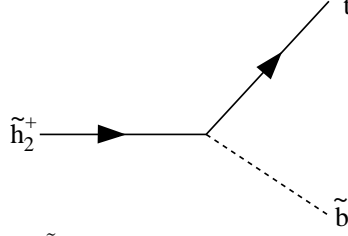

which transfer part of the \tilde{h} CP asymmetry into quarks. One must solve the coupled Boltzmann equations for all the species to find the quark CP asymmetry which biases sphalerons.

Because of the indirectness of the effect, baryon generation is less efficient in the MSSM than in the 2HDM. The effect is largest when $m_+^2 \cong m_-^2$, which happens when $m_2 \cong \mu$, as shown in figure 24, taken from [59]. The figure shows the contours of η in the plane of μ and \tilde{m}_2 , with the LEP limit on the chargino mass superimposed, $m_{\chi^\pm} > 104$ GeV. This figure was prepared before the WMAP determination of η , at which time the preferred value was 3×10^{-10} . Hence the contours only go up to 5×10^{-10} in the LEP-allowed region. It is possible to choose other values of the MSSM parameters to slightly increase the baryon asymmetry to the measured value; for example taking $\tan \beta \lesssim 3$ helps, and assuming a wall thickness (which we have not tried to compute carefully, but is only parametrized) $L \sim 6/T$ increases η . The conclusion is that all relevant parameters, $\arg(\tilde{m}_2 \mu)$, v_w , L , $\tan \beta$, must be at their optimal values to get a large enough baryon asymmetry. The MSSM is nearly ruled out for baryogenesis.

In fact some additional tuning is required since the large CP-violating phases which are needed would lead to large EDM's through the diagram

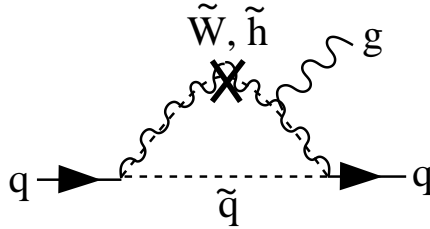

If the squark \tilde{q} is light, the invariant phase (which we can refer to as the phase of μ) must be small, $\theta_\mu \lesssim 10^{-2}$, whereas we need $\theta_\mu \sim 1$. To suppress the EDM's it is necessary to take the squarks masses in the range $m_{\tilde{q}} \gtrsim$ TeV. Roughly, the bound goes like [54]

$$\theta_\mu \left(\frac{1 \text{ TeV}}{m_{\tilde{q}}} \right)^2 < 1 \quad (7.4)$$

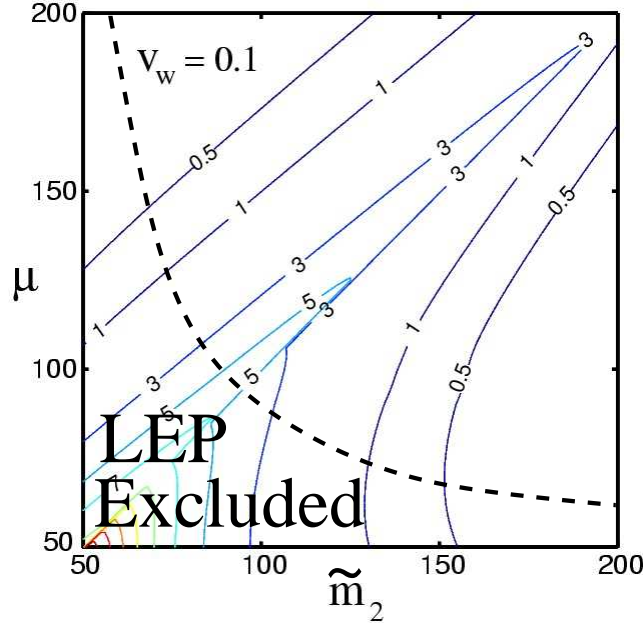

Fig. 24. Contours of constant $\eta \times 10^{10}$ from baryogenesis in the MSSM.

In more detail, [60] finds a bound of $m_{\tilde{q}} > 3$ TeV from the EDM of Hg, if θ_μ is maximal, as shown in figure 25. This does not conflict with the need to keep \tilde{b}_R light because we only need to make d_u^g and d_d^g (the CEDM's of the valence quarks of the neutron) small, while the CEDM's of higher generation quarks might be large.

Assuming heavy first and second generation squarks, the largest contribution to EDM's can come from two-loop diagrams of the Barr-Zee type (figure 23), where the top loop is replaced by a chargino loop [61]. This contribution does not decouple when the squarks are heavy, and it gives stringent constraints on EWBG in the MSSM through the electron EDM. A heavy charged Higgs is needed to suppress this diagram enough to allow for maximal CP violation in the μ parameter.

However we can loosen the constraints on the MSSM by adding a singlet Higgs field S with the superpotential (5.37) and potential (5.38), where the soft SUSY-breaking terms include CP violating terms of the form $\lambda A S H_1 H_2$ and $k A S^3$. This model has much more flexibility to get a strong EWPT and large CP violation [44]. We no longer need 1-loop effects to generate cubic terms

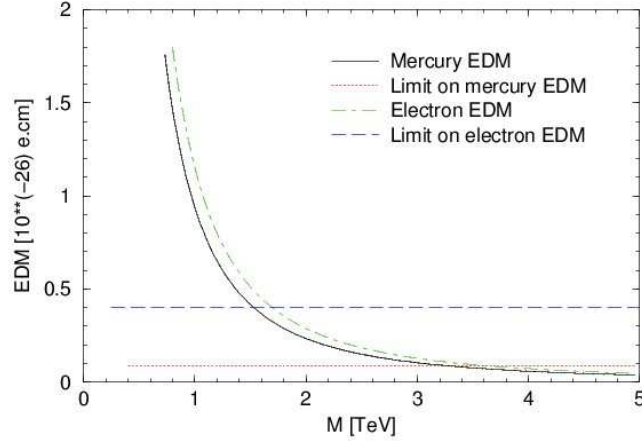

Fig. 25. Bound on squark masses from EDM's assuming maximal phase in the μ parameter, from [60].

in the Higgs potential; already at tree level there are cubic terms $H_1 H_2 S$ and S^3 . If S participates in the EWPT by getting a VEV, these cubic terms help to strengthen the phase transition, and it is possible to have $v_c/T_c > 1$ even with heavy Higgses.

The NMSSM also provides many new CP-violating phases in the Higgs potential due to complex couplings k , μ and A_k , and the model works similarly to the 2HDM, generating a CP asymmetry directly in the top quark.

8. Other mechanisms; Leptogenesis

Unfortunately there was not enough time to cover other interesting ideas for baryogenesis, including the very elegant idea of Affleck and Dine which makes use of flat directions in supersymmetric models to generate baryon number very efficiently [62].

A very popular mechanism for baryogenesis today is leptogenesis, invented by Fukugita and Yanagida in 1986 [63]; see [64] for a recent review. I am not able to do justice to the subject here, but it deserves mention. Leptogenesis is a very natural mechanism, which ties in with currently observed properties of neutrinos; hence its popularity. Unfortunately, the simplest versions of leptogenesis occur at untestably high energies, similar to GUT baryogenesis. Although it is possible to bring leptogenesis down to the TeV scale [65], it requires a corresponding

decrease in Yukawa couplings which renders the theory still untestable by direct laboratory probes.

In leptogenesis, the first step is to create a lepton asymmetry, which can be done without violating electric charge neutrality of the universe since the asymmetry can initially reside in neutrinos. We know however that sphalerons violate $B + L$, while conserving $B - L$. Therefore, an excess in L will bias sphalerons to produce baryon number, just as an excess in left-handed B did within electroweak baryogenesis. Roughly, we can expect that any initial asymmetry L_i in L will be converted by sphalerons into a final asymmetry in B and L given by

$$B_f \sim -\frac{1}{2}L_i, \quad L_f \sim \frac{1}{2}L_i \quad (8.1)$$

This estimate is not bad. A more detailed analysis gives [24, 66]

$$B_f = -L_i \left\{ \begin{array}{l} \frac{28}{79}, \text{ SM} \\ \frac{8}{23}, \text{ MSSM} \end{array} \right\} \sim -\frac{1}{3}L_i \quad (8.2)$$

since sphalerons couple to $B_L + L_L$ and we must consider the conditions of thermal equilibrium between all species.

Leptogenesis is conceptually very similar to GUT baryogenesis, but it relies on the decays of heavy (Majorana) right-handed neutrinos, through the diagrams

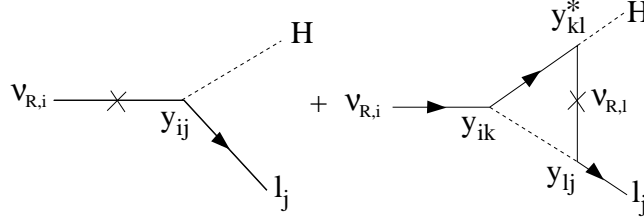

The cross represents an insertion of the L -violating heavy neutrino Majorana mass, which makes it impossible to assign a lepton number to ν_R , and hence makes the decay diagram L -violating. The principles are the same as in GUT baryogenesis. Physically this is a highly motivated theory because (1) heavy ν_R are needed to explain the observed ν_L masses, and (2) ν_R 's are predicted by SO(10) GUT's.

The first point is well-known; it is the seesaw mechanism, based on the neutrino mass terms

$$y_{ij}\bar{\nu}_{R,i}HL_j + \text{h.c.} - \frac{1}{2}(M_{ij}\bar{\nu}_{R,i}^c\nu_{R,j} + \text{h.c.}) \quad (8.3)$$

When the Higgs gets its VEV, the mass matrix in the basis ν_L and ν_R is

$$\begin{pmatrix} 0 & m_D \\ m_D^T & M \end{pmatrix} \quad (8.4)$$

where the Dirac mass matrix is $(m_D)_{ij} = vy_{ij}$ (and we must take the complex conjugate of (8.3) to get the mass matrix for the conjugate fields ν_R^c, ν_L^c). This can be partially diagonalized to the form

$$\begin{pmatrix} -m_D M^{-1} m_D^T & 0 \\ 0 & M \end{pmatrix} \quad (8.5)$$

so the light neutrino masses are $O(m_D^2/M) \sim y^2 v^2/M$. More exactly, they are the eigenvalues of the matrix $v^2(yM^{-1}y^T)_{ij}$, up to phases. We can estimate the size of the ν_R mass scale:

$$M \sim \frac{y^2 v^2}{m_\nu} \sim y^2 \times 10^{14} \text{ GeV} \quad (8.6)$$

where we used the tau neutrino mass, $m_\nu = 0.05 \text{ eV}$, as measured through atmospheric neutrino mixing. Since y can be small, it is possible to make M smaller than the gravitino bound on the reheat temperature after inflation.

It is usually assumed that there is a hierarchy such that $M_1 \ll M_2, M_3$, since this simplifies the calculations, and it seems like a natural assumption. Then $\nu_{R,1}$ is the last heavy neutrino to decay out of equilibrium, and it requires the lowest reheat temperature to be originally brought into equilibrium.

To find the lepton asymmetry, we need the dimensionless measure of CP violation

$$\epsilon_1 = \frac{|\mathcal{M}_{\nu_{R,1} \rightarrow lH}|^2 - |\mathcal{M}_{\nu_{R,1} \rightarrow \bar{l}\bar{H}}|^2}{|\mathcal{M}_{\nu_{R,1} \rightarrow \text{anything}}|^2} = -\frac{3}{16\pi} \sum_i \frac{\text{Im}(y^\dagger y)_{i1}^2}{(y^\dagger y)_{11}} \frac{M_1}{M_i} \quad (8.7)$$

It can be shown that ϵ_1 has a maximum value of $\frac{3}{16\pi} \frac{M_1 m_3}{v^2}$.

The baryon asymmetry can be expressed as

$$\eta = 10^{-2} \epsilon_1 \kappa \quad (8.8)$$

where κ is the efficiency factor, which takes into account the washout processes

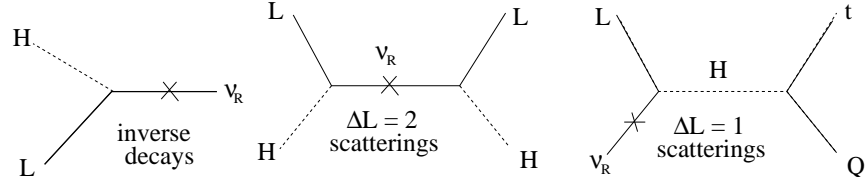

It is interesting that leptogenesis can be related to the measured neutrino masses. The rate of heavy neutrino decays is given by

$$\Gamma_D = \frac{\tilde{m}_1 M_1^2}{8\pi v^2} \quad (8.9)$$

where

$$\tilde{m}_1 = \frac{(m_D^\dagger m_D)_{11}}{M_1} \quad (8.10)$$

is an ‘‘effective’’ neutrino mass; it is not directly related to the neutrino mass eigenvalues (which requires the transpose of m_D instead of the Hermitian conjugate, and also (8.10) is a matrix element rather than an eigenvalue), though it should be of the same order as the light neutrino masses. It can be shown that $m_1 < \tilde{m}_1 < m_3$, and that the condition for M_1 to decay out of equilibrium is satisfied if

$$\tilde{m}_1 < m_* \equiv \frac{16\pi^{5/2}}{2\sqrt{5}} \frac{v^2}{M_p} = 1.1 \times 10^{-3} \text{eV} \quad (8.11)$$

The ratio \tilde{m}_1/m_* enters into the efficiency factor κ , and for $\tilde{m}_1 > m_*$,

$$\kappa \cong 2 \times 10^{-2} \left(\frac{0.01 \text{eV}}{\tilde{m}_1} \right) \quad (8.12)$$

Another interesting connection to the neutrino masses comes through the $\Delta L = 2$ scattering diagram, whose rate does relate to the actual light masses,

$$\Gamma_{\Delta L=2} = \frac{T^3}{\pi^2 v^4} \sum_{i=e,\mu,\tau} m_{\nu_i}^2 \equiv \frac{T^3}{\pi^2 v^4} \bar{m}^2 \quad (8.13)$$

There is a bound on the r.m.s. neutrino mass from leptogenesis, due to this washout process,

$$\bar{m} \lesssim 0.3 \text{eV} \quad (8.14)$$

which intriguingly is consistent with and close to the bound on the sum of the neutrino masses from the CMB (see for example [67]).

It is also possible to derive a lower bound on the lightest right-handed neutrino mass, $M_1 > 2 \times 10^9 \text{GeV}$, assuming maximum value of the efficiency factor [68]. This follows from expressing the maximum value of ϵ_1 in the form

$$\epsilon_1^{\text{max}} < \frac{3}{16\pi} \frac{M_1}{v^2} \left(\frac{\Delta m_{\text{atm}}^2 + \Delta m_{\text{sol}}^2}{m_3} \right) \quad (8.15)$$

and using $\Delta m_{\text{atm}}^2 = 2.5 \times 10^{-3} \text{ eV}^2$, $m_3 \geq \Delta m_{\text{atm}}^2$.

These results which are consistent with the known neutrino masses (and marginally consistent with the gravitino bound) are suggestive that leptogenesis could indeed be the right theory. Unfortunately, there is no way to find out for sure through independent laboratory probes of the particle physics, as we hope to do in electroweak baryogenesis. On the other hand, it is much easier to quantitatively predict the baryon asymmetry in leptogenesis than in electroweak baryogenesis; the Boltzmann equations are much simpler. One need only solve two coupled equations, for the heavy decaying neutrino density, and the produced lepton number,

$$\begin{aligned} \frac{dN_{N_1}}{dz} &= -(D + S) (N_{N_1} - N_{N_1}^{\text{eq}}) \\ \frac{dL}{dz} &= -\epsilon_1 D (N_{N_1} - N_{N_1}^{\text{eq}}) - WL \end{aligned} \quad (8.16)$$

where $z = M_1/T$, D stands for the rate of decay and inverse decay, S is the rate of $\Delta = 1$ scatterings (which can also produce part of the lepton asymmetry), and W is the washout terms which includes $\Delta L = 2$ scatterings; see [69]. Care must be taken when defining the s -channel $\Delta L = 2$ processes which contribute to the washout because when the exchanged heavy neutrino goes on shell, these are the same as inverse decays followed by decays, which have been separately counted; see [70].

Acknowledgment. I thank the organizers and students of Les Houches for a very enjoyable and stimulating week. Thanks to S. Dimopoulos, S. Huber, and S. Weinberg for useful information while preparing these lectures, and to R. Cyburt for providing figure 1. I am grateful to B. Grzadkowski, A. Pilaftsis, P. Mathews, S. Menary, M. Schmidt, A. Strumia and H. Yamashita for pointing out corrections and improvements to the manuscript. I also thank K. Kainulainen for many years of productive collaboration on this subject.

References

- [1] Particle Data Group, http://pdg.lbl.gov/2006/reviews/contents_sports.html#astroetc
- [2] R. H. Cyburt, “Primordial Nucleosynthesis for the New Cosmology: Determining Uncertainties and Examining Concordance,” *Phys. Rev. D* **70**, 023505 (2004) [arXiv:astro-ph/0401091].
- [3] W. Hu and S. Dodelson, “Cosmic Microwave Background Anisotropies,” *Ann. Rev. Astron. Astrophys.* **40**, 171 (2002) [arXiv:astro-ph/0110414].
- [4] E. W. Kolb and M. S. Turner, “The Early universe,” *Front. Phys.* **69**, 1 (1990).
- [5] A. D. Sakharov, “Violation of CP Invariance, C Asymmetry, and Baryon Asymmetry of the Universe,” *Pisma Zh. Eksp. Teor. Fiz.* **5**, 32 (1967) [*JETP Lett.* **5**, 24 (1967 SOPUA,34,392-393.1991 UFNAA,161,61-64.1991)].

- [6] S. M. Barr, "Comments On Unitarity And The Possible Origins Of The Baryon Asymmetry Of The Universe," *Phys. Rev. D* **19**, 3803 (1979).
- [7] C. A. Baker *et al.*, "An improved experimental limit on the electric dipole moment of the neutron," arXiv:hep-ex/0602020;
- [8] R. J. Crewther, P. Di Vecchia, G. Veneziano and E. Witten, "Chiral Estimate Of The Electric Dipole Moment Of The Neutron In Quantum Chromodynamics," *Phys. Lett. B* **88**, 123 (1979) [Erratum-ibid. *B* **91**, 487 (1980)].
- [9] B. C. Regan, E. D. Commins, C. J. Schmidt and D. DeMille, "New limit on the electron electric dipole moment," *Phys. Rev. Lett.* **88**, 071805 (2002).
- [10] M. V. Romalis, W. C. Griffith, J. P. Jacobs and E. N. Fortson, "New limits on CP violation from a search for a permanent electric dipole moment of Hg-199," *Prepared for International Nuclear Physics Conference (INPC 2001): Nuclear Physics and the 21st Century, Berkeley, California, 30 Jul - 3 Aug 2001*
- [11] M. Yoshimura, "Unified Gauge Theories And The Baryon Number Of The Universe," *Phys. Rev. Lett.* **41**, 281 (1978) [Erratum-ibid. **42**, 746 (1979)].
- [12] D. Toussaint, S. B. Treiman, F. Wilczek and A. Zee, "Matter - Antimatter Accounting, Thermodynamics, And Black Hole Radiation," *Phys. Rev. D* **19**, 1036 (1979).
- [13] S. Dimopoulos and L. Susskind, "Baryon Asymmetry In The Very Early Universe," *Phys. Lett. B* **81**, 416 (1979); "On The Baryon Number Of The Universe," *Phys. Rev. D* **18**, 4500 (1978)
- [14] S. Weinberg, "Cosmological Production Of Baryons," *Phys. Rev. Lett.* **42**, 850 (1979).
- [15] M. Yoshimura, "Origin Of Cosmological Baryon Asymmetry," *Phys. Lett. B* **88**, 294 (1979).
- [16] A. Y. Ignatiev, N. V. Krasnikov, V. A. Kuzmin and A. N. Tavkhelidze, "Universal CP Noninvariant Superweak Interaction And Baryon Asymmetry Of The Universe," *Phys. Lett. B* **76**, 436 (1978).
- [17] D. V. Nanopoulos and S. Weinberg, "Mechanisms For Cosmological Baryon Production," *Phys. Rev. D* **20**, 2484 (1979).
- [18] E. W. Kolb and S. Wolfram, "The Development Of Baryon Asymmetry In The Early Universe," *Phys. Lett. B* **91**, 217 (1980). "Baryon Number Generation In The Early Universe," *Nucl. Phys. B* **172**, 224 (1980) [Erratum-ibid. *B* **195**, 542 (1982)].
- [19] G. 't Hooft, "Symmetry breaking through Bell-Jackiw anomalies," *Phys. Rev. Lett.* **37**, 8 (1976).
- [20] F. R. Klinkhamer and N. S. Manton, "A Saddle Point Solution In The Weinberg-Salam Theory," *Phys. Rev. D* **30**, 2212 (1984).
- [21] P. Arnold and L. D. McLerran, "Sphalerons, Small Fluctuations And Baryon Number Violation In Electroweak Theory," *Phys. Rev. D* **36**, 581 (1987); "The Sphaleron Strikes Back,"
- [22] M. Laine and K. Rummukainen, *Phys. Rev. Lett.* **80**, 5259 (1998) [arXiv:hep-ph/9804255]. *Phys. Rev. D* **37**, 1020 (1988).
- [23] V. A. Kuzmin, V. A. Rubakov and M. E. Shaposhnikov, "On The Anomalous Electroweak Baryon Number Nonconservation In The Early Universe," *Phys. Lett. B* **155**, 36 (1985).
- [24] S. Y. Khlebnikov and M. E. Shaposhnikov, "The Statistical Theory of Anomalous Fermion Number Nonconservation," *Nucl. Phys. B* **308**, 885 (1988).
- [25] G.D. Moore, private communication
- [26] P. Arnold, D. Son and L. G. Yaffe, "The hot baryon violation rate is $O(\alpha_w^5 T^4)$," *Phys. Rev. D* **55**, 6264 (1997) [arXiv:hep-ph/9609481].
- [27] G. D. Moore, C. r. Hu and B. Muller, "Chern-Simons number diffusion with hard thermal loops," *Phys. Rev. D* **58**, 045001 (1998) [arXiv:hep-ph/9710436].

- [28] D. Bodeker, G. D. Moore and K. Rummukainen, “Chern-Simons number diffusion and hard thermal loops on the lattice,” *Phys. Rev. D* **61**, 056003 (2000) [arXiv:hep-ph/9907545].
- [29] C. Jarlskog, “Commutator Of The Quark Mass Matrices In The Standard Electroweak Model And A Measure Of Maximal CP Violation,” *Phys. Rev. Lett.* **55**, 1039 (1985); “A Basis Independent Formulation Of The Connection Between Quark Mass Matrices, CP Violation And Experiment,” *Z. Phys. C* **29**, 491 (1985).
- [30] G. R. Farrar and M. E. Shaposhnikov, “Baryon Asymmetry Of The Universe In The Standard Electroweak Theory,” *Phys. Rev. D* **50**, 774 (1994) [arXiv:hep-ph/9305275].
- [31] M. B. Gavela, P. Hernandez, J. Orloff and O. Pene, “Standard model CP violation and baryon asymmetry,” *Mod. Phys. Lett. A* **9**, 795 (1994) [arXiv:hep-ph/9312215].
- [32] A. G. Cohen, D. B. Kaplan and A. E. Nelson, “Weak Scale Baryogenesis,” *Phys. Lett. B* **245**, 561 (1990); “Baryogenesis at the weak phase transition,” *Nucl. Phys. B* **349**, 727 (1991).
- [33] G. D. Moore, “Computing the strong sphaleron rate,” *Phys. Lett. B* **412**, 359 (1997) [arXiv:hep-ph/9705248].
- [34] J. I. Kapusta and P. V. Landshoff, “Finite Temperature Field Theory” *J. Phys. G* **15**, 267 (1989).
- [35] M. E. Shaposhnikov, “Possible Appearance of the Baryon Asymmetry of the Universe in an Electroweak Theory,” *JETP Lett.* **44**, 465 (1986) [*Pisma Zh. Eksp. Teor. Fiz.* **44**, 364 (1986)]; “Baryon Asymmetry of the Universe in Standard Electroweak Theory,” *Nucl. Phys. B* **287**, 757 (1987).
- [36] A. I. Bochkarev and M. E. Shaposhnikov, “Electroweak Production Of Baryon Asymmetry And Upper Bounds On The Higgs And Top Masses,” *Mod. Phys. Lett. A* **2**, 417 (1987).
- [37] P. Arnold, “The Electroweak phase transition: Part 1. Review of perturbative methods,” arXiv:hep-ph/9410294.
- [38] K. Kajantie, M. Laine, K. Rummukainen and M. E. Shaposhnikov, “Is there a hot electroweak phase transition at $m(H) > \text{approx. } m(W)?$,” *Phys. Rev. Lett.* **77**, 2887 (1996) [arXiv:hep-ph/9605288]; “The universality class of the electroweak theory,” *Nucl. Phys. B* **532**, 283 (1998) [arXiv:hep-lat/9805013].
- [39] G. W. Anderson and L. J. Hall, “The Electroweak Phase Transition And Baryogenesis,” *Phys. Rev. D* **45**, 2685 (1992).
- [40] M. Carena, M. Quiros and C. E. M. Wagner, “Opening the Window for Electroweak Baryogenesis,” *Phys. Lett. B* **380**, 81 (1996) [arXiv:hep-ph/9603420].
- [41] J. M. Cline and K. Kainulainen, “Supersymmetric Electroweak Phase Transition: Beyond Perturbation Theory,” *Nucl. Phys. B* **482**, 73 (1996) [arXiv:hep-ph/9605235].
M. Laine, “Effective theories of MSSM at high temperature,” *Nucl. Phys. B* **481**, 43 (1996) [Erratum-ibid. *B* **548**, 637 (1999)] [arXiv:hep-ph/9605283].
M. Losada, “High temperature dimensional reduction of the MSSM and other multi-scalar models,” *Phys. Rev. D* **56**, 2893 (1997) [arXiv:hep-ph/9605266].
- [42] J. M. Cline and G. D. Moore, “Supersymmetric electroweak phase transition: Baryogenesis versus experimental constraints,” *Phys. Rev. Lett.* **81**, 3315 (1998) [arXiv:hep-ph/9806354].
- [43] M. Laine and K. Rummukainen, “A strong electroweak phase transition up to $m(H) \text{ approx. } 105\text{-GeV}$,” *Phys. Rev. Lett.* **80**, 5259 (1998) [arXiv:hep-ph/9804255]; “The MSSM electroweak phase transition on the lattice,” *Nucl. Phys. B* **535**, 423 (1998) [arXiv:hep-lat/9804019].
- [44] S. J. Huber and M. G. Schmidt, “Electroweak baryogenesis: Concrete in a SUSY model with a gauge singlet,” *Nucl. Phys. B* **606**, 183 (2001) [arXiv:hep-ph/0003122].
- [45] J. M. Cline and P. A. Lemieux, “Electroweak phase transition in two Higgs doublet models,” *Phys. Rev. D* **55**, 3873 (1997) [arXiv:hep-ph/9609240].

- [46] L. Fromme, S. J. Huber and M. Seniuch, “Baryogenesis in the two-Higgs doublet model,” arXiv:hep-ph/0605242.
- [47] C. Grojean, G. Servant and J. D. Wells, “First-order electroweak phase transition in the standard model with a low cutoff,” Phys. Rev. D **71**, 036001 (2005) [arXiv:hep-ph/0407019].
- [48] M. Joyce, T. Prokopec and N. Turok, “Electroweak baryogenesis from a classical force,” Phys. Rev. Lett. **75**, 1695 (1995) [Erratum-ibid. **75**, 3375 (1995)] [arXiv:hep-ph/9408339]; “Non-local electroweak baryogenesis. Part 2: The Classical regime,” Phys. Rev. D **53**, 2958 (1996) [arXiv:hep-ph/9410282].
- [49] J. M. Cline, M. Joyce and K. Kainulainen, “Supersymmetric electroweak baryogenesis,” JHEP **0007**, 018 (2000) [arXiv:hep-ph/0006119].
- [50] T. Prokopec, M. G. Schmidt and S. Weinstock, “Transport equations for chiral fermions to order \hbar and electroweak baryogenesis,” Annals Phys. **314**, 208 (2004) [arXiv:hep-ph/0312110]; “Transport equations for chiral fermions to order \hbar and electroweak baryogenesis. II,” Annals Phys. **314**, 267 (2004) [arXiv:hep-ph/0406140].
T. Konstandin, T. Prokopec, M. G. Schmidt and M. Seco, Nucl. Phys. B **738**, 1 (2006) [arXiv:hep-ph/0505103].
T. Konstandin, T. Prokopec and M. G. Schmidt, “Kinetic description of fermion flavor mixing and CP-violating sources for baryogenesis,” Nucl. Phys. B **716**, 373 (2005) [arXiv:hep-ph/0410135].
- [51] S. Weinberg, “Larger Higgs Exchange Terms in the Neutron Electric Dipole Moment,” Phys. Rev. Lett. **63**, 2333 (1989).
- [52] J. F. Gunion and D. Wyler, “Inducing a large neutron electric dipole moment via a quark chromoelectric dipole moment,” Phys. Lett. B **248**, 170 (1990).
- [53] S. M. Barr and A. Zee, “Electric Dipole Moment of the Electron and of the Neutron,” Phys. Rev. Lett. **65**, 21 (1990) [Erratum-ibid. **65**, 2920 (1990)].
- [54] M. Pospelov and A. Ritz, “Electric dipole moments as probes of new physics,” Annals Phys. **318**, 119 (2005) [arXiv:hep-ph/0504231].
- [55] J. M. Cline, M. Joyce and K. Kainulainen, “Supersymmetric electroweak baryogenesis in the WKB approximation,” Phys. Lett. B **417**, 79 (1998) [Erratum-ibid. B **448**, 321 (1999)] [arXiv:hep-ph/9708393].
- [56] P. Huet and A. E. Nelson, “Electroweak baryogenesis in supersymmetric models,” Phys. Rev. D **53**, 4578 (1996) [arXiv:hep-ph/9506477].
- [57] M. Carena, M. Quiros, A. Riotto, I. Vilja and C. E. M. Wagner, “Electroweak baryogenesis and low energy supersymmetry,” Nucl. Phys. B **503**, 387 (1997) [arXiv:hep-ph/9702409].
- [58] M. Joyce, K. Kainulainen and T. Prokopec, “The semiclassical propagator in field theory,” Phys. Lett. B **468**, 128 (1999) [arXiv:hep-ph/9906411]; “Fermion propagator in a nontrivial background field,” JHEP **0010**, 029 (2000) [arXiv:hep-ph/0002239]
K. Kainulainen, T. Prokopec, M. G. Schmidt and S. Weinstock, “First principle derivation of semiclassical force for electroweak baryogenesis,” JHEP **0106**, 031 (2001) “Semiclassical force for electroweak baryogenesis: Three-dimensional derivation,” Phys. Rev. D **66**, 043502 (2002) [arXiv:hep-ph/0202177].
- [59] J. M. Cline and K. Kainulainen, “A new source for electroweak baryogenesis in the MSSM,” Phys. Rev. Lett. **85**, 5519 (2000) [arXiv:hep-ph/0002272].
- [60] T. Falk, K. A. Olive, M. Pospelov and R. Roiban, “MSSM predictions for the electric dipole moment of the Hg-199 atom,” Nucl. Phys. B **560**, 3 (1999) [arXiv:hep-ph/9904393].
- [61] “Higgs-mediated electric dipole moments in the MSSM: An application to baryogenesis and Higgs searches,” Nucl. Phys. B **644** (2002) 263 [arXiv:hep-ph/0207277].

- [62] I. Affleck and M. Dine, "A New Mechanism For Baryogenesis," Nucl. Phys. B **249**, 361 (1985).
- [63] M. Fukugita and T. Yanagida, "Baryogenesis Without Grand Unification," Phys. Lett. B **174**, 45 (1986).
- [64] W. Buchmuller, P. Di Bari and M. Plumacher, "Leptogenesis for pedestrians," Annals Phys. **315**, 305 (2005) [arXiv:hep-ph/0401240].
- [65] A. Pilaftsis and T. E. J. Underwood, "Electroweak-scale resonant leptogenesis," Phys. Rev. D **72**, 113001 (2005) [arXiv:hep-ph/0506107].
- [66] J. A. Harvey and M. S. Turner, "Cosmological baryon and lepton number in the presence of electroweak fermion number violation," Phys. Rev. D **42**, 3344 (1990).
- [67] S. Hannestad and G. G. Raffelt, "Neutrino masses and cosmic radiation density: Combined analysis," arXiv:astro-ph/0607101.
- [68] S. Davidson and A. Ibarra, "A lower bound on the right-handed neutrino mass from leptogenesis," Phys. Lett. B **535**, 25 (2002) [arXiv:hep-ph/0202239].
- [69] M. Plumacher, "Leptogenesis," J. Phys. G **29**, 1561 (2003).
- [70] G. F. Giudice, A. Notari, M. Raidal, A. Riotto and A. Strumia, "Towards a complete theory of thermal leptogenesis in the SM and MSSM," Nucl. Phys. B **685**, 89 (2004) [arXiv:hep-ph/0310123].