

# A TWO-DIMENSIONAL QCD IN THE COVARIANT GAUGE

V. Gogokhia and Gy. Kluge

*HAS, CRIP, RMKI, Depart. Theor. Phys., Budapest 114, P.O.B. 49, H-1525, Hungary*

*email addresses: gogohia@rmki.kfki.hu and kluge@rmki.kfki.hu*

## Abstract

A nonperturbative approach to 2D covariant gauge QCD is presented in the context of the Schwinger-Dyson equations for quark and ghost propagators and the corresponding Slavnov-Taylor identities. The distribution theory, complemented by the dimensional regularization method, is used in order to correctly treat the severe infrared singularities which inevitably appear in the theory. By working out the multiplicative renormalization program we remove them from the theory on a general ground and in a self-consistent way, proving thus the infrared multiplicative renormalizability of 2D QCD within our approach. This makes it possible to sum up the infinite series of the corresponding planar skeleton diagrams in order to derive a closed set of equations for the infrared renormalized quark propagator. We have shown that complications due to ghost degrees of freedom can be considerable within our approach. It is shown exactly that 2D covariant gauge QCD implies quark confinement (the quark propagator has no poles, indeed) as well as dynamical breakdown of chiral symmetry (a chiral symmetry preserving solution is forbidden). We also show explicitly how to formulate the bound-state problem and the Schwinger-Dyson equations for the gluon propagator and the triple gauge proper vertex, all free of the severe IR singularities.

PACS numbers: 11.15.Tk, 12.38.Aw, 12.38.Lg

arXiv:hep-ph/0104296v6 24 May 2002

## I. INTRODUCTION

In his paper [1] 't Hooft investigated two-dimensional (2D) QCD in the light-cone gauge which is free from ghost complications. He used also large  $N_c$  (the number of colors) limit technique in order to make the perturbation (PT) expansion with respect to  $1/N_c$  reasonable. In this case the planar diagrams are reduced to quark self-energy and ladder diagrams which can be summed. The bound-state problem within the Bethe-Salpeter (BS) formalism was finally obtained free from the infrared (IR) singularities. The existence of a discrete spectrum only (no continuum in the spectrum) was demonstrated. Since this pioneering paper 2D QCD continues to attract attention (see, for example, review [2] and recent papers [3-5] and references therein). Despite its simplistic vacuum structure it remains a rather good laboratory for the modern theory of strong interaction which is four-dimensional (4D) QCD [6].

The most important yet unsolved problems in QCD are, of course, quark confinement and the dynamical (spontaneous) breakdown of chiral symmetry (or equivalently dynamical chiral symmetry breaking (DCSB)) closely related to it. In this work a new, nonperturbative (NP) solution (using neither large  $N_c$  limit technique explicitly nor a weak coupling regime, i.e., ladder approximation) to 2D QCD in the covariant gauge is obtained. This makes it possible to construct a 2D covariant gauge model for the above-mentioned important phenomena. It is well known, however, that covariant gauges, in general, are complicated by the ghost contributions. Nevertheless, we will show that ghost degrees of freedom can be considerable within our approach. The ghost-quark sector contains a very important piece of information on quark degrees of freedom themselves through the corresponding quark Slavnov-Taylor (ST) identity. This is just the information which should be self-consistently taken into account. Some results of the present investigation have been already presented in Ref. [7].

The paper is organized as follows. In section II we derive the IR renormalized Schwinger-Dyson (SD) equation for the quark propagator. In section III the SD equation for the IR renormalized ghost self-energy is also derived. In section IV the quark-ghost sector represented by the quark ST identity is analyzed and the IR renormalized quark ST identity is obtained. In section V we show that the obtained complete set of equations for the IR renormalized quark propagator can be reduced to a system of coupled, nonlinear differential equations of the first order. By solving the above-mentioned system of equations, it is explicitly shown that the quark propagator has no poles, indeed (section VI), and that the dynamical (spontaneous) breakdown of chiral symmetry is required (section VII). In section VIII the IR properties of the theory in the quark-ghost and Yang-Mills (YM) sectors (by using the corresponding ST identities for the three- and four-gluon vertices) has been discussed. Within the BS formalism we formulate the bound-state problem free from the IR singularities. In sections IX and X the IR properties of the SD equations for the gluon propagator and three-gluon proper vertex are investigated, respectively. This makes it possible to formulate a general system in order to remove all the severe IR divergences from the theory in a self-consistent way, and thus to prove the IR multiplicative renormalizability of our approach to 2D QCD. In section XI we compare our approach with the 't Hooft model [1] with respect to the approximations made. In section XII we discuss our results and present our conclusions. Some perspectives for 4D QCD are also discussed there. We have

investigated a nonzero quark masses case in appendix A. We have shown explicitly that our solution for the quark propagator possesses a heavy quark flavor symmetry. In appendix B we show schematically how the bound-state problem can be reduced to an algebraic problem within our approach in the framework of the BS formalism.

## II. IR RENORMALIZED QUARK PROPAGATOR

Let us consider the SD equation for the quark propagator (PT unrenormalized (as well as other quantities) for simplicity in order not to complicate notations here and everywhere below) in momentum space with Euclidean signature (see Fig. 1)

$$S^{-1}(p) = S_0^{-1}(p) - g^2 C_F i \int \frac{d^n q}{(2\pi)^n} \Gamma_\mu(p, q) S(p - q) \gamma_\nu D_{\mu\nu}^0(q), \quad (2.1)$$

where  $C_F$  is the eigenvalue of the quadratic Casimir operator in the fundamental representation (for  $SU(N_c)$ , in general,  $C_F = (N_c^2 - 1)/2N_c = 4/3$ ) and

$$S_0^{-1}(p) = i(\hat{p} + m_0) \quad (2.2)$$

with  $m_0$  being the current ("bare") mass of a single quark.  $\Gamma_\mu(p, q)$  is the corresponding quark-gluon proper vertex function. Instead of the simplifications due to the limit  $N_c \rightarrow \infty$  at fixed  $g^2 N_c$  and light-cone gauge [1,8] (see section XI below), we are going to use throughout the present investigation the free gluon propagator in the covariant gauge from the very beginning. This makes it possible to maintain the direct interaction of massless gluons which is the main dynamical effect in QCD of any dimensions. In the covariant gauge it is

$$D_{\mu\nu}^0(q) = i \left( g_{\mu\nu} + (\xi - 1) \frac{q_\mu q_\nu}{q^2} \right) \frac{1}{q^2}, \quad (2.3)$$

where  $\xi$  is the gauge fixing parameter. Let us emphasize the fact that by using the gluon propagator in the whole momentum range, we are investigating the quark propagator in the whole momentum range as well.

The important observation now is that for the free gluon propagator the exact singularity  $1/q^2$  at  $q^2 \rightarrow 0$  in 2D QCD is severe and therefore it should be correctly treated within the distribution theory (DT) [9,10] (in Ref. [10] some fundamental results of pure mathematical tractate on the DT [9] necessary for further purpose are presented in a suitable form). In order to actually define the system of the SD equations (see below) in the IR region, it is convenient to apply the gauge-invariant dimensional regularization (DR) method of 't Hooft and Veltman [11] in the limit  $D = 2 + 2\epsilon$ ,  $\epsilon \rightarrow 0^+$ . Here and below  $\epsilon$  is the IR regularization parameter which is to be set to zero at the end of computations. Let us use in the sense of the DT (i.e., under integrals, taking into account the smoothness properties of the corresponding test functions) the relation [9,10]

$$q^{-2} = \frac{\pi}{\epsilon} \delta^2(q) + \text{finite terms}, \quad \epsilon \rightarrow 0^+. \quad (2.4)$$

We point out that after introducing this expansion here and everywhere below, one can fix the number of dimensions, i.e., put  $D = n = 2$  without any further problems since there will be no other severe IR singularities with respect to  $\epsilon$  as  $\epsilon \rightarrow 0^+$  in the corresponding SD equations but those explicitly shown in this expansion.

FIGURES

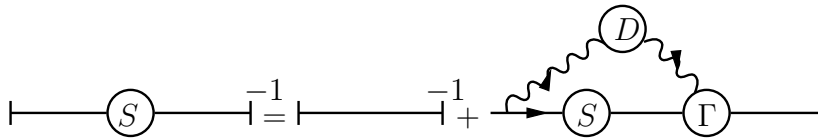

FIG. 1. The quark SD equation. Here and in all figures below  $D \rightarrow D^0$  is understood.

It is worth emphasizing that the IR singularity (2.4) is, on the one hand, a unique, simplest IR singularity possible in 2D QCD; on the other hand, it is a NP (severe) singularity at the same time [9,10]. In this connection, let us remind that in 4D QCD the free gluon's IR singularity is not severe, i.e., the Laurent expansion (2.4) does not exist in this case, so it is a PT singularity there. In other words, the free gluon propagator is the NP itself from the very beginning, and thus may serve as a rather good approximation to the full gluon propagator, at least in the deep IR region, since it exactly reproduces a possible severe IR singularity of the full gluon propagator. This is important since precisely the IR properties of the theory are closely related to its NP dynamics, and therefore they are responsible for such NP effects as quark confinement and dynamical (spontaneous) breakdown of chiral symmetry. That the free gluon propagator IR singularity exactly reproduces a possible simplest NP IR singularity of the full gluon propagator, is a particular feature of 2D QCD. This underlines a special status of this theory. In this case all other Green's functions (in particular, the quark-gluon and ghost-gluon vertices) should be considered as regular functions of the momentum transfer (otherwise, obviously, the IR singularity becomes effectively stronger than (2.4)). In the quark-ghost sector, however, the momentum transfer goes through the momentum of the ghost self-energy (see section IV). In its turn, this means that the quark-gluon vertex is regular with respect to the ghost self-energy momentum. At the same time, we will show that the ghost self-energy can be regular at the origin as well. Apparently, in nD QCD all the severe IR singularities are to be mainly accumulated in the full gluon propagator and effectively correctly described by its structure in the IR domain.

In the presence of such a severe singularity (2.4) all Green's functions become generally dependent on the IR regularization parameter  $\epsilon$ , i.e., they become IR regularized. For simplicity, this dependence is not shown explicitly. Let us introduce the IR renormalized quark-gluon vertex function, coupling constant and the quark propagator as follows:

$$\begin{aligned}\Gamma_\mu(p, q) &= Z_1^{-1}(\epsilon)\bar{\Gamma}_\mu(p, q), \\ g^2 &= X(\epsilon)\bar{g}^2, \quad \epsilon \rightarrow 0^+, \\ S(p) &= Z_2(\epsilon)\bar{S}(p).\end{aligned}\tag{2.5}$$

Here and below  $Z_1(\epsilon)$ ,  $Z_2(\epsilon)$  and  $X(\epsilon)$  are the corresponding IR multiplicative renormalization (IRMR) constants. The  $\epsilon$ -parameter dependence is indicated explicitly to distinguish them from the usual ultraviolet (UV) renormalization constants. In all relations containing the IRMR constants, the  $\epsilon \rightarrow 0^+$  limit is always assumed at the final stage.  $\bar{\Gamma}_\mu(p, q)$  and  $\bar{S}(p)$  are the IR renormalized Green's functions and therefore they do not depend on  $\epsilon$  in the  $\epsilon \rightarrow 0^+$  limit, i.e. they exist as  $\epsilon \rightarrow 0^+$ , as does the IR renormalized coupling constant  $\bar{g}^2$  (charge IR renormalization). There are no restrictions on the  $\epsilon \rightarrow 0^+$  limit behavior of the IRMR constants apart from the smooth  $\epsilon$  dependence of the quark wave function IRMR constant  $Z_2(\epsilon)$  (see Eq. (2.7) below).

Substituting all these relations into the quark SD equation (2.1), and taking into account the expansion (2.4), we see that a cancellation of the IR divergences takes place if and only if (iff)

$$X(\epsilon)Z_2^2(\epsilon)Z_1^{-1}(\epsilon) = \epsilon Y_q, \quad \epsilon \rightarrow 0^+, \quad (2.6)$$

holds. Here  $Y_q$  is an arbitrary but finite constant. Thus the relation (2.6) is the quark SD equation IR convergence condition in the most general form. It is evident that this very condition and the similar ones below govern the concrete  $\epsilon$ -dependence of the IRMR constants which, in general, remain arbitrary. The quark SD equation for the IR renormalized quantities becomes

$$\bar{S}^{-1}(p) = Z_2(\epsilon)S_0^{-1}(p) + \bar{g}^2 Y_q \bar{\Gamma}_\mu(p, 0) \bar{S}(p) \gamma_\mu. \quad (2.7)$$

Let us note that the IR renormalized coupling constant in 2D QCD has the dimensions of mass. All other finite numerical factors (apart from  $Y_q$ ) have been included into it. Also here and below all other finite terms become terms of order  $\epsilon$  and therefore they vanish in the  $\epsilon \rightarrow 0^+$  limit after the completion of the IRMR program (in order to remove all the severe IR singularities from the theory on a general ground).

A few remarks are in order. Here and everywhere below in the derivation of the equations for the IR renormalized quantities we use the relation  $q_\mu q_\nu = (1/2)g_{\mu\nu}q^2$  in the sense of the symmetric integration in 2D Euclidean space since it is multiplied by the  $\delta$  function (i.e.,  $q \rightarrow 0$ ). As was mentioned above, the finite numerical factor  $(\xi + 1)/2$  has been included into the IR renormalized coupling constant (in principle, in the presence of an arbitrary mass scale parameter one can forget about arbitrary, finite constants). In its turn, this means that there is no explicit dependence on the gauge fixing parameter in the quark SD equation (2.7). The same will be true for the quark ST identity (see below).

Let us also show briefly that the gauge fixing parameter is the IR finite from the very beginning, indeed. Similar to relations (2.5), let us introduce the IRMR constant of the gauge fixing parameter as follows:  $\xi = X_1(\epsilon)\bar{\xi}$ , where again  $\bar{\xi}$  exists as  $\epsilon$  goes to zero, by definition. Then in addition to the quark SD equation IR convergence condition (2.6) one has one more condition including the gauge fixing parameter IRMR constant, namely

$$X_1(\epsilon)X(\epsilon)Z_2^2(\epsilon)Z_1^{-1}(\epsilon) = \epsilon Y_1, \quad \epsilon \rightarrow 0^+. \quad (2.8)$$

However, combining these two conditions, one immediately obtains  $X_1(\epsilon) = X_1 = Y_1 Y_q^{-1}$ . So this finite but arbitrary number can be put to unity not losing generality since nothing depends explicitly on the gauge fixing parameter.

The information about the quark-gluon vertex function at zero momentum transfer can be provided by the quark ST identity [6,12,13] which contains unknown ghost contributions in the covariant gauge. For this reason let us consider in the next section the SD equation for the ghost self-energy.

### III. IR RENORMALIZED GHOST SELF-ENERGY

The ghost self-energy  $b(k^2)$  also obeys a simple SD equation in Euclidean space [6,14] (see Fig. 2)

$$ik^2b(k^2) = g^2C_Ai \int \frac{d^nq}{(2\pi)^n} G_\mu(k, q)G(k - q)(k - q)_\nu D_{\mu\nu}^0(q), \quad (3.1)$$

where  $C_A$  is the eigenvalue of the quadratic Casimir operator in the adjoint representation (for  $SU(N_c)$ , in general,  $C_A = N_c$ ). The ghost propagator is

$$G(k) = -\frac{i}{k^2[1 + b(k^2)]} \quad (3.2)$$

and

$$G_\mu(k, q) = k^\lambda G_{\lambda\mu}(k, q) \quad (3.3)$$

is the ghost-gluon vertex function ( $G_{\lambda\mu} = g_{\lambda\mu}$  in perturbation theory).

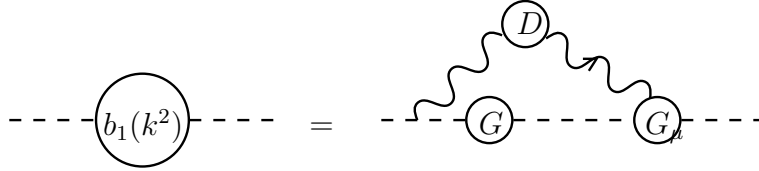

FIG. 2. The ghost self-energy SD equation with definition  $b_1(k^2) = ik^2b(k^2)$ .

Similar to the previous relations, let us introduce the IR renormalized ghost self-energy

$$b(k^2) = \tilde{Z}(\epsilon)\bar{b}(k^2), \quad \epsilon \rightarrow 0^+ \quad (3.4)$$

and the IR renormalized ghost-gluon vertex function

$$G_\mu(k, q) = \tilde{Z}_1(\epsilon)\bar{G}_\mu(k, q), \quad \epsilon \rightarrow 0^+, \quad (3.5)$$

where  $\bar{b}(k^2)$  and  $\bar{G}_\mu(k, q)$  are IR renormalized, by definition. Thus they do not depend on the parameter  $\epsilon$  in the  $\epsilon \rightarrow 0^+$  limit which is always assumed in this kind of relations.  $\tilde{Z}(\epsilon)$  and  $\tilde{Z}_1(\epsilon)$  are the corresponding IRMR constants. The IR renormalized ghost propagator is defined as

$$G(k) = \tilde{Z}_2(\epsilon)\bar{G}(k), \quad \epsilon \rightarrow 0^+, \quad (3.6)$$

where  $\tilde{Z}_2(\epsilon)$  is also the corresponding IRMR constant and  $\bar{G}(k)$  exists as  $\epsilon \rightarrow 0^+$ . From these definitions it follows that the ghost propagator IRMR constant  $\tilde{Z}_2(\epsilon)$  is completely determined by the ghost self-energy IRMR constant  $\tilde{Z}(\epsilon)$  and vice versa, i.e.,

$$\tilde{Z}_2(\epsilon) = \tilde{Z}^{-1}(\epsilon). \quad (3.7)$$

As in the previous case, the dependence of these IRMR constants on  $\epsilon$  in general is arbitrary apart from the ghost self-energy IRMR constant  $\tilde{Z}(\epsilon)$ . The expression for the IR renormalized ghost propagator is

$$\bar{G}(k) = -\frac{i}{k^2 [\tilde{Z}^{-1}(\epsilon) + \bar{b}(k^2)]}, \quad \epsilon \rightarrow 0^+. \quad (3.8)$$

From this expression it obviously follows that the regular dependence of  $\tilde{Z}(\epsilon)$  on  $\epsilon$  in the  $\epsilon \rightarrow 0^+$  limit should be excluded from the very beginning. The problem is that if  $\tilde{Z}(\epsilon)$  vanishes as  $\epsilon \rightarrow 0^+$ , i.e.,  $\tilde{Z}^{-1}(\epsilon)$  is singular, then the full ghost propagator simply reduces to the free one, and there is no nontrivial renormalization at all. In other words, in this case the IR renormalized ghost propagator is vanishing in the  $\epsilon \rightarrow 0^+$  limit. This means in its turn that all the necessary information about quark degrees of freedom which is contained in the quark-ghost sector will be finally totally lost (see next section). Thus the only nontrivial cases remaining are:

1). When the ghost self-energy is IR renormalized from the very beginning (i.e.,  $\tilde{Z}(\epsilon) \equiv \tilde{Z} = \text{const.}$ , so that it is IR finite), then the ghost propagator is also IR finite.

2). The IRMR constant  $\tilde{Z}(\epsilon)$  is singular as  $\epsilon$  goes to zero, so its inverse is regular in the same limit.

Substituting all these relations as well as relation (2.4) into the initial SD equation for the ghost self-energy (3.1), we see obtains that a cancellation of the severe IR divergences takes place iff

$$X(\epsilon)\tilde{Z}_1(\epsilon)\tilde{Z}_2(\epsilon)\tilde{Z}^{-1}(\epsilon) = \epsilon Y_g, \quad \epsilon \rightarrow 0^+, \quad (3.9)$$

holds. Here  $Y_g$  is an arbitrary but finite constant (different from  $Y_q$ , of course). This is the ghost self-energy SD equation IR convergence condition in the most general form. The ghost SD equation for the IR renormalized quantities becomes (in the Euclidean space)

$$ik^2\bar{b}(k^2) = -\bar{g}_1^2 Y_g \bar{G}_\mu(k, 0) \bar{G}(k) k_\mu, \quad (3.10)$$

where all known finite numerical factors are included into the IR renormalized coupling constant  $\bar{g}_1^2$ , apart from  $Y_g$  (see section IV).

### A. Ghost-gluon vertex

In order to show that the IR renormalized ghost self-energy may exist and be finite at origin, one has to extract  $k^2$  from the right hand side of Eq. (3.10), and then pass to the limit  $k^2 = 0$ . For this aim, let us consider the IR renormalized counterpart of the ghost-gluon vertex (3.3) which is shown in Eq. (3.5)

$$\bar{G}_\mu(k, q) = k^\lambda \bar{G}_{\lambda\mu}(k, q). \quad (3.11)$$

Its general decomposition is

$$\bar{G}_{\lambda\mu}(k, q) = g_{\lambda\mu} G_1 + k_\lambda k_\mu G_2 + q_\lambda q_\mu G_3 + k_\lambda q_\mu G_4 + q_\lambda k_\mu G_5, \quad (3.12)$$

and ( $l = k - q$ )

$$G_i \equiv G_i(k^2, q^2, l^2), \quad i = 1, 2, 3, 4, 5. \quad (3.13)$$

Substituting this into the previous vertex (3.11), one obtains

$$\bar{G}_\mu(k, q) = k_\mu \bar{G}_1(k, q) + q_\mu \bar{G}_2(k, q), \quad (3.14)$$

where

$$\begin{aligned}\bar{G}_1(k, q) &= G_1 + k^2 G_2 + (kq)G_5 = G_1 + k^2(G_2 + G_5) - (kl)G_5, \\ \bar{G}_2(k, q) &= k^2 G_4 + (kq)G_3 = k^2(G_3 + G_4) - (kl)G_3.\end{aligned}\tag{3.15}$$

Thus at zero momentum transfer ( $q = 0$ ), one has

$$\bar{G}_\mu(k, 0) = k_\mu \bar{G}_1(k, 0) = k_\mu \bar{G}_1(k^2),\tag{3.16}$$

where

$$\bar{G}_1(k^2) = G_1(k^2) + k^2 G_2(k^2).\tag{3.17}$$

Let us remind that the form factors (3.13) exist when any of their momenta goes to zero.<sup>1</sup> Taking now into account the relation (3.16) and the definition (3.8), it is easy to see that the corresponding equation (3.10) for determining  $\bar{b}(k^2)$  is nothing else but an algebraic equation of second order, namely

$$\bar{b}^2(k^2) + \tilde{Z}^{-1} \bar{b}(k^2) = \frac{1}{k^2} \bar{g}_1^2 Y_g \bar{G}_1(k^2).\tag{3.18}$$

Its solutions are

$$\bar{b}_{1,2}(k^2) = -\frac{1}{2} \tilde{Z}^{-1} \pm \sqrt{\frac{1}{4} \tilde{Z}^{-2} + \frac{1}{k^2} \bar{g}_1^2 Y_g \bar{G}_1(k^2)}.\tag{3.19}$$

Let us remind that in this equation  $\tilde{Z}^{-1} \equiv \tilde{Z}^{-1}(\epsilon)$  is either constant or vanishes as  $\epsilon \rightarrow 0^+$ , so it always exists in this limit. If now (see also Ref. [14])

$$\bar{G}_1(k^2) = k^2 R_1(k^2), \quad k^2 \rightarrow 0,\tag{3.20}$$

and  $R_1(k^2)$  exists and is finite at zero point, then the ghost-self energy exists and is finite at the origin as well.<sup>2</sup> Because of the relation (3.17) this can be achieved in general by setting  $G_1(k^2) = k^2 R(k^2)$  and then  $R_1(k^2) = R(k^2) + G_2(k^2)$ . Let us emphasize in advance that our final results will not explicitly depend on the auxiliary technical assumption (3.20).

Obviously, Eq. (3.10) can be rewritten in the equivalent form as follows:

$$-\bar{g}_1^2 Y_g \bar{G}_\mu(k, 0) \bar{G}(k) = ik_\mu \bar{b}(k^2),\tag{3.21}$$

---

<sup>1</sup>The significance of the unphysical kinematical singularities in the Euclidean space, where  $k^2 = 0$  implies  $k_i = 0$ , becomes hypothetical. In Minkowski space they always can be removed in advance by the Ball and Chiu procedure [15] as well as from the quark-gluon vertex.

<sup>2</sup>In principle, singular dependence of the ghost self-energy on its momentum should not be excluded *a priori*. However, the ST identity (see next section) is to be treated in a completely different way in this case and therefore it is left for consideration elsewhere. Also the smoothness properties of the corresponding test functions are compromised in this case and the use of the relation (2.4) becomes problematic, at least in the standard DT sense.



then it follows that the right hand side of this relation is of order  $k$  ( $\sim O(k)$ ) always as  $k \rightarrow 0$ . Thus the ghost-self energy exists and is finite at zero point but remains arbitrary within our approach.

Concluding, let us note that, in principle, the information about the ghost-gluon vertex (3.11) could be obtained from the corresponding identity derived in Ref. [16]. We found (in complete agreement with Pagels [14]) that even at zero momentum transfer no useful information can be obtained, indeed. It has a too complicated mathematical structure and involves the matrix elements of composite operators of ghost and gluon fields. However, let us emphasize that our approach makes it possible to avoid this difficulty (see below).

#### IV. IR RENORMALIZED QUARK ST IDENTITY

Let us consider the ST identity for the quark-gluon vertex  $\Gamma_\mu(p, k)$ :

$$-ik_\mu \Gamma_\mu^a(p, k) [1 + b(k^2)] = [T^a - B^a(p, k)] S^{-1}(p+k) - S^{-1}(p) [T^a - B^a(p, k)], \quad (4.1)$$

where  $b(k^2)$  is the ghost self-energy and  $B^a(p, k)$  is the ghost-quark scattering kernel [6,14,17,18];  $T^a$ 's are color group generators. From it one recovers the standard Ward-Takahashi (WT) identity in the formal  $b = B = 0$  limit. The ghost-quark scattering kernel  $B^a(p, k)$  is determined by its skeleton expansion

$$B^a(p, k) = \sum_{n=1}^{\infty} B_n^a(p, k) \quad (4.2)$$

which is diagrammatically shown in Fig. 3 (see also Refs. [14,18]).

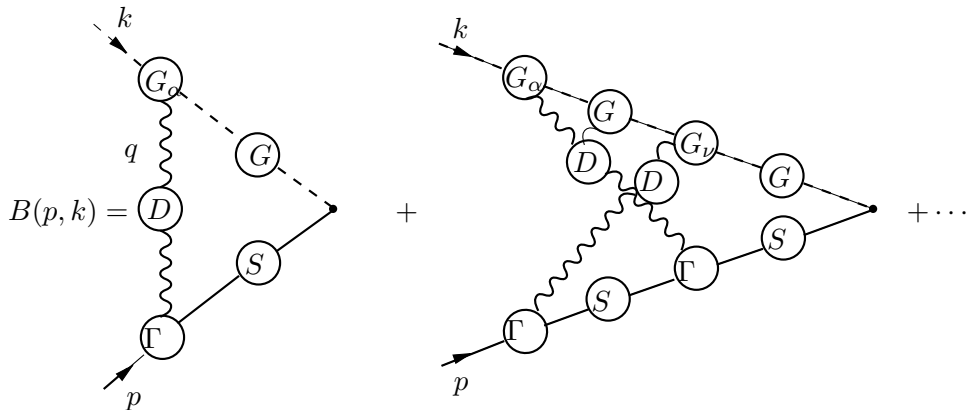

FIG. 3. The skeleton expansion for the ghost-quark scattering kernel.

In addition to the previous IR renormalized quantities, it is convenient to introduce independently the "IRMR constant" for the ghost-quark scattering kernel  $B^a(p, k)$  itself as follows:

$$B^a(p, k) = \tilde{Z}_B(\epsilon) \bar{B}^a(p, k), \quad \epsilon \rightarrow 0^+. \quad (4.3)$$

Then the IR renormalized version of the quark ST identity (4.1) becomes (here and below we have already escaped the dependence on the color group generators  $T^a$ 's)

$$\begin{aligned}
-ik_\mu \bar{\Gamma}_\mu(p, k) \left[ \tilde{Z}^{-1}(\epsilon) + \bar{b}(k^2) \right] &= \left[ \tilde{Z}_B^{-1}(\epsilon) - \bar{B}(p, k) \right] \bar{S}^{-1}(p+k) \\
&\quad - \bar{S}^{-1}(p) \left[ \tilde{Z}_B^{-1}(\epsilon) - \bar{B}(p, k) \right],
\end{aligned} \tag{4.4}$$

iff the corresponding quark ST identity IR convergence relation

$$Z_1^{-1}(\epsilon) \tilde{Z}(\epsilon) = Z_2^{-1}(\epsilon) \tilde{Z}_B(\epsilon), \quad \epsilon \rightarrow 0^+, \tag{4.5}$$

holds. Our final results will not depend on the quark-ghost scattering kernel "IRMR constant". It plays only auxiliary role. It is almost obvious that this "IRMR constant" does not depend on  $\epsilon$  at all, i.e.,  $\tilde{Z}_B(\epsilon) = \tilde{Z}_B = \text{const.}$ , remaining an arbitrary finite constant. Otherwise, from the ST identity (4.4) it would simply follow that either the information about quark degrees of freedom (which is contained in  $\bar{B}(p, k)$ ) would be lost (regular dependence) or the correspondence with the WT identity would be lost (singular dependence). That is why in what follows we will omit its dependence on  $\epsilon$ . Let us note that the IRMR program can be formulated without explicitly introducing it (see second paper in Ref. [18]).

Let us start with the investigation of the first term  $B_1(p, k)$  in the  $B(p, k)$  skeleton expansion (4.2). After the evaluation of the color group factors it becomes (Euclidean space)

$$B_1(p, k) = -\frac{1}{2} g^2 C_A i \int \frac{d^n q}{(2\pi)^n} S(p-q) \Gamma_\nu(p-q, q) G_\mu(k, q) G(k+q) D_{\mu\nu}^0(q), \tag{4.6}$$

where  $C_A$  is the quadratic Casimir operator in the adjoint representation. Proceeding to the IR renormalized functions, we obtain

$$\bar{B}_1(p, k) = \frac{1}{2} \bar{g}_1^2 Y \bar{S}(p) \bar{\Gamma}_\mu(p, 0) \bar{G}_\mu(k, 0) \bar{G}(k), \tag{4.7}$$

iff a cancellation of the severe IR divergences takes place, i.e.,

$$\tilde{Z}_B^{-1} X(\epsilon) Z_2(\epsilon) Z_1^{-1}(\epsilon) \tilde{Z}_1(\epsilon) \tilde{Z}_2(\epsilon) = \epsilon Y, \quad \epsilon \rightarrow 0^+, \tag{4.8}$$

where  $Y$  is an arbitrary but finite constant. From the IR convergence condition (4.8) and the general ST identity IR convergence relation (4.5) and Eq. (3.9), it follows

$$Y = Y_g. \tag{4.9}$$

Substituting now the ghost SD equation (3.21) into the Eq. (4.7), on account of the relation (4.9), one obtains

$$\bar{B}_1(p, k) = -\frac{1}{2} i \bar{S}(p) \bar{\Gamma}_\mu(p, 0) \bar{b}(k^2) k_\mu. \tag{4.10}$$

Let us note that this final expression does not depend explicitly on the coupling constant as it should be. It clearly shows that the first term of the  $\bar{B}(p, k)$  skeleton expansion is of order  $k$  ( $\sim O(k)$ ) as  $k$  goes to zero since  $\bar{b}(0)$  exists and is finite in this limit.

The analytical expression of the second skeleton diagram for the ghost-quark scattering kernel  $B(p, k)$  is

$$\begin{aligned}
B_2(p, k) &= Ag^4 \int \frac{id^n q}{(2\pi)^n} \int \frac{id^n l}{(2\pi)^n} S(p-q+l) \Gamma_\beta(p-q+l, l) S(p-q) \\
&\Gamma_\nu(p-q, q) G_\mu(k, -l) G(k-l) G_\alpha(k-l, q) G(k-l+q) D_{\alpha\nu}^0(q) D_{\mu\beta}^0(l),
\end{aligned} \tag{4.11}$$

where the constant  $A$  is a result of the summation over color group indices (its explicit expression is not important here, see below). As in the previous case, by passing to the IR renormalized quantities and using twice the corresponding IR convergent condition (4.8), we get

$$\bar{B}_2(p, k) = A_1 \bar{g}^4 Y^2 \tilde{Z}_B \bar{S}(p) \bar{\Gamma}_\mu(p, 0) \bar{S}(p) \bar{\Gamma}_\nu(p, 0) \bar{G}_\mu(k, 0) \bar{G}(k) \bar{G}_\nu(k, 0) \bar{G}(k). \tag{4.12}$$

Using further Eq. (3.21) again twice, we finally obtain

$$\bar{B}_2(p, k) = A_2 \tilde{Z}_B \bar{S}(p) \bar{\Gamma}_\mu(p, 0) \bar{S}(p) \bar{\Gamma}_\nu(p, 0) \bar{b}^2(k^2) k_\mu k_\nu, \tag{4.13}$$

which clearly shows that the second term is of order  $k^2$  as  $k$  goes to zero.

In the same way it is possible to show that the third term  $\bar{B}_3(p, k)$  of the skeleton expansion for the ghost-quark scattering kernel  $\bar{B}(p, k)$  is of order  $k^3$  ( $\sim O(k^3)$ ) as  $k$  goes to zero. These arguments are valid term by term in the skeleton expansion for the ghost-quark scattering kernel. Thus we have the estimate

$$\bar{B}_n(p, k) = O(k^n), \quad k \rightarrow 0, \tag{4.14}$$

which means that we can restrict ourselves to the first term in the skeleton expansion of the  $\bar{B}(p, k)$  kernel at small  $k$ , i.e. put

$$\bar{B}(p, k) = \bar{B}_1(p, k) + O(k^2), \quad k \rightarrow 0. \tag{4.15}$$

Differentiating now the IR finite quark ST identity (4.4) with respect to  $k_\mu$  and passing to the limit  $k = 0$ , we obtain

$$-i \bar{\Gamma}_\mu(p, 0) \left[ \tilde{Z}^{-1}(\epsilon) + \bar{b}(0) \right] = \tilde{Z}_B^{-1} d_\mu \bar{S}^{-1}(p) - \bar{\Psi}_\mu(p) \bar{S}^{-1}(p) + \bar{S}^{-1}(p) \bar{\Psi}_\mu(p), \tag{4.16}$$

where

$$\bar{\Psi}_\mu(p) = \left[ \frac{\partial}{\partial k_\mu} \bar{B}(p, k) \right]_{k=0} = -\frac{1}{2} i \bar{b}(0) \bar{S}(p) \bar{\Gamma}_\mu(p, 0). \tag{4.17}$$

Substituting the relation (4.17) back into the previous ST identity (4.16), its IR renormalized version becomes

$$\left[ \tilde{Z}^{-1}(\epsilon) + \frac{1}{2} \bar{b}(0) \right] \bar{\Gamma}_\mu(p, 0) = i \tilde{Z}_B^{-1} d_\mu \bar{S}^{-1}(p) - \frac{1}{2} \bar{b}(0) \bar{S}(p) \bar{\Gamma}_\mu(p, 0) \bar{S}^{-1}(p). \tag{4.18}$$

### A. Rescaling procedure

At the first sight we have obtained a very undesirable result since the IR renormalized ST identity (4.18) heavily depends on the arbitrary IRMR constants which have no physical sense. It depends also on the arbitrary ghost self-energy at zero point. However, let us formulate now a general method how to escape in the IR renormalized ST identity (4.18) the explicit dependence on the arbitrary ghost self-energy at zero point and the above-mentioned arbitrary IRMR constants. For this purpose, let us rescale the vertex in the ST identity (4.18) in accordance with

$$\tilde{Z}_B \left[ \tilde{Z}^{-1}(\epsilon) + \frac{1}{2}\bar{b}(0) \right] \bar{\Gamma}_\mu(p, 0) \implies \bar{\Gamma}_\mu(p, 0). \quad (4.19)$$

Then the ST identity (4.18) becomes

$$\bar{\Gamma}_\mu(p, 0) = id_\mu \bar{S}^{-1}(p) - (1 + \Delta)^{-1} \bar{S}(p) \bar{\Gamma}_\mu(p, 0) \bar{S}^{-1}(p), \quad (4.20)$$

where

$$\Delta = \frac{2\tilde{Z}^{-1}(\epsilon)}{\bar{b}(0)}. \quad (4.21)$$

Let us note that the dependence on the auxiliary "IRMR constant"  $\tilde{Z}_B$  disappears as expected. The only problem now is the behavior of the ghost self-energy IRMR constant  $\tilde{Z}(\epsilon)$  in the  $\epsilon \rightarrow 0^+$  limit. As was underlined in the preceding section, only two independent cases should be considered.

1). The ghost self-energy IRMR constant  $\tilde{Z}(\epsilon)$  does not depend on  $\epsilon$  at all, i.e., it is finite but arbitrary,  $\tilde{Z}(\epsilon) = \tilde{Z} = const$ . In this case, redefining the ghost self-energy at zero point in the IR renormalized ST identity (4.20), one obtains

$$\bar{\Gamma}_\mu(p, 0) = id_\mu \bar{S}^{-1}(p) - b_1(0) \bar{S}(p) \bar{\Gamma}_\mu(p, 0) \bar{S}^{-1}(p) \quad (4.22)$$

and

$$b_1(0) = (1 + \Delta(0))^{-1} = (1 + [2\tilde{Z}^{-1}/\bar{b}(0)])^{-1}. \quad (4.23)$$

It is just the analogue of this identity in 4D QCD which was first obtained by Pagels in his pioneering paper on NP QCD [14]. Let us formally consider  $\Delta(0) = [2\tilde{Z}^{-1}/\bar{b}(0)]$  as small. Then expanding in powers of  $\Delta$ , one gets

$$(1 + \Delta(0))^{-1} = 1 - \delta = 1 - \sum_{n=2}^{\infty} (-1)^n \Delta^{n-1}. \quad (4.24)$$

Substituting this back into the previous ST identity, one finally obtains

$$\bar{\Gamma}_\mu(p, 0) = id_\mu \bar{S}^{-1}(p) - \bar{S}(p) \bar{\Gamma}_\mu(p, 0) \bar{S}^{-1}(p) + \delta \bar{S}(p) \bar{\Gamma}_\mu(p, 0) \bar{S}^{-1}(p), \quad (4.25)$$

which makes it possible to take into account the arbitrary coefficient  $b_1$  step by step in powers of  $\Delta$ , starting from  $\delta = 0$ . For the sake of simplicity, in this approximation (to leading order,  $\delta = 0$ ) this ST identity will be used in what follows.

2). The second available possibility is when the ghost self-energy IRMR constant  $\tilde{Z}(\epsilon)$  is singular as  $\epsilon$  goes to zero, so its inverse vanishes in this limit. In this case  $\Delta = 0$  identically (see Eq. (4.21)), and the quark ST identity (4.20) finally becomes

$$\bar{\Gamma}_\mu(p, 0) = id_\mu \bar{S}^{-1}(p) - \bar{S}(p) \bar{\Gamma}_\mu(p, 0) \bar{S}^{-1}(p). \quad (4.26)$$

It is just the analogue of this identity in 4D QCD which was obtained in our investigation of NP QCD [18] (see also Ref. [10] and references therein). It is automatically free from ghost complications ( $\delta = 0$  from the very beginning). At the same time, it contains nontrivial information on quarks degrees of freedom themselves provided by the quark-ghost sector (the second term in Eqs. (4.25) and (4.26), while the first term is, obviously, the standard WT-type contribution).

## V. COMPLETE SET OF EQUATIONS FOR THE IR RENORMALIZED QUARK PROPAGATOR

The final system of equations obtained for the IR renormalized quantities in the quark sector are presented by the quark SD equation (2.7) and the quark ST identity (4.26), i.e.,

$$\begin{aligned} S^{-1}(p) &= Z_2(\epsilon) S_0^{-1}(p) + \bar{g}^2 \Gamma_\mu(p, 0) S(p) \gamma_\mu, \\ \Gamma_\mu(p, 0) &= id_\mu S^{-1}(p) - S(p) \Gamma_\mu(p, 0) S^{-1}(p). \end{aligned} \quad (5.1)$$

For simplicity here we removed "bars" from the definitions of the IR renormalized Green's functions, retaining them only for the coupling constant (which has the dimensions of mass) in order to distinguish it from initial ("bare") coupling constant. It contains all known finite numerical factors as well as the rescaling factor from the previous section. The arbitrary but finite constant  $Y_q$  is put to unity without losing generality in advance (see section VIII).

The Euclidean version of our parametrization of the quark propagator is as follows:

$$iS(p) = \hat{p}A(p^2) - B(p^2), \quad (5.2)$$

so its inverse is

$$iS^{-1}(p) = \hat{p}\bar{A}(p^2) + \bar{B}(p^2) \quad (5.3)$$

with

$$\begin{aligned} \bar{A}(p^2) &= A(p^2)E^{-1}(p^2), \\ \bar{B}(p^2) &= B(p^2)E^{-1}(p^2), \\ E(p^2) &= p^2 A^2(p^2) + B^2(p^2). \end{aligned} \quad (5.4)$$

In order to solve the ST identity (the second of equations in the system (5.1)), the simplest way is to represent the quark-gluon vertex function at zero momentum transfer as its decomposition in terms of four independent form factors, namely

$$\Gamma_\mu(p, 0) = \gamma_\mu F_1(p^2) + p_\mu F_2(p^2) - \hat{p} p_\mu F_3(p^2) - \hat{p} \gamma_\mu F_4(p^2). \quad (5.5)$$

Substituting this representation into the second of Eqs. (5.1) and doing some tedious algebra of the  $\gamma$  matrices in 2D Euclidean space, one obtains

$$\begin{aligned}
F_1(p^2) &= -\frac{1}{2}\overline{A}'(p^2), \\
F_2(p^2) &= -\overline{B}'(p^2) - F_4(p^2), \\
F_3(p^2) &= \overline{A}'(p^2), \\
F_4(p^2) &= \frac{1}{2}A(p^2)\overline{A}(p^2)B^{-1}(p^2),
\end{aligned} \tag{5.6}$$

where the prime denotes the derivative with respect to the Euclidean momentum variable  $p^2$ .

It is convenient to introduce the dimensionless variables and functions as

$$A(p^2) = \bar{g}^{-2}A(x), \quad B(p^2) = \bar{g}^{-1}B(x), \quad x = p^2/\bar{g}^2. \tag{5.7}$$

Taking into account the previous relations and definitions, and performing further the algebra of the  $\gamma$  matrices in 2D Euclidean space, the system (5.1) can be explicitly reduced to a system of a coupled, nonlinear ordinary differential equations of the first order for the  $A(x)$  and  $B(x)$  quark propagator form factors.

### A. IR finite quark propagator

For the quark propagator which is IR finite (IRF) from the very beginning, i.e., when  $Z_2(\epsilon) = Z_2 = 1$  as  $\epsilon$  goes to zero (see section VIII below), the system of equations (5.1) becomes

$$\begin{aligned}
S^{-1}(p) &= S_0^{-1}(p) + \bar{g}^2\Gamma_\mu(p, 0)S(p)\gamma_\mu, \\
\Gamma_\mu(p, 0) &= id_\mu S^{-1}(p) - S(p)\Gamma_\mu(p, 0)S^{-1}(p).
\end{aligned} \tag{5.8}$$

Doing some of the above-mentioned tedious algebra, the quark SD equation (5.8) is finally reduced to

$$\begin{aligned}
xA' &= -(1+x)A - 1 - m_0B, \\
2BB' &= -A^2 + 2(m_0A - B)B,
\end{aligned} \tag{5.9}$$

where  $A \equiv A(x)$ ,  $B \equiv B(x)$ , and now the prime denotes the derivative with respect to the Euclidean dimensionless momentum variable  $x$ . For the dimensionless current quark mass, we retain, obviously, the same notation, i.e.,  $m_0/\bar{g} \rightarrow m_0$ .

The exact solution of the system (5.9) for the dynamically generated quark mass function is

$$B^2(c, m_0; x) = \exp(-2x) \int_x^c \exp(2x')\tilde{\nu}(x') dx', \tag{5.10}$$

where  $c$  is the constant of integration and

$$\tilde{\nu}(x) = A^2(x) + 2A(x)\nu(x) \tag{5.11}$$

with

$$\nu(x) = -m_0 B(x) = xA'(x) + (1+x)A(x) + 1. \quad (5.12)$$

Then the equation determining the  $A(x)$  function becomes

$$\frac{d\nu^2(x)}{dx} + 2\nu^2(x) = -A^2(x)m_0^2 - 2A(x)\nu(x)m_0^2. \quad (5.13)$$

In the chiral limit ( $m_0 = 0$ ) the system (5.9) can be solved exactly. The solution for the  $A(x)$  function is

$$A_0(x) = -x^{-1} \{1 - \exp(-x)\}. \quad (5.14)$$

It has thus the correct asymptotic properties (is regular at small  $x$  and asymptotically approaches the free propagator at infinity). For the dynamically generated quark mass function  $B(x)$  the exact solution is

$$B_0^2(c_0, x) = \exp(-2x) \int_x^{c_0} \exp(2x') A^2(x') dx', \quad (5.15)$$

where  $c_0 = p_0^2/\bar{g}^2$  is an arbitrary constant of integration. It is regular at zero. In addition, it also has algebraic branch points at  $x = c_0$  and at infinity (at fixed  $c_0$ ). As in the general (nonchiral) case, these unphysical singularities are caused by the inevitable ghost contributions in the covariant gauges.

As was mentioned above,  $A_0(x)$  automatically has a correct behavior at infinity (it does not depend on the constant of integration since it was specified in order to get regular at zero solution). In order to reproduce the correct behavior at infinity ( $x \rightarrow \infty$ ) of the dynamically generated quark mass function, it is necessary to pass simultaneously to the limit  $c_0 \rightarrow \infty$  in Eq. (5.15). So it identically vanishes in this limit in accordance with the vanishing current light quark mass in the chiral limit. Obviously, we have to keep the constant of integration  $c_0$  in Eq. (5.15) arbitrary but finite in order to obtain a regular at zero point solution. The problem is that if  $c_0 = \infty$ , then the solution (5.15) does not exist at all at any finite  $x$ , in particular at  $x = 0$ .

Concluding, let us note that an exact solution which is singular at zero also exists. It is easy to check that  $A_0(x) = -(1/x)$  automatically satisfies the system (5.9) in the chiral limit. The corresponding exact singular solution for the dynamically generated quark mass function can be obtained by substituting this expression into the Eq. (5.15).

## B. IR vanishing quark propagator

For the IR vanishing (IRV) type of the quark propagator, when  $Z_2(\epsilon)$  vanishes as  $\epsilon$  goes to zero, the final system of equations (5.1) becomes

$$\begin{aligned} \bar{S}^{-1}(p) &= i\bar{m}_0 + \bar{g}^2 \bar{\Gamma}_\mu(p, 0) \bar{S}(p) \gamma_\mu, \\ \Gamma_\mu(p, 0) &= id_\mu S^{-1}(p) - S(p) \Gamma_\mu(p, 0) S^{-1}(p), \end{aligned} \quad (5.16)$$

where, obviously,  $\bar{m}_0 = Z_2(\epsilon)m_0(\epsilon)$  exists as  $\epsilon$  goes to zero. Just this type of the quark propagator in the light-cone gauge has been first investigated by 't Hooft [1]. In terms of

the dimensionless variables (5.7), similar to the previous case, the system (5.16) can be reduced to

$$\begin{aligned} xA' &= -A - 1 - \bar{m}_0 B, \\ 2BB' &= -A^2 + 2\bar{m}_0 AB, \end{aligned} \quad (5.17)$$

where again  $A \equiv A(x)$ ,  $B \equiv B(x)$ , and the prime denotes the derivative with respect to the Euclidean dimensionless momentum variable  $x$ . For simplicity, we use the same notation for the dimensionless current quark mass, i.e.,  $\bar{m}_0/\bar{g} \rightarrow \bar{m}_0$ .

The exact solution of this system for the dynamically generated quark mass function is

$$B^2(c, \bar{m}_0; x) = \int_x^c \tilde{\nu}(x') dx', \quad (5.18)$$

where  $c$  is the corresponding constant of integration and

$$\tilde{\nu}(x) = A^2(x) + 2A(x)\nu(x) \quad (5.19)$$

with

$$\nu(x) = -\bar{m}_0 B(x) = xA'(x) + A(x) + 1. \quad (5.20)$$

Then the equation determining the  $A(x)$  function becomes

$$\frac{d\nu^2(x)}{dx} = -A^2(x)\bar{m}_0^2 - 2A(x)\nu(x)\bar{m}_0^2. \quad (5.21)$$

In the chiral limit ( $\bar{m}_0 = 0$ ) exact solutions are

$$A_0(x) = -1 + \frac{c'_0}{x}, \quad (5.22)$$

and

$$B_0^2(c_0, x) = \int_x^{c_0} A^2(x') dx', \quad (5.23)$$

where  $c'_0$  and  $c_0$  are the corresponding constants of integration, respectively. Regularity at zero implies  $c'_0 = 0$ , so that one finally obtains

$$A_0(x) = -1, \quad B_0^2(c_0, x) = (c_0 - x), \quad (5.24)$$

where we retain the same definition and notation as previously for the constant of integration  $c_0$ . Again as in the previous case, it should be kept finite (but it remains arbitrary) as well as a simultaneous limit  $x, c_0 \rightarrow \infty$  for the dynamically generated quark mass function  $B_0^2(c_0, x)$  (5.23) is required.



## VI. QUARK CONFINEMENT

In principle, it is possible to develop the calculation schemes in different modifications which give the solution of both systems (5.9) and (5.17) step by step in powers of the light current quark masses as well as in the inverse powers of the heavy quark masses.

The important observation, however, is that the formal exact solutions (5.10) and (5.18) exhibit the algebraic branch point at  $x = c$  which completely *excludes the pole – type singularity* at any finite point on the real axis in the  $x$ -complex plane whatever the solution for the  $A(x)$  function might be. Thus the solution cannot be presented in either case as the expression having finally a pole-type singularity at any finite point  $p^2 = -m^2$  (Euclidean signature), i.e.,

$$S(p) \neq \frac{\text{const}}{\hat{p} + m}, \quad (6.1)$$

certainly satisfying thereby the first necessary condition of quark confinement formulated at the fundamental quark level as the absence of a pole-type singularity in the quark propagator [19].

In order to confirm this, let us assume the opposite to Eq. (6.1), i.e., that is the quark propagator within our approach may have a pole-type singularity like the electron propagator has in quantum electrodynamics (QED) (see Eq. (6.4) below). In terms of the dimensionless quark form factors, defined in Eq. (5.7), this means that in the neighborhood of the assumed pole at  $x = -m^2$  (Euclidean signature), they can be presented as follows:

$$\begin{aligned} A(x) &= \frac{1}{(x + m^2)^\alpha} \tilde{A}(x), \\ B(x) &= \frac{1}{(x + m^2)^\beta} \tilde{B}(x), \end{aligned} \quad (6.2)$$

where  $\tilde{A}(x)$  and  $\tilde{B}(x)$  are regular at a pole, while  $\alpha$  and  $\beta$  are in general arbitrary with  $\text{Re}\alpha, \beta \geq 0$ . However, substituting these expansions into the systems (5.9) and (5.17) and analyzing them in the neighborhood of the assumed pole, one can immediately conclude in that the self-consistent systems for the quantities with tilde exists iff

$$\alpha = \beta = 0, \quad (6.3)$$

i.e., our systems (5.9) and (5.17) do not admit the pole-type singularities in the quark propagator in complete agreement with the above-mentioned.

This point deserves a more detail discussion, indeed. The IR asymptotics of the electron propagator in QED is [20] (Minkowski signature)

$$S(p) \sim \frac{1}{(p^2 - m^2)^{1+\beta}}, \quad (6.4)$$

where  $\beta = \alpha(\xi - 3)/2\pi$  and here  $\alpha$  is the renormalized charge. Thus instead of a simple pole, it has a cut whose strength can be varied by changing the gauge fixing parameter  $\xi$ . However, there is, in general, the pole-type singularity at the electrom mass  $m$ , indeed, i.e., in QED there is no possibility, in general, to escape a pole-type singularity in the electron

Green's function. Contrast to QED, our general solutions (5.10) and (5.18) have no pole-type singularities, only the branch points at  $x = c$ . Not losing generality, one can put  $c = p_c^2/\bar{g}^2$  (different  $p_c^2$  for different solutions, of course), then it follows that at the branch point  $p_c^2 = p^2$  and this does not explicitly depend on  $\xi$ . At the same time, it is obvious that the existence of a branch point itself does not depend explicitly on a gauge choice as well. Thus the absence of the pole-type singularities in QCD in the same way is gauge-invariant as the existence of the pole-type singularity at the electron mass in QED. This may be used indeed to differentiate QCD from QED and vice versa. The gauge invariance of the above-mentioned first necessary condition of quark confinement should be precisely understood in this sense.

Let us emphasize that the absence of the pole-type singularities in the quark propagator as the criterion of confinement at the fundamental quark level makes sense only for the *IR renormalized* quark propagator, i.e., for entities having sense in the  $\epsilon \rightarrow 0^+$  limit. To speak about quark confinement in the sense that the pole of the propagator is shifted towards infinity as  $\epsilon \rightarrow 0^+$ , and therefore there is no physical single quark state, is though possible, but confusing in our opinion (see Ref. [21] as well). The problem is that the quark propagator which is only IR regularized is not physical, and so cannot be used to analyse such physical phenomena as quark confinement, DCSB, etc.

The second sufficient condition formulated at the hadronic level as the existence of a discrete spectrum only (no continuum in the spectrum) [1] in the bound-state problems within the corresponding BS formalism is obviously beyond the scope of the present investigation. Let us only note here, that at nonzero temperature the bound-states will be dissolved (dehadronization), but the first necessary condition of the quark confinement criterion will remain valid, nevertheless. In other words, quarks at nonzero temperature (for example, in the quark-gluon plasma (QGP) [22]) will remain off-shell objects, i.e., even in this case they cannot be detected as physical particles (like electrons) in the asymptotic states. That is why it is better to speak about dehadronization phase transition in QGP rather than about deconfinement phase transition.

In both cases the region  $c \geq x$  can be considered as NP whereas the region  $c \leq x$  can be considered as the PT one. Approximating the full gluon propagator by its free counterpart in the whole range  $[0, \infty)$ , nevertheless, we obtain a solution for the dynamically generated quark mass function  $B(x)$  which manifests the existence of the boundary value momentum (dimensionless)  $c$  (in the chiral limit  $c_0$ ) separating the PT region from the NP one, where the NP effects such as confinement and DCSB become dominant. The arbitrary constant of integration  $c$  ( $c_0$ ) is related to the characteristic mass which in 2D QCD is nothing else but the coupling constant. So in 2D QCD (unlike 4D QCD) there is no need to introduce explicitly into the quantum YM theory the characteristic mass scale parameter, the so-called Jaffe-Witten (JW) mass gap [23,24].

As was mentioned above, our solutions to the IR renormalized quark propagator are valid in the whole momentum range  $[0, \infty)$ . However, in order to calculate any physical observable from first principles (represented by the corresponding correlation function which can be expressed in terms of the quark propagator integrated out), it is necessary to restrict ourselves to the integration over the NP region  $x \leq c$  ( $x \leq c_0$ ) only. This guarantees us that the above-mentioned unphysical singularity (branch-point at  $x = c$  ( $x = c_0$ )) will not affect the numerical values of the physical quantities. Evidently, this is equivalent to

the subtraction of the contribution in the integration over the PT region  $x \geq c$  ( $x \geq x_0$ ). Let us underline that at the hadronic level this is the only subtraction which should be done "by hand" (see discussion below in section XII, however) since our solutions to the IR renormalized quark SD equations are automatically NP. Thus there is no need for additional subtraction of all types of the PT contributions at the fundamental quark-gluon level in order to deal with the only true NP quantities. In this connection, let us remind the reader that many important quantities in QCD such as gluon and quark condensates, topological susceptibility, etc. are defined beyond the PT theory only [25,26]. This means that they are determined by such  $S$ -matrix elements (correlation functions) from which all types of the PT contributions should be subtracted, by definition, indeed (see next section).

## VII. DYNAMICAL BREAKDOWN OF CHIRAL SYMMETRY (DBCS)

From a coupled systems of the differential equations (5.9) and (5.17) it is easy to see that these systems (for the system (5.17) the replacement  $m_0 \rightarrow \bar{m}_0$  is assumed)

*allow a chiral symmetry breaking solution only,*

$$m_0 = 0, \quad A(x) \neq 0, \quad B(x) \neq 0 \quad (7.1)$$

*and forbid a chiral symmetry preserving solution,*

$$m_0 = B(x) = 0, \quad A(x) \neq 0. \quad (7.2)$$

Thus any nontrivial solutions automatically break the  $\gamma_5$  invariance of the quark propagator

$$\{\gamma_5, S^{-1}(p)\} = -i\gamma_5 2\bar{B}(p^2) \neq 0, \quad (7.3)$$

and they therefore *certainly* lead to the spontaneous chiral symmetry breakdown at the fundamental quark level ( $m_0 = 0$ ,  $\bar{B}(x) \neq 0$ , dynamical quark mass generation). In all previous investigations a chiral symmetry preserving solution (7.2) always exists. For simplicity, we do not distinguish between  $B(x)$  and  $\bar{B}(x)$  calling both dynamically generated quark mass functions.

A few preliminary remarks are in order. A nonzero, dynamically generated quark mass function defined by conditions (7.1) and (7.3) is the order parameter of DBCS at the fundamental quark level. At the phenomenological level the order parameter of DBCS is the nonzero quark condensate defined as the integral of the trace of the quark propagator, i.e., (Euclidean signature, see Eq. (5.2))

$$\langle \bar{q}q \rangle = \langle 0 | \bar{q}q | 0 \rangle \sim i \int d^2p \text{Tr} S(p), \quad (7.4)$$

up to unimportant (here and below in this section for our discussion) numerical factors. In terms of the dimensionless variables (5.5) it becomes

$$\langle \bar{q}q \rangle_0 \sim -\bar{g} \int dx B_0(x), \quad (7.5)$$

where for light quarks in the chiral limit  $\langle \bar{q}q \rangle_0 = \langle \bar{u}u \rangle_0 = \langle \bar{d}d \rangle_0 = \langle \bar{s}s \rangle_0$ , by definition, and integration over  $x$  is assumed from zero to infinity.

It is worth to emphasize now that the phenomenological order parameter of DBCS - the quark condensate - defined as the dynamically generated quark mass function  $B(x)$  integrated out might be in principle zero even when the mass function is definitely nonzero. Thus the nonzero, dynamically generated quark mass is a much more appropriate condition of DBCS than the quark condensate. One can say that this is the first necessary condition of DBCS, while the nonzero quark condensate is only the second sufficient one.

However, this is not the whole story yet. The problem is that the quark condensate defined in Eq. (7.5) still contains the contribution in the integration over the PT region, say,  $[y_0, \infty)$ . In order to define correctly the quark condensate this contribution should be subtracted, i.e.,

$$\langle \bar{q}q \rangle_0 \implies \langle \bar{q}q \rangle_0 + \bar{g} \int_{y_0}^{\infty} dx B_0(x) = -\bar{g} \int_0^{y_0} dx B_0(x). \quad (7.6)$$

If now the mass function  $B(x)$  is really the NP solution of the corresponding quark SD equation, then this definition gives the quark condensate beyond the PT theory. In our case this is so, indeed. Moreover, it is easy to understand that in order to guarantee that the algebraic branch point at  $x = c_0$  will not affect the numerical value of the quark condensate, the soft cutoff  $y_0$  should be identified with the constant of integration  $c_0$ . Thus in our case it becomes

$$\langle \bar{q}q \rangle_0 \sim -\bar{g} \int_0^{c_0} dx B_0(c_0, x), \quad (7.7)$$

i.e., the truly NP dynamically generated quark mass function is integrated out over the NP region as well. So there is not even a bit of PT information in this definition (all types of the PT contributions have been already subtracted in Eq. (7.7)). Moreover, it depends on the fundamental mass scale parameter of 2D QCD which is the IR renormalized coupling constant  $\bar{g}$  and not on the arbitrary mass scales  $1 \text{ GeV}$ ,  $2 \text{ GeV}$ , etc. In the PT limit  $\bar{g} \rightarrow 0$  the quark condensate goes to zero as it should be, by definition ( $B_0(c_0, x)$  tends to zero in the PT limit  $c_0, x \rightarrow \infty$  as well). Thus in our approach the quark condensate itself has a physical meaning, while in other approaches, for example, in lattice QCD or in QCD sum rules neither the quark condensate nor the current quark mass has physical meaning by itself. Only their multiplication product gains a physical sense becoming thus renormgroup invariant. In the same way the quark condensate should be defined in 4D QCD though there is a problem with the JW mass gap as was mentioned above.

## VIII. IR MULTIPLICATIVE RENORMALIZABILITY OF 2D QCD

It is well known that 2D QCD is an UV, i.e., PT super-renormalizable field theory [2,6]. However, the DT clearly shows that this theory is IR divergent since its free gluon propagator IR singularity is a NP (i.e., severe) one. For that very reason, it becomes inevitable firstly to regularize it (which has been already done), and then to prove its IR renormalizability, i.e., to prove that all the NP IR singularities can be removed from the theory on a general ground and in a self-consistent way. In order to formulate the IRMR program in 2D QCD, it is necessary to start from the quark-ghost sector.

### A. IRMR program in the quark-ghost sector

The IRMR program in the quark-ghost sector is based on the corresponding IR convergence conditions: the quark SD condition (2.6), the ghost self-energy condition (3.9), the quark ST identity condition (4.8) and quark ST identity IR convergence relation (4.5). However, taking into account the relation (4.9), only three of them are independent since by combining the ghost self-energy condition (3.9) with the general ST identity relation (4.5), one obtains the IR convergence condition (4.8). Reminding the relation (3.7)  $\tilde{Z}_2(\epsilon) = \tilde{Z}^{-1}(\epsilon)$  and that the "IRMR constant"  $\tilde{Z}_B$  does not depend on  $\epsilon$ , i.e.,  $\tilde{Z}_B(\epsilon) = \tilde{Z}_B$ , the independent system of the IR convergence conditions can be written as follows:

$$\begin{aligned} X(\epsilon)Z_2^2(\epsilon)Z_1^{-1}(\epsilon) &= \epsilon Y_q, \\ X(\epsilon)\tilde{Z}_1(\epsilon)\tilde{Z}^{-2}(\epsilon) &= \epsilon Y_g, \quad \epsilon \rightarrow 0^+, \\ Z_1^{-1}(\epsilon)\tilde{Z}(\epsilon) &= Z_2^{-1}(\epsilon)\tilde{Z}_B. \end{aligned} \tag{8.1}$$

Thus, in general, we have five independent IRMR constants:  $X(\epsilon)$ ,  $Z_2(\epsilon)$ ,  $Z_1(\epsilon)$ ,  $\tilde{Z}_1(\epsilon)$  and  $\tilde{Z}(\epsilon)$ . We have also three arbitrary but finite constants  $Y_q$ ,  $Y_g$  and  $\tilde{Z}_B$ . We know that the quark wave function IRMR constant  $Z_2(\epsilon)$  cannot be singular, while the ghost self-energy IRMR constant  $\tilde{Z}(\epsilon)$  is either singular or constant as  $\epsilon \rightarrow 0^+$ , otherwise all the IRMR constants remain arbitrary in this limit.

Let us show now that the above-mentioned finite constants  $Y_q$ ,  $Y_g$  and  $\tilde{Z}_B$  can be put to unity without losing generality. For this purpose, let us redefine all the IRMR constants as follows:

$$\begin{aligned} X(\epsilon) &= Y_q \tilde{Z}_B^{-2} X'(\epsilon), \quad Z_2(\epsilon) = \tilde{Z}_B Z_2'(\epsilon), \quad Z_1(\epsilon) = Z_1'(\epsilon), \\ \tilde{Z}_1(\epsilon) &= Y_g Y_q^{-1} \tilde{Z}_B^2 \tilde{Z}_1'(\epsilon), \quad \tilde{Z}(\epsilon) = \tilde{Z}'(\epsilon). \end{aligned} \tag{8.2}$$

Then it is easy to see that a new system for the IRMR constants with primes looks like the previous system (8.1) if one puts there

$$\tilde{Z}_B = Y_q = Y_g = 1. \tag{8.3}$$

Thus in fact our system (8.1) is

$$\begin{aligned} X(\epsilon)Z_2^2(\epsilon)Z_1^{-1}(\epsilon) &= \epsilon, \\ X(\epsilon)\tilde{Z}_1(\epsilon)\tilde{Z}^{-2}(\epsilon) &= \epsilon, \quad \epsilon \rightarrow 0^+, \\ Z_1^{-1}(\epsilon)\tilde{Z}(\epsilon) &= Z_2^{-1}(\epsilon), \end{aligned} \tag{8.4}$$

so we have three conditions for the above-mentioned five independent IRMR constants. Obviously, this system has always a nontrivial solution determining three of the constants in terms of two arbitrary chosen independent IRMR constants. It is convenient to choose  $\tilde{Z}(\epsilon)$  and  $Z_2(\epsilon)$  as two independent IRMR constants since we know their possible behavior with respect to  $\epsilon$  as it goes to zero. Then the general solution of the system (8.4) can be written as follows:

$$X(\epsilon) = \epsilon Z_2^{-1}(\epsilon)\tilde{Z}(\epsilon), \quad Z_1(\epsilon) = \tilde{Z}_1(\epsilon) = Z_2(\epsilon)\tilde{Z}(\epsilon). \tag{8.5}$$

Thus in the quark-ghost sector the self-consistent IRMR program really exists. Moreover, it has room for additional specifications. The most interesting case is the quark propagator which is IR finite from the very beginning, i.e., when the quark wave function IRMR constant  $Z_2(\epsilon) = Z_2 = \text{const}$ . In this case the system (8.4) becomes

$$\begin{aligned} X(\epsilon)Z_1^{-1}(\epsilon) &= \epsilon Z_2^{-2}, \\ X(\epsilon)\tilde{Z}_1(\epsilon)\tilde{Z}^{-2}(\epsilon) &= \epsilon, \quad \epsilon \rightarrow 0^+, \\ Z_1^{-1}(\epsilon)\tilde{Z}(\epsilon) &= Z_2^{-1}. \end{aligned} \quad (8.6)$$

Again, let us redefine all the IRMR constants as follows:

$$X(\epsilon) = Z_2^{-1}X'(\epsilon), \quad Z_1(\epsilon) = Z_2Z_1'(\epsilon), \quad \tilde{Z}_1(\epsilon) = Z_2\tilde{Z}_1'(\epsilon), \quad \tilde{Z}(\epsilon) = \tilde{Z}'(\epsilon). \quad (8.7)$$

Then the system for quantities with primes will be the same as the previous one, putting there  $Z_2 = 1$ . This means that in fact our system (8.6) in this case is

$$\begin{aligned} X(\epsilon)Z_1^{-1}(\epsilon) &= \epsilon, \\ X(\epsilon)\tilde{Z}_1(\epsilon)\tilde{Z}^{-2}(\epsilon) &= \epsilon, \quad \epsilon \rightarrow 0^+, \\ Z_1^{-1}(\epsilon)\tilde{Z}(\epsilon) &= 1, \end{aligned} \quad (8.8)$$

which determines now four independent IRMR constants:  $X(\epsilon)$ ,  $Z_1(\epsilon)$ ,  $\tilde{Z}_1(\epsilon)$ ,  $\tilde{Z}(\epsilon)$ . Its solution is

$$X(\epsilon) = \epsilon\tilde{Z}(\epsilon), \quad \tilde{Z}(\epsilon) = \tilde{Z}_1(\epsilon) = Z_1(\epsilon), \quad (8.9)$$

in complete agreement with the general solution (8.5).

It is worth to investigate in detail the case when  $\tilde{Z}(\epsilon) = KZ_2^{-1}(\epsilon)$ , where  $K$  is an arbitrary but finite constant (see subsection C below). Then the general system (8.4) becomes

$$\begin{aligned} X(\epsilon)Z_2^2(\epsilon) &= \epsilon K, \\ X(\epsilon)\tilde{Z}_1(\epsilon)Z_2^2(\epsilon) &= \epsilon K^2, \quad \epsilon \rightarrow 0^+, \\ Z_1^{-1}(\epsilon) &= K^{-1}. \end{aligned} \quad (8.10)$$

Let us, as before, redefine all the IRMR constants in this system as follows:

$$X(\epsilon) = K^{-1}X'(\epsilon), \quad Z_1(\epsilon) = KZ_1'(\epsilon), \quad \tilde{Z}_1(\epsilon) = K\tilde{Z}_1'(\epsilon), \quad Z_2(\epsilon) = KZ_2'(\epsilon). \quad (8.11)$$

Then the system for quantities with primes will be the same as the previous one, putting there  $K = 1$ . This means that in fact our system (8.10) is

$$\begin{aligned} X(\epsilon)Z_2^2(\epsilon) &= \epsilon, \\ X(\epsilon)\tilde{Z}_1(\epsilon)Z_2^2(\epsilon) &= \epsilon, \quad \epsilon \rightarrow 0^+, \\ Z_1^{-1}(\epsilon) &= 1. \end{aligned} \quad (8.12)$$

Its solution is

$$X(\epsilon) = \epsilon Z_2^{-2}(\epsilon), \quad \tilde{Z}(\epsilon) = Z_2^{-1}(\epsilon) = \tilde{Z}_2^{-1}(\epsilon), \quad \tilde{Z}_1(\epsilon) = Z_1^{-1}(\epsilon) = 1, \quad (8.13)$$

again in complete agreement with the general solution (8.5). Evidently, the system (8.12) is equivalent to the general system (8.4) if one puts there the quark-gluon vertex IRMR constant to unity from the very beginning, i.e.,  $Z_1^{-1}(\epsilon) = Z_1^{-1} = 1$ .

The fact that all the arbitrary but finite constants can be put equal to unity is a general feature of our IRMR program in the quark-ghost sector which enables us to remove all the severe IR divergences from the theory in a self-consistent way. This is important, since otherwise these arbitrary but different, finite constants having no physical meaning would “contaminate” the equations of motion (see, for example, the quark SD equation (2.7)). Concluding this subsection, let us emphasize once more that in the quark-ghost sector the IRMR program is definitely self-consistent.

### B. IR finite ST identities for pure gluon vertices

In order to determine the IR finite bound-state problem within the BS formalism, it is necessary to know the IRMR constants of the three- and four-gluon proper vertex functions which satisfy the corresponding ST identities [6,27-31]. This information is also necessary to investigate the IR properties of all other SD equations in 2D QCD. It is convenient to start from the ST identity for the three-gluon vertex [27,28]

$$[1 + b(k^2)]k_\lambda T_{\lambda\mu\nu}(k, q, r) = d^{-1}(q^2)G_{\lambda\nu}(q, k)(g_{\lambda\mu}q^2 - q_\lambda q_\mu) + d^{-1}(r^2)G_{\lambda\mu}(r, k)(g_{\lambda\nu}r^2 - r_\lambda r_\nu), \quad (8.14)$$

where  $k+q+r=0$  is assumed and  $d^{-1}$  is the inverse of the exact gluon form factor, while  $G$ 's are the corresponding ghost-gluon vertices (3.3). Let us now introduce the IR renormalized triple gauge field proper vertex as follows:

$$T_{\lambda\mu\nu}(k, q, r) = Z_3(\epsilon)\bar{T}_{\lambda\mu\nu}(k, q, r), \quad \epsilon \rightarrow 0^+, \quad (8.15)$$

where  $\bar{T}_{\lambda\mu\nu}(k, q, r)$  exists as  $\epsilon$  goes to zero, by definition. Passing to the IR renormalized quantities, one obtains

$$[\tilde{Z}^{-1}(\epsilon) + \bar{b}(k^2)]k_\lambda \bar{T}_{\lambda\mu\nu}(k, q, r) = \bar{G}_{\lambda\nu}(q, k)d^{-1}(q^2)(g_{\lambda\mu}q^2 - q_\lambda q_\mu) + \bar{G}_{\lambda\mu}(r, k)d^{-1}(r^2)(g_{\lambda\nu}r^2 - r_\lambda r_\nu), \quad (8.16)$$

so that the following IR convergence relation holds

$$Z_3(\epsilon) = \tilde{Z}^{-1}(\epsilon)\tilde{Z}_1(\epsilon), \quad \epsilon \rightarrow 0^+. \quad (8.17)$$

Let us make a few remarks. Here and below we are considering the inverse of the free gluon propagator as IR finite from the very beginning, i.e.,  $d^{-1} \equiv \bar{d}^{-1} = 1$ . This is not a singularity at all and therefore it should not be treated as a distribution [9] (there is no integration over its momentum).

The corresponding ST identity for the quartic gauge field vertex is [27,28]

$$[1 + b(p^2)]p_\lambda T_{\lambda\mu\nu\delta}(p, q, r, s) = d^{-1}(q^2)(g_{\lambda\mu}q^2 - q_\lambda q_\mu)B_{\lambda\nu\delta}^g(q, p; r, s) + d^{-1}(r^2)(g_{\lambda\nu}r^2 - r_\lambda r_\nu)B_{\lambda\mu\delta}^g(r, p; q, s)$$

$$\begin{aligned}
& + d^{-1}(s^2)(g_{\lambda\delta}s^2 - s_\lambda s_\delta)B_{\lambda\mu\nu}^g(s, p; q, r) \\
& - T_{\mu\lambda\delta}(q, s, -q, -s)G_{\lambda\nu}(q + s, p, r) \\
& - T_{\mu\nu\lambda}(q, r, -q, -r)G_{\lambda\delta}(q + r, p, s) \\
& - T_{\nu\delta\lambda}(r, s, -r, -s)G_{\lambda\mu}(r + s, p, q),
\end{aligned} \tag{8.18}$$

where  $p + q + r + s = 0$  is assumed. Here T's and G's are the corresponding three- and ghost-gluon vertices, respectively. The quantity  $B^g$  with three Dirac indices is the corresponding ghost-gluon scattering kernel which is shown in Fig. 4 (see also Refs. [6,29]).

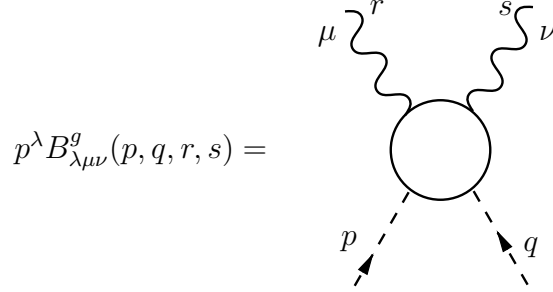

FIG. 4. The ghost-gluon scattering kernel.

Let us introduce now its IR renormalized counterpart as follows:

$$B_{\lambda\nu\delta}^g(q, p; r, s) = \tilde{Z}_g(\epsilon)\bar{B}_{\lambda\nu\delta}^g(q, p; r, s), \quad \epsilon \rightarrow 0^+, \tag{8.19}$$

where  $\bar{B}_{\lambda\nu\delta}^g(q, p; r, s)$  exists as  $\epsilon$  goes to zero. From the decomposition of the ghost-gluon proper vertex shown in Fig. 5, it follows that

$$\tilde{Z}_1(\epsilon) = \frac{1}{\epsilon}X(\epsilon)\tilde{Z}_2(\epsilon)\tilde{Z}_g(\epsilon), \quad \epsilon \rightarrow 0^+, \tag{8.20}$$

so that

$$\tilde{Z}_g(\epsilon) = \epsilon X^{-1}(\epsilon)\tilde{Z}(\epsilon)\tilde{Z}_1(\epsilon), \quad \epsilon \rightarrow 0^+. \tag{8.21}$$

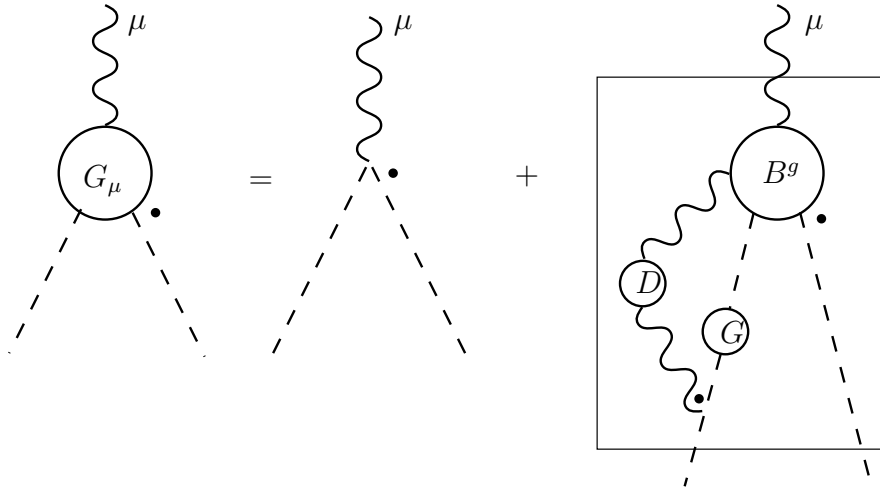

FIG. 5. The decomposition of the ghost-gluon proper vertex.



It is worth reminding that to each ghost-gluon vertex a factor  $\sqrt{X(\epsilon)}$  should be additionally assigned, while to the scattering kernel  $B^g$  with two external gluon legs a factor  $X(\epsilon)$  should be additionally assigned.

Let us now introduce the IR renormalized four-gluon gauge field vertex as follows:

$$T_{\lambda\mu\nu\delta}(p, q, r, s) = Z_4(\epsilon)\bar{T}_{\lambda\mu\nu\delta}(p, q, r, s), \quad \epsilon \rightarrow 0^+, \quad (8.22)$$

where  $\bar{T}_{\lambda\mu\nu\delta}(p, q, r, s)$  exists as  $\epsilon$  goes to zero, by definition. Passing again to the IR renormalized quantities, one obtains

$$\begin{aligned} [\tilde{Z}^{-1}(\epsilon) + \bar{b}(p^2)]p_\lambda\bar{T}_{\lambda\mu\nu\delta}(p, q, r, s) &= d^{-1}(q^2)(g_{\lambda\mu}q^2 - q_\lambda q_\mu)\bar{B}_{\lambda\nu\delta}^g(q, p; r, s) \\ &+ d^{-1}(r^2)(g_{\lambda\nu}r^2 - r_\lambda r_\nu)\bar{B}_{\lambda\mu\delta}^g(r, p; q, s) \\ &+ d^{-1}(s^2)(g_{\lambda\delta}s^2 - s_\lambda s_\delta)\bar{B}_{\lambda\mu\nu}^g(s, p; q, r) \\ &- \bar{T}_{\mu\lambda\delta}(q, s, -q, -s)\bar{G}_{\lambda\nu}(q + s, p, r) \\ &- \bar{T}_{\mu\nu\lambda}(q, r, -q, -r)\bar{G}_{\lambda\delta}(q + r, p, s) \\ &- \bar{T}_{\nu\delta\lambda}(r, s, -r, -s)\bar{G}_{\lambda\mu}(r + s, p, q), \end{aligned} \quad (8.23)$$

iff

$$Z_4(\epsilon) = Z_3^2(\epsilon) = \tilde{Z}^{-2}(\epsilon)\tilde{Z}_1^2(\epsilon), \quad \epsilon \rightarrow 0^+. \quad (8.24)$$

Evidently, in the derivation of this expression the general solution (8.5) has been used as well as Eqs. (8.17) and (8.21). Thus we have determined the IRMR constants of the triple and quartic gauge field vertices in Eqs. (8.17) and (8.24), respectively.

### C. IR finite bound-state problem

Apart from quark confinement and DBCS, the bound-state problem is one of the most important NP problems in QCD. The general formalism for considering it in quantum field theory is the BS equation ([32,33] and references therein). For the color-singlet, flavor-nonsinglet bound-state amplitudes for mesons it is shown in Figs. 6 and 7.

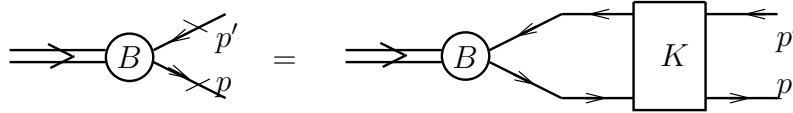

FIG. 6. The BS equation for the flavored mesons.

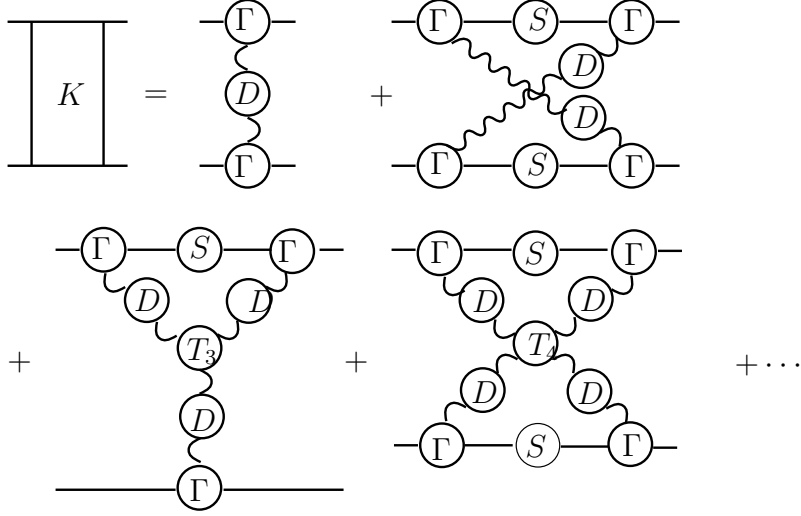

FIG. 7. The skeleton expansion for the 2PI BS scattering kernel.

Flavor-singlet mesons require a special treatment since pairs, etc. of gluons in color-singlet states can contribute to the direct-channel processes. The exact BS equation for the bound-state meson amplitude  $B(p, p')$  can be written analytically as follows (Euclidean signature):

$$S_q^{-1}(p)B(p, p')S_{\bar{q}}^{-1}(p') = i \int d^n l K(p, p'; l)B(p, p'; l), \quad (8.25)$$

(for simplicity all numerical factors are suppressed), where  $S_q^{-1}(p)$  and  $S_{\bar{q}}^{-1}(p')$  are inverse quark and antiquark propagators, respectively, and  $K(p, p'; l)$  is the two-particle irreducible (2PI) BS scattering kernel (its skeleton expansion is shown in Fig. 7) which defines the BS equation itself. The BS equation is a homogeneous linear integral equation for the  $B(p, p')$  amplitude. For this reason the meson bound-state amplitude should be always considered as IR finite from the very beginning, i.e.,  $B(p, p') \equiv \bar{B}(p, p')$ . Passing to the IR renormalized quantities in this equation, one obtains

$$\bar{S}_q^{-1}(p)B(p, p')\bar{S}_{\bar{q}}^{-1}(p') = i \int d^n l \bar{K}(p, p'; l)B(p, p'; l), \quad (8.26)$$

iff

$$Z_2^{-2}(\epsilon) = Z_K(\epsilon), \quad \epsilon \rightarrow 0^+, \quad (8.27)$$

where we introduce the IRMR constant  $Z_K(\epsilon)$  of the BS scattering kernel. This is the exact BS equation IR convergence condition.

In general, the  $n$ th skeleton diagram of the BS equation skeleton expansion contains  $n$  independent loop integrations over the gluon momentum which (as we already know) generates a factor  $1/\epsilon$  each,  $n_1$  quark-gluon vertex functions and  $n_2$  quark propagators. Also it contains  $n_3$  and  $n_4$  three and four-gluon vertices, respectively. It is worth reminding that to each quark-gluon vertex and three-gluon vertex a factor  $\sqrt{X(\epsilon)}$  should be additionally assigned, while to the four-gluon vertex a factor  $X(\epsilon)$  should be additionally assigned. Thus the corresponding IRMR constant is equal to

$$Z_K^{(n)}(\epsilon) = \epsilon^{-n} [Z_1^{-1}(\epsilon)]^{n_1} [Z_2(\epsilon)]^{n_2} [Z_3(\epsilon)]^{n_3} [Z_4(\epsilon)]^{n_4} [X(\epsilon)]^{n_4 + (n_3 + n_1)/2}. \quad (8.28)$$

On the other hand, it is easy to see that for each skeleton diagram the following relations hold

$$n_2 = n_1 - 2, \quad 2n = n_1 + n_3 + 2n_4. \quad (8.29)$$

Substituting these relations into the previous expression and using the general solution (8.5), as well as taking into account results of the previous subsection, one finally obtains

$$Z_K^{(n)}(\epsilon) = Z_2^{-2}(\epsilon) [Z_2(\epsilon) \tilde{Z}(\epsilon)]^{n-n_1}, \quad (8.30)$$

so that from Eq. (8.27) it follows that

$$[Z_2(\epsilon) \tilde{Z}(\epsilon)]^{n-n_1} = A_{(n)}, \quad (8.31)$$

where  $A_{(n)}$  is an arbitrary but finite constant different, in principle, for each skeleton diagram. Evidently, its solution is

$$\tilde{Z}(\epsilon) = [A_{(n)}]^{-\frac{1}{n_1-n}} Z_2^{-1}(\epsilon). \quad (8.32)$$

Let us emphasize now that the relation between these (and all other) IRMR constants cannot depend on the fact which skeleton diagram is considered. This means that the above-mentioned arbitrary but finite constant must be a common factor for all skeleton diagrams, i.e.,  $[A_{(n)}]^{-\frac{1}{n_1-n}} = K$ , where  $K$  is again arbitrary but finite and the solution becomes

$$\tilde{Z}(\epsilon) = K Z_2^{-1}(\epsilon). \quad (8.33)$$

However, we have already shown that all arbitrary but finite IRMR constants, in particular this one (see relations (8.10)-(8.12)), should be put to unity not losing generality.

Thus in order to determine the bound-state problem free from the IR singularities within the corresponding BS equation, the general solution (8.13) is relevant. This means that we can forget about the ghost self-energy IRMR constant and have to analyse everything in terms of the quark wave function IRMR constant just because of the relation (8.33) with  $K = 1$ . When it goes to zero as  $\epsilon \rightarrow 0^+$ , then the ghost self-energy IRMR constant is singular, while when  $Z_2(\epsilon) = Z_2 = const.$ , then  $\tilde{Z}(\epsilon)$  is also constant and, as we already know, both constant can be put to one without losing generality.

#### D. The general system of the IR convergence conditions

The general system of the IR convergence conditions (8.13) for removing at this stage all the severe IR singularities on a general ground and in self-consistent way from the theory becomes

$$\begin{aligned} X(\epsilon) &= \epsilon Z_2^{-2}(\epsilon), & \tilde{Z}^{-1}(\epsilon) &= \tilde{Z}_2(\epsilon) = Z_3(\epsilon) = \tilde{Z}_g(\epsilon) = Z_2(\epsilon), \\ \tilde{Z}_1(\epsilon) &= Z_1^{-1}(\epsilon) = 1, & Z_4(\epsilon) &= Z_3^2(\epsilon) = Z_2^2(\epsilon), \end{aligned} \quad (8.34)$$

and the limit  $\epsilon \rightarrow 0^+$  is always assumed. This system provides the cancellation of all the severe IR singularities in 2D QCD at this stage, and what is most important this system provides the IR finite bound-state problem within our approach. All the IRMR constants are expressed in terms of the quark wave function IRMR constant  $Z_2(\epsilon)$  except the quark-gluon and ghost-gluon proper vertices IRMR constants. They have been fixed to be unity though we were unable to investigate the corresponding ST identity for the latter vertex (as was mentioned in section III).

### IX. IR FINITE SD EQUATION FOR THE GLUON PROPAGATOR

Let us now investigate the IR properties of the SD equation for the gluon propagator which is shown diagrammatically in Fig. 8 (see also Refs. [34,35] and references therein). Analytically it can be written as follows:

$$D^{-1}(q) = D_0^{-1}(q) - \frac{1}{2}T_t(q) - \frac{1}{2}T_1(q) - \frac{1}{2}T_2(q) - \frac{1}{6}T'_2(q) + T_g(q) + T_q(q), \quad (9.1)$$

where numerical factors are due to combinatorics and, for simplicity, the Dirac indices determining the tensor structure are omitted.  $T_t$  (the so-called tadpole term) and  $T_1$  describe one-loop contributions, while  $T_2$  and  $T'_2$  describe two-loop contributions containing three- and four-gluon proper vertices, respectively. Evidently,  $T_g$ ,  $T_q$  describe ghost- and quark-loop contributions.

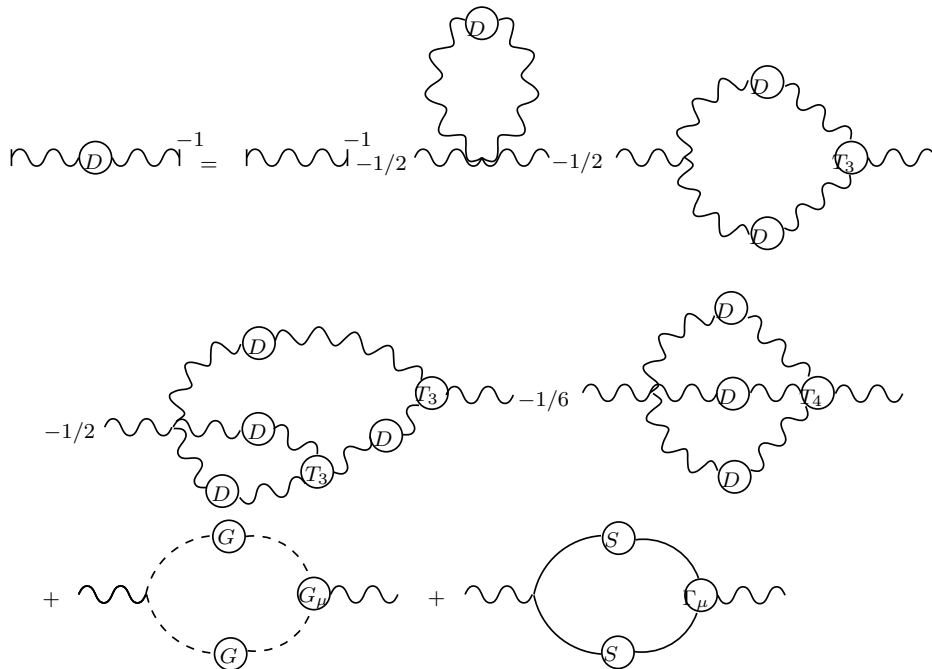

FIG. 8. The SD equation for the gluon propagator.

Equating  $D = D^0$  now and passing as usual to the IR renormalized quantities, one obtains

$$\begin{aligned} \frac{1}{\epsilon}X(\epsilon)\frac{1}{2}\bar{T}_t(q) + \frac{1}{\epsilon}X(\epsilon)Z_3(\epsilon)\frac{1}{2}\bar{T}_1(q) + \frac{1}{\epsilon^2}X^2(\epsilon)Z_3^2(\epsilon)\frac{1}{2}\bar{T}_2(q) + \frac{1}{\epsilon^2}X^2(\epsilon)Z_4(\epsilon)\frac{1}{6}\bar{T}'_2(q) \\ - \frac{1}{\epsilon}X(\epsilon)\tilde{Z}_2^2\tilde{Z}_1(\epsilon)\bar{T}_g(q) - X(\epsilon)Z_2^2(\epsilon)Z_1^{-1}(\epsilon)\bar{T}_q(q) = 0, \end{aligned} \quad (9.2)$$

where quantities with bar are, by definition, IR renormalized, i.e., they exist as  $\epsilon \rightarrow 0^+$ . Let us also remind that each independent loop integration over the gluon and ghost momenta generates the factor  $1/\epsilon$ , while it is easy to show that there are no additional IR singularities with respect to  $\epsilon$  in the quark loop (since we have found regular at zero solutions for the quark propagator). Using now the general solution (8.34), one further obtains

$$\frac{1}{2}\bar{T}_t(q) + Z_2(\epsilon)\frac{1}{2}\bar{T}_1(q) + \frac{1}{2}\bar{T}_2(q) + \frac{1}{6}\bar{T}'_2(q) - Z_2^2(\epsilon)\bar{T}_g(q) - \epsilon Z_2^2(\epsilon)\bar{T}_q(q) = 0. \quad (9.3)$$

Since the quark wave function IRMR constant  $Z_2(\epsilon)$  can be only either unity or vanishing as  $\epsilon$  goes to zero, the contribution from the quark loop is always suppressed in the  $\epsilon \rightarrow 0^+$  limit, and we are left with the pure YM SD equation for the gluon propagator. For the quark propagator which is IR renormalized from the very beginning (i.e.,  $Z_2(\epsilon) = Z_2 = 1$ , so that it is IR finite), the SD equation (9.3) becomes

$$\frac{1}{2}\bar{T}_t(q) + \frac{1}{2}\bar{T}_1(q) + \frac{1}{2}\bar{T}_2(q) + \frac{1}{6}\bar{T}'_2(q) = \bar{T}_g(q), \quad (9.4)$$

while for the IR vanishing type of the quark propagator ( $Z_2(\epsilon) \rightarrow 0$  as  $\epsilon \rightarrow 0^+$ ), the SD equation (9.3) becomes

$$\bar{T}_t(q) + \bar{T}_2(q) + \frac{1}{3}\bar{T}'_2(q) = 0. \quad (9.5)$$

Concluding, let us note that it is not surprising that the IR properties of the YM sector have been analyzed in terms of the quark wave function IRMR constant  $Z_2(\epsilon)$ . Equivalently, it can be analyzed in terms of the ghost self-energy or ghost propagator IRMR constants (because of the general solution (8.34)) which are closely related to pure gluonic degrees of freedom via the corresponding ST identities (see subsection B above). At the same time, the YM SD equations for the gluon propagator (9.4) and (9.5) remain the same, of course. The tensor structure of the YM SD equations for the gluon propagator is not important here. However, it may substantially simplify the corresponding IR renormalized YM SD Eqs. (9.4) and (9.5). Explicitly this should be done elsewhere.<sup>3</sup> What matters here is that the self-consistent equations for the gluon propagator free from the severe IR singularities exist in the YM sector within our approach. In other words, the general solution (8.34) eliminates all the severe IR singularities from the Eq. (9.1), indeed.

---

<sup>3</sup>Let us remind that formally the  $D = D^0$  solution always exists in the system of the SD equations due to its construction by expansion around the free field vacuum [6]. It is either trivial (coupling is zero) or nontrivial, then some additional condition (constraint), including other Green's functions, is to be derived. Eqs. (9.4) and (9.5) are precisely these exact constraints. The only question to be asked is whether this solution is justified to use in order to explain some physical phenomena, for example, quark confinement, DBCS, etc. or not (for our conclusions see final section XII).

## X. IR FINITE SD EQUATION FOR THE THREE-GLUON PROPER VERTEX

It is instructive to investigate the IR properties of the SD equation for the triple gauge field proper vertex since it provides a golden opportunity to fix  $Z_2(\epsilon)$ . This equation is shown in Fig. 9.

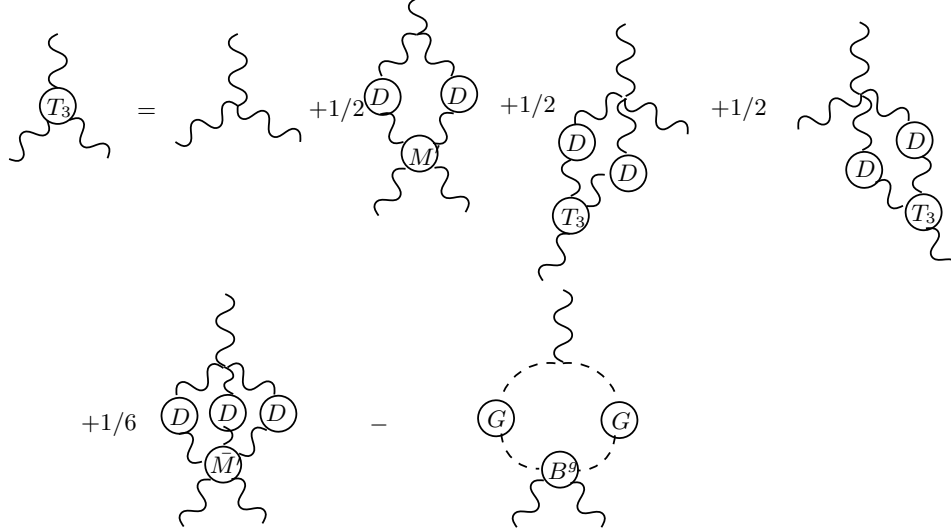

FIG. 9. The SD equation for the triple gauge field vertex.

The skeleton expansions of the corresponding kernels are shown in Fig. 10. Let us note that the ghost-gluon scattering kernel  $B^g$  (for which we have already established its IRMR constant from the decomposition of the ghost-gluon proper vertex shown in Fig. 5 in subsection B, see also the general solution (8.34)) is denoted as  $G'$  in Ref. [6]. Obviously, there is no need to investigate separately the IR properties of the SD equations for the quark-gluon vertex and for pure gluon vertices since the information about their IRMR constants has been uniquely extracted from the corresponding ST identities. Moreover, the IRMR constants of different types of the scattering kernels which enter the above-mentioned SD equations (see, for example Figs. 8, 9 and 10) are to be determined precisely by the general system (8.34). In principle, each skeleton diagram of the above-mentioned expansions should be investigated in the same way as was investigated the BS scattering kernel in subsection C.

Since we know already the IRMR constant of the triple gauge field proper vertex  $Z_3(\epsilon) = Z_2(\epsilon)$ , this makes it possible to establish the IRMR constant of each scattering kernel in general, i.e., not using its skeleton expansion. For this purpose, let us apply the same method which has been used in order to determine the IRMR constant of the above-mentioned ghost-gluon scattering kernel. From the last term in Fig. 9, it follows that

$$Z_3(\epsilon) = \frac{1}{\epsilon} X(\epsilon) \tilde{Z}_2^2(\epsilon) \tilde{Z}_g(\epsilon) = \tilde{Z}_g(\epsilon) = Z_2(\epsilon), \quad (10.1)$$

where in the second and third equalities the general solution (8.34) has been used. Let us remind only that a factor  $X(\epsilon)$  should be additionally assigned to kernels with two gluon external legs, while to the kernels with three gluon external legs a factor  $X^{3/2}(\epsilon)$  should

be additionally assigned. Thus we confirmed the result obtained earlier in subsection B for the IRMR constant of the ghost-gluon scattering kernel  $\tilde{Z}_g(\epsilon)$ . Let us emphasize that the left-hand side of the relation (10.1) should be equal to  $Z_3(\epsilon) = Z_2(\epsilon)$  since this skeleton diagram is nothing but the corresponding independent decomposition of the triple gauge field vertex itself.

However, the golden opportunity is provided by the third and fourth terms of this SD equation. The interesting feature of these terms is that they do not contain unknown scattering kernels, so their IR properties can be investigated directly by using only the known IRMR constants. On the other hand, these terms are nothing but the corresponding decompositions of the triple gauge field proper vertex with the IRMR constant is equal to  $Z_3(\epsilon) = Z_2(\epsilon)$ . Thus one has

$$Z_2(\epsilon) = \frac{1}{\epsilon} X(\epsilon) Z_2(\epsilon) = Z_2^{-1}(\epsilon) = 1, \quad (10.2)$$

which, obviously, has only a unique solution given by the last equality. Thus, we have finally fixed the quark wave function IRMR constant to be unity.

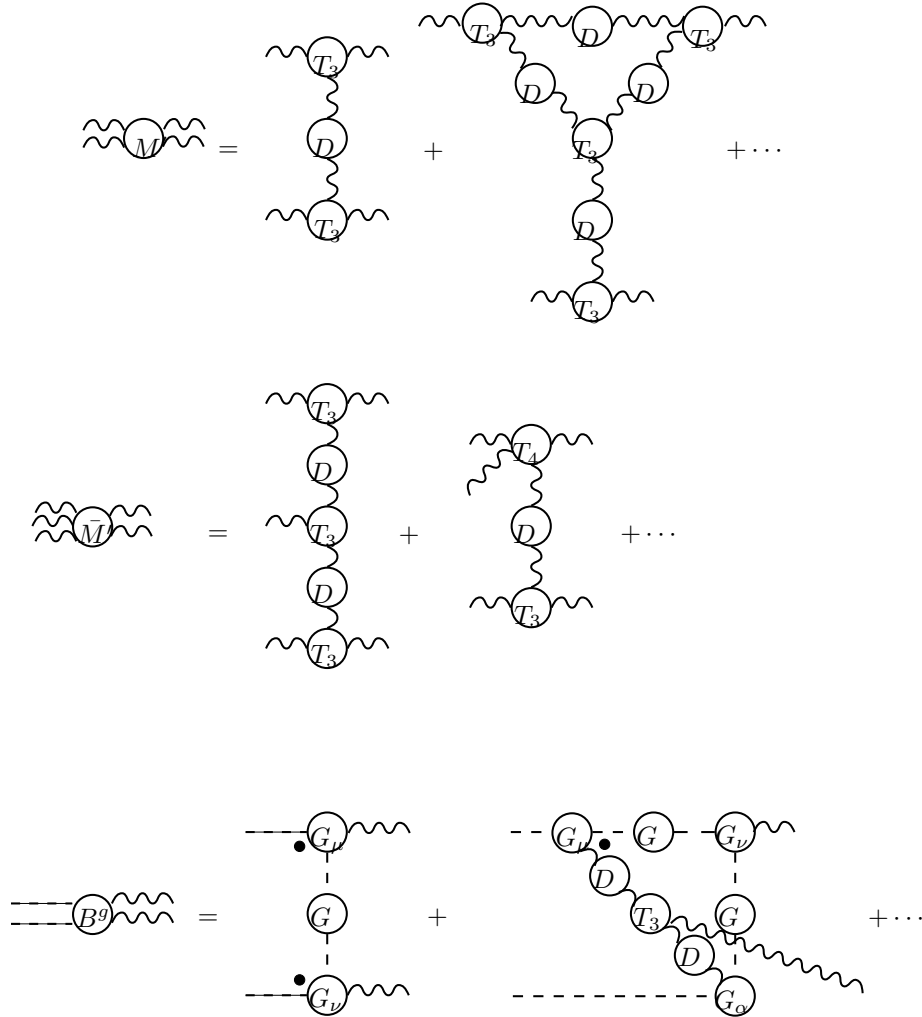

FIG. 10. The skeleton expansions of different scattering kernels in Fig. 9.

Adopting the same method, it is easy to show that all other IRMR constants for the corresponding scattering kernels are

$$\tilde{Z}_g(\epsilon) = Z_{M'}(\epsilon) = Z_{\bar{M}'}(\epsilon) = 1. \quad (10.3)$$

We are now ready to investigate the IR properties of the SD equation for the triple gauge field proper vertex shown in Fig. 9 without referring to the skeleton expansions of the corresponding scattering kernels (it is easy to check that the IRMR constants of these kernels are consistent with their skeleton expansions taking term by term). Using the previous results, the IR renormalized version of this equation is

$$\bar{T}_3 = T_3^{(0)} + \frac{1}{2}\bar{T}_1 + \frac{1}{2}\bar{T}'_1 + \frac{1}{2}\bar{T}''_1 + \frac{1}{6}\bar{T}_2 - \bar{T}_g, \quad (10.4)$$

where, for simplicity, we omit the dependence on momenta and suppress the Dirac indices (i.e., tensor structure) in all terms in this SD equation. As usual the quantities with bar are IR renormalized, i.e., they exist as  $\epsilon \rightarrow 0^+$ .

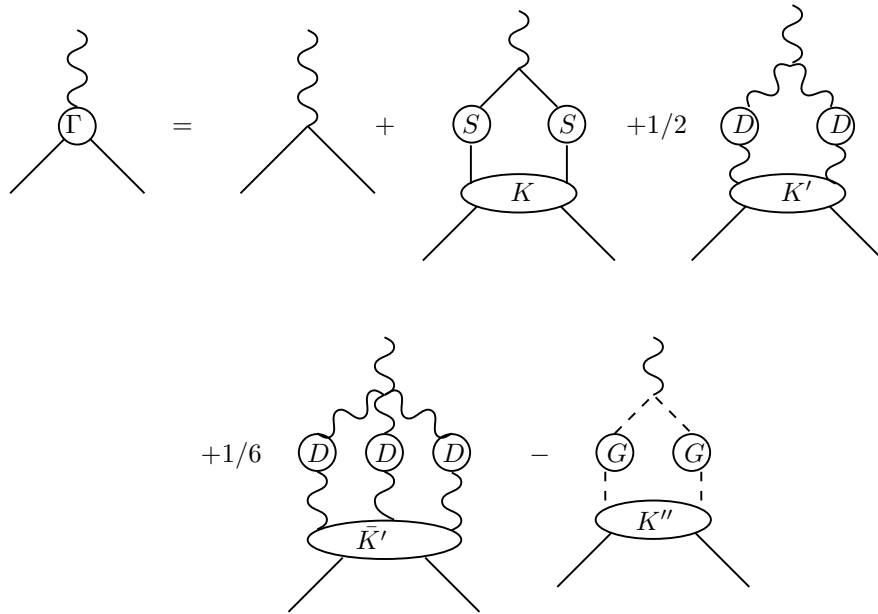

FIG. 11. The SD equation for the quark-gluon proper vertex. The  $K$ 's are the corresponding scattering kernels.

The SD equations for all other Green's functions can be investigated in the same way, in particular for the quark-gluon proper vertex shown in Fig. 11. The general solution (8.34), taking into account the fundamental relation (10.2), provides their IR convergence, i.e., they exist in the  $\epsilon \rightarrow 0^+$  limit and, hence, similar to the SD equations, explicitly considered here, they are free of the IR divergences with respect to  $\epsilon$ . Let us note that Eq. (9.5) should be ruled out as a possible SD equation for the gluon propagator and the SD equation (9.4) is the only possible one.



## XI. COMPARISON WITH THE 'T HOOFT MODEL

Having completed the proof of the IR renormalizability of our approach to 2D QCD, it is instructive to compare it with the 't Hooft model [1]. Of course, there is no direct comparison because of the different gauges used. Nevertheless, one can still compare the approximations made. It is well known that in the large  $N_c$  limit and fixed  $g^2 N_c$  the quark loops are suppressed to the leading order [1,8,36]. So the last term in the SD equation for the gluon propagator (9.1), shown in Fig. 8, vanishes. Due to light-cone gauge there are neither ghosts nor self-interaction of massless gluons, and, therefore, the full gluon propagator becomes equal to its free PT counterpart in this model (see Eq. (9.1)), indeed. Thus from the whole of QCD only two sectors survive, namely the quark and BS ones in the ladder approximation to the quark-gluon proper vertex. Let us emphasize, nevertheless, that in this model  $D = D^0$  only to the leading order in the large  $N_c$  limit, and nobody knows to what extent the next-to-leading order corrections may distort the behavior of the gluon propagator.

In order to reproduce the same approximation scheme within our approach, it is necessary to neglect ghosts and the self-interaction of gluon fields "by hand", while the quark loop contribution is automatically suppressed as  $\epsilon$  as  $\epsilon \rightarrow 0^+$  (see Eq. (9.3)). As a result, we are left with only the quark and BS sectors which is absolutely similar to the 't Hooft model (though in the covariant gauge). For simplicity, here we are going to discuss in some details the quark sector only.

It is easy to show that the SD equation for the quark propagator (2.1) in the ladder approximation (the point-like quark-gluon proper vertex) and within our treatment of the free gluon propagator IR severe singularity, becomes

$$S^{-1}(p) = S_0^{-1}(p) + \frac{1}{\epsilon} g^2 N_c \gamma_\mu S(p) \gamma_\mu, \quad \epsilon \rightarrow 0^+, \quad (11.1)$$

where we include all known numerical factors into the coupling constant (having the dimensions of mass) except of  $N_c$ . Let us remind that in the 't Hooft model [1] the IR regularization parameter was denoted as  $\lambda$  and in fact it was introduced by "hand" (though correctly). At the same time, in this model it was assumed implicitly that the fixed combination  $g^2 N_c$  is IR finite from the very beginning (i.e., it does not depend on  $\epsilon$  when it goes to zero) though both parameters  $g^2$  and  $N_c$  (since it is the free one in the large  $N_c$  approach) should, in general, depend on  $\epsilon$  in the presence of such a strong IR singularity in the theory. There is also a possible problem of the commutation of the two different limits: the IR limit,  $\epsilon \rightarrow 0^+$  and the large  $N_c$  limit,  $N_c \rightarrow \infty$ . Anyway, in this model only the quark propagator becomes  $\epsilon$ -dependent, so the corresponding IR convergence condition (2.8) in the quark sector is simply  $Z_2^2(\epsilon) = \epsilon$  with the obvious solution  $\bar{S}(p) = \sqrt{\epsilon} S(p)$ . In this way one obtains for the IR renormalized quark propagator

$$\bar{S}^{-1}(p) = i\bar{m}_0 + g^2 N_c \gamma_\mu \bar{S}(p) \gamma_\mu, \quad (11.2)$$

where  $\bar{m}_0 = \sqrt{\epsilon} m_0(\epsilon)$  exists as  $\epsilon \rightarrow 0^+$ , by definition, i.e., it is the IR renormalized current quark mass. Using further our parametrization of the quark propagator (5.2), (5.3) and doing a rather simple algebra of the  $\gamma$  matrices in 2D Euclidean space, we finally obtain

$$B^{-1} + \bar{m}_0 = 2g^2 N_c B, \quad \bar{A} = A = 0, \quad (11.3)$$

i.e., the quark propagator has no  $\gamma$  matrix structure, similar to the 't Hooft model [1,2]. Moreover, the quark propagator is simply constant in this approximation, namely

$$\bar{S}(p) = iB(p^2) = \frac{i\bar{m}_0}{4g^2N_c} \left[ 1 \pm \sqrt{1 + \frac{8g^2N_c}{\bar{m}_0^2}} \right]. \quad (11.4)$$

This means that in fact the current quark mass is replaced by the "effective mass"  $M$  as follows:

$$\bar{m}_0 \longrightarrow M = \frac{4g^2N_c}{\bar{m}_0 \left[ 1 \pm \sqrt{1 + \frac{8g^2N_c}{\bar{m}_0^2}} \right]}, \quad (11.5)$$

which in the chiral limit  $\bar{m}_0 \rightarrow 0$  becomes

$$M_0^2 = 2g^2N_c. \quad (11.6)$$

Using our formalism for the bound-state problem (subsection C), it is easy to show that the same quark SD equation IR convergence condition  $Z_2^2(\epsilon) = \epsilon$  makes the BS sector IR finite as well, i.e., free from the severe IR divergences. Thus the 't Hooft model in the covariant gauge is almost trivially IR renormalizable (as well as in the initial light-cone gauge). Though the model quark propagator (11.4) is too simple, nevertheless, its BS sector may be rather nontrivial, similar to the BS sector of the initial 't Hooft model [1].

## XII. SUMMARY

### A. Discussion

In summary, the main observation is that 2D QCD is an inevitably IR divergent theory. We have explicitly shown how the NP IRMR program should be done in order to remove all the severe IR singularities from the theory on a general ground and in a self-consistent way. The general system of the IR convergence conditions (8.34), taking into account the fundamental relation (10.2), simply becomes

$$X(\epsilon) = \epsilon, \quad \epsilon \rightarrow 0^+, \quad (12.1)$$

while all other independent quantities (Green's functions) are IR finite from the very beginning, i.e., their IRMR constants are simply unity. Evidently, only the nontrivial IR renormalization of the coupling constant is needed to render the theory IR finite, i.e., to make it free from all the severe IR divergences. Only the condition (12.1) provides the cancellation of all the severe IR singularities in 2D covariant gauge QCD. This completes the proof of the IR renormalizability of 2D QCD within our approach. It is worth emphasizing once more that it makes sense to discuss quark confinement, DBCS, the bound-state problems, the tensor structure of the various SD equations, etc. only after the completion of the NP IRMR program, i.e., within entities having sense as the IR regularization parameter goes finally to zero (but not before).

Our proof implies that quark propagator should be IR finite from the very beginning, i.e.,  $Z_2(\epsilon) = 1$  which means  $S(p) = \bar{S}(p)$ . In the 't Hooft model [1], the quark propagator is IR

vanishing, i.e.,  $Z_2(\epsilon)$  goes to zero as  $\epsilon \rightarrow 0^+$ . However, there is no contradiction with the above-mentioned since in this model neither  $g^2$  nor  $N_c$  depend on  $\epsilon$  (see section XI). From our general solution (8.34) then it follows that  $Z_2(\epsilon) = \sqrt{\epsilon}$ , indeed, since in this case one has to put  $X(\epsilon) = 1$ .

One can conclude that in some sense it is easier to prove the IR renormalizability of 2D QCD than to prove its UV renormalizability. The reason is, of course, that we know the mathematical theory which has to be used - the theory of distributions [9]. This is due to its fundamental result [9,10] which requires that any NP (severe) singularity with respect to momentum in the deep IR domain in terms of  $\epsilon$  should always be  $1/\epsilon$  and this does not depend on how the IR regularization parameter  $\epsilon$  has been introduced in the way compatible with the DT itself. On the other hand, the above-mentioned fundamental result relates the IR regularization to the number of space-time dimensions [9,10,23] (compactification). It is easy to imagine that otherwise none of the IRMR programs would be possible. In other words, the DT provides the basis for the adequate mathematical investigation of a global character of the severe (NP) IR divergences (each skeleton independent loop diagram diverges as  $1/\epsilon$ ), while the UV divergences have a local character, and thus should be investigated term by term in powers of the coupling constant.

In this connection a few remarks are in order. The full dynamical content of 2D (4D) QCD is contained in its system of the SD equations of motion. To solve 2D (4D) QCD means to solve this system and vice versa. In particular, to prove the IR renormalizability of 2D (4D) QCD means to formulate the IRMR program in order to remove all the NP IR singularities from this system on a general ground and in a self-consistent way. As was mentioned above, the fortunate feature which makes this possible is a global character of the IR singularities in 2D QCD. Each skeleton diagram is a sum of infinite series of terms, however, the DT shows how their IR singularities can be summed up. Moreover, it shows how the IR singularities of different scattering kernels (which by themselves are infinite series of the skeleton diagrams) can be summed up as well (see, for example, sections VIII, IX, X).

The next important step is to impose a number of independent conditions in order to cancel all the NP IR singularities which inevitably appear in the theory after the above-mentioned summations have been done with the help of an entire chain of strongly coupled SD equations. They should also be complemented by the corresponding ST identities which are consequences of the exact gauge invariance, and therefore are exact constraints on any solution to QCD [6]. The only problem now is to find a self-consistent solutions to the system of the IR convergence conditions. If such solutions exist, so everything is O.K. If not, the theory is not renormalizable. It is worth reemphasizing that we have found a self-consistent solution to this system (Eq. (12.1)).

Let us make a few remarks concerning the regularization and gauge invariance of our approach. In principle, no regularization scheme (how to introduce the IR regularization parameter in order to parameterize the IR divergences) should be introduced "by hand". First of all it should be well defined. Secondly, it should be compatible with the DT [9]. The DR scheme [11] is precisely well defined and in Ref. [10] we have shown how it should be introduced into the DT (complemented by the number of subtractions, if necessary). The so-called " $\pm i\epsilon$  regularization" is equivalent to the regularization used in our paper (see again Ref. [9]). Other regularizations schemes are also available, for example, such as analytical regularization used in Ref. [14] or the so-called Speer's regularization [37]. However, they

should be compatible with the DT as was emphasized above. Anyway, not the regularization is important but the DT itself.

Whether the theory is IR multiplicative renormalizable or not depends on neither the regularization nor the gauge. Due to the chosen regularization scheme or the gauge only the details of the corresponding IRMR program can be simplified. For example, in the light-cone gauge at any chosen regularization scheme (the 't Hooft model with different prescriptions how to deal with the severe IR singularities [2] (and references therein)) to prove the IR multiplicative renormalizability of 2D QCD is almost trivial. This is mainly due to the fact that in this case only two sectors survive in QCD, namely quark and BS sectors. In other words, if theory is proven to be IR or UV renormalizable in one gauge, it is IR or UV renormalizable in any other gauge. This is true for the regularization schemes as well. As it follows from the present investigation, to prove the IR multiplicative renormalizability of 2D QCD in the covariant gauge was not so simple. However, it was necessary to get firstly the IR finite bound-state problem (which is important for physical applications), and secondly to generalize our approach on 4D QCD which is real theory of strong interactions. 2D QCD in the light-cone gauge is not appropriate theory for this purpose since its confinement mechanism looks more like that of the Schwinger model [1] of 2D QED, than it may happen in real QCD, where we believe it is much more complicated.

The structure of the severe IR singularities in Euclidean space is much simpler than in Minkowski space, where kinematical (unphysical) singularities due to light cone also exist. In this case it is rather difficult to correctly untangle them from the dynamical singularities, only ones which are important for the calculation of any physical observable. Also the consideration is much more complicated in configuration space [4]. That is why we always prefer to work in momentum space (where propagators do not depend explicitly on the number of dimensions) with Euclidean signature. We also prefer to work in the covariant gauges in order to avoid peculiarities of the noncovariant gauges [38], for example how to untangle the gauge pole from the dynamical one. The IR structure of 2D QCD in the light-cone gauge by evaluating different physical quantities has been investigated in more detail in Refs. [2,21,39-41] (and references therein).

Of course, the quark propagator cannot be gauge-invariant because the quark fields are not, by definition. This implicit gauge dependence of the quark propagator (as well as all other Green's functions) always exists and cannot, in principle, be eliminated. This is a general feature of all gauge theories such as QCD and QED. Unfortunately, in gauge theories the main problem is not the above-mentioned unavoidable implicit gauge dependence, but the explicit dependence of the Green's functions on the gauge fixing parameter  $\xi$  (on its numerical value). In the quark SD equation it comes from the full gluon propagator and the corresponding quark-gluon proper vertex. In both cases we have shown that after the completion of our IRMR program (by correctly using the DT) to remove all the NP IR divergences in a general way, the explicit gauge dependence disappeared from the obtained system of equations (5.1). This means that analytical properties of the solutions to this system (the absence of the pole-type singularities and the presence of the branch-points only) do not depend *explicitly* on the gauge fixing parameter, indeed. Just in this sense the first necessary condition of the quark confinement criterion discussed above is gauge-invariant. Evidently, the second sufficient condition of quark confinement formulated as the existence of a discrete spectrum (no continuum in the spectrum) in the hadron spectroscopy

is, by definition, gauge-invariant.

Also, it makes sense to bring the reader's attention to the following point. The simplest approximation to the quark-gluon vertex (compatible with the correct treatment of the IR singularities by the DT in 2D QCD) is the vertex at zero momentum transfer (see Eqs. (5.1)) and not its point-like counterpart. This means that even in 2D QCD it is better to analyse confinement at the fundamental quark level in terms of the analytical properties of the quark propagator which reflect the IR structure of the 2D QCD true ground state. At the macroscopic, hadronic level the linear rising potential interpretation of confinement becomes relevant for bound states between heavy quarks only. In this case, apparently, the full vertex can be approximated by its point-like counterpart, so the analysis in terms of the potential becomes relevant. As was mentioned above, that is why in the 't Hooft model [1] (where the vertex is the point-like from the very beginning, see section XI) confinement looks more like that of the Schwinger model [6] of 2D QED. In real QCD it is believed to be much more complicated. This complication is also due to nonabelian degrees of freedom, while in the 't Hooft model they are eliminated by the choice of the gauge.

## B. Conclusions

We have shown that 2D covariant gauge QCD reveals several desirable and promising features, so our main conclusions are:

- 1). We have proven the IR multiplicative renormalizability of 2D QCD in the covariant gauge. It is based on the compelling mathematical ground provided by the DT itself.
- 2). The nontrivial renormalization of the coupling constant only makes theory free from all the severe IR singularities which inevitably appear in 2D QCD.
- 3). The quark propagator has no poles, indeed (quark confinement).
- 4). It also implies DCSB, i.e., the chiral symmetry is certainly dynamically (spontaneously) broken in 2D QCD.
- 5). We fixed finally the type of the quark propagator. The NP IRMR program implies it to be IR finite from the very beginning as well as all other Green's functions.
- 6). The bound-state problem becomes tractable within our approach. To any order in the skeleton expansion of the BS scattering amplitude shown in Fig. 7, the corresponding BS equation (8.26) can be reduced finally to an algebraic problem (Appendix B).
- 7). The chiral limit physics (i.e., the Goldstone sector) can be exactly evaluated since we have found exact solution for the quark propagator in this case.
- 8). The nonzero quark masses can also easily be included in our scheme. We develop an analytical formalism which allows one to find solution for the quark propagator in powers of the light quark masses as well as in the inverse powers of the heavy quark masses. We have theoretically justified the use of the free quark propagator for heavy quarks. So our solution in this case automatically possesses the heavy quark flavor symmetry (Appendix A).
- 9). It was widely believed that the severe IR singularities could not be put under control. However, we show explicitly that the above-mentioned common belief is not justified. They are controlled in all sectors of QCD of any dimensions by using correctly the DT [9,10]. This can be considered also as one of our main results from a mathematical point of view.
- 10). We have proven that in order to accumulate the severe IR singularities in 2D QCD, the YM SD equation for the gluon propagator (9.4) is completely sufficient for this purpose.

The only dynamical mechanism responsible for quark confinement, DBCS, the bound-states, etc. which can be thought of in 2D QCD is the direct interaction of massless gluons. It becomes strongly dominant and can be effectively correctly absorbed into the gluon propagator. It is well known that it is this interaction which brings to birth asymptotic freedom (AF) [6] in QCD in the deep UV limit. Thus the free gluon propagator due to its severe IR structure is justified to use in order to explain all the above-mentioned NP phenomena within our approach without explicitly involving some extra degrees of freedom.

A few points are worth reemphasizing as well.

The first important point is that the IR singularity of the free gluon propagator, being strong at the same time, should be correctly treated by the DT, complemented by the DR method. It enables us to extract the required class of test functions in the IR renormalized quark SD equation. The test functions do consist of the quark propagator and the corresponding quark-gluon vertex function. By performing the IRMR program, we have found the regular solutions for the quark propagator. For that very reason the relation (2.4) is justified since it is multiplied by the appropriate smooth test functions [9]. Moreover, we establish the space in which our generalized functions are continuous linear functionals. It is a linear topological space denoted as  $K(c)$  (for the solutions in the chiral limit denoted as  $K(c_0)$ ), consisting of infinitely differentiable functions having compact support in  $x \leq c$  ( $x \leq c_0$ ), i.e., such functions which vanish outside the interval  $x \leq c$  ( $x \leq c_0$ ) [9]. Thus the above-mentioned subtraction of all kinds of the PT contributions become not only physically well justified but well confirmed by the DT (i.e., mathematically) as well.

The second point is that our theory (as mentioned above) is defined by subtraction of all kinds of the PT contributions at the fundamental quark level and at the hadronic level as well. The only point of subtractions is the branch point. Thus we have exact criterion how to separate the NP region (soft momenta) from the PT region (hard momenta).

The third point is that the system of SD equations for the IR finite quantities (5.1) becomes automatically free of the UV divergences though it is valid in the whole momentum range  $[0, \infty)$ . At the same time, its solutions, in general, and in the chiral limit, in particular, preserve AF up to renormgroup log improvements, of course.

The fourth point is that the system of equations (5.1) for the IR renormalized quark propagator is exact. Moreover, it does not *explicitly* depend on the gauge fixing parameter. It was obtained in accordance with the rigorous rules of the DT, so there is no place for theoretical uncertainties.

The fifth point is that the DT with its requirements to the corresponding properties of the test functions removes all the ambiguities from the theory. Because of this, all types of the singular solutions should be excluded from the consideration, at least in the standard DT sense.

### C. Some perspectives for 4D QCD

We are not going here to evaluate the hadronic spectrum within our approach. Anyway, it requires a separate treatment since, unlike the 't Hooft model [1], our model is not simple (it cannot be reduced to the ladder approximation in the BS sector). At the same time, the bound-state problem becomes tractable within our approach (see Appendix B).

Our main concern is how to generalize this approach on 4D QCD which is a realistic theory of strong interactions not only at the fundamental quark-gluon level but at the hadronic level as well. 2D covariant gauge QCD is a much more appropriate theory to be generalized on 4D QCD than its 't Hooft counterpart. Firstly, it maintains the direct interaction of massless gluons (nonabelian degrees of freedom). Secondly, its dynamical structure is much richer (full vertices, etc.). It is not accidental that 2D light-cone gauge confinement mechanism at the fundamental quark-gluon level turned out to be almost useless to understand confinement mechanism in 4D QCD.

However, there are some principal distinctions between 2D and 4D QCD. The most important one is that the former has initially the JW mass gap which is the coupling constant itself. In the latter case the coupling is dimensionless, so it is necessary to introduce the JW mass gap from the very beginning into the quantum 4D YM theory. In close connection with this problem is the clear understanding that the free gluon propagator is a bad approximation to the full gluon propagator in the IR domain. Its IR singularity is the PT one (i.e., not severe) in 4D QCD. So necessarily the IR singularities of the full gluon propagator in 4D QCD should be stronger than  $1/q^2$  as  $q^2$  goes to zero. We have already attempted to discuss both problems in more detail in Ref. [24].

There still remains to resolve a set of some important problems. Firstly, how to obtain the system of equations of motion in 4D QCD free from possible strong IR singularities. We think that in this case the general IRMR program should not be drastically different from that of 2D QCD formulated in this work. Secondly, how to formulate the above-mentioned system of equations of motion free from the explicit ghost degrees dependence and in a manifestly gauge invariant way, at least in the deep IR domain since there is no hope for an exact solution(s). This is important for 4D QCD. Also there should exist nontrivial PT dynamics in 4D QCD, while in 2D QCD it is simple (we approximate the full gluon propagator by its free PT counterpart in the whole momentum range). In this approximation the 2D YM vacuum is also trivial (to all orders of the vacuum-loops expansion [42]), while in 4D YM theory it can by no means be trivial to any order. Anyway, the NP vacuum of 4D QCD is expecting to be much more complicated. A generalization of our approach to 2D and 4D QCD on nonzero temperature would be also interesting.

### XIII. ACKNOWLEDGEMENTS

The authors would like to thank L.P. Csernai and BPCL for their kind support enabling us to carry out the substantial part of this work at the Bergen University in the framework of the BPCL-17 Contract. It is pleasure also to thank J. Revai and J. Nyiri for help. One of the authors (V.G.) is grateful to A.V. Kouziouchine for help and support.

### APPENDIX A: NONZERO QUARK MASSES

To investigate solutions for the IR finite from the very beginning quark propagator in the general (nonchiral case) it is much more convenient to start from the ground system itself, Eqs. (5.9), rather than to investigate the general solutions (5.10)-(5.13). The ground system is

$$\begin{aligned}
xA' + (1+x)A + 1 &= -m_0B, \\
2BB' + A^2 + 2B^2 &= 2m_0AB,
\end{aligned}
\tag{A1}$$

where, let us remind,  $A \equiv A(x)$ ,  $B \equiv B(x)$ , and here the prime denotes the derivative with respect to the Euclidean dimensionless momentum variable  $x$  and the same notation for the dimensionless current quark mass is retained (i.e.,  $m_0/\bar{g} \rightarrow m_0$ ). As was mentioned above, we are interested in the solutions which are regular at zero and asymptotically approach free quark case. Because of our parametrization of the quark propagator (5.2) its asymptotic behavior has to be determined as follows (Euclidean metrics):

$$\begin{aligned}
A(x) &\sim_{x \rightarrow \infty} -\frac{1}{x + m_0^2}, \\
B(x) &\sim_{x \rightarrow \infty} -\frac{m_0}{x + m_0^2},
\end{aligned}
\tag{A2}$$

up to renormgroup improvements by perturbative logarithms. The ground system (A1) is very suitable for numerical calculations.

### 1. Light quarks

Let us now develop an analytical formalism which makes it possible to find solution of the ground system step by step in powers of the light current quark masses, the so-called chiral perturbation theory at the fundamental quark level. For this purpose let us present the quark propagator form factors  $A$  and  $B$  as follows:

$$\begin{aligned}
A(x) &= \sum_{n=0}^{\infty} m_0^n A_n(x), \\
B(x) &= \sum_{n=0}^{\infty} m_0^n B_n(x),
\end{aligned}
\tag{A3}$$

where

$$m_0^{(u,d,s)} \ll 1. \tag{A4}$$

Substituting these expansions into the ground system (A1) and omitting some tedious algebra, one finally obtains

$$\begin{aligned}
xA'_0(x) + (1+x)A_0(x) + 1 &= 0, \\
2B_0(x)B'_0(x) + A_0^2(x) + 2B_0^2(x) &= 0,
\end{aligned}
\tag{A5}$$

and for  $n = 1, 2, 3, \dots$ , one has

$$\begin{aligned}
xA'_n(x) + (1+x)A_n(x) &= -B_{n-1}(x), \\
2P_n(x) + M_n(x) + 2Q_n(x) &= 2N_{n-1}(x),
\end{aligned}
\tag{A6}$$

where



$$\begin{aligned}
P_n(x) &= \sum_{m=0}^n B_{n-m}(x)B'_m(x), \\
M_n(x) &= \sum_{m=0}^n A_{n-m}(x)A_m(x), \\
Q_n(x) &= \sum_{m=0}^n B_{n-m}(x)B_m(x), \\
N_n(x) &= \sum_{m=0}^n A_{n-m}(x)B_m(x).
\end{aligned} \tag{A7}$$

Is is obvious that the system (A5) describes the ground system (A1) in the chiral limit ( $m_0 = 0$ ). As we already know it can be solved exactly (see below as well). The first nontrivial correction in powers of a small  $m_0$  is determined by the following system which follows from Eqs. (A6) and it is

$$\begin{aligned}
xA'_1 + (1+x)A_1 &= -B_0, \\
(B_1B'_0 + B_0B'_1) + A_0A_1 + 2B_0B_1 &= A_0B_0,
\end{aligned} \tag{A8}$$

where we omit the dependence on the argument  $x$  for simplicity. In the similar way can be found the system of equations to determine terms of order  $m_0^2$  in the solution for the quark propagator and so on.

Let us present a general solution to the first of Eqs. (A6) which is

$$A_n(x) = -x^{-1}e^{-x} \int_0^x dx' e^{x'} B_{n-1}(x'). \tag{A9}$$

It is always regular at zero since all  $B_n(x)$  are regular as well. The advantage of the developed chiral perturbation theory at the fundamental quark level is that each correction in the powers of small current quark masses is determined by the corresponding system of equations which can be formally solved exactly.

The differential equation (A8) which determines first correction for the dynamically generated quark mass function is

$$B'_1 + [1 - \frac{1}{2}A_0^2B_0^{-2}]B_1 = A_0 - A_0A_1B_0^{-1}, \tag{A10}$$

where we used the second of Eqs. (A5). It is easy to check that its solution which is regular at zero is

$$B_1(x) = \mu^{-1}(x) \int_{c_1}^x dz A_0(z)[1 - A_1(z)B_0^{-1}(z)]\mu(z), \tag{A11}$$

where

$$\mu(x) = \exp[x - \frac{1}{2}a(x)], \tag{A12}$$

and

$$a(x) = \int_0^x dx' A_0^2(x')B_0^{-2}(x'). \tag{A13}$$

Let us write down the system of solutions approximating the light quark propagator up to first corrections, i.e.,

$$\begin{aligned} A(x) &= A_0(x) + m_0 A_1(x) + \dots, \\ B(x) &= B_0(x) + m_0 B_1(x) + \dots \end{aligned} \quad (\text{A14})$$

This system is

$$A_0(x) = -x^{-1}(1 - e^{-x}), \quad A_0(0) = -1, \quad (\text{A15})$$

$$B_0^2(x) = e^{-2x} \int_x^{c_0} dx' e^{2x'} A_0^2(x'). \quad (\text{A16})$$

And

$$A_1(x) = -x^{-1} e^{-x} \int_0^x dx' e^{x'} B_0(x'), \quad (\text{A17})$$

$$B_1(x) = e^{-2x} B_0^{-1}(x) \int_{c_1}^x dz e^{2z} A_0(z) [B_0(z) - A_1(z)], \quad (\text{A18})$$

where again we use second of Eq. (A5) in order to integrated out the  $\mu(x)$  function. In physical applications we also need  $B^2(x)$ , so we have

$$\begin{aligned} B^2(x) &= B_0^2(x) + 2m_0 B_0(x) B_1(x) + \dots \\ &= B_0^2(x) + 2m_0 e^{-2x} \int_{c_1}^x dz e^{2z} A_0(z) [B_0(z) - A_1(z)] + \dots, \end{aligned} \quad (\text{A19})$$

and the relation between constants of integration  $c_0$  and  $c_1$  remains, in general, arbitrary. However, there exists a general restriction, namely  $B^2(x) \geq 0$  and it should be real which may lead to some bounds for the constants of integration, while  $x \leq c_0$  always remains.

## 2. Heavy quarks

For heavy quarks it makes sense to replace  $m_0 \rightarrow m_Q$ . In this case it is convenient to find solution for heavy quark form factors  $A$  and  $B$  as follows:

$$\begin{aligned} m_Q^2 A(x) &= \sum_{n=0}^{\infty} m_Q^{-n} A_n(x), \\ m_Q B(x) &= \sum_{n=0}^{\infty} m_Q^{-n} B_n(x), \end{aligned} \quad (\text{A20})$$

and for heavy quark masses we have

$$m_Q^{(c,b,t)} \gg 1, \quad (\text{A21})$$

i.e., the inverse powers are small. Substituting these expansions into the first equation of the ground system (A1) and omitting some tedious algebra, one finally obtains

$$\begin{aligned}
B_0(x) &= -1, \\
B_1(x) &= 0,
\end{aligned}
\tag{A22}$$

and

$$xA'_n(x) + (1+x)A_n(x) = -B_{n+2}(x), \quad n = 0, 1, 2, 3, \dots \tag{A23}$$

In the same way, by equating terms at equal powers in the inverse of heavy quark masses, from second of the equations of the ground system, one finally obtains

$$\begin{aligned}
P_0(x) + Q_0(x) - N_0(x) &= 0, \\
P_1(x) + Q_1(x) - N_1(x) &= 0.
\end{aligned}
\tag{A24}$$

and

$$P_{n+2}(x) + Q_{n+2}(x) - N_{n+2}(x) = -\frac{1}{2}M_n(x), \quad n = 0, 1, 2, 3, \dots, \tag{A25}$$

where  $P_n(z)$ ,  $M_n(z)$ ,  $Q_n(z)$ ,  $N_n(z)$  are again given by Eqs. (A7). Solving these equations, one obtains

$$\begin{aligned}
A_0(x) = B_0(x) &= -1, \\
A_1(x) = B_1(x) &= 0,
\end{aligned}
\tag{A26}$$

and

$$\begin{aligned}
xA'_n(x) + (1+x)A_n(x) &= -B_{n+2}(x), \\
P_{n+2}(x) + Q_{n+2}(x) - N_{n+2}(x) &= -\frac{1}{2}M_n(x), \quad n = 0, 1, 2, 3, \dots
\end{aligned}
\tag{A27}$$

It is possible to show that all odd terms are simply zero, i.e.,

$$A_{2n+1}(x) = B_{2n+1}(x) = 0, \quad n = 0, 1, 2, 3, \dots \tag{A28}$$

The explicit solutions for a few first nonzero terms are

$$A_0(x) = B_0(x) = -1. \tag{A29}$$

$$\begin{aligned}
A_2(x) &= x + \frac{3}{2}, \\
B_2(x) &= x + 1.
\end{aligned}
\tag{A30}$$

$$\begin{aligned}
A_4(x) &= -x^2 - \frac{3}{2}x - \frac{15}{2}, \\
B_4(x) &= -x^2 - \frac{7}{2}x - \frac{3}{2}.
\end{aligned}
\tag{A31}$$

Thus our solutions for the heavy quark form factors look like

$$\begin{aligned}
A(x) &= \frac{1}{m_Q^2} \sum_{n=0}^{\infty} m_Q^{-n} A_n(x) \\
&= -\frac{1}{m_Q^2} + \frac{x}{m_Q^4} - \frac{x^2}{m_Q^6} + \dots + D_A(x),
\end{aligned} \tag{A32}$$

where

$$D_A(x) = \frac{3}{2m_Q^4} - \frac{3x+15}{2m_Q^6} + \dots \tag{A33}$$

And

$$\begin{aligned}
B(x) &= \frac{1}{m_Q} \sum_{n=0}^{\infty} m_Q^{-n} B_n(x) \\
&= -\frac{1}{m_Q} + \frac{x}{m_Q^3} - \frac{x^2}{m_Q^5} + \dots + D_B(x),
\end{aligned} \tag{A34}$$

where

$$D_B(x) = \frac{1}{m_Q^3} - \frac{7x+3}{2m_Q^5} + \dots \tag{A35}$$

Summing up, one obtains

$$\begin{aligned}
A(x) &= -\frac{1}{x+m_Q^2} + D_A(x), \\
B(x) &= -\frac{m_Q}{x+m_Q^2} + D_B(x).
\end{aligned} \tag{A36}$$

In terms of the Euclidean dimensionless variables (5.7), the heavy quark propagator (5.2) is

$$iS(x) = \hat{x}A(x) - B(x). \tag{A37}$$

Using our solutions, obtained above, it can be written down as follows:

$$iS(x) = \hat{x} \left( -\frac{1}{x+m_Q^2} + D_A(x) \right) + \frac{m_Q}{x+m_Q^2} - D_B(x). \tag{A38}$$

In other words, it becomes

$$iS(x) = iS_0(x) + \hat{x}D_A(x) - D_B(x), \tag{A39}$$

where  $iS_0(x)$  is nothing else but the free quark propagator with the substitution  $m_0 \rightarrow m_Q$ , i.e.,

$$iS_0(x) = -\frac{\hat{x} - m_Q}{x+m_Q^2}. \tag{A40}$$

Since  $\hat{x}D_A(x)$  and  $D_B(x)$  both are of the same order in the inverse powers of  $m_Q$ , namely they are of order  $m_Q^{-3}$ , then Eq. (A39), becomes

$$iS(x) = iS_0(x) + 0(m_Q^{-3}). \tag{A41}$$

This means that our solution for the heavy quark propagator is reduced to the free quark propagator up to terms of order  $1/m_Q^3$ .

### 3. Heavy quarks flavor symmetry

Let us explicitly show here that our solutions (A36) possess the heavy quark flavor symmetry [43]. We will show that the quark propagator to leading order in the inverse powers of the heavy quark mass will not depend on it, i.e., it is manifestly flavor independent to the leading order of this expansion. For this purpose, we must take into account that argument  $x$  which is the dimensionless momentum of the heavy quark contains itself the heavy quark mass  $m_Q$ . In other words, a standard heavy quark momentum decomposition should be used, namely

$$p_\mu = m_Q v_\mu + k_\mu, \quad (\text{A42})$$

as well as

$$\hat{x} = \gamma_\mu x_\mu = \gamma_\mu (m_Q v_\mu + y_\mu), \quad (\text{A43})$$

where  $v$  is the four-velocity with  $v^2 = -1$  (Euclidean signature). It should be identified with the four-velocity of the hadron. The "residual" momentum  $k$  is of dynamical origin. In these terms the Euclidean dimensionless dynamical momentum variable  $x = p^2/\bar{g}^2$  then becomes

$$x = -m_Q^2 - 2m_Q t - z, \quad (\text{A44})$$

where we denote  $t = (v \cdot y)$  with  $y_\mu = k_\mu/\bar{g}$  and  $z = k^2/\bar{g}^2$ .

Substituting expressions (A43) and (A44) and taking into account only leading order terms in the inverse powers of  $m_Q$ , one finally obtains

$$iS_h(v, y) = iS_0(v, y) + O\left(\frac{1}{m_Q}\right), \quad (\text{A45})$$

where

$$iS_0(v, y) = \frac{1}{v \cdot y} \frac{\hat{v} - 1}{2}, \quad (\text{A46})$$

which is exactly the heavy quark propagator [43]. Thus our propagator does not depend on  $m_Q$  to leading order in the heavy quark mass limit,  $m_Q \rightarrow \infty$ , i.e., in this limit it possesses the heavy quark flavor symmetry, indeed.

Concluding, let us note that the general system (A1) does not demonstrate the principal difference in the analytical structure of its solutions for light and heavy quarks. Also at the fundamental quark level the heavy quark mass limit is not Lorentz covariant. That is why in the case of heavy quarks we will use rather Eq. (A39) than Eq. (A45).

## APPENDIX B: BOUND-STATE PROBLEM

Here let us only schematically show that the BS equation within our approach can be reduced to an algebraic problem, indeed. The BS equation (8.25) for the bound-state meson amplitude  $B(p, p')$  to leading order (first skeleton diagram in Fig. 7) in the skeleton

expansion of the 2PI BS scattering kernel can be written analytically as follows (Euclidean signature):

$$S_q^{-1}(p)B(p, p')S_{\bar{q}}^{-1}(p') = -ig^2 \int d^2l \Gamma_\mu(p', l)B(p, p'; l)\Gamma_\nu(p, l)D_{\mu\nu}^0(l), \quad (\text{B1})$$

(for simplicity all numerical factors are suppressed), where as usual  $S_q^{-1}(p)$  and  $S_{\bar{q}}^{-1}(p')$  are inverse quark and antiquark propagators, respectively. Proceeding absolutely in the same way as in section II, on account of the Laurent expansion (2.4), one finally gets

$$S_q^{-1}(p)B(p, p')S_{\bar{q}}^{-1}(p') = \frac{1}{\epsilon}g^2\Gamma_\mu(p', 0)B(p, p')\Gamma_\mu(p, 0), \quad (\text{B2})$$

where all numerical factors again were included into the coupling constant. It is already known that the renormalization of the coupling constant only is needed to get theory IR finite, i.e.,  $g^2 = X(\epsilon)\bar{g}^2$ . Taking now into account the relation (12.1), the IR renormalized bound-state problem becomes

$$S_q^{-1}(p)B(p, p')S_{\bar{q}}^{-1}(p') = \bar{g}^2\Gamma_\mu(p', 0)B(p, p')\Gamma_\mu(p, 0). \quad (\text{B3})$$

Thus we came to an algebraic problem to solve, indeed. It is necessary to remind that the explicit solution for the quark-gluon vertex at zero momentum transfer is given in Eqs. (5.5) and (5.6). The bound-state amplitude  $B(p, p')$ , for example, for the pseudoscalar meson-quark-antiquark vertex function is

$$G_5^i(p' + q, p') = \left(\frac{\lambda^i}{2}\right)\gamma_5[G_1 + \hat{q}G_2 + \hat{p}'G_3 + \hat{p}'\hat{q}G_4], \quad (\text{B4})$$

where right hand side is nothing else but the decomposition of the pseudoscalar bound-state amplitude into the independent matrix structures.  $G_j = G_j(p^2, p'^2, q^2)$  with  $j = 1, 2, 3, 4$  and  $i$  is the flavor index. Absolutely in the same way can be evaluated the BS equation on account of the second skeleton diagram in Fig. 7 and so on. The actual evaluation of the BS equation for the pion bound-state amplitude deserves a separate investigation as well as the investigation of the Goldstone sector in QCD.

## REFERENCES

- [1] G. 't Hooft, Nucl. Phys. **B75**, 461 (1974).
- [2] E. Abdalla, M. C. B. Abdalla, Phys. Rep. **265**, 253 (1996).
- [3] A. Armoni, Y. Frishman, J. Sonnenschein, Nucl. Phys. **B596**, 459 (2001).
- [4] U. Trittman, Nucl. Phys. **B587**, 311 (2000).
- [5] K. Aoki, K. Ito, Phys. Rev. D **60**, 096004 (1999).
- [6] W. Marciano, H. Pagels, Phys. Rep. C **36**, 137 (1978).
- [7] V. Gogohia, Phys. Lett. B **531**, 321 (2002).
- [8] G. 't Hooft, Nucl. Phys. **B72**, 461 (1974).
- [9] I. M. Gel'fand, G. E. Shilov, Generalized Functions, Vol. 1, (Academic Press, New York, 1968).
- [10] V. Gogohia, hep-ph/0102261.
- [11] G. 't Hooft, M. Veltman, Nucl. Phys. **B44**, 189 (1972).
- [12] J. C. Taylor, Nucl. Phys. **B33**, 436 (1971).
- [13] A. A. Slavnov, Sov. Jour. Theor. Math. Phys. **10**, 153 (1972).
- [14] H. Pagels, Phys. Rev. D **15**, 2991 (1977).
- [15] J. S. Ball, T.- W. Chiu, Phys. Rev. D **22**, 2542 (1980).
- [16] S. D. Joglekar, B. W. Lee, Ann. Phys. (N.Y.) **97**, 160 (1976).
- [17] E. G. Eichten, F. L. Feinberg, Phys. Rev. D **10**, 3254 (1974).
- [18] V.Sh. Gogokhia, Phys. Rev. D **40**, 4157 (1989).  
V.Sh. Gogohia, Inter. Jour. Mod. Phys. A **9**, 759 (1994).
- [19] G. Preparata, Phys. Rev. D **7**, 2973 (1973).
- [20] N.N. Bogolyubov, D.V. Shirkov, Introduction into the Theory of Quantized Fields, (Nauka, Moscow, 1976).
- [21] M.B. Einhorn, Phys. Rev. D **14**, 3451 (1976).
- [22] Proc. of QM'2001, Nucl.Phys. **A698**, 3c-674c (2002).  
E.V. Shuryak, Phys. Rep. **61**, 71 (1980).  
J. Cleymans, R.V. Gavai, and E. Suhonen, Phys. Rep. **130**, 217 (1986).
- [23] A. Jaffe, E. Witten, Quantum YM Theory,  
<http://www.claymath.org/prizeproblems/yang-mills.pdf>
- [24] V. Gogohia, hep-ph/0109196, to appear in Proceedings of the Sixth Inter. Conf. On Non-Perturbative QCD, 5-9 June, 2001, Paris, France.
- [25] E. Witten, Nucl. Phys. **B156**, 269 (1979).  
G. Veneziano, Nucl. Phys. **B159**, 213 (1979).
- [26] M.A. Shifman, A.I. Vainshtein, V.I. Zakharov, Nucl. Phys. **B147**, 385 (1979).  
I. Halperin, A. Zhitnitsky, Nucl. Phys. **B539**, 166 (1999).
- [27] M. Baker, Ch. Lee, Phys. Rev. D **15**, 2201 (1977).
- [28] S.K. Kim, M. Baker, Nucl. Phys. **B164**, 152 (1980).
- [29] U. Bar-Gadda, Nucl. Phys. **B163**, 312 (1980).
- [30] B.W. Lee, Phys. Rev. D **9**, 933 (1974).
- [31] S.-H.H. Tye, E. Tomboulis, E.C. Poggio, Phys. Rev. D **11**, 2839 (1975).
- [32] Behavior of the Solutions to the Bethe-Salpeter Equation (Ed. N. Nakanishi), Prog. Theor. Phys. Suppl. **95**, 1 (1988).
- [33] K. Ladanyi, Ann. Phys. (N.Y.) **130**, 427 (1980).
- [34] N. Brown, M.R. Pennington, Phys. Rev. D **39**, 2723 (1989).

- [35] C.D. Roberts, S.M. Schmidt, Prog. Part. Nucl. Phys. **45**, 2nd issue (2000).  
L.v. Smekal, A. Hauck, R. Alcofer, Ann. Phys. (N.Y.) **267**, 1 (1998).
- [36] E. Witten, Nucl. Phys. **B160**, 57 (1979);  
S. Coleman, in: Proc. Inter. School of Subnuclear Physics, ed. A. Zichichi (Plenum Press, New York and London, 1979).
- [37] E.R. Speer, Jour. Math. Phys. **15**, 1 (1974).
- [38] A. Bassetto, G. Nardeli and R. Soldati, Yang-Mills Theories in Algebraic Non Covariant Gauges (WS, Singapore, 1991);  
G. Leibbrandt, Noncovariant Gauges (WS, Singapore, 1994).
- [39] A. Bassetto, R. Begliuomini, G. Nardeli, Phys. Rev. D **59**, 125005 (1999);  
M. Staudacher, W. Krauth, Phys. Rev. D **57**, 2456 (1998).
- [40] C.G. Callan, Jr., N. Coote, D.J. Gross, Phys. Rev. D **13**, 1649 (1976).
- [41] T.T. Wu, Phys. Lett. B **71**, 142 (1977);  
K.G. Klimenko, G.L. Rcheulishvili, Theor. Math. Phys. **62**, 247 (1985).
- [42] J.M. Cornwall, R. Jakiw, E. Tomboulis, Phys. Rev. D **10**, 2428 (1974).
- [43] M. Neubert, Phys. Rep. D **245**, 260 (1994).