

Radiative Corrections to Chargino Production in Electron-Positron Collisions

T. Blank¹, W. Hollik²

*Institut für Theoretische Physik, Universität Karlsruhe,
D-76128 Karlsruhe, Germany*

Abstract

The results of a complete one-loop calculation for the production of chargino pairs in electron-positron collisions, including the option of polarized beams, are presented. The calculation has been performed in the on-shell renormalization scheme. Applications to the integrated cross section, to the forward-backward asymmetry for unpolarized beams, and to the left-right asymmetry show that the higher-order effects have a sizeable influence on the theoretical predictions and therefore should be properly taken into account for detailed studies in the MSSM.

¹E-mail: Torsten.Blank@physik.uni-karlsruhe.de

²E-mail: Wolfgang.Hollik@physik.uni-karlsruhe.de

1 Introduction

In the MSSM, charginos are the fermionic superpartners of the W^\pm bosons and the charged-Higgs bosons, in specific superpositions forming the mass eigenstates. High-energy electron-positron colliders are the best environment to make a precise determination of their properties. In e^+e^- annihilation, charginos are produced in pairs, in lowest order described by γ, Z s -channel exchange and $\tilde{\nu}_e$ t -channel exchange. In that approximation, the cross section is determined by the gauge couplings and by the masses of the charginos and of the e -sneutrino. From precise measurements of the masses, production cross sections and asymmetries, the fundamental parameters of the model can be reconstructed [1]. In view of these prospects it is necessary to include the radiative corrections in order to get theoretical predictions matching the experimental accuracy.

It has been shown in previous studies that the lowest-order predictions can significantly be influenced by higher-order contributions. These studies concentrate on the one-loop diagrams with virtual fermions and sfermions [2], which can involve large Yukawa couplings. In this note we present the result of a complete one-loop calculation, where all MSSM particles with electroweak couplings are included in the virtual states. As a calculational frame, the on-shell renormalization scheme has been applied where all particle masses are physical on-shell quantities. Cross sections and asymmetries are thus directly related to the physical masses of the charginos and of the other particles entering the loops. We briefly outline the theoretical basis of the calculation and discuss the numerical size of the loop effects in the integrated cross sections (for unpolarized beams) and for the angular distributions in terms of the forward-backward asymmetry, as well as for the left-right asymmetry in case of longitudinal beam polarization.

2 Amplitudes and cross sections

The differential cross section for $e^+e^- \rightarrow \tilde{\chi}_j^+ \tilde{\chi}_i^-$ ($i, j = 1$ or 2) with given e^\pm helicities η_\pm can be written in terms of the helicity amplitudes \mathcal{M} as follows,

$$\frac{d\sigma}{d\Omega}(\eta_+, \eta_-) = \frac{\lambda(s, m_i^2, m_j^2)}{64\pi^2 s^2} \sum_{s_+, s_-} |\mathcal{M}(\eta_+, \eta_-, s_+, s_-)|^2, \quad (1)$$

with $\lambda(s, m_i^2, m_j^2) = (s^2 + m_i^4 + m_j^4 - 2sm_i^2 - 2sm_j^2 - 4m_i^2 m_j^2)^{1/2}$. The sum extends over the final-state helicities s_\pm . Unpolarized e^\pm in the initial state require a further summation over η_\pm , together with an additional factor $1/4$. Of specific interest are the integrated cross section

$$\sigma = \int d\Omega \frac{d\sigma}{d\Omega}, \quad (2)$$

the forward-backward asymmetry

$$A_{\text{FB}} = \frac{\sigma_{\text{F}} - \sigma_{\text{B}}}{\sigma_{\text{F}} + \sigma_{\text{B}}}, \quad (3)$$

with the cross sections $\sigma_{\text{F(B)}}$ integrated over the forward (F) and backward (B) hemispheres in the center-of-mass system, and the left-right asymmetry

$$A_{\text{LR}} = \frac{\sigma_{\text{L}} - \sigma_{\text{R}}}{\sigma_{\text{L}} + \sigma_{\text{R}}}, \quad (4)$$

with the integrated cross sections $\sigma_{\text{L(R)}}$ for left- and right-handed electrons.

At lowest order, the amplitude for chargino-pair production can be described by s -channel photon and Z -boson exchange and by t -channel exchange of a scalar neutrino ($\tilde{\nu}_e$), as displayed in the following Feynman diagrams:

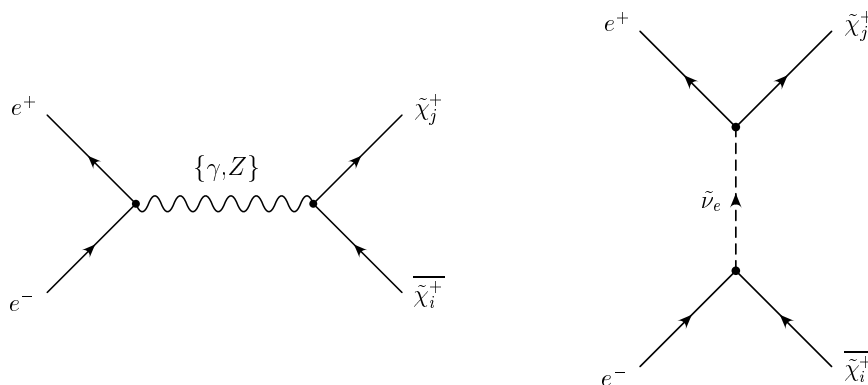

For a heavy $\tilde{\nu}_e$, the t -channel-exchange contribution decouples.

At the one-loop level, the full particle spectrum of the MSSM enters into the amplitudes, and the process becomes dependent on all the parameters of the model. Schematically, the loop contributions are depicted below, grouped into three classes.

- Self-energy contributions:

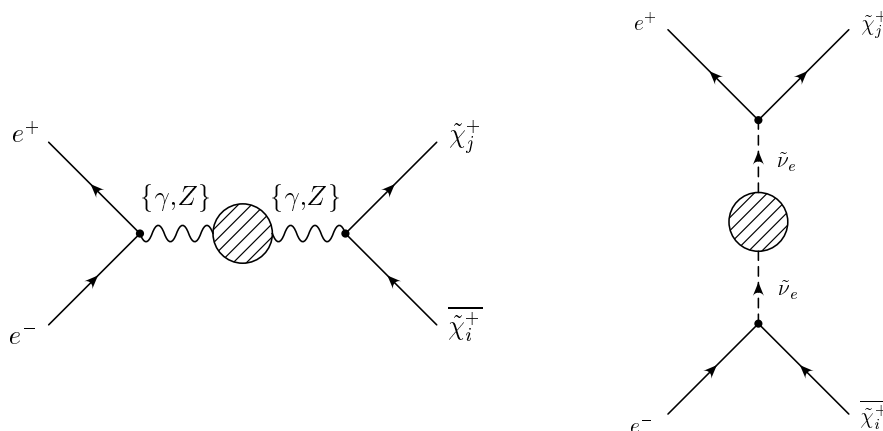

- Vertex corrections:

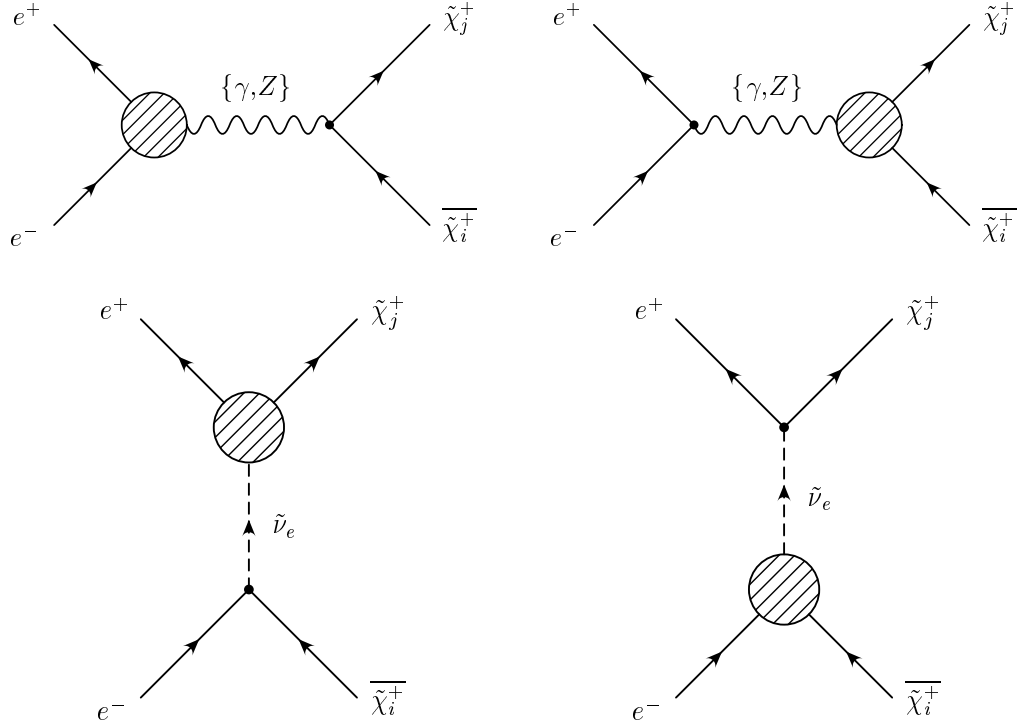

The bubbles summarize the one-particle irreducible 3-point functions including their counterterms, together with the wave-function renormalization of the external lines and chargino mixing.

- Box-diagram contributions:

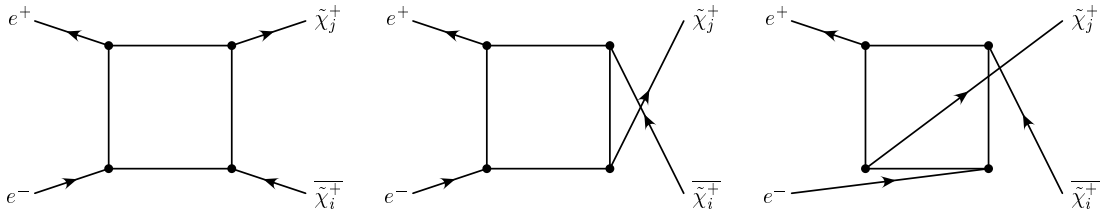

For illustration, the particle insertions for the first box topology are depicted (with gauge bosons V , Higgs bosons H , charginos/neutralinos χ , leptons l , and sleptons \tilde{l}):

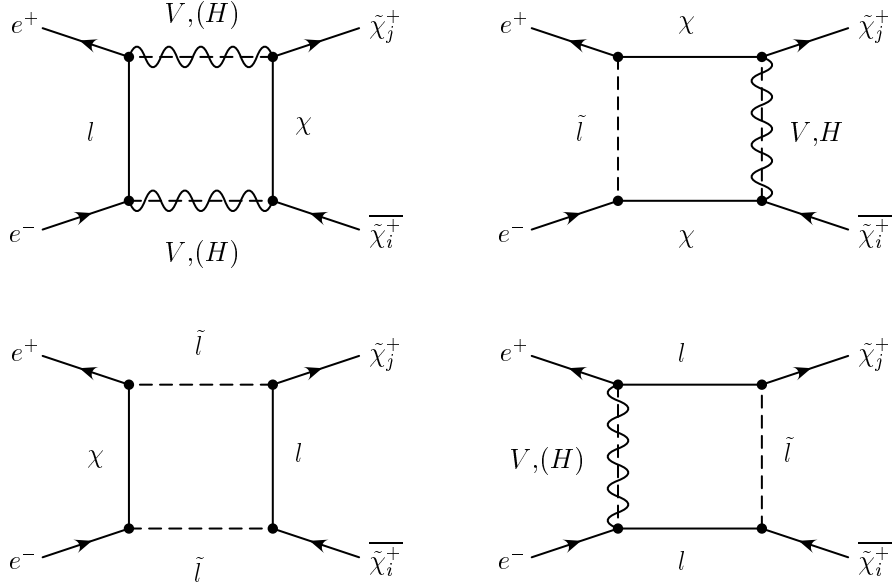

The diagrams with a Higgs line attached to an electron line are negligible, owing to the small electron Yukawa coupling.

The previously calculated fermion/sfermion-loop terms are contained in the self-energy diagrams, in the $V\chi\chi$ vertex corrections, and in the wave-function renormalization from the external-chargino self-energies.

For a complete one-loop calculation, the full particle spectrum of the MSSM has to be taken into account in the loop diagrams, and the process becomes dependent on all the parameters of the model. The parameters are chosen in the following way:

gauge sector:	α, M_Z, M_W
Higgs sector:	$M_A, \tan \beta$
gaugino sector:	M_2, M_1, μ
sfermion sector:	$M_{\tilde{L}}, M_{\tilde{Q}}, A_f$.

The sfermion-mass parameters for the slepton and squark generations $M_{\tilde{L},\tilde{Q}}$, for simplicity, are chosen as equal in the numerical analysis.

Applying the on-shell renormalization scheme to the charginos, the chargino masses $m_{\tilde{\chi}_1^+}, m_{\tilde{\chi}_2^+}$ are considered to be the pole masses, which fixes the mass counterterms by the on-shell values of the chargino self-energies. In this way, the parameters M_2 and μ are determined in terms of the chargino masses, in the same way as in the lowest order relations. Their physical meaning, however, is different from e.g. those in a \overline{MS} renormalization scheme, which becomes important when comparisons between different schemes are performed. In a similar way, the $\tilde{\nu}_e$ on-shell mass renormalization relates the

slepton mass parameter to the $\tilde{\nu}_e$ mass, $m_{\tilde{\nu}_e}^2 = M_{\tilde{L}}^2 + \cos(2\beta) M_Z^2/2$. The other parameters enter only at the one-loop level and hence do not need renormalization.

A special subtlety arises from the contributions with virtual photons attached to two external charged particles, which are infrared divergent. To obtain an infrared-finite result, real-photon bremsstrahlung from the external legs has to be taken into account. After integrating over the photon phase space, the sum of the one-loop and the bremsstrahlung cross section is IR-finite. Different from standard-fermion production, these photonic contributions cannot be removed and treated separately as ‘‘QED corrections’’, because the one-loop result without the virtual photons would not be UV-finite even after renormalization. The presence of the photon is required to cancel the divergence owing to the photino component of the virtual neutralinos. This is a new aspect, which does not appear in the approximate calculation with (s)fermion-loops only.

3 Numerical Results

In this section we provide an illustration of the higher-order effects by choosing specific examples of parameters. We consider the unpolarized integrated cross section (2) and forward-backward asymmetry (3), and the left-right asymmetry (4). As a fixed input parameter, the mass of the pseudoscalar Higgs boson is set to $M_A = 150$ GeV. The mass parameters $M_{\tilde{L}} = M_{\tilde{Q}}$, assumed to be equal for all generations and for left/right chiralities, are denoted by the common mass scale M_{SUSY} ; sfermions are treated as unmixed. Moreover, between the gaugino masses M_1 and M_2 , the usual GUT relation is assumed.

(i) *Integrated cross section:* For demonstration of the loop effects, we define the relative correction

$$\Delta = \frac{\sigma - \sigma_0}{\sigma_0} \quad (5)$$

to the lowest-order cross section σ_0 . Thereby, σ_0 is an improved Born cross section, which already incorporates the large effects arising from the light standard fermions, i.e. the following specifications are made:

- The fine-structure constant α is replaced by the QED-running effective fine-structure constant $\alpha(s)$ in the photon-exchange diagram;
- The normalization of the weak coupling to the Z boson is chosen in terms of the Fermi constant: $(G_F M_Z^2)^{1/2}$;
- The normalization of the $e\tilde{\nu}_e\tilde{\chi}^-$ coupling is chosen as $(G_F M_W^2)^{1/2}$.

Since, for a IR-finite result, we have to include photon bremsstrahlung, which is treated in the soft-photon approximation (with a cut $k_\gamma < 0.05\sqrt{s}$). A large part of the one-loop corrections is due to initial-state real and virtual photonic corrections. These initial-state corrections contain large logarithms of the type $\log(s/m_e^2)$ from collinear radiation. Such terms are universal; they are conventionally taken into account already by convoluting the Born cross section with a radiator function,

$$\sigma(s) = \int_0^{k_{max}} dk H(k) \sigma_0((1-k)s). \quad (6)$$

We therefore drop the universal terms from initial-state radiation (ISR) in our one-loop result and display only the non-universal residual corrections in the numerical presentation.

Figure 1 displays the relative one-loop correction Δ , eq. (5), for the production cross section of a light-chargino pair as a function of $\tan\beta$. The low- $\tan\beta$ region, although experimentally ruled out meanwhile from Higgs-boson searches [3], is kept for illustration to outline the effect of the top-Yukawa-coupling enhancement. The gaugino mass M_2 is kept fixed; varying $\tan\beta$ thus corresponds to a variation of μ , which can be both negative and positive. Typically, the higher-order contributions are between 5 and 10%.

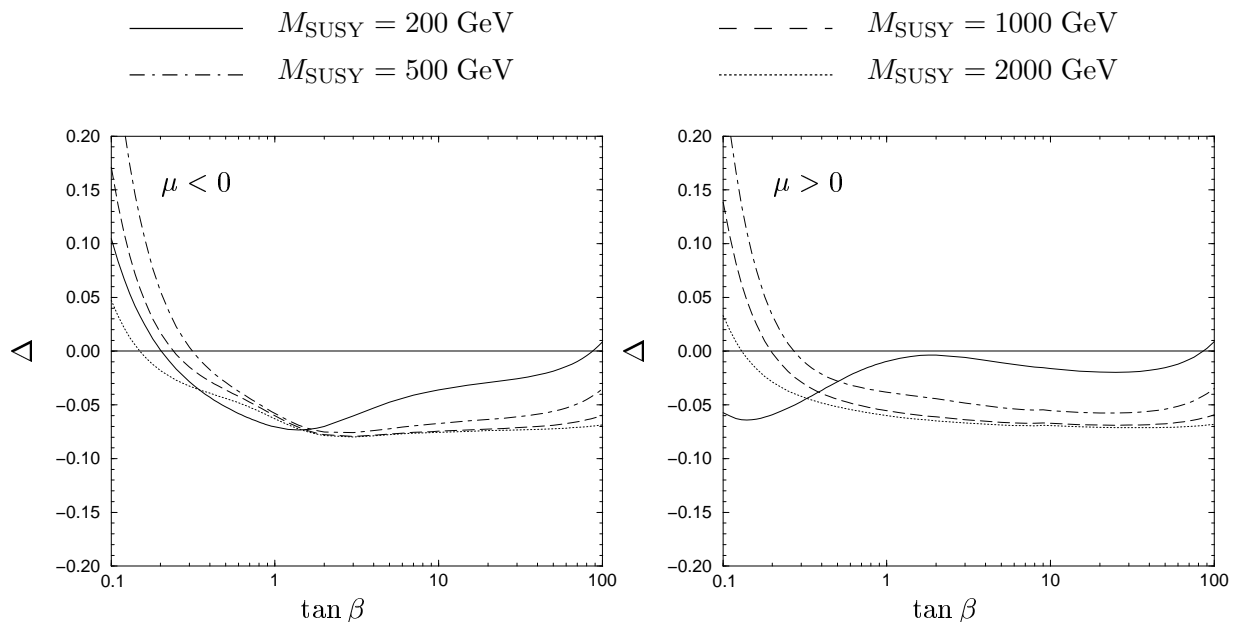

Figure 1: The one-loop corrections to the production cross section of a pair of light charginos with $m_{\tilde{\chi}_1^+} = 150$ GeV and $M_2 = 200$ GeV, normalized to the Born approximation, for a center-of-mass energy of $\sqrt{s} = 500$ GeV.

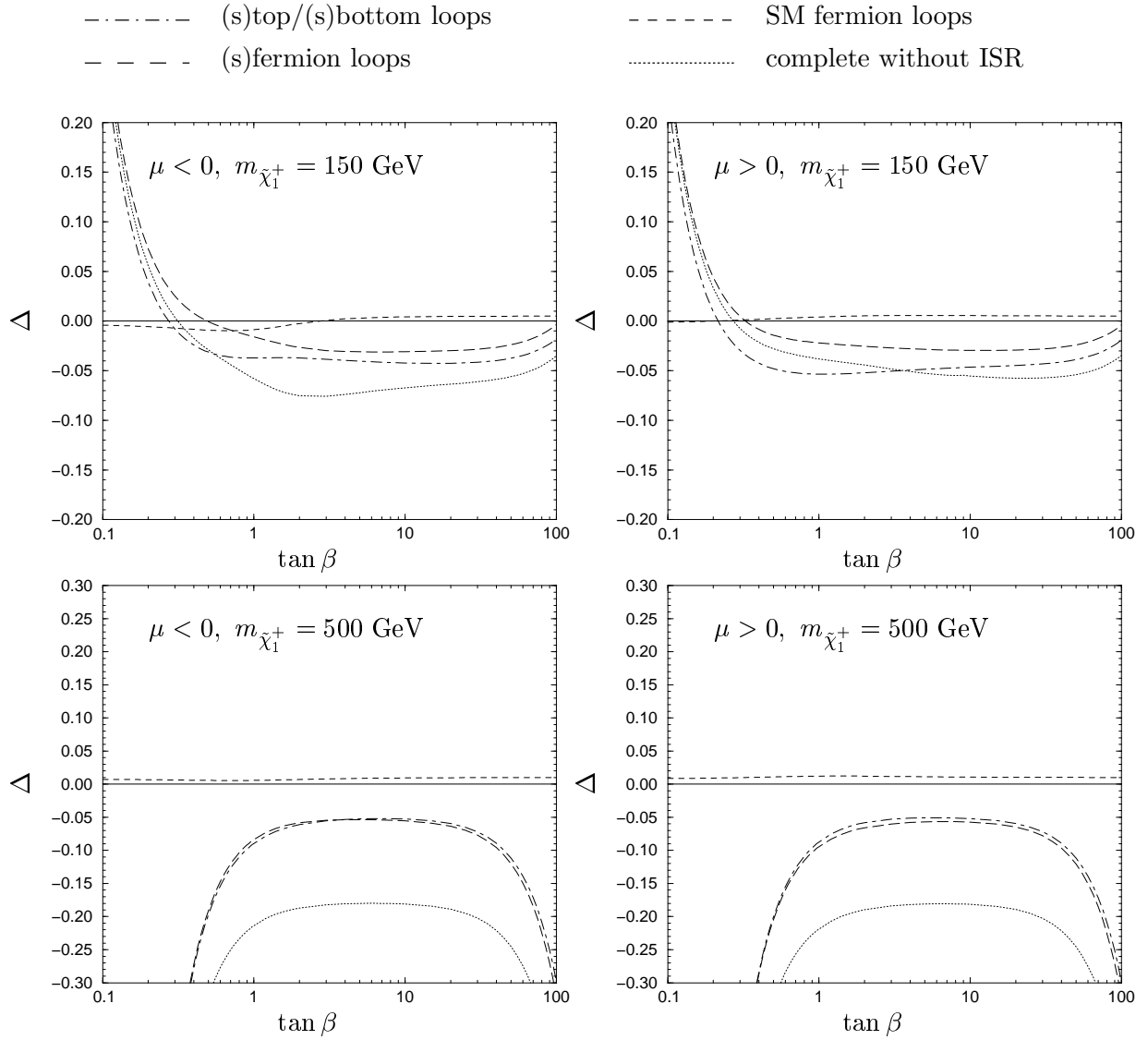

Figure 2: One-loop corrections to the chargino-pair production cross section, normalized to the Born approximation. The various lines show the contributions from different subsets of diagrams. Upper (lower) row: $M_2 = 200 \text{ GeV}$ (800 GeV), $\sqrt{s} = 500 \text{ GeV}$ (1 TeV), $M_{\text{SUSY}} = 500 \text{ GeV}$.

The breakdown of the complete set of radiative corrections into the various subsets of classes of diagrams is shown in Figure 2, for two values of the lighter-chargino mass: the subset with only top/stop and bottom/sbottom loops, the subset with all fermion and sfermion loops, and the set with the complete one-loop terms. For illustration, also the effect resulting from the standard-model light fermions is included. As expected, the standard-fermion loop contribution is very small since its main effect is already incorporated in the Born cross section in terms of the running fine-structure constant. The figure demonstrates the comparable size of the various subclasses and underlines the importance of a full calculation.

(ii) *Forward-backward asymmetry*: The angular distribution of the produced $\tilde{\chi}_i^+$ shows an asymmetry, originating at the tree level from the different left- and right-handed couplings to the Z and from the t -channel-exchange diagram. This angular asymmetry can be expressed in terms of the forward-backward asymmetry A_{FB} , eq. (3), which is displayed in Figure 3 as a function of the CMS energy, for unpolarized beams.

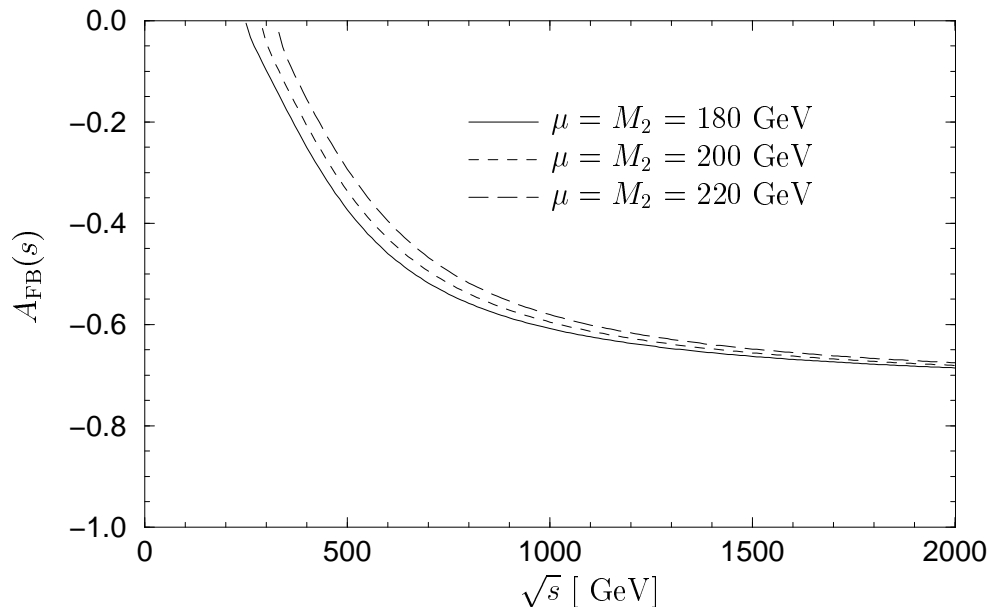

Figure 3: The forward-backward asymmetry in Born approximation for the production of two light charginos $e^+e^- \rightarrow \tilde{\chi}_1^+ \tilde{\chi}_1^-$. $\tan \beta = 10$, $M_{\text{SUSY}} = 300$ GeV.

The loop diagrams represent an additional source for A_{FB} , which can be described in terms of a shift ΔA_{FB} according to

$$A_{\text{FB}} = A_{\text{FB}}^{\text{Born}} + \Delta A_{\text{FB}}. \quad (7)$$

This shift is shown in Figure 4 for the same set of parameters as in Figure 1. The loop contributions can thus modify the asymmetry by up to 10%. In order to illustrate the total effect from the loops, we include also the contribution from the subclass of only fermion/sfermion diagrams (lower two figures). The significance of the non-(s)fermionic loop contributions is clearly visible.

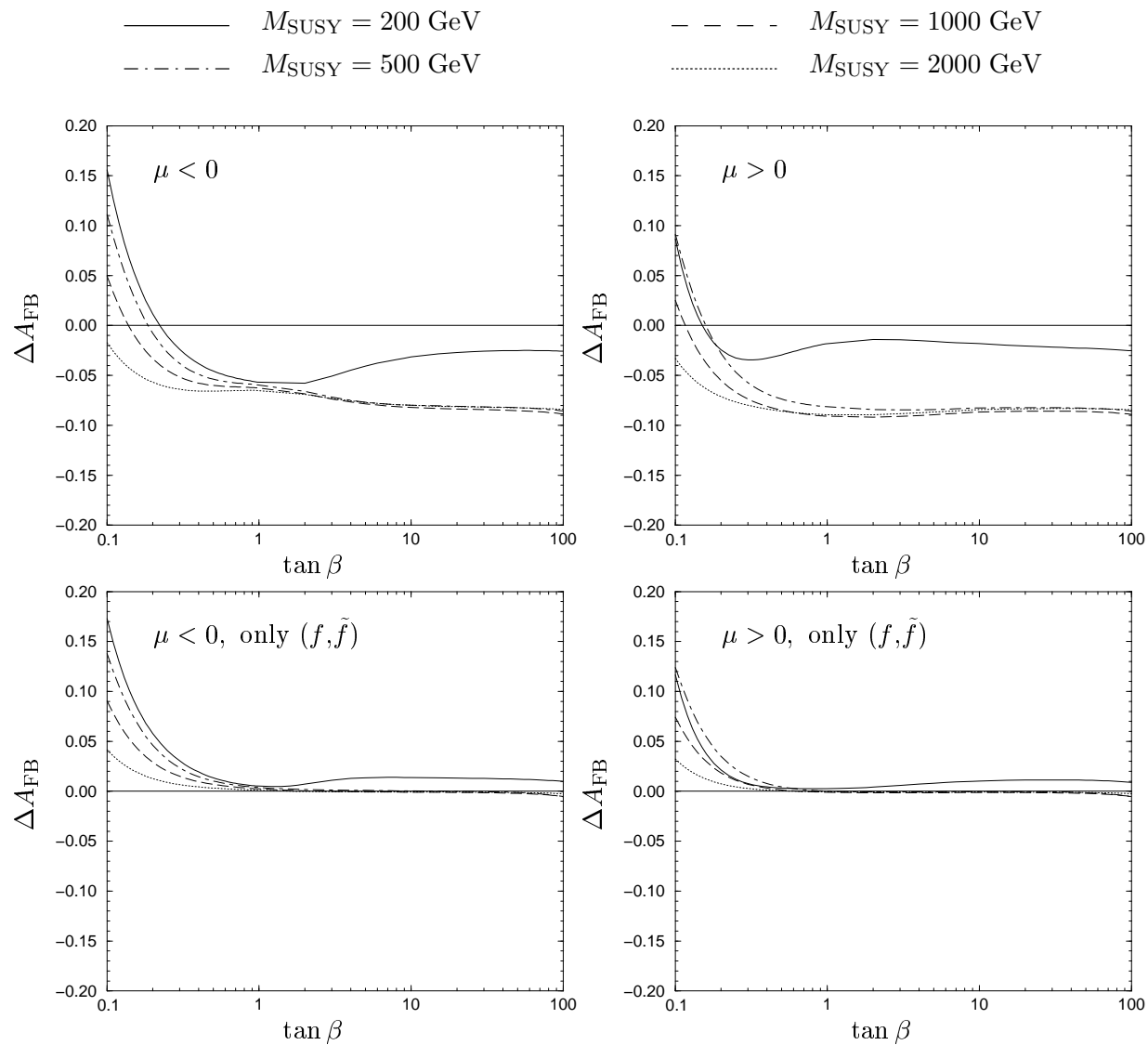

Figure 4: The radiative corrections to the forward backward asymmetry for the production of two light charginos with $m_{\tilde{\chi}_1^+} = 150 \text{ GeV}$, $M_2 = 200 \text{ GeV}$ and $\sqrt{s} = 500 \text{ GeV}$. At the top, the complete corrections are shown. At the bottom, only the (s)fermion loops are taken into account.

(iii) *Left-right asymmetry*: The left-right asymmetry A_{LR} , eq. (4), is of specific interest for probing the fundamental parameters of the MSSM [1], since the $\tilde{\nu}_e$ -exchange diagram is absent for right-handed electrons. In order to point out the contributions from the higher-order terms, we define a loop-induced shift ΔA_{LR} with respect to the Born term, according to

$$A_{\text{LR}} = A_{\text{LR}}^{\text{Born}} + \Delta A_{\text{LR}}. \quad (8)$$

This shift is displayed in Figure 5. Again, the same set of parameters has been used as in Figures 1 and 4. For illustration, the approximate results from only (s)fermion-loop diagrams are also shown (lower two figures). The differences are less pronounced than in the case of A_{FB} , but still they are significant and recommend the use of a full calculation for precise predictions.

4 Conclusions

A complete one-loop calculation for chargino-pair production in electron-positron collisions has been performed, using the on-shell renormalization scheme. Applications to the integrated cross sections and to the forward-backward asymmetry A_{FB} for unpolarized beams, as well as to the left-right asymmetry A_{LR} , have shown that the higher-order effects have a sizeable influence on the theoretical predictions and therefore should be properly taken into account for detailed studies in the MSSM.

This work has been supported by the DFG Forschergruppe ‘‘Quantenfeldtheorie, Computeralgebra und Monte Carlo Simulation’’ and by the European Union under contract HPRN-CT-2000-00149.

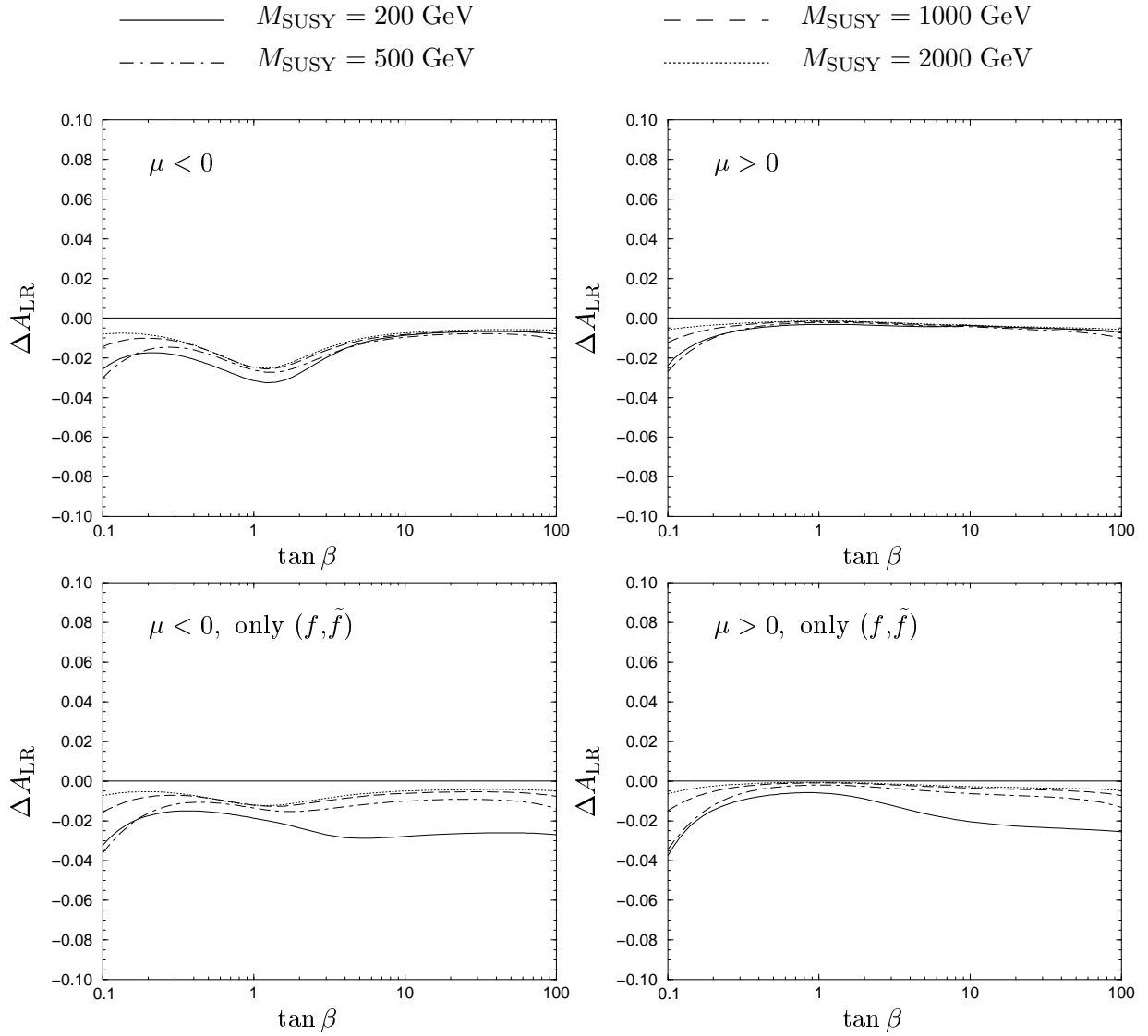

Figure 5: The radiative corrections to the left right asymmetry for the production of two light charginos with $m_{\tilde{\chi}_1^+} = 150$ GeV, $M_2 = 200$ GeV and $\sqrt{s} = 500$ GeV. At the top, the complete corrections are shown. At the bottom, only the (s)fermion loops are taken into account.

References

- [1] S.Y. Choi, A. Djouadi, M. Guchait, J. Kalinowski, H.S. Song, P.M. Zerwas, *Eur. Phys. J. C* 14 (2000) 535 [hep-ph0002033];
G. Moortgat-Pick, A. Bartl, H. Fraas, W. Majerotto, hep-ph/0004181
- [2] M.A. Diaz, S.F. King, D.A. Ross, *Nucl. Phys. B* 529 (1998) 23;
S. Kiyoura, M. Nojiri, D.M. Pierce, Y. Yamada, *Phys. Rev. D* 58 (1998) 075002
- [3] P. Igo-Kemenes, plenary talk at the XXXth International Conference on High Energy Physics, July 27 - August 2, 2000, Osaka, Japan