

USC-FP/99-01
January 18, 1998

The Micro Wire Detector

B. Adeva, F. Gómez, A. Pazos,
R. Pfau* , M. Pló†, J. M. Rodríguez, P. Vázquez
Universidade de Santiago de Compostela ‡

J. C. Labbé
CERN

Abstract

We present the performance of a new proportional gas detector. Its geometry consists of a cathode plane with $70 \times 70 \mu\text{m}^2$ apertures, crossed by $25 \mu\text{m}$ anode strips to which it is attached by $50 \mu\text{m}$ kapton spacers. In the region where the avalanche takes place, the anode strips are suspended in the gas mixture like in a standard wire chamber. This detector exhibits high rate capability and large gains, introducing very little material.

PACS: 2940, 2970

Keywords: MSGC, Gas Detector

Submitted to Nuclear Instruments and Methods A

*Visiting student from Heidelberg University.

† Corresponding author: Tel. +34-981-563100-13987, Fax: +34-981-521091, e-mail: Maximo.Plo@cern.ch

‡Work supported by Comisión Interministerial de Ciencia y Tecnología (CICYT), projects AEN96-1671 and AEN97-1706-E.

1 Introduction

A variety of micropattern gas detectors have emerged recently, in close relation with the introduction of advanced printed circuit technology. The possibility of kapton etching has allowed new geometries like the Gas Electron Multiplier (GEM) [1], the Micro Groove Detector [2], the Well Detector [3], or the Micro Slit Gas Detector (MSGD) [4]. These avalanche detectors have provided significant improvements towards the construction of a suitable gas detector for the high radiation environment of the LHC. We present here, as a result of a collaboration between the University of Santiago and the CERN CMT and SMT groups, a new idea that arises as an improvement with respect to the MSGD, which has good charge collection properties, but a limited gain (typically around 2000). The openings in the kapton foil have been reduced so as to have a pattern very similar to a GEM on one side of the detector layer. The other side, however, is made of metal strips, or wires, running across the kapton holes. The better mechanical stability of this setup, having less suspended length than in the case of the MSGD, allowed to produce thinner strips. In this way we obtain a single-stage, high gain, proportional device, combining the focused electric field in the micro-hole with the standard wire amplification and charge collection. This is why we call this device a Micro Wire Detector (μ WD). The test of the first prototypes presented here have shown very promising results of this scheme, as a real option for a high rate tracking detector with very low amount of material.

2 Detector description

Two prototypes $10 \times 10\text{cm}^2$ of the μ WD have been built and tested. The first of them consists of a kapton foil with a thickness of $50\mu\text{m}$ copper metallized ($5\mu\text{m}$) on both sides. On one side a pattern of square holes $70 \times 70\mu\text{m}^2$ has been lithographically etched. On the opposite side $25\mu\text{m}$ wide strips are also etched ensuring that they run in the middle of the square holes pattern. The kapton is then removed in such a way that just an insulating mechanical joint between anode (strips) and cathode (mesh of square holes) remains (see Figure 1). The real setup can be appreciated in the electron microscope photographs shown in Figure 2. The second detector has been built in the

same way, with $60 \times 60 \mu\text{m}^2$ cathode apertures and $25 \mu\text{m}$ kapton thickness. The pitch of the anode strips is $100 \mu\text{m}$. In this design, the strips are joined in groups of two at the detector end. The chamber is finally assembled by enclosing the detector foil between two 3mm height Vectronite frames, sealed with two kapton metallized foils. The foil in front of the cathode provides the drift field while the other is set to ground.

The main differences respect to other micropattern gas detectors are that anodes are suspended and no substrate for them is needed, and that these anodes run aligned respect to the holes in the cathode metallic mesh. The detector foil material represents only 0.037% of a radiation length¹. Moreover this design allows the construction of a mirror cathode device (see Figure 3) , using a second kapton foil with another cathode mesh. This scheme would imply a faster operation by improving the charge collection time as a consequence of the reduced drift gap. Also, this configuration would be less sensitive with respect to the Lorentz angle under magnetic field.

3 Detector performance

The first prototypes have been tested in mixtures of Ar–DME 50–50%. In Figure 4 we present the gain dependence on the cathode and drift voltages, as measured by a charge sensitive preamplifier² integrating the avalanche charge produced by a 5.9 keV X-ray from a ⁵⁵Fe radioactive source. It can be seen that gains exceeding 15000 are achievable thanks to the high non–uniformity of the electric field³ in the detector foil as it is shown in Figure 5.

In Figure 6 we show the gain dependence on the cathode voltage for the two different prototypes. These results were obtained from X-ray signals from a Cr anode tube. Although the μWD with a kapton thickness of $25 \mu\text{m}$ exhibits higher gains, in the present development stage, the mechanical and electrical robustness of the $50 \mu\text{m}$ foil provided more reliable working conditions. The operation of the device in non flammable mixtures (like Ar- CO_2 50–50) is also possible as shown in the same figure, although with reduced values of the gain factor.

¹In the complete detector, the contribution on the drift electrode and gas should be added.

²ORTEC 142PC

³Computed with MAXWELL *3DParameterExtractor* program.

In order to study the rate capability and current distributions, the detector was irradiated again with a high intensity Cr X-ray tube. Rate capability was tested directly using a current amplifier⁴ at high rate where the peak value from the current spectra was monitored. The gain variations are less than 5% up to rates as high as 4×10^5 Hz mm⁻² (Figure 7).

Beginning from a cold start, charging up from the kapton spacers affects the gain less than a 10%, as shown in Figure 8. The uniformity of the gain was also measured in 2mm steps over a length of 5cm along the strips. The variations with respect to the mean were less than 10% (Figure 9). These results show that the cathode and anode planarity and the thickness uniformity of the kapton spacers are good enough.

In Figure 10 we show the anode, cathode and drift currents versus the cathode voltage (a) and versus the drift field (b) while the detector was irradiated with a high intensity X-ray beam with a 2mm diameter collimation. It is possible to obtain field configurations in which 90% of the ions migrate to the cathode producing a fast charge collection device. In Figure 11 we show the fast avalanche signal from a current amplifier (VT 120) originated by a 5.9 keV photon.

4 Conclusions

We present a new gas proportional device, the Micro Wire Detector. This high granularity (100 μ m pitch) position sensitive detector exhibits excellent performance characteristics: high rate capability (up to $.4 \cdot 10^6$ Hz/mm²), very low amount of interposed material (0.037% X₀) and high gain factor ($\sim 10^4$). Although further tests and improvements are needed, we consider it as a very promising new kind of micropattern gas device.

5 Acknowledgements

One of us (J.C. Labbé) would like to thank A. Placci (CERN/EP/TA1) for his encouragement and assistance to the technical development of the detector.

⁴ ORTEC VT120

We thank A. Monfort, M. Sánchez (CERN EP/PES/LT Bureau d' études Electroniques), L. Mastrostefano and D. Berthet (CERN EST/SM Section des Techniques Photomécaniques). Also we acknowledge A. Gandi, responsible of the Section des Techniques Photomécaniques, for his logistic support.

We are also grateful to Luciano Sánchez, from LADICIM (Universidad de Cantabria), for the excellent electron microscope pictures.

References

- [1] F. Sauli, **GEM: A new concept for electron amplification in gas detectors**, NIM A535 (1993) 69.
- [2] R. Bellazzini, et al, **The Micro-Groove Detector**, INFN PI/AE 98/02.
- [3] R. Bellazzini, et al, **The WELL Detector**, INFN PI/AE 98/03.
- [4] C. Labbé, et al. **The Micro Slit Gas Detector**, CERN-PPE-98-166.

Figure Captions

- Figure 1: Design of the Micro Wire Detector foil.
- Figure 2: Electron microscope image of the detector foil as seen from the cathode side (a), and the same foil seen from the anode side (b).
- Figure 3: Schematic view of the double cathode μ WD proposed in the article.
- Figure 4: Gain of the $50\mu\text{m}$ μ WD as a function of the cathode voltage in Ar-DME 50-50, obtained from the pulse height spectra of a ^{55}Fe source (a). Gain of the same prototype as a function of drift field (b).
- Figure 5: Electric field configuration for one detector cell in the plane transverse to the anode direction (across the middle of one hole). Lines correspond to equal electric field intensity in kV/cm ($V_{anode}=0\text{V}$, $V_{cathode}=-500\text{V}$, $V_{drift}=-3000\text{V}$). Straight lines indicate the limits of the kapton spacer not intersected by the chosen xz plane.
- Figure 6: Comparison of the calibrated gain factor between the $50\mu\text{m}$ and $25\mu\text{m}$ prototypes tested in Ar-DME 50-50. Also it is shown the gain for the $50\mu\text{m}$ prototype with Ar-CO₂ 50-50.
- Figure 7: Relative values of the peak current spectra (from the signal of a VT120 amplifier) versus the photon rate interactions from a Cr anode X-ray tube.
- Figure 8: Relative variations of the gain as a function of time, measured every 30s, beginning from a cold start.
- Figure 9: Relative variations of the detector gain measured in 2mm steps over a length of 5cm along the strips.
- Figure 10: Anode, drift and cathode currents versus: (a) cathode voltage and (b) drift field, under high intensity X-ray irradiation (2mm diameter collimator).
- Figure 11: Avalanche signal of a 5.9 keV photon interaction from a ^{55}Fe source obtained with the VT120 ORTEC amplifier. Note that the horizontal scale is 10ns/division and vertical scale is 20mV/division.

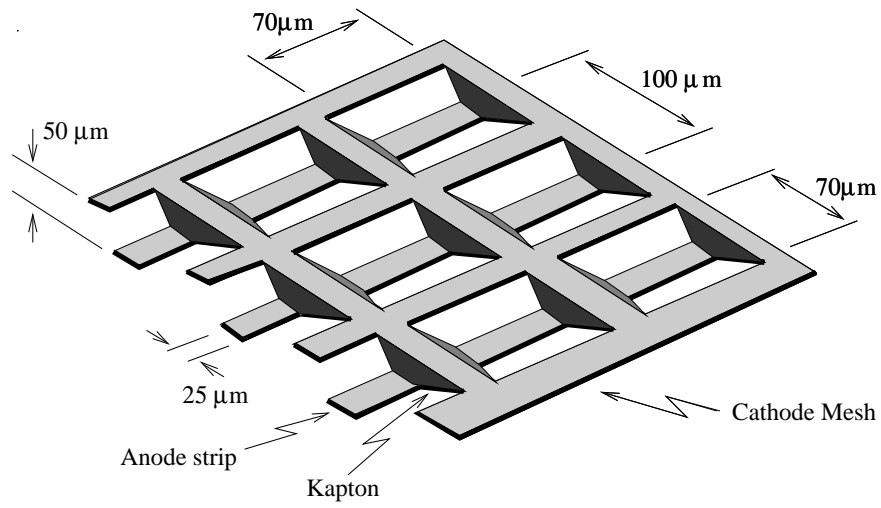

Figure 1

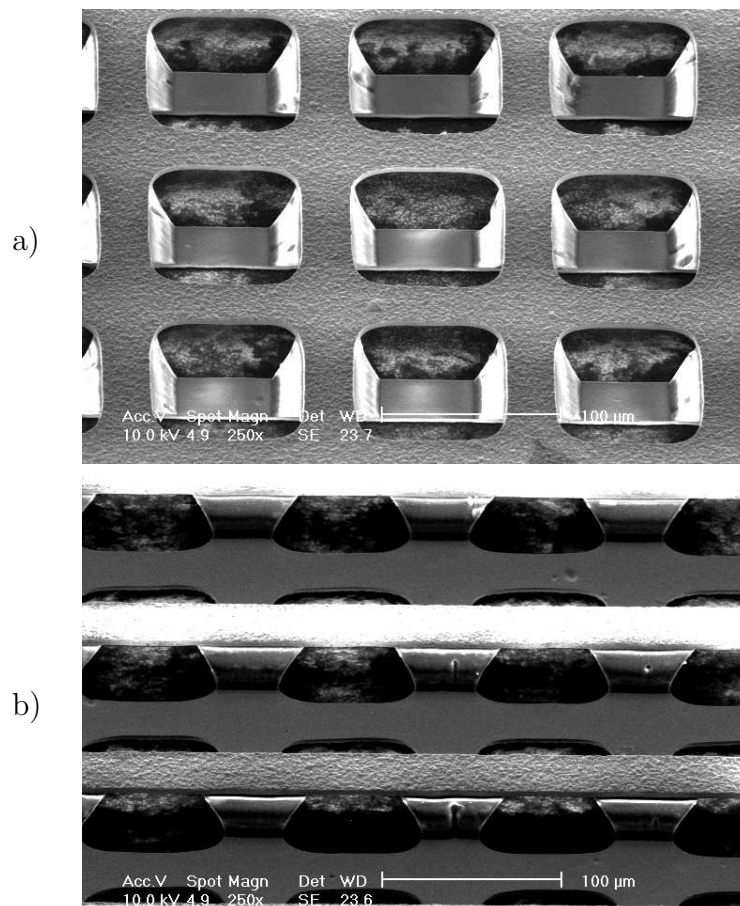

Figure 2

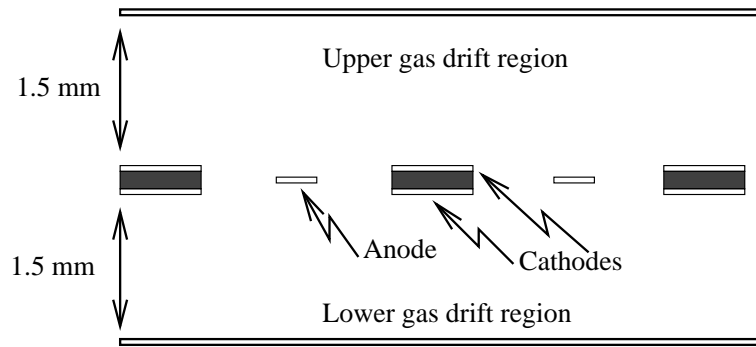

Figure 3

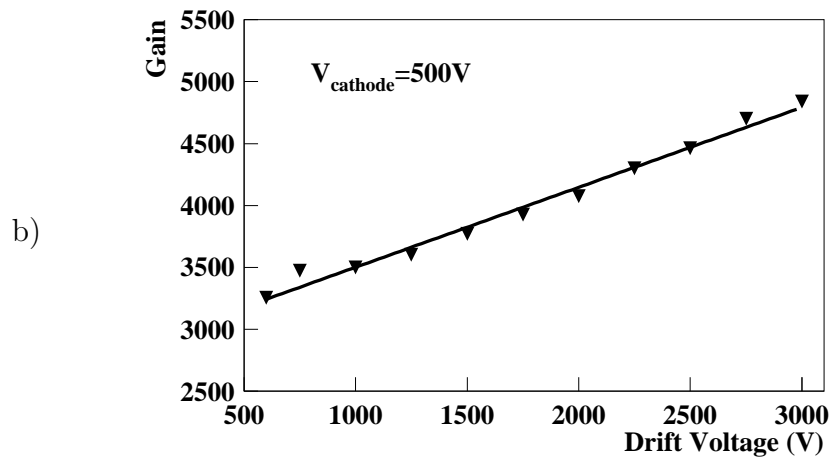
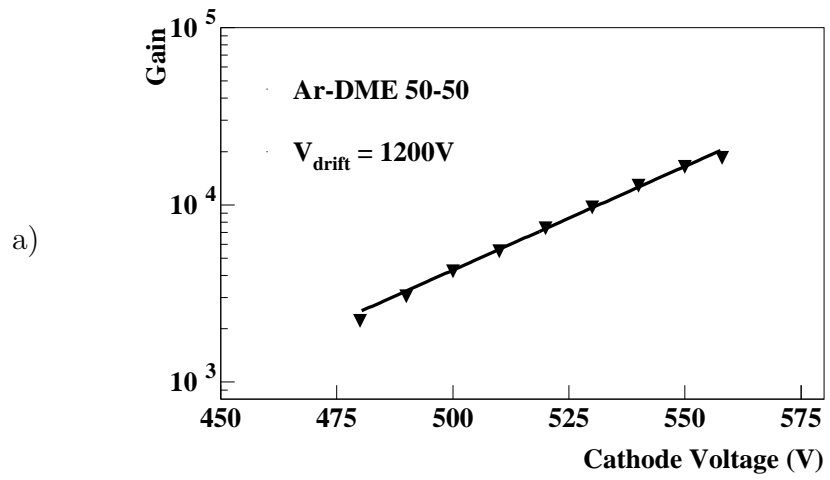

Figure 4

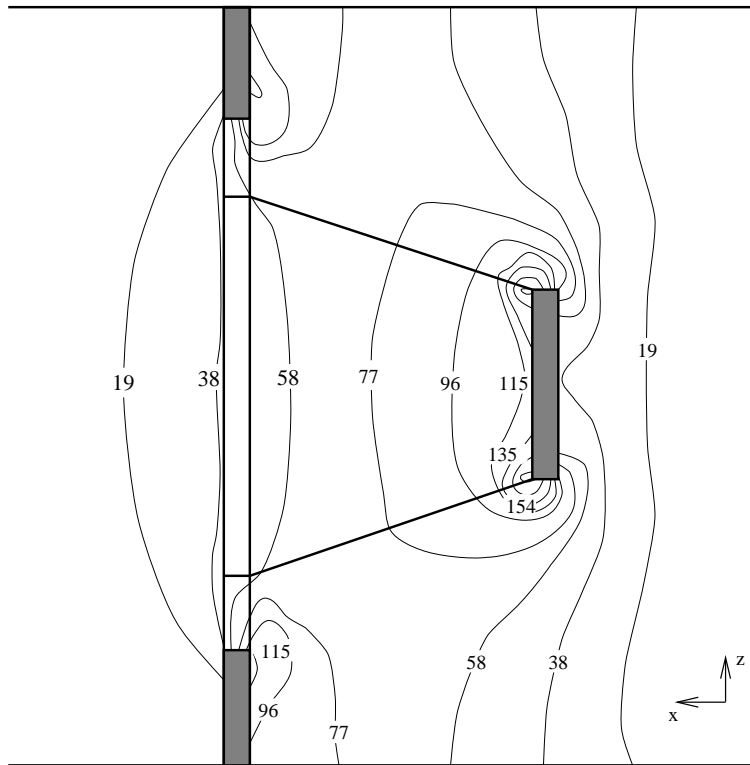
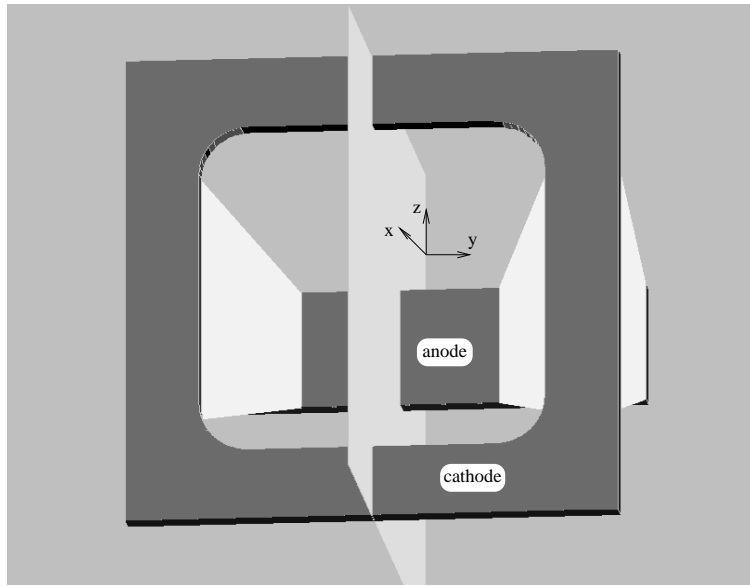

Figure 5

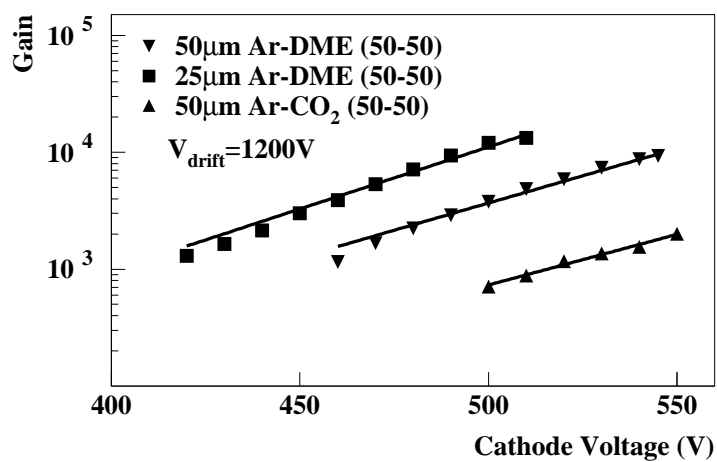

Figure 6

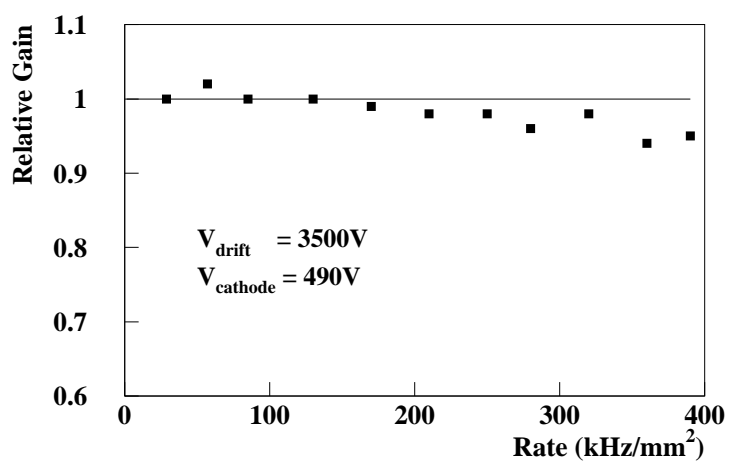

Figure 7

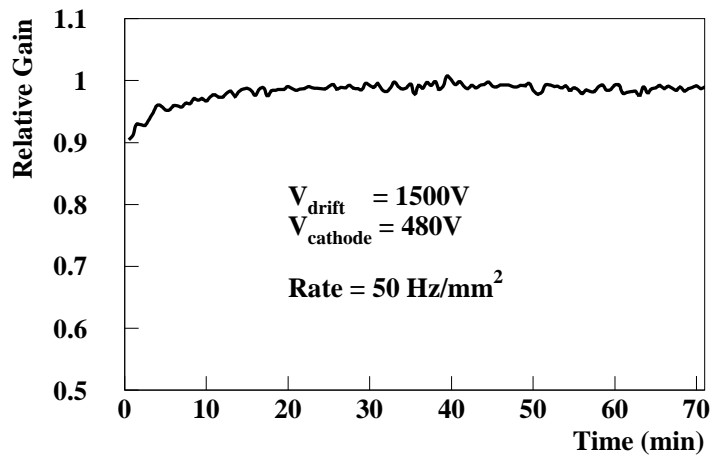

Figure 8

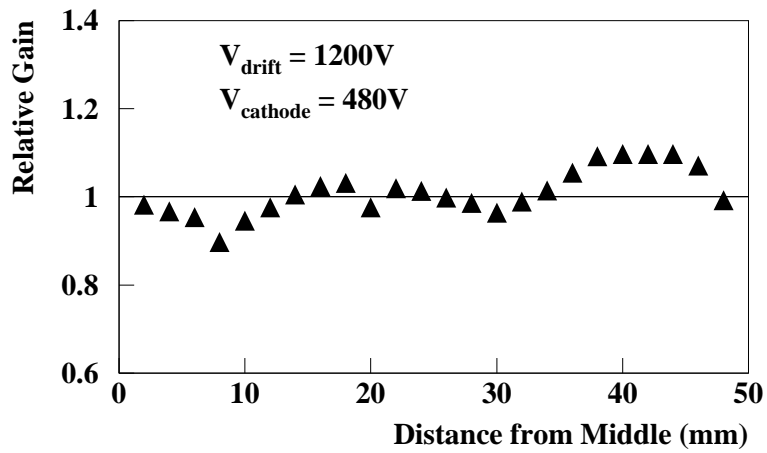

Figure 9

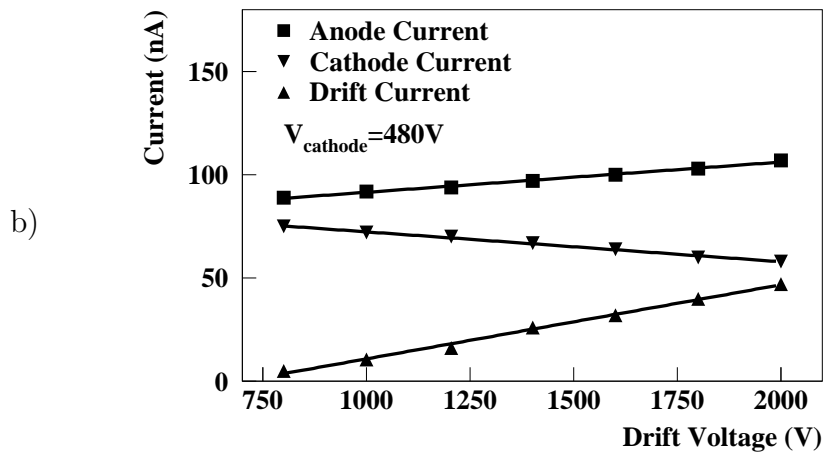
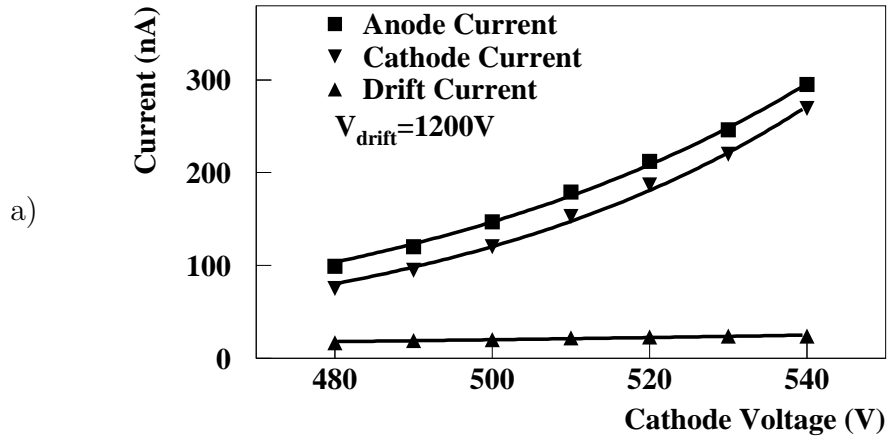

Figure 10

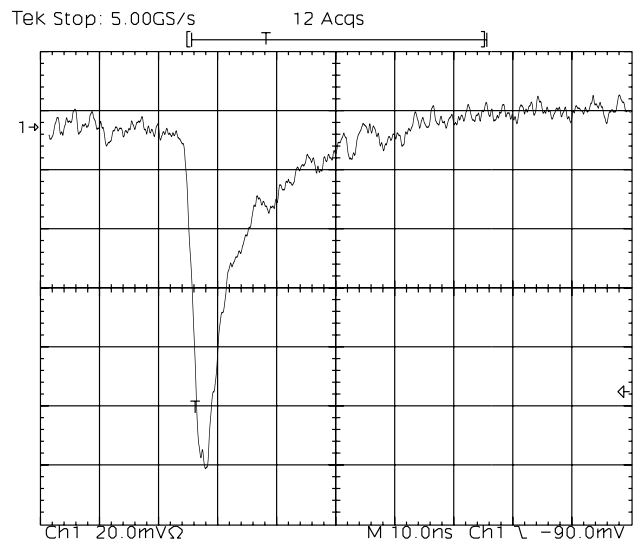

Figure 11