

An Introduction to Spin Foam Models of BF Theory and Quantum Gravity

John C. Baez

Department of Mathematics, University of California
Riverside, California 92521
USA

email: baez@math.ucr.edu

May 20, 1999

Abstract

In loop quantum gravity we now have a clear picture of the quantum geometry of *space*, thanks in part to the theory of spin networks. The concept of ‘spin foam’ is intended to serve as a similar picture for the quantum geometry of *spacetime*. In general, a spin network is a graph with edges labelled by representations and vertices labelled by intertwining operators. Similarly, a spin foam is a 2-dimensional complex with faces labelled by representations and edges labelled by intertwining operators. In a ‘spin foam model’ we describe states as linear combinations of spin networks and compute transition amplitudes as sums over spin foams. This paper aims to provide a self-contained introduction to spin foam models of quantum gravity and a simpler field theory called BF theory.

1 Introduction

Spin networks were first introduced by Penrose as a radical, purely combinatorial description of the geometry of spacetime. In their original form, they are trivalent graphs with edges labelled by spins:

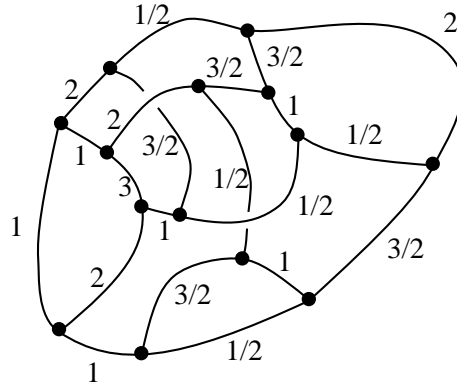

In developing the theory of spin networks, Penrose seems to have been motivated more by the quantum mechanics of angular momentum than by the details of general relativity. It thus came as a delightful surprise when Rovelli and Smolin discovered that spin networks can be used to describe states in loop quantum gravity.

Fundamentally, loop quantum gravity is a very conservative approach to quantum gravity. It starts with the equations of general relativity and attempts to apply the time-honored principles of quantization to obtain a Hilbert space of states. There are only two really new ideas in loop quantum gravity. The first is its insistence on a background-free approach. That is, unlike perturbative quantum gravity, it makes no use of a fixed ‘background’ metric on spacetime. The second is that it uses a formulation of Einstein’s equations in which parallel transport, rather than the metric, plays

the main role. It is very interesting that starting from such ideas one is naturally led to describe states using spin networks!

However, there is a problem. While Penrose originally intended for spin networks to describe the geometry of spacetime, they are really better for describing the geometry of *space*. In fact, this is how they are used in loop quantum gravity. Since loop quantum gravity is based on canonical quantization, states in this formalism describe the geometry of space at a fixed time. Dynamics enters the theory only in the form of a constraint called the Hamiltonian constraint. Unfortunately this constraint is still poorly understood. Thus until recently, we had almost no idea what loop quantum gravity might say about the geometry of *spacetime*.

To remedy this problem, it is natural to try to supplement loop quantum gravity with an appropriate path-integral formalism. In ordinary quantum field theory we calculate path integrals using Feynman diagrams. Copying this idea, in loop quantum gravity we may try to calculate path integrals using ‘spin foams’, which are a 2-dimensional analogue of Feynman diagrams. In general, spin networks are graphs with edges labelled by group representations and vertices labelled by intertwining operators. These reduce to Penrose’s original spin networks when the group is $SU(2)$ and the graph is trivalent. Similarly, a spin foam is a 2-dimensional complex built from vertices, edges and polygonal faces, with the faces labelled by group representations and the edges labelled by intertwining operators. When the group is $SU(2)$ and three faces meet at each edge, this looks exactly like a bunch of soap suds with all the faces of the bubbles labelled by spins — hence the name ‘spin foam’.

If we take a generic slice of a spin foam, we get a spin network. Thus we can think of a spin foam as describing the geometry of spacetime, and any slice of it as describing the geometry of space at a given time. Ultimately we would like a ‘spin foam model’ of quantum gravity, in which we compute transition amplitudes between states by summing over spin foams going from one spin network to another:

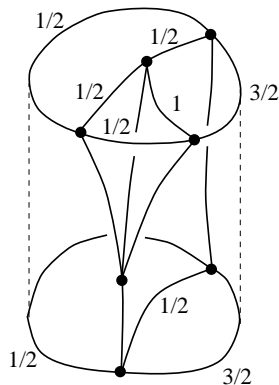

At present this goal has been only partially attained. For this reason it seems best to start by discussing spin foam models of a simpler theory, called BF theory. In a certain sense this the simplest possible gauge theory. It can be defined on spacetimes of any dimension. It is ‘background-free’, meaning that to formulate it we do not need a pre-existing metric or any other such geometrical structure on spacetime. At the classical level, the theory has no local degrees of freedom: all the interesting observables are global in nature. This remains true upon quantization. Thus BF theory serves as a simple starting-point for the study of background-free theories. In particular, general relativity in 3 dimensions is a special case of BF theory, while general relativity in 4 dimensions can be viewed as a BF theory with extra constraints. Most work on spin foam models of 4-dimensional quantum gravity seeks to exploit this fact.

In what follows, we start by describing BF theory at the classical level. Next we canonically quantize the theory and show the space of gauge-invariant states is spanned by spin networks. Then

we use the path-integral formalism to study the dynamics of the theory and show that the transition amplitude from one spin network state to another is given as a sum over spin foams. When the dimension of spacetime is above 2, this sum usually diverges. However, in dimensions 3 and 4, we can render it finite by adding an extra term to the Lagrangian of BF theory. In applications to gravity, this extra term corresponds to the presence of a cosmological constant. Finally, we discuss spin foam models of 4-dimensional quantum gravity.

At present, work on spin foam models is spread throughout a large number of technical papers in various fields of mathematics and physics. This has the unfortunate effect of making the subject seem more complicated and less beautiful than it really is. As an attempt to correct this situation, I have tried to make this paper as self-contained as possible. For the sake of smooth exposition, I have relegated all references to the Notes, which form a kind of annotated bibliography of the subject. The remarks at the end of each section contain information of a more technical nature that can safely be skipped.

2 BF Theory: Classical Field Equations

To set up BF theory, we take as our gauge group any Lie group G whose Lie algebra \mathfrak{g} is equipped with an invariant nondegenerate bilinear form $\langle \cdot, \cdot \rangle$. We take as our spacetime any n -dimensional oriented smooth manifold M , and choose a principal G -bundle P over M . The basic fields in the theory are then:

- a connection A on P ,
- an $\text{ad}(P)$ -valued $(n-2)$ -form E on M .

Here $\text{ad}(P)$ is the vector bundle associated to P via the adjoint action of G on its Lie algebra. The curvature of A is an $\text{ad}(P)$ -valued 2-form F on M . If we pick a local trivialization we can think of A as a \mathfrak{g} -valued 1-form on M , F as a \mathfrak{g} -valued 2-form, and E as a \mathfrak{g} -valued $(n-2)$ -form.

The Lagrangian for BF theory is:

$$\mathcal{L} = \text{tr}(E \wedge F).$$

Here $\text{tr}(E \wedge F)$ is the n -form constructed by taking the wedge product of the differential form parts of E and F and using the bilinear form $\langle \cdot, \cdot \rangle$ to pair their \mathfrak{g} -valued parts. The notation ‘tr’ refers to the fact that when G is semisimple we can take this bilinear form to be the Killing form $\langle x, y \rangle = \text{tr}(xy)$, where the trace is taken in the adjoint representation.

We obtain the field equations by setting the variation of the action to zero:

$$\begin{aligned} 0 &= \delta \int_M \mathcal{L} \\ &= \int_M \text{tr}(\delta E \wedge F + E \wedge \delta F) \\ &= \int_M \text{tr}(\delta E \wedge F + E \wedge d_A \delta A) \\ &= \int_M \text{tr}(\delta E \wedge F + (-1)^{n-1} d_A E \wedge \delta A) \end{aligned}$$

where d_A stands for the exterior covariant derivative. Here in the second step we used the identity $\delta F = d_A \delta A$, while in the final step we did an integration by parts. We see that the variation of the action vanishes for all δE and δA if and only if the following field equations hold:

$$F = 0, \quad d_A E = 0.$$

These equations are rather dull. But this is exactly what we want, since it suggests that BF theory is a topological field theory! In fact, all solutions of these equations look the same locally, so BF theory describes a world with no local degrees of freedom. To see this, first note that the equation $F = 0$ says the connection A is flat. Indeed, all flat connections are locally the same up to gauge transformations. The equation $d_A E = 0$ is a bit subtler. It is not true that all solutions of this are locally the same up to a gauge transformation in the usual sense. However, BF theory has another sort of symmetry. Suppose we define a transformation of the A and E fields by

$$A \mapsto A, \quad E \mapsto E + d_A \eta$$

for some $\text{ad}(P)$ -valued $(n-3)$ -form η . This transformation leaves the action unchanged:

$$\begin{aligned} \int_M \text{tr}((E + d_A \eta) \wedge F) &= \int_M \text{tr}(E \wedge F + d_A \eta \wedge F) \\ &= \int_M \text{tr}(E \wedge F + (-1)^n \eta \wedge d_A F) \\ &= \int_M \text{tr}(E \wedge F) \end{aligned}$$

where we used integration by parts and the Bianchi identity $d_A F = 0$. In the next section we shall see that this transformation is a ‘gauge symmetry’ of BF theory, in the more general sense of the term, meaning that two solutions differing by this transformation should be counted as physically equivalent. Moreover, when A is flat, any E field with $d_A E = 0$ can be written locally as $d_A \eta$ for some η ; this is an easy consequence of the fact that locally all closed forms are exact. Thus locally, all solutions of the BF theory field equations are equal modulo gauge transformations and transformations of the above sort.

Why is general relativity in 3 dimensions a special case of BF theory? To see this, take $n = 3$, let $G = \text{SO}(2, 1)$, and let $\langle \cdot, \cdot \rangle$ be minus the Killing form. Suppose first that $E: TM \rightarrow \text{ad}(P)$ is one-to-one. Then we can use it to define a Lorentzian metric on M as follows:

$$g(v, w) = \langle Ev, Ew \rangle$$

for any tangent vectors $v, w \in T_x M$. We can also use E to pull back the connection A to a metric-preserving connection Γ on the tangent bundle of M . The equation $d_A E = 0$ then says precisely that Γ is torsion-free, so that Γ is the Levi-Civita connection on M . Similarly, the equation $F = 0$ implies that Γ is flat. Thus the metric g is flat.

In 3 dimensional spacetime, the vacuum Einstein equations simply say that the metric is flat. Of course, many different A and E fields correspond to the same metric, but they all differ by gauge transformations. So in 3 dimensions, BF theory with gauge group $\text{SO}(2, 1)$ is really just an alternate formulation of Lorentzian general relativity without matter fields — at least when E is one-to-one. When E is not one-to-one, the metric g defined above will be degenerate, but the field equations of BF theory still make perfect sense. Thus 3d BF theory with gauge group $\text{SO}(2, 1)$ may be thought of as an extension of the vacuum Einstein equations to the case of degenerate metrics.

If instead we take $G = \text{SO}(3)$, all these remarks still hold except that the metric g is Riemannian rather than Lorentzian when E is one-to-one. We call this theory ‘Riemannian general relativity’. We study this theory extensively in what follows, because it is easier to quantize than 3-dimensional Lorentzian general relativity. However, it is really just a warmup exercise for the Lorentzian case — which in turn is a warmup for 4-dimensional Lorentzian quantum gravity.

We conclude with a word about double covers. We can also express general relativity in 3 dimensions as a BF theory by taking the double cover $\text{Spin}(2, 1) \cong \text{SL}(2, \mathbb{R})$ or $\text{Spin}(3) \cong \text{SU}(2)$ as gauge group and letting P be the spin bundle. This does not affect the classical theory. As we shall see, it does affect the quantum theory. Nonetheless, it is very popular to take these groups as gauge

groups in 3-dimensional quantum gravity. The question whether it is ‘correct’ to use these double covers as gauge groups seems to have no answer — until we couple quantum gravity to spinors, at which point the double cover is necessary.

Remarks

1. In these calculations we have been ignoring the boundary terms that arise when we integrate by parts on a manifold with boundary. They are valid if either M is compact or if M is compact with boundary and boundary conditions are imposed that make the boundary terms vanish. BF theory on manifolds with boundary is interesting both for its applications to black hole physics — where the event horizon may be treated as a boundary — and as an example of an ‘extended topological field theory’.

3 Classical Phase Space

To determine the classical phase space of BF theory we assume spacetime has the form

$$M = \mathbb{R} \times S$$

where the real line \mathbb{R} represents time and S is an oriented smooth $(n - 1)$ -dimensional manifold representing space. This is no real loss of generality, since any oriented hypersurface in any oriented n -dimensional manifold has a neighborhood of this form. We can thus use the results of canonical quantization to study the dynamics of BF theory on quite general spacetimes.

If we work in temporal gauge, where the time component of the connection A vanishes, we see the momentum canonically conjugate to A is

$$\frac{\partial \mathcal{L}}{\partial \dot{A}} = E.$$

This is reminiscent of the situation in electromagnetism, where the electric field is canonically conjugate to the vector potential. This is why we use the notation ‘ E ’. Originally people used the notation ‘ B ’ for this field, hence the term ‘ BF theory’, which has subsequently become ingrained. But to understand the physical meaning of the theory, it is better to call this field ‘ E ’ and think of it as analogous to the electric field. Of course, the analogy is best when $G = \text{U}(1)$.

Let $P|_S$ be the restriction of the bundle P to the ‘time-zero’ slice $\{0\} \times S$, which we identify with S . Before we take into account the constraints imposed by the field equations, the configuration space of BF theory is the space \mathcal{A} of connections on $P|_S$. The corresponding classical phase space, which we call the ‘kinematical phase space’, is the cotangent bundle $T^*\mathcal{A}$. A point in this phase space consists of a connection A on $P|_S$ and an $\text{ad}(P|_S)$ -valued $(n - 2)$ -form E on S . The symplectic structure on this phase space is given by

$$\omega((\delta A, \delta E), (\delta A', \delta E')) = \int_S \text{tr}(\delta A \wedge \delta E' - \delta A' \wedge \delta E).$$

This reflects the fact that A and E are canonically conjugate variables. However, the field equations of BF theory put constraints on the initial data A and E :

$$B = 0, \quad d_A E = 0$$

where B is the curvature of the connection $A \in \mathcal{A}$, analogous to the magnetic field in electromagnetism. To deal with these constraints, we should apply symplectic reduction to $T^*\mathcal{A}$ to obtain the physical phase space.

The constraint $d_A E = 0$, called the Gauss law, is analogous to the equation in vacuum electromagnetism saying that the divergence of the electric field vanishes. This constraint generates

the action of gauge transformations on $T^*\mathcal{A}$. Doing symplectic reduction with respect to this constraint, we thus obtain the ‘gauge-invariant phase space’ $T^*(\mathcal{A}/\mathcal{G})$, where \mathcal{G} is the group of gauge transformations of the bundle $P|_S$.

The constraint $B = 0$ is analogous to an equation requiring the magnetic field to vanish. Of course, no such equation exists in electromagnetism; this constraint is special to BF theory. It generates transformations of the form

$$A \mapsto A, \quad E \mapsto E + d_A \eta,$$

so these transformations, discussed in the previous section, really are gauge symmetries as claimed. Doing symplectic reduction with respect to this constraint, we obtain the ‘physical phase space’ $T^*(\mathcal{A}_0/\mathcal{G})$, where \mathcal{A}_0 is the space of flat connections on $P|_S$. Points in this phase space correspond to physical states of classical BF theory.

Remarks

1. The space \mathcal{A} is an infinite-dimensional vector space, and if we give it an appropriate topology, an open dense set of \mathcal{A}/\mathcal{G} becomes an infinite-dimensional smooth manifold. The simplest way to precisely define $T^*(\mathcal{A}/\mathcal{G})$ is as the cotangent bundle of this open dense set. The remaining points correspond to connections with more symmetry than the rest under gauge transformations. These are called ‘reducible’ connections. A more careful definition of the physical phase space would have to take these points into account.

2. The space $\mathcal{A}_0/\mathcal{G}$ is called the ‘moduli space of flat connections on $P|_S$ ’. We can understand it better as follows. Since the holonomy of a flat connection around a loop does not change when we apply a homotopy to the loop, a connection $A \in \mathcal{A}_0$ determines a homomorphism from the fundamental group $\pi_1(S)$ to G after we trivialize P at the basepoint $p \in S$ that we use to define the fundamental group. If we apply a gauge transformation to A , this homomorphism is conjugated by the value of this gauge transformation at p . This gives us a map from $\mathcal{A}_0/\mathcal{G}$ to $\text{hom}(\pi_1(S), G)/G$, where $\text{hom}(\pi_1(S), G)$ is the space of homomorphisms from $\pi_1(S)$ to G , and G acts on this space by conjugation. When S is connected this map is one-to-one, so we have

$$\mathcal{A}_0/\mathcal{G} \subseteq \text{hom}(\pi_1(S), G)/G.$$

The space $\text{hom}(\pi_1(S), G)/G$ is called the ‘moduli space of flat G -bundles over S ’. When $\pi_1(S)$ is finitely generated (e.g. when S is compact) this space is a real algebraic variety, and $\mathcal{A}_0/\mathcal{G}$ is a subvariety. Usually $\mathcal{A}_0/\mathcal{G}$ has singularities, but each component has an open dense set that is a smooth manifold. When we speak of $T^*(\mathcal{A}_0/\mathcal{G})$ above, we really mean the cotangent bundle of this open dense set, though again a more careful treatment would deal with the singularities.

We can describe $\mathcal{A}_0/\mathcal{G}$ much more explicitly in particular cases. For example, suppose that S is a compact oriented surface of genus n . Then the group $\pi_1(S)$ has a presentation with $2n$ generators $x_1, y_1, \dots, x_n, y_n$ satisfying the relation

$$R(x_i, y_i) := (x_1 y_1 x_1^{-1} y_1^{-1}) \cdots (x_n y_n x_n^{-1} y_n^{-1}) = 1.$$

A point in $\text{hom}(\pi_1(S), G)$ may thus be identified with a collection $g_1, h_1, \dots, g_n, h_n$ of elements of G satisfying

$$R(g_i, h_i) = 1,$$

and a point in $\text{hom}(\pi_1(S), G)/G$ is an equivalence class $[g_i, h_i]$ of such collections.

The cases $G = \text{SU}(2)$ and $G = \text{SO}(3)$ are particularly interesting for their applications to 3-dimensional Riemannian general relativity. When $G = \text{SU}(2)$, all G -bundles over a compact oriented surface S are isomorphic, and $\mathcal{A}_0/\mathcal{G} = \text{hom}(\pi_1(S), G)/G$. When $G = \text{SO}(3)$, there are two isomorphism classes of G -bundles over S , distinguished by their second Stiefel-Whitney number $w_2 \in$

\mathbb{Z}_2 . For each of these bundles, the points $[g_i, h_i]$ that lie in $\mathcal{A}_0/\mathcal{G}$ can be described as follows. Choose representatives $g_i, h_i \in \text{SO}(3)$ and choose elements \tilde{g}_i, \tilde{h}_i that map down to these representatives via the double cover $\text{SU}(2) \rightarrow \text{SO}(3)$. Then $[g_i, h_i]$ lies in $\mathcal{A}_0/\mathcal{G}$ if and only if

$$(-1)^{w_2} = R(\tilde{g}_i, \tilde{h}_i).$$

For 3-dimensional Riemannian general relativity with gauge group $\text{SO}(3)$, the relevant bundle is the frame bundle of S , which has $w_2 = 0$. For both $\text{SU}(2)$ and $\text{SO}(3)$, the space $\mathcal{A}_0/\mathcal{G}$ has dimension $6n - 6$ for $n \geq 2$. For the torus $\mathcal{A}_0/\mathcal{G}$ has dimension 2, and for the sphere it is a single point.

4 Canonical Quantization

In the previous section we described the kinematical, gauge-invariant and physical phase spaces for BF theory. All of these are cotangent bundles. Naively, quantizing any one of them should give the Hilbert space of square-integrable functions on the corresponding configuration space. We can summarize this hope with the following diagram:

$$\begin{array}{ccc}
 T^*(\mathcal{A}) & \xrightarrow{\text{quantize}} & L^2(\mathcal{A}) \\
 \downarrow \text{constrain} & & \downarrow \text{constrain} \\
 T^*(\mathcal{A}/\mathcal{G}) & \xrightarrow{\text{quantize}} & L^2(\mathcal{A}/\mathcal{G}) \\
 \downarrow \text{constrain} & & \downarrow \text{constrain} \\
 T^*(\mathcal{A}_0/\mathcal{G}) & \xrightarrow{\text{quantize}} & L^2(\mathcal{A}_0/\mathcal{G})
 \end{array}$$

Traditionally it had been difficult to realize this hope with any degree of rigor because the spaces \mathcal{A} and \mathcal{A}/\mathcal{G} are typically infinite-dimensional, making it difficult to define $L^2(\mathcal{A})$ and $L^2(\mathcal{A}/\mathcal{G})$. The great achievement of loop quantum gravity is that it gives rigorous and background-free, hence diffeomorphism-invariant, definitions of these Hilbert spaces. It does so by breaking away from the traditional Fock space formalism and taking holonomies along paths as the basic variables to be quantized. The result is a picture in which the basic excitations are not 0-dimensional particles but 1-dimensional ‘spin network edges’. As we shall see, this eventually leads us to a picture in which 1-dimensional Feynman diagrams are replaced by 2-dimensional ‘spin foams’.

In what follows we shall assume that the gauge group G is compact and connected and the manifold S representing space is real-analytic. The case where S merely smooth is considerably more complicated, but people know how to handle it. The case where G is not connected would only require some slight modifications in our formalism. However, nobody really knows how to handle the case where G is noncompact! This is why, when we apply our results to quantum gravity, we consider the quantization of the vacuum Einstein equations for Riemannian rather than Lorentzian metrics: $\text{SO}(n)$ is compact but $\text{SO}(n, 1)$ is not. The Lorentzian case is just beginning to receive the serious study that it deserves.

To define $L^2(\mathcal{A})$, we start with the algebra $\text{Fun}(\mathcal{A})$ consisting of all functions on \mathcal{A} of the form

$$\Psi(A) = f(Te^{\int_{\gamma_1} A}, \dots, Te^{\int_{\gamma_n} A}).$$

Here γ_i is a real-analytic path in S , $Te^{\int_{\gamma_i} A}$ is the holonomy of A along this path, and f is a continuous complex-valued function of finitely many such holonomies. Then we define an inner

product on $\text{Fun}(\mathcal{A})$ and complete it to obtain the Hilbert space $L^2(\mathcal{A})$. To define this inner product, we need to think about graphs embedded in space:

Definition 1. *A finite collection of real-analytic paths $\gamma_i: [0, 1] \rightarrow S$ form a graph in S if they are embedded and intersect, if at all, only at their endpoints. We then call them edges and call their endpoints vertices. Given a vertex v , we say an edge γ_i is outgoing from v if $\gamma_i(0) = v$, and we say γ_i is incoming to v if $\gamma_i(1) = v$.*

Suppose we fix a collection of paths $\gamma_1, \dots, \gamma_n$ that form a graph in S . We can think of the holonomies along these paths as elements of G . Using this idea one can show that the functions of the form

$$\Psi(A) = f(Te^{\int_{\gamma_1} A}, \dots, Te^{\int_{\gamma_n} A})$$

for these particular paths γ_i form a subalgebra of $\text{Fun}(\mathcal{A})$ that is isomorphic to the algebra of all continuous complex-valued functions on G^n . Given two functions in this subalgebra, we can thus define their inner product by

$$\langle \Psi, \Phi \rangle = \int_{G^n} \overline{\Psi} \Phi$$

where the integral is done using normalized Haar measure on G^n . Moreover, given any functions $\Psi, \Phi \in \text{Fun}(\mathcal{A})$ there is always some subalgebra of this form that contains them. Thus we can always define their inner product this way. Of course we have to check that this definition is independent of the choices involved, but this is not too hard. Completing the space $\text{Fun}(\mathcal{A})$ in the norm associated to this inner product, we obtain the ‘kinematical Hilbert space’ $L^2(\mathcal{A})$.

Similarly, we may define $\text{Fun}(\mathcal{A}/\mathcal{G})$ to be the space consisting of all functions in $\text{Fun}(\mathcal{A})$ that are invariant under gauge transformations, and complete it in the above norm to obtain the ‘gauge-invariant Hilbert space’ $L^2(\mathcal{A}/\mathcal{G})$. This space can be described in a very concrete way: it is spanned by ‘spin network states’.

Definition 2. *A spin network in S is a triple $\Psi = (\gamma, \rho, \iota)$ consisting of:*

1. *a graph γ in S ,*
2. *for each edge e of γ , an irreducible representation ρ_e of G ,*
3. *for each vertex v of γ , an intertwining operator*

$$\iota_v: \rho_{e_1} \otimes \dots \otimes \rho_{e_n} \rightarrow \rho_{e'_1} \otimes \dots \otimes \rho_{e'_m}$$

where e_1, \dots, e_n are the edges incoming to v and e'_1, \dots, e'_m are the edges outgoing from v .

In what follows we call an intertwining operator an intertwiner.

There is an easy way to get a function in $\text{Fun}(\mathcal{A}/\mathcal{G})$ from a spin network in S . To explain how it works, it is easiest to give an example. Suppose we have a spin network Ψ in S with three edges e_1, e_2, e_3 and two vertices v_1, v_2 as follows:

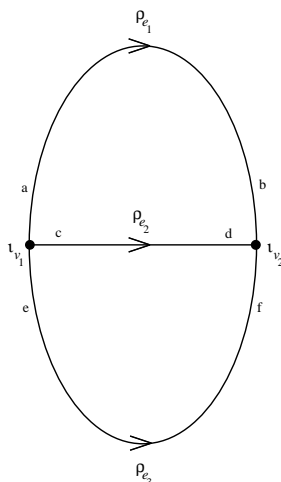

We draw arrows on the edges to indicate their orientation, and write little letters near the beginning and end of each edge. Then for any connection $A \in \mathcal{A}$ we define

$$\Psi(A) = \rho_{e_1}(Te^{J_{e_1} A})_b^a \rho_{e_2}(Te^{J_{e_2} A})_d^c \rho_{e_3}(Te^{J_{e_3} A})_f^e (\iota_{v_1})_{ace} (\iota_{v_2})^{bdf}$$

In other words, we take the holonomy along each edge of Ψ , think of it as a group element, and put it into the representation labelling that edge. Picking a basis for this representation we think of the result as a matrix with one superscript and one subscript. We use the little letter near the beginning of the edge for the superscript and the little letter near the end of the edge for the subscript. In addition, we write the intertwining operator for each vertex as a tensor. This tensor has one superscript for each edge incoming to the vertex and one subscript for each edge outgoing from the vertex. Note that this recipe ensures that each letter appears once as a superscript and once as a subscript! Finally, using the Einstein summation convention we sum over all repeated indices and get a number, which of course depends on the connection A . This is $\Psi(A)$.

Since $\Psi: \mathcal{A} \rightarrow \mathbb{C}$ is a continuous function of finitely many holonomies, it lies in $\text{Fun}(\mathcal{A})$. Using the fact that the ι_v are intertwiners, one can show that this function is gauge-invariant. We thus have $\Psi \in \text{Fun}(\mathcal{A}/\mathcal{G})$. We call Ψ a ‘spin network state’. The only hard part is to prove that spin network states span $L^2(\mathcal{A}/\mathcal{G})$. We give some references to the proof in the Notes.

The constraint $F = 0$ is a bit more troublesome. If we impose this constraint at the classical level, symplectic reduction takes us from $T^*(\mathcal{A}/\mathcal{G})$ to the physical phase space $T^*(\mathcal{A}_0/\mathcal{G})$. Heuristically, quantizing this should give the ‘physical Hilbert space’ $L^2(\mathcal{A}_0/\mathcal{G})$. However, for this to make sense, we need to choose a measure on $\mathcal{A}_0/\mathcal{G}$. This turns out to be problematic.

The space $\mathcal{A}_0/\mathcal{G}$ is called the ‘moduli space of flat connections’. As explained in Remark 3 below, it has a natural measure when S is compact and of dimension 2 or less. It also has a natural measure when S is simply connected, since then it is a single point, and we can use the Dirac delta measure at that point. In these cases the physical Hilbert space is well-defined. In most other cases, there seems to be no natural measure on the moduli space of flat connections, so we cannot unambiguously define the physical Hilbert space.

If we are willing to settle for a mere vector space instead of a Hilbert space, there is something that works quite generally. Every function in $\text{Fun}(\mathcal{A}/\mathcal{G})$ restricts to a gauge-invariant function on the space of flat connections, or in other words, a function on $\mathcal{A}_0/\mathcal{G}$. We denote the space of such functions by $\text{Fun}(\mathcal{A}_0/\mathcal{G})$. In the cases listed above where there is a natural measure on $\mathcal{A}_0/\mathcal{G}$, the space $\text{Fun}(\mathcal{A}_0/\mathcal{G})$ is dense in $L^2(\mathcal{A}_0/\mathcal{G})$. In what follows, we abuse language by calling elements of $\text{Fun}(\mathcal{A}_0/\mathcal{G})$ ‘physical states’ even when there is no best measure on $\mathcal{A}_0/\mathcal{G}$. Of course, a space of physical states without an inner product is of limited use. Nonetheless the mathematics turns out to be very important for other things, so we proceed to study this space anyway.

We can understand $\text{Fun}(\mathcal{A}_0/\mathcal{G})$ quite explicitly using the fact that every spin network in S gives a function in this space. In fact, if we give $\text{Fun}(\mathcal{A}_0/\mathcal{G})$ a reasonable topology, like the sup norm topology, finite linear combinations of spin network states are dense in this space. Moreover, one can work out quite explicitly when two linear combinations of spin networks define the same physical state. For example, two spin networks in S differing by a homotopy define the same physical state, because the holonomy of a flat connection along a path does not change when we apply a homotopy to the path. There are also other relations, called ‘skein relations’, coming from the representation theory of the group G .

For example, suppose ρ is any irreducible representation of the group G . Then the following skein relation holds:

$$= \dim(\rho)$$

Here the left-hand side is a spin network with one edge e labelled by the representation ρ and one vertex labelled by the identity intertwiner. The edge is a contractible loop in S . The corresponding spin network state Ψ is given by

$$\Psi(A) = \text{tr}(\rho(Te^{\oint_e A})).$$

The skein relation above means that $\Psi(A) = \dim(\rho)$ when A is flat. The reason is that the holonomy of a flat connection around a contractible loop is the identity, so its trace in the representation ρ is $\dim(\rho)$. As a consequence, whenever a spin network has a piece that looks like the above picture, if we eliminate that piece and multiply the remaining spin network state by $\dim(\rho)$, we obtain the same physical state.

People usually do not bother to draw vertices that are labelled by identity intertwiners. From now on we shall follow this custom. Thus instead of the above skein relation, we write:

$$= \dim(\rho)$$

Moving on to something a bit more complicated, let us consider spin networks with trivalent vertices. Given any pair of irreducible representations ρ_1, ρ_2 of G , their tensor product can be written as a direct sum of irreducible representations. Picking one of these and calling it ρ_3 , the projection from $\rho_1 \otimes \rho_2$ to ρ_3 is an intertwiner that we can use to label a trivalent vertex. However, it is convenient to multiply this projection by a constant so as to obtain an intertwiner $\iota: \rho_1 \otimes \rho_2 \rightarrow \rho_3$ with $\text{tr}(\iota^*) = 1$. We then have the skein relation

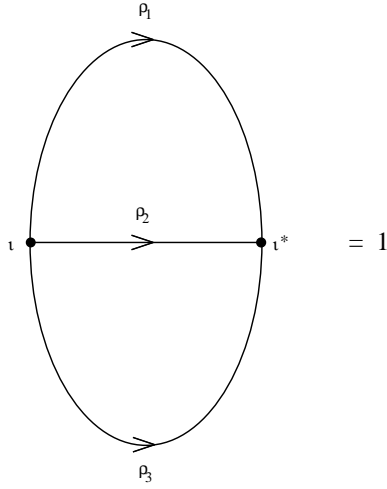

whenever this graph sits in S in a contractible way. Again, this skein relation means that the spin network on the left side of the equation defines a function $\Psi \in \text{Fun}(\mathcal{A}/\mathcal{G})$ that equals 1 on all flat connections. Whenever a spin network in S has a piece that looks like this, we can eliminate that piece without changing the physical state it defines.

Of course, if the irreducible representation ρ_3 appears more than once in the direct sum decomposition of $\rho_1 \otimes \rho_2$ there will be more than one intertwiner of the above form. We can always pick a basis of such intertwiners such that $\iota_1 \iota_2^* = 0$ for any two distinct intertwiners ι_1, ι_2 in the basis. We then have the following skein relation:

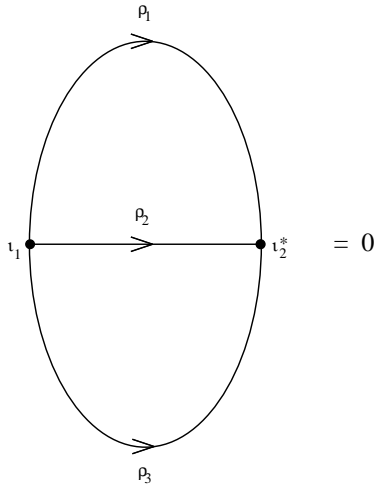

Let us pick such a basis of intertwiners for each triple of irreducible representations of G . To get enough states to span $\text{Fun}(\mathcal{A}_0/\mathcal{G})$, it suffices to use these special intertwiners — appropriately dualized when necessary — to label trivalent vertices. What about vertices of higher valence? We can break any 4-valent vertex into two trivalent ones using the following sort of skein relation:

$$\begin{array}{c} \rho_1 \\ \downarrow \\ \bullet \\ \uparrow \\ \rho_2 \end{array} \begin{array}{c} \rho_3 \\ \downarrow \\ \bullet \\ \uparrow \\ \rho_4 \end{array} = \sum_{\rho_5, \iota_1, \iota_2} c_{\rho_5, \iota_1, \iota_2} \begin{array}{c} \rho_1 \\ \downarrow \\ \bullet \\ \uparrow \\ \rho_2 \\ \downarrow \\ \rho_5 \\ \downarrow \\ \bullet \\ \uparrow \\ \rho_3 \\ \downarrow \\ \rho_4 \end{array}$$

Here the sum is over irreducibles ρ_5 and intertwiners ι_1, ι_2 in the chosen bases. The coefficient depend on the details of the intertwiners in question. Both sides of this relation are to be interpreted as part of a larger spin network. The rest of the spin network, not shown in the figure, is arbitrary but the same for both sides. Similar skein relations hold for vertices of valence 5 or more. Using these skein relations and the tricks discussed in Remark 2 below, we can write any physical state as a linear combination of states coming from trivalent spin networks.

Philosophically, skein relations are intriguing because they can be interpreted in two different ways: either as facts about BF theory, or as facts about group representation theory. In the first interpretation, which we have emphasized here, the spin network edges represent actual curves embedded in space. In the second interpretation, they are merely an abstract notation for representations of G . The fact that both interpretations are possible shows that in some sense BF theory is nothing but a clever way to encode the representation theory of G in a quantum field theory. Ultimately, this is the real reason why BF theory is so interesting.

Remarks

1. The reason for assuming S is real-analytic is that given a finite collection of real-analytic paths γ_i in S , there is always some graph in S such that each path γ_i is a product of finitely many edges of this graph. This is not true in the smooth context: for example, two smoothly embedded paths can intersect in a Cantor set. One can generalize the construction of $L^2(\mathcal{A})$ and $L^2(\mathcal{A}/\mathcal{G})$ to the smooth context, but one needs a generalization of graphs known as ‘webs’. The smooth and real-analytic categories are related as nicely as one could hope: a paracompact smooth manifold of any dimension admits a real-analytic structure, and this structure is unique up to a smooth diffeomorphism.
2. There are various ways to modify a spin network in S without changing the state it defines:

- We can reparametrize an edge by any orientation-preserving diffeomorphism of the unit interval.
- We can reverse the orientation of an edge while simultaneously replacing the representation labelling that edge by its dual and appropriately dualizing the intertwiners labelling the endpoints of that edge.
- We can subdivide an edge into two edges labelled with the same representation by inserting a vertex labelled with the identity intertwiner.
- We can eliminate an edge labelled by the trivial representation.

In fact, two spin networks in S define the same state in $L^2(\mathcal{A}/\mathcal{G})$ if and only if they differ by a sequence of these moves and their inverses. It is usually best to treat two such spin networks as ‘the same’.

3. When S is a circle, $\mathcal{A}_0/\mathcal{G}$ is just the space of conjugacy classes of G . The normalized Haar measure on G can be pushed down to this space. We can easily extend this idea to put a measure on $\mathcal{A}_0/\mathcal{G}$ whenever S is a compact and 1-dimensional. When S is compact and 2-dimensional the space

$\mathcal{A}_0/\mathcal{G}$ is an algebraic variety described as in Remark 2 of the previous section. There is a natural symplectic structure on the smooth part of this variety, given by

$$\omega([\delta A], [\delta A']) = \int_S \text{tr}(\delta A \wedge \delta A')$$

where $\delta A, \delta' A$ are tangent vectors to \mathcal{A}_0 , i.e., $\text{ad}(P)$ -valued 1-forms. Raising ω to a suitable power we obtain a volume form, and thus a measure, on $\mathcal{A}_0/\mathcal{G}$.

4. The theory of Reidemeister torsion helps to explain why there is typically a natural measure on the moduli space of flat connections only in dimensions 2 or less. The Reidemeister torsion is a natural section of a certain bundle on the moduli space of flat connections. In dimensions 2 or less we can think of this section as a volume form, but in most other cases we cannot.

5 Observables

The true physical observables in BF theory are self-adjoint operators on the physical Hilbert space, when this space is well-defined. Nonetheless it is interesting to consider operators on the gauge-invariant Hilbert space $L^2(\mathcal{A}/\mathcal{G})$. These are relevant not only to BF theory but also other gauge theories, such as 4-dimensional Lorentzian general relativity in terms of real Ashtekar variables, where the gauge group is $SU(2)$. In what follows we shall use the term ‘observables’ to refer to operators on the gauge-invariant Hilbert space. We consider observables of two kinds: functions of A and functions of E .

Since A is analogous to the ‘position’ operator in elementary quantum mechanics while E is analogous to the ‘momentum’, we expect that functions of A act as multiplication operators while functions of E act by differentiation. As usual in quantum field theory, we need to smear these fields — i.e., integrate them over some region of space — to obtain operators instead of operator-valued distributions. Since A is like a 1-form, it is tempting to smear it by integrating it over a path. Similarly, since E is like an $(n - 2)$ -form, it is tempting to integrate it over an $(n - 2)$ -dimensional submanifold. This is essentially what we shall do. However, to obtain operators on the gauge-invariant Hilbert space $L^2(\mathcal{A}/\mathcal{G})$, we need to quantize gauge-invariant functions of A and E .

The simplest gauge-invariant function of the A field is a ‘Wilson loop’: a function of the form

$$\text{tr}(\rho(Te^{\oint_{\gamma} A}))$$

for some loop γ in S and some representation ρ of G . In the simplest case, when $G = U(1)$ and the loop γ bounds a disk, we can use Stokes’ theorem to rewrite $\oint_{\gamma} A$ as the flux of the magnetic field through this disk. In general, a Wilson loop captures gauge-invariant information about the holonomy of the A field around the loop.

A Wilson loop is just a special case of a spin network, and we can get an operator on $L^2(\mathcal{A}/\mathcal{G})$ from any other spin network in a similar way. As we have seen, any spin network in S defines a function $\Psi \in \text{Fun}(\mathcal{A}/\mathcal{G})$. Since $\text{Fun}(\mathcal{A}/\mathcal{G})$ is an algebra, multiplication by Ψ defines an operator on $\text{Fun}(\mathcal{A}/\mathcal{G})$. Since Ψ is a bounded function, this operator extends to a bounded operator on $L^2(\mathcal{A}/\mathcal{G})$. We call this operator a ‘spin network observable’. Note that since $\text{Fun}(\mathcal{A}/\mathcal{G})$ is an algebra, any product of Wilson loop observables can be written as a finite linear combination of spin network observables. Thus spin network observables give a way to measure correlations among the holonomies of A around a collection of loops.

When $G = U(1)$ it is also easy to construct gauge-invariant functions of E . We simply take any compact oriented $(n - 2)$ -dimensional submanifold Σ in S , possibly with boundary, and do the integral

$$\int_{\Sigma} E.$$

This measures the flux of the electric field through Σ . Unfortunately, this integral is not gauge-invariant when G is nonabelian, so we need to modify the construction slightly to handle the non-abelian case. Write

$$E|_{\Sigma} = e d^{n-2}x$$

for some \mathfrak{g} -valued function e on Σ and some $(n-2)$ -form $d^{n-2}x$ on Σ that is compatible with the orientation of Σ . Then

$$\int_{\Sigma} \sqrt{\langle e, e \rangle} d^{n-2}x$$

is a gauge-invariant function of E . One can check that it does not depend on how we write E as $e d^{n-2}x$. We can think of it as a precise way to define the quantity

$$\int_{\Sigma} |E|.$$

Recall that 3-dimensional BF theory with gauge group $SU(2)$ or $SO(3)$ is a formulation of Riemannian general relativity in 3 dimensions. In this case Σ is a curve, and the above quantity has a simple interpretation: it is the *length* of this curve. Similarly, in 4-dimensional BF theory with either of these gauge groups, Σ is a surface, and the above quantity can be interpreted as the *area* of this surface. The same is true for 4-dimensional Lorentzian general relativity formulated in terms of the real Ashtekar variables.

Quantizing the above function of E we obtain a self-adjoint operator $\mathcal{E}(\Sigma)$ on $L^2(\mathcal{A}/\mathcal{G})$, at least when Σ is real-analytically embedded in S . We shall not present the quantization procedure here, but only the final result. Suppose Ψ is a spin network in S . Generically, Ψ will intersect Σ transversely at finitely many points, and these points will not be vertices of Ψ :

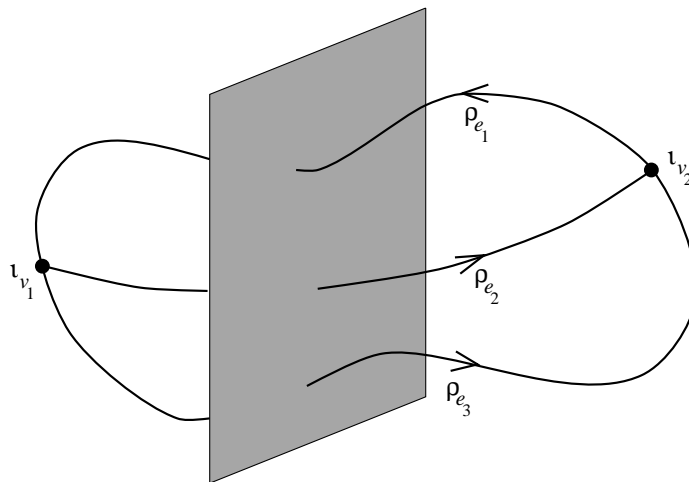

In this case we have

$$\mathcal{E}(\Sigma)\Psi = \left(\sum_i C(\rho_i)^{1/2} \right) \Psi$$

Here the sum is taken over all points p_i where an edge intersects the surface Σ , and $C(\rho_i)$ denotes the Casimir of the representation labelling that edge. Note that the same edge may intersect Σ in several points; if so, we count each point separately.

This result clarifies the physical significance of spin network edges: they represent *quantized flux lines of the E field*. In the case of 3-dimensional Riemannian quantum gravity they have a particularly simple geometrical meaning. Here the observable $\mathcal{E}(\Sigma)$ measures the length of the curve

Σ . The irreducible representations of $SU(2)$ correspond to spins $j = 0, \frac{1}{2}, 1, \dots$, and the Casimir equals $j(j+1)$ in the spin- j representation. Thus a spin network edge labelled by the spin j contributes a length $\sqrt{j(j+1)}$ to any curve it crosses transversely.

As an immediate consequence, we see that the length of a curve is not a continuously variable quantity in 3d Riemannian quantum gravity. Instead, it has a discrete spectrum of possible values! We also see here the difference between using $SU(2)$ and $SO(3)$ as our gauge group: only integer spins correspond to irreducible representations of $SO(3)$, so the spectrum of allowed lengths for curves is sparser if we use $SO(3)$. Of course, in a careful treatment we should also consider spin networks intersecting Σ nongenerically. As explained in Remark 1 below, these give the operator $\mathcal{E}(\Sigma)$ additional eigenvalues. However, our basic qualitative conclusions here remain unchanged.

Similar remarks apply to 4-dimensional BF theory with gauge group $SU(2)$, as well as quantum gravity in the real Ashtekar formulation. Here $\mathcal{E}(\Sigma)$ measures the area of the surface Σ , area is quantized, and spin network edges give area to the surfaces they intersect! This is particularly intriguing given the Bekenstein-Hawking formula saying that the entropy of a black hole is proportional to its area. It is natural to try to explain this result by associating degrees of freedom of the event horizon to points where spin network edges intersect it. Attempts along these lines have been made, and the results look promising. Unfortunately, it is too much of a digression to describe these here, so we refer the reader to the Notes for more details.

Remarks

1. The formula for $\mathcal{E}(\Sigma)\Psi$ is slightly more complicated when the underlying graph γ of Ψ intersects Σ nongenerically. By subdividing its edges if necessary we may assume this graph has the following properties:

- If an edge of γ contains a segment lying in Σ , it lies entirely in Σ .
- Each isolated intersection point of γ and Σ is a vertex.
- Each edge of γ intersects Σ at most once.

For each vertex v of γ lying in Σ , we can divide the edges incident to v into three classes, which we call ‘upwards’, ‘downwards’, and ‘horizontal’. The ‘horizontal’ edges are those lying in Σ ; the other edges are separated into two classes according to which side of Σ they lie on; using the orientation of Σ we call these classes ‘upwards’ and ‘downwards’. Reversing orientations of edges if necessary, we may assume all the upwards and downwards edges are incoming to v while the horizontal ones are outgoing. We can then write any intertwiner labelling v as a linear combination of intertwiners of the following special form:

$$\iota_v: \rho_v^u \otimes \rho_v^d \rightarrow \rho_v^h$$

where ρ_v^u (resp. ρ_v^d, ρ_v^h) is an irreducible summand of the tensor product of all the representations labelling upwards (resp. downwards, horizontal) edges. This lets us write any spin network state with γ as its underlying graph as a finite linear combination of spin network states with intertwiners of his special form. Now suppose Ψ is a spin network state with intertwiners of this form. Then we have

$$\mathcal{E}(\Sigma)\Psi = \frac{1}{2} \left(\sum_v [2C(\rho_v^u) + 2C(\rho_v^d) - C(\rho_v^h)]^{\frac{1}{2}} \right) \Psi$$

where the sum is over all vertices at which Σ intersects γ . In the generic case $C(\rho_v^u) = C(\rho_v^d)$ and $C(\rho_v^h) = 0$, so this formula reduces to the previous one.

2. When $G = U(1)$ we can also quantize the observable $\int_{\Sigma} E$ when Σ is real-analytically embedded in S , obtaining an operator that measures the flux of the electric field through Σ . For any irreducible representation ρ of $U(1)$ there is an integer $Q(\rho)$ such that

$$\rho(e^{i\theta}) = e^{iQ(\rho)\theta},$$

and using the notation of the previous remark this operator is given by

$$\left(\int_{\Sigma} \hat{E}\right)\Psi = \frac{1}{2}\left(\sum_v Q(\rho_v^u) - Q(\rho_v^d)\right)\Psi.$$

3. As noted, the true physical observables in BF theory are self-adjoint operators on the physical Hilbert space $L^2(\mathcal{A}_0/\mathcal{G})$. Examples include spin network observables: any spin network Ψ in S defines a bounded function on $\mathcal{A}_0/\mathcal{G}$, and multiplication by this function defines a bounded operator on the physical Hilbert space. Unlike the spin network observables on the gauge-invariant Hilbert space, these operators remain unchanged when we apply any homotopy to the underlying graph of the spin network, and they satisfy skein relations.

In the case of 3d BF theory with gauge group $SU(2)$ or $SO(3)$, a maximal commuting algebra of operators on $L^2(\mathcal{A}_0/\mathcal{G})$ is generated by Wilson loops corresponding to any set of generators of the fundamental group $\pi_1(S)$. For example, we can use the generators described in Remark 2 of Section 3. It suffices to use Wilson loops labelled by the fundamental representation of the gauge group.

6 Canonical Quantization via Triangulations

Starting from classical BF theory, canonical quantization has led us to a picture in which states are described using spin networks embedded in the manifold representing space. But our discussion of skein relations has shown that spin networks may also be regarded as abstract diagrams arising naturally from the representation theory of the gauge group G . This is very appealing to those who cherish the hope that someday quantum gravity will replace the differential-geometric conception of spacetime by something more algebraic or combinatorial in nature. If something like this is true, spin networks may ultimately be seen as more important than the manifold containing them! To study this possibility, we may isolate the following ‘abstract’ notion of spin network:

Definition 3. A spin network is a triple $\Psi = (\gamma, \rho, \iota)$ consisting of:

1. a graph γ : i.e., a finite set \mathcal{E} of edges, a finite set \mathcal{V} of vertices, and source and target maps $s, t: \mathcal{E} \rightarrow \mathcal{V}$ assigning to each edge its two endpoints,
2. for each edge e of γ , an irreducible representation ρ_e of G ,
3. for each vertex v of γ , an intertwiner

$$\iota_v: \rho_{e_1} \otimes \cdots \otimes \rho_{e_n} \rightarrow \rho_{e'_1} \otimes \cdots \otimes \rho_{e'_m}$$

where e_1, \dots, e_n are the edges incoming to v and e'_1, \dots, e'_m are the edges outgoing from v .

Here we say an edge is incoming to v if its target is v , and outgoing from v if its source is v .

People have already begun formulating physical theories in which such abstract spin networks, not embedded in any manifold, describe the geometry of space. However it is still a bit difficult to relate such theories to more traditional physics. Thus it is useful to consider a kind of halfway house: namely, spin networks in the dual 1-skeleton of a triangulated manifold. While purely combinatorial, these objects still have a clear link to field theory as formulated on a pre-existing manifold.

In this case of BF theory this halfway house works as follows. As before, let us start with an $(n-1)$ -dimensional real-analytic manifold S representing space. Given any triangulation of S we can choose a graph in S called the ‘dual 1-skeleton’, having one vertex at the center of each $(n-1)$ -simplex and one edge intersecting each $(n-2)$ -simplex. Using homotopies and skein relations, we can express any state in $\text{Fun}(\mathcal{A}_0/\mathcal{G})$ as a linear combination of states coming from spin networks whose underlying graph is this dual 1-skeleton. So at least for BF theory, there is no loss in working with spin networks of this special form.

It turns out that the working with a triangulation this way sheds new light on the observables discussed in the previous section. Moreover, the dynamics of BF theory is easiest to describe using triangulations. Thus it pays to formalize the setup a bit more. To do so, we borrow some ideas from lattice gauge theory.

Given a graph γ , define a ‘connection’ on γ to be an assignment of an element of G to each edge of γ , and denote the space of such connections by \mathcal{A}_γ . As in lattice gauge theory, these group elements represent the holonomies along the edges of the graph. Similarly, define a ‘gauge transformation’ on γ to be an assignment of a group element to each vertex, and denote the group of gauge transformations by \mathcal{G}_γ . This group acts on \mathcal{A}_γ in a natural way that mimics the usual action of gauge transformations on holonomies. Since \mathcal{A}_γ is just a product of copies of G , we can use normalized Haar measure on G to put a measure on \mathcal{A}_γ , and this in turn pushes down to a measure on the quotient space $\mathcal{A}_\gamma/\mathcal{G}_\gamma$. Using these we can define Hilbert spaces $L^2(\mathcal{A}_\gamma)$ and $L^2(\mathcal{A}_\gamma/\mathcal{G}_\gamma)$.

In Section 4 we saw how to extract a gauge-invariant function on the space of connections from any spin network embedded in space. The same trick works in the present context: any spin network Ψ with γ as its underlying graph defines a function $\Psi \in L^2(\mathcal{A}_\gamma/\mathcal{G}_\gamma)$. For example, if Ψ is this spin network:

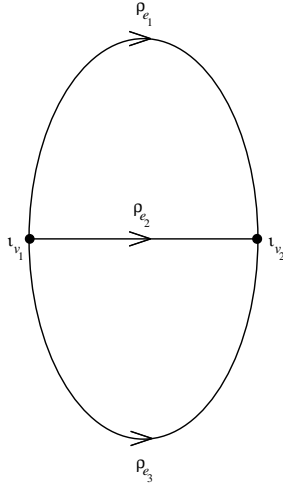

and the connection A assigns the group elements g_1, g_2, g_3 to the three edges of Ψ , we have

$$\Psi(A) = \rho_{e_1}(g_1)_a^b \rho_{e_2}(g_2)_d^c \rho_{e_3}(g_3)_f^e (\iota_{v_1})_{ac}^f (\iota_{v_2})_{db}^e.$$

We again call such functions ‘spin network states’. Not only do these span $L^2(\mathcal{A}_\gamma/\mathcal{G}_\gamma)$, it is easy to choose an orthonormal basis of spin network states. Let $\text{Irrep}(G)$ be a complete set of irreducible unitary representations of G . To obtain spin networks $\Psi = (\gamma, \rho, \iota)$ giving an orthonormal basis of $L^2(\mathcal{A}_\gamma/\mathcal{G}_\gamma)$, let ρ range over all labellings of the edges of γ by representations in $\text{Irrep}(G)$, and for each ρ and each vertex v , let the intertwiners ι_v range over an orthonormal basis of the space of intertwiners

$$\iota: \rho_{e_1} \otimes \cdots \otimes \rho_{e_n} \rightarrow \rho_{e'_1} \otimes \cdots \otimes \rho_{e'_m}$$

where the e_i are incoming to v and the e'_i are outgoing from v .

How do these purely combinatorial constructions relate to our previous setup where space is described by a real-analytic manifold S equipped with a principal G -bundle? Quite simply: whenever γ is a graph in S , trivializing the bundle at the vertices of this graph gives a map from \mathcal{A} onto \mathcal{A}_γ , and also a homomorphism from \mathcal{G} onto \mathcal{G}_γ . Thus we have inclusions

$$L^2(\mathcal{A}_\gamma) \hookrightarrow L^2(\mathcal{A})$$

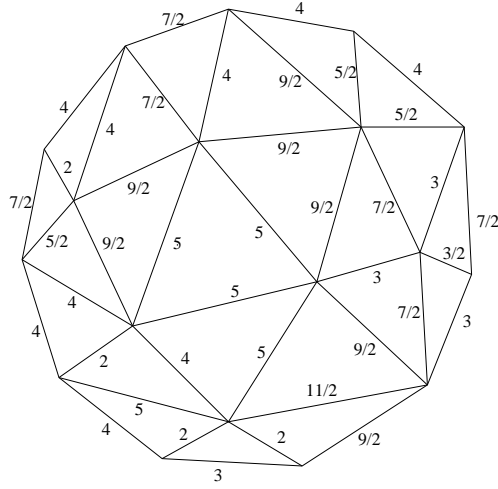

By the results of the previous section, these spins specify the *lengths* of the edges, with spin j corresponding to length $\sqrt{j(j+1)}$. Note that for there to be an intertwiner $\iota: j_1 \otimes j_2 \rightarrow j_3$, the spins j_1, j_2, j_3 labelling the three edges of a given triangle must satisfy two constraints. First, the triangle inequality must hold:

$$|j_1 - j_2| \leq j_3 \leq j_1 + j_2.$$

This has an obvious geometrical interpretation. Second, the spins must sum to an integer. This rather peculiar constraint would hold automatically if we had used the gauge group $\text{SO}(3)$ instead of $\text{SU}(2)$. If we consider all labellings satisfying these constraints, we obtain spin network states forming a basis of $L^2(\mathcal{A}_\gamma/\mathcal{G}_\gamma)$.

The situation is similar but a bit more complicated for 4-dimensional BF theory with gauge group $\text{SU}(2)$. Let S be a triangulated 3-dimensional manifold and let γ be its dual 1-skeleton. Now γ is a 4-valent graph with one vertex in the center of each tetrahedron and one edge intersecting each triangle. To specify a spin network state in $L^2(\mathcal{A}_\gamma/\mathcal{G}_\gamma)$, we need to label each edge of γ with a spin and each vertex with an intertwiner:

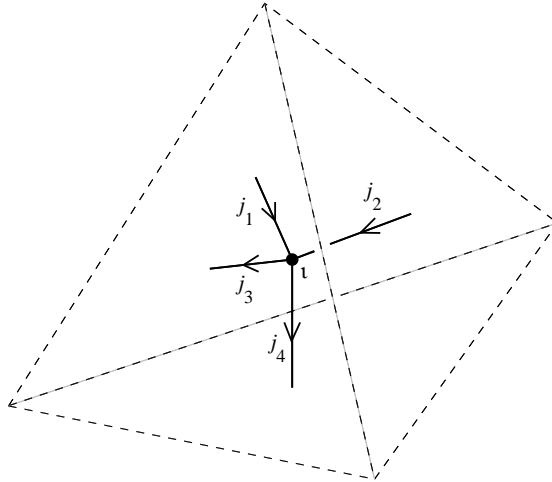

For each vertex there is a basis of intertwiners $\iota: j_1 \otimes j_2 \rightarrow j_3 \otimes j_4$ as described at the end of Section 4. We can draw such an intertwiner by formally ‘splitting’ the vertex into two trivalent ones and labelling the new edge with a spin j_5 :

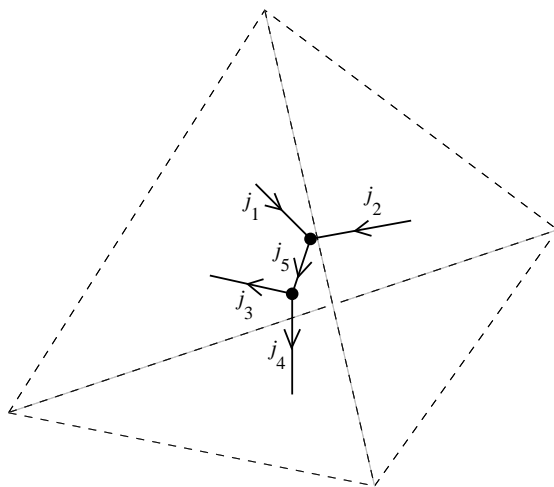

In the triangulation picture, this splitting corresponds to chopping the tetrahedron in half along a parallelogram:

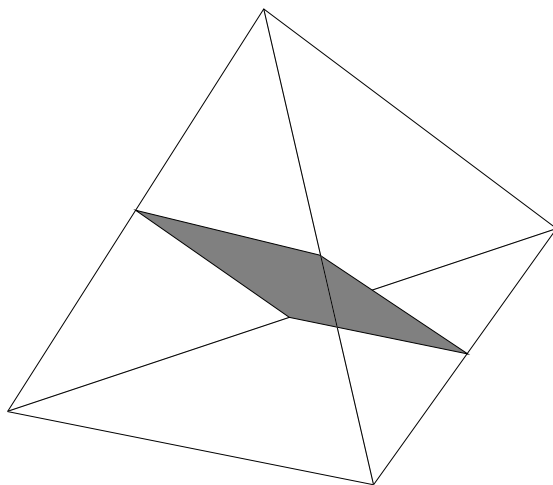

We can thus describe a spin network state in $L^2(\mathcal{A}_\gamma/\mathcal{G}_\gamma)$ by chopping each tetrahedron in half and labelling all the resulting parallelograms, along with all the triangles, by spins. These spins specify the *areas* of the parallelograms and triangles.

It may seem odd that in this picture the geometry of each tetrahedron is described by 5 spins, since classically it takes 6 numbers to specify the geometry of a tetrahedron. In fact, this is a consequence of the uncertainty principle. The area operators for surfaces do not commute when the surfaces intersect. There are three ways to chop a tetrahedron in half using a parallelogram, but we cannot simultaneously diagonalize the areas of these parallelograms, since they intersect. We can describe a basis of states for the quantum tetrahedron using 5 numbers: the areas of its 4 faces and any *one* of these parallelograms. Different ways of chopping tetrahedron in half gives us different bases of this sort, and the matrix relating these bases goes by the name of the ‘6j symbols’:

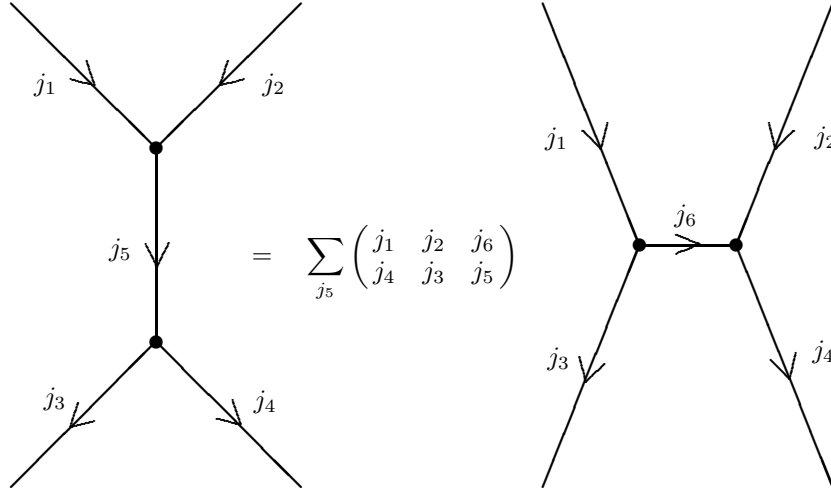

Remarks

1. For a deeper understanding of BF theory with gauge group $SU(2)$, it is helpful to start with a classical phase space describing tetrahedron geometries and apply geometric quantization to obtain a Hilbert space of quantum states. We can describe a tetrahedron in \mathbb{R}^3 by specifying vectors E_1, \dots, E_4 normal to its faces, with lengths equal to the faces' areas. We can think of these vectors as elements of $\mathfrak{so}(3)^*$, which has a Poisson structure familiar from the quantum mechanics of angular momentum:

$$\{J^a, J^b\} = \epsilon^{abc} J^c.$$

The space of 4-tuples (E_1, \dots, E_4) thus becomes a Poisson manifold. However, a 4-tuple coming from a tetrahedron must satisfy the constraint $E_1 + \dots + E_4 = 0$. This constraint is the discrete analogue of the Gauss law $d_A E = 0$. In particular, it generates rotations, so if we take $(\mathfrak{so}(3)^*)^4$ and do Poisson reduction with respect to this constraint, we obtain a phase space whose points correspond to tetrahedron geometries modulo rotations. If we geometrically quantize this phase space, we obtain the 'Hilbert space of the quantum tetrahedron'.

We can describe this Hilbert space quite explicitly as follows. If we geometrically quantize $\mathfrak{so}(3)^*$, we obtain the direct sum of all the irreducible representations of $SU(2)$:

$$\mathcal{H} \cong \bigoplus_{j=0, \frac{1}{2}, 1, \dots} j.$$

Since this Hilbert space is a representation of $SU(2)$, it has operators \hat{J}^a on it satisfying the usual angular momentum commutation relations:

$$[\hat{J}^a, \hat{J}^b] = i\epsilon^{abc} \hat{J}^c.$$

We can think of \mathcal{H} as the 'Hilbert space of a quantum vector' and the operators \hat{J}^a as measuring the components of this vector. If we geometrically quantize $(\mathfrak{so}(3)^*)^{\otimes 4}$, we obtain $\mathcal{H}^{\otimes 4}$, which is the Hilbert space for 4 quantum vectors. There are operators on this Hilbert space corresponding to the components of these vectors:

$$\begin{aligned} \hat{E}_1^a &= \hat{J}^a \otimes 1 \otimes 1 \otimes 1 \\ \hat{E}_2^a &= 1 \otimes \hat{J}^a \otimes 1 \otimes 1 \\ \hat{E}_3^a &= 1 \otimes 1 \otimes \hat{J}^a \otimes 1 \\ \hat{E}_4^a &= 1 \otimes 1 \otimes 1 \otimes \hat{J}^a. \end{aligned}$$

One can show that the Hilbert space of the quantum tetrahedron is isomorphic to

$$\mathcal{T} = \{\psi \in \mathcal{H}^{\otimes 4}: (\hat{E}_1 + \hat{E}_2 + \hat{E}_3 + \hat{E}_4)\psi = 0\}.$$

On the Hilbert space of the quantum tetrahedron there are operators

$$\hat{A}_i = (\hat{E}_i \cdot \hat{E}_i)^{\frac{1}{2}}$$

corresponding to the areas of the 4 faces of the tetrahedron, and also operators

$$\hat{A}_{ij} = ((\hat{E}_i + \hat{E}_j) \cdot (\hat{E}_i + \hat{E}_j))^{\frac{1}{2}}$$

corresponding to the areas of the parallelograms. Since $\hat{A}_{ij} = \hat{A}_{kl}$ whenever $(ijkl)$ is some permutation of the numbers (1234) , there are really just 3 different parallelogram area operators. The face area operators commute with each other and with the parallelogram area operators, but the parallelogram areas do not commute with each other. There is a basis of \mathcal{T} consisting of states that are eigenvectors of all the face area operators together with any one of the parallelogram area operators. If for example we pick \hat{A}_{12} as our preferred parallelogram area operator, any basis vector ψ is determined by 5 spins:

$$\begin{aligned} \hat{A}_i \psi &= \sqrt{j_i(j_i + 1)} & 1 \leq i \leq 4, \\ \hat{A}_{12} \psi &= \sqrt{j_5(j_5 + 1)}. \end{aligned}$$

This basis vector corresponds to the intertwiner $\iota_j: j_1 \otimes j_2 \rightarrow j_3 \otimes j_4$ that factors through the representation j_5 .

In 4d BF theory with gauge group $SU(2)$, the Hilbert space $L^2(\mathcal{A}_\gamma/\mathcal{G}_\gamma)$ described by taking the tensor product of copies of \mathcal{T} , one for each tetrahedron in the 3-manifold S , and imposing constraints saying that when two tetrahedra share a face their face areas must agree. This gives a clearer picture of the ‘quantum geometry of space’ in this theory. For example, we can define observables corresponding to the volumes of tetrahedra. The results nicely match those of loop quantum gravity, where it has been shown that spin network vertices give volume to the regions of space in which they lie. In loop quantum gravity these results were derived not from BF theory, but from Lorentzian quantum gravity formulated in terms of the real Ashtekar variables. However, these theories differ only in their dynamics.

7 Dynamics

We now turn from the spin network description of the kinematics of BF theory to the spin foam description of its dynamics. Our experience with quantum field theory suggests that we can compute transition amplitudes in BF theory using path integrals. To keep life simple, consider the most basic example: the partition function of a closed manifold representing spacetime. Heuristically, if M is a compact oriented n -manifold we expect that

$$\begin{aligned} Z(M) &= \int \int \mathcal{D}A \mathcal{D}E e^{i \int_M \text{tr}(E \wedge F)} \\ &= \int \mathcal{D}A \delta(F), \end{aligned}$$

where formally integrating out the E field gives a Dirac delta measure on the space of flat connections on the G -bundle P over M . The final result should be the ‘volume of the space of flat connections’, but of course this is ill-defined without some choice of measure.

To try to make this calculation more precise, we can *discretize* it by choosing a triangulation for M and working, not with flat connections on P , but instead with flat connections on the dual

2-skeleton. By definition, the ‘dual 2-skeleton’ of a triangulation has one vertex in the center of each n -simplex, one edge intersecting each $(n - 1)$ -simplex, and one polygonal face intersecting each $(n - 2)$ -simplex. We call these ‘dual vertices’, ‘dual edges’, and ‘dual faces’, respectively. For example, when M is 3-dimensional, the intersection of the dual 2-skeleton with any tetrahedron looks like this:

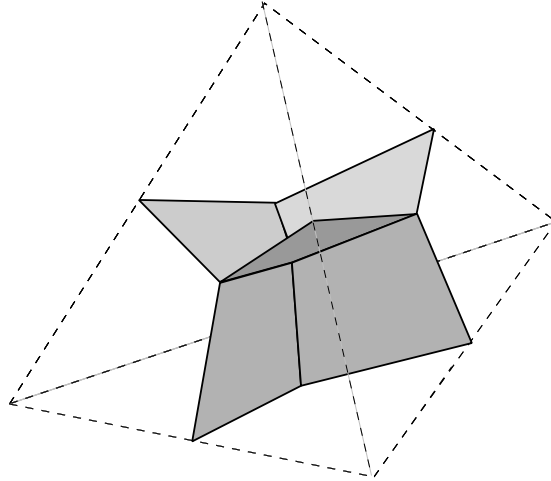

while a typical dual face looks like this:

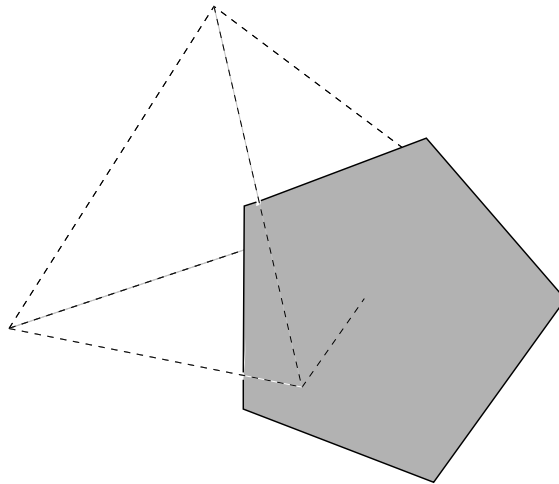

Note that the dual faces can have any number of edges. To keep track of these edges, we fix an orientation and distinguished vertex for each face f and call its edges e_{1f}, \dots, e_{Nf} , taken in cyclic order starting from the distinguished vertex. Similarly, we call its vertices v_{1f}, \dots, v_{Nf} :

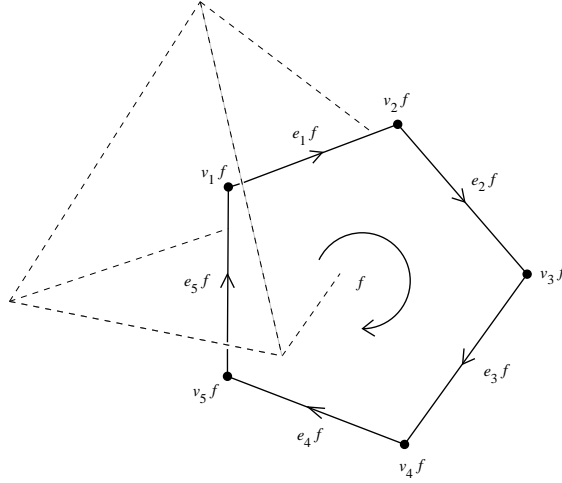

A ‘connection’ on the dual 2-skeleton is an object assigning a group element g_e to each dual edge e . For this to make sense we should fix an orientation for each dual edge. However, we can safely reverse our choice of the orientation as long as we remember to replace g_e by g_e^{-1} when we do so. We say that a connection on the dual 2-skeleton is ‘flat’ if that the holonomy around each dual face f is the identity:

$$g_{e_1 f} \cdots g_{e_N f} = 1$$

where we use the orientation of f to induce orientations of its edges.

To make sense of our earlier formula for the partition function of BF theory, we can try defining

$$Z(M) = \int \prod_{e \in \mathcal{E}} dg_e \prod_{f \in \mathcal{F}} \delta(g_{e_1 f} \cdots g_{e_N f}),$$

where \mathcal{V} is the set of dual vertices, \mathcal{E} is the set of dual edges, \mathcal{F} is the set of dual faces, and the integrals are done using normalized Haar measure on G . Of course, since we are taking a product of Dirac deltas here, we run the danger that this expression will not make sense. Nonetheless we proceed and see what happens!

We begin by using the identity

$$\delta(g) = \sum_{\rho \in \text{Irrep}(G)} \dim(\rho) \text{tr}(\rho(g)),$$

obtaining

$$Z(M) = \sum_{\rho: \mathcal{F} \rightarrow \text{Irrep}(G)} \int \prod_{e \in \mathcal{E}} dg_e \prod_{f \in \mathcal{F}} \dim(\rho_f) \text{tr}(\rho_f(g_{e_1 f} \cdots g_{e_N f})).$$

This formula is really a discretized version of

$$Z(M) = \int \int \mathcal{D}A \mathcal{D}E e^{i \int_M \text{tr}(E \wedge F)}.$$

The analogue of A is the labelling of dual edges by group elements. The analogue of F is the labelling of dual faces by holonomies around these faces. These analogies make geometrical sense because A is like a 1-form and F is like a 2-form. What is the analogue of E ? It is the labelling of dual faces by representations! Since each dual face intersects one $(n-2)$ -simplex in the triangulation, we may dually think of these representations as labelling $(n-2)$ -simplices. This is nice because E is an $(n-2)$ -form. The analogue of the pairing $\text{tr}(E \wedge F)$ is the pairing of a representation ρ_f and the holonomy around the face f to obtain the number $\dim(\rho_f) \text{tr}(\rho_f(g_{e_1 f} \cdots g_{e_N f}))$.

Next we do the integrals over group elements in the formula for $Z(M)$. The details depend on the dimension of spacetime, and it is easiest to understand them with the aid of some graphical notation. In the previous section we saw how an abstract spin network Ψ together with a connection A on the underlying graph of Ψ give a number $\Psi(A)$. Since the connection A assigns a group element g_e to each edge of Ψ , our notation for the number $\Psi(A)$ will be a picture of Ψ together with a little circle containing the group element g_e on each edge e . When the g_e is the identity we will not bother drawing it. Also, when two or more parallel edges share the same group element g we use one little circle for both edges. For example, we define:

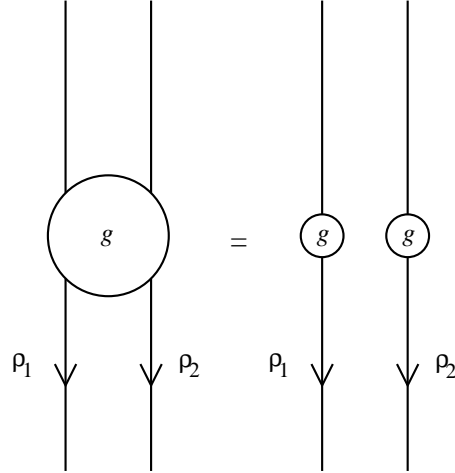

This is just the graphical analogue of the equation $(\rho_1 \otimes \rho_2)(g) = \rho_1(g) \otimes \rho_2(g)$.

Now suppose M is 2-dimensional. Since each dual edge is the edge of two dual faces, each group element appears twice in the expression

$$\prod_{f \in \mathcal{F}} \text{tr}(\rho_f(g_{e_1 f} \cdots g_{e_N f})).$$

In our graphical notation, this expression corresponds to a spin network with one loop running around each dual face:

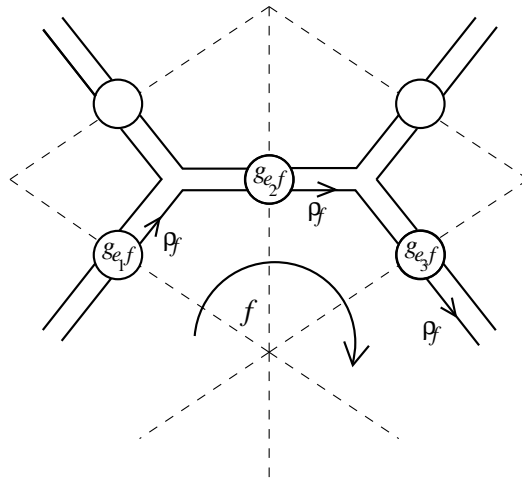

Here we have only drawn a small portion of the spin network. We can do the integral

$$\int \prod_{e \in E} dg_e \prod_{f \in F} \dim(\rho_f) \text{tr}(\rho_f(g_{e_1 f} \cdots g_{e_N f}))$$

by repeatedly using the formula

$$\int dg \rho_1(g) \otimes \rho_2(g) = \begin{cases} \frac{\iota \iota^*}{\dim(\rho_1)} & \text{if } \rho_1 \cong \rho_2^* \\ 0 & \text{otherwise} \end{cases}$$

where $\iota: \rho_1 \otimes \rho_2 \rightarrow \mathbb{C}$ is the dual pairing when ρ_1 is the dual of ρ_2 . This formula holds because both sides describe the projection from $\rho_1 \otimes \rho_2$ onto the subspace of vectors transforming in the trivial representation. Graphically, this formula can be written as the following skein relation:

The diagram illustrates a skein relation. On the left, the expression $\int dg$ is followed by a diagram of two vertical lines. The left line has a downward arrow labeled ρ_1 , and the right line has a downward arrow labeled ρ_2 . A circle labeled g is drawn around the two lines, with the lines passing through it. This is followed by an equals sign and a fraction $\frac{\delta_{\rho_1 \rho_2^*}}{\dim(\rho_1)}$. To the right of the fraction is a diagram consisting of two vertices. The top vertex is labeled ι and has two lines entering it from above, labeled ρ_1 and ρ_2 . The bottom vertex is labeled ι^* and has two lines exiting it downwards, labeled ρ_1 and ρ_2 .

Applying this to every dual edge, we see that when M is connected the integral

$$\int \prod_{e \in E} dg_e \prod_{f \in F} \dim(\rho_f) \text{tr}(\rho_f(g_{e_1 f} \cdots g_{e_N f}))$$

vanishes unless all the representations ρ_f are the same representation ρ , in which case it equals $\dim(\rho)^{|\mathcal{V}| - |\mathcal{E}| + |\mathcal{F}|}$. The quantity $|\mathcal{V}| - |\mathcal{E}| + |\mathcal{F}|$ is a topological invariant of M , namely the Euler characteristic $\chi(M)$. Summing over all labellings of dual faces, we thus obtain

$$Z(M) = \sum_{\rho \in \text{Irrep}(G)} \dim(\rho)^{\chi(M)}$$

The Euler characteristic of a compact oriented surface of genus n is $2 - 2n$. When $\chi(M) < 0$, the sum converges for any compact Lie group G , and we see that the partition function of our discretized BF theory is well-defined and *independent of the triangulation!* This is precisely what we would expect in a topological quantum field theory. For $\chi(M) \geq 0$, that is, for the sphere and torus, the partition function typically does not converge.

In the 3-dimensional case each group element shows up in 3 factors of the product over dual faces, since 3 dual faces share each dual edge:

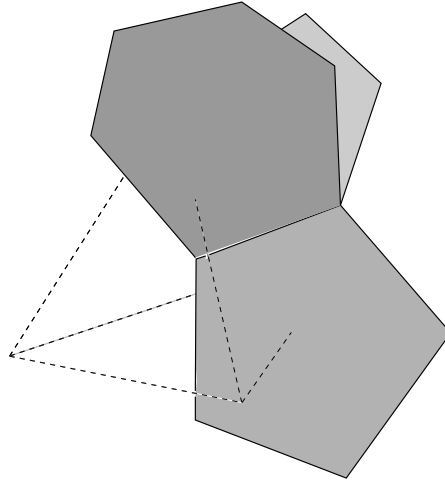

We can do the integral over each group element using the formula

$$\int dg \rho_1(g) \otimes \rho_2(g) \otimes \rho_3(g) = \sum_{\iota} \iota^*$$

where the sum ranges over a basis of intertwiners $\iota: \rho_1 \otimes \rho_2 \otimes \rho_3 \rightarrow \mathbb{C}$, normalized as in Section 4, so that $\text{tr}(\iota_1 \iota_2^*) = \delta_{\iota_1 \iota_2}$ for any two intertwiners ι_1, ι_2 in the basis. In our graphical notation this formula is written as:

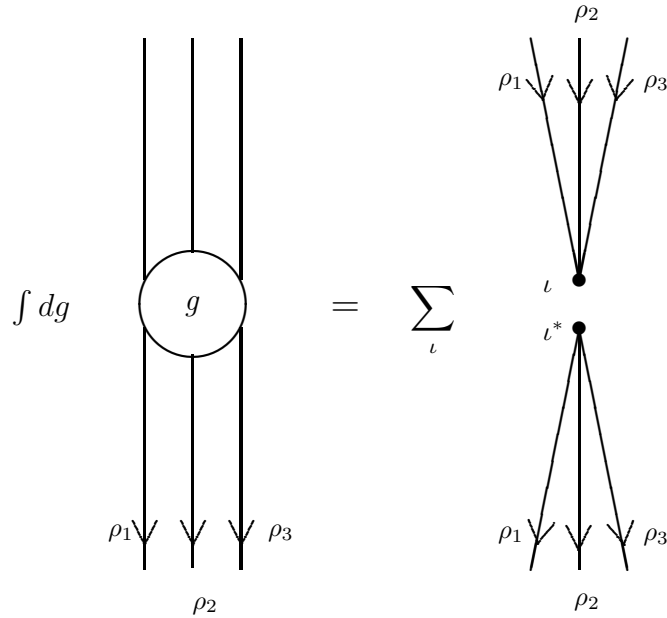

Both sides represent intertwiners from $\rho_1 \otimes \rho_2 \otimes \rho_3$ to itself. Again, the formula is true because both sides are different ways of describing the projection from $\rho_1 \otimes \rho_2 \otimes \rho_3$ onto the subspace of vectors that transform trivially under G . Using this formula once for each dual edge — or equivalently, once for each triangle in the triangulation — we can integrate out all the group elements g_e . Graphically, each time we do this, an integral over expressions like this:

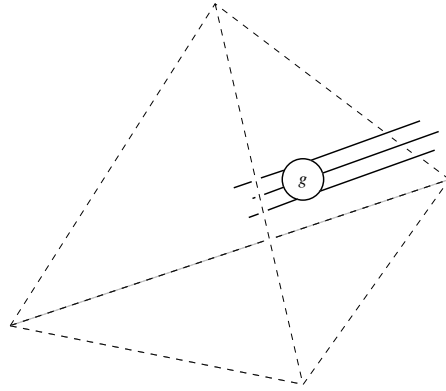

is replaced by a sum of expressions like this:

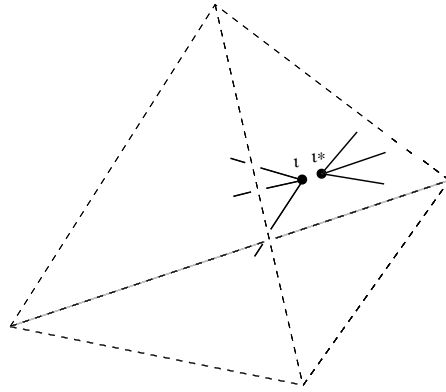

(We have not bothered to show the orientation of the edges in these pictures, since they depend on how we orient the edges of the dual 2-skeleton.) When we do this for all the triangular faces of a given tetrahedron, we obtain a little tetrahedral spin network like this:

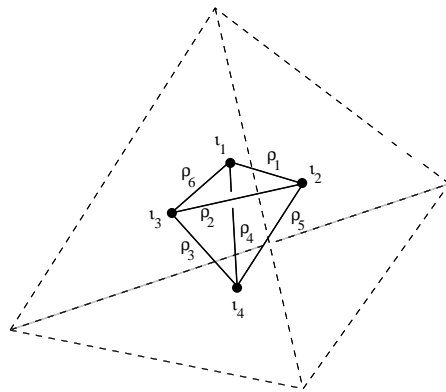

which we can evaluate in the usual way. This tetrahedral spin network is ‘dual’ to the original tetrahedron in the triangulation of M : its vertices (resp. edges, faces) correspond to faces (resp. edges, vertices) of the original tetrahedron.

We thus obtain the following formula for the partition function in 3-dimensional BF theory:

$$Z(M) = \sum_{\rho: \mathcal{F} \rightarrow \text{Irrep}(G)} \sum_{\iota} \prod_{f \in \mathcal{F}} \dim(\rho_f) \prod_{v \in \mathcal{V}}$$

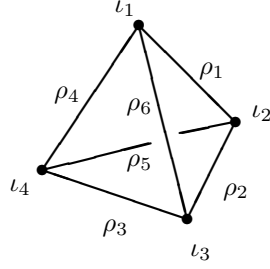

Here for each labelling $\rho: \mathcal{F} \rightarrow \text{Irrep}(G)$, we take a sum over labellings ι of dual edges by intertwiners taken from the appropriate bases. For each dual vertex v , the tetrahedral spin network shown above is built using the representations ρ_i labelling the 6 dual faces incident to v and the intertwiners ι_i labelling the 4 dual edges incident to v . When $G = \text{SU}(2)$ or $\text{SO}(3)$, the labelling by intertwiners is trivial, so the tetrahedral spin network depends only on 6 spins. Using our graphical notation, it is not hard to express the value of this spin network in terms of the $6j$ symbols described in the previous section. We leave this as an exercise for the reader.

The calculation in 4 dimensions is similar, but now 4 dual faces share each dual edge, so we need to use the formula

$$\int dg \rho_1(g) \otimes \rho_2(g) \otimes \rho_3(g) \otimes \rho_4(g) = \sum_{\iota} \iota^*$$

where now the sum ranges over a basis of intertwiners $\iota: \rho_1 \otimes \rho_2 \otimes \rho_3 \otimes \rho_4 \rightarrow \mathbb{C}$, normalized so that $\text{tr}(\iota_1 \iota_2^*) = \delta_{\iota_1 \iota_2}$ for any intertwiners ι_1, ι_2 in the basis. Again both sides describe the projection on the subspace of vectors that transform in the trivial representation, and again we can write the formula as a generalized skein relation:

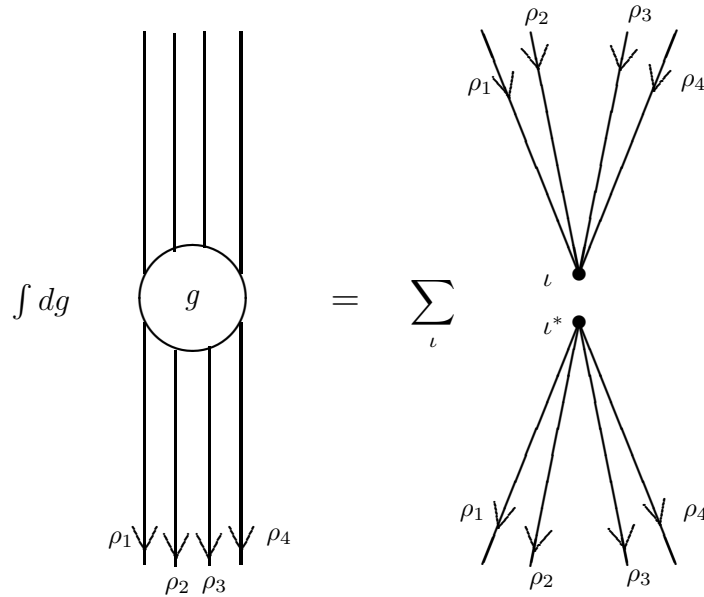

We use this formula once for each dual edge — or equivalently, once for each tetrahedron in the triangulation — to do the integral over all group elements in the partition function. Each time we do so, we introduce an intertwiner labelling the dual edge in question. We obtain

$$Z(M) = \sum_{\rho: \mathcal{F} \rightarrow \text{Irrep}(G)} \sum_v \prod_{f \in \mathcal{F}} \dim(\rho_f) \prod_{v \in \mathcal{V}}$$

The 4-simplex in this formula is dual to the 4-simplex in the original triangulation that contains $v \in \mathcal{V}$. Its edges are labelled by the representations labelling the 10 dual faces incident to v , and its vertices are labelled by the intertwiners labelling the 5 dual edges incident to v .

People often rewrite this formula for the partition function by splitting each 4-valent vertex into two trivalent vertices using the skein relations described in Section 4. The resulting equation involves a trivalent spin network with 15 edges. In the $SU(2)$ case this trivalent spin network is called a ‘15j symbol’, since it depends on 15 spins.

Having computed the BF theory partition function in 2, 3, and 4 dimensions, it should be clear that the same basic idea works in all higher dimensions, too. We always get a formula for the partition function as a sum over ways of labelling dual faces and dual edges by representations and dual edges by intertwiners. There is, however, a problem. The sum usually diverges! The only cases I know where it converges are when G is a finite group (see Remark 2 below), when M is 0- or 1-dimensional, or when M is 2-dimensional with $\chi(M) < 0$. Not surprisingly, these are a subset of the cases when the moduli space of flat connections on M has a natural measure. In other cases, it seems there are too many delta functions in the expression

$$Z(M) = \int \prod_{e \in \mathcal{E}} dg_e \prod_{f \in \mathcal{F}} \delta(g_{e_1 f} \cdots g_{e_N f})$$

to extract a meaningful answer. We discuss this problem further in Section 9.

Of course, there is more to dynamics than the partition function. For example, we also want to compute vacuum expectation values of observables, and transition amplitudes between states. It is not hard to generalize the formulas above to handle these more complicated calculations. However, at this point it helps to explicitly introduce the concept of a ‘spin foam’.

Remarks

1. Ponzano and Regge gave a formula for a discretized version of the action in 3-dimensional Riemannian general relativity. In their approach the spacetime manifold M is triangulated and each edge is assigned a length. The Ponzano-Regge action is the sum over all tetrahedra of the quantity:

$$S = \sum_e \ell_e \theta_e$$

where the sum is taken over all 6 edges, ℓ_e is the length of the edge e , and θ_e is the dihedral angle of the edge e , that is, the angle between the outward normals of the two faces incident to this edge. One can show that in a certain precise their action is an approximation to the integral of the Ricci scalar curvature. In the limit of large spins, the value of the tetrahedral spin network described above is asymptotic to

$$\sqrt{\frac{2}{3\pi V}} \cos\left(S + \frac{\pi}{4}\right).$$

where the lengths ℓ_e are related to the spins j_e labelling the tetrahedron's edges by $\ell = j + 1/2$, and V is the volume of the tetrahedron. Naively one might have hoped to get $\exp(iS)$. That one gets a cosine instead can be traced back to the fact that the lengths of the edges of a tetrahedron only determine its geometry modulo rotation *and reflection*. The phase $\frac{\pi}{4}$ shows up because calculating the asymptotics of the tetrahedral spin network involves a stationary phase approximation.

2. Ever since Section 4 we have been assuming that G is connected. The main reason for this is that it ensures the map from \mathcal{A} to \mathcal{A}_γ is onto for any graph γ in S , so that we have inclusions $L^2(\mathcal{A}_\gamma) \hookrightarrow L^2(\mathcal{A})$ and $L^2(\mathcal{A}_\gamma/\mathcal{G}_\gamma) \hookrightarrow L^2(\mathcal{A}/\mathcal{G})$. When G is not connected, these maps are usually not one-to-one.

Requiring that G be connected rules out all nontrivial finite groups. However, our formula for the BF theory partition function makes equally good sense for groups that are not connected. In fact, when G is finite, the partition function is convergent regardless of the dimension of M , and when a suitable normalization factor is included it becomes triangulation-independent. This is a special case of the ‘Dijkgraaf-Witten model.’

In this model, the path integral is not an integral over flat connections on a fixed G -bundle over M , but rather a sum over isomorphism classes of G -bundles. In fact, our discretized formula for the path integral in BF theory always implicitly includes a sum over isomorphism classes of G -bundles, because it corresponds to an integral over the whole moduli space of flat G -bundles over M , rather than the moduli space of flat connections on a fixed G -bundle. (For the relation between these spaces, see Remark 2 in Section 3.) When G is a finite group, the moduli space of flat G -bundles is discrete, with one point for each isomorphism class of G -bundle.

8 Spin Foams

We have seen that in BF theory the partition function can be computed by triangulating spacetime and considering all ways of labelling dual faces by irreducible representations and dual edges by intertwiners. For each such labelling, we compute an ‘amplitude’ as a product of amplitudes for dual faces, dual edges, and dual vertices. (By cleverly normalizing our intertwiners we were able to make the edge amplitudes equal 1, rendering them invisible, but this was really just a cheap trick.) We then take a sum over all labellings to obtain the partition function.

To formalize this idea we introduce the concept of a ‘spin foam’. A spin foam is the 2-dimensional analog of a spin network. Just as a spin network is a graph with edges labelled by irreducible representations and vertices labelled by intertwiners, a spin foam is a 2-dimensional complex with faces labelled by irreducible representations and edges labelled by intertwiners. Of course, to make this precise we need a formal definition of ‘2-dimensional complex’. Loosely, such a thing should consist of vertices, edges, and polygonal faces. There is some flexibility about the details. However, we certainly want the dual 2-skeleton of a triangulated manifold to qualify. Since topologists have already studied such things, this suggests that we take a 2-dimensional complex to be what they call a ‘2-dimensional piecewise linear cell complex’.

The precise definition of this concept is somewhat technical, so we banish it to the Appendix and only state what we need here. A 2-dimensional complex has a finite set \mathcal{V} of vertices, a finite set \mathcal{E} of edges, and a finite set \mathcal{F}_N of N -sided faces for each $N \geq 3$, with only finitely many \mathcal{F}_N being nonempty. In fact, we shall work with ‘oriented’ 2-dimensional complexes, where each edge and each face has an orientation. The orientations of the edges give maps

$$s, t: \mathcal{E} \rightarrow \mathcal{V}$$

assigning to each edge its source and target. The orientation of each face gives a cyclic ordering to its edges and vertices. Suppose we arbitrarily choose a distinguished vertex for each face $f \in \mathcal{F}_N$. Then we may number all its vertices and edges from 1 to N . If we think of these numbers as lying in \mathbb{Z}_N , we obtain maps

$$e_i: \mathcal{F}_N \rightarrow \mathcal{E}, \quad v_i: \mathcal{F}_N \rightarrow \mathcal{V} \quad i \in \mathbb{Z}_N.$$

We say f is ‘incoming’ to e when the orientation of e agrees with the orientation it inherits from f , and ‘outgoing’ when these orientations do not agree:

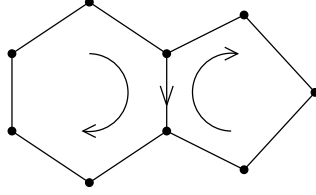

With this business taken care of, we can define spin foams. The simplest kind is a ‘closed’ spin foam. This is the sort we sum over when computing partition functions in BF theory.

Definition 4. A closed spin foam F is a triple (κ, ρ, ι) consisting of:

1. a 2-dimensional oriented complex κ ,
2. a labelling ρ of each face f of κ by an irreducible representation ρ_f of G ,
3. a labelling ι of each edge e of κ by an intertwiner

$$\iota_e: \rho_{f_1} \otimes \cdots \otimes \rho_{f_n} \rightarrow \rho_{f'_1} \otimes \cdots \otimes \rho_{f'_m}$$

where f_1, \dots, f_n are the faces incoming to e and f'_1, \dots, f'_m are the faces outgoing from e .

Note that this definition is exactly like that of a spin network, but with everything one dimension higher! This is why a generic slice of a spin foam is a spin network. We can formalize this using the notion of a spin foam $F: \Psi \rightarrow \Psi'$ going from a spin network Ψ to a spin network Ψ' :

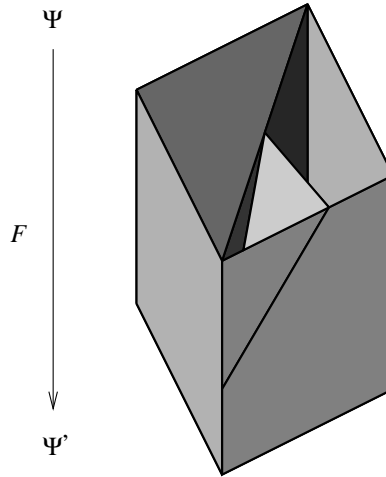

This is the sort we sum over when computing transition amplitudes in BF theory. (To reduce clutter, we have not drawn the labellings of edges and faces in this spin foam.) In this sort of spin foam, the edges that lie in Ψ and Ψ' are not labelled by intertwiners. Also, the edges ending at spin network vertices must be labelled by intertwiners that match those labelling the spin network vertices. These extra requirements are lacking for closed spin foams, because a closed spin foam is just one of the form $F: \emptyset \rightarrow \emptyset$, where \emptyset is the ‘empty spin network’: the spin network with no vertices and no edges.

To make this more precise, we need to define what it means for a graph γ to ‘border’ a 2-dimensional oriented complex κ . The reader can find this definition in Appendix A. What matters here is that if γ borders κ , then each vertex v of γ is the source or target of a unique edge \tilde{v} of κ , and each edge e of γ is the edge of a unique face \tilde{e} of κ . Using these ideas, we first define spin foams of the form $F: \emptyset \rightarrow \Psi$:

Definition 5. *Suppose that $\Psi = (\gamma, \rho, \iota)$ is a spin network. A spin foam $F: \emptyset \rightarrow \Psi$ is a triple $(\kappa, \tilde{\rho}, \tilde{\iota})$ consisting of:*

1. a 2-dimensional oriented complex κ such that γ borders κ ,
2. a labeling $\tilde{\rho}$ of each face f of κ by an irreducible representation $\tilde{\rho}_f$ of G ,
3. a labeling $\tilde{\iota}$ of each edge e of κ not lying in γ by an intertwiner

$$\tilde{\iota}_e: \rho_{f_1} \otimes \cdots \otimes \rho_{f_n} \rightarrow \rho_{f'_1} \otimes \cdots \otimes \rho_{f'_m}$$

where f_1, \dots, f_n are the faces incoming to e and f'_1, \dots, f'_m are the faces outgoing from e ,

such that the following hold:

1. For any edge e of γ , $\tilde{\rho}_{\tilde{e}} = \rho_e$ if \tilde{e} is incoming to e , while $\tilde{\rho}_{\tilde{e}} = (\rho_e)^*$ if \tilde{e} is outgoing from e .
2. For any vertex v of γ , $\tilde{\iota}_{\tilde{e}}$ equals ι_e after appropriate dualizations.

Finally, to define general spin foams, we need the notions of ‘dual’ and ‘tensor product’ for spin networks. The dual of a spin network $\Psi = (\gamma, \rho, \iota)$ is the spin network Ψ^* with the same underlying graph, but with each edge e labelled by the dual representation ρ_e^* , and each vertex v labelled by the appropriately dualized form of the intertwining operator ι_v . Given spin networks $\Psi = (\gamma, \rho, \iota)$ and $\Psi' = (\gamma', \rho', \iota')$, their tensor product $\Psi \otimes \Psi'$ is defined to be the spin network whose underlying graph is the disjoint union of γ and γ' , with edges and vertices labelled by representations and intertwiners using ρ, ρ' and ι, ι' . As usual, duality allows us to think of an input as an output:

Definition 6. *Given spin networks Ψ and Ψ' , a spin foam $F: \Psi \rightarrow \Psi'$ is defined to be a spin foam $F: \emptyset \rightarrow \Psi^* \otimes \Psi'$.*

Here is how we compute transition amplitudes in BF theory as a sum over spin foams. Suppose spacetime is given by a compact oriented cobordism $M: S \rightarrow S'$, where S and S' are compact oriented manifolds of dimension $n - 1$:

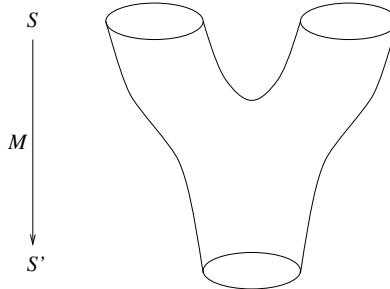

Choose a triangulation of M . This induces triangulations of S and S' with dual 1-skeletons γ and γ' , respectively. As described in Section 6, in this triangulated context we can use $L^2(\mathcal{A}_\gamma/\mathcal{G}_\gamma)$ as the gauge-invariant Hilbert space for S . This Hilbert space has a basis given by spin networks

whose underlying graph is the dual 1-skeleton of S . Similarly, we use $L^2(\mathcal{A}_{\gamma'}/\mathcal{G}_{\gamma'})$ as the space of gauge-invariant states on S' . We describe time evolution as an operator

$$Z(M): L^2(\mathcal{A}_{\gamma}/\mathcal{G}_{\gamma}) \rightarrow L^2(\mathcal{A}_{\gamma'}/\mathcal{G}_{\gamma'}).$$

To specify this operator, it suffices to describe the transition amplitudes $\langle \Psi', Z(M)\Psi \rangle$ when Ψ, Ψ' are spin network states. We write this transition amplitude as a sum over spin foams going from Ψ to Ψ' :

$$\langle \Psi', Z(M)\Psi \rangle = \sum_{F: \Psi \rightarrow \Psi'} Z(F)$$

Since we are working with a fixed triangulation of M , we restrict the sum to spin foams whose underlying complex is the dual 2-skeleton of M . The crucial thing is the formula for the amplitude $Z(F)$ of a given spin foam F .

We have already given a formula for the amplitude of a closed spin foam in the previous section: it is computed as a product of amplitudes for spin foam faces, edges and vertices. A similar formula works for any spin foam $F: \Psi \rightarrow \Psi'$, but we need to make a few adjustments. First, when we take the product over faces, edges and vertices, we exclude edges and vertices that lie in Ψ and Ψ' . Second, we use the square root of the usual edge amplitude for edges of the form \tilde{v} , where v is a vertex of Ψ or Ψ' . Third, we use the square root of the usual face amplitudes for faces of the form \tilde{e} , where e is an edge of Ψ or Ψ' . The reason for these adjustments is that we want to have

$$Z(M')Z(M) = Z(M'M)$$

when $M: S \rightarrow S'$ and $M': S' \rightarrow S''$ are composable cobordisms and $M'M: S \rightarrow S''$ is their composite:

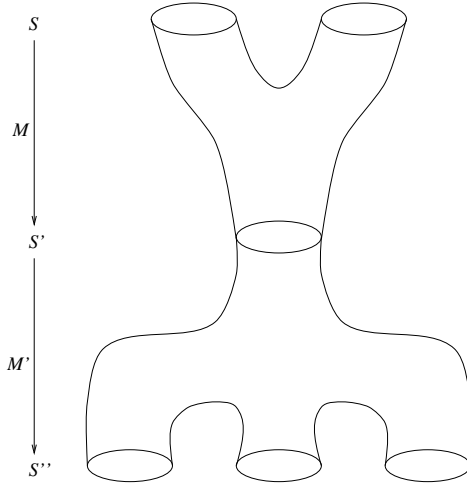

For this to hold, we want

$$Z(F')Z(F) = Z(F'F)$$

whenever $F'F: \Psi \rightarrow \Psi''$ is the spin foam formed by gluing together $F: \Psi \rightarrow \Psi'$ and $F': \Psi' \rightarrow \Psi''$ along their common border Ψ' and erasing the vertices and edges that lie in Ψ' . The adjustments described above make this equation true. Of course, the argument that $Z(F')Z(F) = Z(F'F)$ implies $Z(M')Z(M) = Z(M'M)$ is merely formal unless the sums over spin foams used to define these time evolution operators converge in a sufficiently nice way.

Let us conclude with some general remarks on the meaning of the spin foam formalism. Just as spin networks are designed to merge the concepts of *quantum state* and the *geometry of space*, spin foams are designed to merge the concepts of *quantum history* and the *geometry of spacetime*.

However, the concept of ‘quantum history’ is a bit less familiar than the concept of ‘quantum state’, so it deserves some comment. Perhaps the most familiar example of a quantum history is a Feynman diagram. A Feynman diagram determines an operator on Fock space, but there is more information in the diagram than this operator, since besides telling us transition amplitudes between states, the diagram also tells a story of ‘how the transition happened’. In other words, the internal edges and vertices of the diagram describe a ‘quantum history’ in which various virtual particles are created and annihilated.

Similarly, spin foams can be used to describe operators, but they contain extra information. If Ψ and Ψ' are spin networks with underlying graphs γ and γ' , respectively, then any spin foam $F: \Psi \rightarrow \Psi'$ determines an operator from $L^2(\mathcal{A}_\gamma/\mathcal{G}_\gamma)$ to $L^2(\mathcal{A}_{\gamma'}/\mathcal{G}_{\gamma'})$, which we also denote by F , such that

$$\langle \Phi', F\Phi \rangle = \langle \Phi', \Psi' \rangle \langle \Psi, \Phi \rangle$$

for any states Φ, Φ' . The time evolution operator $Z(M)$ is a linear combination of these operators weighted by the amplitudes $Z(F)$. But a spin foam contains more information than the operator it determines, since the operator depends only on the initial state Ψ and the final state Ψ' , not on the details of the spin foam at intermediate times. This extra information is what we call a ‘quantum history’.

How exactly does a spin foam describe the geometry of spacetime? In part, this follows from how spin networks describe the geometry of space. Consider, for example, 4d BF theory with gauge group $SU(2)$. Spin network edges give area to surfaces they puncture, while spin network vertices give volume to regions of space in which they lie. But a spin network edge is really just a slice of a spin foam face, and a spin network vertex is a slice of a spin foam edge. Thus in the spacetime context, spin foam faces give area to surfaces they intersect, while spin foam edges give 3-volume to 3-dimensional submanifolds they intersect. Continuing the pattern, one expects that spin foam vertices give 4-volume to regions of spacetime in which they lie. However, calculations have not yet been done to confirm this, in part because a thorough picture of the metric geometry of spacetime in 4 dimensions requires that one impose constraints on the E field. We discuss this a bit more in Section 10.

A similar story holds for 3d BF theory with gauge group $SU(2)$, or in other words, Riemannian quantum gravity in 3 dimensions. In this case, spin foam faces give length to curves they intersect and spin foam edges give area to surfaces they intersect. We expect that spin foam vertices give volume to regions of spacetime in which they lie, but so far the calculations remain a bit problematic.

Remarks

1. The notation $F: \Psi \rightarrow \Psi'$ is meant to suggest that there is a category with spin networks as objects and spin foams as morphisms. For this, we should be able to compose spin foams $F: \Psi \rightarrow \Psi'$ and $F': \Psi' \rightarrow \Psi''$ and obtain a spin foam $F'F: \Psi \rightarrow \Psi''$. This composition should be associative, and for each spin network Ψ we want a spin foam $1_\Psi: \Psi \rightarrow \Psi$ serving as a left and right unit for composition.

To get this to work, we actually need to take certain equivalence classes of spin foams as morphisms. In my previous paper on this subject, the equivalence relation described was actually not coarse enough to prove associativity and the left and right unit laws. The quickest way to fix this problem is to simply impose extra equivalence relations of the form $F(GH) \sim (FG)H$ and $1_\Psi F \sim F \sim 1_{\Psi'}$, to ensure that these laws hold.

2. The physical meaning of the time evolution operators

$$Z(M): L^2(\mathcal{A}_\gamma/\mathcal{G}_\gamma) \rightarrow L^2(\mathcal{A}_{\gamma'}/\mathcal{G}_{\gamma'})$$

is somewhat subtle in a background-independent theory. For example, when $M = S \times [0, 1]$ is a cylinder cobordism from S to itself, we should have $Z(M)^2 = Z(M)$. In this case $Z(M)$ should represent the projection from the gauge-invariant Hilbert space to the space of physical states.

9 q -Deformation and the Cosmological Constant

As we have seen, BF theory leads to a beautiful interplay between representation theory and geometry, in which the distinction between the two subjects gradually fades away. In the end, spin networks serve simultaneously as a tool for calculations in representation theory and as a description of the quantum geometry of space. Spin foams extend this idea to the geometry of spacetime. This is exactly the sort of thing one would hope for in a theory of quantum gravity, since quantum mechanics is largely based on representation theory, while general relativity is founded on differential geometry.

But so far, our treatment has been plagued by a serious technical problem. Mathematically, the problem is that the moduli space of flat connections only has a natural measure in dimensions 2 or less. We need this measure to define the physical Hilbert space, so canonical quantization only works when the dimension of *space* is at most 2. But we also need this measure to do path integrals in BF theory, so transition amplitudes between states are only well-defined when the dimension of *spacetime* is at most 2. Physically, the problem is the presence of infrared divergences. For example, in 3-dimensional Riemannian quantum gravity, spin networks describe the geometry of space, while spin foams describe the geometry of spacetime. When we compute a transition amplitude from one spin network to another, we sum over spin foams going between them. The transition amplitude diverges because we are summing over spin foams with faces labelled by arbitrarily high spins. These correspond to arbitrarily large spacetime geometries.

In quantum field theory, one can often learn to live with infrared divergences by restricting the set of questions one expects the theory to answer. Crudely speaking, the idea is that we can ignore the behavior of a theory on length scales greatly exceeding the characteristic length scale of the experiment whose outcome we are seeking to predict. For example, certain infrared divergences in quantum electrodynamics can be ignored if we assume our apparatus is unable to detect ‘soft photons’, i.e., those with very long wavelengths. Similarly, one can argue that the possibility of arbitrarily large spacetime geometries should not affect the outcome of an experiment that occurs within a bounded patch of spacetime. Thus it is quite possible that with a little cleverness we can learn to extract extra sensible physics from spin foam models with infrared divergences.

Luckily, when it comes to BF theory, we have another option: we can completely *eliminate* the infrared divergences by adding an extra term to the Lagrangian of our theory, built using only the E field. This trick only works when spacetime has dimension 3 or 4. In dimension 3, the modified Lagrangian is

$$\mathcal{L} = \text{tr}(E \wedge F + \frac{\Lambda}{6} E \wedge E \wedge E),$$

while in dimension 4 it is

$$\mathcal{L} = \text{tr}(E \wedge F + \frac{\Lambda}{12} E \wedge E).$$

For reasons that will become clear, the coupling constant Λ is called the ‘cosmological constant’. We only consider the case $\Lambda > 0$.

Adding this ‘cosmological term’ has a profound effect on BF theory: it changes all our calculations involving the representation theory of the gauge group into analogous calculations involving the representation theory of the corresponding quantum group. This gives us a well-defined and *finite-dimensional* physical Hilbert space, and turns the divergent sum over spin foams into a *finite* sum for the transition amplitudes between states. This process is known as ‘ q -deformation’, because the quantum group depends on a parameter q , and reduces to the original group at $q = 1$. Often people think of q as a function of \hbar , but for us it is a function of Λ , and we have $q = 1$ when $\Lambda = 0$. Thus, at least in the present context, quantum groups should really be called ‘cosmological groups’!

To understand how quantum groups are related to BF theory with a cosmological term, we need to exploit its ties to Chern-Simons theory. This is a background-free gauge theory in 3 dimensions

whose action depends only the connection A :

$$S_{CS}(A) = \frac{k}{4\pi} \int_M \text{tr}(A \wedge dA + \frac{2}{3} A \wedge A \wedge A)$$

This formula only makes sense after we have chosen a trivialization of P . Luckily, if we assume G is simply connected, every G -bundle over a 3-manifold admits a trivialization. The Chern-Simons action is not invariant under large gauge transformations. However, if we also assume that G is semisimple and ‘tr’ is defined using the Killing form, then the Chern-Simons action changes by an integer multiple of $2\pi k$ when we do a large gauge transformation. This implies that $\exp(iS_{CS}(A))$ is gauge-invariant when the quantity k , called the ‘level’, is an integer. Since this exponential of the action is what actually appears in the path integral, one might hope that Chern-Simons theory admits a reasonable quantization in this case. And indeed this is so — at least when G is compact. Unfortunately, Chern-Simons theory with noncompact gauge group is still poorly understood.

The vacuum expectation values of spin network observables are very interesting in Chern-Simons theory. Suppose Ψ is a spin network in M . We can try to compute the vacuum expectation value

$$\langle \Psi \rangle = \frac{\int \Psi(A) e^{iS_{CS}(A)} \mathcal{D}A}{\int e^{iS_{CS}(A)} \mathcal{D}A}.$$

Naively, we would expect from the diffeomorphism-invariance of the Chern-Simons action that $\langle \Psi \rangle$ remains unchanged when we apply a diffeomorphism to Ψ . In fact, this expectation value is ill-defined until we smear Ψ by equipping it with a ‘framing’. Roughly, this means that we thicken each edge of Ψ into a ribbon, put a small disc at each vertex, and demand that the ribbons merge with the discs smoothly at each vertex to form an orientable surface with boundary. The expectation values of these framed spin networks are diffeomorphism-invariant, and they satisfy skein relations which allow one to calculate them in a completely combinatorial way.

The reader will recall that in BF theory without cosmological term, spin network observables also satisfied skein relations. In that case, the skein relations encoded the representation theory of G . That is what allowed us to give a purely combinatorial, or algebraic, description of the theory. Marvelously, a similar thing is true in Chern-Simons theory! In Chern-Simons theory, however, the skein relations encode the representation theory of the quantum group $U_q\mathfrak{g}$. This is an algebraic gadget depending on a parameter q which is related to k by the formula

$$q = \exp(2\pi i/(k + h))$$

where h is the value of the Casimir in the adjoint representation of \mathfrak{g} . Alas, it would vastly expand the size of this paper to really explain what quantum groups are, and how they arise from Chern-Simons theory. To learn these things, the reader must turn to the references in the Notes. For our purposes, the most important thing is that the representation theory of $U_q\mathfrak{g}$ closely resembles that of G . In particular, each representation of G gives a representation of $U_q\mathfrak{g}$. This lets us think of spin network edges as labelled by representations of the quantum group rather than the group. However, only finitely many irreducible representations of the group give irreducible representations of the quantum group with nice algebraic properties. We shall call these ‘good’ representations. For example, when $G = \text{SU}(2)$, only the representations of spin $j = 0, \frac{1}{2}, \dots, \frac{k}{2}$ give good representations of $U_q\mathfrak{g}$. It turns out that Chern-Simons theory admits an algebraic formulation involving only the good representations of $U_q\mathfrak{g}$.

With this information in hand, let us turn to 3-dimensional BF theory with cosmological term. Starting from the action one can derive the classical field equations:

$$F + \frac{\Lambda}{2} E \wedge E = 0, \quad d_A E = 0.$$

For $G = \text{SO}(2, 1)$, these are equivalent to the vacuum Einstein equations *with a cosmological constant* when E is one-to-one. One can show this using the same sort of argument we gave in Section 2 for

the case $\Lambda = 0$. This reason this works is that $\text{tr}(E \wedge E \wedge E)$ is proportional to the volume form coming from the metric defined by E . Up to a constant factor, it is therefore just a rewriting of the usual cosmological term in the action for general relativity. Similar remarks apply to $G = \text{SO}(3)$, which gives us Riemannian general relativity with cosmological constant. We can also use the double covers of these gauge groups without affecting the classical theory.

The relation between 3d BF theory with cosmological term and Chern-Simons theory is as follows. Starting from the A and E fields in BF theory, we can define two new connections A_{\pm} as follows:

$$A_{\pm} = A \pm \sqrt{\Lambda}E.$$

Ignoring boundary terms, we then have

$$\int_M \text{tr}(E \wedge F + \frac{\Lambda}{6}E \wedge E \wedge E) = S_{CS}(A_+) - S_{CS}(A_-)$$

where

$$k = \frac{4\pi}{\sqrt{\Lambda}}.$$

In short, the action for 3d BF theory with cosmological term is a difference of two Chern-Simons actions. Thus we can quantize this BF theory whenever we can quantize Chern-Simons theory at levels k and $-k$, and we obtain a theory equivalent to two independent copies of Chern-Simons theory with these two opposite values of k . The physical Hilbert space is thus the tensor product of Hilbert spaces for two copies of Chern-Simons theory with opposite values of k , and a similar factorization holds for the time evolution operators associated to cobordisms. Actually, we can simplify this description using the fact that the Hilbert space for Chern-Simons theory at level $-k$ is naturally the dual of the Hilbert space at level k . This let us describe 3d BF theory with cosmological constant Λ completely in terms of Chern-Simons theory at level k .

Using this description together with the formulation of Chern-Simons theory in terms of quantum groups, one can derive a formula for the partition function 3d BF theory with cosmological term. This formula is almost identical to the one given in Section 7 for 3d BF theory with $\Lambda = 0$. The main difference is that now the quantum group $U_q\mathfrak{g}$ takes over the role of the group G . In other words, we now label dual faces by good representations of $U_q\mathfrak{g}$ and label dual edges by intertwiners between tensor products of these representations. A similar formula holds for transition amplitudes. In short, we have a spin foam model of a generalized sort, based on the representation theory of a quantum group instead of a group. The wonderful thing about this spin foam model is that the sums involved are finite, since there are only finitely many good representations of $U_q\mathfrak{g}$. With the infrared divergences eliminated, the partition function and transition amplitudes are truly well-defined. Even better, one can check that they are triangulation-independent!

The first example of this sort of spin foam model is due to Turaev and Viro, who considered the case $G = \text{SU}(2)$. As we have seen, this model corresponds to 3-dimensional Riemannian gravity with cosmological constant Λ . In this case only spins $j \leq \frac{k}{2}$ correspond to good representations of $U_q\mathfrak{g}$. This constraint on the spins labelling dual faces corresponds to an upper bound on the lengths of the edges of the original triangulation. We thus have, not only a minimum length due to nonzero Planck's constant, but also a maximum length due to nonzero cosmological constant! As $\Lambda \rightarrow 0$, this maximum length goes to infinity.

Now let us turn to 4-dimensional BF theory with cosmological term. Here the classical field equations are

$$F + \frac{\Lambda}{6}E = 0, \quad d_A E = 0.$$

If we canonically quantize the theory, we discover something interesting: for any compact oriented 3-manifold S representing space, the space of physical states is 1-dimensional. To see this, note first

that ‘kinematical’ states should be functions on \mathcal{A} , just as we saw in Section 4 for the case $\Lambda = 0$. Physical states are solutions of the constraints

$$B + \frac{\Lambda}{6}E = 0, \quad d_A E = 0,$$

where B is the curvature of $A \in \mathcal{A}$. As before, the constraint $d_A E = 0$ generates gauge transformations, so imposing this constraint should restrict us to gauge-invariant functions on \mathcal{A} . But the other constraint has a very different character when $\Lambda \neq 0$ than it did for $\Lambda = 0$. If we naively replace A and E by operators following the usual rules of canonical quantization, we see that states satisfying this constraint should be functions $\Psi: \mathcal{A} \rightarrow \mathbb{C}$ with

$$(B_{ij}^a + \frac{\Lambda}{6i}\epsilon_{ijk}\frac{\delta}{\delta A_{ka}})\psi = 0.$$

For $\Lambda \neq 0$ this equation has just one solution, the so-called ‘Chern-Simons state’:

$$\psi(A) = e^{-\frac{3i}{\Lambda} \int_S \text{tr}(A \wedge dA + \frac{2}{3} A \wedge A \wedge A)}.$$

By our previous remarks, if G is simple, connected and simply-connected and ‘tr’ is defined using the Killing form, the Chern-Simons state is gauge-invariant exactly when the quantity

$$k = \frac{12\pi}{\Lambda}$$

is an integer. If in addition G is compact, we can go further: we can compute expectation values of framed spin networks in the Chern-Simons state using skein relations.

How do we describe dynamics in 4-dimensional BF theory with cosmological term? Unlike the other cases we have discussed, there is not yet a plausible ‘derivation’ of a spin foam model for this theory. At present, about the best one can do is note the following facts. There is a quantum group analog of the spin foam model for 4d BF theory discussed in Section 7, and this theory has finite and triangulation-independent partition function and transition amplitudes. One can show that this theory has a 1-dimensional physical Hilbert space for any compact oriented 3-manifold S . Moreover, one can compute the expectation values of framed spin networks in this theory, and one gets the same answers as in the Chern-Simons state. Thus it seems plausible that this theory is the correct spin foam model for 4d BF theory with cosmological term. However, this subject deserves further investigation.

10 4-Dimensional Quantum Gravity

We finally turn to theory that really motivates the interest in spin foam models: quantum gravity in 4 dimensions. Various competing spin foam models have been proposed for 4-dimensional quantum gravity — mainly in the Riemannian case so far. While some of these models are very elegant, their physical meaning has not really been unravelled, and some basic problems remain unsolved. The main reason is that, unlike BF theory, general relativity in 4 dimensions has local degrees of freedom. In short, the situation is full of that curious mix of promise and threat so typical of quantum gravity. In what follows we do not attempt a full description of the state of the art, since it would soon be outdated anyway. Instead, we merely give the reader a taste of the subject. For more details, see the Notes!

We begin by describing the Palatini formulation of general relativity in 4 dimensions. Let space-time be given by a 4-dimensional oriented smooth manifold M . We choose a bundle \mathcal{T} over M that is isomorphic to the tangent bundle, but not in any canonical way. This bundle, or any of its fibers, is called the ‘internal space’. We equip it with an orientation and a metric η , either Lorentzian

or Riemannian. Let P denote the oriented orthonormal frame bundle of M . This is a principal G -bundle, where G is either $\text{SO}(3,1)$ or $\text{SO}(4)$ depending on the signature of η . The basic fields in the Palatini formalism are:

- a connection A on P ,
- a \mathcal{T} -valued 1-form e on M .

The curvature of A is an $\text{ad}(P)$ -valued 2-form which, as usual, we call F . Note however that the bundle $\text{ad}(P)$ is isomorphic to the second exterior power $\Lambda^2\mathcal{T}$. Thus we are free to switch between thinking of F as an $\text{ad}(P)$ -valued 2-form and a $\Lambda^2\mathcal{T}$ -valued 2-form. The same is true for the field $e \wedge e$.

The Lagrangian of the theory is

$$\mathcal{L} = \text{tr}(e \wedge e \wedge F).$$

Here we first take the wedge products of the differential form parts of $e \wedge e$ and F while simultaneously taking the wedge products of their ‘internal’ parts, obtaining the $\Lambda^4\mathcal{T}$ -valued 4-form $e \wedge e \wedge F$. The metric and orientation on \mathcal{T} give us an ‘internal volume form’, that is, a nowhere vanishing section of $\Lambda^4\mathcal{T}$. We can write $e \wedge e \wedge F$ as this volume form times an ordinary 4-form, which we call $\text{tr}(e \wedge e \wedge F)$.

To obtain the field equations, we set the variation of the action to zero:

$$\begin{aligned} 0 &= \delta \int_M \mathcal{L} \\ &= \int_M \text{tr}(\delta e \wedge e \wedge F + e \wedge \delta e \wedge F + e \wedge e \wedge \delta F) \\ &= \int_M \text{tr}(2\delta e \wedge e \wedge F + e \wedge e \wedge d_A \delta A) \\ &= \int_M \text{tr}(2\delta e \wedge e \wedge F - d_A(e \wedge e) \wedge \delta A). \end{aligned}$$

The field equations are thus

$$e \wedge F = 0, \quad d_A(e \wedge e) = 0.$$

These equations are really just an extension of the vacuum Einstein equation to the case of degenerate metrics. To see this, first define a metric g on M by

$$g(v, w) = \eta(ev, ew).$$

When $e: TM \rightarrow \mathcal{T}$ is one-to-one, g is nondegenerate, with the same signature as η . The equation $d_A(e \wedge e) = 0$ is equivalent to $e \wedge d_A e = 0$, and when e is one-to-one this implies $d_A e = 0$. If we use e to pull back A to a metric-preserving connection Γ on the tangent bundle, the equation $d_A e = 0$ says that Γ is torsion-free, so Γ is the Levi-Civita connection of g . This lets us rewrite $e \wedge F$ in terms of the Riemann tensor. In fact, $e \wedge F$ is proportional to the Einstein tensor, so $e \wedge F = 0$ is equivalent to the vacuum Einstein equation.

There are a number of important variants of the Palatini formulation which give the same classical physics (at least for nondegenerate metrics) but suggest different approaches to quantization. Most simply, we can pick a spin structure on M and use the double cover $\text{Spin}(3,1) \cong \text{SL}(2, \mathbb{C})$ or $\text{Spin}(4) \cong \text{SU}(2) \times \text{SU}(2)$ as gauge group. A subtler trick is to work with the ‘self-dual’ or ‘left-handed’ part of the spin connection. In the Riemannian case this amounts to using only one of the $\text{SU}(2)$ factors of $\text{Spin}(4)$ as gauge group; in the Lorentzian case we need to complexify $\text{Spin}(3,1)$ first, obtaining $\text{SL}(2, \mathbb{C}) \times \text{SL}(2, \mathbb{C})$, and then use one of these $\text{SL}(2, \mathbb{C})$ factors. It is not immediately obvious that one can formulate general relativity using only the left-handed part of the connection, but the great discovery of Plebanski and Ashtekar is that one can. A further refinement of this trick allows one to formulate the canonical quantization of Lorentzian general relativity in terms of

the e field and an $SU(2)$ connection. These so-called ‘real Ashtekar variables’ play a crucial role in most work on loop quantum gravity. Indeed, much of the spin network technology described in this paper was first developed for use with the real Ashtekar variables. However, to keep the discussion focused, we only discuss the Palatini formulation in what follows.

The Palatini formulation of general relativity brings out its similarity to BF theory. In fact, if we set $E = e \wedge e$, the Palatini Lagrangian looks exactly like the BF Lagrangian. The big difference, of course, is that not every $\text{ad}(P)$ -valued 2-form E is of the form $e \wedge e$. This restricts the allowed variations of the E field when we compute the variation of the action in general relativity. As a result, the equations of general relativity in 4 dimensions:

$$e \wedge F = 0, \quad d_A E = 0$$

are weaker than the BF theory equations:

$$F = 0, \quad d_A E = 0.$$

Another, subtler difference is that, even when E is of the form $e \wedge e$, we cannot uniquely recover e from E . In the nondegenerate case there is only a sign ambiguity: both e and $-e$ give the same E . Luckily, changing the sign of e does not affect the metric. In the degenerate case the ambiguity is greater, but we need not be unduly concerned about it, since we do not really know the ‘correct’ generalization of Einstein’s equation to degenerate metrics.

The relation between the Palatini formalism and BF theory suggests that one develop a spin foam model of quantum gravity by taking the spin foam model for BF theory and imposing extra constraints: quantum analogues of the constraint that E be of the form $e \wedge e$. However, there are some obstacles to doing this. First, BF theory is only well-understood when the gauge group is compact. If we work with a compact gauge group, we are limited to Riemannian quantum gravity. Of course, this simply means that we should work harder and try to understand BF theory with noncompact gauge group. Work on this is currently underway, but the picture is still rather murky, and a fair amount of new mathematics will need to be developed before it clears up. For this reason, we only consider the Riemannian quantum gravity in what follows.

Second, when computing transition amplitudes in BF theory, we only summed over spin foams living in the dual 2-skeleton of a fixed triangulation of spacetime. This was acceptable because we could later show triangulation-independence. But triangulation-independence is closely related to the fact that BF theory lacks local degrees of freedom: if we study BF theory on a triangulated manifold, subdividing the triangulation changes the gauge-invariant Hilbert space, but it does not increase the number of physical degrees of freedom. There is no particular reason to expect something like this to hold in 4d quantum gravity, since general relativity in 4 dimensions *does* have local degrees of freedom. So what should we do? Nobody knows! This problem requires careful thought and perhaps some really new ideas. In what follows, we simply ignore it and restrict attention to spin foams lying in the dual 2-skeleton of a fixed triangulation, for no particular good reason.

We begin by considering at the classical level the constraints that must hold for the E field to be of the form $e \wedge e$. We pick a spin structure for spacetime and take the double cover $\text{Spin}(4)$ as our gauge group. Locally we may think of the E field as taking values in the Lie algebra $\mathfrak{so}(4)$, but the splitting

$$\mathfrak{so}(4) \cong \mathfrak{so}(3) \oplus \mathfrak{so}(3)$$

lets us write E as the sum of left-handed and right-handed parts E^\pm taking values in $\mathfrak{so}(3)$. If $E = e \wedge e$, the following constraint holds for all vector fields v, w on M :

$$|E^+(v, w)| = |E^-(v, w)|$$

where $|\cdot|$ is the norm on $\mathfrak{so}(3)$ coming from the Killing form. In fact, this constraint is almost sufficient to guarantee that E is of the form $e \wedge e$. Unfortunately, in addition to solutions of the

desired form, there are also solutions of the form $-e \wedge e$, $*(e \wedge e)$, and $-*(e \wedge e)$, where $*$ is the Hodge star operator on $\Lambda^2 \mathcal{T}$.

If we momentarily ignore this problem and work with the constraint as described, we must next decide how to impose this constraint in a spin foam model. First recall some facts about 4d BF theory with gauge group $SU(2)$. In this theory, a spin foam in the dual 2-skeleton of a triangulated 4-manifold is given by labelling each dual face with a spin and each dual edge with an intertwiner. This is equivalent to labelling each triangle with a spin and each tetrahedron with an intertwiner. We can describe these intertwiners by chopping each tetrahedra in half with a parallelogram and labelling all these parallelograms with spins. Then all the data is expressed in terms of spins labelling surfaces, and each spin describes the integral of $|E|$ over the surface it labels.

Now we are trying to describe 4-dimensional Riemannian quantum gravity as a BF theory with extra constraints, but now the gauge group is $\text{Spin}(4)$. Since $\text{Spin}(4)$ is isomorphic to $SU(2) \times SU(2)$, irreducible representation of this group are of the form $j^+ \otimes j^-$ for arbitrary spins j^+, j^- . Thus, before we take the constraints into account, a spin foam with gauge group $\text{Spin}(4)$ can be given by labelling each triangle and parallelogram with a *pair* of spins. These spins describe the integrals of $|E^+|$ and $|E^-|$, respectively, over the surface in question. Thus, to impose the constraint

$$|E^+(v, w)| = |E^-(v, w)|$$

at the quantum level, it is natural to restrict ourselves to labellings for which these spins are equal. This amounts to labelling each triangle with a representation of the form $j \otimes j$ and each tetrahedron with an intertwiner of the form $\iota_j: j_1 \otimes j_2 \rightarrow j_3 \otimes j_4$ is given in our graphical notation by:

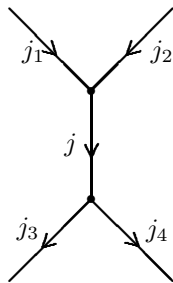

and j_1, \dots, j_4 are the spins labelling the 4 triangular faces of the tetrahedron. More generally, we can label the tetrahedron by any intertwiner of the form $\sum_j c_j (\iota_j \otimes \iota_j)$.

However, there is a subtlety. There are three ways to split a tetrahedron in half with a parallelogram P , and we really want the constraint

$$\int_P |E^+| = \int_P |E^-|$$

to hold for all three. To achieve this, we must label tetrahedra with intertwiners of the form $\sum_j c_j (\iota_j \otimes \iota_j)$ that *remain* of this form when we switch to a different splitting using the $6j$ symbols. Barrett and Crane found an intertwiner with this property:

$$\iota = \sum_j (2j + 1) (\iota_j \otimes \iota_j).$$

Later, Reisenberger proved that this was the unique solution. Thus, in this spin foam model for 4-dimensional Riemannian quantum gravity, we take the partition function to be:

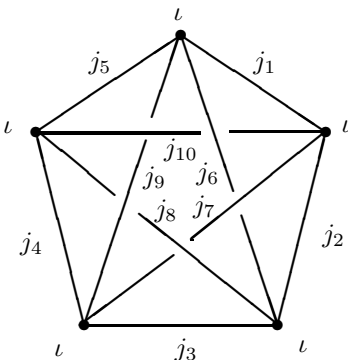
$$Z(M) = \sum_{j:\mathcal{F}\rightarrow\{0,\frac{1}{2},1,\dots\}} \prod_{f\in\mathcal{F}} (2j_f + 1) \prod_{v\in\mathcal{V}}$$

Here j_1, \dots, j_{10} are the spins labelling the dual faces meeting at the dual vertex in question, and ι is the Barrett-Crane intertwiner. One can also write down a similar formula for transition amplitudes.

The sums in these formulas probably diverge, but there is a q -deformed version where they become finite. This q -deformed version appears *not* to be triangulation-independent. We expect that it is related to general relativity with a nonzero cosmological constant. As a piece of evidence for this, note that adding a cosmological term to general relativity in 4 dimensions changes the Lagrangian to

$$\mathcal{L} = \text{tr}(e \wedge e \wedge F + \frac{\Lambda}{12} e \wedge e \wedge e \wedge e).$$

We can think of this as the BF Lagrangian with cosmological term together with a constraint saying that $E = e \wedge e$.

So, where do we stand? We have a specific proposal for a spin foam model of quantum gravity. In this theory, a quantum state of the geometry of space is described by a linear combination of spin networks. Areas and volumes take on a discrete spectrum of quantized values. Transition amplitudes between states are computed as sums over spin foams. In the q -deformed version of the theory these sums are finite and explicitly computable.

This sounds very nice, but there are severe problems as well. The theory is actually a theory of Riemannian rather than Lorentzian quantum gravity. It depends for its formulation on a fixed triangulation of spacetime. Even worse, our ability to do computations with the theory is too poor to really tell if it reduces to classical Riemannian general relativity in the large-scale limit, i.e. the limit of distances much larger than the Planck length. We thus face the following tasks:

- Develop spin foam models of Lorentzian quantum gravity.
- Determine what role, if any, triangulations or related structures should play in spin foam models with local degrees of freedom.
- Develop computational techniques for studying the large-scale limit of spin foam models.

Luckily, work on these tasks is already underway.

Remarks

1. Regge gave a formula for a discretized version of the action in 4-dimensional Riemannian general relativity. In his approach, spacetime is triangulated and each edge is assigned a length. The Regge action is the sum over all 4-simplices of:

$$S = \sum_t A_t \theta_t$$

where the sum is taken over the 10 triangular faces t , A_t is the area of the face t , and θ_t is the dihedral angle of t , that is, the angle between the outward normals of the two tetrahedra incident to

this edge. Calculations suggest that the spin foam vertex amplitudes in the Barrett-Crane theory are related to the Regge action by a formula very much like the one relating vertex amplitudes in 3d Riemannian quantum gravity to the Ponzano-Regge action (see Remark 1 of Section 7).

2. Our heuristic explanation of the Barrett-Crane model may make it seem more ad hoc than it actually is. For a more thorough treatment one should see the references in the Notes. At present our best understanding of this model comes from a 4-dimensional analogue of the theory of the quantum tetrahedron discussed in Remark 1 of Section 6. In particular, this approach allows a careful study of the ‘spurious solutions’ to the constraint $|E^+(v, w)| = |E^-(v, w)|$. It appears that at the quantum level, use of the Barrett-Crane intertwiner automatically excludes solutions of the form $E = \pm*(e \wedge e)$, but does not exclude solutions of the form $E = -e \wedge e$. The physical significance of this is still not clear.

Appendix: Piecewise linear cell complexes

Here we give the precise definition of ‘piecewise linear cell complex’. A subset $X \subseteq \mathbb{R}^n$ is said to be a ‘polyhedron’ if every point $x \in X$ has a neighborhood in X of the form

$$\{\alpha x + \beta y : \alpha, \beta \geq 0, \alpha + \beta = 1, y \in Y\}$$

where $Y \subseteq X$ is compact. A compact convex polyhedron X for which the smallest affine space containing X is of dimension k is called a ‘ k -cell’. The term ‘polyhedron’ may be somewhat misleading to the uninitiated; for example, \mathbb{R}^n is a polyhedron, and any open subset of a polyhedron is a polyhedron. Cells, on the other hand, are more special. For example, every 0-cell is a point, every 1-cell is a compact interval affinely embedded in \mathbb{R}^n , and every 2-cell is a convex compact polygon affinely embedded in \mathbb{R}^n .

The ‘vertices’ and ‘faces’ of a cell X are defined as follows. Given a point $x \in X$, let $\langle x, X \rangle$ be the union of lines L through x such that $L \cap X$ is an interval with x in its interior. If there are no such lines, we define $\langle x, X \rangle$ to be $\{x\}$ and call x a ‘vertex’ of X . One can show that $\langle x, X \rangle \cap X$ is a cell, and such a cell is called a ‘face’ of X . (In the body of this paper we use the words ‘vertex’, ‘edge’ and ‘face’ to stand for 0-cells, 1-cells and 2-cells, respectively. This should not be confused with the present use of these terms.)

One can show that any cell X has finitely many vertices v_i and that X is the convex hull of these vertices, meaning that:

$$X = \left\{ \sum \alpha_i v_i : \alpha_i \geq 0, \sum \alpha_i = 1 \right\}.$$

Similarly, any face of X is the convex hull of some subset of the vertices of X . However, not every subset of the vertices of X has a face of X as its convex hull. If the cell Y is a face of X we write $Y \leq X$. This relation is transitive, and if $Y, Y' \leq X$ we have $Y \cap Y' \leq X$.

Finally, one defines a ‘piecewise linear cell complex’, or ‘complex’ for short, to be a collection κ of cells in some \mathbb{R}^n such that:

1. If $X \in \kappa$ and $Y \leq X$ then $Y \in \kappa$.
2. If $X, Y \in \kappa$ then $X \cap Y \leq X, Y$.

In this paper we restrict our attention to complexes with finitely many cells.

A complex is ‘ k -dimensional’ if it has cells of dimension k but no higher. A complex is ‘oriented’ if every cell is equipped with an orientation, with all 0-cells being equipped with the positive orientation. The union of the cells of a complex κ is a polyhedron which we denote by $|\kappa|$.

When discussing spin foams we should really work with spin networks whose underlying graph is a 1-dimensional oriented complex. Suppose γ is a 1-dimensional oriented complex and κ is a 2-dimensional oriented complex. Note that the product $\gamma \times [0, 1]$ becomes a 2-dimensional oriented

complex in a natural way. We say γ ‘borders’ κ if there is a one-to-one affine map $c: |\gamma| \times [0, 1] \rightarrow |\kappa|$ mapping each cell of $\gamma \times [0, 1]$ onto a unique cell of κ in an orientation-preserving way, such that c maps $\gamma \times [0, 1)$ onto an open subset of $|\kappa|$. Note that in this case, c lets us regard each k -cell of γ as the face of a unique $(k + 1)$ -cell of κ .

11 Notes

While long-winded, this bibliography has no pretensions to completeness. In particular, as a mathematician by training, my selection of references inevitably has an emphasis on mathematically rigorous work. This gives a somewhat slanted view of the the subject, which is bound to make some people unhappy. I apologize for this in advance, and urge the reader to look at some of the references written by physicists to get a more balanced picture.

1 *BF* Theory: Classical Field Equations

For all aspects of *BF* theory, the following papers are invaluable:

A. S. Schwartz, The partition function of degenerate quadratic functionals and Ray-Singer invariants, *Lett. Math. Phys.* **2** (1978), 247-252.

G. Horowitz, Exactly soluble diffeomorphism-invariant theories, *Comm. Math. Phys.* **125** (1989) 417-437.

D. Birmingham, M. Blau, M. Rakowski and G. Thompson, Topological field theories, *Phys. Rep.* **209** (1991), 129-340.

M. Blau and G. Thompson, Topological gauge theories of antisymmetric tensor fields, *Ann. Phys.* **205** (1991), 130-172.

For *BF* theory on manifolds with boundary, see:

V. Husain and S. Major, Gravity and *BF* theory defined in bounded regions, *Nucl. Phys.* **B500** (1997), 381-401.

A. Momen, Edge dynamics for *BF* theories and gravity, *Phys. Lett.* **B394** (1997), 269-274.

2 Classical Phase Space

The space \mathcal{A}/\mathcal{G} and its cotangent bundle have mainly been studied in the context of Yang-Mills theory:

V. Moncrief, Reduction of the Yang-Mills equations, in *Differential Geometrical Methods in Mathematical Physics*, eds. P. Garcia, A. Pérez-Rendón, and J. Souriau, Lecture Notes in Mathematics 836, Springer-Verlag, New York, 1980, pp. 276-291.

P. K. Mitter, Geometry of the space of gauge orbits and Yang-Mills dynamical system, in *Recent developments in Gauge Theories*, eds. G. 't Hooft et al., Plenum Press, New York, 1980, pp. 265-292.

The moduli space of flat G -bundles and the moduli space of flat connections on any particular G -bundle have been extensively studied when the base manifold is a Riemann surface. See for example:

M. Narasimhan and C. Seshadri, Stable and unitary vector bundles on a compact Riemann surface, *Ann. Math.* **82** (1965) 540-567.

Later, Goldman and others studied these spaces when the base space is a compact 2-dimensional smooth manifold, without any complex structure:

W. Goldman, The symplectic nature of fundamental groups of surfaces, *Adv. Math.* **54** (1984) 200-225.

W. Goldman, Invariant functions on Lie groups and Hamiltonian flows of surface group representations, *Invent. Math.* **83** (1986) 263-302.

W. Goldman, Topological components of spaces of representations, *Invent. Math.* **93** (1988) 557-607.

A. Alekseev, A. Malkin, Symplectic structure of the moduli space of flat connections on a Riemann surface, *Commun. Math. Phys.* **169** (1995), 99-120.

3 Canonical Quantization

The idea of taking functions of holonomies as the basic observables or states in a quantized gauge theory has a long history. The earliest work dealt with Yang-Mills theory and used Wilson loops; later the idea was applied to gravity, and the importance of spin networks became clear still later. Some good books and review articles include:

R. Gambini and J. Pullin, *Loops, Knots, Gauge Theories, and Quantum Gravity*, Cambridge U. Press, Cambridge, 1996.

R. Loll, Chromodynamics and gravity as theories on loop space, preprint available as hep-th/9309056.

C. Rovelli, Loop quantum gravity, *Living Reviews in Relativity* (1998), available online at (<http://www.livingreviews.org>).

The first really systematic attempt to formulate quantum gravity in terms of Wilson loops is due to Rovelli and Smolin:

C. Rovelli and L. Smolin, Loop representation for quantum general relativity, *Nucl. Phys.* **B331** (1990), 80-152.

An important step towards a rigorous description of the space of states in loop quantum gravity was made by Ashtekar and Isham:

A. Ashtekar and C. J. Isham, Representations of the holonomy algebra of gravity and non-abelian gauge theories, *Class. Quan. Grav.* **9** (1992), 1069-1100.

This work used piecewise smooth loops, which turn out to be technically difficult to handle, so these authors were unable to construct $L^2(\mathcal{A}/\mathcal{G})$ except when G is abelian. Later, Ashtekar and Lewandowski used piecewise real-analytic loops to give a rigorous construction of $L^2(\mathcal{A}/\mathcal{G})$ for $G = \text{SU}(2)$:

A. Ashtekar and J. Lewandowski, Representation theory of analytic holonomy C^* -algebras, in *Knots and Quantum Gravity*, ed. J. Baez, Oxford, Oxford U. Press, 1994.

Then graphs with real-analytic edges were introduced, and used to construct $L^2(\mathcal{A}/\mathcal{G})$ for more general groups:

J. Baez, Diffeomorphism-invariant generalized measures on the space of connections modulo gauge transformations, in *Proceedings of the Conference on Quantum Topology*, ed. D. Yetter, World Scientific, Singapore, 1994.

Later graphs were used to construct the space $L^2(\mathcal{A})$:

J. Baez, Generalized measures in gauge theory, *Lett. Math. Phys.* **31** (1994), 213-223.

The use of graphs for integral and differential calculus on \mathcal{A} and \mathcal{A}/\mathcal{G} is systematically developed in the following papers:

A. Ashtekar and J. Lewandowski, Projective techniques and functional integration, *Jour. Math. Phys.* **36** (1995), 2170-2191.

A. Ashtekar and J. Lewandowski, Differential geometry for spaces of connections via graphs and projective limits, *Jour. Geom. Phys.* **17** (1995), 191-230.

The history of spin networks is rather complicated and I cannot do justice to it here. For a good introduction see:

L. Smolin, The future of spin networks, preprint available as gr-qc/9702030.

Briefly, spin networks were first invented by Penrose:

R. Penrose, Angular momentum: an approach to combinatorial space-time, in *Quantum Theory and Beyond*, ed. T. Bastin, Cambridge U. Press, Cambridge, 1971, pp. 151-180.

R. Penrose, Applications of negative dimensional tensors, in *Combinatorial Mathematics and its Applications*, ed. D. Welsh, Academic Press, New York, 1971, pp. 221-244.

R. Penrose, On the nature of quantum geometry, in *Magic Without Magic*, ed. J. Klauder, Freeman, San Francisco, 1972, pp. 333-354.

R. Penrose, Combinatorial quantum theory and quantized directions, in *Advances in Twistor Theory*, eds. L. Hughston and R. Ward, Pitman Advanced Publishing Program, San Francisco, 1979, pp. 301-317.

Penrose considered trivalent graphs labelled by spins. He wanted to use these as the basis for a purely combinatorial approach to spacetime. The following thesis is still invaluable for anyone interested in these ideas:

J. Moussouris, Quantum models of space-time based on recoupling theory, Ph.D. thesis, Department of Mathematics, Oxford University, 1983.

Later, as part of an attempt to understand the Jones polynomial and related knot invariants, the notion of spin network was generalized to include arbitrary graphs labelled by representations of any quantum group:

N. Reshetikhin and V. Turaev, Ribbon graphs and their invariants derived from quantum groups, *Comm. Math. Phys.* **127** (1990), 1-26.

In this more general context a framing of the graph is required, hence the term 'ribbon graph'. Spin networks were introduced into loop quantum gravity by Rovelli and Smolin:

C. Rovelli and L. Smolin, Spin networks in quantum gravity, *Phys. Rev.* **D52** (1995), 5743-5759.

The fact that spin network states span $L^2(\mathcal{A}/\mathcal{G})$ was shown in:

J. Baez, Spin networks in gauge theory, *Adv. Math.* **117** (1996), 253-272.

For an expository account of this proof and a general introduction to quantum gravity, try:

J. Baez, Spin networks in nonperturbative quantum gravity, in *The Interface of Knots and Physics*, ed. L. Kauffman, American Mathematical Society, Providence, Rhode Island, 1996.

For a rigorous approach to the canonical quantization of diffeomorphism-invariant gauge theories using spin networks, see:

A. Ashtekar, J. Lewandowski, D. Marolf, J. Mourão, and T. Thiemann, Quantization of diffeomorphism invariant theories of connections with local degrees of freedom, *Jour. Math. Phys.* **36** (1995), 6456-6493.

For the theory of $L^2(\mathcal{A})$ and $L^2(\mathcal{A}/\mathcal{G})$ in the smooth context, which involves the notion of ‘webs’, see:

J. Baez and S. Sawin, Functional integration on spaces of connections, *Jour. Funct. Anal.* **150** (1997), 1-27.

J. Baez and S. Sawin, Diffeomorphism-invariant spin network states, *Jour. Funct. Anal.* **158** (1998), 253-266.

J. Lewandowski and T. Thiemann, Diffeomorphism invariant quantum field theories of connections in terms of webs, preprint available as gr-qc/9901015.

For the canonical quantization of 3-dimensional general relativity, see:

E. Witten, 2+1 dimensional gravity as an exactly soluble system, *Nucl. Phys.* **B311** (1988), 46-78.

A. Ashtekar, V. Husain, C. Rovelli, J. Samuel and L. Smolin, 2+1 gravity as a toy model for the 3+1 theory, *Class. Quant. Grav.* **6** (1989), L185-L193.

A. Ashtekar, Lessons from (2+1)-dimensional quantum gravity, *Strings 90*, World Scientific, Singapore, 1990, pp. 71-88.

A. Ashtekar, R. Loll, New loop representations for 2+1 gravity, *Class. Quant. Grav.* **11** (1994), 2417-2434.

S. Carlip, *Quantum Gravity in 2+1 Dimensions*, Cambridge U. Press, Cambridge, 1998.

For a discussion of torsion and BF theory, see:

M. Blau and G. Thompson, A new class of topological field theories and the Ray-Singer torsion, *Phys. Lett.* **B228** (1989), 64-68.

4 Observables

The first calculation of area and volume operators in loop quantum gravity was by Rovelli and Smolin:

C. Rovelli and L. Smolin, Discreteness of area and volume in quantum gravity, *Nucl. Phys.* **B442** (1995), 593-622. Erratum, *ibid.* **B456** (1995), 753.

A rigorous construction and analysis of area and volume operators on $L^2(\mathcal{A}/\mathcal{G})$, using a somewhat different quantization scheme, was given in the following series of papers:

A. Ashtekar and J. Lewandowski, Quantum theory of geometry I: area operators, *Class. Quantum Grav.* **14** (1997), A55-A81.

A. Ashtekar and J. Lewandowski, Quantum theory of geometry II: volume operators, *Adv. Theor. Math. Phys.* **1** (1998), 388-429.

A. Ashtekar, A. Corichi and J. Zapata, Quantum theory of geometry III: non-commutativity of Riemannian structures, *Class. Quantum Grav.* **15** (1998), 2955-2972.

The area operator considered in these papers is the same as the operator $\mathcal{E}(\Sigma)$ in the special case when space is 3-dimensional and the gauge group is $SU(2)$; however, the generalization to other

dimensions and gauge groups is straightforward. For a simplified derivation of the area operator, see:

C. Rovelli and P. Upadhyaya, Loop quantum gravity and quanta of space: a primer, preprint available as gr-qc/9806079.

For attempts to compute the entropy of black holes in loop quantum gravity, see:

L. Smolin, Linking topological quantum field theory and nonperturbative quantum gravity, *Jour. Math. Phys.* **36** (1995) 6417-6455.

C. Rovelli, Loop quantum gravity and black hole physics, *Helv. Phys. Acta* **69** (1996), 582-611.

K. Krasnov, Counting surface states in loop quantum gravity, *Phys. Rev.* **D55** (1997), 3505-3513.

K. Krasnov, On quantum statistical mechanics of a Schwarzschild black hole, *Gen. Rel. Grav.* **30** (1998), 53-68.

A. Ashtekar, J. Baez, A. Corichi and K. Krasnov, Quantum geometry and black hole entropy, *Phys. Rev. Lett.* **80** (1998), 904-907.

A. Ashtekar, A. Corichi and K. Krasnov, Isolated black holes: the classical phase space, to appear.

A. Ashtekar, J. Baez, and K. Krasnov, Quantum geometry of black hole horizons, to appear.

5 Canonical Quantization via Triangulations

The relation between canonical quantum gravity on a triangulated manifold and other simplicial approaches to quantum gravity was noted by Rovelli:

C. Rovelli, The basis of the Ponzano-Regge-Turaev-Viro-Ooguri model is the loop representation basis, *Phys. Rev.* **D48** (1993), 2702-2707.

In a series of papers, Loll developed a version of loop quantum gravity on a cubical lattice:

R. Loll, Non-perturbative solutions for lattice quantum gravity, *Nucl. Phys.* **B444** (1995), 619-640.

R. Loll, The volume operator in discretized quantum gravity, *Phys. Rev. Lett.* **75** (1995) 3048-3051.

R. Loll, Spectrum of the volume operator in quantum gravity, *Nucl. Phys.* **B460** (1996) 143-154.

R. Loll, Further results on geometric operators in quantum gravity, *Class. Quantum Grav.* **14** (1997), 1725-1741.

R. Loll, Imposing $\det E > 0$ in discrete quantum gravity, *Phys. Lett.* **B399** (1997), 227-232.

For a definition of $L^2(\mathcal{A})$ and $L^2(\mathcal{A}/\mathcal{G})$ in the piecewise-linear context, see:

J. A. Zapata, A combinatorial approach to diffeomorphism invariant quantum gauge theories, *Jour. Math. Phys.* **38** (1997), 5663-5681.

J. A. Zapata, Combinatorial space from loop quantum gravity, *Gen. Rel. Grav.* **30** (1998), 1229-1245.

The study of the quantum tetrahedron was initiated by Barbieri:

A. Barbieri, Quantum tetrahedra and simplicial spin networks, *Nucl. Phys.* **B518** (1998) 714-728.

For a treatment of the quantum tetrahedron using geometric quantization, see:

J. Baez and J. Barrett, The quantum tetrahedron in 3 and 4 dimensions, preprint available as gr-qc/9903060.

6 Dynamics

The formulation of 3d Riemannian quantum gravity as a sum over labellings of the edges of a triangulated 3-manifold by spins was first given by Ponzano and Regge:

G. Ponzano and T. Regge, Semiclassical limit of Racah coefficients, in *Spectroscopic and Group Theoretical Methods in Physics*, ed. F. Bloch, North-Holland, New York, 1968.

The relation to Penrose's spin networks was noted by Hasslacher and Perry:

B. Hasslacher and M. Perry, Spin networks are simplicial quantum gravity, *Phys. Lett.* **B103** (1981), 21-24.

We can now see the Ponzano-Regge formula as a purely combinatorial formula for the partition function of 3d BF theory with gauge group $SU(2)$. Much later, Witten gave a similar formula in the 2-dimensional case:

E. Witten, On quantum gauge theories in two dimensions, *Comm. Math. Phys.* **141** (1991) 153-209.

and Ooguri gave a similar formula in the 4-dimensional case:

H. Ooguri, Topological lattice models in four dimensions, *Mod. Phys. Lett.* **A7** (1992) 2799-2810.

For the Dijkgraaf-Witten model see:

R. Dijkgraaf and E. Witten, Topological gauge theories and group cohomology, *Commun. Math. Phys.* **129** (1990) 393-429.

D. Freed and F. Quinn, Chern-Simons theory with finite gauge group, *Commun. Math. Phys.* **156** (1993), 435-472.

Ponzano and Regge's original argument relating the asymptotics of $6j$ symbols to their discretized action for 3-dimensional Riemannian general relativity turned out to be surprisingly hard to make precise. A rigorous proof was recently given by Roberts:

J. Roberts, Classical $6j$ -symbols and the tetrahedron, *Geometry and Topology* **3** (1999), 21-66.

7 Spin Foams

The idea that transition amplitudes in 4d quantum gravity should be expressed as a sum over surfaces was proposed in the following paper:

J. Baez, Strings, loops, knots and gauge fields, in *Knots and Quantum Gravity*, ed. J. Baez, Oxford U. Press, Oxford, 1994.

This idea was developed by Iwasaki and Reisenberger, who stressed the importance of summing over 2-dimensional complexes, as opposed to 2-manifolds:

J. Iwasaki, A definition of the Ponzano-Regge quantum gravity model in terms of surfaces, *Jour. Math. Phys.* **36** (1995), 6288-6298.

M. Reisenberger, Worldsheet formulations of gauge theories and gravity, preprint available as gr-qc/9412035.

Later, Reisenberger and Rovelli showed how to derive such a 'sum over surfaces' formulation from a formula for the Hamiltonian constraint in quantum gravity:

M. Reisenberger and C. Rovelli, “Sum over surfaces” form of loop quantum gravity, *Phys. Rev.* **D56** (1997), 3490-3508.

The relation between spin network evolution and triangulated spacetime manifolds was clarified by Markopoulou:

F. Markopoulou, Dual formulation of spin network evolution, preprint available as gr-qc/9704013.

The general notion of a spin foam was defined in the following paper:

J. Baez, Spin foam models, *Class. Quant. Grav.* **15** (1998) 1827-1858.

For an attempt to systematically derive spin foam models from the Lagrangians for BF theory and related theories, see:

L. Freidel and K. Krasnov, Spin foam models and the classical action principle, *Adv. Theor. Phys.* **2** (1998), 1221-1285.

For a discussion of the mathematical and philosophical underpinnings of the spin foam approach, see:

J. Baez, Higher-dimensional algebra and Planck-scale physics, to appear in *Physics Meets Philosophy at the Planck Scale*, eds. C. Callender and N. Huggett, Cambridge U. Press, preprint available as gr-qc/9902017.

For a study of volume in 3-dimensional quantum gravity, see:

L. Freidel and K. Krasnov, Discrete space-time volume for 3-dimensional BF theory and quantum gravity, *Class. Quant. Grav.* **16** (1999), 351-362.

8 q -Deformation and the Cosmological Constant

The relation between Chern-Simons theory and the Jones polynomial was first glimpsed in Witten’s seminal paper:

E. Witten, Quantum field theory and the Jones polynomial, *Comm. Math. Phys.* **121** (1989), 351-399.

The relation to quantum groups was clarified by Reshetikhin and Turaev:

N. Reshetikhin and V. Turaev, Invariants of 3-manifolds via link polynomials and quantum groups, *Invent. Math.* **103** (1991), 547-597.

By now the subject has grown to enormous proportions, and we can scarcely begin to list all the relevant references here. Instead, we merely direct the reader to the following textbooks:

M. Atiyah, *The Geometry and Physics of Knots*, Cambridge U. Press, Cambridge, 1990.

V. Chari and A. Pressley, *A Guide to Quantum Groups*, Cambridge U. Press, Cambridge, 1994.

J. Fuchs, *Affine Lie Algebra and Quantum Groups*, Cambridge U. Press, Cambridge, 1992.

C. Kassel, *Quantum Groups*, Springer-Verlag, New York, 1995.

L. Kauffman, *Knots and Physics*, World Scientific Press, Singapore, 1993.

L. Kauffman and S. Lins, *Temperley-Lieb Recoupling Theory and Invariants of 3-Manifolds*, Princeton U. Press, Princeton, New Jersey, 1994.

V. Turaev, *Quantum Invariants of Knots and 3-Manifolds*, de Gruyter, New York, 1994.

The book by Kauffman and Lins is especially handy whenever one needs a compendium of skein relations for $U_q\mathfrak{su}(2)$. For an overview of the relations between BF theory and Chern-Simons theory, see:

A. Cattaneo, P. Cotta-Ramusino, J. Fröhlich and M. Martellini, Topological BF theories in 3 and 4 dimensions, *Jour. Math. Phys.* **36** (1995), 6137-6160.

The q -deformed version of the Ponzano-Regge model was discovered by Turaev and Viro:

V. Turaev and O. Viro, State sum invariants of 3-manifolds and quantum $6j$ symbols, *Topology* **31** (1992), 865-902.

They formulated the theory both in terms of a triangulation of the 3-manifold and, dually, in terms of a 2-dimensional complex embedded in the manifold. We may now see their theory as a spin foam model for 3d Riemannian quantum gravity with nonzero cosmological constant. Their construction was soon generalized by isolating the properties of the $6j$ symbols that make it work, and tracing these back to the properties of certain categories of representations. One can read about these generalizations in the book by Turaev, and also in the following papers:

B. Durhuus, H. Jakobsen and R. Nest, Topological quantum field theories from generalized $6j$ -symbols, *Rev. Math. Phys.* **5** (1993), 1-67.

J. Barrett and B. Westbury, Invariants of piecewise-linear 3-manifolds, *Trans. Amer. Math. Soc.* **348** (1996), 3997-4022.

D. Yetter, State-sum invariants of 3-manifolds associated to Artinian semisimple tortile categories, *Topology and its Applications* **58** (1994), 47-80.

Turaev also described a related model in 4 dimensions, formulated in terms of a 2-dimensional complex embedded in the manifold:

V. Turaev, Quantum invariants of 3-manifolds and a glimpse of shadow topology, in *Quantum Groups*, Springer Lecture Notes in Mathematics 1510, Springer-Verlag, New York, 1992, pp. 363-366.

This model is also discussed in Turaev's book. Crane and Yetter developed an isomorphic theory, formulated in terms of a triangulation, by q -deforming Ooguri's formula for the partition function of 4d BF theory with gauge group $SU(2)$:

L. Crane and D. Yetter, A categorical construction of 4d TQFTs, in *Quantum Topology*, eds. L. Kauffman and R. Baadhio, World Scientific, Singapore, 1993, pp. 120-130.

The isomorphism between Turaev's theory and the Crane-Yetter model was worked out by Roberts:

J. Roberts, Skein theory and Turaev-Viro invariants, *Topology* **34** (1995), 771-787.

The generalization of this theory to other quantum groups was later worked out by Turaev (see his book above) and in the following paper:

L. Crane, L. Kauffman and D. Yetter, State-sum invariants of 4-manifolds, *J. Knot Theory & Ramifications* **6** (1997), 177-234.

For an argument that this theory is really a spin foam model of BF theory with cosmological term, see:

J. Baez, Four-dimensional BF theory as a topological quantum field theory, *Lett. Math. Phys.* **38** (1996), 129-143.

Along closely related lines, there is also some interesting work on the canonical quantization of Chern-Simons theory and 3d BF theory in the piecewise-linear context:

A. Alekseev, H. Grosse and V. Schomerus, Combinatorial quantization of the Hamiltonian Chern-Simons theory I, *Commun. Math. Phys.* **172** (1995), 317-358.

A. Alekseev, H. Grosse and V. Schomerus, Combinatorial quantization of the Hamiltonian Chern-Simons theory II, *Commun. Math. Phys.* **174** (1995), 561-604.

D. Bullock, C. Frohman, and J. Kania-Bartoszyńska, Topological interpretations of lattice gauge field theory, *Commun. Math. Phys.* **198** (1998), 47-81.

D. Bullock, C. Frohman, and J. Kania-Bartoszyńska, Skein modules and lattice gauge field theory, preprint available as math.GT/9802023.

9 4-Dimensional Quantum Gravity

For a tour of various formulations of Einstein's equation, see:

P. Peldan, Actions for gravity, with generalizations: a review, *Class. Quant. Grav.* **11** (1994), 1087-1132.

For an introduction to canonical quantum gravity, try the following books:

A. Ashtekar and invited contributors, *New Perspectives in Canonical Gravity*, Bibliopolis, Napoli, Italy, 1988. (Available through the American Institute of Physics; errata available from the Center for Gravitational Physics and Geometry at Pennsylvania State University.)

A. Ashtekar, *Lectures on Non-perturbative Canonical Quantum Gravity*, World Scientific, Singapore, 1991.

The spin foam model of 4-dimensional Riemannian quantum gravity which we discuss here was invented by Barrett and Crane:

J. Barrett and L. Crane, Relativistic spin networks and quantum gravity, *Jour. Math. Phys.* **39** (1998), 3296-3302.

A detailed discussion of their model appears in my first paper on spin foam models (see the Notes for Section 7). A more detailed treatment of general relativity as a constrained $\text{Spin}(4)$ BF theory can be found in the following papers:

M. Reisenberger, Classical Euclidean general relativity from 'lefthanded area = righthanded area', preprint available as gr-qc/9804061.

R. De Pietri and L. Freidel, $\mathfrak{so}(4)$ Plebanski action and relativistic spin foam model, preprint available as gr-qc/9804071.

A heuristic argument for the uniqueness of the Barrett-Crane intertwiner was given by Barbieri:

A. Barbieri, Space of the vertices of relativistic spin networks, preprint available as gr-qc/9709076.

Later, Reisenberger gave a rigorous proof:

M. Reisenberger, On relativistic spin network vertices, preprint available as gr-qc/9809067.

An explanation of the uniqueness of the Barrett-Crane intertwiner in terms of geometric quantization was given in my paper with Barrett on the quantum tetrahedron (see the Notes for Section 5.) Similar intertwiners for vertices of higher valence have been constructed by Yetter:

D. Yetter, Generalized Barrett-Crane vertices and invariants of embedded graphs, preprint available as math.QA/9801131.

Barrett found an integral formula for the Barrett-Crane intertwiner:

J. Barrett, the classical evaluation of relativistic spin networks, preprint available as math.QA/9803063.

Later, he and Williams used this to give a heuristic argument relating the asymptotics of the amplitudes in the Barrett-Crane model to the Regge action:

J. Barrett and R. Williams, The asymptotics of an amplitude for the 4-simplex, preprint available as gr-qc/9809032.

For the Regge action, see:

T. Regge, General relativity without coordinates, *Nuovo Cimento* **19** (1961), 558-571.

Reisenberger and Iwasaki have proposed alternative spin foam models of 4-dimensional Riemannian quantum gravity. As with the Barrett-Crane model, the basic idea behind these models is to treat general relativity as a constrained BF theory. However, the models of Reisenberger and Iwasaki involve only the left-handed part of the spin connection, so the gauge group is $SU(2)$:

M. Reisenberger, A lattice worldsheet sum for 4-d Euclidean general relativity, preprint available as gr-qc/9711052.

J. Iwasaki, A surface theoretic model of quantum gravity, preprint available as gr-qc/9903112.

Freidel and Krasnov have constructed spin foam models of Riemannian quantum gravity in higher dimensions by treating the theory as a constrained BF theory with gauge group $SO(n)$:

L. Freidel, K. Krasnov, and R. Puzio, BF description of higher-dimensional gravity theories, preprint available as hep-th/9901069.

Barrett and Crane have also begun work on a Lorentzian version of their theory, but so far their formula for the amplitude of a spin foam vertex remains formal, because the evaluation of spin networks typically diverges when the gauge group is noncompact, apparently even after q -deformation:

J. Barrett and L. Crane, A Lorentzian signature model for quantum general relativity, preprint available as gr-qc/9904025.

In a different but related line of development, Markopoulou and Smolin have considered a class of local, causal rules for the time evolution of spin networks. Rules in this class are the same as spin foam models.

F. Markopoulou and L. Smolin, Quantum geometry with intrinsic local causality, *Phys. Rev.* **D58**:084032 (1998).

Smolin has suggested a relationship between these models and string theory, and proposed a specific model of this type as a candidate for a background-free formulation of M -theory. Ling and Smolin have begun to develop the supersymmetric analogue of the theory of spin networks:

L. Smolin, Strings as perturbations of evolving spin networks, preprint available as hep-th/9801022.
L. Smolin, Towards a background-independent approach to M theory, preprint available as hep-th/9808192.
Y. Ling, L. Smolin, Supersymmetric spin networks and quantum supergravity, preprint available as hep-th/9904016.

Appendix

For more details on piecewise linear cell complexes, try:

C. Rourke and B. Sanderson, *Introduction to Piecewise-Linear Topology*, Springer Verlag, Berlin, 1972.

The 2-dimensional case is explored more deeply in:

C. Hog-Angeloni, W. Metzler, and A. Sieradski, *Two-dimensional Homotopy and Combinatorial Group Theory*, London Mathematical Society Lecture Note Series 197, Cambridge U. Press, Cambridge, 1993.