

Black Holes

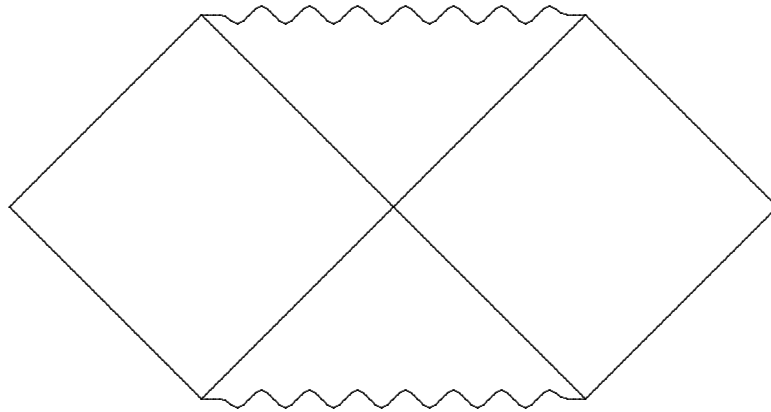

Lecture notes
by

Dr. P.K. Townsend

DAMTP, University of Cambridge,
Silver St., Cambridge, U.K.

Acknowledgements

These notes were written to accompany a course taught in Part III of the Cambridge University Mathematical Tripos. There are occasional references to questions on four 'example sheets', which can be found in the Appendix. The writing of these course notes has greatly benefitted from discussions with Gary Gibbons and Stephen Hawking. The organisation of the course was based on unpublished notes of Gary Gibbons and owes much to the 1972 Les Houches and 1986 Cargèse lecture notes of Brandon Carter, and to the 1972 lecture notes of Stephen Hawking. Finally, I am very grateful to Tim Perkins for typing the notes in \LaTeX , producing the diagrams, and putting it all together.

Contents

1	Gravitational Collapse	6
1.1	The Chandrasekhar Limit	6
1.2	Neutron Stars	8
2	Schwarzschild Black Hole	11
2.1	Test particles: geodesics and affine parameterization	11
2.2	Symmetries and Killing Vectors	13
2.3	Spherically-Symmetric Pressure Free Collapse	15
2.3.1	Black Holes and White Holes	18
2.3.2	Kruskal-Szekeres Coordinates	20
2.3.3	Eternal Black Holes	24
2.3.4	Time translation in the Kruskal Manifold	26
2.3.5	Null Hypersurfaces	27
2.3.6	Killing Horizons	29
2.3.7	Rindler spacetime	33
2.3.8	Surface Gravity and Hawking Temperature	37
2.3.9	Tolman Law - Unruh Temperature	39
2.4	Carter-Penrose Diagrams	40
2.4.1	Conformal Compactification	40
2.5	Asymptopia	47
2.6	The Event Horizon	49
2.7	Black Holes vs. Naked Singularities	53
3	Charged Black Holes	56
3.1	Reissner-Nordström	56
3.2	Pressure-Free Collapse to RN	65
3.3	Cauchy Horizons	67
3.4	Isotropic Coordinates for RN	70
3.4.1	Nature of Internal ∞ in Extreme RN	74

3.4.2	Multi Black Hole Solutions	75
4	Rotating Black Holes	76
4.1	Uniqueness Theorems	76
4.1.1	Spacetime Symmetries	76
4.2	The Kerr Solution	78
4.2.1	Angular Velocity of the Horizon	84
4.3	The Ergosphere	88
4.4	The Penrose Process	88
4.4.1	Limits to Energy Extraction	89
4.4.2	Super-radiance	90
5	Energy and Angular Momentum	93
5.1	Covariant Formulation of Charge Integral	93
5.2	ADM energy	94
5.2.1	Alternative Formula for ADM Energy	96
5.3	Komar Integrals	97
5.3.1	Angular Momentum in Axisymmetric Spacetimes	98
5.4	Energy Conditions	99
6	Black Hole Mechanics	101
6.1	Geodesic Congruences	101
6.1.1	Expansion and Shear	106
6.2	The Laws of Black Hole Mechanics	109
6.2.1	Zeroth law	109
6.2.2	Smarr's Formula	110
6.2.3	First Law	112
6.2.4	The Second Law (Hawking's Area Theorem)	113
7	Hawking Radiation	119
7.1	Quantization of the Free Scalar Field	119
7.2	Particle Production in Non-Stationary Spacetimes	123
7.3	Hawking Radiation	125
7.4	Black Holes and Thermodynamics	129
7.4.1	The Information Problem	130
A	Example Sheets	132
A.1	Example Sheet 1	132
A.2	Example Sheet 2	135
A.3	Example Sheet 3	138

A.4 Example Sheet 4 141

Chapter 1

Gravitational Collapse

1.1 The Chandrasekhar Limit

A Star is a self-gravitating ball of hydrogen atoms supported by thermal pressure $P \sim nkT$ where n is the number density of atoms. In equilibrium,

$$E = E_{\text{grav}} + E_{\text{kin}} \quad (1.1)$$

is a minimum. For a star of mass M and radius R

$$E_{\text{grav}} \sim -\frac{GM^2}{R} \quad (1.2)$$

$$E_{\text{kin}} \sim nR^3 \langle E \rangle \quad (1.3)$$

where $\langle E \rangle$ is average kinetic energy of atoms. Eventually, fusion at the core must stop, after which the star cools and contracts. Consider the possible final state of a star at $T = 0$. The pressure P does not go to zero as $T \rightarrow 0$ because of *degeneracy pressure*. Since $m_e \ll m_p$ the electrons become degenerate first, at a number density of one electron in a cube of side \sim Compton wavelength.

$$n_e^{-1/3} \sim \frac{\hbar}{\langle p \rangle}, \quad \langle p \rangle = \text{average electron momentum} \quad (1.4)$$

Can electron degeneracy pressure support a star from collapse at $T = 0$?

Assume that electrons are *non-relativistic*. Then

$$\langle E \rangle \sim \frac{\langle p_e \rangle^2}{m_e}. \quad (1.5)$$

So, since $n = n_e$,

$$E_{\text{kin}} \sim \frac{\hbar^2 R^2 r_e^{2/3}}{m_e}. \quad (1.6)$$

Since $m_e \ll m_p$, $M \approx n_e R^3 m_e$, so $n_e \sim \frac{M}{m_p R^3}$ and

$$E_{\text{kin}} \sim \frac{\hbar^2}{m_e} \underbrace{\left(\frac{M}{m_p}\right)^{5/3}}_{\text{constant for fixed } M} \frac{1}{R^2}. \quad (1.7)$$

Thus

$$E \sim -\frac{\alpha}{R} - \frac{\beta}{R^2}, \quad \alpha, \beta \text{ independent of } R. \quad (1.8)$$

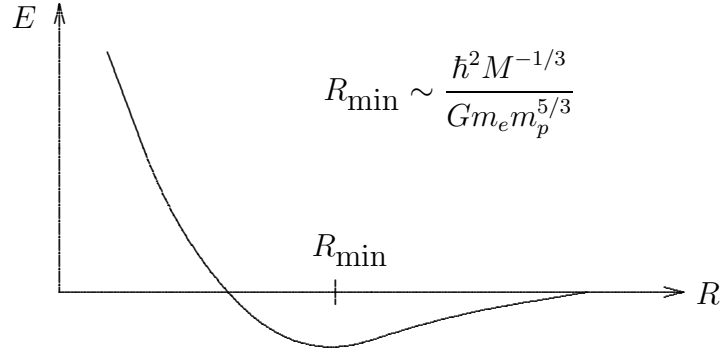

The collapse of the star is therefore prevented. It becomes a *White Dwarf* or a cold, dead star supported by electron degeneracy pressure.

At equilibrium

$$n_e \sim \frac{M}{m_p R_{\text{min}}^3} \left(\frac{m_e G}{\hbar^2} (M m_p^2)^{2/3} \right)^3. \quad (1.9)$$

But the validity of non-relativistic approximation requires that $\langle p_e \rangle \ll m_e c$, i.e.

$$\frac{\langle p_e \rangle}{m_e} = \frac{\hbar n_e^{1/3}}{m_e} \ll c \quad (1.10)$$

$$\text{or } n_e \ll \left(\frac{m_e c}{\hbar} \right)^3. \quad (1.11)$$

For a White Dwarf this implies

$$\frac{m_e G}{\hbar^2} (M m_p^2)^{2/3} \ll \frac{m_e c}{\hbar} \quad (1.12)$$

$$\text{or } M \ll \frac{1}{m_p^2} \left(\frac{\hbar c}{G} \right)^{3/2}. \quad (1.13)$$

For sufficiently large M the electrons would have to be relativistic, in which case we must use

$$\langle E \rangle = \langle p_e \rangle c = \hbar c n_e^{1/3} \quad (1.14)$$

$$\Rightarrow E_{\text{kin}} \sim n_e R^3 \langle E \rangle \sim \hbar c R^3 n_e^{4/3} \quad (1.15)$$

$$\sim \hbar c R^3 \left(\frac{M}{m_p R^3} \right)^{4/3} \sim \hbar c \left(\frac{M}{m_p} \right)^{4/3} \frac{1}{R} \quad (1.16)$$

So now,

$$E \sim -\frac{\alpha}{R} + \frac{\gamma}{R}. \quad (1.17)$$

Equilibrium is possible only for

$$\gamma = \alpha \quad \Rightarrow \quad M \sim \frac{1}{m_p^2} \left(\frac{\hbar c}{G} \right)^{3/2}. \quad (1.18)$$

For smaller M , R must increase until electrons become non-relativistic, in which case the star is supported by electron degeneracy pressure, as we just saw. For larger M , R must continue to decrease, so electron degeneracy pressure cannot support the star. There is therefore a critical mass M_C

$$M_C \sim \frac{1}{m_p^2} \left(\frac{\hbar c}{G} \right)^{3/2} \quad \Rightarrow \quad R_C \sim \frac{1}{m_e m_p} \left(\frac{\hbar^3}{G c} \right)^{1/2} \quad (1.19)$$

above which a star cannot end as a White Dwarf. This is the *Chandrasekhar limit*. Detailed calculation gives $M_C \simeq 1.4 M_\odot$.

1.2 Neutron Stars

The electron energies available in a White Dwarf are of the order of the Fermi energy. Necessarily $E_F \lesssim m_e c^2$ since the electrons are otherwise relativistic and cannot support the star. A White Dwarf is therefore stable against inverse β -decay

$$e^- + p^+ \rightarrow n + \nu_e \quad (1.20)$$

since the reaction needs energy of at least $(\Delta m_n)c^2$ where Δm_n is the neutron-proton mass difference. Clearly $\Delta m > m_e$ (β -decay would otherwise be impossible) and in fact $\Delta m \sim 3m_e$. So we need energies of order of $3m_e c^2$ for inverse β -decay. This is not available in White Dwarf stars but for $M > M_C$ the star must continue to contract until $E_F \sim (\Delta m_n)c^2$. At this point inverse β -decay can occur. The reaction cannot come to equilibrium with the reverse reaction

$$n + \nu_e \rightarrow e^- + p^+ \quad (1.21)$$

because the neutrinos escape from the star, and β -decay,

$$n \rightarrow e^- + p^+ \bar{\nu}_e \quad (1.22)$$

cannot occur because all electron energy levels below $E < (\Delta m_n)c^2$ are filled when $E > (\Delta m_n)c^2$. Since inverse β -decay removes the electron degeneracy pressure the star will undergo a catastrophic collapse to nuclear matter density, at which point we must take *neutron-degeneracy pressure* into account.

Can neutron-degeneracy pressure support the star against collapse?

The ideal gas approximation would give same result as before but with $m_e \rightarrow m_p$. The critical mass M_C is *independent* of m_e and so is unaffected, but the critical radius is now

$$\left(\frac{m_e}{m_p}\right) R_C \sim \frac{1}{m_p^2} \left(\frac{\hbar^3}{Gc}\right)^{1/2} \sim \frac{GM_C}{c^2} \quad (1.23)$$

which is the Schwarzschild radius, so the neglect of GR effects was not justified. Also, at nuclear matter densities the ideal gas approximation is not justified. A perfect fluid approximation is reasonable (since viscosity can't help). Assume that $P(\rho)$ (ρ = density of fluid) satisfies

$$\text{i) } P \geq 0 \quad (\text{local stability}). \quad (1.24)$$

$$\text{ii) } P' < c^2 \quad (\text{causality}). \quad (1.25)$$

Then the *known behaviour* of $P(\rho)$ at low nuclear densities gives

$$M_{\text{max}} \sim 3M_\odot. \quad (1.26)$$

More massive stars must continue to collapse either to an unknown new ultra-high density state of matter or to a black hole. The latter is more

likely. In any case, there must be *some* mass at which gravitational collapse to a black hole is unavoidable because the density at the Schwarzschild radius decreases as the total mass increases. In the limit of very large mass the collapse is well-approximated by assuming the collapsing material to be a pressure-free ball of fluid. We shall consider this case shortly.

Chapter 2

Schwarzschild Black Hole

2.1 Test particles: geodesics and affine parameterization

Let \mathcal{C} be a timelike curve with endpoints A and B . The action for a particle of mass m moving on \mathcal{C} is

$$I = -mc^2 \int_A^B d\tau \quad (2.1)$$

where τ is proper time on \mathcal{C} . Since

$$d\tau = \sqrt{-ds^2} = \sqrt{-dx^\mu dx^\nu g_{\mu\nu}} = \sqrt{-\dot{x}^\mu \dot{x}^\nu g_{\mu\nu}} d\lambda \quad (2.2)$$

where λ is an arbitrary parameter on \mathcal{C} and $\dot{x}^\mu = \frac{dx^\mu}{d\lambda}$, we have

$$I[x] = -m \int_{\lambda_A}^{\lambda_B} d\lambda \sqrt{-\dot{x}^\mu \dot{x}^\nu g_{\mu\nu}} \quad (c = 1) \quad (2.3)$$

The particle worldline, \mathcal{C} , will be such that $\delta I / \delta x(\lambda) = 0$. By definition, this is a *geodesic*. For the purpose of finding geodesics, an equivalent action is

$$I[x, e] = \frac{1}{2} \int_{\lambda_A}^{\lambda_B} d\lambda [e^{-1}(\lambda) \dot{x}^\mu \dot{x}^\nu g_{\mu\nu} - m^2 e(\lambda)] \quad (2.4)$$

where $e(\lambda)$ (the ‘einbein’) is a new independent function.

Proof of equivalence (for $m \neq 0$)

$$\frac{\delta I}{\delta e} = 0 \quad \Rightarrow \quad e = \frac{1}{m} \sqrt{-\dot{x}^\mu \dot{x}^\nu g_{\mu\nu}} = \frac{1}{m} \frac{d\tau}{d\lambda} \quad (2.5)$$

and (exercise)

$$\frac{\delta I}{\delta x^\mu} = 0 \quad \Rightarrow \quad D_{(\lambda)} \dot{x}^\mu = (e^{-1} \dot{e}) \dot{x}^\mu \quad (2.6)$$

where

$$D_{(\lambda)} V^\mu(\lambda) \equiv \frac{d}{d\lambda} V^\mu + \dot{x}^\nu \left\{ \begin{matrix} \mu \\ \rho \nu \end{matrix} \right\} V^\rho \quad (2.7)$$

If (2.5) is substituted into (2.6) we get the EL equation $\delta I / \delta x^\mu = 0$ of the original action $I[x]$ (exercise), hence equivalence.

The freedom in the choice of parameter λ is equivalent to the freedom in the choice of function e . Thus any curve $x^\mu(\lambda)$ for which $t^\mu = \dot{x}^\mu(\lambda)$ satisfies

$$D_{(\lambda)} t^\mu V^\mu = f(x) t^\mu \quad (\text{arbitrary } f) \quad (2.8)$$

is a geodesic. Note that for any vector field on \mathcal{C} , $V^\mu(x(\lambda))$,

$$t^\nu D_\nu V^\mu \equiv t^\nu \partial_\nu V^\mu + t^\nu \left\{ \begin{matrix} \mu \\ \nu \rho \end{matrix} \right\} V^\rho \quad (2.9)$$

$$= \frac{d}{d\lambda} V^\mu + \dot{x}^\nu \left\{ \begin{matrix} \mu \\ \nu \rho \end{matrix} \right\} V^\rho \quad (2.10)$$

$$= D_{(\lambda)} V^\mu \quad (2.11)$$

Since t is *tangent* to the curve \mathcal{C} , a vector field V on \mathcal{C} for which

$$D_{(\lambda)} V^\mu = f(\lambda) V^\mu \quad (\text{arbitrary } f) \quad (2.12)$$

is said to be *parallelly transported* along the curve. A geodesic is therefore a *curve whose tangent is parallelly transported along it* (w.r.t. the affine connection).

A natural choice of parameterization is one for which

$$D_{(\lambda)} t^\mu = 0 \quad (t^\mu = \dot{x}^\mu) \quad (2.13)$$

This is called *affine parameterization*. For a timelike geodesic it corresponds to $e(\lambda) = \text{constant}$, or

$$\lambda \propto \tau + \text{constant} \quad (2.14)$$

The einbein form of the particle action has the advantage that we can take the $m \rightarrow 0$ limit to get the action for a massless particle. In this case

$$\frac{\delta I}{\delta e} = 0 \quad \Rightarrow \quad ds^2 = 0 \quad (m = 0) \quad (2.15)$$

while (2.6) is unchanged. We still have the freedom to choose $e(\lambda)$ and the choice $e = \text{constant}$ is again called affine parameterization.

Summary

Let $t^\mu = \frac{dx^\mu(\lambda)}{d\lambda}$ and $\sigma = \begin{cases} 1 & m \neq 0 \\ 0 & m = 0 \end{cases}$.

Then

$$\boxed{\begin{aligned} t \cdot Dt^\mu &\equiv D_{(\lambda)}t^\mu = 0 \\ ds^2 &= -\sigma d\lambda^2 \end{aligned}} \quad (2.16)$$

are the equations of affinely-parameterized timelike or null geodesics.

2.2 Symmetries and Killing Vectors

Consider the transformation

$$x^\mu \rightarrow x^\mu - \alpha k^\mu(x), \quad (e \rightarrow e) \quad (2.17)$$

Then (Exercise)

$$I[x, e] \rightarrow I[x, e] - \frac{\alpha}{2} \int_{\lambda_A}^{\lambda_B} d\lambda e^{-1} \dot{x}^\mu \dot{x}^\nu (\mathcal{L}_k g)_{\mu\nu} + \mathcal{O}(\alpha^2) \quad (2.18)$$

where

$$(\mathcal{L}_k g)_{\mu\nu} = k^\lambda g_{\mu\nu, \lambda} + k^\lambda_{, \mu} g_{\lambda\nu} + k^\lambda_{, \nu} g_{\lambda\mu} \quad (2.19)$$

$$= 2D_{(\mu} k_{\nu)} \quad (\text{Exercise}) \quad (2.20)$$

Thus the action is invariant to first order if

$$\mathcal{L}_k g = 0 \quad (2.21)$$

A vector field $k^\mu(x)$ with this property is a *Killing vector* field. k is associated with a symmetry of the particle action and hence with a conserved charge. This charge is (Exercise)

$$Q = k^\mu p_\mu \quad (2.22)$$

where p_μ is the particle's 4-momentum.

$$p_\mu = \frac{\partial \mathcal{L}}{\partial \dot{x}^\mu} = e^{-1} \dot{x}^\nu g_{\mu\nu} \quad (2.23)$$

$$= m \frac{dx^\nu}{d\tau} g_{\mu\nu} \quad \text{when } m \neq 0 \quad (2.24)$$

Exercise Check that the Euler-Lagrange equations imply

$$\frac{dQ}{d\lambda} = 0$$

Quantize, $p_\mu \rightarrow -i\partial/\partial x^\mu \equiv -i\partial_\mu$. Then

$$Q \rightarrow -ik^\mu \partial_\mu \quad (2.25)$$

Thus the components of k can be viewed as the components of a *differential operator* in the basis $\{\partial_\mu\}$.

$$k \equiv k^\mu \partial_\mu \quad (2.26)$$

It is convenient to identify this operator with the vector field. Similarly for all other vector fields, e.g. the tangent vector to a curve $x^\mu(\lambda)$ with affine parameter λ .

$$t = t^\mu \partial_\mu = \frac{dx^\mu}{d\lambda} \partial_\mu = \frac{d}{d\lambda} \quad (2.27)$$

For any vector field, k , local coordinates can be found such that

$$k = \partial/\partial \xi \quad (2.28)$$

where ξ is one of the coordinates. In such a coordinate system

$$\mathcal{L}_k g_{\mu\nu} = \frac{\partial}{\partial \xi} g_{\mu\nu} \quad (2.29)$$

So k is Killing if $g_{\mu\nu}$ is independent of ξ .

e.g. for Schwarzschild $\partial_t g_{\mu\nu} = 0$, so $\partial/\partial t$ is a Killing vector field. The conserved quantity is

$$mk^\mu \frac{dx^\nu}{d\tau} g_{\mu\nu} = mg_{00} \frac{dt}{d\tau} = -m\varepsilon \quad (\varepsilon = \text{energy/unit mass}) \quad (2.30)$$

2.3 Spherically-Symmetric Pressure Free Collapse

While it is impossible to say with complete confidence that a real star of mass $M \gg 3M_\odot$ will collapse to a BH, it is easy to invent idealized, but physically possible, stars that definitely do collapse to black holes. One such ‘star’ is a spherically-symmetric ball of ‘dust’ (i.e. zero pressure fluid). *Birkhoff’s theorem* implies that the metric outside the star is the *Schwarzschild metric*. Choose units for which

$$G = 1, \quad c = 1. \quad (2.31)$$

Then

$$ds^2 = - \left(1 - \frac{2M}{r}\right) dt^2 + \left(1 - \frac{2M}{r}\right)^{-1} dr^2 + r^2 d\Omega^2 \quad (2.32)$$

where

$$d\Omega^2 = d\theta^2 + \sin^2 \theta d\varphi^2 \quad (\text{metric on a unit 2-sphere}) \quad (2.33)$$

This is valid outside the star but also, by continuity of the metric, at the surface. If $r = R(t)$ on the surface we have

$$ds^2 = - \left[\left(1 - \frac{2M}{R}\right) - \left(1 - \frac{2M}{R}\right)^{-1} \dot{R}^2 \right] dt^2 + R^2 d\Omega^2, \quad \left(\dot{R} = \frac{d}{dt} R \right) \quad (2.34)$$

On the surface zero pressure and spherical symmetry implies that a point on the surface follows a *radial timelike geodesic*, so $d\Omega^2 = 0$ and $ds^2 = -d\tau^2$, so

$$1 = \left[\left(1 - \frac{2M}{R}\right) - \left(1 - \frac{2M}{R}\right)^{-1} \dot{R}^2 \right] \left(\frac{dt}{d\tau} \right)^2 \quad (2.35)$$

But also, since $\partial/\partial t$ is a Killing vector we have *conservation of energy*:

$$\varepsilon = -g_{00} \frac{dt}{d\tau} = \left(1 - \frac{2M}{R}\right) \frac{dt}{d\tau} \quad (\text{energy/unit mass}) \quad (2.36)$$

ε is *constant on the geodesics*. Using this in (2.35) gives

$$1 = \left[\left(1 - \frac{2M}{R}\right) - \left(1 - \frac{2M}{R}\right)^{-1} \dot{R}^2 \right] \left(1 - \frac{2M}{R}\right)^{-2} \varepsilon^2 \quad (2.37)$$

or

$$\boxed{\dot{R}^2 = \frac{1}{\varepsilon^2} \left(1 - \frac{2M}{R}\right)^2 \left(\frac{2M}{R} - 1 + \varepsilon^2\right)} \quad (2.38)$$

($\varepsilon < 1$ for gravitationally bound particles).

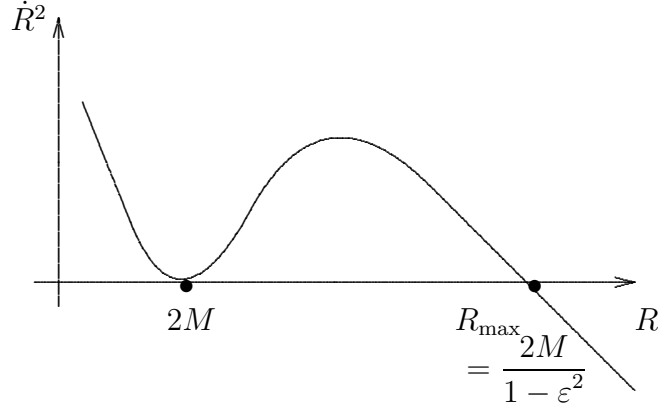

$\dot{R} = 0$ at $R = R_{\max}$ so we consider collapse to begin with zero velocity at this radius. R then decreases and approaches $R = 2M$ asymptotically as $t \rightarrow \infty$. So an observer ‘sees’ the star contract at most to $R = 2M$ but no further.

However from the point of view of an observer on the surface of the star, the relevant time variable is proper time along a radial geodesic, so use

$$\frac{d}{dt} = \left(\frac{dt}{d\tau}\right)^{-1} \frac{d}{d\tau} = \frac{1}{\epsilon} \left(1 - \frac{2M}{R}\right) \frac{d}{d\tau} \quad (2.39)$$

to rewrite (2.38) as

$$\boxed{\left(\frac{dR}{d\tau}\right)^2 = \left(\frac{2M}{R} - 1 + \epsilon^2\right) = (1 - \epsilon^2) \left(\frac{R_{\max}}{R} - 1\right)} \quad (2.40)$$

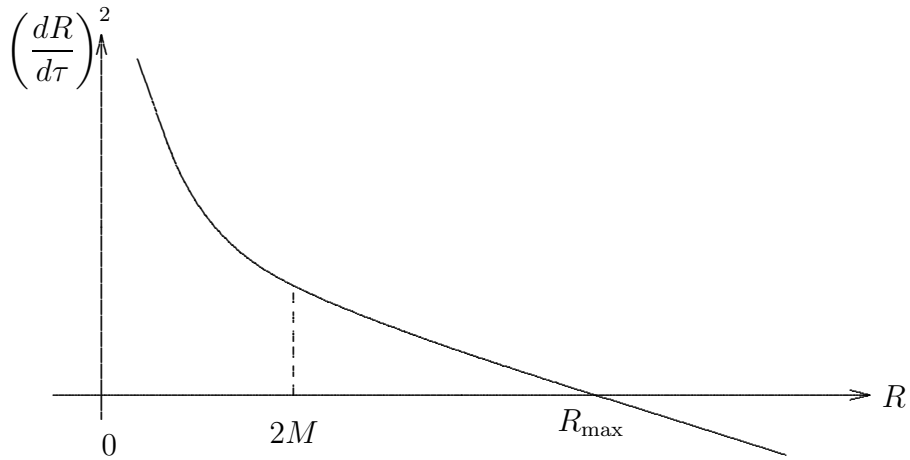

Surface of the star falls from $R = R_{\max}$ through $R = 2M$ in *finite proper time*. In fact, it falls to $R = 0$ in proper time

$$\tau = \frac{\pi M}{(1 - \varepsilon)^{3/2}} \quad (\text{Exercise}) \quad (2.41)$$

Nothing special happens at $R = 2M$ which suggests that we investigate the spacetime near $R = 2M$ in coordinates adapted to infalling observers. It is convenient to choose *massless* particles.

On radial null geodesics in Schwarzschild spacetime

$$dt^2 = \frac{1}{\left(1 - \frac{2M}{r}\right)^2} dr^2 \equiv (dr^*)^2 \quad (2.42)$$

where

$$r^* = r + 2M \ln \left| \frac{r - 2M}{2M} \right| \quad (2.43)$$

is the *Regge-Wheeler radial coordinate*. As r ranges from $2M$ to ∞ , r^* ranges from $-\infty$ to ∞ . Thus

$$d(t \pm r^*) = 0 \quad \text{on radial null geodesics} \quad (2.44)$$

Define the ingoing radial null coordinate v by

$$v = t + r^*, \quad -\infty < v < \infty \quad (2.45)$$

and rewrite the Schwarzschild metric in *ingoing Eddington-Finkelstein coordinates* (v, r, θ, ϕ) .

$$ds^2 = \left(1 - \frac{2M}{r}\right) (-dt^2 + dr^{*2}) + r^2 d\Omega^2 \quad (2.46)$$

$$= -\left(1 - \frac{2M}{r}\right) dv^2 + 2dr dv + r^2 d\Omega^2 \quad (2.47)$$

This metric is *initially* defined for $r > 2M$ since the relation $v = t + r^*(r)$ between v and r is only defined for $r > 2M$, but it can now be *analytically continued* to all $r > 0$. Because of the $dr dv$ cross-term the metric in EF coordinates is *non-singular at $r = 2M$* , so the singularity in Schwarzschild coordinates was really a coordinate singularity. There is nothing at $r = 2M$ to prevent the star collapsing through $r = 2M$. This is illustrated by a *Finkelstein diagram*, which is a plot of $t^* = v - r$ against r :

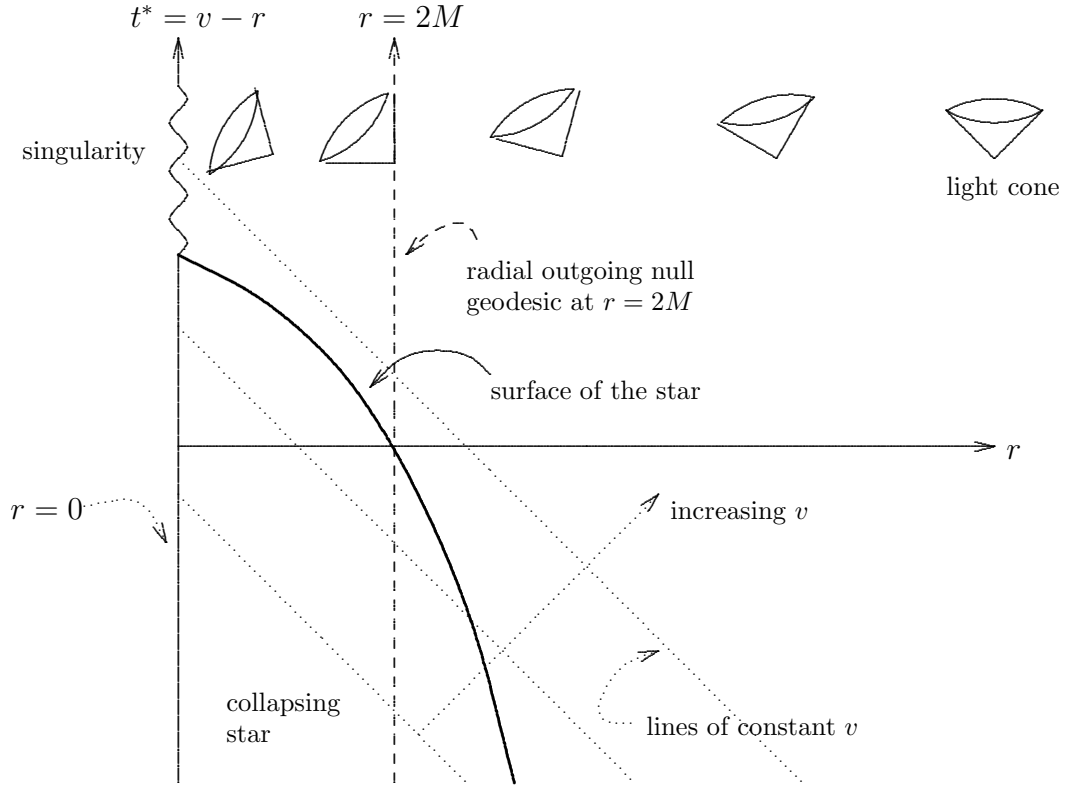

The light cones distort as $r \rightarrow 2M$ from $r > 2M$, so that no future-directed timelike or null worldline can reach $r > 2M$ from $r \leq 2M$.

Proof When $r \leq 2M$,

$$2dr dv = - \left[-ds^2 + \left(\frac{2M}{r} - 1 \right) dv^2 + r^2 d\Omega^2 \right] \quad (2.48)$$

$$\leq 0 \quad \text{when } ds^2 \leq 0 \quad (2.49)$$

for all timelike or null worldlines $dr dv \leq 0$. $dv > 0$ for future-directed worldlines, so $dr \leq 0$ with equality when $r = 2M$, $d\Omega = 0$ (i.e. ingoing radial null geodesics at $r = 2M$).

2.3.1 Black Holes and White Holes

No signal from the star's surface can escape to infinity once the surface has passed through $r = 2M$. The star has collapsed to a *black hole*. For

the external observer, the surface never actually reaches $r = 2M$, but as $r \rightarrow 2M$ the redshift of light leaving the surface increases *exponentially* fast and the star effectively disappears from view within a time $\sim MG/c^3$. The late time appearance is dominated by photons escaping from the unstable photon orbit at $r = 3M$.

The hypersurface $r = 2M$ acts like a one-way membrane. This may seem paradoxical in view of the time-reversibility of Einstein's equations. Define the *outgoing* radial null coordinate u by

$$u = t - r^*, \quad -\infty < u < \infty \quad (2.50)$$

and rewrite the Schwarzschild metric in *outgoing Eddington-Finkelstein coordinates* (u, r, θ, ϕ) .

$$ds^2 = - \left(1 - \frac{2M}{r} \right) du^2 - 2dr du + r^2 d\Omega^2 \quad (2.51)$$

This metric is initially defined only for $r > 2M$ but it can be analytically continued to all $r > 0$. However the $r < 2M$ region in outgoing EF coordinates is not the same as the $r < 2M$ region in ingoing EF coordinates. To see this, note that for $r \leq 2M$

$$2dr du = -ds^2 + \left(\frac{2M}{r} - 1 \right) du^2 + r^2 d\Omega^2 \quad (2.52)$$

$$\geq 0 \quad \text{when } ds^2 \leq 0 \quad (2.53)$$

i.e. $dr du \geq 0$ on timelike or null worldlines. But $du > 0$ for future-directed worldlines so $dr \geq 0$, with equality when $r = 2M$, $d\Omega = 0$, and $ds^2 = 0$. In this case, a star with a surface at $r < 2M$ must *expand* and explode through $r = 2M$, as illustrated in the following Finkelstein diagram.

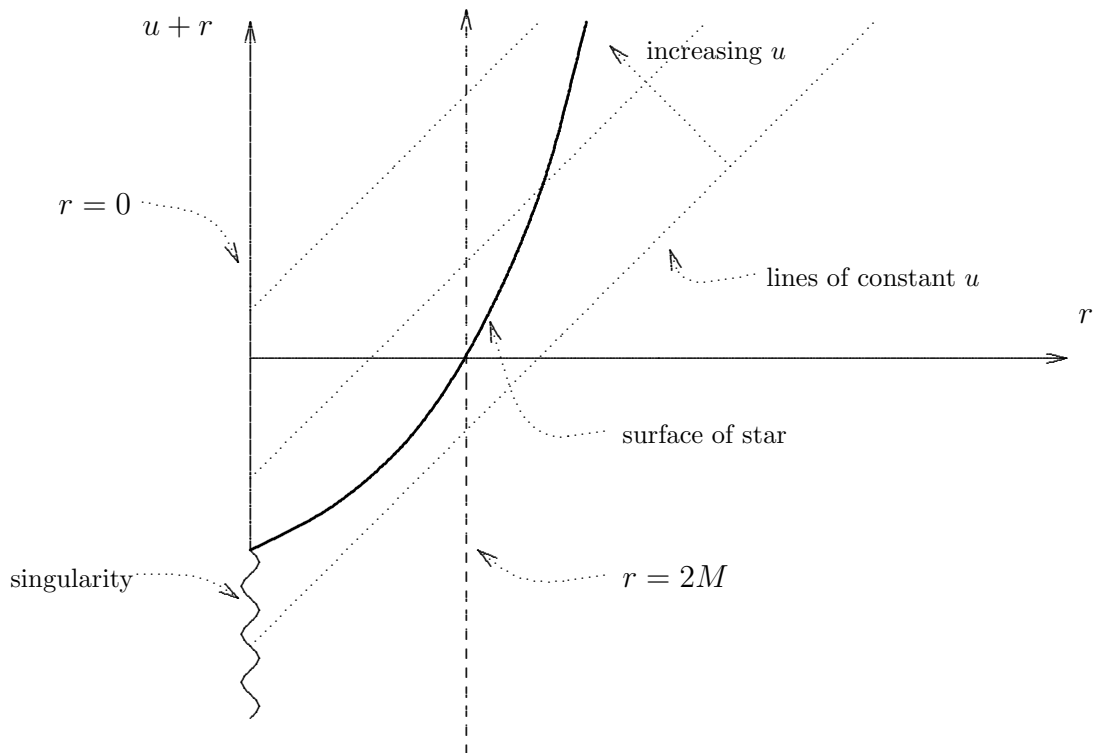

This is a *white hole*, the time reverse of a black hole. Both black and white holes are allowed by G.R. because of the time reversibility of Einstein's equations, but white holes require very special initial conditions near the singularity, whereas black holes do not, so only black holes can occur in practice (cf. irreversibility in thermodynamics).

2.3.2 Kruskal-Szekeres Coordinates

The exterior region $r > 2M$ is covered by both ingoing *and* outgoing Eddington-Finkelstein coordinates, and we may write the Schwarzschild metric in terms of (u, v, θ, ϕ)

$$ds^2 = - \left(1 - \frac{2M}{r} \right) du dv + r^2 d\Omega^2 \quad (2.54)$$

We now introduce the new coordinates (U, V) defined (for $r > 2M$) by

$$U = -e^{-u/4M}, \quad V = e^{v/4M} \quad (2.55)$$

in terms of which the metric is now

$$ds^2 = \frac{-32M^3}{r} e^{-r/2M} dU dV + r^2 d\Omega^2 \quad (2.56)$$

where $r(U, V)$ is given implicitly by $UV = -e^{r^*/2M}$ or

$$UV = - \left(\frac{r - 2M}{2M} \right) e^{r/2M} \quad (2.57)$$

We now have the Schwarzschild metric in KS coordinates (U, V, θ, ϕ) . Initially the metric is defined for $U < 0$ and $V > 0$ but it can be extended by analytic continuation to $U > 0$ and $V < 0$. Note that $r = 2M$ corresponds to $UV = 0$, i.e. either $U = 0$ or $V = 0$. The singularity at $r = 0$ corresponds to $UV = 1$.

It is convenient to plot lines of constant U and V (outgoing or ingoing radial null geodesics) at 45° , so the spacetime diagram now looks like

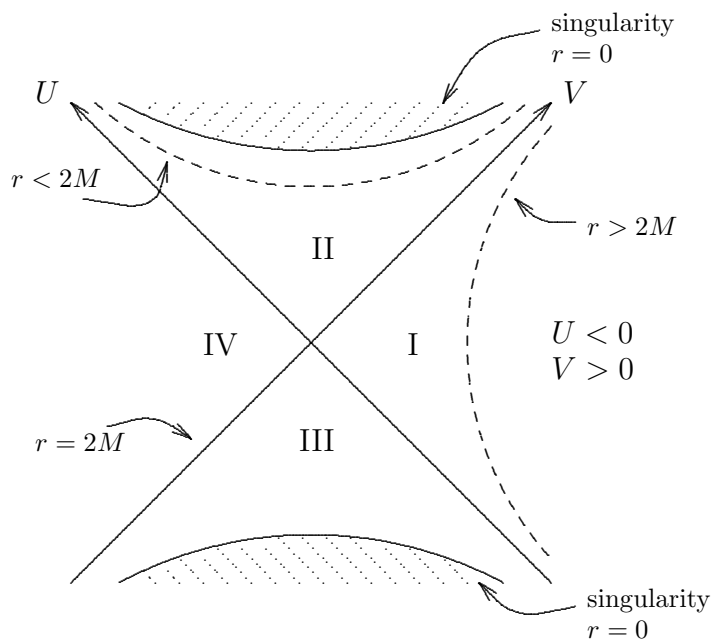

There are four regions of Kruskal spacetime, depending on the signs of U and V . Regions I and II are also covered by the ingoing Eddington-Finkelstein coordinates. These are the only regions relevant to gravitational collapse because the other regions are then replaced by the star's interior, e.g. for collapse of homogeneous ball of pressure-free fluid:

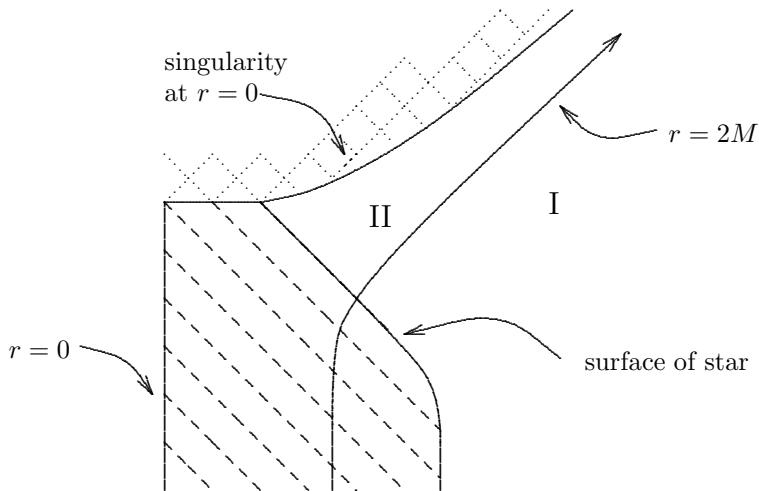

Similarly, regions I and III are those relevant to a white hole.

Singularities and Geodesic Completeness

A singularity of the metric is a point at which the determinant of either it or its inverse vanishes. However, a singularity of the metric may be simply due to a failure of the coordinate system. A simple two-dimensional example is the origin in plane polar coordinates, and we have seen that the singularity of the Schwarzschild metric at the Schwarzschild radius is of this type. Such singularities are removable. If no coordinate system exists for which the singularity is removable then it is irremovable, i.e. a genuine singularity of the spacetime. Any singularity for which some scalar constructed from the curvature tensor blows up as it is approached is irremovable. Such singularities are called ‘curvature singularities’. The singularity at $r = 0$ in the Schwarzschild metric is an example. Not all irremovable singularities are ‘curvature singularities’, however. Consider the singularity at the tip of a cone formed by rolling up a sheet of paper. All curvature invariants remain finite as the singularity is approached; in fact, in this two-dimensional example the curvature tensor is everywhere zero. If we could assign a curvature to the singular point at the tip of the cone it would have to be infinite but, strictly speaking, we cannot include this point as part of the manifold since there is no coordinate chart that covers it.

We might try to make a virtue of this necessity: by excising the regions containing irremovable singularities we apparently no longer have to worry about them. However, this just leaves us with the essentially equivalent problem of what to do with curves that reach the boundary of the excised

region. There is no problem if this boundary is at infinity, i.e. at infinite affine parameter along all curves that reach it from some specified point in the interior, but otherwise the inability to continue all curves to all values of their affine parameters may be taken as the defining feature of a ‘spacetime singularity’. Note that the concept of affine parameter is not restricted to geodesics, e.g. the affine parameter on a timelike curves is the proper time on the curve regardless of whether the curve is a geodesic. This is just as well, since there is no good physical reason why we should consider only geodesics. Nevertheless, it is virtually always true that the existence of a singularity as just defined can be detected by the incompleteness of some geodesic, i.e. there is some geodesic that cannot be continued to all values of its affine parameter. For this reason, and because it is simpler, we shall follow the common practice of defining a spacetime singularity in terms of ‘geodesic incompleteness’. Thus, *a spacetime is non-singular if and only if all geodesics can be extended to all values of their affine parameters*, changing coordinates if necessary.

In the case of the Schwarzschild vacuum solution, a particle on an ingoing radial geodesics will reach the coordinate singularity at $r = 2M$ at finite affine parameter but, as we have seen, this geodesic can be continued into region II by an appropriate change of coordinates. Its continuation will then approach the curvature singularity at $r = 0$, coming arbitrarily close for finite affine parameter. The excision of any region containing $r = 0$ will therefore lead to a incompleteness of the geodesic. The vacuum Schwarzschild solution is therefore singular. The singularity theorems of Penrose and Hawking show that geodesic incompleteness is a *generic feature* of gravitational collapse, and not just a special feature of spherically symmetric collapse.

Maximal Analytic Extensions

Whenever we encounter a singularity at finite affine parameter along some geodesic (timelike, null, or spacelike) our first task is to identify it as removable or irremovable. In the former case we can continue through it by a change of coordinates. By considering all geodesics we can construct in this way the *maximal analytic extension* of a given spacetime in which *any geodesic that does not terminate on an irremovable singularity can be extended to arbitrary values of its affine parameter*. The Kruskal manifold is the maximal analytic extension of the Schwarzschild solution, so no more regions can be found by analytic continuation.

2.3.3 Eternal Black Holes

A black hole formed by gravitational collapse is not time-symmetric because it will continue to exist into the indefinite future but did not always exist in the past, and vice-versa for white holes. However, one can imagine a time-symmetric eternal black hole that has always existed (it could equally well be called an eternal white hole, but isn't). In this case there is no matter covering up part of the Kruskal spacetime and all four regions are relevant. In region I

$$\frac{U}{V} = e^{-t/2M} \quad (2.58)$$

so hypersurfaces of constant Schwarzschild time t are straight lines through the origin in the Kruskal spacetime.

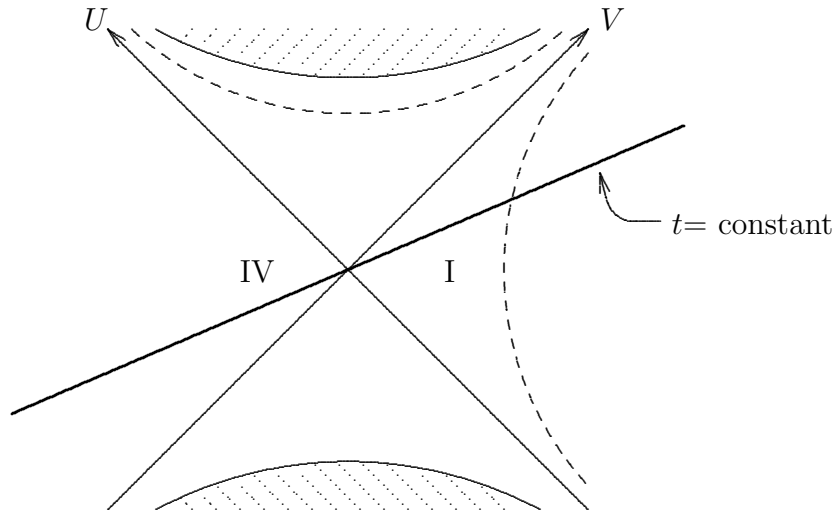

These hypersurfaces have a part in region I and a part in region IV. Note that $(U, V) \rightarrow (-U, -V)$ is an isometry of the metric so that region IV is isometric to region I.

To understand the geometry of these $t = \text{constant}$ hypersurfaces it is convenient to rewrite the Schwarzschild metric in *isotropic coordinates* (t, ρ, θ, ϕ) , where ρ is the new radial coordinate

$$r = \left(1 + \frac{M}{2\rho}\right)^2 \rho \quad (2.59)$$

Then (**Exercise**)

$$ds^2 = - \left(\frac{1 - \frac{M}{2\rho}}{1 + \frac{M}{2\rho}} \right)^2 dt^2 + \left(1 + \frac{M}{2\rho} \right)^4 \underbrace{[d\rho^2 + \rho^2 d\Omega^2]}_{\text{flat 3-space metric}} \quad (2.60)$$

In isotropic coordinates, the $t = \text{constant}$ hypersurfaces are *conformally flat*, but to each value of r there corresponds *two* values of ρ

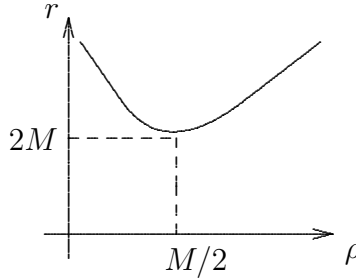

The two values of ρ are exchanged by the isometry, $\rho \rightarrow M^2/4\rho$ which has $\rho = M/2$ as its fixed ‘point’, actually a fixed 2-sphere of radius $2M$. This isometry corresponds to the $(U, V) \rightarrow (-U, -V)$ isometry of the Kruskal spacetime. The isotropic coordinates cover only regions I and IV since ρ is complex for $r < 2M$.

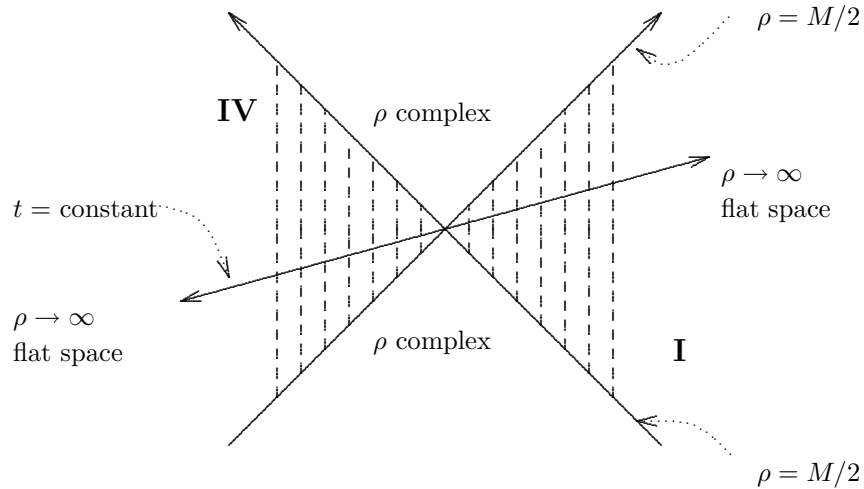

As $\rho \rightarrow M/2$ from either side the radius of a 2-sphere of constant ρ on a $t = \text{constant}$ hypersurface decreases to minimum of $2M$ at $\rho = M/2$, so $\rho = M/2$ is a *minimal 2-sphere*. It is the midpoint of an *Einstein-Rosen bridge* connecting spatial sections of regions I and IV.

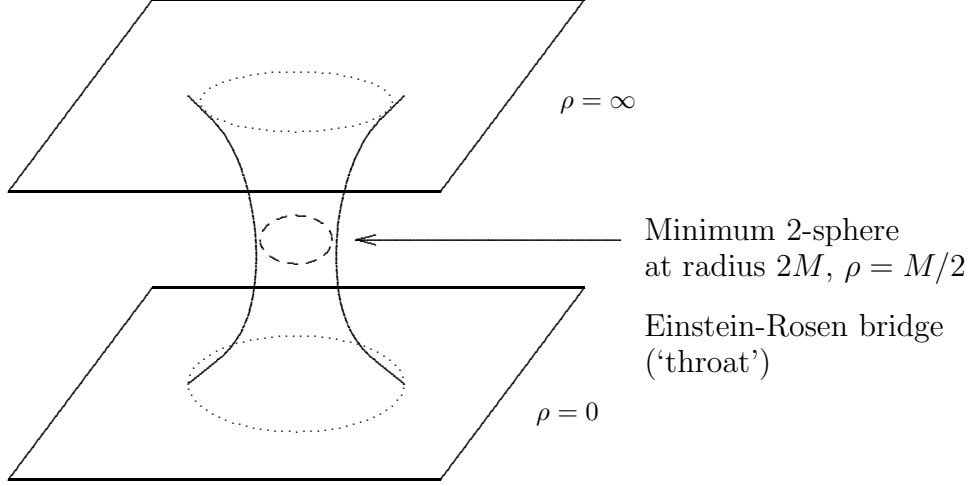

2.3.4 Time translation in the Kruskal Manifold

The time translation $t \rightarrow t + c$, which is an isometry of the Schwarzschild metric becomes

$$U \rightarrow e^{-c/4M}U, \quad V \rightarrow e^{c/4M}V \quad (2.61)$$

in Kruskal coordinates and extends to an isometry of the entire Kruskal manifold. The infinitesimal version

$$\delta U = -\frac{c}{4M}U, \quad \delta V = \frac{c}{4M}V \quad (2.62)$$

is generated by the Killing vector field

$$k = \frac{1}{4M} \left(V \frac{\partial}{\partial V} - U \frac{\partial}{\partial U} \right) \quad (2.63)$$

which equals $\partial/\partial t$ in region I. It has the following properties

$$(i) \quad k^2 = -\left(1 - \frac{2M}{r}\right) \Rightarrow \begin{cases} \text{timelike} & \text{in I \& IV} \\ \text{spacelike} & \text{in II \& III} \\ \text{null} & \text{on } r = 2M, \text{ i.e. } \{U = 0\} \cup \{V = 0\} \end{cases}$$

(ii) $\{U = 0\}$ and $\{V = 0\}$ are *fixed sets* on k .

On $\left\{ \begin{array}{l} \{U = 0\} \quad k = \partial/\partial v \\ \{V = 0\} \quad k = \partial/\partial u \end{array} \right\}$ where v, u are EF null coordinates.

$\therefore v$ is the natural group parameter on $\{U = 0\}$. Orbits of k correspond to $-\infty < v < \infty$, (where v is well-defined).

- (iii) Each point on the *Boyer-Kruskal axis*, $\{U = V = 0\}$ (a 2-sphere) is a *fixed point* of k .

The orbits of k are shown below

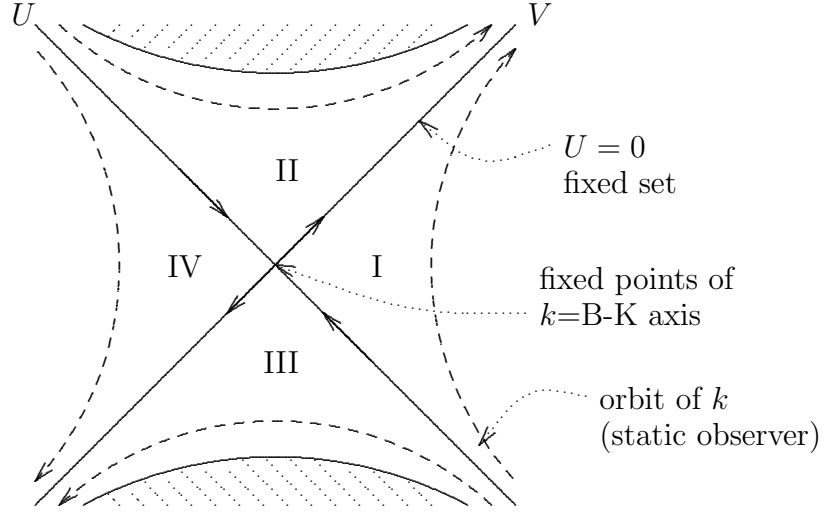

2.3.5 Null Hypersurfaces

Let $S(x)$ be a smooth function of the spacetime coordinates x^μ and consider a family of hypersurfaces $S = \text{constant}$. The vector fields normal to the hypersurface are

$$l = \tilde{f}(x) (g^{\mu\nu} \partial_\nu S) \frac{\partial}{\partial x^\mu} \quad (2.64)$$

where \tilde{f} is an arbitrary non-zero function. If $l^2 = 0$ for a particular hypersurface, \mathcal{N} , in the family, then \mathcal{N} is said to be a *null hypersurface*.

Example Schwarzschild in ingoing Eddington-Finkelstein coordinates (r, v, θ, ϕ) and the surface $S = r - 2M$.

$$l = \tilde{f}(r) \left[\left(1 - \frac{2M}{r}\right) \frac{\partial S}{\partial r} \frac{\partial}{\partial r} + \frac{\partial S}{\partial r} \frac{\partial}{\partial v} + \frac{\partial S}{\partial v} \frac{\partial}{\partial r} \right] \quad (2.65)$$

$$= \tilde{f}(r) \left[\left(1 - \frac{2M}{r}\right) \frac{\partial}{\partial r} + \frac{\partial}{\partial v} \right] \quad (2.66)$$

while

$$l^2 = g^{\mu\nu} \partial_\mu S \partial_\nu S \tilde{f}^2 \quad (2.67)$$

$$= g^{rr} \tilde{f}^2 = \left(1 - \frac{2M}{r}\right) \tilde{f}^2 \quad (2.68)$$

so $r = 2M$ is a null hypersurface, and

$$l|_{r=2M} = \tilde{f} \frac{\partial}{\partial v} \quad (2.69)$$

Properties of Null Hypersurfaces

Let \mathcal{N} be a null hypersurface with normal l . A vector t , tangent to \mathcal{N} , is one for which $t \cdot l = 0$. But, since \mathcal{N} is null, $l \cdot l = 0$, so l is itself a tangent vector, i.e.

$$l^\mu = \frac{dx^\mu}{d\lambda} \quad (2.70)$$

for some null curve $x^\mu(\lambda)$ in \mathcal{N} .

Proposition The curves $x^\mu(\lambda)$ are *geodesics*.

Proof Let \mathcal{N} be the member $S = 0$ of the family of (not necessarily null) hypersurfaces $S = \text{constant}$. Then $l^\mu = \tilde{f} g^{\mu\nu} \partial_\nu S$ and hence

$$l \cdot D l^\mu = \left(l^\rho \partial_\rho \tilde{f} \right) g^{\mu\nu} \partial_\nu S + \tilde{f} g^{\mu\nu} l^\rho D_\rho \partial_\nu S \quad (2.71)$$

$$= \left(l \cdot \partial \ln \tilde{f} \right) l^\mu + \tilde{f} g^{\mu\nu} l^\rho D_\nu \partial_\rho S \quad (\text{by symmetry of } \Gamma) \quad (2.72)$$

$$= \left(\frac{d}{d\lambda} \ln \tilde{f} \right) l^\mu + l^\rho \tilde{f} D^\mu \left(\tilde{f}^{-1} l_\rho \right) \quad (2.73)$$

$$= \left(\frac{d}{d\lambda} \ln \tilde{f} \right) l^\mu + l^\rho D^\mu l_\rho - \left(\partial^\mu \ln \tilde{f} \right) l^2 \quad (2.74)$$

$$= \left(\frac{d}{d\lambda} \ln \tilde{f} \right) l^\mu + \frac{1}{2} l^{2,\mu} - \left(\partial^\mu \ln \tilde{f} \right) l^2 \quad (2.75)$$

Although $l^2|_{\mathcal{N}} = 0$ it doesn't follow that $l^{2,\mu}|_{\mathcal{N}} = 0$ unless the whole family of hypersurfaces $S = \text{constant}$ is null. However since l^2 is constant on \mathcal{N} , $t^\mu \partial_\mu l^2 = 0$ for any vector t tangent to \mathcal{N} . Thus

$$\partial_\mu l^2|_{\mathcal{N}} \propto l_\mu \quad (2.76)$$

and therefore

$$l \cdot D l^\mu|_{\mathcal{N}} \propto l^\mu \quad (2.77)$$

i.e. $x^\mu(\lambda)$ is a geodesic (with tangent l). The function \tilde{f} can be chosen such that $l \cdot D l = 0$, i.e. so that λ is an affine parameter.

Definition The null geodesics $x^\mu(\lambda)$ with affine parameter λ , for which the tangent vectors $dx^\mu/d\lambda$ are normal to a null hypersurface \mathcal{N} , are the *generators of \mathcal{N}* .

Example \mathcal{N} is $U = 0$ hypersurface of Kruskal spacetime. Normal to $U = \text{constant}$ is

$$l = -\frac{\tilde{f}r}{32M^3}e^{r/2M}\frac{\partial}{\partial V} \quad (2.78)$$

$$l|_{\mathcal{N}} = -\frac{\tilde{f}e}{16M^2}\frac{\partial}{\partial V} \quad \text{since } r = 2M \text{ on } \mathcal{N} \quad (2.79)$$

Note that $l^2 \equiv 0$, so l^2 and $l^{2,\mu}$ both vanish on \mathcal{N} ; this is because $U = \text{constant}$ is null for *any* constant, not just zero. thus $l \cdot Dl = 0$ if \tilde{f} is *constant*. Choose $\tilde{f} = -16M^2e^{-1}$. Then

$$l = \frac{\partial}{\partial V} \quad (2.80)$$

is normal to $U = 0$ and V is an affine parameter for the generator of this null hypersurface.

2.3.6 Killing Horizons

Definition A null hypersurface \mathcal{N} is a Killing horizon of a Killing vector field ξ if, on \mathcal{N} , ξ is normal to \mathcal{N} .

Let l be normal to \mathcal{N} such that $l \cdot Dl^\mu = 0$ (affine parameterization). Then, since, on \mathcal{N} ,

$$\xi = fl \quad (2.81)$$

for some function f , it follows that

$$\boxed{\xi \cdot D\xi^\mu = \kappa\xi^\mu, \quad \text{on } \mathcal{N}} \quad (2.82)$$

where $\kappa = \xi \cdot \partial \ln |f|$ is called the *surface gravity*.

Formula for surface gravity

Since ξ is normal to \mathcal{N} , *Frobenius' theorem* implies that

$$\boxed{\xi_{[\mu}D_\nu\xi_{\rho]}|_{\mathcal{N}} = 0} \quad (2.83)$$

where ‘[]’ indicates total anti-symmetry in the enclosed indices, μ, ν, ρ . For a Killing vector field ξ , $D_\mu \xi_\nu = D_{[\mu} \xi_{\nu]}$ (i.e. symmetric part of $D_\mu \xi_\nu$ vanishes). In this case (2.83) can be written as

$$\xi_\rho D_\mu \xi_\nu|_{\mathcal{N}} + (\xi_\mu D_\nu \xi_\rho - \xi_\nu D_\mu \xi_\rho)|_{\mathcal{N}} = 0 \quad (2.84)$$

Multiply by $D^\mu \xi^\nu$ to get

$$\xi_\rho (D^\mu \xi^\nu) (D_\mu \xi_\nu)|_{\mathcal{N}} = -2 (D^\mu \xi^\nu) \xi_\mu (D_\nu \xi_\rho)|_{\mathcal{N}} \quad (\text{since } D^\mu \xi^\nu = D^{[\mu} \xi^{\nu]}) \quad (2.85)$$

or

$$\xi_\rho (D^\mu \xi^\nu) (D_\mu \xi_\nu)|_{\mathcal{N}} = -2 (\xi \cdot D \xi^\nu) D_\nu \xi_\rho|_{\mathcal{N}} \quad (2.86)$$

$$= -2\kappa \xi \cdot D \xi_\rho|_{\mathcal{N}} \quad (\text{for Killing horizon}) \quad (2.87)$$

$$= -2\kappa^2 \xi_\rho|_{\mathcal{N}} \quad (2.88)$$

Hence, except at points for which $\xi = 0$,

$$\boxed{\kappa^2 = -\frac{1}{2} (D^\mu \xi^\nu) (D_\mu \xi_\nu)|_{\mathcal{N}}} \quad (2.89)$$

It will turn out that all points at which $\xi = 0$ are limit points of orbits of ξ for which $\xi \neq 0$, so continuity implies that this formula is valid even when $\xi = 0$ (Note that $\xi = 0 \not\Rightarrow D_\mu \xi_\nu = 0$).

Killing Vector Lemma For a Killing vector field ξ

$$\boxed{D_\rho D_\mu \xi^\nu = R^\nu{}_{\mu\rho\sigma} \xi^\sigma} \quad (2.90)$$

where $R^\nu{}_{\mu\rho\sigma}$ is the Riemann tensor.

Proof: Exercise (Question II.1)

Proposition κ is constant on orbits of ξ .

Proof Let t be tangent to \mathcal{N} . Then, since (2.89) is valid everywhere on \mathcal{N}

$$t \cdot \partial \kappa^2 = - (D^\mu \xi^\nu) t^\rho D_\rho D_\mu \xi_\nu|_{\mathcal{N}} \quad (2.91)$$

$$= - (D^\mu \xi^\nu) t^\rho R_{\nu\mu\rho}{}^\sigma \xi_\sigma \quad (\text{using Lemma}) \quad (2.92)$$

Now, ξ is tangent to \mathcal{N} (in addition to being normal to it). Choosing $t = \xi$ we have

$$\xi \cdot \partial \kappa^2 = -(D^\mu \xi^\nu) R_{\nu\mu\rho\sigma} \xi^\rho \xi^\sigma \quad (2.93)$$

$$= 0 \quad (\text{since } R_{\nu\mu\rho\sigma} = -R_{\nu\mu\sigma\rho}) \quad (2.94)$$

so κ is constant on orbits of ξ .

Non-degenerate Killing horizons ($\kappa \neq 0$)

Suppose $\kappa \neq 0$ on one orbit of ξ in \mathcal{N} . Then this orbit coincides with only *part* of a null generator of \mathcal{N} . To see this, choose coordinates on \mathcal{N} such that

$$\xi = \frac{\partial}{\partial \alpha} \quad (\text{except at points where } \xi = 0) \quad (2.95)$$

i.e. such that the group parameter α is one of the coordinates. Then if $\alpha = \alpha(\lambda)$ on an orbit of ξ with an affine parameter λ

$$\xi|_{\text{orbit}} = \frac{d\lambda}{d\alpha} \frac{d}{d\lambda} = fl \quad \begin{cases} f = \frac{d\lambda}{d\alpha} \\ l = \frac{d}{d\lambda} = \frac{dx^\mu(\lambda)}{d\lambda} \partial_\mu \end{cases} \quad (2.96)$$

Now

$$\frac{\partial}{\partial \alpha} \ln |f| = \kappa \quad (2.97)$$

where κ is *constant* for orbit on \mathcal{N} . For such orbits, $f = f_0 e^{\kappa\alpha}$ for arbitrary constant f_0 . Because of freedom to shift α by a constant we can choose $f_0 = \pm\kappa$ without loss of generality, i.e.

$$\frac{d\lambda}{d\alpha} = \pm\kappa e^{\kappa\alpha} \quad \Rightarrow \quad \lambda = \pm e^{\kappa\alpha} + \text{constant} \quad (2.98)$$

Choose constant = 0

$$\boxed{\lambda = \pm e^{\kappa\alpha}} \quad (2.99)$$

As α ranges from $-\infty$ to ∞ we cover the $\lambda > 0$ or the $\lambda < 0$ portion of the generator of \mathcal{N} (geodesic in \mathcal{N} with normal l). The bifurcation point $\lambda = 0$ is a fixed point of ξ , which can be shown to be a 2-sphere, called the bifurcation 2-sphere, (BK-axis for Kruskal).

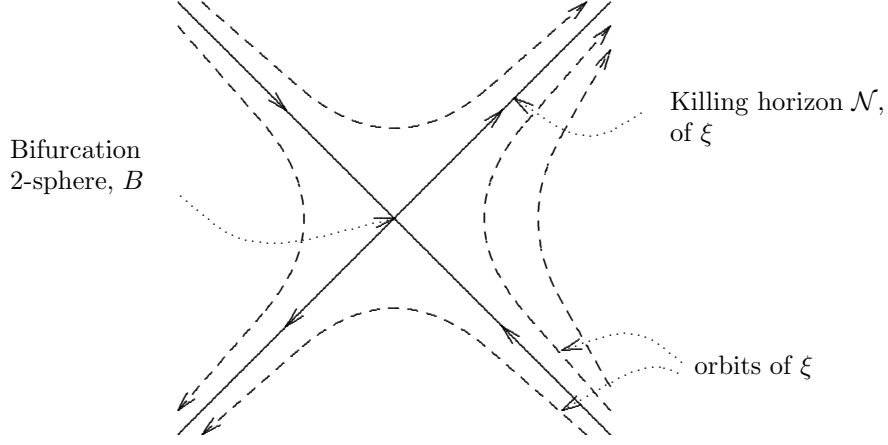

This is called a *bifurcate Killing horizon*.

Proposition If \mathcal{N} is a bifurcate Killing horizon of ξ , with bifurcation 2-sphere, B , then κ^2 is constant on \mathcal{N} .

Proof κ^2 is constant on each orbit of ξ . The value of this constant is the value of κ^2 at the limit point of the orbit on B , so κ^2 is constant on \mathcal{N} if it is constant on B . But we saw previously that

$$t \cdot \partial \kappa^2 = - (D^\mu \xi^\nu) t^\rho R_{\nu\mu\rho}{}^\sigma \xi_\sigma|_{\mathcal{N}} \quad (2.100)$$

$$= 0 \quad \text{on } B \text{ since } \xi_\sigma|_B = 0 \quad (2.101)$$

Since t can be any tangent to B , κ^2 is constant on B , and hence on \mathcal{N} .

Example \mathcal{N} is $\{U = 0\} \cup \{V = 0\}$ of Kruskal spacetime, and $\xi = k$, the time-translation Killing vector field.

On \mathcal{N} ,

$$k = \left\{ \begin{array}{l} \frac{1}{4M} V \frac{\partial}{\partial V} \quad \text{on } \{U = 0\} \\ -\frac{1}{4M} U \frac{\partial}{\partial U} \quad \text{on } \{V = 0\} \end{array} \right\} = fl \quad (2.102)$$

where

$$f = \left\{ \begin{array}{l} \frac{1}{4M} V \quad \text{on } \{U = 0\} \\ -\frac{1}{4M} U \quad \text{on } \{V = 0\} \end{array} \right\}, \quad l = \left\{ \begin{array}{l} \frac{\partial}{\partial V} \quad \text{on } \{U = 0\} \\ \frac{\partial}{\partial U} \quad \text{on } \{V = 0\} \end{array} \right\} \quad (2.103)$$

Since l is normal to \mathcal{N} , \mathcal{N} is a Killing horizon of k . Since $l \cdot Dl = 0$, the surface gravity is

$$\kappa = k \cdot \partial \ln |f| = \begin{cases} \frac{1}{4M} V \frac{\partial}{\partial V} \ln |V| & \text{on } U = 0 \\ -\frac{1}{4M} U \frac{\partial}{\partial U} \ln |U| & \text{on } V = 0 \end{cases} \quad (2.104)$$

$$= \begin{cases} \frac{1}{4M} & \text{on } \{U = 0\} \\ -\frac{1}{4M} & \text{on } \{V = 0\} \end{cases} \quad (2.105)$$

So $\kappa^2 = 1/(4M)^2$ is indeed a constant on \mathcal{N} . Note that orbits of k lie either entirely in $\{U = 0\}$ or in $\{V = 0\}$ or are fixed points on B , which allows a difference of sign in κ on the two branches of \mathcal{N} .

[N.B. Reinstating factors of c and G , $|\kappa| = \frac{c^3}{4GM}$]

Normalization of κ

If \mathcal{N} is a Killing horizon of ξ with surface gravity κ , then it is also a Killing horizon of $c\xi$ with surface gravity $c^2\kappa$ [from formula (2.89) for κ] for any constant c . Thus surface gravity is not a property of \mathcal{N} alone, it also depends on the normalization of ξ .

There is no natural normalization of ξ on \mathcal{N} since $\xi^2 = 0$ there, but in an asymptotically flat spacetime there is a natural normalization at spatial infinity, e.g. for the time-translation Killing vector field k we choose

$$k^2 \rightarrow -1 \quad \text{as } r \rightarrow \infty \quad (2.106)$$

This fixes k , and hence κ , up to a sign, and the sign of κ is fixed by requiring k to be future-directed.

Degenerate Killing Horizon ($\kappa = 0$)

In this case, the group parameter on the horizon is also an affine parameter, so there is no bifurcation 2-sphere. More on this case later.

2.3.7 Rindler spacetime

Return to Schwarzschild solution

$$ds^2 = -\left(1 - \frac{2M}{r}\right) dt^2 + \left(1 - \frac{2M}{r}\right)^{-1} dr^2 + r^2 d\Omega^2 \quad (2.107)$$

and let

$$r - 2M = \frac{x^2}{8M} \quad (2.108)$$

Then

$$1 - \frac{2M}{r} = \frac{(\kappa x)^2}{1 + (\kappa x)^2} \quad \left(\kappa = \frac{1}{4M} \right) \quad (2.109)$$

$$\approx (\kappa x)^2 \quad \text{near } x = 0 \quad (2.110)$$

$$dr^2 = (\kappa x)^2 dx^2 \quad (2.111)$$

so for $r \approx 2M$ we have

$$ds^2 \approx \underbrace{-(\kappa x)^2 dt^2 + dx^2}_{\substack{\text{2-dim Rindler} \\ \text{spacetime}}} + \underbrace{\frac{1}{4\kappa^2} d\Omega^2}_{\substack{\text{2-sphere of} \\ \text{radius } 1/(2\kappa)}} \quad (2.112)$$

so we can expect to learn something about the spacetime near the Killing horizon at $r = 2M$ by studying the 2-dimensional *Rindler spacetime*

$$ds^2 = -(\kappa x)^2 dt^2 + dx^2 \quad (x > 0) \quad (2.113)$$

This metric is singular at $x = 0$, but this is just a coordinate singularity. To see this, introduce the Kruskal-type coordinates

$$U' = -xe^{-\kappa t}, \quad V' = xe^{\kappa t} \quad (2.114)$$

in terms of which the Rindler metric becomes

$$ds^2 = -dU' dV' \quad (2.115)$$

Now set

$$U' = T - X, \quad V' = T + X \quad (2.116)$$

to get

$$ds^2 = -dT^2 + dX^2 \quad (2.117)$$

i.e. the *Rindler spacetime is just 2-dim Minkowski in unusual coordinates*. Moreover, the Rindler coordinates with $x > 0$ cover only the $U' < 0, V' > 0$ region of 2d Minkowski

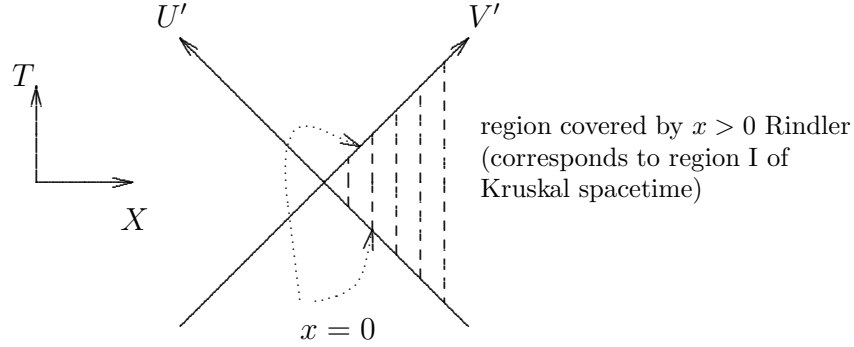

From what we know about the surface $r = 2M$ of Schwarzschild it follows that the lines $U' = 0$, $V' = 0$, i.e. $x = 0$ of Rindler is a Killing horizon of $k = \partial/\partial t$ with surface gravity $\pm\kappa$.

Exercise

- (i) Show that $U' = 0$ and $V' = 0$ are *null curves*.
- (ii) Show that

$$k = \kappa \left(V' \frac{\partial}{\partial V'} - U' \frac{\partial}{\partial U'} \right) \quad (2.118)$$

and that $k|_{U'=0}$ is normal to $U' = 0$. (So $\{U' = 0\}$ is a Killing horizon).

$$(iii) \quad (k \cdot Dk)^\mu|_{U'=0} = \kappa k^\mu|_{U'=0} \quad (2.119)$$

Note that $k^2 = -(\kappa x)^2 \rightarrow -\infty$ as $x \rightarrow \infty$, so *there is no natural normalization of k for Rindler*.

i.e. In contrast to Schwarzschild only the fact that $\kappa \neq 0$ is a property of the Killing horizon itself - the actual value of κ depends on an arbitrary normalization of k — so what is the meaning of the value of κ ?

Acceleration Horizons

Proposition The proper acceleration of a particle at $x = a^{-1}$ in Rindler spacetime (i.e. on an orbit of k) is constant and equal to a .

Proof A particle on a timelike orbit $X^\mu(\tau)$ of a Killing vector field ξ has 4-velocity

$$u^\mu = \frac{\xi^\mu}{(-\xi^2)^{1/2}} \quad (\text{since } u \propto \xi \text{ and } u \cdot u = -1) \quad (2.120)$$

Its proper 4-acceleration is

$$a^\mu = D_{(\tau)} u^\mu = u \cdot D u^\mu \quad (2.121)$$

$$= \frac{\xi \cdot D \xi^\mu}{-\xi^2} + \frac{(\xi \cdot \partial \xi^2) \xi^\mu}{2\xi^2} \quad (2.122)$$

But $\xi \cdot \partial \xi^2 = 2\xi^\mu \xi^\nu D_\mu \xi_\nu = 0$ for Killing vector field, so

$$a^\mu = \frac{\xi \cdot D \xi^\mu}{-\xi^2} \quad (2.123)$$

and ‘proper acceleration’ is magnitude $|a|$ of a^μ .

For Rindler with $\xi = k$ we have (**Exercise**)

$$a^\mu \partial_\mu = \frac{1}{U'} \frac{\partial}{\partial V'} + \frac{1}{V'} \frac{\partial}{\partial U'} \quad (2.124)$$

so

$$|a| \equiv (a^\mu a^\nu g_{\mu\nu})^{1/2} = \left(-\frac{1}{U'V'} \right)^{1/2} \quad (2.125)$$

$$= \frac{1}{x} \quad (2.126)$$

so for $x = a^{-1}$ (constant) we have $|a| = a$, i.e. *orbits of k in Rindler are worldlines of constant proper acceleration*. The acceleration increases *without bound* as $x \rightarrow 0$, so the Killing horizon at $x = 0$ is called an *acceleration horizon*.

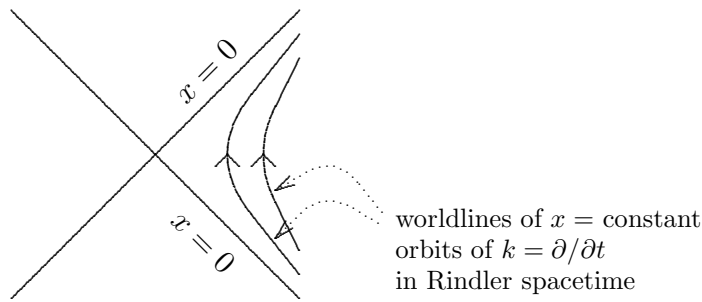

Although the *proper acceleration* of an $x = \text{constant}$ worldline diverges as $x \rightarrow 0$ its acceleration as measured by another $x = \text{constant}$ observer will remain finite. Since

$$d\tau^2 = (\kappa x)^2 dt^2 \quad (\text{for } x = a^{-1}, \text{ constant}) \quad (2.127)$$

the acceleration as measured by *an observer whose proper time is t* is

$$\left(\frac{d\tau}{dt}\right) \times \frac{1}{x} = (\kappa x) \times \frac{1}{x} = \kappa \quad (2.128)$$

which has a *finite* limit, κ , as $x \rightarrow 0$.

In Rindler spacetime such an observer is one with constant proper acceleration κ , but these observers are *in no way ‘special’* because the normalization of t was arbitrary.

$$t \rightarrow \lambda t \quad \Rightarrow \quad \kappa \rightarrow \lambda^{-1} \kappa, \quad (\lambda \in \mathbb{R}) \quad (2.129)$$

For Schwarzschild, however,

$$d\tau^2 = dt^2 \quad \Rightarrow \quad \begin{cases} r = \text{constant} \rightarrow \infty \\ \theta, \phi \text{ constant} \end{cases} \quad (2.130)$$

i.e. an observer whose proper time is t is one at spatial ∞ . Thus

surface gravity is the acceleration of a static particle near the horizon as measured at spatial infinity

This explains the term ‘surface gravity’ for κ .

2.3.8 Surface Gravity and Hawking Temperature

We can study the behaviour of QFT in a black hole spacetime using *Euclidean path integrals*. In Minkowski spacetime this involves setting

$$t = i\tau \quad (2.131)$$

and continuing τ from imaginary to real values. Thus τ is ‘imaginary time’ here (not proper time on some worldline).

In the black hole spacetime this leads to a continuation of the Schwarzschild metric to the *Euclidean Schwarzschild metric*.

$$ds_{\text{E}}^2 = \left(1 - \frac{2M}{r}\right) d\tau^2 + \frac{dr^2}{\left(1 - \frac{2M}{r}\right)} + r^2 d\Omega^2 \quad (2.132)$$

This is singular at $r = 2M$. To examine the region *near* $r = 2M$ we set

$$r - 2M = \frac{x^2}{8M} \quad (2.133)$$

to get

$$ds_{\text{E}}^2 \approx \underbrace{(\kappa x)^2 d\tau^2 + dx^2}_{\text{Euclidean Rindler}} + \frac{1}{4\kappa^2} d\Omega^2 \quad (2.134)$$

Not surprisingly, the metric near $r = 2M$ is the product of the metric on S^2 and the Euclidean Rindler spacetime

$$ds_{\text{E}}^2 = dx^2 + x^2 d(\kappa\tau)^2 \quad (2.135)$$

This is just \mathbb{E}^2 in plane polar coordinates if we make the *periodic identification*

$$\tau \sim \tau + \frac{2\pi}{\kappa} \quad (2.136)$$

i.e. the singularity of Euclidean Schwarzschild at $r = 2M$ (and of Euclidean Rindler at $x = 0$) is just a coordinate singularity provided that imaginary time coordinate τ is periodic with period $2\pi/\kappa$. This means that the Euclidean functional integral must be taken over fields $\Phi(\vec{x}, \tau)$ that are periodic in τ with period $2\pi/\kappa$ [Why this is so is not self-evident, which is presumably why the Hawking temperature was not first found this way. Closer analysis shows that the non-singularity of the Euclidean metric is required for equilibrium].

Now, the Euclidean functional integral is

$$Z = \int [\mathcal{D}\Phi] e^{-S_{\text{E}}[\Phi]} \quad (2.137)$$

where

$$S_{\text{E}} = \int dt (-ip\dot{q} + H) \quad (2.138)$$

is the Euclidean action. If the functional integral is taken over fields Φ that are periodic in imaginary time with period $\hbar\beta$ then it can be written as (see QFT course)

$$Z = \text{tr} e^{-\beta H}, \quad (2.139)$$

which is the partition function for a quantum mechanical system with Hamiltonian H at temperature T given by $\beta = (k_B T)^{-1}$ where k_B is Boltzman's

constant.

But we just saw that $\hbar\beta = 2\pi/\kappa$ for Schwarzschild, so we deduce that a QFT can be in equilibrium with a black hole only at the *Hawking temperature*

$$T_H = \frac{\kappa}{2\pi} \frac{\hbar}{k_B} \quad (2.140)$$

i.e. in units for which $\hbar = 1$, $k_B = 1$

$$\boxed{T_H = \frac{\kappa}{2\pi}} \quad (2.141)$$

N.B.

- (i) At any other temperature, Euclidean Schwarzschild has a conical singularity \rightarrow no equilibrium.
- (ii) Equilibrium at Hawking temperature is unstable since if the black hole absorbs radiation its mass increases and its temperature *decreases*, i.e. the black hole has *negative* specific heat.

2.3.9 Tolman Law - Unruh Temperature

Tolman Law The local temperature T of a static self-gravitating system in thermal equilibrium satisfies

$$(-k^2)^{1/2} T = T_0 \quad (2.142)$$

where T_0 is constant and k is the timelike Killing vector field $\partial/\partial t$. If $(k^2) \rightarrow -1$ asymptotically we can identify T_0 as the temperature ‘as seen from infinity’. For a Schwarzschild black hole we have

$$T_0 = T_H = \frac{\kappa}{2\pi} \quad (2.143)$$

Near $r = 2M$ we have, in Rindler coordinates,

$$(\kappa x)T = \frac{\kappa}{2\pi} \quad (2.144)$$

so

$$T = \frac{x^{-1}}{2\pi} \quad (2.145)$$

is the temperature measured by a static observer (on orbit of k) near the horizon. But $x = a^{-1}$, constant, for such an observer, where a is proper acceleration. So

$$T = \frac{a}{2\pi} \quad (2.146)$$

is the local (Unruh) temperature. It is a general feature of quantum mechanics (Unruh effect) that an observer accelerating in Minkowski spacetime appears to be in a heat bath at the Unruh temperature.

In Rindler spacetime the Tolman law states that

$$(\kappa x)T = T_0 \quad (2.147)$$

Since $T = x^{-1}/(2\pi)$ for $x = \text{constant}$, we deduce that $T_0 = \kappa/(2\pi)$, as in Schwarzschild, but this is now just the temperature of the observer with constant acceleration κ , who is of no particular significance. Note that in Rindler spacetime

$$T = \frac{x^{-1}}{2\pi} \rightarrow 0 \quad \text{as } x \rightarrow \infty \quad (2.148)$$

so the Hawking temperature (i.e. temperature as measured at spatial ∞) is actually zero.

This is expected because Rindler is just Minkowski in unusual coordinates, there is nothing inside which could radiate. But for a black hole

$$T_{\text{local}} \rightarrow T_H \quad \text{at infinity} \quad (2.149)$$

\Rightarrow the black hole must be radiating at this temperature. We shall confirm this later.

2.4 Carter-Penrose Diagrams

2.4.1 Conformal Compactification

A black hole is a “region of spacetime from which no signal can escape to infinity” (Penrose). This is unsatisfactory because ‘infinity’ is not part of the spacetime. However the ‘definition’ concerns the *causal structure* of spacetime which is unchanged by *conformal compactification*

$$ds^2 \rightarrow d\tilde{s}^2 = \Lambda^2(\vec{r}, t)ds^2, \quad \Lambda \neq 0 \quad (2.150)$$

We can choose Λ in such a way that all points at ∞ in the original metric are at *finite* affine parameter in the new metric. For this to happen we must choose Λ s.t.

$$\Lambda(\vec{r}, t) \rightarrow 0 \quad \text{as } |\vec{r}| \rightarrow \infty \quad \text{and/or } |t| \rightarrow \infty \quad (2.151)$$

In this case ‘infinity’ can be identified as those points (\vec{r}, t) for which $\Lambda(\vec{r}, t) = 0$. These points are not part of the original spacetime but they can be added to it to yield a *conformal compactification* of the spacetime.

Example 1

Minkowski space

$$ds^2 = -dt^2 + dr^2 + r^2 d\Omega^2 \quad (2.152)$$

Let

$$\left\{ \begin{array}{l} u = t - r \\ v = t + r \end{array} \right\} \rightarrow ds^2 = -du dv + \frac{(u - v)^2}{4} d\Omega^2 \quad (2.153)$$

Now set

$$\left\{ \begin{array}{ll} u = \tan \tilde{U} & -\pi/2 < \tilde{U} < \pi/2 \\ v = \tan \tilde{V} & -\pi/2 < \tilde{V} < \pi/2 \end{array} \right\} \begin{array}{l} \text{with } \tilde{V} \geq \tilde{U} \\ \text{since } r \geq 0 \end{array} \quad (2.154)$$

In these coordinates,

$$ds^2 = \left(2 \cos \tilde{U} \cos \tilde{V}\right)^{-2} \left[-4d\tilde{U} d\tilde{V} + \sin^2(\tilde{V} - \tilde{U}) d\Omega^2\right] \quad (2.155)$$

To approach ∞ in this metric we must take $|\tilde{U}| \rightarrow \pi/2$ or $|\tilde{V}| \rightarrow \pi/2$, so by choosing

$$\Lambda = 2 \cos \tilde{U} \cos \tilde{V} \quad (2.156)$$

we bring these points to finite affine parameter in the new metric

$$d\tilde{s}^2 = \Lambda ds^2 = -4d\tilde{U} d\tilde{V} + \sin^2(\tilde{V} - \tilde{U}) d\Omega^2 \quad (2.157)$$

We can now add the ‘points at infinity’. Taking the restriction $\tilde{V} \geq \tilde{U}$ into account, these are

$$\begin{aligned}
\left. \begin{array}{l} \tilde{U} = -\pi/2 \\ \tilde{V} = \pi/2 \end{array} \right\} &\Leftrightarrow \left\{ \begin{array}{l} u \rightarrow -\infty \\ v \rightarrow \infty \end{array} \right\} \Leftrightarrow \left\{ \begin{array}{l} r \rightarrow \infty \\ t \text{ finite} \end{array} \right\} \text{spatial } \infty, i_0 \\
\left. \begin{array}{l} \tilde{U} = \pm\pi/2 \\ \tilde{V} = \pm\pi/2 \end{array} \right\} &\Leftrightarrow \left\{ \begin{array}{l} u \rightarrow \pm\infty \\ v \rightarrow \pm\infty \end{array} \right\} \Leftrightarrow \left\{ \begin{array}{l} t \rightarrow \pm\infty \\ r \text{ finite} \end{array} \right\} \text{past and future} \\
&\hspace{15em} \text{temporal } \infty, i_{\pm} \\
\left. \begin{array}{l} \tilde{U} = -\pi/2 \\ |\tilde{V}| \neq \pi/2 \end{array} \right\} &\Leftrightarrow \left\{ \begin{array}{l} u \rightarrow -\infty \\ v \text{ finite} \end{array} \right\} \Leftrightarrow \left\{ \begin{array}{l} r \rightarrow \infty \\ t \rightarrow -\infty \\ r+t \text{ finite} \end{array} \right\} \text{past null } \infty \\
&\hspace{15em} \mathfrak{S}^- \\
\left. \begin{array}{l} |\tilde{U}| \neq \pi/2 \\ \tilde{V} = \pi/2 \end{array} \right\} &\Leftrightarrow \left\{ \begin{array}{l} u \text{ finite} \\ v \rightarrow \infty \end{array} \right\} \Leftrightarrow \left\{ \begin{array}{l} r \rightarrow \infty \\ t \rightarrow \infty \\ r-t \text{ finite} \end{array} \right\} \text{future null } \infty \\
&\hspace{15em} \mathfrak{S}^+
\end{aligned}$$

Minkowski spacetime is conformally embedded in the new spacetime with metric $d\tilde{s}^2$ with boundary at $\Lambda = 0$.

Introducing the new time and space coordinates τ, χ by

$$\tau = \tilde{V} + \tilde{U}, \quad \chi = \tilde{V} - \tilde{U} \quad (2.158)$$

we have

$$\boxed{
\begin{aligned}
d\tilde{s}^2 &= \Lambda ds^2 = -d\tau^2 + d\chi^2 + \sin^2 \chi d\Omega^2 \\
\Lambda &= \cos \tau + \cos \chi
\end{aligned}
} \quad (2.159)$$

χ is an angular variable which must be identified modulo 2π , $\chi \sim \chi + 2\pi$. If no other restriction is placed on the ranges of τ and χ , then this metric $d\tilde{s}^2$ is that of the *Einstein Static Universe*, of topology \mathbb{R} (time) \times \mathbb{S}^3 (space).

The 2-spheres of constant $\chi \neq 0, \pi$ have radius $|\sin \chi|$ (the points $\chi = 0, \pi$ are the poles of a 3-sphere). If we represent each 2-sphere of constant χ as a point the E.S.U. can be drawn as a cylinder.

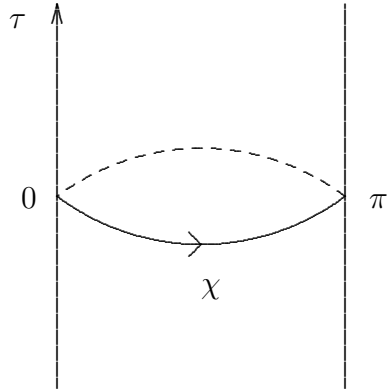

But compactified Minkowski spacetime is conformal to the triangular region

$$-\pi \leq \tau \leq \pi, \quad 0 \leq \chi \leq \pi \quad (2.160)$$

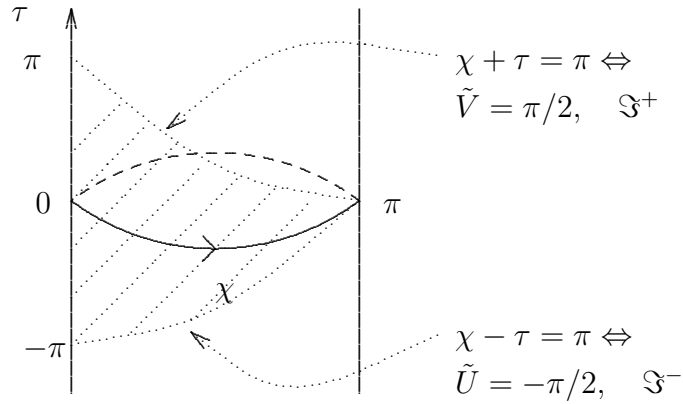

Flatten the cylinder to get the *Carter-Penrose diagram* of Minkowski spacetime.

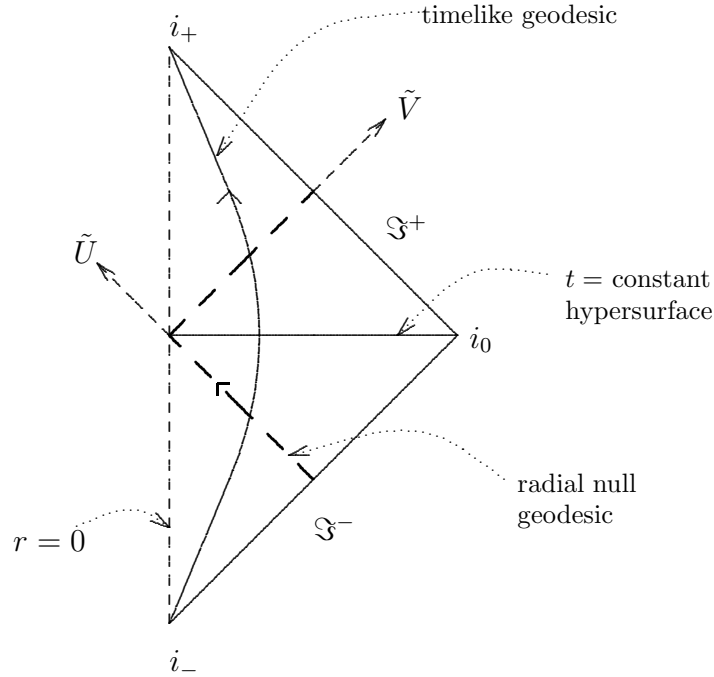

Each point represents a 2-sphere, except points on $r = 0$ and i_0, i_{\pm} . Light rays travel at 45° from \mathfrak{S}^- through $r = 0$ and then out to \mathfrak{S}^+ . [\mathfrak{S}^{\pm} are null hypersurfaces].

Spatial sections of the compactified spacetime are topologically S^3 because of the addition of the point i_0 . Thus, they are not only compact, but also have no boundary. This is not true of the whole spacetime. Asymptotically it is possible to identify points on the boundary of compactified spacetime to obtain a compact manifold without boundary (the group $U(2)$; see Question I.6). More generally, this is not possible because i_{\pm} are singular points that cannot be added (see **Example 3: Kruskal**).

Example 2: Rindler Spacetime

$$ds^2 = -dU' dV' \quad (2.161)$$

Let

$$\left. \begin{aligned} U' &= \tan \tilde{U} \\ V' &= \tan \tilde{V} \end{aligned} \right\} \begin{aligned} -\pi/2 < \tilde{U} < \pi/2 \\ -\pi/2 < \tilde{V} < \pi/2 \end{aligned} \quad (2.162)$$

Then

$$ds^2 = -(\cos \tilde{U} \cos \tilde{V})^{-2} d\tilde{U} d\tilde{V} \quad (2.163)$$

$$= \Lambda^{-2} d\tilde{s}^2 \quad (\Lambda = \cos \tilde{U} \cos \tilde{V}) \quad (2.164)$$

i.e. conformally compactified spacetime with metric $d\tilde{s}^2 = -d\tilde{U} d\tilde{V}$ is same as before but with the above *finite* ranges for coordinates \tilde{U}, \tilde{V} .

The points at infinity are those for which $\Lambda = 0$, $|\tilde{U}| = \pi/2$, $|\tilde{V}| = \pi/2$.

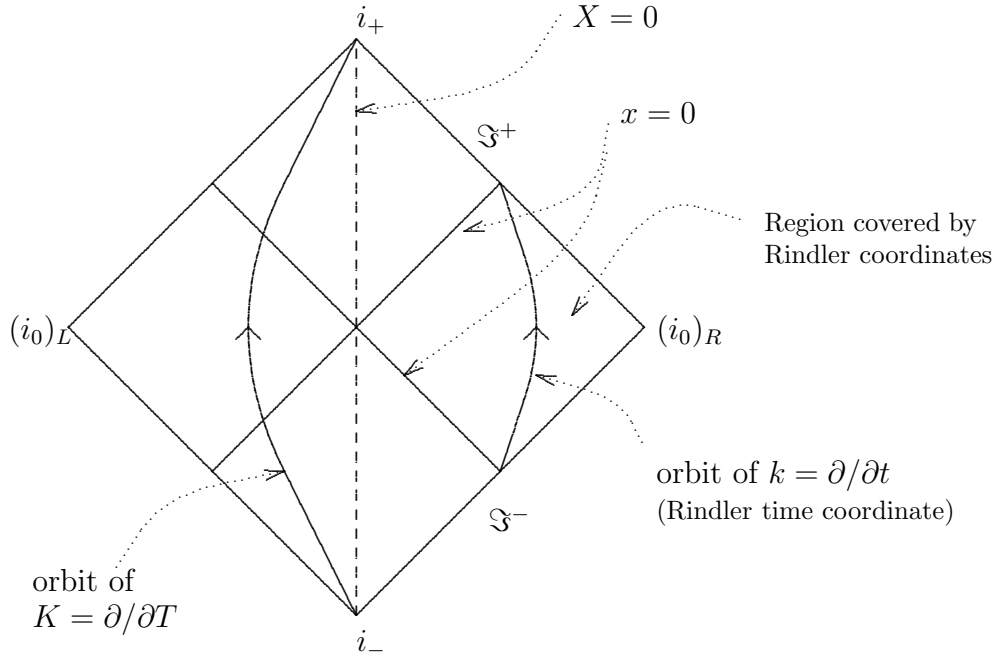

Similar to 4-dim Minkowski, but i_0 is now two points.

Example 3: Kruskal Spacetime

$$ds^2 = -\left(1 - \frac{2M}{r}\right) du dv + r^2 d\Omega^2 \quad \text{in region I} \quad (2.165)$$

Let

$$\left\{ \begin{array}{l} u = \tan \tilde{U} \quad -\pi/2 < \tilde{U} < \pi/2 \\ v = \tan \tilde{V} \quad -\pi/2 < \tilde{V} < \pi/2 \end{array} \right\} \quad (2.166)$$

Then

$$ds^2 = \left(2 \cos \tilde{U} \cos \tilde{V}\right)^{-2} \left[-4 \left(1 - \frac{2M}{r}\right) d\tilde{U} d\tilde{V} + r^2 \cos^2 \tilde{U} \cos^2 \tilde{V} d\Omega^2\right] \quad (2.167)$$

Using the fact that

$$r^* = \frac{1}{2}(v - u) = \frac{\sin(\tilde{V} - \tilde{U})}{2 \cos \tilde{U} \cos \tilde{V}} \quad (2.168)$$

we have

$$d\tilde{s}^2 = \Lambda^2 ds^2 = -4 \left(1 - \frac{2M}{r}\right) d\tilde{U} d\tilde{V} + \left(\frac{r}{r^*}\right)^2 \sin^2(\tilde{V} - \tilde{U}) d\Omega^2 \quad (2.169)$$

Kruskal is an example of an *asymptotically flat spacetime*. It approaches the metric of compactified Minkowski spacetime as $r \rightarrow \infty$ (with or without fixing t) so i_0 , and \mathfrak{S}^\pm can be added as before. Near $r = 2M$ we can introduce KS-type coordinates to pass through the horizon. In this way one can deduce that the CP diagram for the Kruskal spacetime is

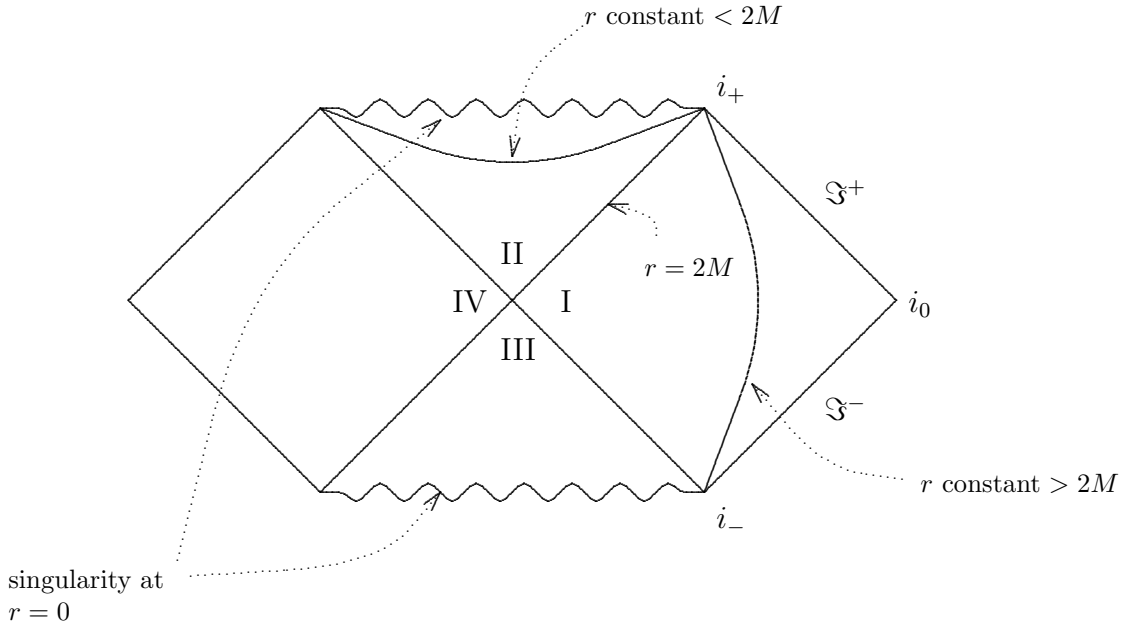

Note

- (i) All $r = \text{constant}$ hypersurfaces meet at i_+ including the $r = 0$ hypersurface, which is singular, so i_+ is a singular point. Similarly for i_- , so these points cannot be added.
- (ii) We can adjust Λ so that $r = 0$ is represented by a straight line.

In the case of a collapsing star, only that part of the CP diagram of Kruskal that is exterior to the star is relevant. The details of the interior region depend on the physics of the star. For pressure-free, spherical collapse, all parts of the star not initially at $r = 0$ reach the singularity at $r = 0$ *simultaneously*, so the CP diagram is

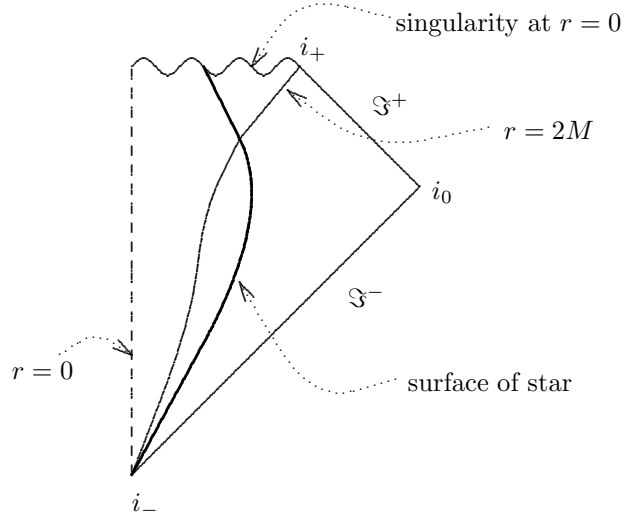

2.5 Asymptopia

A spacetime (M, g) is *asymptotically simple* if \exists a manifold $(\widetilde{M}, \widetilde{g})$ with boundary $\partial\widetilde{M} = \overline{M}$ and a continuous embedding $f(M) : M \rightarrow \widetilde{M}$ s.t.

- (i) $f(M) = \widetilde{M} - \partial\widetilde{M}$
- (ii) \exists a smooth function Λ on \widetilde{M} with $\Lambda > 0$ on $f(M)$ and $\widetilde{g} = \Lambda^2 f(g)$.
- (iii) $\Lambda = 0$ but $d\Lambda \neq 0$ on $\partial\widetilde{M}$.
- (iv) Every null geodesic in M acquires 2 endpoints on ∂M .

Example $M = \text{Minkowski}$, $\widetilde{M} = \text{compactified Minkowski}$.

Condition (iv) excludes black hole spacetime. This motivates the following definition:

A *weakly asymptotically simple* spacetime (M, g) is one for which \exists an open set $U \subset M$ that is isometric to an open neighborhood of $\partial\widetilde{M}$, where \widetilde{M} is the ‘conformal compactification’ of some asymptotically simple manifold.

Example $M = \text{Kruskal}$, \widetilde{M} its conformal ‘compactification’.

Note

- (i) \widetilde{M} is not actually compact because $\partial\widetilde{M}$ excludes i_{\pm} .
- (ii) M is not asymptotically simple because geodesics that enter $r < 2M$ cannot end on \mathfrak{S}^+ .

Asymptotic flatness

An *asymptotically flat* spacetime is one that is both weakly asymptotically simple and is *asymptotically empty* in the sense that

- (v) $R_{\mu\nu} = 0$ in an open neighborhood of ∂M in \overline{M} .

This excludes, for example, anti-de Sitter space. It also excludes spacetimes with long range electromagnetic fields that we don’t wish to exclude so condition (v) requires modification to deal with electromagnetic fields.

Asymptotically flat spacetimes have the same type of structure for \mathfrak{S}^{\pm} and i_0 as Minkowski spacetime.

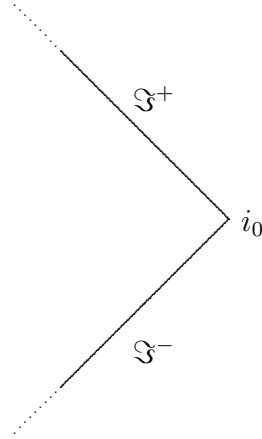

In particular they admit vectors that are asymptotic to the Killing vectors of Minkowski spacetime near i_0 , which *allows a definition of total mass, momentum and angular momentum on spacelike hypersurfaces*. The asymptotic symmetries on \mathfrak{S}^\pm are much more complicated (the ‘BMS’ group, which will not be discussed in this course).

2.6 The Event Horizon

Assume spacetime M is weakly asymptotically flat. Define

$$J^-(U)$$

to be the *causal past* of a set of points $U \subset M$ and

$$\overline{J}^-(U)$$

to be the topological closure of J^- , i.e. including limit points. Define the *boundary* of \overline{J}^- to be

$$j^-(U) = \overline{J}^-(U) - J^-(U) \tag{2.170}$$

The *future event horizon* of M is

$$\mathcal{H}^+ = j^-(\mathfrak{S}^+) \tag{2.171}$$

i.e. the *boundary of the closure of the causal past of \mathfrak{S}^+* .

Example Spacetime of a spherically-symmetric collapsing star

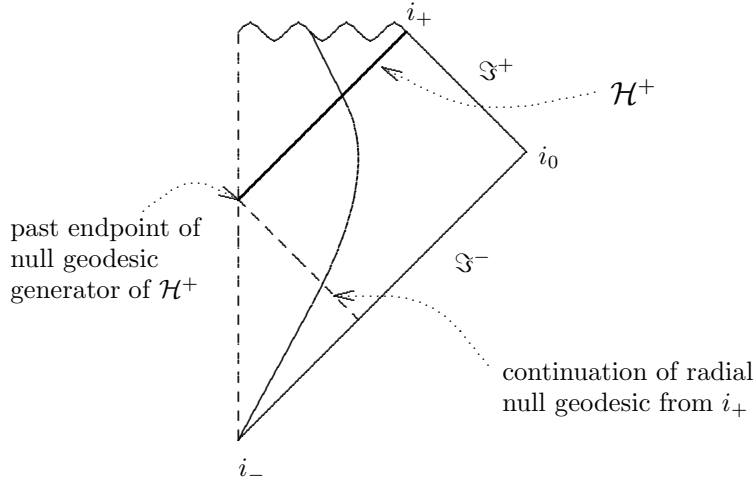

Properties of the Future Event Horizon, \mathcal{H}^+

- (i) i_0 and \mathfrak{S}^- are contained in $J^-(\mathfrak{S}^+)$, so they are not part of \mathcal{H}^+ .
- (ii) \mathcal{H}^+ is a null hypersurface.
- (iii) No two points of \mathcal{H}^+ are timelike separated. For nearby points this follows from (ii) but is also true globally. Suppose that α and β were two such points with $\alpha \in J^-(\beta)$. The timelike curve between them could then be deformed to a nearby timelike curve between α' and β' with $\beta' \in J^-(\mathfrak{S}^+)$ but $\alpha' \notin J^-(\mathfrak{S}^+)$

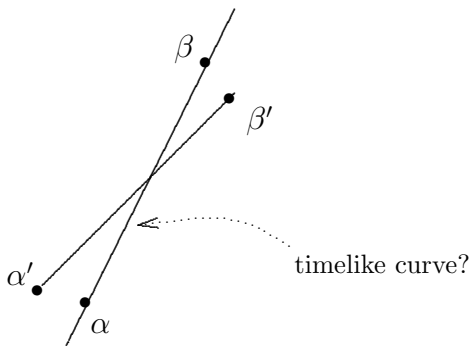

But $\alpha' \in J^-(\beta) \in J^-(\mathfrak{S}^+)$, so we have a contradiction. The timelike curve between α and β cannot exist.

- (iv) The null geodesic generators of \mathcal{H}^+ may have *past endpoints* in the sense that the continuation of the geodesic further into the past is no longer in \mathcal{H}^+ , e.g. at $r = 0$ for a spherically symmetric star, as shown in diagram above.
- (v) If a generator of \mathcal{H}^+ had a future endpoint, the future continuation of the null geodesic beyond a certain point would leave \mathcal{H}^+ . This cannot happen.

Theorem (Penrose) The generators of \mathcal{H}^+ have no future endpoints

Proof Consider the causal past $J^-(S)$ of some set S .

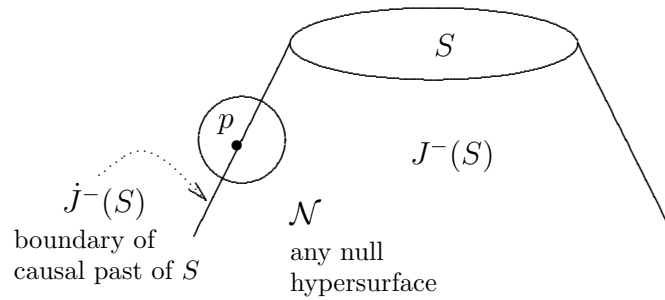

Consider a point $p \in \dot{J}^-(S)$, $p \notin S, \bar{S}$. Endpoints of the null geodesic in $\dot{J}^-(S)$ through p . Consider also an infinite sequence of timelike curves $\{\gamma_i\}$ from $p_i \in$ neighborhood of p and $\in J^-(S)$ to S s.t. p is the limit point of $\{p_i\}$ on $\dot{J}^-(S)$.

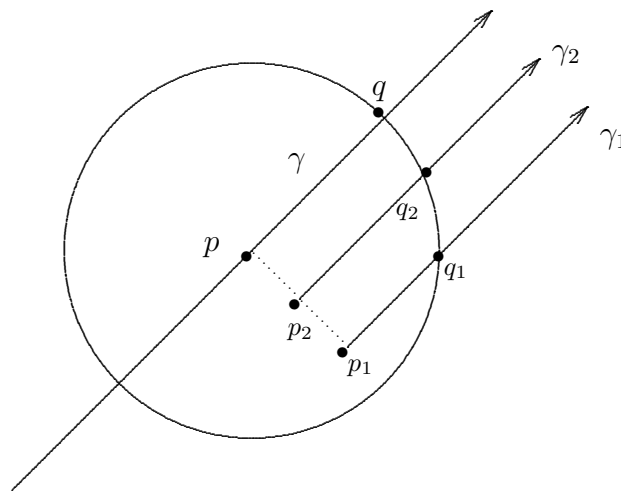

The points $\{q_i\}$ must have a limit point q on $J^-(S)$. Being the limit of timelike curves, the curve γ from p to q cannot be spacelike, but can be null (lightlike). It cannot be timelike either from property (iii) above, so it is a segment of the null geodesic generator of \mathcal{N} through p . The argument can now be repeated with p replaced by q to find another segment from q to a point, $r \in \mathcal{N}$, but further in the future. It must be a segment of the *same* generator because otherwise there exists a deformation to a timelike curve in \mathcal{N} separating p and r .

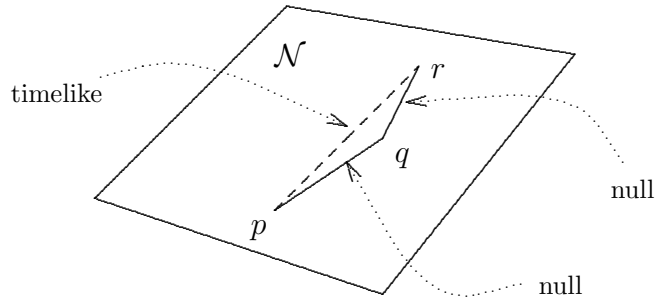

Choosing $S = \mathfrak{S}^+$, then gives Penrose's Theorem.

Properties (iv) and (v) show that *null geodesics may enter \mathcal{H}^+ but cannot leave it*.

This result may appear inconsistent with time-reversibility, but is not. The time-reverse statement is that null geodesics may leave but cannot enter the *past event horizon*, \mathcal{H}^- . \mathcal{H}^- is defined as for \mathcal{H}^+ with $J^-(\mathfrak{S}^+)$ replaced by $J^+(\mathfrak{S}^-)$, i.e. the causal future of \mathfrak{S}^- . The time-symmetric Kruskal spacetime has both a future and a past event horizon.

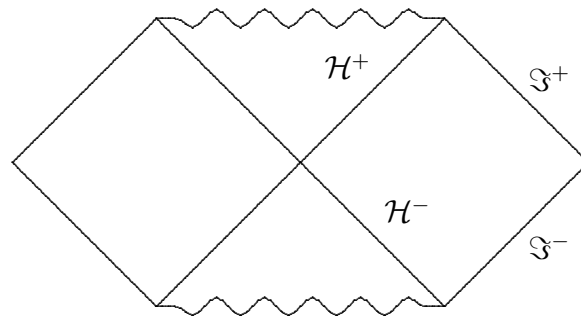

The location of the event horizon \mathcal{H}^+ generally requires knowledge of the *complete* spacetime. Its location cannot be determined by observations over

a finite time interval.

However if we wait until the black hole settles down to a stationary spacetime we can invoke:

Theorem (Hawking) The event horizon of a stationary asymptotically flat spacetime is a Killing horizon (but not necessarily of $\partial/\partial t$).

This theorem is the essential input needed in the proof of the uniqueness theorems for stationary black holes, to be considered later.

2.7 Black Holes vs. Naked Singularities

The singularity at $r = 0$ that occurs in spherically symmetric collapse is hidden in the sense that no signal from it can reach \mathfrak{S}^+ . This is not true of the Kruskal spacetime manifold since a signal from $r = 0$ in the white hole region *can* reach \mathfrak{S}^+ .

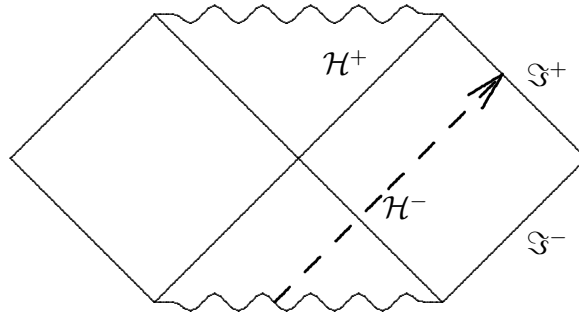

This singularity is *naked*. Another example of a naked singularity is the $M < 0$ Schwarzschild solution

$$ds^2 = - \left(1 + \frac{2|M|}{r} \right) dt^2 + \frac{1}{\left(1 + \frac{2|M|}{r} \right)} dr^2 + r^2 d\Omega^2 \quad (2.172)$$

This solves Einstein's equations so we have no a priori reason to exclude it. The CP diagram is

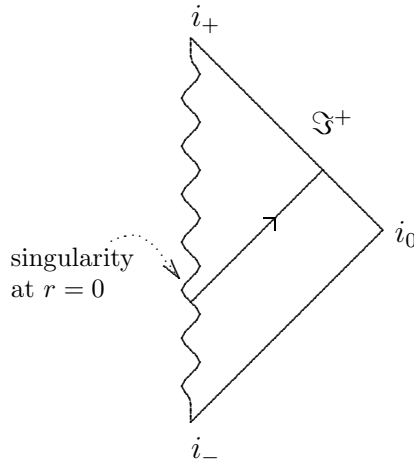

Neither of these examples is relevant to gravitational collapse, but consider the CP diagram:

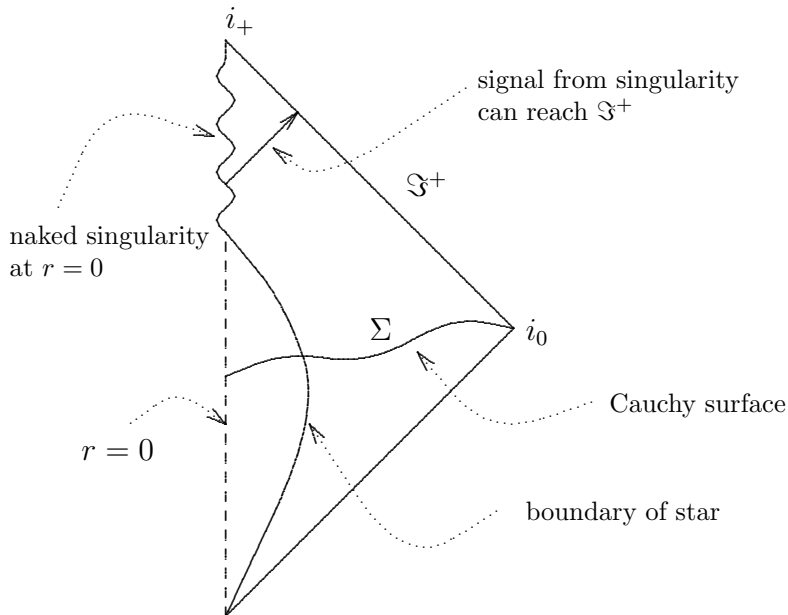

At late times the spacetime is $M < 0$ Schwarzschild but at earlier times it is non-singular. Under these circumstances it can be shown that $M \geq 0$ for physically reasonable matter (the ‘positive energy’ theorem) so the possibility illustrated by the above CP diagram (formation of a naked singularity in *spherically-symmetric* collapse) cannot occur. There remains the possibility that naked singularities could form in non-spherical collapse. If this

were to happen the future would eventually cease to be predictable from data given on an initial spacelike hypersurface (Σ in CP diagram above). There is considerable evidence that this possibility cannot be realized for physically reasonable matter, which led Penrose to suggest the:

Cosmic Censorship Conjecture ‘Naked singularities cannot form from gravitational collapse in an asymptotically flat spacetime that is non-singular on some initial spacelike hypersurface (Cauchy surface).’

Notes

- (i) Certain types of ‘trivial’ naked singularities must be excluded.
- (ii) Initial, cosmological, singularities are excluded.
- (iii) There is no proof. This is the major unsolved problem in classical G.R.

Chapter 3

Charged Black Holes

3.1 Reissner-Nordström

Consider the Einstein-Maxwell action

$$S = \frac{1}{16\pi G} \int d^4x \sqrt{-g} [R - F_{\mu\nu} F^{\mu\nu}], \quad (R = R_{\mu\nu}{}^{\mu\nu}) \quad (3.1)$$

The unusual normalization of the Maxwell term means that the magnitude of the Coulomb force between point charges Q_1, Q_2 at separation r (large) in flat space is

$$\frac{G|Q_1 Q_2|}{r^2} \quad (\text{'geometrized' units of charge}) \quad (3.2)$$

The source-free Einstein-Maxwell equations are

$$G_{\mu\nu} = 2 \left(F_{\mu\lambda} F_{\nu}{}^{\lambda} - \frac{1}{4} g_{\mu\nu} F_{\rho\sigma} F^{\rho\sigma} \right) \quad (3.3)$$

$$D_{\mu} F^{\mu\nu} = 0 \quad (3.4)$$

They have the *spherically-symmetric Reissner-Nordström* (RN) solution (which generalizes Schwarzschild)

$$ds^2 = - \left(1 - \frac{2M}{r} + \frac{Q^2}{r^2} \right) dt^2 + \frac{dr^2}{\left(1 - \frac{2M}{r} + \frac{Q^2}{r^2} \right)} + r^2 d\Omega^2 \quad (3.5)$$

$$A = \frac{Q}{r} dt \quad (\text{Maxwell 1-form potential } F = dA) \quad (3.6)$$

The parameter Q is clearly the *electric charge*.

The RN metric can be written as

$$ds^2 = -\frac{\Delta}{r^2}dt^2 + \frac{r^2}{\Delta}dr^2 + r^2d\Omega^2 \quad (3.7)$$

where

$$\Delta = r^2 - 2Mr + Q^2 = (r - r_+)(r - r_-) \quad (3.8)$$

where r_{\pm} are not necessarily real

$$r_{\pm} = M \pm \sqrt{M^2 - Q^2} \quad (3.9)$$

There are therefore 3 cases to consider:

i) $M < |Q|$

Δ has no real roots so there is no horizon and the singularity at $r = 0$ is naked.

This case is similar to $M < 0$ Schwarzschild. According to the cosmic censorship hypothesis this case could not occur in gravitational collapse. As confirmation, consider a shell of matter of charge Q and radius R in Newtonian gravity but incorporating

- a) Equivalence of inertial mass M with total energy, from special relativity.
- b) Equivalence of inertial and gravitational mass from general relativity.

$$\underbrace{M_{\text{total}}}_{\substack{\uparrow \\ \text{total energy}}} = \underbrace{M_0}_{\substack{\uparrow \\ \text{rest mass}}} + \underbrace{\frac{GQ^2}{R}}_{\substack{\uparrow \\ \text{Coulomb energy}}} - \underbrace{\frac{GM^2}{R}}_{\substack{\uparrow \\ \text{grav. binding energy} \\ (M=\text{total mass})}} \quad (3.10)$$

This is a quadratic equation for M . The solution with $M \rightarrow M_0$ as $R \rightarrow \infty$ is

$$M(R) = \frac{1}{2G} \left[(R^2 + 4GM_0R + 4G^2Q^2)^{1/2} - R \right] \quad (3.11)$$

The shell will only undergo gravitational collapse iff M decreases with decreasing R (so allowing K.E. to increase). Now

$$M' = \frac{G(M^2 - Q^2)}{2MGR + R^2} \quad (3.12)$$

so collapse occurs only if $M > |Q|$ as expected.

Now consider $M(R)$ as $R \rightarrow 0$.

$$M \longrightarrow |Q| \quad \text{independent of } M_0 \quad (3.13)$$

So GR resolves the infinite self-energy problem of point particles in classical EM. A point particle becomes an extreme ($M = |Q|$) RN black hole (case (iii) below).

Remark The electron has $M \ll |Q|$ (at least when probed at distances $\gg GM/c^2$) because the gravitational attraction is negligible compared to the Coulomb repulsion. But the electron is *intrinsically quantum mechanical*, since its Compton wavelength \gg Schwarzschild radius. Clearly the applicability of GR requires

$$\frac{\text{Compton wavelength}}{\text{Schwarzschild radius}} = \frac{\hbar/Mc}{MG/c^2} = \frac{\hbar c}{M^2 G} \ll 1 \quad (3.14)$$

i.e.

$$M \gg \left(\frac{\hbar c}{G} \right)^{1/2} \equiv M_P \quad (\text{Planck mass}) \quad (3.15)$$

This is satisfied by any macroscopic object but not by elementary particles.

More generally the domains of applicability of classical physics QFT and GR are illustrated in the following diagram.

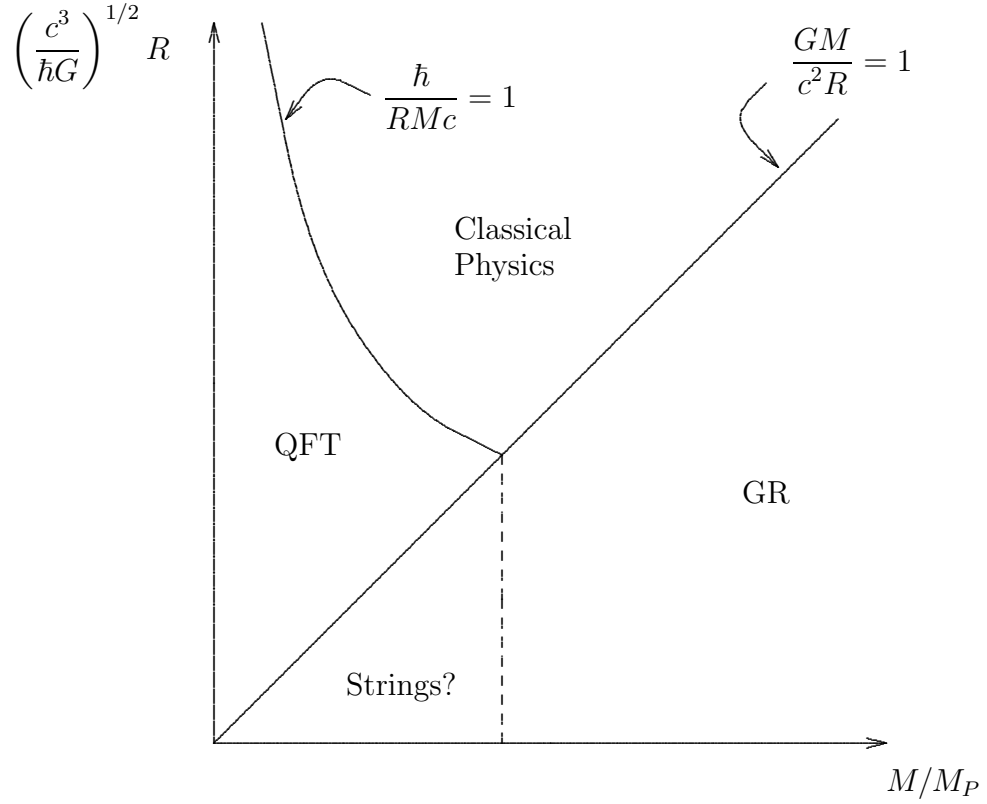

ii) $M > |Q|$

Δ vanishes at $r = r_+$ and $r = r_-$ real, so metric is singular there, but these are coordinate singularities. To see this we proceed as for $r = 2M$ in Schwarzschild. Define r^* by

$$dr^* = \frac{r^2}{\Delta} dr = \frac{dr}{\left(1 - \frac{2M}{r} + \frac{Q^2}{r^2}\right)} \quad (3.16)$$

$$\Rightarrow r^* = r + \frac{1}{2\kappa_+} \ln\left(\frac{|r - r_+|}{r_+}\right) + \frac{1}{2\kappa_-} \ln\left(\frac{|r - r_-|}{r_-}\right) + \text{const} \quad (3.17)$$

where

$$\boxed{\kappa_{\pm} = \frac{(r_{\pm} - r_{\mp})}{2r_{\pm}^2}} \quad (3.18)$$

We then introduce the radial null coordinates u, v as before

$$v = t + r^*, \quad u = t - r^* \quad (3.19)$$

The RN metric in ingoing Eddington-Finkelstein coordinates (v, r, θ, ϕ) is

$$ds^2 = -\frac{\Delta}{r^2} dv^2 + 2dv dr + r^2 d\Omega^2 \quad (3.20)$$

which is non-singular everywhere except at $r = 0$. Hence the $\Delta = 0$ singularities of RN were coordinate singularities. The hypersurfaces of constant r are null when $g^{rr} = \Delta/r^2 = 0$, i.e. when $\Delta = 0$, so $r = r_{\pm}$ are null hypersurfaces, \mathcal{N}_{\pm} .

Proposition The null hypersurfaces \mathcal{N}_{\pm} of RN are Killing horizons of the Killing vector field $k = \partial/\partial v$ (the extension of $\partial/\partial t$ in RN coordinates) with surface gravities κ_{\pm} .

Proof The normals to \mathcal{N}_{\pm} are

$$l_{\pm} = f_{\pm} \left(g^{rr} \frac{\partial}{\partial r} + g^{vr} \frac{\partial}{\partial v} \right) \Big|_{\mathcal{N}_{\pm}} = f_{\pm} \frac{\partial}{\partial v} \quad (3.21)$$

(note $g^{rr} = 0$ on \mathcal{N}_{\pm} and $g^{vr} = 1$) for some arbitrary functions f_{\pm} which we can choose s.t. $\boxed{l_{\pm} D l_{\pm}^{\mu} = 0}$ (tangent to an affinely parameterized geodesic) so

$$\frac{\partial}{\partial v} = f_{\pm}^{-1} l_{\pm} \quad (3.22)$$

which shows that \mathcal{N}_{\pm} are Killing horizons of $\frac{\partial}{\partial v}$ (This is Killing because in EF coordinates the metric is v -independent). We can interpret the LHS of this equation as a derivative w.r.t the group parameter, and the RHS as a derivative w.r.t the affine parameter. Now

$$(k \cdot Dk)^r = \Gamma^r_{vv} = -\frac{1}{2} g^{rr} g_{vv,r} = 0 \quad \text{on } \mathcal{N}_{\pm} \quad (3.23)$$

$$(k \cdot Dk)^v \Big|_{r=r_{\pm}} = \Gamma^v_{vv} = -\frac{1}{2} g^{vr} g_{vv,r} = \frac{1}{2r^2} \frac{\partial}{\partial r} \Delta \Big|_{r=r_{\pm}} \quad (3.24)$$

$$= \frac{1}{2r_{\pm}^2} (r_{\pm} - r_{\mp}) \quad \text{on } \mathcal{N}_{\pm} \quad (3.25)$$

$$= \kappa_{\pm} \quad (3.26)$$

$$\boxed{\therefore k \cdot Dk^\mu = \kappa_\pm k^\mu} \quad (3.27)$$

Since $k = \partial/\partial t$ in static coordinates we have $k^2 \rightarrow -1$ as $r \rightarrow \infty$. So we identify κ_\pm as the surface gravities of \mathcal{N}_\pm .

Each of the Killing horizons \mathcal{N}_\pm will have a bifurcation 2-sphere in the neighborhood of which we can introduce the KS-type coordinates

$$U^\pm = -e^{-\kappa_\pm u}, \quad V^\pm = e^{\kappa_\pm v} \quad (3.28)$$

For the + sign we have

$$ds^2 = -\frac{r_+ r_- e^{-2\kappa_+ r}}{\kappa_+^2 r^2} \left(\frac{r_-}{r - r_-} \right)^{\left(\frac{\kappa_+}{\kappa_-} - 1\right)} dU^+ dV^+ + r^2 d\Omega^2 \quad (3.29)$$

where $r(U^+, V^+)$ is determined implicitly by

$$U^+ V^+ = -e^{2\kappa_+ r} \left(\frac{r - r_+}{r_+} \right) \left(\frac{r - r_-}{r_-} \right)^{\kappa_+/\kappa_-} \quad (3.30)$$

This metric covers four regions of the maximal analytic extension of RN,

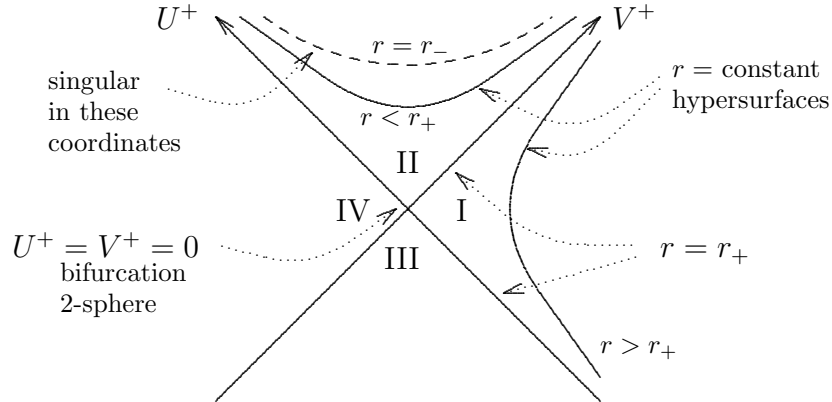

These coordinates do not cover $r \leq r_-$ because of the coordinate singularity at $r = r_-$ (and $U^+ V^+$ is complex for $r < r_-$), but $r =$

r_- and a similar four regions are covered by the (U^-V^-) KS-type coordinates to this case (Exercise).

$$\begin{aligned}
 ds^2 &= -\frac{r_+r_-}{\kappa_-^2} \frac{e^{-2\kappa_-r}}{r^2} \left(\frac{r_+}{r_+-r}\right)^{\frac{\kappa_-}{\kappa_+}-1} dU^- dV^- + r^2 d\Omega^2 \\
 U^-V^- &= -e^{-2\kappa_-r} \left(\frac{r_- - r}{r_-}\right) \left(\frac{r_+ - r}{r_+}\right)^{\kappa_-/\kappa_+}
 \end{aligned} \tag{3.32}$$

This metric covers four regions around $U^- = V^- = 0$.

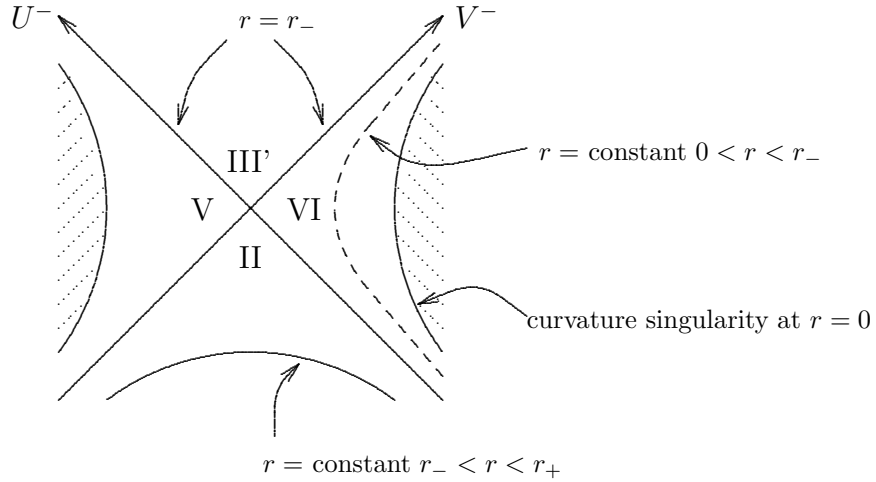

Region II is the same as the region II covered by the (U^+, V^+) coordinates. The other regions are new. Regions V and VI contain the curvature singularity at $r = 0$, which is *timelike* because the normal to $r = \text{constant}$ is spacelike for $\Delta > 0$, e.g. in $r < r_-$.

We know that region II of the diagram is connected to an exterior spacetime in the past (regions I, III, and IV), by time-reversal invariance, region III' must be connected to another exterior region (isometric regions I', II', and IV').

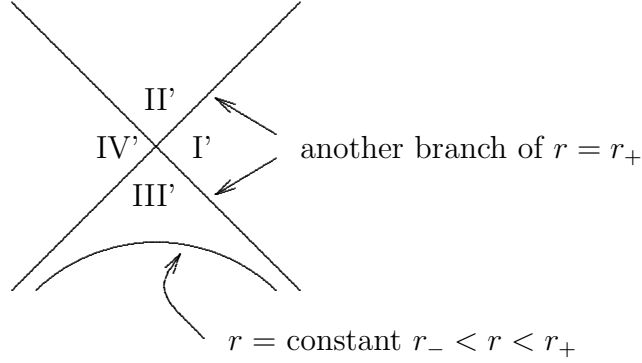

Regions I' and IV' are new asymptotically flat 'exterior' spacetimes. Continuing in this manner we can find an infinite sequence of them.

Internal Infinities

Consider a path of constant r, θ, ϕ in any region for which $\Delta < 0$, e.g. region II. In ingoing EF coordinates

$$\begin{aligned}
 ds^2 &= -\frac{\Delta}{r^2} dv^2 & (3.33) \\
 &= \frac{|\Delta|}{r^2} dv^2 \quad \text{since we are considering } \Delta < 0 \text{ by hypothesis} & (3.34)
 \end{aligned}$$

Since $ds^2 > 0$ the path is spacelike. The distance along it from $v = 0$ to $v = -\infty$ (i.e. to $V^+ = 0$ or $V^- = 0$) is

$$\begin{aligned}
 s &= \int_{-\infty}^0 \frac{|\Delta|^{1/2}}{r} dv = \frac{|\Delta|^{1/2}}{r} \int_{-\infty}^0 dv \quad \text{since } r \text{ is constant} & (3.35) \\
 &= \infty & (3.36)
 \end{aligned}$$

So there is an 'internal' spatial infinity behind the $r = r_+$ horizon. (Note that one can still reach $V^\pm = 0$ in finite proper time on a *time-like* path, so the null hypersurfaces $V^\pm = 0$ are part of the spacetime).

If all points at ∞ , external and internal, are brought to finite affine parameter by a conformal transformation, one finds the following CP diagram, which can be infinitely extended in both directions:

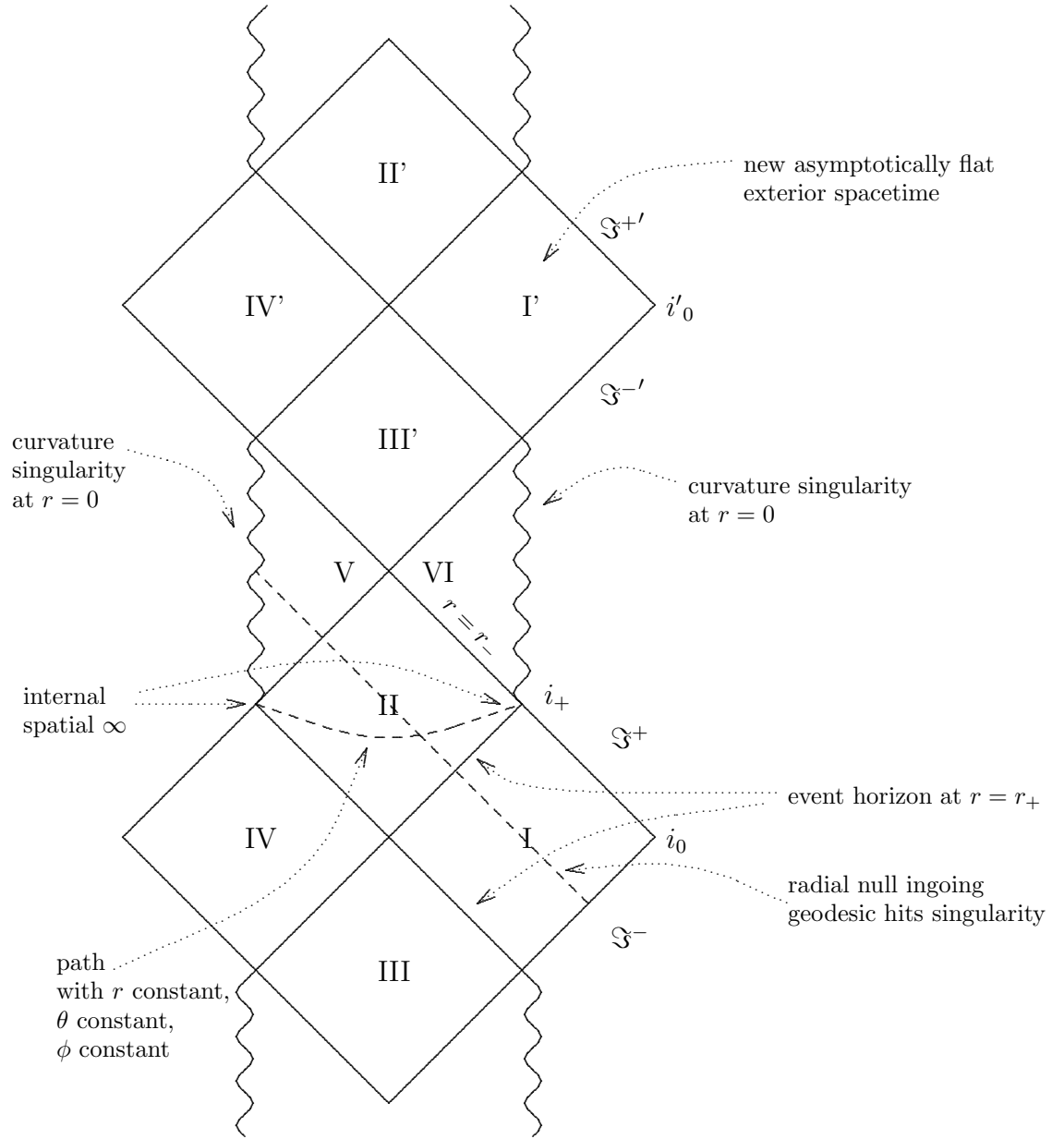

3.2 Pressure-Free Collapse to RN

Consider a spherical dust ball for which each particle of dust has charge/mass ratio

$$\gamma = \frac{Q}{M}, \quad |\gamma| < 1 \quad (3.37)$$

where Q is the total charge and M is the total mass. The exterior metric is $M > |Q|$ RN. The trajectory of a particle at the surface is the same as that of a radially infalling particle of charge/mass ratio γ in the RN spacetime. This is not a geodesic because of the additional electrostatic repulsion. From the result of Question II.4, we see that the trajectory of a point on the surface obeys

$$\left(\frac{dr}{d\tau}\right)^2 = \varepsilon^2 - V_{\text{eff}}, \quad (\varepsilon < 1) \quad (3.38)$$

where

$$V_{\text{eff}} = 1 - (1 - \varepsilon\gamma^2) \frac{2M}{r} + (1 - \gamma^2) \frac{Q^2}{r^2} \quad (3.39)$$

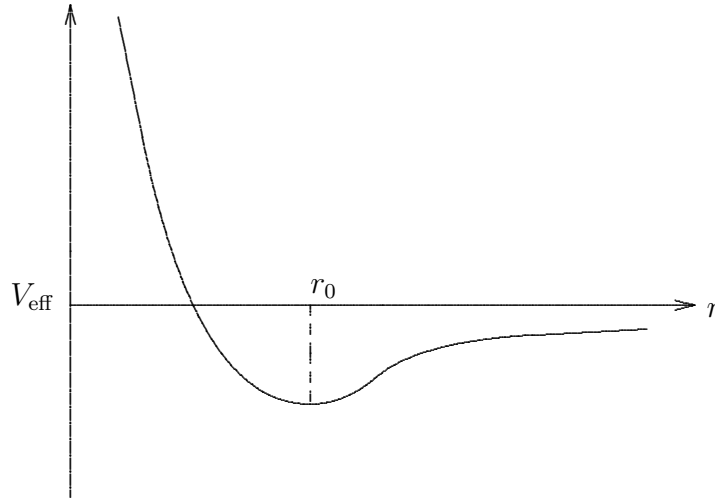

$$r_0 = \frac{(1 - \gamma^2) Q^2}{(1 - \varepsilon\gamma^2) M} = \frac{\gamma^2 (1 - \gamma^2)}{(1 - \varepsilon\gamma^2)} M \quad (3.40)$$

The collapse will therefore be halted by the electrostatic repulsion. All timelike curves that enter $r < r_+$ must continue to $r < r_-$, so the ‘bounce’ will occur in region V. The dust ball then enters region III’, explodes as a white hole into region I’ and then recollapses and re-expands indefinitely.

This is illustrated by the following CP diagram

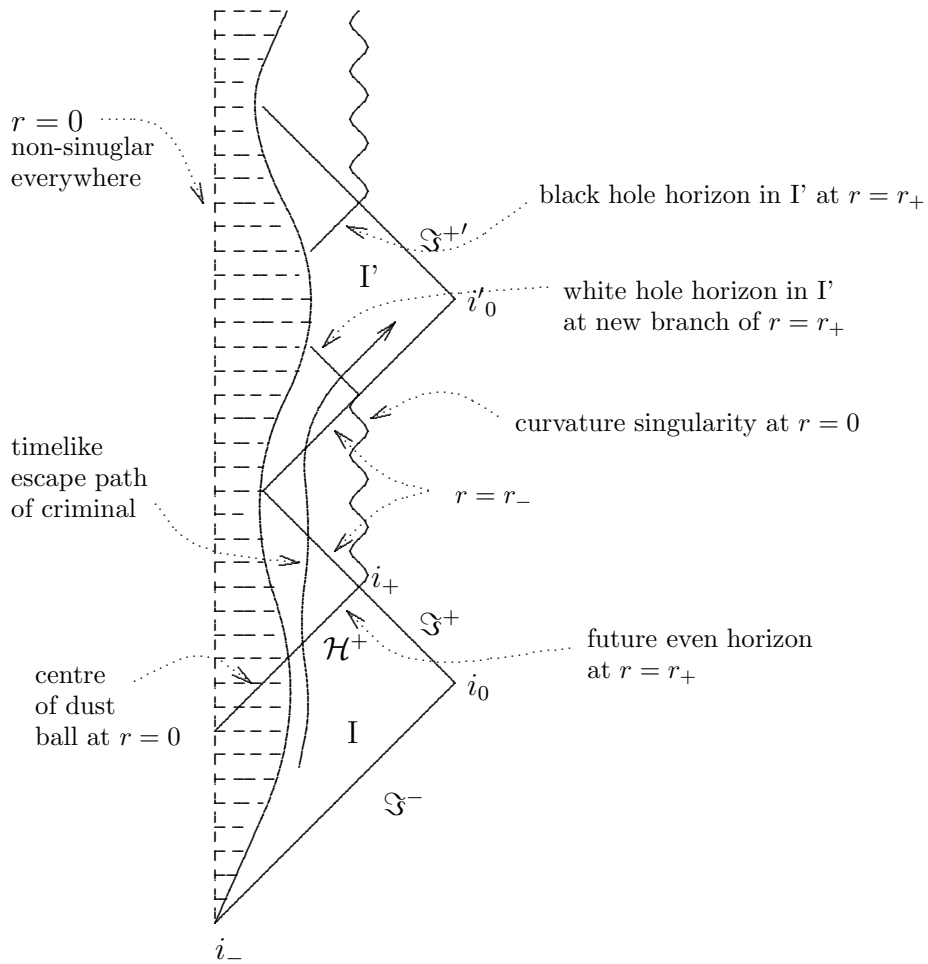

Notes

- i) No singularity is visible from \mathcal{S}^+ , in agreement with cosmic censorship.

- ii) Although the dust ball never collapses to zero size and its interior is completely non-singular, there is nevertheless a singularity behind \mathcal{H}^+ on another branch of $r = 0$, in agreement with the singularity theorems.
- iii) It seems that a criminal could escape justice in universe I by escaping on a timelike path into universe I'. Is this science fiction?

3.3 Cauchy Horizons

A particle on an ingoing radial geodesic of RN (e.g. surface of collapsing star) will 'hit' the singularity at $r = 0$, but once in region V or VI it can accelerate away from the singularity then enter the new exterior region via the white hole region III'. However, there is no way to ensure in advance of entering the black hole (e.g. by programming of rockets) that it will do so because to get to region I' it must cross a *Cauchy horizon*, a concept that will now be elaborated.

Definition A *partial Cauchy surface*, Σ , for a spacetime M is a hypersurface which no causal curve intersects more than once.

Definition A causal curve is *past-inextendable* if it has no past endpoint in M .

Definition The *future domain of dependence*, $D^+(\Sigma)$ of Σ , is the set of points $p \in M$ for which every past-inextendable causal curve through p intersects Σ .

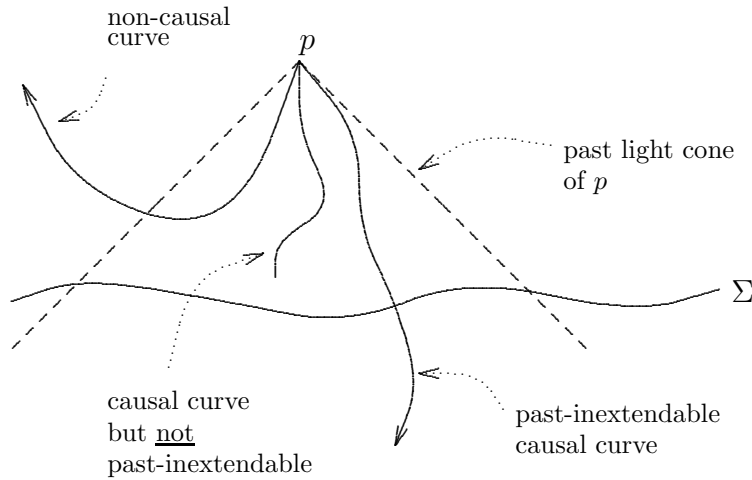

The significance of $D^+(\Sigma)$ is that the behavior of solutions of hyperbolic PDE's *outside* $D^+(\Sigma)$ is not determined by initial data on Σ .

The past domain of dependence, $D^-(\Sigma)$ of Σ , is defined similarly and Σ is said to be a *Cauchy surface* for M if

$$D^+(\Sigma) \cup D^-(\Sigma) = M \tag{3.41}$$

If M has a Cauchy surface it is said to be *globally hyperbolic*. Examples of globally hyperbolic spacetimes are

- 1) Spherical, pressure-free collapse (Schwarzschild)

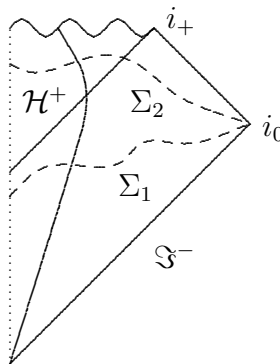

Σ_1 and Σ_2 are both Cauchy surfaces.

2) Kruskal

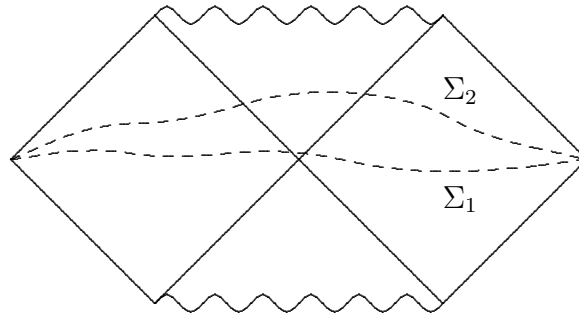

Σ_1 and Σ_2 are both Cauchy surfaces.

If M is not globally hyperbolic then $D^+(\Sigma)$ or $D^-(\Sigma)$ will have a boundary in M , called the *future or past Cauchy horizon*.

Examples

(i) Gravitationally-collapsed charged dust ball.

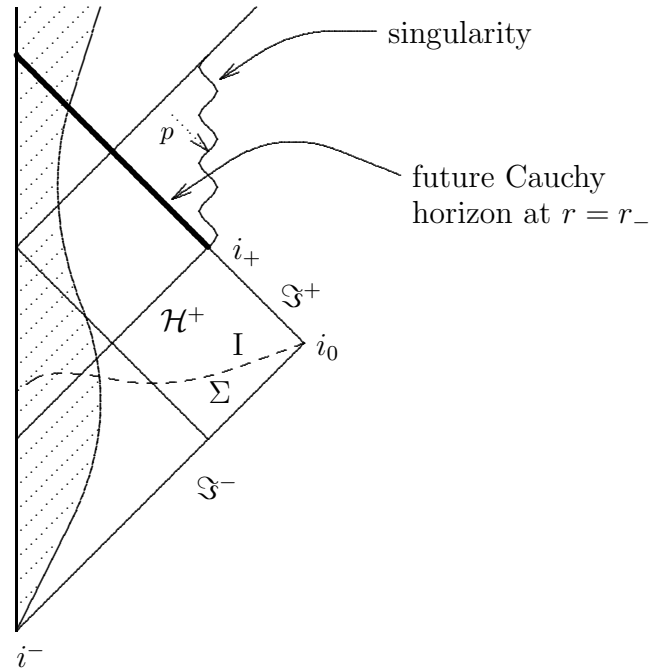

(ii) Maximal analytic extension of RN

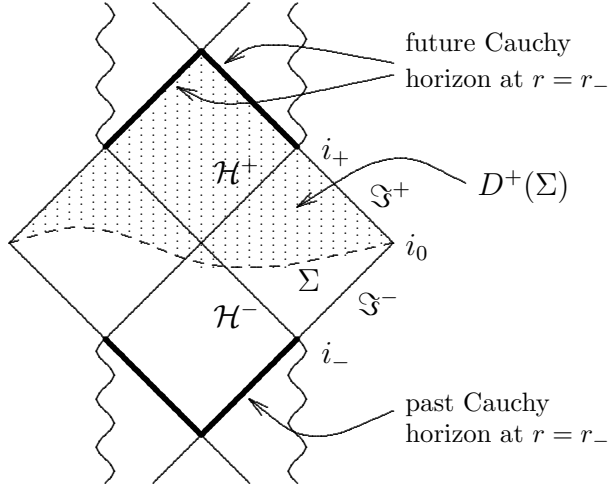

In example (i) a strange feature of the future Cauchy horizon is that the entire infinite history of the external spacetime in region I is in its causal past, i.e. visible, so signals from I must undergo an infinite blueshift as they approach the Cauchy horizon. For this reason, the Cauchy horizon usually becomes singular when subjected to any perturbation, no matter how small. For any physically realistic collapse, the Cauchy horizon is a *singular null hypersurface* for which new physics beyond GR is needed.

3.4 Isotropic Coordinates for RN

Let

$$r = \rho + M + \frac{M^2 - Q^2}{4\rho} \quad (3.42)$$

Then

$$ds^2 = -\frac{\Delta dt^2}{r^2(\rho)} + \frac{r^2(\rho)}{\rho^2} \underbrace{(d\rho^2 + \rho^2 d\Omega^2)}_{\text{flat space metric}} \quad (3.43)$$

$$\Delta = \left[\rho - \frac{(M^2 - Q^2)}{4\rho} \right]^2 \quad (3.44)$$

is RN metric in isotropic coordinates (t, ρ, θ, ϕ) . As in $Q = 0$ case, there are *two* values ρ for every value of $r > r_+$, but ρ is complex for $r < r_+$.

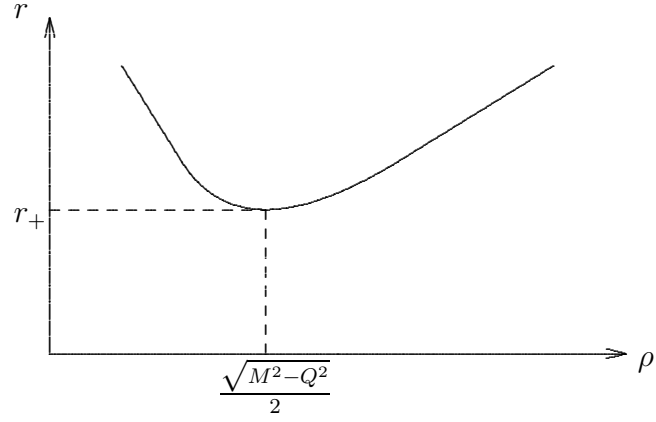

This new metric covers *two* isometric regions (I&IV) exchanged by the geometry.

$$\rho \rightarrow \frac{M^2 - Q^2}{4\rho} \quad (3.45)$$

The fixed points set at $\rho = \sqrt{M^2 - Q^2}/2$ (i.e. $r = r_+$) is a minimal 2-sphere of an ER bridge as in the $Q = 0$ case.

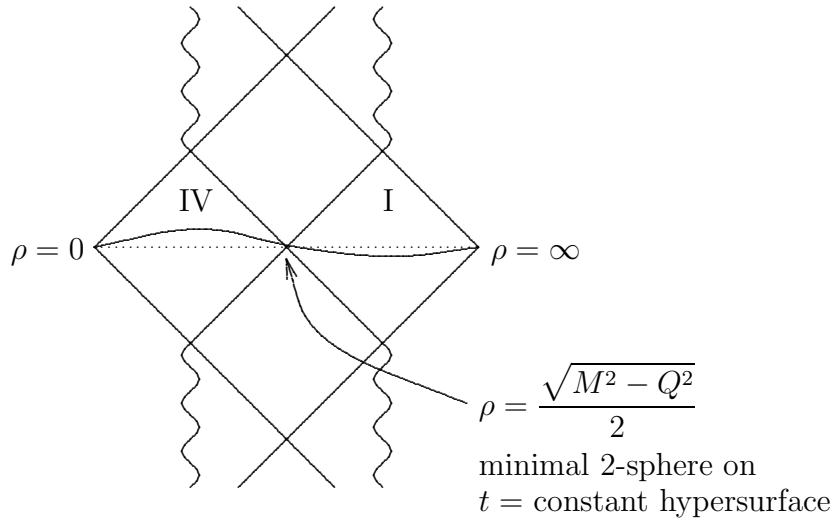

The distance to the horizon at $r = r_+$ along a curve of constant t, θ, ϕ from $r = R$ is

$$s = \int_{r_+}^R \frac{dr}{\sqrt{\left(1 - \frac{r_+}{r}\right) \left(1 - \frac{r_-}{r}\right)}} \quad (3.46)$$

$$\rightarrow \infty \quad \text{as } r_+ - r_- \rightarrow 0, \text{ i.e. as } M - |Q| \rightarrow 0 \quad (3.47)$$

so the ER bridge separating regions I & IV becomes *infinitely long* in the limit as $|Q| \rightarrow M$. In this limit, the spatial sections look like:

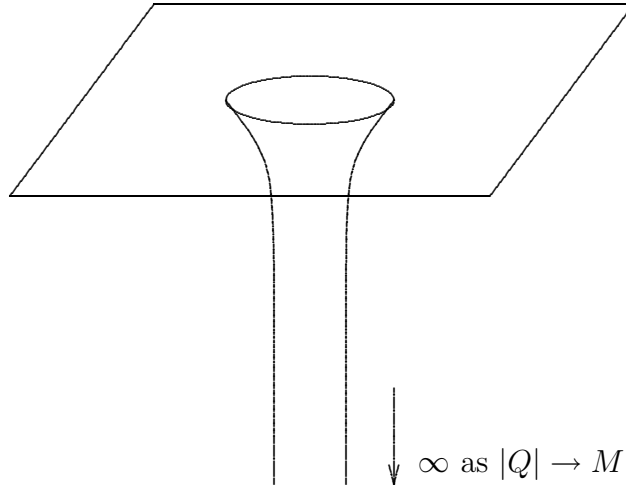

iii) $M = |Q|$ ‘Extreme’ RN ($r_{\pm} = M$)

$$ds^2 = - \left(1 - \frac{M}{r}\right)^2 dt^2 + \frac{dr^2}{\left(1 - \frac{M}{r}\right)^2} + r^2 d\Omega^2 \quad (3.48)$$

This is singular at $r = M$ so define the Regge-Wheeler coordinate

$$r^* = r + 2M \ln \left| \frac{r - M}{M} \right| - \frac{M^2}{r - M} \quad \Rightarrow \quad dr^* = \frac{dr}{1 - \frac{M}{r}} \quad (3.49)$$

and introduce ingoing EF coordinates as before. Then

$$ds^2 = - \left(1 - \frac{M}{r}\right)^2 dv^2 + 2dv dr + r^2 d\Omega^2 \quad (3.50)$$

This is non-singular on the null hypersurface $r = M$.

Proposition $r = M$ is a *degenerate* (i.e. surface gravity $\kappa = 0$) Killing horizon of the Killing vector field $k = \partial/\partial v$.

Proof From the previous calculation $l = f\partial/\partial v$ so $r = M$ is a Killing horizon of k , and $k \cdot Dk = 0$ when $r_+ = r_- = M$.

Since the orbits of k on $r = M$ are affinely parameterized they must go to infinite affine parameter in both directions \Rightarrow *internal* ∞ . This is the same internal ∞ that we find down the infinite ER bridge.

Note that k is null on $r = 2M$, but *timelike everywhere else*, so region II has disappeared and region I now leads directly to region V. The CP diagram is

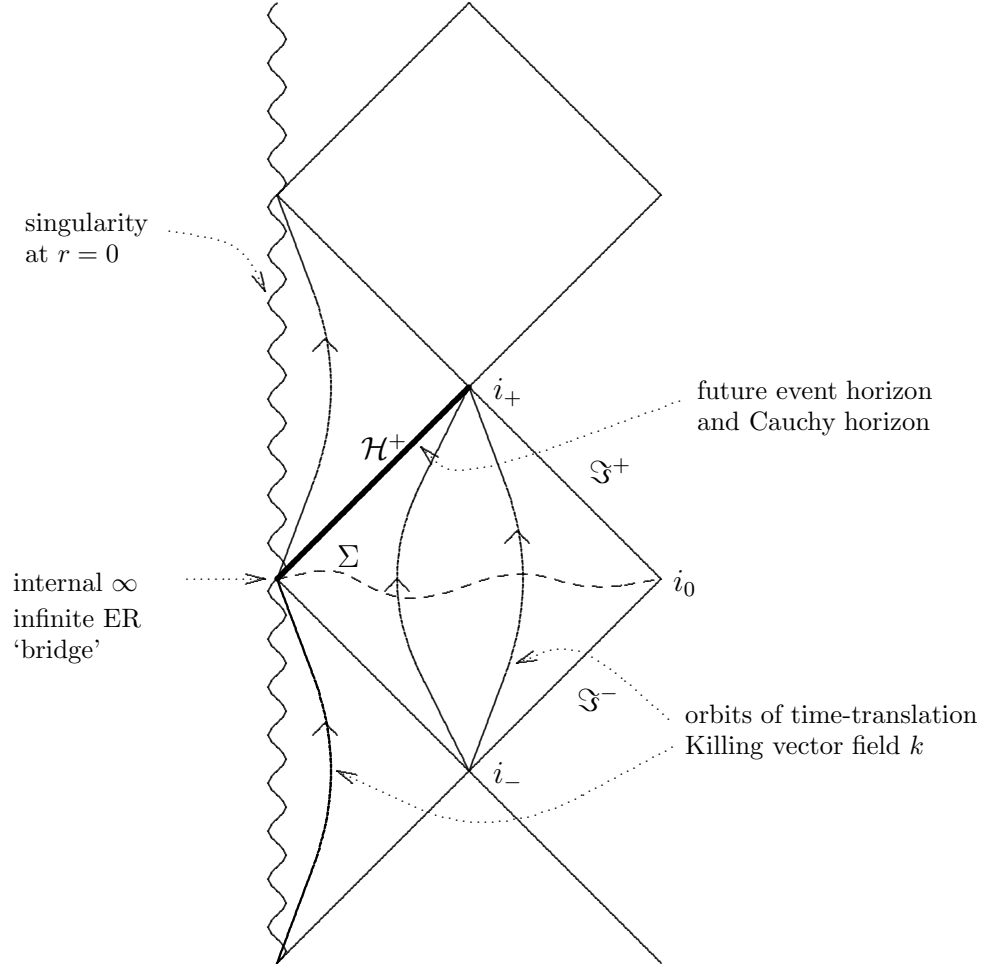

3.4.1 Nature of Internal ∞ in Extreme RN

The asymptotic metric as $r \rightarrow \infty$ is Minkowski. To determine the asymptotic metric as $r \rightarrow M$ we introduce the new coordinate λ by $r = M(1 + \lambda)$ and keep only the leading terms in λ , to get

$$F \sim d\lambda \wedge dt \quad (3.51)$$

$$ds^2 \sim \underbrace{(-\lambda^2 dt^2 + M^2 \lambda^{-2} d\lambda^2)}_{adS_2} + \underbrace{M^2 d\Omega^2}_{\substack{2\text{-sphere} \\ \text{of radius } M}} \quad (3.52)$$

This is the Robinson-Bertotti metric. It is a kind of ‘Kaluza-Klein’ vacuum in which two directions are compactified and the ‘effective’

spacetime is the two-dimensional ‘anti-de Sitter’ (adS_2) spacetime of constant negative curvature. (See Q.II.7).

3.4.2 Multi Black Hole Solutions

The extreme RN in isotropic coordinates is

$$ds^2 = V^{-2}dt^2 + V^2(d\rho^2 + \rho^2 d\Omega^2) \quad (3.53)$$

where

$$V = 1 + \frac{M}{\rho} \quad (3.54)$$

This is a special case of the multi black hole solution

$$ds^2 = V^{-2}dt^2 + V^2 d\vec{x} \cdot d\vec{x} \quad (3.55)$$

where $d\vec{x} \cdot d\vec{x}$ is the Euclidean 3-metric and V is any solution of $\nabla^2 V = 0$. In particular,

$$V = 1 + \sum_{i=1}^N \frac{M_i}{|\vec{x} - \vec{x}^i|} \quad (3.56)$$

yields the metric for N extreme black holes of masses M_i at positions \vec{x}^i . Note that the ‘points’ \vec{x}^i are actually minimal 2-spheres. There are no δ -function singularities at $x = \vec{x}^i$ because the lines of force continue indefinitely into the asymptotically RB regions (‘charge without charge’).

Note that a static multi black hole solution is possible only when there is an exact balance between the gravitational attraction and the electrostatic repulsion. This occurs only for $M = |Q|$.

Chapter 4

Rotating Black Holes

4.1 Uniqueness Theorems

4.1.1 Spacetime Symmetries

Definition An asymptotically flat spacetime is *stationary* if and only if there exists a Killing vector field, k , that is timelike near ∞ (where we may normalize it s.t. $k^2 \rightarrow -1$).

i.e. outside a possible horizon, $k = \partial/\partial t$ where t is a time coordinate. The general stationary metric in these coordinates is therefore

$$ds^2 = g_{00}(\vec{x})dt^2 + 2g_{0i}(\vec{x})dt dx^i + g_{ij}(\vec{x})dx^i dx^j \quad (4.1)$$

A stationary spacetime is *static* at least near ∞ if it is also *invariant under time-reversal*. This requires $g_{0i} = 0$, so the general static metric can be written as

$$ds^2 = g_{00}(\vec{x})dt^2 + g_{ij}(\vec{x})dx^i dx^j \quad (4.2)$$

for a static spacetime outside a possible horizon.

Definition An asymptotically flat spacetime is *axisymmetric* if there exists a Killing vector field m (an ‘axial’ Killing vector field) that is spacelike near ∞ and for which *all orbits are closed*.

We can choose coordinates such that

$$m = \frac{\partial}{\partial \phi} \quad (4.3)$$

where ϕ is a coordinate *identified modulo 2π* , such that $m^2/r^2 \rightarrow 1$ as $r \rightarrow \infty$. Thus, as for k , there is a natural choice of normalization for an axial Killing vector field in an asymptotically flat spacetime.

Birkhoff's theorem says that any spherically symmetric vacuum solution is static, which effectively implies that it must be Schwarzschild. A generalization of this theorem to the Einstein-Maxwell system shows that the only spherically symmetric solution is RN.

But suppose we know only that the metric exterior to a star is static. Unfortunately static $\not\Rightarrow$ spherical symmetry. However, if the 'star' is actually a black hole we have:

Israel's theorem If (M, g) is an asymptotically-flat, *static, vacuum* spacetime that is non-singular on and outside an event horizon, then (M, g) is Schwarzschild.

Even more remarkable is the:

Carter-Robinson theorem If (M, g) is an asymptotically-flat *stationary* and *axi-symmetric* vacuum spacetime that is non-singular on and outside an event horizon, then (M, g) is a member of the two-parameter Kerr family (given later). The parameters are the mass M and the angular momentum J .

The assumption of axi-symmetry has since been shown to be unnecessary, i.e. *for black holes, stationarity \Rightarrow axisymmetry* (Hawking, Wald).

Stationarity \Leftrightarrow equilibrium, so we expect the final state of gravitational collapse to be a stationary spacetime. The uniqueness theorems say that if the collapse is to a black hole then this spacetime is uniquely determined by its mass and angular momentum (cf. state of matter in thermal equilibrium). Thus, *all multipole moments of the gravitational field are radiated away* in the collapse to a black hole, except the monopole and dipole moments (which can't be radiated away because the graviton has spin 2).

These theorems can be generalized to 'vacuum' Einstein-Maxwell equations. The result is that a stationary black hole spacetimes must belong to the 3-parameter *Kerr-Newman family*. In *Boyer-Linquist coordinates* the KN metric is

$$\boxed{
 \begin{aligned}
 ds^2 = & -\frac{(\Delta - a^2 \sin^2 \theta)}{\Sigma} dt^2 - 2a \sin^2 \theta \frac{(r^2 + a^2 - \Delta)}{\Sigma} dt d\phi \\
 & + \left(\frac{(r^2 + a^2)^2 - \Delta a^2 \sin^2 \theta}{\Sigma} \right) \sin^2 \theta d\phi^2 + \frac{\Sigma}{\Delta} dr^2 + \Sigma d\theta^2
 \end{aligned}
 } \quad (4.4)$$

where

$$\begin{array}{l} \Sigma = r^2 + a^2 \cos^2 \theta \\ \Delta = r^2 - 2Mr + a^2 + e^2 \end{array} \quad (4.5)$$

The three parameters are M , a , and e . It can be shown that

$$a = \frac{J}{M} \quad (4.6)$$

where J is the total angular momentum, while

$$e = \sqrt{Q^2 + P^2} \quad (4.7)$$

where Q and P are the electric and magnetic (monopole) charges, respectively. The Maxwell 1-form of the KN solution is

$$A = \frac{Qr (dt - a \sin^2 \theta d\phi) - P \cos \theta [adt - (r^2 + a^2) d\phi]}{\Sigma} \quad (4.8)$$

Remarks

- (i) When $a = 0$ the KN solution reduces to the RN solution.
- (ii) Taking $\phi \rightarrow -\phi$ effectively changes the sign of a , so we may choose $a \geq 0$ without loss of generality.
- (iii) The KN solution has the discrete isometry

$$t \rightarrow -t, \quad \phi \rightarrow -\phi \quad (4.9)$$

4.2 The Kerr Solution

This is obtained from KN by setting $e = 0$. Then

$$\Delta = r^2 - 2Mr + a^2 \quad (4.10)$$

$$(\Sigma = r^2 + a^2 \cos^2 \theta) \quad (4.11)$$

The Kerr metric is important astrophysically since it is a good *approximation* to the metric of a rotating star at large distances where all multipole moments except $l = 0$ and $l = 1$ are unimportant. The only known solution of Einstein's equations for which Kerr is *exact* for $r > R$ is the Kerr solution itself (for which $T_{\mu\nu} = 0$), i.e. it has not been matched to any known non-vacuum solution that could represent the interior of a star, in contrast

to the Schwarzschild solution which is guaranteed by Birkhoff's theorem to be the exact exterior spacetime that matches on to the interior solution for any spherically symmetric star.

The Kerr metric in BL coordinates has *coordinate* singularities at

(a) $\theta = 0$ (i.e on axis of symmetry)

(b) $\Delta = 0$

Write

$$\Delta = (r - r_+) (r - r_-) \quad (4.12)$$

where

$$r_{\pm} = M \pm \sqrt{M^2 - a^2} \quad (4.13)$$

There are 3 cases to consider

- (i) $M^2 < a^2$: r_{\pm} are complex, so Δ has no real zeroes, and there are no coordinate singularities there. The metric still has a coordinate singularity at $\theta = 0$. More significantly, it has a *curvature singularity* at $\Sigma = 0$, i.e.

$$r = 0, \quad \theta = \pi/2 \quad (4.14)$$

The nature of this singularity is best seen in Kerr-Schild coordinates (\tilde{t}, x, y, z) (which also removes the coordinate singularity at $\theta = 0$). These are defined by

$$x + iy = (r + ia) \sin \theta \exp \left[i \int \left(d\phi + \frac{a}{\Delta} dr \right) \right] \quad (4.15)$$

$$z = r \cos \theta \quad (4.16)$$

$$\tilde{t} = \int \left(dt + \frac{r^2 + a^2}{\Delta} dr \right) - r \quad (4.17)$$

which implies that $r = r(x, y, z)$ is given implicitly by

$$r^4 - (x^2 + y^2 + z^2 - a^2) r^2 - a^2 z^2 = 0 \quad (4.18)$$

In these coordinates the metric is

$$ds^2 = -d\tilde{t}^2 + dx^2 + dy^2 + dz^2 \quad (4.19)$$

$$+ \frac{2Mr^3}{r^4 + a^2z^2} \left[\frac{r(x dx + y dy) - a(x dy - y dx)}{r^2 + a^2} + \frac{z dz}{r} + d\tilde{t} \right]^2$$

which shows that the spacetime is flat (Minkowski) when $M = 0$.

The surfaces of constant \tilde{t}, r are confocal ellipsoids which degenerate at $r = 0$ to the disc $z = 0, x^2 + y^2 \leq a^2$.

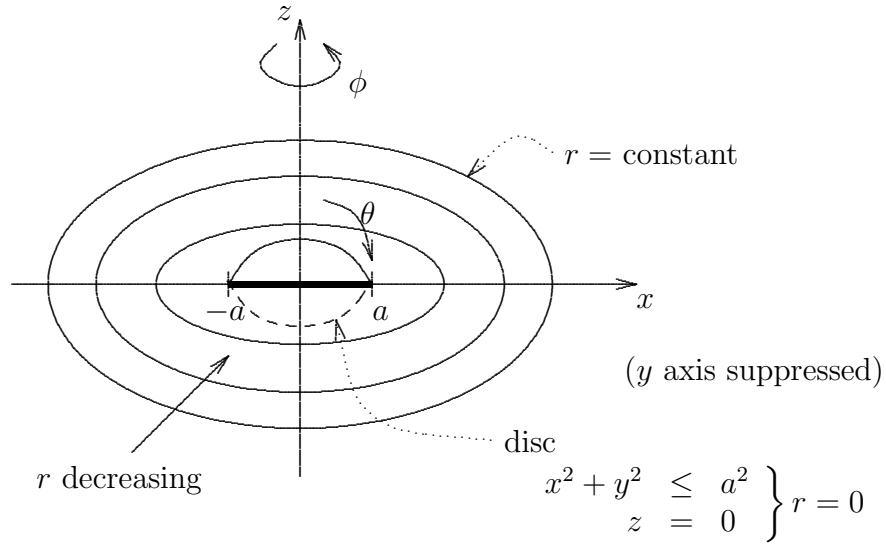

$\theta = \pi/2$ corresponds to the boundary of the disc at $x^2 + y^2 = a^2$ so the curvature singularity occurs on the boundary of the disc, i.e. on the ‘ring’

$$x^2 + y^2 = a^2, \quad z = 0 \quad (4.20)$$

There is no reason to restrict r to be positive. The spacetime can be analytically continued through the disc to another asymptotically flat region with $r < 0$.

Causal structure

Because we now have only axial symmetry we really need a 3-dim spacetime diagram to encode the causal structure, but the $\theta = 0, \pi/2$ submanifolds are *totally-geodesic*, i.e. a geodesic that is initially tangent to the submanifold remains tangent to it, so we can draw 2-dim CP diagrams for them.

$\theta = \pi/2$

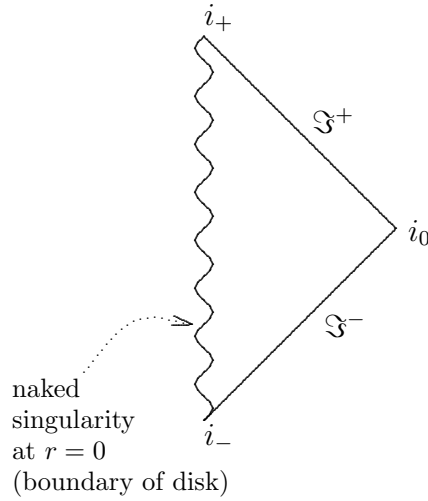

$\theta = 0$

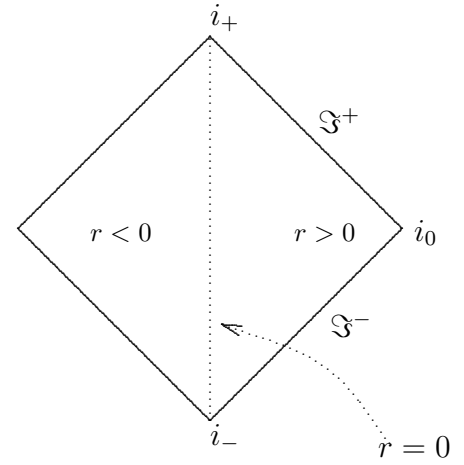

For $\theta = \pi/2$ each point in the diagram represents a circle ($0 \leq \phi < 2\pi$). Each ingoing radial geodesic hits the ring singularity at $r = 0$, which is clearly *naked*. For $\theta = 0$ we are considering only geodesics on the axis of symmetry. Ingoing radial null geodesics pass through the disc at $r = 0$ into the other region with $r < 0$. We can summarize both diagrams by the single one.

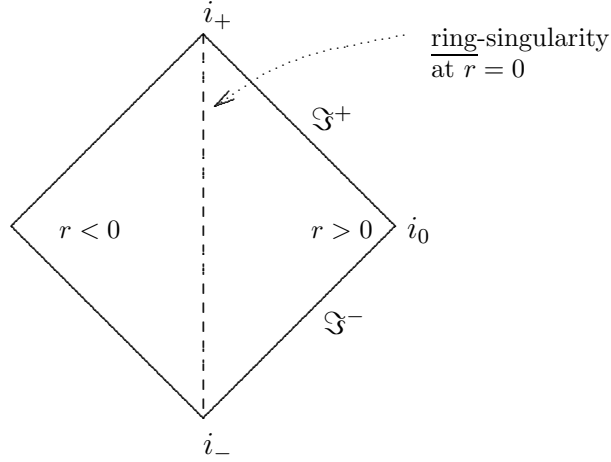

The spacetime is unphysical for another reason. Consider the norm of the Killing vector field $m = \partial/\partial\phi$:

$$m^2 = g_{\phi\phi} = a^2 \sin^2 \theta \left(1 + \frac{r^2}{a^2} \right) + \frac{Ma^2}{r} \left(\frac{2 \sin^4 \theta}{1 + \frac{a^2}{r^2} \cos^2 \theta} \right) \quad (4.21)$$

Let $r/a = \delta$ (small) and consider $\theta = \pi/2 + \delta$. Then

$$\begin{aligned} m^2 &= a^2 + \frac{Ma}{\delta} + \mathcal{O}(\delta), \quad \text{for } \delta \ll 1 \\ &< 0 \quad \text{for sufficiently small negative } \delta \end{aligned} \quad (4.22)$$

So m becomes timelike near the ring-singularity on the $r < 0$ branch. But the orbits of m are closed, so the spacetime admits closed timelike curves (CTCs). This constitute a *global violation of causality*.

Moreover because of the absence of a horizon these CTCs may be deformed to pass through *any point* of the spacetime (Carter). They also miss the singularity by a distance $\sim M$, for $M \sim a$, and M can be arbitrarily large. Since the ring singularity would be naked for $M^2 < a^2$, then even if the white hole region is replaced by a collapsing star, we can invoke cosmic censorship to rule out $M^2 < a^2$.

- (ii) $M^2 > a^2$. We still have a ring-singularity but now the metric (in BL coordinates) is singular at $r = r_+$ and $r = r_-$. These are coordinate

singularities. To see this we define new coordinates v and χ by

$$dv = dt + \frac{(r^2 - a^2)}{\Delta} dr \quad (4.23)$$

$$d\chi = d\phi + \frac{a}{\Delta} dr \quad (4.24)$$

This yields the Kerr solution in Kerr coordinates (v, r, θ, χ) which are analogous to ingoing EF for Schwarzschild:

$$\boxed{ds^2 = -\frac{(\Delta - a^2 \sin^2 \theta)}{\Sigma} dv^2 + 2dv dr - \frac{2a \sin^2 \theta (r^2 + a^2 - \Delta)}{\Sigma} dv d\chi - 2a \sin^2 \theta d\chi dr + \frac{[(r^2 + a^2)^2 - \Delta a^2 \sin^2 \theta]}{\Sigma} \sin^2 \theta d\chi^2 + \Sigma d\theta^2} \quad (4.25)$$

This metric is non singular when $\Delta = 0$, i.e. when $r = r_+$ or $r = r_-$.

Proposition The hypersurfaces $r = r_{\pm}$ are Killing horizons of the Killing vector fields

$$\xi_{\pm} = k + \left(\frac{a}{r_{\pm}^2 + a^2} \right) m \quad (4.26)$$

with surface gravities

$$\kappa_{\pm} = \frac{r_{\pm} - r_{\mp}}{2(r_{\pm}^2 + a^2)} \quad (4.27)$$

Proof Let \mathcal{N}_{\pm} be the hypersurfaces $r = r_{\pm}$. The normals are

$$\begin{aligned} l_{\pm} &= f_{\pm} g^{\mu r} |_{\mathcal{N}_{\pm}} \partial_{\mu}, \quad \text{for some non-zero functions } f_{\pm} \quad (4.28) \\ &= - \left(\frac{r_{\pm}^2 + a^2}{r_{\pm}^2 + a^2 \cos^2 \theta} \right) f_{\pm} \underbrace{\left(\frac{\partial}{\partial v} + \frac{a}{r_{\pm}^2 + a^2} \frac{\partial}{\partial \chi} \right)}_{\xi_{\pm}} \quad (\text{Ex. 4.13}) \end{aligned}$$

First

$$l_{\pm}^2 \propto \left(g_{vv} + \frac{2a}{r^2 + a^2} g_{v\chi} + \frac{a^2}{(r^2 + a^2)^2} g_{\chi\chi} \right) \Big|_{\Delta=0} = 0 \quad (4.30)$$

so \mathcal{N}_\pm are null hypersurfaces. Since $\xi_\pm|_{\mathcal{N}_\pm} \propto l_\pm$, they are Killing horizons of ξ_\pm . It remains to compute $\xi_\pm D\xi_\pm^\mu$. This gives the result for κ_\pm (Exercise).

This result can be used to find KS type coordinates that cover 4 regions around a BK axis of each Killing horizon, and the $\theta = 0$ and $\theta = \pi/2$ CP diagram of the maximal analytic extension of $M^2 > a^2$ Kerr can be found. Note that the diagram can be extended infinitely in both time directions.

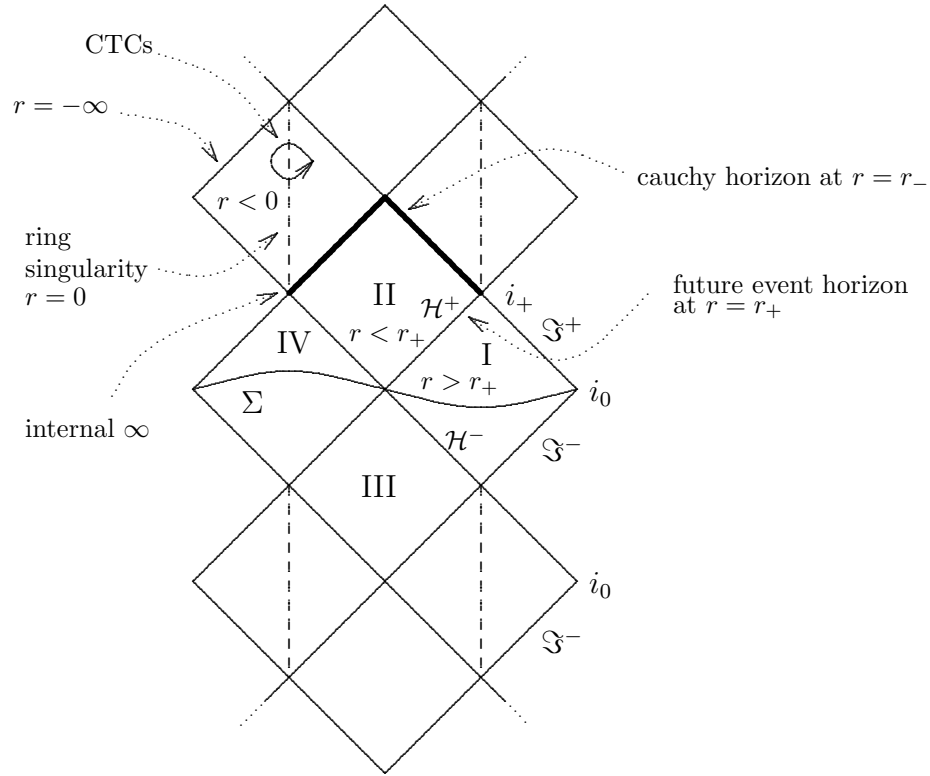

4.2.1 Angular Velocity of the Horizon

The event horizon is a Killing horizon of

$$\xi = k + \Omega_H m \tag{4.31}$$

where

$$\Omega_H = \frac{a}{r_+^2 + a^2} = \frac{J}{2M \left[M^2 + \sqrt{M^4 - J^2} \right]} \quad (4.32)$$

In coordinates for which $k = \partial/\partial t$ and $m = \partial/\partial\phi$ we have that

$$\xi^\mu \partial_\mu (\phi - \Omega_H t) = 0 \quad (4.33)$$

i.e. $\phi = \Omega_H t + \text{constant}$, on orbits of ξ , whereas ϕ is constant on orbits of k . Note that k is *unique*. Consider

$$(k + \alpha m)^2 = g_{tt} + 2\alpha g_{t\phi} + \alpha^2 g_{\phi\phi} \quad (4.34)$$

As long as $g_{t\phi}$ is finite and $g_{\phi\phi} \sim r^2$ as $r \rightarrow \infty$, we have $(k + \alpha m)^2 \sim \alpha^2 r^2 > 0$ (if $\alpha \neq 0$) as $r \rightarrow \infty$. So there can be only *one* Killing vector k that is timelike at ∞ and normalized s.t. $k^2 \rightarrow -1$ as $r \rightarrow \infty$.

Thus particles on orbits of ξ rotate with angular velocity Ω_H relative to static particles, those on orbits of k , and hence relative to a stationary frame at ∞ . Since the null geodesic generators of the horizon follow orbits of ξ the black hole is rotating with angular velocity Ω_H .

Lemma $\xi \cdot k = 0$ on a Killing horizon, \mathcal{N} , of ξ .

Proof

$$\xi \cdot k|_{\mathcal{N}} = \xi^2|_{\mathcal{N}} - \Omega_H \xi \cdot m|_{\mathcal{N}} \quad (4.35)$$

$$= -\Omega_H \xi \cdot m|_{\mathcal{N}} \quad (\text{since } \xi^2 = 0 \text{ on } \mathcal{N}) \quad (4.36)$$

Now, \mathcal{N} is a fixed point set of m , since m is Killing (Choose coordinates s.t. $m = \partial/\partial\phi$. The metric is ϕ independent, so the position of the horizon is independent of ϕ). So m must be tangent to \mathcal{N} or $l \cdot m = 0$ where l is normal to \mathcal{N} . But $\xi \propto l$ on \mathcal{N} , so $\xi \cdot m|_{\mathcal{N}} = 0$. Hence result.

Consistency checks (See Question III.3)

$\xi^2 = 0$ implies that

$$k^2 + 2\Omega_H m \cdot k - m^2 \Omega_H = 0, \quad \text{on } \mathcal{N} \quad (4.37)$$

But $\xi \cdot k = 0$ implies that

$$k^2 + \Omega_H m \cdot k = 0, \quad \text{on } \mathcal{N} \quad (4.38)$$

Consistency requires

$$D \equiv (k \cdot m)^2 - k^2 m^2|_{\mathcal{N}} = 0 \quad (4.39)$$

For Kerr, $D = \Delta \sin^2 \theta = 0$ on \mathcal{N} \square .

Also

$$\Omega_H = -\frac{k^2}{m \cdot k} = -\frac{g_{tt}}{g_{t\phi}} \Big|_{\mathcal{N}} \quad \text{in BL coordinates} \quad (4.40)$$

$$= \frac{-a^2 \sin^2 \theta}{-2a \sin^2 \theta (r_+^2 + a^2)} \quad (4.41)$$

$$= \frac{a}{r_+^2 + a^2} \quad \square. \quad (4.42)$$

(iii) $M^2 = a^2$ Extreme Kerr

In this case we have a *degenerate* ($\kappa = 0$) Killing horizon at $r = M$ of the Killing vector field

$$\xi = k + \Omega_H m, \quad \Omega_H = \frac{a}{2M} \quad (4.43)$$

The CP diagram is

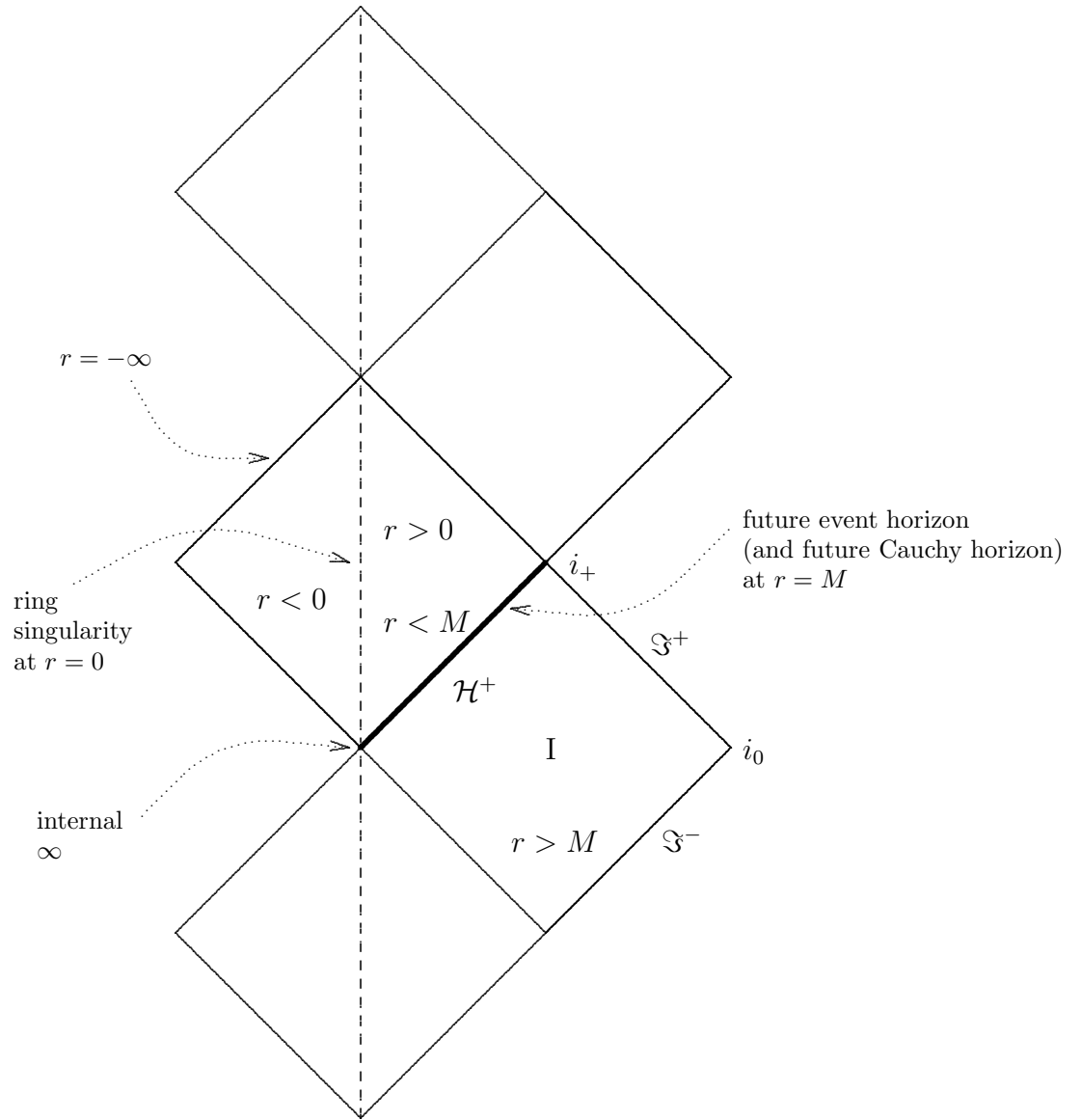

So there can be only *one* Killing vector k for which $k \cdot k \rightarrow -1$ as $r \rightarrow \infty$.

N.B. If you change the sign of r in the Kerr metric this effectively changes the sign of M .

4.3 The Ergosphere

Although k is timelike at ∞ it need not be timelike everywhere outside the horizon. For Kerr,

$$k^2 = g_{tt} = -\frac{(\Delta - a^2 \sin^2 \theta)}{\Sigma} = -\left(1 - \frac{2Mr}{r^2 + a^2 \cos^2 \theta}\right) \quad (4.44)$$

so k is timelike provided that

$$r^2 + a^2 \cos^2 \theta - 2Mr > 0 \quad (4.45)$$

For $M^2 \gg a^2$ this implies that

$$r > M + \sqrt{M^2 - a^2 \cos^2 \theta} \quad (4.46)$$

(or $r < M - \sqrt{M^2 - a^2 \cos^2 \theta}$, but this is not physically relevant).

The boundary of this region, i.e. the hypersurface

$$r = M + \sqrt{M^2 - a^2 \cos^2 \theta} \quad (4.47)$$

is the *ergosphere*. The ergosphere intersects the event horizon at $\theta = 0, \pi$, but it lies *outside* the horizon for other values of θ . Thus, k can become *spacelike in a region outside the event horizon*. This is called the *ergoregion*.

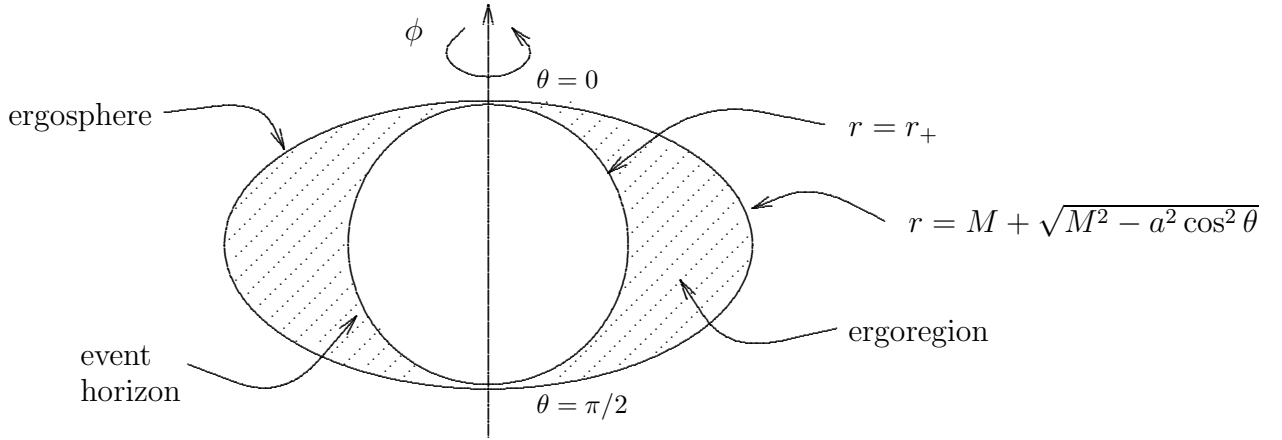

4.4 The Penrose Process

Suppose that a particle approaches a Kerr black hole along a geodesic. If p is its 4-momentum we can identify the constant of the motion

$$E = -p \cdot k \quad (4.48)$$

as its energy (since $E = p^0$ at ∞). Now suppose that the particle decays into two others, one of which falls into the hole while the other escapes to ∞ .

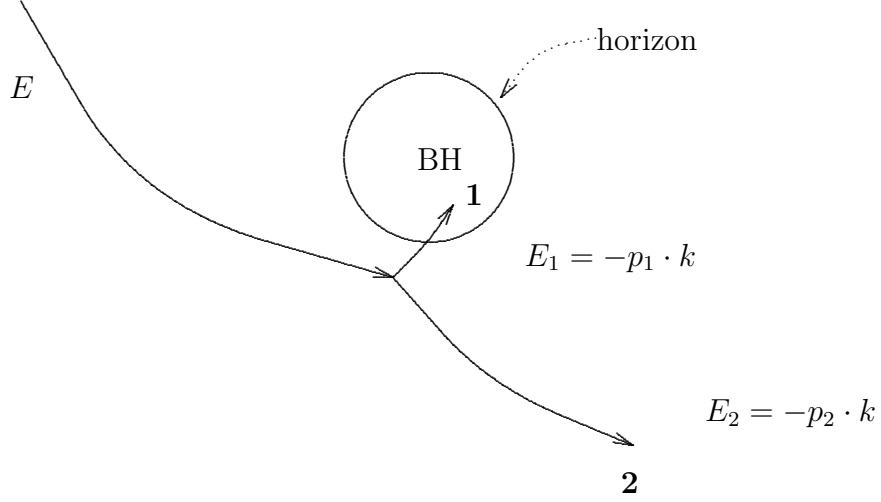

By conservation of energy

$$E_2 = E - E_1 \quad (4.49)$$

Normally $E_1 > 0$ so $E_2 < E$, but in this case

$$E_1 = -p_1 \cdot k \quad (4.50)$$

which is *not necessarily positive in the ergoregion* since k may be spacelike there. Thus, if the decay takes place in the ergoregion we may have $E_2 > E$, so *energy has been extracted from the black hole*.

4.4.1 Limits to Energy Extraction

For particles passing through the horizon at $r = r_+$ we have

$$-p \cdot \xi \geq 0 \quad (4.51)$$

Since ξ is future-directed null on the horizon and p is future-directed timelike or null. Since $\xi = k + \Omega_H m$,

$$E - \Omega_H L \geq 0 \quad (4.52)$$

where $L = p \cdot m$ is the component of the particle's angular momentum in the direction defined by m (only this component is a constant of the motion). Thus

$$L \leq \frac{E}{\Omega_H} \quad (4.53)$$

If E is negative, as it is for particle **1** in the Penrose process then L is also negative, so the hole's angular momentum is reduced. We end up with a hole of mass $M + \delta M$ and angular momentum $J + \delta J$ where $\delta M = E$ and $\delta J = L$ so

$$\delta J \leq \frac{\delta M}{\Omega_H} = \frac{2M \left(M^2 + \sqrt{M^4 - J^2} \right)}{J} \delta M \quad (4.54)$$

from formula for Ω_H . This is equivalent to (Exercise)

$$\delta \left(M^2 + \sqrt{M^4 - J^2} \right) \geq 0 \quad (4.55)$$

(This quantity must increase in the Penrose process).

Lemma $A = 8\pi \left[M^2 + \sqrt{M^4 - J^2} \right]$ is the 'area of the event horizon', of a Kerr black hole (i.e. area of intersection of \mathcal{H}^+ with partial Cauchy surface, e.g. area of $v = \text{constant}$, $r = r_+$ in Kerr coordinates (See Question III.5)).

Corollary Energy extraction by Penrose process is limited by the requirement that $\delta A \geq 0$. This is a special case of the second law of black hole mechanics.

4.4.2 Super-radiance

The Penrose process has a close analogue in the scattering of radiation by a Kerr black hole. For simplicity, consider a massless scalar field Φ . Its stress tensor is

$$T_{\mu\nu} = \partial_\mu \Phi \partial_\nu \Phi - \frac{1}{2} g_{\mu\nu} (\partial\Phi)^2 \quad (4.56)$$

Since $D_\mu T^\mu{}_\nu = 0$ we have

$$D_\mu (T^\mu{}_\nu k^\nu) = T^{\mu\nu} D_\mu k_\nu = 0 \quad (4.57)$$

so we can consider

$$j^\mu = -T^\mu{}_\nu k^\nu = -\partial^\mu \Phi k \cdot \partial\Phi + \frac{1}{2} k^\mu (\partial\Phi)^2 \quad (4.58)$$

as the future directed ($-k \cdot J > 0$) energy flux 4-vector of Φ . Now consider the following region, S , of spacetime with a null hypersurface $\mathcal{N} \subset \mathcal{H}^+$ as one boundary.

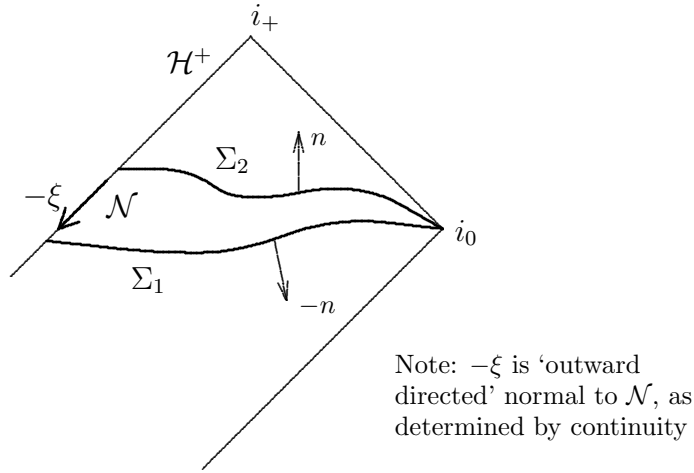

Assume that $\partial\Phi = 0$ at i_0 . Since $D_\mu j^\mu = 0$ we have

$$0 = \int_S d^4x \sqrt{-g} D_\mu j^\mu = \int_{\partial S} dS_\mu j^\mu \quad (4.59)$$

$$= \int_{\Sigma_2} dS_\mu j^\mu - \int_{\Sigma_1} dS_\mu j^\mu - \int_{\mathcal{N}} dS_\mu j^\mu \quad (4.60)$$

$$= E_2 - E_1 - \int_{\mathcal{N}} dS_\mu j^\mu \quad (4.61)$$

where E_i is the energy of the scalar field on the spacelike hypersurface Σ_i . The energy going through the horizon is therefore

$$\Delta E = E_1 - E_2 = - \int_{\mathcal{N}} dS_\mu j^\mu \quad (4.62)$$

$$= - \int dA dv \xi_\mu j^\mu, \quad (v \text{ is Kerr coordinate}) \quad (4.63)$$

The energy flux lost/unit time (power) is therefore

$$P = - \int dA \xi_\mu j^\mu = \int dA (\xi \cdot \partial\Phi)(k \cdot D\Phi) \quad (4.64)$$

(since $\xi \cdot k = 0$ on horizon by previous Lemma)

$$= \int dA \left(\frac{\partial}{\partial v} \Phi + \Omega_H \frac{\partial}{\partial \chi} \Phi \right) \left(\frac{\partial \Phi}{\partial v} \right) \quad (4.65)$$

For a wave-mode of angular-frequency ω

$$\Phi = \Phi_0 \cos(\omega v - \nu \chi), \quad \nu \in \mathbb{Z} \quad (\text{angular quantum no.}) \quad (4.66)$$

The time average power lost across the horizon is

$$P = \frac{1}{2} \Phi_0^2 A \omega (\omega - \nu \Omega) \quad (4.67)$$

where A is the area of the horizon.

P is positive for most values of ω , but for ω in the range

$$0 < \omega < \nu \Omega_H \quad (4.68)$$

it is negative, i.e. a wave-mode with ω, ν satisfying the inequality is *amplified* by the black hole.

Remarks

- i) Process is positive only for $\nu \neq 0$ because the amplified field must also take away angular momentum from the hole.
- ii) Process is similar to stimulated emission in atomic physics, which suggests the possibility of a spontaneous emission effect. This can be shown to occur in the quantum theory so any black with an ergoregion cannot be stable quantum mechanically.
- iii) We have neglected the back-reaction of Φ on the metric. When corrected for back-reaction the metric can be stationary only if $\partial\Phi/\partial\phi = 0$, but then $j^\mu = 0$ and the black hole energy doesn't change, i.e. strictly speaking super-radiance is incompatible with stationarity.

Chapter 5

Energy and Angular Momentum

5.1 Covariant Formulation of Charge Integral

In the usual Minkowski space formulation with charge density $\rho(\vec{x}, t)$, the charge in a volume V is written as

$$Q = \int_V dV \rho = \int_V dV \vec{\nabla} \cdot \vec{E} \quad \text{by Maxwell's eqs.} \quad (5.1)$$

$$Q = \oint_{\partial V} d\vec{S} \cdot \vec{E} \quad \text{by Gauss' law} \quad (5.2)$$

where surface integral is over boundary of V . Note that,

$$\vec{\nabla} \cdot \vec{E} = \frac{1}{\sqrt{{}^{(3)}g}} \partial_i \sqrt{{}^{(3)}g} E^i, \quad dV = d^3x \sqrt{{}^{(3)}g} \quad (5.3)$$

where ${}^{(3)}g$ is the determinant of the 3-metric, so

$$\int dV \vec{\nabla} \cdot \vec{E} = \int d^3x \partial_i \left(\sqrt{{}^{(3)}g} E^i \right) = \int dS_i E^i. \quad (5.4)$$

The Lorentz covariant formulation uses the similar result

$$\frac{1}{\sqrt{-{}^{(4)}g}} \partial_\mu \left(\sqrt{-{}^{(4)}g} F^{\mu\nu} \right) = D_\mu F^{\mu\nu}. \quad (5.5)$$

The volume V is replaced by an arbitrary spacelike hypersurface Σ (partial Cauchy surface) with boundary $\partial\Sigma$. The volume element on Σ is a *non-*

spacelike co-vector (1-form) dS_μ . Given the current density 4-vector $j^\mu(x)$ we write

$$Q = \int_{\Sigma} dS_\mu j^\mu \quad (5.6)$$

We can choose Σ (at least locally) to be $t = \text{constant}$, in which case $dS_\mu = (dV, \vec{0})$. Since $j^0 = \rho$, we recover the previous expression for Q . Now use Maxwell's equations. $D_\nu F^{\mu\nu} = j^\mu$ to rewrite Q as

$$Q = \int_{\Sigma} dS_\mu D_\nu F^{\mu\nu} \quad (5.7)$$

$$= \frac{1}{2} \oint_{\partial\Sigma} dS_{\mu\nu} F^{\mu\nu} \quad \text{by Gauss' law} \quad (5.8)$$

where $dS_{\mu\nu}$ is the area element of $\partial\Sigma$. When Σ is $t = \text{constant}$ the only non-vanishing components of $dS_{\mu\nu}$ are

$$dS_{0i} = -dS_{i0} \equiv dS_i \quad (5.9)$$

in which case

$$Q = \oint_{\partial\Sigma} dS_i F^{0i} \quad (5.10)$$

But $F^{0i} = -F^{i0} = E^i$, so we recover the previous formula.

5.2 ADM energy

We cannot define energy in the same way because this is associated with a conserved *symmetric tensor* $T^{\mu\nu}$, rather than a vector. This is not unexpected because a *locally conserved energy can exist only in a spacetime admitting a timelike Killing vector field*.

[Unlike photons, which do not carry charge, gravitons *do* carry energy \Rightarrow possibility of energy exchange between matter and its gravitational field.]

We can still define a *total* energy in asymptotically flat spacetimes as a surface integral at infinity because $\partial/\partial t$ is asymptotically Killing in such spacetimes. In this case

$$g_{\mu\nu} \rightarrow \eta_{\mu\nu} \quad \text{as } r \rightarrow \infty \quad (\eta_{\mu\nu} \text{ Minkowski metric}) \quad (5.11)$$

We shall assume that, *in Cartesian coordinates*,

$$h_{\mu\nu} = g_{\mu\nu} - \eta_{\mu\nu} = \mathcal{O}\left(\frac{1}{r}\right) \quad (5.12)$$

which will justify a linearization of Einstein's equations near ∞ .

Exercise Show that $G_{\mu\nu} = 8\pi GT_{\mu\nu}$ becomes the Pauli-Fierz equation

$$\boxed{\square h_{\mu\nu} + h_{,\mu\nu} - 2h_{(\mu,\nu)} = -16\pi G \left(T_{\mu\nu} - \frac{1}{2}\eta_{\mu\nu}T \right)} \quad (5.13)$$

where

$$\square = \eta^{\mu\nu} \partial_\mu \partial_\nu \quad (5.14)$$

$$h = \eta^{\mu\nu} h_{\mu\nu} \quad (5.15)$$

$$h_\mu = \eta^{\nu\rho} h_{\rho\mu,\nu} = h^\nu_{\mu,\nu} \quad (5.16)$$

$$T = \eta^{\mu\nu} T_{\mu\nu} \quad (5.17)$$

Take the trace to get

$$\boxed{\square h - h^\mu_{,\mu} = 8\pi GT} \quad (5.18)$$

We shall first consider a *weak static dust* source

$$T_{\mu\nu} = \left(\begin{array}{c|c} \rho & 0 \\ \hline 0 & 0 \end{array} \right) \quad \text{zero pressure for 'dust'} \quad (5.19)$$

$$\left. \begin{array}{l} \dot{\rho} = 0 \\ 4\pi G\rho \ll 1 \\ T_{0i} = 0 \end{array} \right\} \begin{array}{l} \text{for } \textit{static} \\ \text{for } \textit{weak} \end{array}$$

Since source is static we may assume static $h_{\mu\nu}$, i.e. $\dot{h}_{\mu\nu} = 0$. Then $\mu = \nu = 0$ component of (5.13) becomes

$$\nabla^2 h_{00} = -8\pi GT_{00} \quad (5.20)$$

while (5.18) becomes

$$-\nabla^2 h_{00} + \underbrace{\nabla^2 h_{jj} - h_{ij,ij}}_{\partial_i (\partial_i h_{jj} - \partial_j h_{ij})} = -8\pi GT_{00} \quad (5.21)$$

Add (5.20) and (5.21) to get

$$T_{00} = \frac{1}{16\pi G} \partial_i (\partial_j h_{ij} - \partial_i h_{jj}) \quad (\text{Cartesian coordinates}) \quad (5.22)$$

Since the source is weak we can assume that the spacetime is almost Minkowski, i.e. we treat $h_{\mu\nu}$ as a field on Minkowski spacetime. The total energy is now found by integrating T_{00} over all space.

$$E = \int_{\substack{t = \text{constant} \\ \text{all space}}} d^3x T_{00} \quad (5.23)$$

Using Gauss' law we can rewrite result as the surface integral

$$E = \frac{1}{16\pi G} \oint_{\infty} dS_i (\partial_j h_{ij} - \partial_i h_{jj}) \quad (\text{Cartesian coordinates}) \quad (5.24)$$

But this depends *only* on the asymptotic data, so we may now change the source in any way we wish in the interior without changing E , provided that the asymptotic metric is unchanged. So *formula for E is valid in general.*

This is the ADM formula for the energy of asymptotically flat spacetimes.

5.2.1 Alternative Formula for ADM Energy

Subtract (5.21) from (5.20) to get

$$\partial_i (\partial_j h_{ij} - \partial_i h_{jj}) = -2\nabla^2 h_{00} \quad (5.25)$$

This allows us to rewrite ADM formula as

$$E = -\frac{1}{8\pi G} \oint_{\infty} dS_i \partial_i h_{00} \quad (5.26)$$

But (Exercise)

$$g^{ij}\Gamma_{0j}{}^0 = -\frac{1}{2}\partial_i h_{00} + \mathcal{O}\left(\frac{1}{r^3}\right) \quad (\Gamma = \text{affine connection}) \quad (5.27)$$

and hence

$$E = \frac{1}{4\pi G} \oint_{\infty} dS_i g^{ij}\Gamma_{0j}{}^0 \quad (5.28)$$

$$= \frac{1}{4\pi G} \oint_{\infty} dS_{0i} D^i k^0 \quad \text{where } k = \frac{\partial}{\partial t}, \quad dS_i \equiv dS_{0i} \quad (5.29)$$

But k is asymptotically Killing, i.e.

$$D^\mu k^\nu + D^\nu k^\mu = \mathcal{O}\left(\frac{1}{r^3}\right) \quad (5.30)$$

so

$$E = -\frac{1}{8\pi G} \oint_{\infty} dS_{\mu\nu} D^\mu k^\nu \quad (5.31)$$

5.3 Komar Integrals

Let V be a volume of spacetime on a spacelike hypersurface Σ , with boundary ∂V . To every *Killing* vector field ξ we can associate the Komar integral

$$Q_\xi(V) = \frac{c}{16\pi G} \oint_{\partial V} dS_{\mu\nu} D^\mu \xi^\nu \quad (5.32)$$

for some constant c . Using Gauss' law

$$Q_\xi(V) = \frac{c}{8\pi G} \int_V dS_\mu D_\nu D^\mu \xi^\nu \quad (5.33)$$

Lemma $D_\nu D_\mu \xi^\nu = R_{\mu\nu} \xi^\nu$ for Killing vector field ξ .

Proof By contraction of previous 'Killing vector Lemma.'

Using Lemma,

$$Q_\xi(V) = \frac{c}{8\pi G} \int_V dS_\mu R^\mu{}_\nu \xi^\nu \quad (5.34)$$

$$= c \int dS_\mu \left(T^\mu{}_\nu \xi^\nu - \frac{1}{2} T \xi^\mu \right) \quad (\text{by Einstein's eqs.}) \quad (5.35)$$

$$= \int dS_\mu J^\mu(\xi) \quad (5.36)$$

where

$$J^\mu(\xi) = c \left(T^\mu{}_\nu \xi^\nu - \frac{1}{2} T \xi^\mu \right) \quad (5.37)$$

Proposition $\partial_\mu J^\mu(\xi) = 0$.

Proof Using $D_\mu T^{\mu\nu} = 0$ we have

$$D_\mu J^\mu = c \underbrace{\left(T^{\mu\nu} D_\mu \xi_\nu - \frac{1}{2} T D_\mu \xi^\mu \right)}_{0 \text{ for Killing vector } \xi} - \frac{c}{2} \xi \cdot \partial T \quad (5.38)$$

$$= \frac{c}{2} \xi \cdot \partial R \quad (\text{by Einstein's eqs.}) \quad (5.39)$$

$$= 0 \quad \text{for Killing vector field } \xi \quad (5.40)$$

(In this last step, choose coordinates s.t. $\xi \cdot \partial = \partial/\partial\alpha$, then the metric is α -independent ($\partial g_{\mu\nu}/\partial\alpha = 0$), so R is too ($\partial R/\partial\alpha = 0$)).

Since $J^\mu(\xi)$ is a ‘conserved current’, the charge $Q_\xi(V)$ is time-independent provided $J^\mu(\xi)$ vanishes on ∂V , *just as for electric charge*.

Exercise $\xi = k$ (time-translation Killing vector field)

$$E(V) = -\frac{1}{8\pi G} \oint_{\partial V} dS_{\mu\nu} D^\mu k^\nu \quad (5.41)$$

i.e. $c = -2$, is fixed by comparison with previous formula derived for total energy, i.e. by choosing $V = 2$ -sphere at spatial ∞ .

Exercise Verify that $E(V) = M$ for Schwarzschild, for any V with ∂V in exterior ($r > 2M$) spacetime.

5.3.1 Angular Momentum in Axisymmetric Spacetimes

Return to Komar integral. Let $\xi = m = \partial/\partial\phi$ and choose $c = 1$ to get

$$J(V) = \frac{1}{16\pi G} \oint_{\partial V} dS_{\mu\nu} D^\mu m^\nu \quad (5.42)$$

Note here factor of $-1/2$ relative to Komar integral for the energy.

To check coefficient, use Gauss’ law to write $J(V) = \int_V dS_\mu J^\mu(m)$ where

$$J^\mu(m) = T^\mu{}_\nu m^\nu - \frac{1}{2} T m^\mu \quad (5.43)$$

If we choose V to be on $t = \text{constant}$ hypersurface, and $m = \partial/\partial\phi$, then $dS_\mu m^\mu = 0$, so

$$J(V) = \int_V dV T^0{}_\nu m^\nu = \int_V dV (T^0{}_2 x^1 - T^0{}_1 x^2) \quad (5.44)$$

in Cartesian coordinates $\{x^i; i = 1, 2, 3\}$ where

$$m = x^1 \frac{\partial}{\partial x^2} - x^2 \frac{\partial}{\partial x^1} \quad (5.45)$$

For a *weak source*, $g \approx \eta$ and

$$J(V) \approx \varepsilon_{3jk} \int_V d^3x x^j T^{k0} \quad (5.46)$$

which is result for 3rd component of angular momentum of field in Minkowski spacetime with stress tensor $T_{\mu\nu}$.

So the *total* angular momentum of an asymptotically flat spacetime is found by taking ∂V to be a 2-sphere at spatial infinity

$$J = \frac{1}{16\pi G} \oint_{\infty} dS_{\mu\nu} D^{\mu} m^{\nu} \quad (5.47)$$

5.4 Energy Conditions

$T_{\mu\nu}$ satisfies the *dominant energy condition* if for *all* future-directed timelike vector fields v , the vector field

$$j(v) \equiv -v^{\mu} T_{\mu}{}^{\nu} \partial_{\nu} \quad (5.48)$$

is future-directed non-spacelike, or zero.

All physically reasonable matter satisfies this condition, e.g. for massless scalar field Φ (with $T_{\mu\nu} = \partial_{\mu}\Phi\partial_{\nu}\Phi - \frac{1}{2}g_{\mu\nu}(\partial\Phi)^2$):

$$j^{\mu}(v) = -v \cdot \partial\Phi \partial^{\mu}\Phi + \frac{1}{2}v^{\mu}(\partial\Phi)^2 \quad (5.49)$$

$$j^2(v) = \frac{1}{4}v^2 \underbrace{((\partial\Phi)^2)^2}_{\geq 0} \leq 0 \quad \text{if } v^2 < 0 \quad (5.50)$$

so $j(v)$ is timelike or null if v is timelike. Since v is assumed future-directed, $j(v)$ will be too if $-v \cdot j > 0$. Allowing for $j = 0$ means that we have to prove that $-v \cdot j \geq 0$. Now

$$-v \cdot j = (v \cdot \partial\Phi)^2 - \frac{1}{2}v^2(\partial\Phi)^2 \quad (5.51)$$

$$= \frac{1}{2}(v \cdot \partial\Phi)^2 + \frac{1}{2}(-v^2) \left(\partial\Phi - \frac{v(v \cdot \partial\Phi)}{v^2} \right)^2 \quad (5.52)$$

But $(v \cdot \partial\Phi)^2 \geq 0$ and $-v^2 > 0$ for timelike v , so we have to prove that

$$\left(\partial\Phi - \frac{v(v \cdot \partial\Phi)}{v^2} \right)^2 \geq 0 \quad (5.53)$$

i.e. that $\left(\partial\Phi - \frac{v(v \cdot \partial\Phi)}{v^2} \right)$ is spacelike or zero. This follows from

$$v \cdot \left(\partial\Phi - \frac{v(v \cdot \partial\Phi)}{v^2} \right) = 0 \quad (5.54)$$

since $v \cdot V < 0$ for any non-zero timelike or null vector for timelike v (choose coordinates s.t. $v = (1, \vec{0})$). So if $v \cdot V = 0$ then V cannot be timelike or null.

Since $-v \cdot j = v^\mu v^\nu T_{\mu\nu}$, the dominant energy condition implies that $v^\mu v^\nu T_{\mu\nu} \geq 0$ for all timelike v . By continuity it also implies the

<p><i>Weak energy condition</i></p> $v^\mu v^\nu T_{\mu\nu} \geq 0 \quad \forall \text{ non-spacelike } v \tag{5.55}$

There is also the

<p><i>Strong energy condition</i></p> $v^\mu v^\nu \left(T_{\mu\nu} - \frac{1}{2} g_{\mu\nu} T \right) \geq 0 \quad \forall \text{ non-spacelike } v \tag{5.56}$

Note, *Dominant* $\not\Rightarrow$ *Strong*.

The strong energy condition is needed to prove the singularity theorems, but the dominant energy condition is the physically important one. (An inflationary universe violates the strong energy condition). For example it is needed for the

Positive Energy Theorem (Shoen & Yau, Witten)

The ADM energy of an asymptotically-flat spacetime satisfying $G_{\mu\nu} = 8\pi G T_{\mu\nu}$ is positive semi-definite, and vanishes *only* for Minkowski spacetime with $T_{\mu\nu} = 0$, provided that

- i) \exists an initially non-singular Cauchy surface (otherwise $M < 0$ Schwarzschild would be a counter-example).
- ii) $T_{\mu\nu}$ satisfies the dominant energy condition (clearly, *some* condition on $T_{\mu\nu}$ is necessary).
- iii) Some other technical assumptions which we ignore here.

Chapter 6

Black Hole Mechanics

6.1 Geodesic Congruences

Definition A congruence is a family of curves such that precisely one curve of the family passes through each point. It is a geodesic congruence if the curves are geodesics.

The equations of a geodesic congruence may be written as $x^\mu = x^\mu(y^\alpha, \lambda)$ where the parameters $y^\alpha, \alpha = 0, 1, 2$ label the geodesic and λ is an affine parameter on the geodesic, i.e.

$$t = \frac{d}{d\lambda} = \frac{\partial x^\mu}{\partial \lambda} \partial_\mu \quad (6.1)$$

is the tangent to the geodesics such that $t \cdot Dt^\mu = 0$. Since the parameter λ is affine, $t^2 \equiv -1$ for timelike geodesics (while $t^2 \equiv 0$ for null geodesics). The vectors

$$\eta_\alpha = \frac{d}{dy^\alpha} = \frac{\partial x^\mu}{\partial y^\alpha} \partial_\mu \quad (6.2)$$

may be considered as a basis of ‘displacement’ vectors across the congruence:

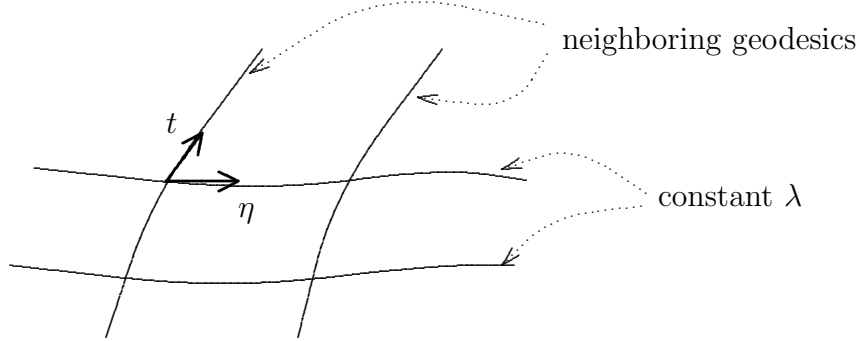

Note that t and η_α commute (since we could choose coordinates x^μ s.t. $t = \partial/\partial\lambda$ and $\eta_\alpha = \partial/\partial y^\alpha$), so

$$0 = t^\nu \partial_\nu \eta_\alpha^\mu - \eta_\alpha^\nu \partial_\nu t^\mu \quad (6.3)$$

$$= t^\nu (\partial_\nu \eta_\alpha^\mu + \Gamma^\mu_{\sigma\nu} \eta_\alpha^\sigma) - \eta_\alpha^\nu (\partial_\nu t^\mu + \Gamma^\mu_{\sigma\nu} t^\sigma) \quad (6.4)$$

$$= t^\nu D_\nu \eta_\alpha^\mu - \eta_\alpha^\nu D_\nu t^\mu \quad (\text{by symmetry of connection}) \quad (6.5)$$

or

$$\boxed{t^\nu D_\nu \eta_\alpha^\mu = B^\mu{}_\nu \eta_\alpha^\nu} \quad (6.6)$$

where

$$B^\mu{}_\nu = D_\nu t^\mu \quad (6.7)$$

measures the failure of the displacement vectors η_α to be parallelly-transported along the geodesics, i.e. it measures *geodesic deviation*.

A geodesic nearby some fiducial geodesic may now be specified by a displacement vector η , but this specification is not *unique* because $\eta' = \eta + a t$ ($a = \text{constant}$) is a displacement vector to the *same* geodesic.

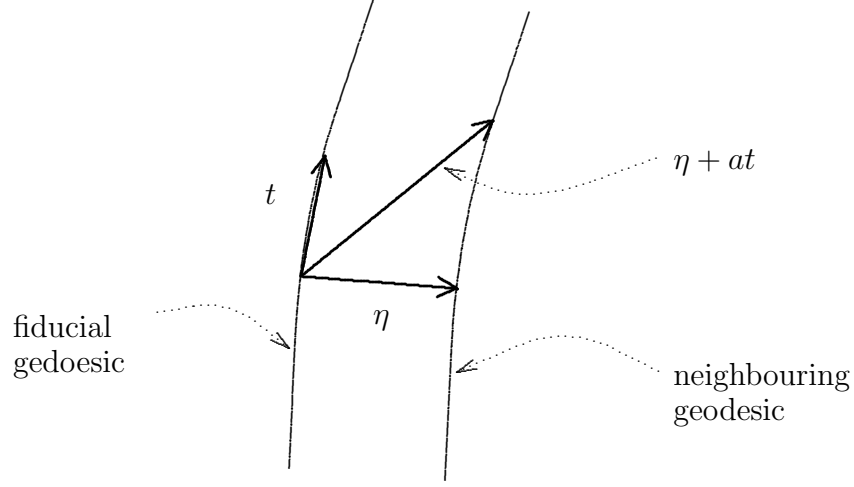

For timelike geodesics we can remove this ambiguity by requiring η to be orthogonal to t , i.e.

$$\boxed{\eta \cdot t = 0} \quad (6.8)$$

Strictly, speaking we can only make such a choice at a given value of λ , by choosing the origin of λ across the congruence. However

$$\frac{d}{d\lambda}(\eta \cdot t) = (t \cdot D\eta^\mu) t_\mu \quad (\text{since } t \cdot Dt_\mu = 0) \quad (6.9)$$

$$= B^\mu{}_\nu \eta^\nu t_\mu = (\eta^\nu D_\nu t^\mu) t_\mu \quad (6.10)$$

$$= \frac{1}{2} \eta \cdot \partial t^2 = 0, \quad (6.11)$$

since $t^2 \equiv -1$ for timelike congruences, so if $\eta \cdot t$ is chosen to vanish at one value of λ it will do so for all λ .

For null congruences the condition $\eta \cdot t = 0$ is not sufficient to eliminate the ambiguity in the choice of η because

$$\eta' \cdot t = (\eta + at) \cdot t = \eta \cdot t + at \cdot t \quad (6.12)$$

$$= \eta \cdot t \quad (6.13)$$

when $t^2 = 0$, which means that $\eta' \cdot t = 0$ whenever $\eta \cdot t = 0$. The problem is that *the 3-dim space of vectors orthogonal to t now includes t itself*, so the displacement vectors η orthogonal to t specify only a *two-parameter family of geodesics*. Displacement vectors to the other null geodesics in the congruence have a component in the direction of a vector n that is not

orthogonal to t . The choice of n is otherwise arbitrary (it is analogous to the choice of gauge in electrodynamics), but it is *convenient* to choose it such that

$$\boxed{n^2 = 0, \quad n \cdot t = -1} \quad (6.14)$$

e.g. if t is tangent to an outgoing radial null geodesic, then n is tangent to an ingoing one.

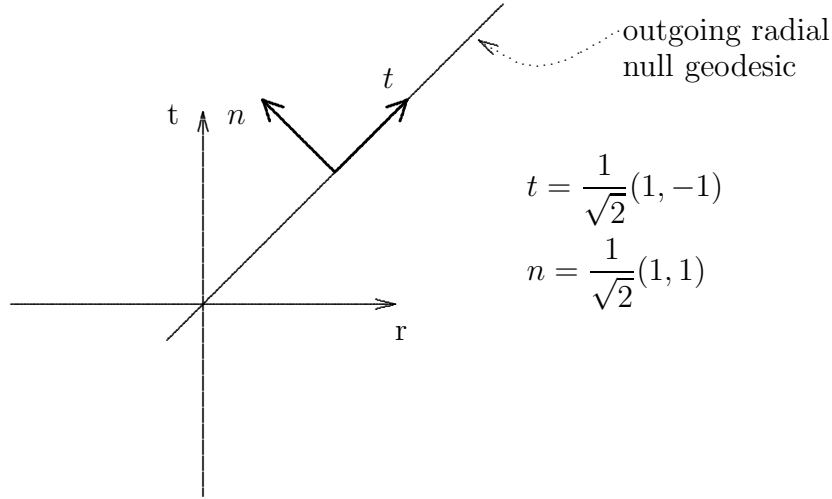

Consistency of the choice of n requires that n^2 and $n \cdot t$ be independent of λ , which is satisfied if

$$\boxed{t \cdot Dn^\mu = 0} \quad (6.15)$$

i.e. we choose n to be parallelly-transported along the geodesics.

Having made a choice of the vector n , we may now uniquely specify a two-parameter subset of geodesics of a null geodesic congruence by displacement vectors η orthogonal to t by requiring them to also satisfy

$$\boxed{\eta \cdot n = 0} \quad (6.16)$$

The vectors η now span a two-dimensional subspace, T_\perp , of the tangent space, that is orthogonal to both t and n , i.e. $P\eta = \eta$, where

$$P^\mu_\nu = \delta^\mu_\nu + n^\mu t_\nu + t^\mu n_\nu \quad (6.17)$$

projects onto T_\perp .

Proposition $P\eta = \eta \Rightarrow t \cdot D\eta^\mu = \hat{B}^\mu{}_\nu \eta^\nu$, where

$$\hat{B}^\mu{}_\nu = P^\mu{}_\lambda B^\lambda{}_\rho P^\rho{}_\nu \quad (6.18)$$

i.e. if $\eta \in T_\perp$ initially, it remains in this subspace.

Proof

$$t \cdot D\eta^\mu = t \cdot D(P^\mu{}_\nu \eta^\nu) \quad (\text{if } P\eta = \eta) \quad (6.19)$$

$$= P^\mu{}_\nu t \cdot D\eta^\nu \quad (\text{since } t \cdot Dn = t \cdot Dt = 0) \quad (6.20)$$

$$= P^\mu{}_\nu B^\nu{}_\rho \eta^\rho \quad (\text{by definition}) \quad (6.21)$$

$$= P^\mu{}_\nu B^\nu{}_\rho P^\rho{}_\lambda \eta^\lambda \quad (\text{since } P\eta = \eta) \quad (6.22)$$

$$= \hat{B}^\mu{}_\nu \eta^\nu \quad \square. \quad (6.23)$$

\hat{B} is effectively a 2×2 matrix. We now decompose it into its algebraically irreducible parts

$$\hat{B}^\mu{}_\nu = \frac{1}{2}\theta P^\mu{}_\nu + \hat{\sigma}^\mu{}_\nu + \hat{\omega}^\mu{}_\nu \quad (6.24)$$

where

θ	$= \hat{B}^\mu{}_\mu$	(trace)	<i>expansion</i>
$\hat{\sigma}_{\mu\nu}$	$= \hat{B}_{(\mu\nu)} - \frac{1}{2}P_{\mu\nu}\hat{B}^\rho{}_\rho$	(symmetric, traceless)	<i>shear</i>
$\hat{\omega}_{\mu\nu}$	$= \hat{B}_{[\mu\nu]}$	(anti-symmetric)	<i>twist</i>

Notation:

$$\hat{B}_{(\mu\nu)} = \frac{1}{2}(\hat{B}_{\mu\nu} + \hat{B}_{\nu\mu})$$

$$\hat{B}_{[\mu\nu]} = \frac{1}{2}(\hat{B}_{\mu\nu} - \hat{B}_{\nu\mu})$$

Lemma $t_{[\mu}\hat{B}_{\nu\rho]} = t_{[\mu}B_{\nu\rho]}$

Proof Using $t \cdot Dt = 0$ and $t^2 = 0$, we have

$$\hat{B}^\mu{}_\nu = B^\mu{}_\nu + t^\mu (n_\lambda B^\lambda{}_\nu + n_\lambda B^\lambda{}_\rho n^\rho t_\nu) + (B^\mu{}_\rho n^\rho) t_\nu \quad (6.25)$$

Hence result. ([] indicates total anti-symmetrization on enclosed indices).

Proposition The tangents t are normal to a family of null hypersurfaces iff $\hat{\omega} = 0$.

Proof If $\hat{\omega} = 0$, then

$$0 = t_{[\mu}\hat{\omega}_{\nu\rho]} \equiv t_{[\mu}\hat{B}_{\nu\rho]} \quad (6.26)$$

$$= t_{[\mu}B_{\nu\rho]} \quad (\text{by Lemma}) \quad (6.27)$$

$$= t_{[\mu}D_{\rho}t_{\nu]} \quad (6.28)$$

so t is normal to a family of hypersurfaces by Frobenius' theorem. (In this case we can take $t = l$).

Conversely, if t is normal to a family of null hypersurfaces, then Frobenius' theorem implies $t_{[\mu}D_{\nu}t_{\rho]} = 0$. Then, reversing the previous steps we find that,

$$0 = t_{[\mu}\hat{\omega}_{\nu\rho]} = \frac{1}{3} (t_{\mu}\hat{\omega}_{\nu\rho} + t_{\rho}\hat{\omega}_{\mu\nu} + t_{\nu}\hat{\omega}_{\rho\mu}) \quad (6.29)$$

Contract with n . Since $n \cdot t = -1$ and $n\hat{\omega} = \hat{\omega}n = 0$ (because $\hat{\omega}$ contains the projection operator P), we deduce that $\hat{\omega} = 0$.

If $\hat{\omega} = 0$ we have a family of null hypersurfaces. The family is parameterized by the displacement along n

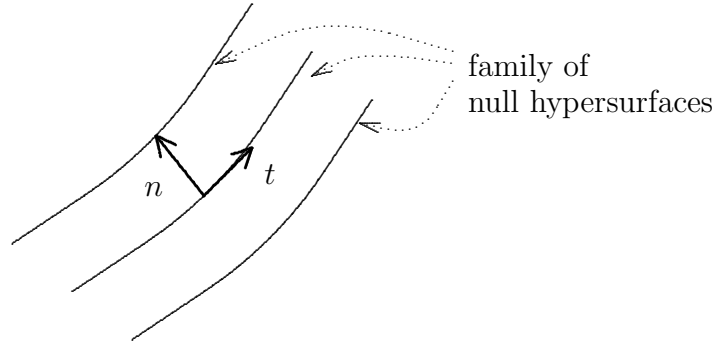

6.1.1 Expansion and Shear

Two linearly independent vectors $\eta^{(1)}$ and $\eta^{(2)}$ orthogonal to n and t determine an area element of T_{\perp} . The shear $\hat{\sigma}$ determines the change of *shape* of this area element as λ increases. The *magnitude* of the area element defined by $\eta^{(1)}$ and $\eta^{(2)}$ is

$$a = \varepsilon^{\mu\nu\rho\sigma} t_{\mu} \eta_{\nu} \eta_{\rho}^{(1)} \eta_{\sigma}^{(2)} \quad (6.30)$$

Since $t \cdot Dt = 0$ and $t \cdot Dn = 0$, we have

$$\frac{da}{d\lambda} = t \cdot \partial a = t \cdot Da = \varepsilon^{\mu\nu\rho\sigma} t_{\mu} n_{\nu} \left(t \cdot D\eta_{\rho}^{(1)} \eta_{\sigma}^{(2)} + \eta_{\rho}^{(1)} t \cdot D\eta_{\sigma}^{(2)} \right) \quad (6.31)$$

$$= \varepsilon^{\mu\nu\rho\sigma} t_\mu n_\nu \left[\hat{B}_\rho^\lambda \eta_\lambda^{(1)} \eta_\sigma^{(2)} + \eta_\rho^{(1)} \hat{B}_\sigma^\lambda \eta_\lambda^{(2)} \right] \quad (6.32)$$

$$= 2\varepsilon^{\mu\nu\rho\sigma} t_\mu n_\nu \hat{B}_\rho^\lambda \eta_{[\lambda}^{(1)} \eta_{\sigma]}^{(2)} \quad (6.33)$$

$$= \theta a \quad (\text{see Question IV.2}) \quad (6.34)$$

i.e. θ measures the rate of increase of the magnitude of the area element. If $\theta > 0$ neighboring geodesics are *diverging*, if $\theta < 0$ they are *converging*.

Raychaudhuri's equation for null geodesic congruences

$$\frac{d\theta}{d\lambda} = t \cdot D (B^\mu_\nu P^\nu_\mu) \quad (6.35)$$

$$= P^\nu_\mu t \cdot D B^\mu_\nu \quad (\text{since } t \cdot Dt = 0 \text{ and } t \cdot Dn = 0) \quad (6.36)$$

$$= P^\nu_\mu t^\rho D_\rho D_\nu t^\mu \quad (6.37)$$

$$= P^\nu_\mu t^\rho D_\nu D_\rho t^\mu + P^\nu_\mu t^\rho [D_\rho, D_\nu] t^\mu \quad (6.38)$$

$$= P^\nu_\mu \left[\underbrace{D_\nu (t \cdot Dt^\mu)}_0 - (D_\nu t^\rho) (D_\rho t^\mu) \right] + P^\nu_\mu t^\rho R_{\rho\nu}{}^\mu{}_\sigma t^\sigma \quad (6.39)$$

$$= -P^\nu_\mu B^\mu_\rho B^\rho_\nu - t^\rho R_{\rho\sigma} t^\sigma \quad (\text{using symmetries of } R) \quad (6.40)$$

$$= -P^\nu_\mu B^\mu_\lambda P^\lambda_\rho B^\rho_\nu + P^\nu_\mu B^\mu_\lambda t^\lambda n_\rho B^\rho_\nu + P^\nu_\mu B^\mu_\lambda n^\lambda t_\rho B^\rho_\nu - t^\rho t^\sigma R_{\rho\sigma} \\ = -\hat{B}^\mu_\rho \hat{B}^\rho_\nu - t^\rho t^\sigma R_{\rho\sigma} \quad (\text{using } t \cdot Dt \equiv 0 \text{ and } t^2 \equiv 0) \quad (6.41)$$

or

$$\boxed{\frac{d\theta}{d\lambda} = -\frac{1}{2}\theta^2 - \hat{\sigma}^{\mu\nu} \hat{\sigma}_{\mu\nu} + \hat{\omega}^{\mu\nu} \hat{\omega}_{\mu\nu} - R_{\mu\nu} t^\mu t^\nu} \quad (6.42)$$

This is Raychaudhuri's equation for null geodesic congruences.

Some consequences of Raychaudhuri's equation for null hypersurfaces

Proposition The expansion θ of the null geodesic generator of a null hypersurface, \mathcal{N} , obeys the differential inequality

$$\frac{d\theta}{d\lambda} \leq -\frac{1}{2}\theta^2 \quad (6.43)$$

provided the spacetime metric solves Einstein's equations $G_{\mu\nu} = 8\pi G T_{\mu\nu}$ and $T_{\mu\nu}$ satisfies the weak energy condition.

Proof $\hat{\sigma}^2 \geq 0$ because the metric in the orthogonal subspace T_\perp (to l and n) is positive definite. $\hat{\omega}^2 \geq 0$ also, but this comes in with wrong sign, however $\hat{\omega} = 0$ for a hypersurface. Thus Raychaudhuri's equation implies

$$\frac{d\theta}{d\lambda} \leq -\frac{1}{2}\theta^2 - R_{\mu\nu}l^\mu l^\nu \quad (6.44)$$

$$\leq -\frac{1}{2}\theta^2 - 8\pi g T_{\mu\nu}l^\mu l^\nu \quad (\text{by Einstein's eq.}) \quad (6.45)$$

$$\leq -\frac{1}{2}\theta^2 \quad \text{by weak energy condition} \quad (6.46)$$

Corollary If $\theta = \theta_0 < 0$ at some point p on a null generator γ of a null hypersurface, then $\theta \rightarrow -\infty$ along γ within an affine length $2/|\theta_0|$.

Proof Let λ be the affine parameter, with $\lambda = 0$ at p . Now

$$\frac{d\theta}{d\lambda} \leq -\frac{1}{2}\theta^2 \quad \Leftrightarrow \quad \frac{d}{d\lambda}(\theta^{-1}) > \frac{1}{2} \quad \Rightarrow \quad \theta^{-1} \geq \frac{1}{2}\lambda + \text{constant} \quad (6.47)$$

where, since $\theta = \theta_0$ at $\lambda = 0$, the constant cannot exceed θ_0^{-1} . Thus

$$\theta^{-1} \geq \frac{1}{2}\lambda + \theta_0^{-1} \quad \Rightarrow \quad \theta \leq \frac{\theta_0}{1 + \frac{1}{2}\lambda\theta_0} \quad (6.48)$$

If $\theta_0 < 0$ the right-hand-side $\rightarrow -\infty$ when $\lambda = 2/|\theta_0|$, so $\theta \rightarrow -\infty$ within that affine length.

Interpretation When $\theta < 0$ neighboring geodesics are converging. The attractive nature of gravitation (weak energy condition) then implies that they must continue to converge to a focus or a caustic.

Proposition If \mathcal{N} is a Killing horizon then $\hat{B}_{\mu\nu} = 0$ and

$$\frac{d\theta}{d\lambda} = 0 \quad (6.49)$$

Proof Let ξ be the Killing vector s.t. $\xi = fl$ ($l \cdot Dl = 0$) on \mathcal{N} for some non-zero function f . Then

$$\hat{B}_{\mu\nu} = \hat{B}_{(\mu\nu)} \quad (\text{since } \hat{\omega} = 0 \text{ for family of hypersurface}) \quad (6.50)$$

$$= P_\mu^\lambda B_{(\lambda\rho)} P_\nu^\rho \equiv P_\mu^\lambda D_{(\rho} l_{\lambda)} P_\nu^\rho \quad (6.51)$$

$$= P_\mu^\lambda (\partial_{(\rho} f^{-1)}) \xi_{\lambda)} P_\nu^\rho \quad (\text{since } D_{(\rho} \xi_{\lambda)} = 0) \quad (6.52)$$

$$= 0 \quad (\text{since } P\xi = \xi P = 0) \quad (6.53)$$

In particular $\theta = 0$, *everywhere on* \mathcal{N} , so $d\theta/d\lambda = 0$.

Corollary For Killing horizon \mathcal{N} of ξ

$$\boxed{R_{\mu\nu} \xi^\mu \xi^\nu|_{\mathcal{N}} = 0} \quad (6.54)$$

Proof Using $d\theta/d\lambda = 0$ and $\hat{B}_{\mu\nu} = 0$ in Raychaudhuri's equation.

6.2 The Laws of Black Hole Mechanics

Previously we showed that κ^2 is constant on a *bifurcate* Killing horizon. The proof fails if we have only part of a Killing horizon, without the bifurcation 2-sphere, as happens in *gravitational collapse*. In this case we need the:

6.2.1 Zeroth law

If $T_{\mu\nu}$ obeys the dominant energy condition then the surface gravity κ is constant on the future event horizon.

Proof Let ξ be the Killing vector normal to \mathcal{H}^+ (here we use the theorem that \mathcal{H}^+ is a Killing horizon). Then since $R_{\mu\nu} \xi^\mu \xi^\nu = 0$ and $\xi^2 = 0$ on \mathcal{H}^+ , Einstein's equations imply

$$0 = -T_{\mu\nu} \xi^\mu \xi^\nu|_{\mathcal{H}^+} \equiv J_\mu \xi^\mu|_{\mathcal{H}^+} \quad (6.55)$$

i.e. $J = (-T^\mu{}_\nu \xi^\nu) \partial_\mu$ is tangent to \mathcal{H}^+ . It follows that J can be expanded on a basis of tangent vectors to \mathcal{H}^+

$$J = a\xi + b_1\eta^{(1)} + b_2\eta^{(2)} \quad \text{on } \mathcal{H}^+ \quad (6.56)$$

But since $\xi \cdot \eta^{(i)} = 0$ this is spacelike or null (when $b_1 = b_2 = 0$), whereas it must be *timelike or null* by the *dominant energy condition*. Thus, dominant energy $\Rightarrow J \propto \xi$ and hence that

$$0 = \xi_{[\sigma} J_{\rho]}|_{\mathcal{H}^+} = -\xi_{[\sigma} T_{\rho]}^\lambda \xi_\lambda|_{\mathcal{H}^+} \quad (6.57)$$

$$= \xi_{[\sigma} R_{\rho]}^\lambda \xi_\lambda|_{\mathcal{H}^+} \quad (\text{by Einstein's eq.}) \quad (6.58)$$

$$= \xi_{[\rho} \partial_{\sigma]} \kappa|_{\mathcal{H}^+} \quad (\text{by result of Question IV.3}) \quad (6.59)$$

$$(6.60)$$

$\Rightarrow \partial_\sigma \kappa \propto \xi_\sigma \Rightarrow t \cdot \partial \kappa = 0$ for any tangent vector t to \mathcal{H}^+
 $\Rightarrow \kappa$ is constant on \mathcal{H}^+ .

6.2.2 Smarr's Formula

Let Σ be a spacelike hypersurface in a stationary exterior black hole space-time with an inner boundary, H , on the future event horizon and another boundary at i_0 .

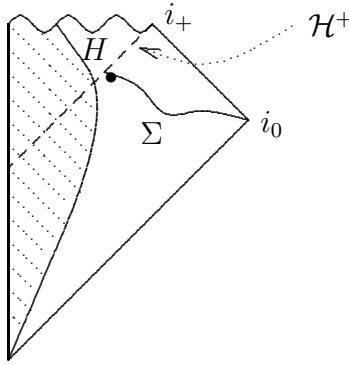

The surface H is a 2-sphere that can be considered as the ‘boundary’ of the black hole.

Applying Gauss’ law to the Komar integral for J we have

$$J = \frac{1}{8\pi G} \int_{\Sigma} dS_{\mu} D_{\nu} D^{\mu} m^{\nu} + \frac{1}{16\pi G} \oint_H dS_{\mu\nu} D^{\mu} m^{\nu} \quad (6.61)$$

$$= \frac{1}{8\pi G} \int_{\Sigma} dS_{\mu} R^{\mu}{}_{\nu} m^{\nu} + J_H \quad \text{by Killing vector Lemma} \quad (6.62)$$

where J_H is the integral over H . Using Einstein’s equation,

$$J = \int_{\Sigma} dS_{\mu} \left(T^{\mu}{}_{\nu} m^{\nu} - \frac{1}{2} T m^{\mu} \right) + J_H \quad (6.63)$$

In the absence of matter other than an electromagnetic field, we have $T_{\mu\nu} = T_{\mu\nu}(F)$, the stress tensor of the electromagnetic field. Since $g^{\mu\nu} T_{\mu\nu}(F) = T(F) = 0$ we have

$$\boxed{J = \int_{\Sigma} dS_{\mu} T^{\mu}{}_{\nu}(F) m^{\nu} + J_H} \quad (6.64)$$

for an *isolated* black hole (i.e. $T_{\mu\nu} = T_{\mu\nu}(F)$).

Now apply Gauss' law to the Komar integral for the total energy (= mass).

$$\begin{aligned}
M &= -\frac{1}{4\pi G} \int_{\Sigma} dS_{\mu} R^{\mu}{}_{\nu} k^{\nu} - \frac{1}{8\pi G} \oint_H dS_{\mu\nu} D^{\mu} k^{\nu} \quad (\text{insert } \xi = k + \Omega_H m) \\
&= \int_{\Sigma} dS_{\mu} (-2T^{\mu}{}_{\nu} k^{\nu} + T k^{\mu}) - \frac{1}{8\pi G} \oint_H dS_{\mu\nu} (D^{\mu} \xi^{\nu} - \Omega_H D^{\mu} m^{\nu}) \quad (6.65)
\end{aligned}$$

(6.66)

since Ω_H is constant on H . For $T_{\mu\nu} = T_{\mu\nu}(F)$ ($T(F) = 0$) we have

$$M = -2 \int_{\Sigma} dS_{\mu} T^{\mu}{}_{\nu}(F) k^{\nu} + 2\Omega_H J_H - \frac{1}{8\pi G} \oint_H dS_{\mu\nu} D^{\mu} \xi^{\nu} \quad (6.67)$$

for an isolated black hole. Using (6.64) we have

$$M = -2 \int_{\Sigma} dS_{\mu} T^{\mu}{}_{\nu}(F) \xi^{\nu} + 2\Omega_H J - \frac{1}{8\pi G} \oint_H dS_{\mu\nu} D^{\mu} \xi^{\nu} \quad (6.68)$$

For simplicity, we now suppose that $T_{\mu\nu}(F) = 0$, i.e. the black hole has zero charge (see Questions III.7&8 for general case). Then

$$M = 2\Omega_H J - \frac{1}{8\pi G} \oint_H dS_{\mu\nu} D^{\mu} \xi^{\nu} \quad (6.69)$$

Lemma

$$dS_{\mu\nu} = (\xi_{\mu} n_{\nu} - \xi_{\nu} n_{\mu}) dA \quad \text{on } H \quad (6.70)$$

where n is s.t. $n \cdot \xi = -1$.

Proof n and ξ are normals to H , so we have to check coefficients. In coordinates such that

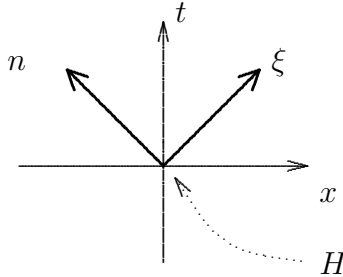

$$\xi_\mu = \frac{1}{\sqrt{2}}(1, 1, 0, 0) \quad (6.71)$$

$$n_\mu = \frac{1}{\sqrt{2}}(1, -1, 0, 0) \quad (6.72)$$

we should have $|dS_{01}| = dA$. We do if $dS_{\mu\nu}$ is as given. [There is still a sign ambiguity. Fix by requiring sensible results].

Thus

$$-\frac{1}{8\pi G} \oint_H dS_{\mu\nu} D^\mu \xi^\nu = -\frac{1}{4\pi G} \oint_H dA \underbrace{(\xi \cdot D\xi)^\nu}_{\kappa \xi^\nu} n_\nu \quad (6.73)$$

$$= -\frac{\kappa}{4\pi G} \oint_H dA \underbrace{\xi \cdot n}_{-1} \quad (\kappa \text{ is constant by 0}^{\text{th}} \text{ law}) \quad (6.74)$$

$$= \frac{\kappa}{4\pi G} A \quad (6.75)$$

where A is the “area of the horizon” (i.e. H).

Hence

$$\boxed{M = \frac{\kappa A}{4\pi} + 2\Omega_H J} \quad (6.76)$$

This is Smarr’s formula for the mass of a Kerr black hole. [Exercise: Check, using previous results for κ , Ω_H , and A]. In the $Q \neq 0$ case, this formula generalizes to

$$M = \frac{\kappa A}{4\pi} + 2\Omega_H J + \Phi_H Q \quad (6.77)$$

where Φ_H is the co-rotating electric potential on the horizon (see Question III.6&7).

6.2.3 First Law

If a stationary black hole of mass M , charge Q and angular momentum J , with future event horizon of surface gravity κ , electric surface potential Φ_H and angular velocity Ω_H , is perturbed such that it settles down to another black hole with mass $M + \delta M$ charge $Q + \delta Q$ and angular momentum $J + \delta J$, then

$$\boxed{dM = \frac{\kappa}{8\pi} dA + \Omega_H dJ + \Phi_H dQ} \quad (6.78)$$

- 1) Definition of Φ_H and proof for $Q \neq 0$ in Q. III.6&7.

- 2) This statement of the first law uses the fact that the event horizon of a stationary black hole must be a Killing horizon.

‘Proof’ for $Q = 0$ (Gibbons) Uniqueness theorems imply that

$$M = M(A, J) \tag{6.79}$$

But A and J both have dimensions of M^2 ($G = c = 1$) so the function $M(A, J)$ must be *homogeneous of degree 1/2*. By Euler’s theorem for homogeneous functions

$$A \frac{\partial M}{\partial A} + J \frac{\partial M}{\partial J} = \frac{1}{2} M \tag{6.80}$$

$$= \frac{\kappa}{8\pi} A + \Omega_H J \quad \text{by Smarr’s formula} \tag{6.81}$$

Therefore

$$A \left(\frac{\partial M}{\partial A} - \frac{\kappa}{8\pi} \right) + J \left(\frac{\partial M}{\partial J} - \Omega_H \right) = 0 \tag{6.82}$$

But A and J are free parameters so

$$\frac{\partial M}{\partial A} = \frac{\kappa}{8\pi}, \quad \frac{\partial M}{\partial J} = \Omega_H \tag{6.83}$$

6.2.4 The Second Law (Hawking’s Area Theorem)

If $T_{\mu\nu}$ satisfies the weak energy condition, and assuming that the cosmic censorship hypothesis is true then the area of the future event horizon of an asymptotically flat spacetime is a non-decreasing function of time.

Technically the cosmic censorship assumption is that the spacetime is ‘strongly asymptotically predictable’ which requires the existence of a globally hyperbolic submanifold of spacetime containing both the exterior spacetime *and* the horizon. A theorem of Geroch states that in this case there exists a family of Cauchy hypersurfaces $\Sigma(\lambda)$ such that $\Sigma(\lambda') \subset D^+(\Sigma(\lambda))$ if $\lambda' > \lambda$.

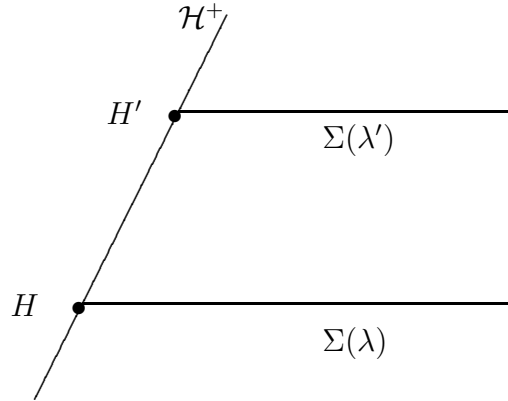

We can choose λ to be the affine parameter on a null geodesic generator of \mathcal{H}^+ . The “area of the horizon” $A(\lambda)$ is the area of the intersection of $\Sigma(\lambda)$ with \mathcal{H}^+ . The second law states that $A(\lambda') \geq A(\lambda)$ if $\lambda' > \lambda$.

Idea of proof To show that $A(\lambda)$ cannot decrease with increasing λ it is sufficient to show that each area element, a , of H has this property. Recalling that

$$\frac{da}{d\lambda} = \theta a \tag{6.84}$$

we see that the second law holds if $\theta \geq 0$ everywhere on \mathcal{H}^+ . To see that this is true, recall that if $\theta < 0$ the geodesics must converge to a focus or caustic, i.e. nearby geodesics to a given one passing through a point p must intersect γ at finite affine distance along it. The first point q for which this happens is called the point conjugate to p on γ .

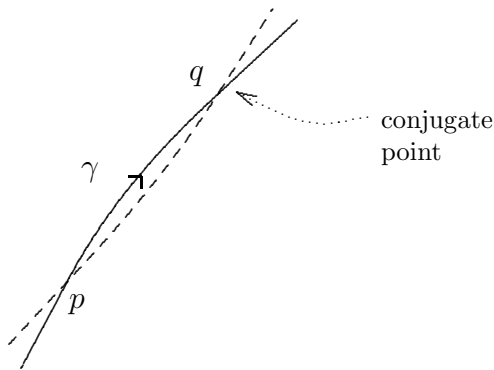

Points on γ beyond q are no longer null separated. They are *timelike* separated from p . An example illustrating this is light rays in a flat 2-dim cylindrical spacetime.

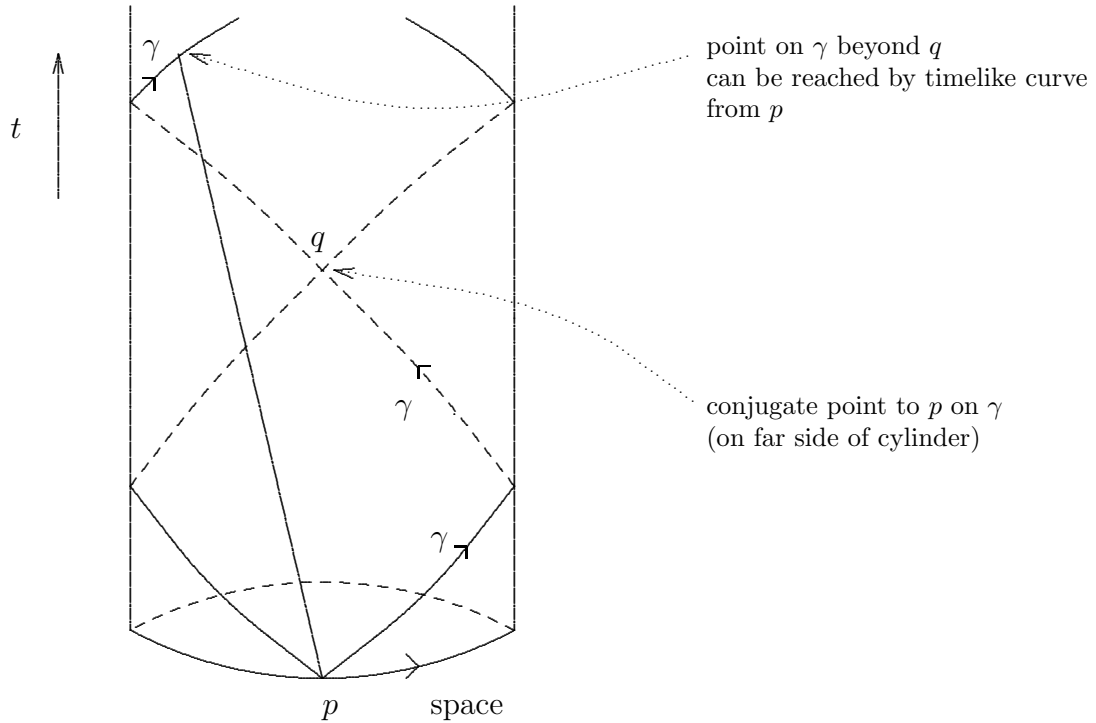

The existence of a conjugate point to the future of a null geodesic generator in \mathcal{H}^+ would mean that this generator of \mathcal{H}^+ has a finite endpoint, in contradiction to Penrose's theorem, so the hypothetical conjugate point cannot exist. Thus it must be that $\theta \geq 0$ everywhere on \mathcal{H}^+ and hence the second law.

$\theta = 0$ only for stationary spacetimes.

Example Formation of black hole from pressure-free spherically-symmetric gravitational collapse. Illustrate by a Finkelstein diagram

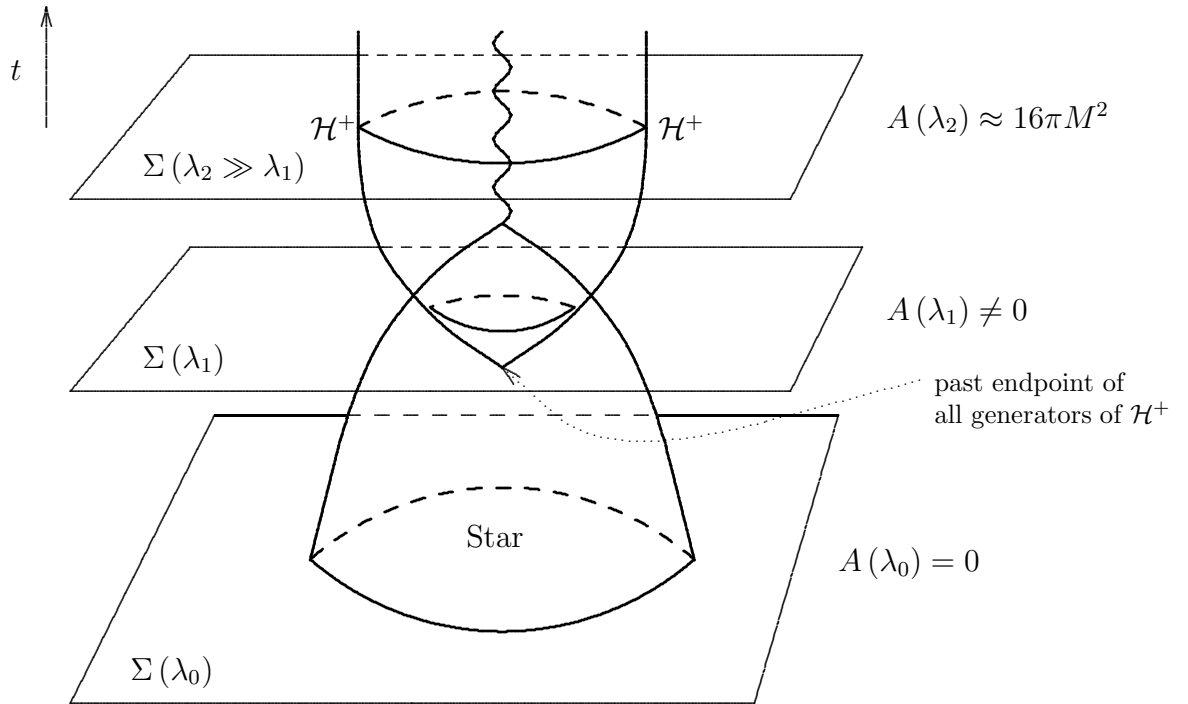

$A = 0$ on $\Sigma(\lambda_0)$. $A \neq 0$ on $\Sigma(\lambda_1)$ and it has increased to its final value of $A = 16\pi M^2$ for a stationary Schwarzschild black hole on $\Sigma(\lambda_2)$.

Consequences of 2nd Law

- (1) Limits to efficiency of mass/energy conversion in black hole collisions.
Consider Finkelstein diagram of two coalescing black holes.

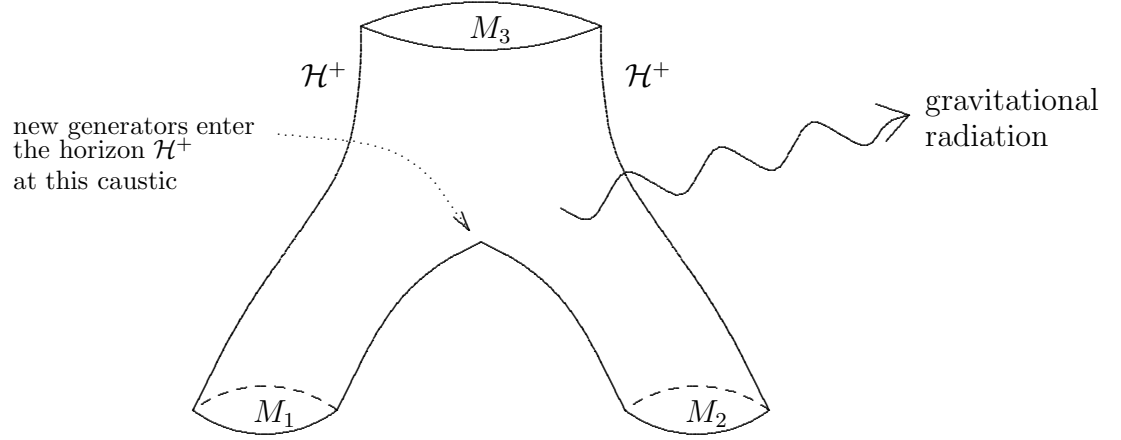

Then energy radiated is $M_1 + M_2 - M_3$, so the efficiency, η , of mass to energy conversion is

$$\eta = \frac{M_1 + M_2 - M_3}{M_1 + M_2} = 1 - \frac{M_3}{M_1 + M_2} \quad (6.85)$$

Assuming that the two black holes are initially approximately stationary, so $A_1 = 16\pi M_1^2$ and $A_2 = 16\pi M_2^2$ the area theorem says that

$$A_3 \geq 16\pi (M_1^2 + M_2^2) \quad (6.86)$$

But $16\pi M_3^2 \geq A_3$ (with equality at late times), so

$$M_3 \geq \sqrt{M_1^2 + M_2^2} \quad (6.87)$$

Thus

$$\eta \leq 1 - \frac{\sqrt{M_1^2 + M_2^2}}{M_1 + M_2} \leq 1 - \frac{1}{\sqrt{2}} \quad (6.88)$$

The radiated energy could be used to do work, so the area theorem limits the useful energy that can be extracted from black holes in the same way that the 2nd law of thermodynamics limits the efficiency of heat engines.

- (2) *Black holes cannot bifurcate.* Consider $M_3 \rightarrow M_1 + M_2$ (with $M_1 > 0$ and $M_2 > 0$). The area theorem now says that

$$M_3 \leq \sqrt{M_1^2 + M_2^2} \leq M_1 + M_2 \quad (6.89)$$

but energy conservation requires $M_3 \geq M_1 + M_2$ (with $M_3 - M_1 - M_2$ being radiated away). We have a contradiction so the process cannot occur.

Chapter 7

Hawking Radiation

7.1 Quantization of the Free Scalar Field

Let $\Phi(x)$ be a real scalar field satisfying the Klein-Gordon equation.

$$(D^\mu \partial_\mu - m^2) \Phi(x) = 0 \quad (7.1)$$

Let $\{\phi_\alpha\}$ span the space \mathcal{S} of solutions. We shall assume that the spacetime is globally hyperbolic, i.e. that \exists a Cauchy surface Σ . A point in the space \mathcal{S} then corresponds to a choice of initial data on Σ . The space \mathcal{S} has a natural *symplectic structure*.

$$\phi_\alpha \wedge \phi_\beta = \int_\Sigma dS_\mu \phi_\alpha \overleftrightarrow{\partial}^\mu \phi_\beta, \quad (= -\phi_\beta \wedge \phi_\alpha) \quad (7.2)$$

where $\overleftrightarrow{\partial}$ is defined by

$$f \overleftrightarrow{\partial} g = f \partial g - g \partial f \quad (7.3)$$

‘Natural’ means that \wedge *does not depend on the choice of Σ* .

$$(\phi_\alpha \wedge \phi_\beta)_\Sigma - (\phi_\alpha \wedge \phi_\beta)_{\Sigma'} = \int_S d^4x \sqrt{-g} D_\mu (\phi_\alpha \overleftrightarrow{\partial}^\mu \phi_\beta) \quad (7.4)$$

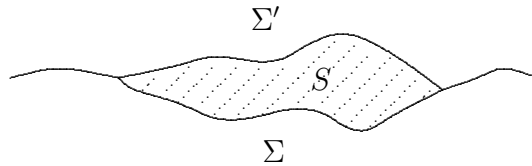

But

$$D_\mu \left(\phi_\alpha \overleftrightarrow{\partial}^\mu \phi_\beta \right) = \phi_\alpha (D_\mu \partial^\mu \phi_\beta) - (D_\mu \partial^\mu \phi_\alpha) \phi_\beta \quad (7.5)$$

$$= \phi_\alpha (m^2 \phi_\beta) - (m^2 \phi_\alpha) \phi_\beta = 0 , \quad (7.6)$$

using the Klein-Gordon equation in the last step.

The antisymmetric form $\phi_\alpha \wedge \phi_\beta$ can be brought to a canonical block diagonal form, with 2×2 blocks $\begin{pmatrix} 0 & 1 \\ -1 & 0 \end{pmatrix}$, by a change of basis (Darboux's theorem). Thus, real solutions of the Klein-Gordon equation can be grouped in pairs (ϕ, ϕ') with $\phi \wedge \phi' = 1$. It then follows that the complex solution $\psi = (\phi - i\phi')/\sqrt{2}$ has unit norm if we define its norm $\|\psi\|$ by $\|\psi\|^2 = \phi \wedge \phi'$ or, equivalently,

$$\|\psi\|^2 = i \int_\Sigma dS_\mu \psi^* \overleftrightarrow{\partial}^\mu \psi . \quad (7.7)$$

More generally, we can introduce a complex basis $\{\psi_i\}$ of solutions of the Klein-Gordon equation with hermitian inner product defined by

$$(\psi_i, \psi_j) = i \int dS_\mu \psi_i^* \overleftrightarrow{\partial}^\mu \psi_j , \quad (7.8)$$

and we can choose this basis such that $(\psi_i, \psi_j) = \delta_{ij}$. This inner product is not positive definite, however, because $\|\psi^*\|^2 = -\|\psi\|^2$. In fact, we can choose the basis $\{\psi_i\}$ such that

$$\begin{pmatrix} (\psi_i, \psi_j) = \delta_{ij} & (\psi_i, \psi_j^*) = 0 \\ (\psi_i^*, \psi_j) = 0 & (\psi_i^*, \psi_j^*) = -\delta_{ij} \end{pmatrix} \quad (7.9)$$

We could interpret the complex solution $\Psi = \sum_i a_i \psi_i$ as the wavefunction of a free particle since $(,)$ is positive-definite when restricted to such solutions, but this cannot work when interactions are present. It is also inapplicable for *real* scalar fields. A real solution Φ of the K-G equation can be written as

$$\Phi(x) = \sum [a_i \psi_i(x) + a_i^* \psi_i^*(x)] \quad (7.10)$$

To quantize we pass to the *quantum* field

$$\Phi(x) = \sum [a_i \psi_i(x) + a_i^\dagger \psi_i^*(x)] \quad (7.11)$$

where $\{a_i\}$ are now operators in a Hilbert space \mathcal{H} with Hermitian conjugates a_i^\dagger satisfying the commutation relations

$$[a_i, a_j] = 0, \quad [a_i, a_j^\dagger] = \delta_{ij} \quad (\hbar = 1) \quad (7.12)$$

We choose the Hilbert space to be the Fock space built from a ‘vacuum’ state $|\text{vac}\rangle$ satisfying

$$a_i |\text{vac}\rangle = 0 \quad \forall i \quad (7.13)$$

$$\langle \text{vac} | \text{vac} \rangle = 1 \quad (7.14)$$

i.e. \mathcal{H} has the basis

$$\left\{ |\text{vac}\rangle, a_i^\dagger |\text{vac}\rangle, a_i^\dagger a_j^\dagger |\text{vac}\rangle, \dots \right\}$$

$\langle | \rangle$ is a positive-definite inner product on this space.

This basis for \mathcal{H} is determined by the choice of $|\text{vac}\rangle$, but this depends on the choice of complex basis $\{\psi_i\}$ of solutions of the K-G equation satisfying (7.9). There are *many* such bases.

Consider $\{\psi'_i\}$ where

$$\psi'_i = \sum_j (A_{ij}\psi_j + B_{ij}\psi_j^*) \quad (7.15)$$

This has the same inner product matrix (7.9) provided that

$$\boxed{\begin{aligned} AA^\dagger - BB^\dagger &= \mathbf{1} \\ AB^\top - BA^\top &= 0 \end{aligned}} \quad (7.16)$$

Inversion of (7.15) leads to

$$\psi_j = \sum_k A'_{jk}\psi'_k + B'_{jk}\psi'^*_k \quad (7.17)$$

where

$$A' = A^\dagger, \quad B' = -B^\top \quad (7.18)$$

Check

$$\psi' = A(A'\psi' + B'\psi'^*) + B(A'^*\psi'^* + B'^*\psi') \quad (7.19)$$

$$= (AA' + BB'^*)\psi' + (AB' + BA'^*)\psi'^* \quad (7.20)$$

$$= (AA^\dagger - BB^\dagger)\psi' - (AB^\top - BA^\top)\psi' \quad (7.21)$$

$$= \psi' \quad (7.22)$$

But A' and B' must satisfy the same conditions as A and B , i.e.

$$A'A'^{\dagger} - B'B'^{\dagger} = \mathbf{1} \quad (7.23)$$

$$A'B'^{\top} - B'A'^{\top} = 0 \quad (7.24)$$

Equivalently,

$$\boxed{\begin{aligned} A^{\dagger}A - B^{\top}B^* &= \mathbf{1} \\ A^{\dagger}B - B^{\top}A^* &= 0 \end{aligned}} \quad (7.25)$$

These conditions are not implied by (7.16); the additional information contained in them is the invertibility of the change of basis.

In a general spacetime there is no ‘preferred’ choice of basis satisfying (7.9) and so no preferred choice of vacuum. In a stationary spacetime, however, we can choose the basis $\{u_i\}$ of *positive frequency* eigenfunctions of k , i.e.

$$k^{\mu}\partial_{\mu}u_i = -i\omega_i u_i, \quad \omega_i \geq 0 \quad (7.26)$$

Notes

- (1) Since k is Killing it maps solutions of the Klein-Gordon equation to solutions (**Proof: Exercise**).
- (2) k is anti-hermitian, so it can be diagonalized with pure-imaginary eigenvalues.
- (3) Eigenfunctions with distinct eigenvalues are orthogonal so

$$(u_i, u_j^*) = 0 \quad (7.27)$$

We can normalize $\{u_i\}$ s.t. $(u_i, u_j) = \delta_{ij}$, so the basis $\{u_i\}$ can be chosen s.t. (7.9) is satisfied.

- (4) We exclude functions with $\omega = 0$.

For this choice of basis the vacuum state $|\text{vac}\rangle$ is actually the state of lowest energy. The states $a_i^{\dagger}|\text{vac}\rangle$ are one-particle states, $a_i^{\dagger}a_j^{\dagger}|\text{vac}\rangle$ two-particle states, etc., and

$$N = \sum_i a_i^{\dagger}a_i \quad (7.28)$$

is the particle number operator.

7.2 Particle Production in Non-Stationary Spacetimes

Consider a ‘sandwich’ spacetime $M = M_- \cup M_0 \cup M_+$

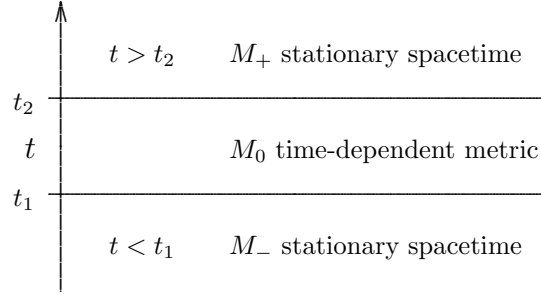

In M_- we can choose to expand a scalar field solution of the Klein-Gordon equation as

$$\Phi(x) = \sum_i \left[a_i u_i(x) + a_i^\dagger u_i^*(x) \right] \quad \text{in } M_- \quad (7.29)$$

The functions $u_i(x)$ solve the KG equation in M_- but not in M , so its continuation through M_0 will lead to some new function $\psi_i(x)$ in M_+ , so

$$\Phi(x) = \sum_i \left[a_i \psi_i(x) + a_i^\dagger \psi_i^*(x) \right] \quad \text{in } M_+ \quad (7.30)$$

Because the inner product $(\ , \)$ was independent of the hypersurface Σ , the matrix of inner products will still be as before, i.e. as in (7.9). But, as we have seen this implies only that

$$\psi_i = \sum_j (A_{ij} u_j + B_{ij} u_j^*) \quad (7.31)$$

for some matrices A and B satisfying (7.16). Thus, in M_+

$$\Phi(x) = \sum_i \left(a_i \psi_i + a_i^\dagger \psi_i^* \right) \quad (7.32)$$

$$= \sum_i \left[a_i \sum_j (A_{ij} u_j + B_{ij} u_j^*) + a_i^\dagger \sum_j (A_{ij}^* u_j^* + B_{ij}^* u_j) \right] \quad (7.33)$$

$$= \sum_i \left[a'_i u_i(x) + a_i'^\dagger u_i^*(x) \right] \quad (7.34)$$

where

$$\boxed{a'_j = \sum_i (a_i A_{ij} + a_i^\dagger B_{ij}^*)} \quad (7.35)$$

This is called a *Bogoliubov transformation*. A and B are the *Bogoliubov coefficients*.

Note that (**Exercise**)

$$\left. \begin{aligned} [a'_i, a'_j] &= 0 \\ [a'_i, a'_j{}^\dagger] &= \delta_{ij} \end{aligned} \right\} \Leftrightarrow \text{relations (7.25) satisfied by } A \text{ \& } B \quad (7.36)$$

If $B = 0$ then (7.16) and (7.25) imply $A^\dagger A = AA^\dagger = 1$, i.e. the change of basis from $\{u_i\}$ to $\{\psi_i\}$ is just a unitary transformation which permutes the annihilation operators but does not change the definition of the vacuum.

The particle number operator for the i^{th} mode of k is

$$\begin{aligned} N_i &= a_i^\dagger a_i && \text{in } M_- \\ N'_i &= a_i'^\dagger a'_i && \text{in } M_+ \end{aligned} \quad (7.37)$$

The state with no particles in M_- is $|\text{vac}\rangle$ s.t. $a_i |\text{vac}\rangle = 0 \forall i$. The expected number of particles in the i^{th} mode in M_+ is then

$$\langle N'_i \rangle \equiv \langle \text{vac} | N'_i | \text{vac} \rangle = \langle \text{vac} | a_i'^\dagger a'_i | \text{vac} \rangle \quad (7.38)$$

$$= \sum_{j,k} \langle \text{vac} | (a_k B_{ki}) (a_j^\dagger B_{ji}^*) | \text{vac} \rangle \quad (7.39)$$

$$= \sum_{j,k} \underbrace{\langle \text{vac} | a_k a_j^\dagger | \text{vac} \rangle}_{\delta_{kj}} B_{ki} B_{ij}^\dagger \quad (7.40)$$

$$= (B^\dagger B)_{ii} \quad (7.41)$$

The expected total number of particles is therefore $\text{tr}(B^\dagger B)$. Since $B^\dagger B$ is positive semi-definite, this vanishes iff $B = 0$.

7.3 Hawking Radiation

The spacetime associated to gravitational collapse to a black hole cannot be everywhere stationary so we expect particle creation. But the exterior spacetime is stationary at late times, so we might expect particle creation to be just a transient phenomenon determined by details of the collapse.

But the *infinite time dilation* at the horizon of a black hole means that particles created in the collapse can take arbitrarily long to escape - suggests a possible flux of particles at late times that is due to the existence of the horizon and *independent of the details of the collapse*. There is such a particle flux, and it turns out to be thermal - this is *Hawking radiation*

We shall consider only a massless scalar field Φ in a Schwarzschild black hole spacetime. From Question IV.4 we learn that the positive frequency outgoing modes of Φ have the behaviour

$$\Phi_\omega \sim e^{-i\omega u} \tag{7.42}$$

near \mathfrak{S}^+ . Consider a geometric optics approximation in which a particle's worldline is a null ray, γ , of constant phase u , and trace this ray backwards in time from \mathfrak{S}^+ . The later it reaches \mathfrak{S}^+ the closer it must approach \mathcal{H}^+ in the exterior spacetime before entering the star.

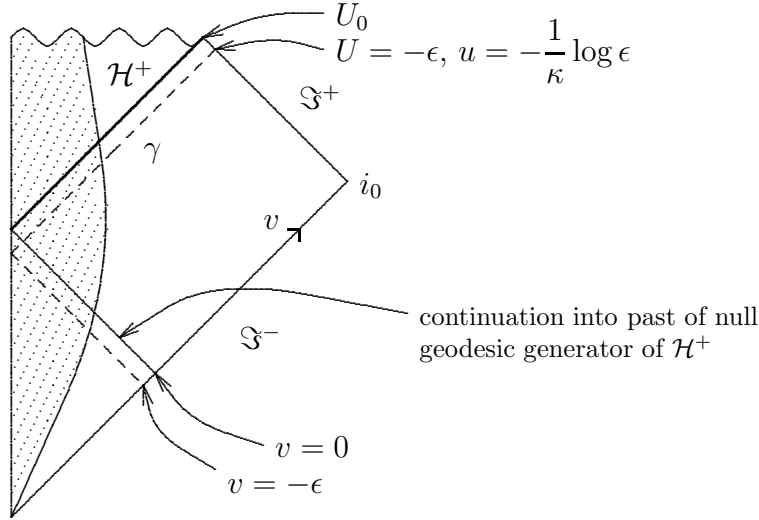

The ray γ is one of a family of rays whose limit as $t \rightarrow \infty$ is a null geodesic generator, γ_H , of \mathcal{H}^+ . We can specify γ by giving its affine distance from γ_H along an ingoing null geodesic through \mathcal{H}^+

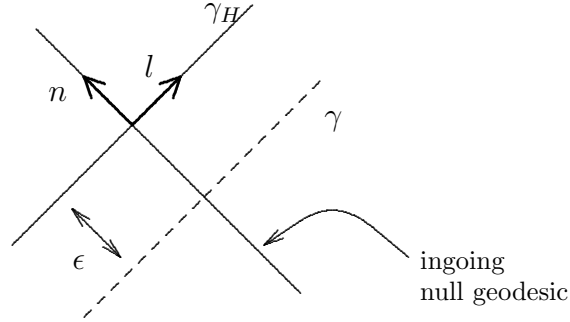

The affine parameter on this ingoing null geodesic is U , so $U = -\epsilon$. Equivalently

$$u = -\frac{1}{\kappa} \log \epsilon \quad (\text{on } \gamma \text{ near } \mathcal{H}^+) \quad (7.43)$$

so

$$\Phi_\omega \sim \exp\left(\frac{i\omega}{\kappa} \log \epsilon\right) \quad \text{near } \mathcal{H}^+ \quad (7.44)$$

This oscillates increasingly rapidly as $\epsilon \rightarrow 0$, so *the geometric optics approximation is justified at late times.*

We need to match Φ_ω onto a solution of the K-G equation near \mathfrak{S}^- . In the geometric optics approximation we just parallelly-transport n and l back to \mathfrak{S}^- along the continuation of γ_H . Let this continuation meet \mathfrak{S}^- at $v = 0$. The continuation of the ray γ back to \mathfrak{S}^- will now meet \mathfrak{S}^- at an affine distance ϵ along an outgoing null geodesic on \mathfrak{S}^-

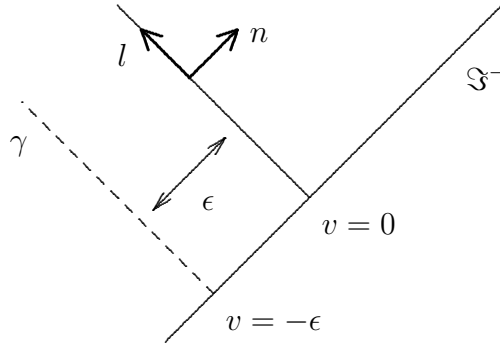

The affine parameter on outgoing null geodesics in \mathfrak{S}^- is v (since $ds^2 = du dv + r^2 d\Omega^2$ on \mathfrak{S}^-), so $v = -\epsilon$ on γ so

$$\Phi_\omega \sim \exp\left\{\frac{i\omega}{\kappa} \log(-v)\right\} \quad (7.45)$$

This is for $v < 0$. For $v > 0$ an ingoing null ray from \mathfrak{S}^- passes through \mathcal{H}^+ and doesn't reach \mathfrak{S}^+ , so $\Phi_\omega = \Phi_\omega(v)$ on \mathfrak{S}^- , where

$$\Phi_\omega(v) = \begin{cases} 0 & v > 0 \\ \exp\left(\frac{i\omega}{\kappa} \log(-v)\right) & v < 0 \end{cases} \quad (7.46)$$

Take the Fourier transform,

$$\tilde{\Phi}_\omega = \int_{-\infty}^{\infty} e^{i\omega'v} \Phi_\omega(v) dv \quad (7.47)$$

$$= \int_{-\infty}^0 \exp\left\{i\omega'v + \frac{i\omega}{\kappa} \log(-v)\right\} dv \quad (7.48)$$

Lemma

$$\boxed{\tilde{\Phi}_\omega(-\omega') = -\exp\left(-\frac{\pi\omega}{\kappa}\right) \tilde{\Phi}_\omega(\omega') \quad \text{for } \omega' > 0} \quad (7.49)$$

Proof Choose branch cut in complex v -plane to lie along the real axis

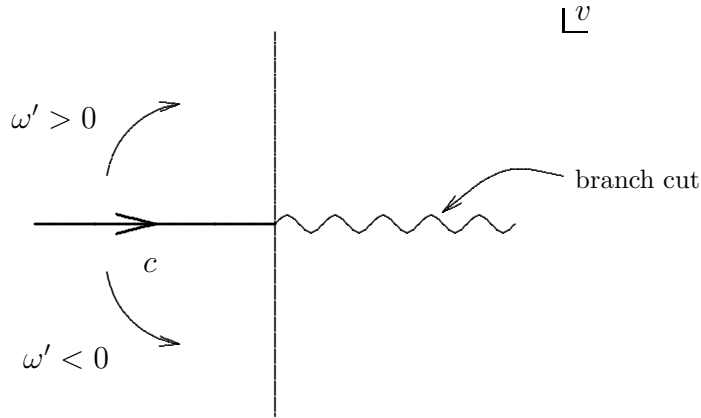

For $\omega' > 0$ rotate contour to the positive imaginary axis and then set $v = ix$ to get

$$\tilde{\Phi}_\omega(\omega') = -i \int_0^{\infty} \exp\left\{-\omega'x + \frac{i\omega}{\kappa} \log\left(xe^{-i\pi/2}\right)\right\} dx \quad (7.50)$$

$$= -\exp\left(\frac{\pi\omega}{2\kappa}\right) \int_0^{\infty} \exp\left\{-\omega'x + \frac{i\omega}{\kappa} \log(x)\right\} dx \quad (7.51)$$

Since $\omega' > 0$ the integral converges. When $\omega' < 0$ we rotate the contour to the negative imaginary axis and then set $v = -ix$ to get

$$\tilde{\Phi}_\omega(\omega') = i \int_0^\infty \exp \left\{ \omega' x + \frac{i\omega}{\kappa} \log \left(x e^{i\pi/2} \right) \right\} dx \quad (7.52)$$

$$= \exp \left(-\frac{\pi\omega}{2\kappa} \right) \int_0^\infty \exp \left\{ \omega' x + \frac{i\omega}{\kappa} \log(x) \right\} dx \quad (7.53)$$

Hence the result.

Corollary A mode of *positive* frequency ω on \mathfrak{S}^+ , *at late times*, matches onto *mixed positive and negative* modes on \mathfrak{S}^- . We can identify (for positive ω')

$$A_{\omega\omega'} = \tilde{\Phi}_\omega(\omega') \quad (7.54)$$

$$B_{\omega\omega'} = \tilde{\Phi}_\omega(-\omega') = -e^{-\pi\omega/\kappa} \tilde{\Phi}_\omega(\omega') \quad (7.55)$$

as the Bogoliubov coefficients. We see that

$$\boxed{B_{ij} = -e^{-\pi\omega_i/\kappa} A_{ij}} \quad (7.56)$$

But the matrices A and B must satisfy the Bogoliubov relations, e.g.

$$\delta_{ij} = \left(AA^\dagger - BB^\dagger \right)_{ij} \quad (7.57)$$

$$= \sum_k A_{ik} A_{jk}^* - B_{ik} B_{jk}^* \quad (7.58)$$

$$= \left[e^{\pi(\omega_i + \omega_j)/\kappa} - 1 \right] \sum_k B_{ik} B_{jk}^* \quad (7.59)$$

Take $i = j$ to get

$$\left(BB^\dagger \right)_{ii} = \frac{1}{e^{2\pi\omega_i/\kappa} - 1} \quad (7.60)$$

Now, what we actually need are the *inverse* Bogoliubov coefficients corresponding to a positive frequency mode on \mathfrak{S}^- matching onto mixed positive and negative frequency modes on \mathfrak{S}^+ . As we saw earlier, the inverse B coefficient is

$$B' = -B^\top \quad (7.61)$$

The late time particle flux through \mathfrak{S}^+ given a vacuum on \mathfrak{S}^- is

$$\langle N_i \rangle_{\mathfrak{S}^+} = \left((B')^\dagger B' \right)_{ii} = \left(B^* B^\top \right)_{ii} = \left(BB^\top \right)_{ii}^* \quad (7.62)$$

But $(BB^\top)_{ii}$ is real so

$$\boxed{\langle N_i \rangle_{\mathfrak{S}^+} = \frac{1}{e^{2\pi\omega_i/\kappa} - 1}} \quad (7.63)$$

This is the Planck distribution for black body radiation at the Hawking temperature

$$T_H = \frac{\hbar\kappa}{2\pi} \quad (7.64)$$

We conclude that at late times the black hole radiates away its energy at this temperature. From Stephan's law

$$\frac{dE}{dt} \simeq -\sigma AT_H^4, \quad \left(\sigma = \frac{\pi^2 k_B^4}{60\hbar^3 c^2} \right) \quad (7.65)$$

where A is the black hole area. Since

$$E = Mc^2, \quad A = \left(\frac{MG}{c^2} \right)^2, \quad k_B T_H \sim \frac{\hbar c^3}{GM} \quad (7.66)$$

we have

$$\frac{dM}{dt} \sim \frac{\hbar c^4}{G^2 M^2} \quad (7.67)$$

which gives a lifetime

$$\tau \sim \left(\frac{G^2}{\hbar c^4} \right) M^3 \quad (7.68)$$

Note The calculation of Hawking radiation assumed no backreaction, i.e. M was taken to be constant. This is a good approximation when $dM/dt \ll M$, but fails in the final stages of evaporation.

7.4 Black Holes and Thermodynamics

Since $T = \frac{\hbar\kappa}{2\pi}$ is the black hole temperature, we can now rewrite the 1st law of black hole mechanics as

$$dM = TdS_{\text{BH}} + \Omega_H dJ + \Phi_H dQ, \quad (\Omega_H, \Phi_H \text{ intensive, } J, Q \text{ extensive}) \quad (7.69)$$

where

$$\boxed{S_{\text{BH}} = \frac{A}{4\hbar}} \quad (7.70)$$

is the black hole (or Beckenstein-Hawking) entropy.

Clearly, black hole evaporation via Hawking radiation will cause S_{BH} to *decrease* in violation of the 2nd law of black hole mechanics (derived on the assumption of classical physics). But the entropy is

$$S = S_{\text{BH}} + S_{\text{ext}} \tag{7.71}$$

where S_{ext} is the entropy of matter in exterior spacetime. But because the Hawking radiation is *thermal*, S_{ext} increases with the result that S is a non-decreasing function of time. This suggests:

Generalized 2nd Law of Thermodynamics

$S = S_{\text{BH}} + S_{\text{ext}}$ is always a non-decreasing function of time (in any process).

This was first suggested by Beckenstein (without knowledge of the precise form of S_{BH}) on the grounds that the entropy in the exterior spacetime could be decreased by throwing matter into a black hole. This would violate the 2nd law of thermodynamics unless the black hole is assigned an entropy.

7.4.1 The Information Problem

Taking Hawking radiation into account, a black hole that forms from gravitational collapse will eventually evaporate, after which the spacetime has no event horizon. This is depicted by the following CP diagram:

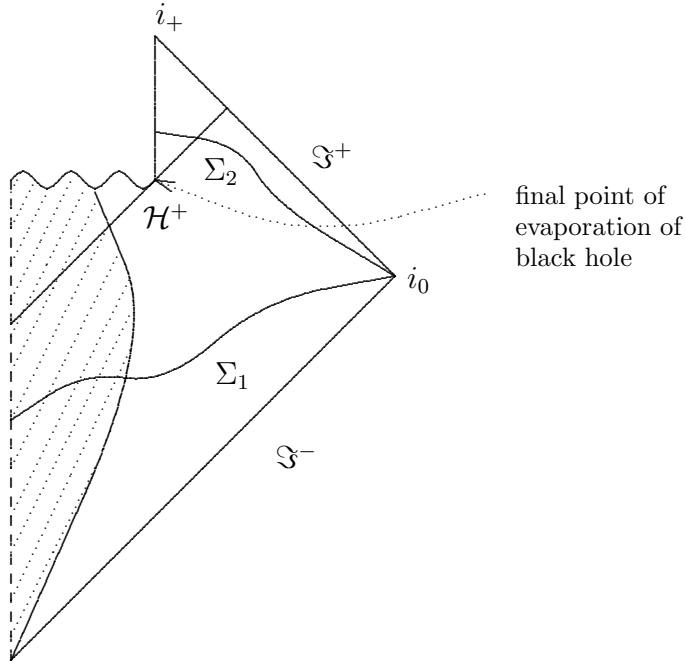

Σ_1 is a Cauchy surface for this spacetime, but Σ_2 is not because its past domain of dependence $D^-(\Sigma_2)$ does not include the black hole region. Information from Σ_1 can propagate into the black hole region instead of to Σ_2 . Thus it appears that information is ‘lost’ into the black hole. This would imply a *non-unitary* evolution from Σ_1 to Σ_2 , and hence put QFT in curved spacetime in conflict with a basic principle of Q.M. However, from the point of view of a static external observer, nothing actually passes through \mathcal{H}^+ , so maybe the information is not really lost. A complete calculation including all back-reaction effects might resolve the issue, but even this is controversial since some authors claim that the resolution requires an understanding of the Planck scale physics. The point is that whereas QFT in curved spacetime predicts $T_{\text{loc}} \rightarrow \infty$ on the horizon of a black hole, this should not be believed when kT reaches the Planck energy $(\hbar c/G)^{1/2} c^2$ because i) Quantum Gravity effects cannot then be ignored and ii) this temperature is then of the order maximum (Hagedorn) temperature in string theory.

Appendix A

Example Sheets

A.1 Example Sheet 1

1. Explain why

(i) GR effects are important for neutron stars but not for white dwarfs

(ii) inverse beta-decay becomes energetically favourable for densities higher than those in white dwarfs.

2. Use Newtonian theory to derive the Newtonian pressure support equation

$$P'(r) \equiv \frac{dP}{dr} = -\frac{Gm\rho}{r^2},$$

where

$$m = 4\pi \int_0^r \tilde{r}^2 \rho(\tilde{r}) d\tilde{r},$$

for a spherically-symmetric and static star with pressure $P(r)$ and density $\rho(r)$. Show that

$$\begin{aligned} \int_0^r P(\tilde{r}) \tilde{r}^3 d\tilde{r} &= \frac{P(r)r^4}{4} - \frac{1}{4} \int_0^r P'(\tilde{r}) \tilde{r}^4 d\tilde{r} \\ &= \frac{Gm^2(r)}{32\pi} + \frac{P(r)r^4}{4}. \end{aligned}$$

Assuming that $P' \leq 0$, with $P = 0$ at the star's surface, show that

$$\frac{d}{dr} \left[\left(\int_0^r P(\tilde{r}) \tilde{r}^3 d\tilde{r} \right)^{3/4} \right] \leq \frac{3\sqrt{2}}{4} P^{3/4} r^2.$$

Assuming the bound

$$P \lesssim (\hbar c)n_e^{4/3},$$

where $n_e(r)$ is the electron number density, show that the total mass, M , of the star satisfies

$$M \lesssim \left(\frac{\hbar c}{G}\right)^{3/2} \left(\frac{\mu_e}{m_N}\right)^2$$

where m_N is the nucleon mass and μ_e is the number of electrons per nucleon. Why is it reasonable to bound the pressure as you have done? Compare your bound with Chandrasekhar's limit.

3. A particle orbits a Schwarzschild black hole with non-zero angular momentum per unit mass h . Given that $\sigma = 0$ for a massless particle and $\sigma = 1$ for a massive particle, show that the orbit satisfies

$$\frac{d^2u}{d\phi^2} + u = \frac{M\sigma}{h^2} + 3Mu^2$$

where $u = 1/r$ and ϕ is the azimuthal angle. Verify that this equation is solved by

$$u = \frac{1}{6M} + \frac{2\omega^2}{3M} - \frac{2\omega^2}{M \cosh^2(\omega\phi)},$$

where ω is given by

$$4\omega^2 = \pm \sqrt{\left(1 - \frac{12M^2\sigma}{h^2}\right)}.$$

where $\sigma = 1$ for a massive particle and $\sigma = 0$ for a massless particle. Interpret these orbits in terms of the effective potential. Comment on the cases $\omega^2 = 1/4$, $\omega^2 = 1/8$ and $\omega^2 = 0$.

4. A photon is emitted outward from a point P outside a Schwarzschild black hole with radial coordinate r in the range $2M < r < 3M$. Show that if the photon is to reach infinity the angle its initial direction makes with the radial direction (as determined by a stationary observer at P) cannot exceed

$$\arcsin \sqrt{\frac{27M^2}{r^2} \left(1 - \frac{2M}{r}\right)}.$$

5. Show that in region II of the Kruskal manifold one may regard r as a time coordinate and introduce a new spatial coordinate x such that

$$ds^2 = -\frac{dr^2}{\left(\frac{2M}{r} - 1\right)} + \left(\frac{2M}{r} - 1\right) dx^2 + r^2 d\Omega^2 .$$

Hence show that *every* timelike curve in region II intersects the singularity at $r = 0$ within a proper time no greater than πM . For what curves is this bound attained? Compare your result with the time taken for the collapse of a ball of pressure free matter of the same gravitational mass M . Calculate the binding energy of such a ball of dust as a fraction of its (conserved) rest mass.

6. Using the map

$$(t, x, y, z) \mapsto X = \begin{pmatrix} t + z & x + iy \\ x - iy & t - z \end{pmatrix} ,$$

show that Minkowski spacetime may be identified with the space of Hermitian 2×2 matrices X with metric

$$ds^2 = -\det(dX) .$$

Using the Cayley map $X \mapsto U = \frac{1+iX}{1-iX}$, show further that Minkowski spacetime may be identified with the space of unitary 2×2 matrices U for which $\det(1+U) \neq 0$. Now show that any 2×2 unitary matrix U may be expressed uniquely in terms of a real number τ and two complex numbers α, β , as

$$U = e^{i\tau} \begin{pmatrix} \alpha & \beta \\ -\bar{\beta} & \bar{\alpha} \end{pmatrix}$$

where the parameters (τ, α, β) satisfy $|\alpha|^2 + |\beta|^2 = 1$, and are subject to the identification

$$(\tau, \alpha, \beta) \sim (\tau + \pi, -\alpha, -\beta) .$$

Using the relation

$$(1 + U)dX = -2idU(1 + U)^{-1} ,$$

deduce that

$$ds^2 = \frac{1}{(\cos \tau + \operatorname{Re} \alpha)^2} (-d\tau^2 + |d\alpha|^2 + |d\beta|^2)$$

is the metric on Minkowski spacetime and hence conclude that the conformal compactification of Minkowski spacetime may be identified with the space of unitary 2×2 matrices, i.e the group $U(2)$. Explain how $U(2)$ may be identified with a portion of the Einstein static universe $S^3 \times \mathbb{R}$.

A.2 Example Sheet 2

1. Let ζ be a Killing vector field. Prove that

$$D_\sigma D_\mu \zeta_\nu = R_{\nu\mu\sigma}{}^\lambda \zeta_\lambda ,$$

where $R_{\nu\mu\sigma\lambda}$ is the Riemann tensor, defined by $[D_\mu, D_\nu] v_\rho = R_{\mu\nu\rho}{}^\sigma v_\sigma$ for arbitrary vector field v .

2. A conformal Killing vector is one for which

$$(\mathcal{L}_\xi g)_{\mu\nu} = \Omega^2 g_{\mu\nu} .$$

for some non-zero function Ω . Given that ξ is a Killing vector of ds^2 , show that it is a conformal Killing vector of the conformally-equivalent metric $\Lambda^2 ds^2$ for arbitrary (non-vanishing) conformal factor Λ .

Show that the action for a *massless* particle,

$$S[x, e] = \frac{1}{2} \int d\lambda e^{-1} \dot{x}^\mu \dot{x}^\nu g_{\mu\nu}(x) ,$$

is invariant, to first order in the constant α , under the transformation

$$x^\mu \rightarrow x^\mu + \alpha \xi^\mu(x) \quad e \rightarrow e + \frac{1}{4} \alpha e g^{\mu\nu} (\mathcal{L}_\xi g)_{\mu\nu}$$

if $\xi = \xi^\mu \partial_\mu$ is a conformal Killing vector. Show that ξ is the operator corresponding to the conserved charge implied by Noether's theorem.

3. Show that the extreme RN metric in isotropic coordinates is

$$ds^2 = - \left(1 + \frac{M}{\rho}\right)^{-2} dt^2 + \left(1 + \frac{M}{\rho}\right)^2 (d\rho^2 + \rho^2 d\Omega^2) \quad (\dagger)$$

Verify that $\rho = 0$ is at infinite proper distance from any finite ρ along any curve of constant t . Verify also that $|t| \rightarrow \infty$ as $\rho \rightarrow 0$ along any timelike or null curve but that a timelike or null ingoing radial geodesic reaches $\rho = 0$ for *finite* affine parameter. By introducing a null coordinate to replace ρ show that $\rho = 0$ is merely a coordinate singularity and hence that the metric (\dagger) is geodesically incomplete. What happens to the particles that reach $\rho = 0$? Illustrate your answers using a Penrose diagram.

4. The action for a particle of mass m and charge q is

$$S[x, e] = \int d\lambda \left[\frac{1}{2} e^{-1} \dot{x}^\mu \dot{x}^\nu g_{\mu\nu}(x) - \frac{1}{2} m^2 e - q \dot{x}^\mu A_\mu(x) \right] \quad (*)$$

where A_μ is the electromagnetic 4-potential. Show that if

$$(\mathcal{L}_\xi A)_\mu \equiv \xi^\nu \partial_\nu A_\mu + (\partial_\mu \xi^\nu) A_\nu = 0$$

for Killing vector ξ , then S is invariant, to first-order in ξ , under the transformation $x^\mu \rightarrow x^\mu + \alpha \xi^\mu(x)$. Verify that the corresponding Noether charge

$$-\xi^\mu (m u_\mu - q A_\mu) ,$$

where u^μ is the particle's 4-velocity, is a constant of the motion. Verify for the Reissner-Nordstrom solution of the vacuum Einstein-Maxwell equations, with mass M and charge Q , that $\mathcal{L}_k A = 0$ for $k = \frac{\partial}{\partial t}$ and hence deduce, for $m \neq 0$, that

$$\left(1 - \frac{2M}{r} + \frac{Q^2}{r^2}\right) \frac{dt}{d\tau} = \varepsilon - \frac{q}{m} \frac{Q}{r} ,$$

where τ is the particle's proper time and ε is the energy per unit mass. Show that the trajectories $r(t)$ of massive particles with zero angular momentum satisfy

$$\left(\frac{dr}{d\tau}\right)^2 = (\varepsilon^2 - 1) + \left(1 - \varepsilon \frac{qQ}{mM}\right) \frac{2M}{r} + \left(\left(\frac{q}{m}\right)^2 - 1\right) \frac{Q^2}{r^2} .$$

Give a physical interpretation of this result for the special case for which $q^2 = m^2$, $qQ = mM$, and $\varepsilon = 1$.

5. Show that the action

$$S[p, x, e] = \int d\lambda \left\{ p_\mu \dot{x}^\mu - \frac{1}{2} e [g^{\mu\nu}(x) p_\mu p_\nu + m^2] \right\}$$

for a point particle of mass m is equivalent, for $q = 0$, to the action of Q.4. Show that S is invariant to first order in α under the transformation

$$\delta x^\mu = \alpha K^{\mu\nu} p_\nu \quad \delta p_\mu = -\frac{1}{2} \alpha p_\rho p_\sigma \partial_\mu K^{\rho\sigma}$$

for any symmetric tensor $K_{\mu\nu}$ obeying the *Killing tensor* condition

$$D_{(\rho} K_{\mu\nu)} = 0 .$$

Show that the corresponding Noether charge is proportional to $K^{\mu\nu} p_\mu p_\nu$ and verify that it is a constant of the motion. A trivial example is $K_{\mu\nu} = g_{\mu\nu}$; what is the corresponding constant of the motion? Show that $\xi_\mu \xi_\nu$ is a Killing tensor if ξ is a Killing vector. [A Killing tensor that cannot be

constructed from the metric and Killing vectors is said to be irreducible. In a general axisymmetric metric there are no such tensors, and so only three constants of the motion, but for geodesics of the Kerr-Newman metric there is a ‘fourth constant’ of the motion corresponding to an irreducible Killing tensor.]

6. By replacing the time coordinate t by one of the radial null coordinates

$$u = t + \frac{M}{\lambda} \quad v = t - \frac{M}{\lambda}$$

show that the singularity at $\lambda = 0$ of the Robinson-Bertotti (RB) metric

$$ds^2 = -\lambda^2 dt^2 + M^2 \left(\frac{d\lambda}{\lambda} \right)^2 + M^2 d\Omega^2$$

is merely a coordinate singularity. Show also that $\lambda = 0$ is a degenerate Killing Horizon with respect to $\frac{\partial}{\partial t}$. By introducing the new coordinates (U, V) , defined by

$$u = \tan \left(\frac{U}{2} \right) \quad v = -\cot \left(\frac{V}{2} \right)$$

obtain the maximal analytic extension of the RB metric and deduce its Penrose diagram.

A.3 Example Sheet 3

1. Let ε and h be the energy and angular momentum per unit mass of a zero charge particle in free fall within the equatorial plane, i.e on a timelike ($\sigma = 1$) or null ($\sigma = 0$) geodesic with $\theta = \pi/2$, of a Kerr-Newman black hole. Show that the particle's Boyer-Lindquist radial coordinate r satisfies

$$\left(\frac{dr}{d\lambda}\right)^2 = \varepsilon^2 - V_{eff}(r),$$

where λ is an affine parameter, and the effective potential V_{eff} is given by

$$V_{eff} = \left(1 - \frac{2M}{r} + \frac{e^2}{r^2}\right) \left(\sigma + \frac{h^2}{r^2}\right) + \frac{2a\varepsilon h}{r^3} \left(2M - \frac{e^2}{r}\right) + \frac{a^2}{r^2} \left[\sigma - \varepsilon^2 \left(1 + \frac{2M}{r} - \frac{e^2}{r^2}\right)\right].$$

2. Show that the surface gravity of the event horizon of a Kerr black hole of mass M and angular momentum J is given by

$$\kappa = \frac{\sqrt{M^4 - J^2}}{2M(M^2 + \sqrt{M^4 - J^2})}.$$

3. A particle at fixed r and θ in a stationary spacetime, with metric $ds^2 = g_{\mu\nu}(r, \theta)dx^\mu dx^\nu$, has angular velocity $\Omega = \frac{d\phi}{dt}$ with respect to infinity. Show that $\Omega(r, \theta)$ must satisfy

$$g_{tt} + 2g_{t\phi}\Omega + g_{\phi\phi}\Omega^2 \leq 0$$

and hence deduce that

$$\mathcal{D} \equiv g_{t\phi}^2 - g_{tt}g_{\phi\phi} \geq 0$$

Show that $\mathcal{D} = \Delta(r) \sin^2 \theta$ for the Kerr-Newman metric in Boyer-Lindquist coordinates, where $\Delta = r^2 - 2Mr + a^2 + e^2$. What happens if (r, θ) are such that $\mathcal{D} < 0$? For what values of (r, θ) can Ω vanish? Given that r_\pm are the roots of Δ , show that when $\mathcal{D} = 0$

$$\Omega = \frac{a}{r_\pm^2 + a^2}.$$

4. Show that the area of the event horizon of a Kerr-Newman black hole is

$$A = 8\pi \left[M^2 - \frac{e^2}{2} + \sqrt{M^4 - e^2 M^2 - J^2} \right].$$

5. A perfect fluid has stress tensor

$$T_{\mu\nu} = (\rho + P)u_\mu u_\nu + P g_{\mu\nu} ,$$

where ρ is the density and $P(\rho)$ the pressure. State the dominant energy condition for $T_{\mu\nu}$ and show that for a perfect fluid in Minkowski spacetime this condition is equivalent to

$$\rho \geq |P| .$$

Show that the same condition arises from the requirement of causality, i.e. that the speed of sound, $\sqrt{|dP/d\rho|}$, not exceed that of light, together with the fact that the pressure vanishes in the vacuum.

6. The vacuum Einstein-Maxwell equations are

$$G_{\mu\nu} = 8\pi T_{\mu\nu}(F) \quad D_\mu F^{\mu\nu} = 0$$

where $F_{\mu\nu} = \partial_\mu A_\nu - \partial_\nu A_\mu$, and

$$T_{\mu\nu}(F) = \frac{1}{4\pi}(F_\mu{}^\lambda F_{\nu\lambda} - \frac{1}{4}g_{\mu\nu}F^{\alpha\beta}F_{\alpha\beta}) .$$

Asymptotically-flat solutions are stationary and axisymmetric if the metric admits Killing vectors k and m that can be taken to be $k = \frac{\partial}{\partial t}$ and $m = \frac{\partial}{\partial \phi}$ near infinity, and if (for some choice of electromagnetic gauge)

$$\mathcal{L}_k A = \mathcal{L}_m A = 0 ,$$

where the Lie derivative of A with respect to a vector ξ , $\mathcal{L}_\xi A$, is as defined in Q.4 of Example Sheet 2. The event horizon of such a solution is necessarily a Killing horizon of $\xi = k + \Omega_H m$, for some constant Ω_H . What is the physical interpretation of Ω_H ? What is its value for the Kerr-Newman solution? The co-rotating electric potential is defined by

$$\Phi = \xi^\mu A_\mu .$$

Use the fact that $R_{\mu\nu}\xi^\mu\xi^\nu = 0$ on a Killing horizon to show that Φ is constant on the horizon. In particular, show that for a choice of the electromagnetic gauge for which $\Phi = 0$ at infinity,

$$\Phi_H = \frac{Qr_+}{r_+^2 + a^2}$$

for a charged rotating black hole, where $r_+ = M + \sqrt{M^2 - Q^2 - a^2}$.

7. Let (\mathcal{M}, g, A) be an asymptotically flat, stationary, axisymmetric, solution of the Einstein-Maxwell equations of Q.6 and let Σ be a spacelike hypersurface with one boundary at spatial infinity and an internal boundary, H , at the event horizon of a black hole of charge Q . Show that

$$-2 \int_{\Sigma} dS_{\mu} T^{\mu}{}_{\nu}(F) \xi^{\nu} = \Phi_H Q$$

where Φ_H is the co-rotating electric potential on the horizon. Use this result to deduce that the mass M of a charged rotating black hole is given by

$$M = \frac{\kappa A}{4\pi} + 2\Omega_H J + \Phi_H Q .$$

where J is the total angular momentum. Use this formula for M to deduce the first law of black hole mechanics for charged rotating black holes:

$$dM = \frac{\kappa}{8\pi} dA + \Omega_H dJ + \Phi_H dQ .$$

[Hint: $\mathcal{L}_{\xi}(F^{\mu\nu} A_{\nu}) = 0$]

A.4 Example Sheet 4

1. Use the Komar integral,

$$J = \frac{1}{16\pi G} \oint_{\infty} dS_{\mu\nu} D^{\mu} m^{\nu} ,$$

for the total angular momentum of an asymptotically-flat axisymmetric spacetime (with Killing vector m) to verify that $J = Ma$ for the Kerr-Newman solution with parameter a .

2. Let l and n be two linearly independent vectors and \hat{B} a second rank tensor such that

$$\hat{B}_{\mu}{}^{\nu} l_{\nu} = \hat{B}_{\mu}{}^{\nu} n_{\nu} = 0 .$$

Given that $\eta^{(i)}$ ($i = 1, 2$) are two further linearly independent vectors, show that

$$\varepsilon^{\mu\nu\rho\sigma} l_{\mu} n_{\nu} \hat{B}_{\rho}{}^{\lambda} (\eta_{\lambda}^{(1)} \eta_{\sigma}^{(2)} - \eta_{\sigma}^{(1)} \eta_{\lambda}^{(2)}) = \theta \varepsilon^{\mu\nu\rho\sigma} l_{\mu} n_{\nu} \eta_{\rho}^{(1)} \eta_{\sigma}^{(2)} .$$

where $\theta = \hat{B}_{\alpha}{}^{\alpha}$.

3. Let \mathcal{N} be a Killing horizon of a Killing vector field ξ , with surface gravity κ . Explain why, for any third-rank totally-antisymmetric tensor A , the scalar $\Psi = A^{\mu\nu\rho} (\xi_{\mu} D_{\nu} \xi_{\rho})$ vanishes on \mathcal{N} . Use this to show that

$$(\xi_{[\rho} D_{\sigma]} \xi_{\nu})(D^{\nu} \xi^{\mu}) = \kappa \xi_{[\rho} D_{\sigma]} \xi^{\mu} \quad (\text{on } \mathcal{N}) , \quad (*)$$

where the square brackets indicate antisymmetrization on the enclosed indices.

From the fact that Ψ vanishes on \mathcal{N} it follows that its derivative on \mathcal{N} is normal to \mathcal{N} , and hence that $\xi_{[\mu} \partial_{\nu]} \Psi = 0$ on \mathcal{N} . Use this fact and the Killing vector lemma of Q.II.1 to deduce that, on \mathcal{N} ,

$$(\xi_{\nu} R_{\sigma\rho[\beta}{}^{\lambda} \xi_{\alpha]} + \xi_{\rho} R_{\nu\sigma[\beta}{}^{\lambda} \xi_{\alpha]} + \xi_{\sigma} R_{\rho\nu[\beta}{}^{\lambda} \xi_{\alpha]}) \xi_{\lambda} .$$

Contract on ρ and α and use the fact that $\xi^2 = 0$ on \mathcal{N} to show that

$$\xi^{\nu} \xi_{[\rho} R_{\sigma]\nu\mu}{}^{\lambda} \xi_{\lambda} = -\xi_{\mu} \xi_{[\rho} R_{\sigma]}{}^{\lambda} \xi_{\lambda} \quad (\text{on } \mathcal{N}) , \quad (\dagger)$$

where $R_{\mu\nu}$ is the Ricci tensor.

For any vector v the scalar $\Phi = (\xi \cdot D\xi - \kappa\xi) \cdot v$ vanishes on \mathcal{N} . It follows that $\xi_{[\mu} \partial_{\nu]} \Phi|_{\mathcal{N}} = 0$. Show that this fact, the result (*) derived above and the Killing vector lemma imply that, on \mathcal{N} ,

$$\begin{aligned} \xi^{\mu} \xi_{[\rho} \partial_{\sigma]} \kappa &= \xi^{\nu} R_{\mu\nu[\sigma}{}^{\lambda} \xi_{\rho]} \xi_{\lambda} \\ &= \xi^{\nu} \xi_{[\rho} R_{\sigma]\nu\mu}{}^{\lambda} \xi_{\lambda} , \end{aligned}$$

where the second line is a consequence of the cyclic identity satisfied by the Riemann tensor. Now use (\dagger) to show that, on \mathcal{N} ,

$$\xi^\mu \xi_{[\rho} \partial_{\sigma]} \kappa = \xi_{[\sigma} R_{\rho]}^\lambda \xi_\lambda \quad (\text{A.1})$$

$$= 8\pi G \xi_{[\sigma} T_{\rho]}^\lambda \xi_\lambda, \quad (\text{A.2})$$

where the second line follows on using the Einstein equations. Hence deduce the zeroth law of black hole mechanics: that, provided the matter stress tensor satisfies the dominant energy condition, the surface gravity of any Killing vector field ξ is constant on each connected component of its Killing horizon (in particular, on the event horizon of a stationary spacetime).

4. A scalar field Φ in the Kruskal spacetime satisfies the Klein-Gordon equation

$$D^2\Phi - m^2\Phi = 0.$$

Given that, in static Schwarzschild coordinates, Φ takes the form

$$\Phi = R_\ell(r) e^{-i\omega t} Y_\ell(\theta, \phi)$$

where $Y_{\ell m}$ is a spherical harmonic, find the radial equation satisfied by $R_\ell(r)$. Show that near the horizon at $r = 2M$, $\Phi \sim e^{\pm i\omega r^*}$, where r^* is the Regge-Wheeler radial coordinate. Verify that ingoing waves are analytic, in Kruskal coordinates, on the future horizon, \mathcal{H}^+ , but not, in general, on the past horizon, \mathcal{H}^- , and conversely for outgoing waves.

Given that both m and ω vanish, show that

$$R_\ell = A_\ell P_\ell(z) + B_\ell Q_\ell(z)$$

for constants A_ℓ, B_ℓ , where $z = (r - M)/M$, $P_\ell(z)$ is a Legendre Polynomial and $Q_\ell(z)$ a linearly-independent solution. Hence show that there are no *non-constant* solutions that are both regular on the horizon, $\mathcal{H} = \mathcal{H}^+ \cup \mathcal{H}^-$, and bounded at infinity.

5. Use the fact that a Schwarzschild black hole radiates at the Hawking temperature

$$T_H = \frac{1}{8\pi M}$$

(in units for which \hbar, G, c , and Boltzmann's constant all equal 1) to show that the thermal equilibrium of a black hole with an infinite reservoir of radiation at temperature T_H is unstable.

A finite reservoir of radiation of volume V at temperature T has an energy, E_{res} and entropy, S_{res} given by

$$E_{res} = \sigma VT^4 \quad S_{res} = \frac{4}{3}\sigma VT^3$$

where σ is a constant. A Schwarzschild black hole of mass M is placed in the reservoir. Assuming that the black hole has entropy

$$S_{BH} = 4\pi M^2 ,$$

show that the total entropy $S = S_{BH} + S_{res}$ is extremized for fixed total energy $E = M + E_{res}$, when $T = T_H$, Show that the extremum is a maximum if and only if $V < V_c$, where the critical value of V is

$$V_c = \frac{2^{20}\pi^4 E^5}{5^5 \sigma}$$

What happens as V passes from $V < V_c$ to $V > V_c$, or vice-versa?

6. The specific heat of a charged black hole of mass M , at fixed charge Q , is

$$C \equiv T_H \left. \frac{\partial S_{BH}}{\partial T_H} \right|_Q ,$$

where T_H is its Hawking temperature and S_{BH} its entropy. Assuming that the entropy of a black hole is given by $S_{BH} = \frac{1}{4}A$, where A is the area of the event horizon, show that the specific heat of a Reissner-Nordstrom black hole is

$$C = \frac{2S_{BH}\sqrt{M^2 - Q^2}}{(M - 2\sqrt{M^2 - Q^2})} .$$

Hence show that C^{-1} changes sign when M passes through $\frac{2|Q|}{\sqrt{3}}$.

Repeat Q.5 for a Reissner-Nordstrom black hole. Specifically, show that the critical reservoir volume, V_c , is infinite for $|Q| \leq M \leq \frac{2|Q|}{\sqrt{3}}$. Why is this result to be expected from your previous result for C ?

Index

- acceleration horizon, 32
- ADM energy, 85
- affine parameter, 10, 92
- asymptotically
 - empty, 43
 - simple, 42
 - weakly, 42
- axisymmetric, 68

- Beckenstein-Hawking entropy, 119
- bifurcate Killing horizon, 28
- bifurcation
 - 2-sphere, 28
 - point, 28
- Birkhoff's theorem, 12, 69
- black body radiation, 118
- black hole, 16
 - entropy, 119
- Bogoliubov transformation, 113
- Boyer-Kruskal axis, 23
- Boyer-Linquist coordinates, 69

- Carter-Penrose diagram, 38
- Carter-Robinson theorem, 69
- Cauchy
 - horizon, 60
 - surface
 - partial, 60
- Cauchy surface, 60
- Chandrasekhar limit, 7
- co-rotating electric potential, 102
- conformal compactification, 36

- congruence, 92
 - geodesic, 92
 - null, 94
- cosmic censorship hypothesis, 51
- degenerate pressure, 5
- dominant energy condition, 89

- Eddington-Finkelstein coordinates
 - ingoing, 15
 - outgoing, 16
- einbein, 9
- Einstein Static Universe, 38
- Einstein-Rosen bridge, 22
- ergoregion, 79
- ergosphere, 79

- Finkelstein diagram, 15, 16
- fixed point, 23
- fixed sets, 23
- Frobenius' theorem, 26, 96
- future event horizon, 44

- geodesic, 9
 - congruence, 92
 - deviation, 93
- global violation of causality, 74
- graviton, 69, 85

- Hawking
 - radiation, 114
 - temperature, 34, 118

- imaginary time, 33

- isotropic coordinates, 21
- Israel's theorem, 69
- Kaluza-Klein vacuum, 66
- Kerr metric, 70
- Kerr-Newman family, 69
- Kerr-Schild coordinates, 71
- Killing
 - horizon, 26
 - bifurcate, 28
 - degenerate, 65
 - vector, 11
- Klein-Gordon equation, 109
- Komar integrals, 87
- Kruskal-Szekeres coordinates, 17
- maximal analytic extension, 20
- naked singularity, 47
- null hypersurface, 24
- parallel transport, 10
- particle number operator, 112
- Pauli-Fierz equation, 86
- Penrose
 - process, 79
- Planck distribution, 118
- positive energy theorem, 91
- proper time, 14
- quantum gravity, 120
- Raychaudhuri equation, 97
- Regge-Wheeler radial coordinate, 15
- Reissner-Nordström solution, 50
- Rindler
 - metric, 31
 - spacetime, 30
 - Euclidean, 34
- sandwich spacetime, 112
- Schwarzschild metric, 12
- singularity
 - conical, 35
- Smarr's formula, 102
- static, 68
- stationary, 68
- Stephan's law, 118
- string theory, 120
- strong energy condition, 90
- super-radiance, 81
- surface gravity, 26, 33
- symplectic structure, 109
- Tolman law, 35
- totally-geodesic, 72
- uniqueness theorems, 68
- Unruh
 - effect, 35
 - temperature, 35
- weak energy condition, 90
- weak static dust, 86
- white dwarf, 6
- white hole, 17