

On Bus Graph Realizability*

Anil Ada, Melanie Coggan, Paul Di Marco, Alain Doyon, Liam Flookes, Samuli Heilala, Ethan Kim, Jonathan Li On Wing, Louis-Francois Preville-Ratelle, Sue Whitesides, and Nuo Yu

School of Computer Science
McGill University
Montréal, Canada

Technical Report SOCS-TR-2006.1, September 2006

Abstract. In this paper, we consider the following graph embedding problem: Given a bipartite graph $G = (V_1, V_2; E)$, where the maximum degree of vertices in V_2 is 4, can G be embedded on a two dimensional grid such that each vertex in V_1 is drawn as a line segment along a grid line, each vertex in V_2 is drawn as a point at a grid point, and each edge $e = (u, v)$ for some $u \in V_1$ and $v \in V_2$ is drawn as a line segment connecting u and v , perpendicular to the line segment for u ? We show that this problem is NP-complete, and sketch how our proof techniques can be used to show the hardness of several other related problems.

1 Introduction

Orthogonal graph drawing is a well studied area in the graph drawing community, and one may find many applications in VLSI design. In this paper, we study orthogonal drawings of *bus graphs*, which represent interconnectivity of functional entities in a chip. In VLSI layouts, a *bus* is a line segment drawn on a plane. To establish a connection among a collection of buses, a *connector* is drawn as a point on the plane, and then joined to the buses by line segments. Thus, the interconnections of the buses can be represented by a bipartite graph, where one partition of vertices corresponds to the set of buses, and the other corresponds to the set of connectors. We call such bipartite graphs *bus graphs*, and we are interested in the problem of drawing bus graphs on the plane.

For manufacturing purposes, it is desired that all the buses and the edges that join them are laid out either horizontally or vertically. Furthermore, it is also necessary to lay out the components of a chip, i.e. buses and connectors, sufficiently far from each other. Thus, we wish to draw the bus graph on a grid, where each bus is laid out along a grid line, and each connector is drawn at a grid

* Our interest in bus graph problems is a consequence of the participation of one of us in Bertinoro Workshop on Graph Drawing, 5–10 March, 2006 where the problem was presented as an open problem. Contact author: Ethan Kim, School of Computer Science, McGill University, 3480 University St., Montréal, Canada, ethan@cs.mcgill.ca

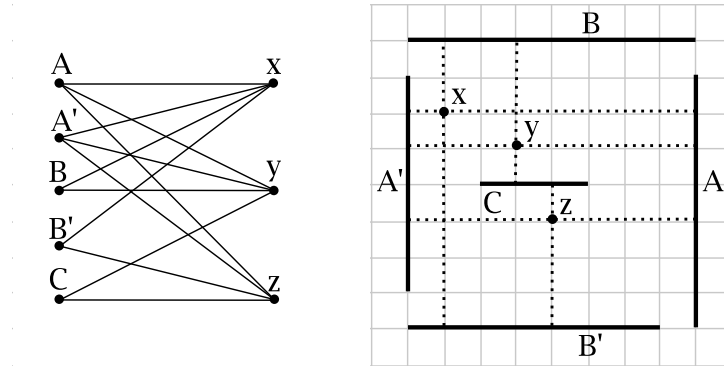

Fig. 1. A combinatorial bus graph and its realization. This graph is a gadget called an (A, B) -perp, defined in Sect. 3.2, Definition 1.

point. Each edge between a bus and a connector is also drawn along a grid line. In particular, an edge joining a bus is drawn as a line segment perpendicular to the bus. We do not allow any edge to intersect with any connectors or buses, except at endpoints of the edge. However, a horizontal edge may cross a vertical edge. Thus, each connector can connect at most 4 buses. We define the combinatorial bus graphs as the class of bipartite graphs $G = (\mathcal{B}, \mathcal{C}; \mathcal{E})$, where the degree of connector vertices in \mathcal{C} is at most 4.

We say a (combinatorial) bus graph G is *realizable* if G can be drawn while meeting the conditions above. See Fig. 1 for an example of a bus graph and its realization. We now formally define the Bus Graph Realizability (BGR) problem as follows:

Instance: A bipartite graph $G = (\mathcal{B}, \mathcal{C}; \mathcal{E})$ such that $\forall c \in \mathcal{C}, \deg(c) \leq 4$.

Question: Can G be drawn onto a grid so that the following properties hold?

1. Each vertex $B \in \mathcal{B}$ is drawn as a closed line segment along a grid line.
2. Each vertex $c \in \mathcal{C}$ is drawn as a point at a grid point.
3. Each edge $(B, c) \in \mathcal{E}$ is drawn as a closed line segment between B and c , that is perpendicular to B , and contains no other connectors or buses apart from B and c ; an edge can, however, cross other edges as shown in Fig. 1. An edge may connect to a bus at an endpoint of the bus.
4. No buses or connectors may intersect.

Now we are ready to state our main result.

Theorem 1. *Bus Graph Realizability is NP-complete.*

The rest of this paper is organized as follows. In Sect. 2, we give definitions and preliminaries. A proof of our main theorem is given in Sect. 3. In Sect. 4, we show that the techniques we use to prove Theorem 1 can be applied to related

problems. In Sect. 5, we look at a variation of the problem where the lengths of the buses are given as input, and prove that this version of the problem is NP-hard. Finally, we conclude with some open problems in Sect. 6.

Related Work. The orthogonal graph drawing style has found many applications in VLSI design since its introduction in [1], [2], and [3]. Many optimization criteria have been suggested, such as minimizing layout area, minimizing the number of wire crossings in a layout, etc. ([4], [5])

A realization of a bus graph conveys visibility relations among the buses and connectors. Given an arrangement of points (connectors) and axis-parallel line segments (buses) on a grid, if a bus B_i and a connector c_j can be joined by a straight-line edge, then there exists an axis-parallel line of sight that does not intersect any buses or connectors except B_i and c_j . Furthermore, if all the buses are drawn horizontally, the bus graph G is a subgraph of the visibility graph representing the vertical visibility among the bus segments. There is an abundance of prior work on the visibility graphs based on axis-parallel lines of sight, for example, in [6], [7], [8], [9], [10], [11], [12], and [13]. In particular, [10] and [11] study bar visibility graphs (BVGs), where each vertex in the graph is drawn as a horizontal line segment in \mathbb{R}^2 , and the adjacency among the vertices represent vertical visibility. It is shown that the recognition problem of such graphs can be solved in linear time. In [7], [9], [8], [12], [13], the authors study rectangle visibility graphs (RVGs), where each vertex is drawn as a rectangle, and the adjacency among the vertices represent axis-parallel lines of sight. Reference [13] shows that the recognition problem of such graphs is NP-complete. The bus graphs that we study in this paper can be regarded as related to RVGs, where the vertices are restricted to degenerate rectangles such as line segments and points.

2 Preliminaries

Given a bus graph $G = (\mathcal{B}, \mathcal{C}; \mathcal{E})$, we call a vertex B a \mathcal{B} -vertex if $B \in \mathcal{B}$; its realization is called a *bus*. Similarly, a \mathcal{C} -vertex refers to a vertex in \mathcal{C} , and its realization is called a *connector*. We often use uppercase letters to denote \mathcal{B} -vertices, and lowercase letters to denote \mathcal{C} -vertices.

We use a function Γ to denote an embedding of a combinatorial bus graph G . For example, $\Gamma(c)$ for some \mathcal{C} -vertex c denotes the grid point where c is laid out in the embedding, and $\Gamma(B)$ for some \mathcal{B} -vertex B or $\Gamma((B, c))$ for some edge (B, c) denotes the line segment along a grid line where the bus or edge is laid out. We call a grid point an *event point* if there is either a connector or an endpoint of a bus at that grid point.

It is important to note here that many variations of the bus graph problem can be devised, yet several are equivalent. For example, suppose the buses are realized as *open* line segments. It is not hard to see that this variation is equivalent to the problem stated in Sect. 1, as an embedding with buses as open line

segments can easily be transformed into an embedding with buses as closed line segments, and vice versa.

For another variation, note that a bus graph $G = (\mathcal{B}, \mathcal{C}; \mathcal{E})$ can be regarded as a hypergraph, where \mathcal{B} is the set of vertices, and \mathcal{C} is the set of hyperedges, each connecting at most four vertices. In this context, it is of interest to see if the realizability problem changes if we disallow multiple hyperedges in the hypergraph G . In other words, we would assume that no two \mathcal{C} -vertices are adjacent to the same set of \mathcal{B} -vertices. As the following lemma shows, this assumption does not change our problem.

Lemma 1. *Let G be a bus graph with multiple hyperedges in \mathcal{C} , and let G' be the bus graph constructed from G by removing hyperedge duplicates. Then G is realizable if and only if G' is realizable.*

Proof. Necessity is trivial. Conversely, suppose G' is realizable. Take any embedding of G' , and let c be a connector in the embedding at some position (i, j) . Then, create a copy of c with the same connectivity to buses as follows. For each event point in the embedding, if its x -coordinate is strictly greater than i , increase its x -coordinate by 1. Then, if c is connected to the rightmost endpoint of a horizontal bus B , where the endpoint is at an x -coordinate equal to i , increase the x -coordinate of the endpoint by 1. Similarly, if an event point has a y -coordinate strictly greater than j , increase its y -coordinate by 1. Then, if c is connected to the topmost endpoint of a vertical bus B' , where the endpoint is at a y -coordinate equal to j , increase the y -coordinate of the endpoint by 1. Finally, create a copy of c , and place it at $(i + 1, j + 1)$. Intuitively, we are *stretching* the buses that intersect either of the two grid lines $x = i$ and $y = j$, so that there is a grid point for the newly created copy of c , without making any collisions. Repeat this for each \mathcal{C} -vertex in G' , until a realization of G is obtained. \square

3 NP-Completeness

3.1 Membership in NP

Lemma 2. *Bus graph realizability is in NP.*

Proof. First, we claim that if a bus graph G is realizable, there exists a compact layout such that the size of the layout is linear in each dimension. To see this, take any layout of G , and *compact* the layout as follows. Take a vertical grid line with no event points on it. Then, for each event point at (x, y) appearing to the right of this grid line, shift it to $(x - 1, y)$. Observe that this operation still guarantees a legal layout. Repeat this for each such vertical grid line. Notice that the width of the layout is now linear in the size of G . We can apply a similar operation for all such horizontal grid lines. Thus, the claim is true, so there exists a short certificate for each realizable graph G that gives the coordinates of the event points in a compact layout. It is easy to see that we can check, in polynomial time, if such a certificate represents a correct solution. \square

3.2 NP-Hardness

In this section, we prove the NP-hardness of BGR by a reduction from NAE-3SAT [14]. We first introduce and discuss properties of several gadgets, and then give the transformation.

Definition 1. An (A, B) -perp is a bus graph component consisting of three \mathcal{C} -vertices x, y, z , five \mathcal{B} -vertices A, A', B, B', C , and twelve edges $(A, x), (A', x), (B, x), (B', x), (A, y), (A', y), (B, y), (C, y), (A, z), (A', z), (B', z), (C, z)$.

A combinatorial graph of an (A, B) -perp and an example embedding of it are shown in Fig. 1.

Lemma 3. In any embedding Γ of an (A, B) -perp,

1. $\Gamma(B)$ and $\Gamma(B')$ are parallel,
2. $\Gamma(A)$ and $\Gamma(B)$ are perpendicular, and
3. $\Gamma(A)$ and $\Gamma(A')$ are parallel.

Proof.

1. Note that y and z are both adjacent to A, A' and C . $\Gamma((B, y))$ and $\Gamma((B', z))$ are then parallel, so $\Gamma(B)$ and $\Gamma(B')$ are parallel.
2. By 1, $\Gamma(B)$ and $\Gamma(B')$ are parallel. So if $\Gamma(A)$ were parallel to $\Gamma(B)$, then x would be adjacent to three parallel buses. This is a contradiction.
3. By 2, $\Gamma(A)$ and $\Gamma(B)$ are perpendicular. If $\Gamma(A')$ were perpendicular to $\Gamma(A)$, then $\Gamma(A')$ would be parallel to $\Gamma(B)$, making x adjacent to three parallel buses. This is a contradiction. □

Definition 2. A (B, o) -flipper is a bus graph component consisting of an (A, B) -perp, one additional \mathcal{C} -vertex o , and two additional edges $(B, o), (B', o)$.

An example embedding of a (B, o) -flipper is shown in Fig. 2.

Lemma 4. Let i be a \mathcal{C} -vertex, and O be a \mathcal{B} -vertex. If i is joined with a (B, o) -flipper by an edge (B, i) , and O is joined with the (B, o) -flipper by an edge (O, o) , then in any embedding Γ ,

1. $\Gamma((B, i))$ and $\Gamma((O, o))$ are perpendicular, and
2. $\Gamma(B)$ and $\Gamma(O)$ are perpendicular.

Proof.

1. By Lemma 3, $\Gamma(B)$ and $\Gamma(B')$ are parallel, so $\Gamma((B, o))$ and $\Gamma((B', o))$ are also parallel. $\Gamma((O, o))$ is then perpendicular to $\Gamma((B, o))$. Thus, $\Gamma((O, o))$ is parallel to $\Gamma(B)$ and perpendicular to $\Gamma((B, i))$.
2. Follows immediately from 1. □

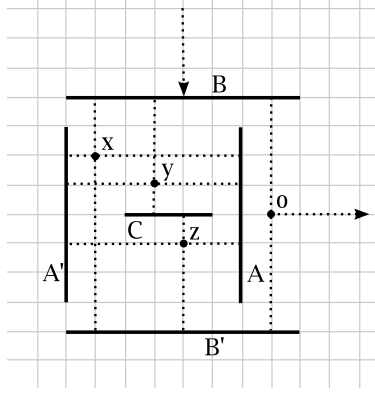

Fig. 2. Example embedding of a (B, o) -flipper.

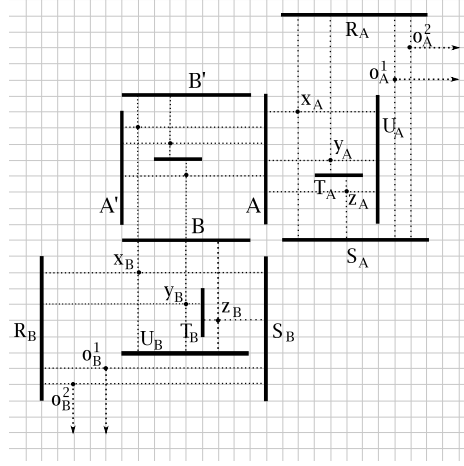

Fig. 3. Example embedding of an $(A, 2, B, 2)$ -variable-box.

Definition 3. An (A, k, B, l) -variable-box is a bus graph component consisting of an (A, B) -perp, $(3+k) + (3+l)$ additional \mathcal{C} -vertices $x_A, y_A, z_A, o_A^1, o_A^2, \dots, o_A^k, x_B, y_B, z_B, o_B^1, o_B^2, \dots, o_B^l$, eight additional \mathcal{B} -vertices $R_A, S_A, T_A, U_A, R_B, S_B, T_B, U_B$, and $(12+2k) + (12+2l)$ additional edges

$$\begin{aligned}
& (A, x_A), (R_A, x_A), (S_A, x_A), (U_A, x_A), \\
& (A, y_A), (R_A, y_A), (T_A, y_A), (U_A, y_A), \\
& (A, z_A), (S_A, z_A), (T_A, z_A), (U_A, z_A), \\
& (R_A, o_A^i), (S_A, o_A^i) \text{ for } i = 1, 2, \dots, k, \\
& (B, x_B), (R_B, x_B), (S_B, x_B), (U_B, x_B), \\
& (B, y_B), (R_B, y_B), (T_B, y_B), (U_B, y_B), \\
& (B, z_B), (S_B, z_B), (T_B, z_B), (U_B, z_B), \\
& (R_B, o_B^i), (S_B, o_B^i) \text{ for } i = 1, 2, \dots, l.
\end{aligned}$$

An example embedding of an $(A, 2, B, 2)$ -variable-box is shown in Fig. 3.

Lemma 5. Let (O_A^i, o_A^i) for $i = 1, 2, \dots, k$ and (O_B^j, o_B^j) for $j = 1, 2, \dots, l$ be edges joined with an (A, k, B, l) -variable-box. Then in any embedding Γ ,

1. $\Gamma((O_A^i, o_A^i))$ and $\Gamma(A)$ are perpendicular for any $i = 1, 2, \dots, k$.
2. $\Gamma((O_B^i, o_B^i))$ and $\Gamma(B)$ are perpendicular for any $i = 1, 2, \dots, l$.

Proof. We prove the first statement; the proof of the second is analogous. Notice that vertices $x_A, y_A, z_A, R_A, S_A, T_A, U_A, o_A^1, o_A^2, \dots, o_A^k$ form an (R_A, o_A^i) -flipper with multiple output \mathcal{C} -vertices. As shown in the proof of Lemma 4,

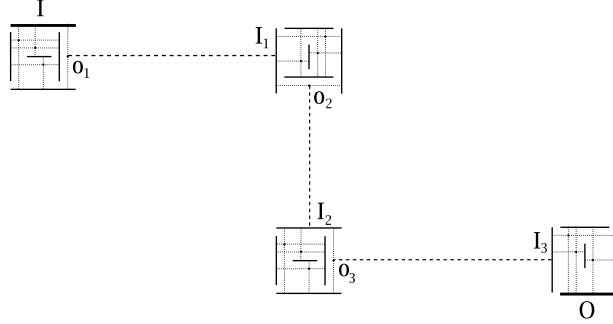

Fig. 4. Example embedding of an (I, O) -chain.

$\Gamma((O_A^i, o_A^i))$ is parallel to $\Gamma(R_A)$ for all $i = 1, 2, \dots, k$. Using the same reasoning as in the proof of Lemma 3, $\Gamma(R_A)$ is perpendicular to $\Gamma(A)$. It follows that every edge $\Gamma((O_A^i, o_A^i))$ is perpendicular to $\Gamma(A)$. \square

Definition 4. An (I, O) -chain is a bus graph component consisting of

1. an (I, o_1) -flipper,
2. an (I_1, o_2) -flipper,
3. an (I_2, o_3) -flipper,
4. an (I_3, O) -perp,

and three additional edges (I_1, o_1) , (I_2, o_2) , (I_3, o_3) .

An example embedding of an (I, O) -chain is shown in Fig. 4.

Lemma 6. In any embedding Γ of an (I, O) -chain, $\Gamma(I)$ and $\Gamma(O)$ are parallel.

Proof. By repeatedly applying Lemma 4, $\Gamma(I)$ is perpendicular to $\Gamma(I_1)$, $\Gamma(I_1)$ is perpendicular to $\Gamma(I_2)$, and $\Gamma(I_2)$ is perpendicular to $\Gamma(I_3)$. By Lemma 3, $\Gamma(I_3)$ is perpendicular to $\Gamma(O)$. It follows that $\Gamma(I)$ is parallel to $\Gamma(O)$. \square

Finally, we are ready to give the transformation from NAE-3SAT to BGR. Let ϕ be an instance of NAE-3SAT, consisting of boolean variables x_1, \dots, x_n , and clauses C_1, \dots, C_m . Construct a bus graph G as follows.

1. For each boolean variable x_i , create a $(X_i, t_i, \overline{X}_i, f_i)$ -variable-box, where t_i and f_i are the numbers of distinct occurrences of the literals x_i and \overline{x}_i , respectively, in ϕ .
2. For each clause $C_q = (x_i^* \vee x_j^* \vee x_k^*)$, where x^* is either x or \overline{x} , create
 - (a) a \mathcal{C} -vertex c_q ,
 - (b) an $(I_{q,1}, O_{q,1})$ -chain, an $(I_{q,2}, O_{q,2})$ -chain, and an $(I_{q,3}, O_{q,3})$ -chain,
 - (c) edges $(O_{q,1}, c_q)$, $(O_{q,2}, c_q)$ and $(O_{q,3}, c_q)$,

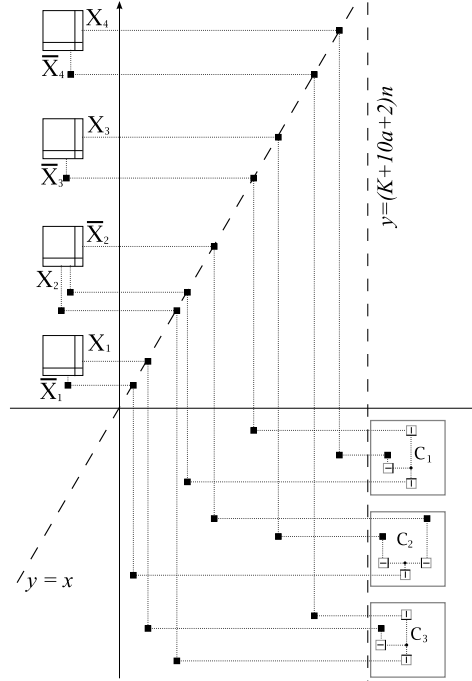

Fig. 5. A schematic embedding of G , where ϕ consists of the clauses $C_1 = (x_2 \vee \overline{x_3} \vee x_4)$, $C_2 = (\overline{x_1} \vee \overline{x_2} \vee x_3)$, and $C_3 = (x_1 \vee x_2 \vee \overline{x_4})$ with a satisfying truth assignment $x_1 = x_3 = x_4 = \text{true}$ and $x_2 = \text{false}$. Note the regions separated by the dashed lines and x -, y -axes. Complete instructions for the embedding is included in Appendix.

- (d) edges $(I_{q,1}, p_i)$, $(I_{q,2}, p_j)$ and $(I_{q,1}, p_k)$, where $p_i = o_{X_i}^r$ if $x_i^* = x_i$ and $p_i = o_{\overline{X_i}}^r$ if $x_i^* = \overline{x_i}$, and it is the r th occurrence of x_i^* being considered.

Since every gadget is of linear size, the transformation clearly takes polynomial time. Finally, the following lemma completes the proof of Theorem 1.

Lemma 7. $\phi \in \text{NAE-3SAT}$ if and only if $G \in \text{BGR}$.

Proof. Suppose $\phi \in \text{NAE-3SAT}$. An embedding Γ of G can be constructed as demonstrated in Fig. 5. Notice that the variable boxes are embedded in such a way that the buses corresponding to true literals are drawn vertically and the buses corresponding to false literals are drawn horizontally. See Appendix for a full description of this layout.

Conversely, suppose $G \in \text{BGR}$, and take an embedding Γ of G . By Lemma 3, $\Gamma(X_i)$ is perpendicular to $\Gamma(\overline{X_i})$ for each variable box, so assign each variable x_i to be true if $\Gamma(X_i)$ is vertical and false otherwise. To see that this truth-assignment satisfies the clauses, consider a clause $C_q = (x_i^* \vee x_j^* \vee x_k^*)$. The clause vertex c_q is adjacent to three buses $O_{q,1}$, $O_{q,2}$, and $O_{q,3}$ at the end of

(I, O) -chains. Since c_q can be joined to at most two parallel buses, at least one of these three buses must be drawn horizontally, and at least one must be drawn vertically. Take any one of the three buses, say $O_{q,1}$, and consider the literal bus to which $O_{q,1}$ connects in the variable box. By Lemma 5 and Lemma 6, the orientation of these two buses must be the same. This implies that the clause vertex c_q is connected to at least one vertically drawn literal bus, and at least one horizontally drawn literal bus. Therefore, the truth-assignment satisfies ϕ . \square

4 Applications of Proof Techniques

In this section, we look at variations of the bus graph realizability problem in which the degree of \mathcal{C} -vertices is restricted. In the original bus graph realizability problem presented in Sect. 1, each \mathcal{C} -vertex has a maximum degree of 4, due to the orthogonal drawing style. An analogous problem can be devised for the class of bus graphs where the \mathcal{C} -vertices have maximum degrees of either 2 or 3. In what follows, we show that these variations are also NP-complete. Finally, we discuss the problem of merely deciding the orientation of buses, which also turns out to be NP-complete.

4.1 Connectors with Bounded Degree

First, consider the class of bus graphs where the \mathcal{C} -vertices have maximum degree 1. These graphs are trivially realizable by simply drawing all the buses along a grid line. However, if the maximum degree of \mathcal{C} -vertices is greater than or equal to 2, the problem becomes harder. Recall from the proof of Theorem 1 in Sect. 3 that the reduction from NAE-3SAT was done using a series of gadgets, each of which was based on the (A, B) -perp. The following results follow from constructing an (A, B) -perp gadget for each case, and then constructing the remaining gadgets in a similar fashion.

Theorem 2. *Bus Graph Realizability is NP-complete when the maximum degree of \mathcal{C} -vertices is 2.*

Proof sketch. If every \mathcal{C} -vertex has degree 2, we may regard each \mathcal{C} -vertex as an edge connecting two \mathcal{B} -vertices. Thus, in the following description, when we say to join two \mathcal{B} -vertices, we mean to create a \mathcal{C} -vertex that joins the two \mathcal{B} -vertices. To construct the perp gadget, start with a complete graph K_8 , with vertices labeled B_1 through B_8 . Then, create another vertex B_9 , and join it with vertices B_1 through B_7 . Finally, create a vertex B_{10} , and join it to vertices B_1 through B_6 , B_8 , and B_9 . It can be shown that the buses B_8 and B_{10} must be drawn perpendicularly to each other, and all other gadgets can be constructed based on this structure.¹ \square

Theorem 3. *Bus Graph Realizability is NP-complete, when the maximum degree of \mathcal{C} -vertices is 3.*

¹ For obvious reasons, we cannot use a single \mathcal{C} -vertex to represent a clause. This can be resolved by creating a combination of perp gadgets and (I, O) -chains.

Proof sketch. The perp gadget for this case is a bus graph component consisting of eight \mathcal{C} -vertices s, t, u, v, w, x, y, z , six \mathcal{B} -vertices A, A', B, B', C, D and 24 edges, connecting the \mathcal{B} -vertices to the \mathcal{C} -vertices as follows: s to A, B, C ; t to A, B, A' ; u to A, B, B' ; v to C, A', B' ; w to A', B, D ; x to A', B, B' ; y to D, A, B' ; z to A', B', A . It can be shown that the buses A and B must be drawn perpendicularly to each other, and parallel to A' and B' , respectively. All other gadgets can be constructed based on this structure. \square

Our results can be summarized as follows.

Theorem 4. *Bus Graph Realizability is NP-complete if and only if the maximum degree of \mathcal{C} -vertices in the given graph is 2, 3, or 4.*

4.2 Partition by Orientation

In order to realize a given bus graph, one must decide the orientations of the buses. Since a connector can be joined to at most two horizontal buses and at most two vertical buses, all realizable bus graphs admit a bipartition of buses by orientation. As we will see shortly, even deciding whether the buses can be properly oriented is hard to compute. Note, however, that a proper bipartition by orientation does not guarantee that the graph is realizable.²

We define the problem *PARTITION-BY-ORIENTATION* as follows:

Instance: A bipartite graph $G = (\mathcal{B}, \mathcal{C}; \mathcal{E})$ such that $\forall c \in \mathcal{C}, \deg(c) \leq 4$.

Question: Can \mathcal{B} be partitioned into two disjoint sets $\mathcal{B}_{\mathcal{H}}$ and $\mathcal{B}_{\mathcal{V}}$, such that $\forall c \in \mathcal{C}, c$ is adjacent to no more than two vertices in $\mathcal{B}_{\mathcal{H}}$ and no more than two vertices in $\mathcal{B}_{\mathcal{V}}$?

Theorem 5. *PARTITION-BY-ORIENTATION is NP-complete.*

Proof. The problem is clearly in NP, as one could guess a partition and check for its correctness in polynomial time. For the reduction, we use NAE-3SAT. Given an instance ϕ of NAE-3SAT, we construct a graph G as follows. First, for each variable x_i in ϕ , create an (A, B) -perp. Vertex A corresponds to x_i , whereas vertex B corresponds to $\overline{x_i}$. Then, for each clause $C_q = (x_i^* \vee x_j^* \vee x_k^*)$, create a \mathcal{C} -vertex c_q , and join it to the three literal vertices. The rest of the proof is similar to the proof of Lemma 7, and follows from Lemma 3. \square

5 Bus Graph Realizability with Given Bus Lengths

In this section, we study a variation of bus graph realizability in which the lengths of buses are given as input (BGR+BL). We devise a new encoding scheme for the instances of this problem. The purpose of this encoding scheme will become clear shortly. Recall from the discussion in Sect. 2 that bus graphs can be regarded

² A simple counterexample can be constructed by first creating a complete graph with 9 \mathcal{B} -vertices, and then placing a \mathcal{C} -vertex on each edge.

as hypergraphs, where each \mathcal{C} -vertex corresponds to a hyperedge. In the new encoding scheme, we assume that the problem instance is given as a list of subsets of \mathcal{B} , where each subset is of cardinality at most 4. For each subset, we also encode the number of \mathcal{C} -vertices that are adjacent to exactly that subset of \mathcal{B} -vertices. Notice that this is a form of adjacency matrix for the hypergraph, where each entry in the matrix denotes the number of hyperedges for that particular subset of buses. In the case of hypergraphs where no multiple hyperedges are allowed, each entry in the matrix would be either 1 or 0.

Now we are ready to state and prove the main result of this section.

Theorem 6. *BGR+BL is NP-hard. It is also NP-hard if the maximum degree of \mathcal{C} -vertices is 2, or if we require the buses to be parallel to each other.*

Proof. The reduction is from PARTITION [14]. Let $\langle A, s \rangle$ be an instance of PARTITION, where A is a set of elements, and $s : A \rightarrow \mathbb{Z}^+$ is a size function for each element. For simplicity, we assume that no element is of size 1, as we can scale the size function appropriately. We construct a bus graph G as follows. Create a \mathcal{B} -vertex B^* of length $\frac{1}{2} \sum_{a \in A} s(a) - 1$. Then, for each $a \in A$, create a \mathcal{B} -vertex B_a of length $s(a) - 1$. Now, for each element $a \in A$, create exactly $s(a)$ copies of \mathcal{C} -vertex, and join them to both B_a and B^* . With the new encoding scheme, this transformation can be done in polynomial time.

Suppose $\langle A, s \rangle \in \text{PARTITION}$. First, lay out the bus B^* horizontally along the x -axis. It is easy to see that one can place the buses B_a for all $a \in A'$ horizontally along the grid line $y = 1$ (above B^*), and place the rest horizontally along the grid line $y = -1$ (below B^*). This is a legal layout.

Conversely, suppose G is a yes-instance of BGR+BL. Take an embedding of G , and assume without loss of generality that B^* is drawn horizontally. Then, each bus B_a must be laid out either completely above B^* , or completely below B^* . To see this, suppose otherwise. This means either (1) some B_a is drawn on the same grid line as B^* , or (2) some B_a is drawn vertically, where one endpoint of B_a is above B^* , and the other endpoint is below B^* . Case (1) is not possible, as no connector can join B_a with B^* . Consider case (2). Then, there exists a grid point p at the intersection of B_a and the grid line where B^* is drawn. No connector can connect p with B^* , since every edge must connect to a bus (B^* , in particular) perpendicularly. This is a contradiction because each grid point along the bus B_a must connect to B^* via a connector.

This implies that the number of grid points along the buses drawn above B^* equals the number of grid points along B^* . Similarly, the number of grid points along the buses drawn below B^* equals the number of grid points along B^* . Therefore, we have a subset $A' \subset A$, where A' is the set of elements that correspond to the buses drawn above B^* , and this is a valid partition. \square

6 Concluding Remarks and Open Problems

Although bus graph realizability is an NP-complete problem in general, some special classes of graphs admit polynomial time solutions. For example, if the

given bus graph G is a tree, it is simple to devise an algorithm to produce a realization of G , and hence G *always* admits a bus graph embedding. However, what other classes of graphs admit polynomial time recognition algorithms for realizable bus graphs is an unexplored question.

As a consequence of the hardness results of this paper, one may search for approximate solutions to the problems. It is unclear, however, what optimization criteria would be used. With applications in VLSI in mind, one may wish to lay out all the buses first, and then maximize the connectivity by maximizing the number of connectors realized in the layout.

Acknowledgments. We thank Olivier Mireault for his interest and support. Those of us who hold research grants or government scholarships gratefully acknowledge NSERC and FQRNT for their support.

References

1. Thompson, C.D.: Area-time complexity for vlsi. In: Eleventh Annual ACM Symposium on Theory of Computing. (1979)
2. Thompson, C.D.: A Complexity Theory for VLSI. PhD thesis, Carnegie-Mellon University (1980)
3. Bhatt, S.N., Leighton, F.T.: A framework for solving vlsi graph layout problems. Technical report, MIT/LCS/TR-305 (1983)
4. Leighton, F.T.: A layout strategy for vlsi which is provably good (extended abstract). In: Proceedings of the fourteenth annual ACM symposium on Theory of computing. (1982)
5. Leighton, F.T.: New lower bound techniques for vlsi. *Theory of Computing Systems* **17**, **1** (1984) 47 – 70
6. Fößmeier, U., Kant, G., Kaufmann, M.: 2-visibility drawings of planar graphs. In: Symposium on Graph Drawing. (1996)
7. Dean, A.M., Hutchinson, J.P.: Rectangle-visibility representations of bipartite graphs. *Discrete Applied Mathematics* **75** (1997) 9–25
8. Hutchinson, J.P., Shermer, T., Vince, A.: On representations of some thickness-two graphs. *Computational Geometry: Theory and Applications* **13**(3) (1999) 161–171
9. Streinu, I., Whitesides, S.: Rectangle visibility graphs: Characterization, construction, and compaction. In: Proceedings of the 20th Annual Symposium on Theoretical Aspects of Computer Science. (2003)
10. Wismath, S.K.: Characterizing bar line-of-sight graphs. In: Annual Symposium on Computational Geometry. (1985)
11. Tamassia, R., Tollis, I.G.: A unified approach to visibility representations of planar graphs. *Discrete and Computational Geometry* **1** (1986) 321–341
12. Bose, P., Dean, A., Hutchinson, J., Shermer, T.: On rectangle visibility graphs i: k -trees and caterpillar forests. Technical report, DIMACS and Simon Fraser U. (1996)
13. Shermer, T.: On rectangle visibility graphs. iii: External visibility and complexity. In: Proceedings of 8th Canadian Conference on Computational Geometry. (1996)
14. Garey, M.R., Johnson, D.S.: *Computers and Intractability*. Freeman (1979)

Appendix: Necessity Proof for Lemma 7

In this section, a full proof for the necessity of the Lemma 7 is given. Let ϕ denote a boolean formula for NAE-3SAT, consisting of n variables and m clauses, and let $\sigma : X \rightarrow \{T, F\}$ be a satisfying truth assignment for ϕ . Given ϕ , our goal is to show that the bus graph G , constructed from the transformation shown in Sect. 3.2, is realizable. We first describe how each gadget, as introduced in Sect. 3.1, can be embedded within a bounding box of predefined size. Then, the overall embedding of G is presented by explicitly giving coordinates for each gadget bounding box. Finally, we show that the so-described embedding of G is a legal layout of a bus graph, which completes the proof. For simplicity, we often refer to a bounding box as an $n \times n$ *subgrid*, which is a square of size $(n - 1) \times (n - 1)$, with n grid points along each side.

A. Embedding of Gadgets

Note that the coordinates used in this section are relative to each corresponding gadget only.

Perps and Flippers. We embed a perp within an 9×9 subgrid, as shown in Fig. 1. In the case of the (I_3, O) -perp inside an (I, O) -chain, its incoming edge is connected to the grid point at the center of the bus $\Gamma(I_3)$. See Fig. 4 for an example. Similarly, a flipper is embedded in a 9×9 subgrid, and the incoming and outgoing edges are drawn so that they lie along the same grid line as the center grid point of the subgrid. See Fig. 2 for an illustration of the embedding.

Variable Boxes. Let a denote the maximum number of occurrences of a literal in ϕ . Then, draw each variable box in a $K \times K$ subgrid, where $K = 11a + 18$. Then, using the upper-left corner of the subgrid as the origin:

1. Embed the horizontal outgoing edges along the grid lines $y = -10i$
2. Embed the vertical outgoing edges along the grid lines $x = 10i$

for all $i = 1 \dots a$. See Fig. 6 for the embedding of a $(X, 4, \overline{X}, 4)$ -variable box. Notice that some literals may not appear a times in ϕ , but the embedding reserves a fixed area for every variable box to accommodate all the occurrences of a literal in ϕ . Notice that all parallel outgoing edges are spaced apart by 9 grid lines. It is also important to note that the embedding is symmetric along the diagonal of the subgrid with respect to the position of outgoing edges. This is crucial for the embedding, as the orientation of the embedding is decided upon the satisfying assignment σ . If a variable X_i is assigned true by σ , then the corresponding variable box is embedded so that the bus $\Gamma(X_i)$ is drawn vertically. Otherwise, it is embedded as a reflection about the diagonal so that $\Gamma(X_i)$ is drawn horizontally.

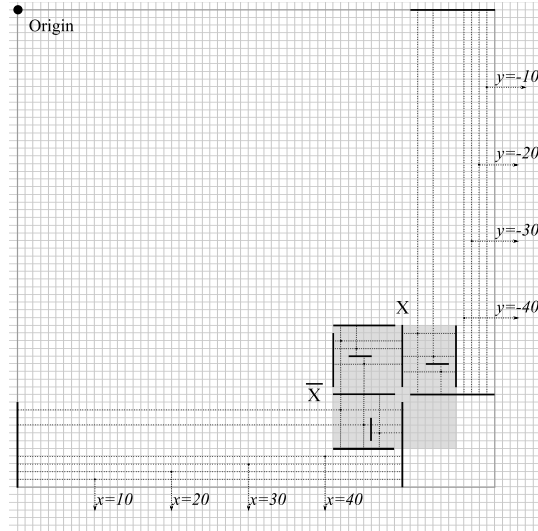

Fig. 6. Embedding of a $(X, 4, \overline{X}, 4)$ -variable box. Observe that there are 16 grid points along each side of the shaded region, and $(10a + 1) + (a + 1)$ grid points on either side of the shaded region. The orientation in the figure assumes $X = \text{true}$.

Clause Boxes. Although not presented as a gadget in Sect. 3.2, each clause connector c_i can be embedded on a 40×40 subgrid, along with some components of (I, O) -chains joined to c_i . As with the embedding of variable boxes, the embedding of clause boxes depends on σ . Since σ is a satisfying assignment of NAE-3SAT, there are 2 cases for the truth assignment of each clause: (T, F, F) , and (T, T, F) . See Fig. 7 for the embedding of both cases. Observe that if a literal in the clause is assigned to true, then the (I_2, o_3) -flipper and (I_3, O) -perp component in the corresponding (I, O) -chain is drawn inside the subgrid. Otherwise, only the (I_3, O) -perp component is drawn inside the subgrid. Observe that the incoming edges are drawn at fixed y -coordinates, regardless of the assignment for the clause.

B. Embedding of G

We are now ready to realize G . For an overview of the embedding, see Fig. 5. First, we begin by embedding the variable boxes. For each boolean variable X_i , lay out the corresponding variable box on the subgrid bounded by $x \in [-K, -1]$ and $y \in [(K + 10a + 2)i - K + 1, (K + 10a + 2)i]$, in the orientation determined by σ . Observe that each variable box is embedded in the second quadrant, and every two neighboring subgrids are $10a + 2$ grid lines apart from each other.

Then, for each clause c_q , lay out the corresponding clause box on the subgrid bounded by $x \in [(K + 10a + 2)n, (K + 10a + 2)n + 39]$ and $y \in [-40q, -40q + 39]$. The internal layout of each clause box is determined by σ , but the three incoming

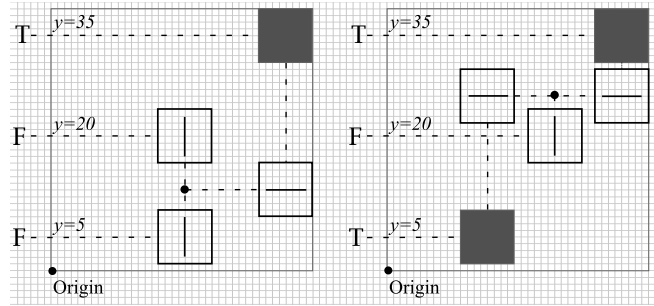

Fig. 7. Embedding for a clause box assigned with T, F, F (left), and a clause box assigned with T, T, F (right). Shaded boxes denote flipper components, whereas unshaded boxes denote perp components, for each corresponding (I, O) -chain.

edges are always located at $y = -40q + 5$, $y = -40q + 20$, and $y = -40q + 35$. Observe that each clause box is embedded to the right of the grid line $y = (K + 10a + 2)n$.

We now need to lay out the (I, O) -chains that join the variable boxes with clause boxes. There are two types of embedding for (I, O) -chains, determined by the truth-assignment of the literal bus that the (I, O) -chain connects to. If an (I, O) -chain connects to a literal assigned true, we say that its embedding is of Type- \mathcal{T} . If an (I, O) -chain connects to a literal assigned false, we say that its embedding is of Type- \mathcal{F} . We describe the two embedding types separately. See Fig. 8 for an illustration.

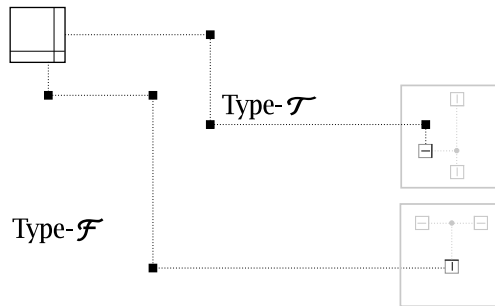

Fig. 8. Type- \mathcal{T} embedding and Type- \mathcal{F} embedding

Type- \mathcal{T} Embedding. Let c_q be the clause vertex inside the clause box, and let $o_{X_i}^{r_i}$ be the literal vertex inside the variable box. Our aim is to connect c_q to $o_{X_i}^{r_i}$

using an (I, O) -chain. For Type- \mathcal{T} , recall that (I_2, o_3) -flipper and (I_3, O) -perp are embedded within the clause box. Thus, it suffices to describe the positions for the (I, o_1) -flipper and the (I_1, o_2) -flipper.

Observe that the (I, O) -chain must exit the variable box horizontally at $y = y_1$, where y_1 is the y -coordinate of $o_{X_i}^{r_i}$, and enter the clause box horizontally at $y = y_2$, where y_2 is the position defined by the clause box type as shown in Fig. 7. Place the two flippers as follows.

1. Embed the (I, o_1) -flipper in the subgrid bounded by $x, y \in [y_1 - 4, y_1 + 4]$.
2. Embed the (I_1, o_2) -flipper in the subgrid bounded by $x \in [y_1 - 4, y_1 + 4]$ and $y \in [y_2 - 4, y_2 + 4]$.

Type- \mathcal{F} Embedding. Let c_q be the clause vertex inside the clause box, and let $o_{X_j}^{r_j}$ be the literal vertex inside the variable box. Our aim is to connect c_q to $o_{X_j}^{r_j}$ using an (I, O) -chain. For Type- \mathcal{F} , only the (I_3, O) -perp is embedded within the clause box. Hence, we must describe the positions for (I, o_1) -flipper, (I_1, o_2) -flipper, and (I_2, o_3) -flipper.

Observe that the (I, O) -chain must exit the variable box vertically at $x = x_1$, where x_1 is the x -coordinate of $o_{X_j}^{r_j}$, and enter the clause box horizontally at $y = y_2$, where y_2 is the position defined by the clause box type as shown in Fig. 7. Place the three flippers as follows.

1. Embed the (I, o_1) -flipper in the subgrid bounded by $x \in [x_1 - 4, x_1 + 4]$ and $y \in [y_1 - 4, y_1 + 4]$, where $y_1 = (K + 10a + 2)(j - 1) + 6 + 10(r_j - 1)$.
2. Embed the (I_1, o_2) -flipper in the subgrid bounded by $x, y \in [y_1 - 4, y_1 + 4]$.
3. Embed the (I_2, o_3) -flipper in the subgrid bounded by $x \in [y_1 - 4, y_1 + 4]$ and $y \in [y_2 - 4, y_2 + 4]$.

C. Correctness of the Embedding

In this section, we show that the embedding of G is a legal layout. To do this, we refer back to the four properties stated in the problem definition in Sect. 1. The first two properties hold trivially by construction. Hence, it suffices to show that the other two properties hold.

Proof. We check if the properties hold as we lay out each gadget. By construction, the embedding of each individual gadget is legal. So first lay out the variable boxes and clause boxes. The embedding of these boxes together is legal, since no two boxes overlap. Now, lay out the (I, O) -chains and see if the two properties still hold.

(Property 3.) We say an edge *passes through* a gadget if the embedded edge enters and exits the bounding box of the gadget. Since each bus or connector is drawn within the bounding box of a gadget, we need to show that no edge passes through a gadget. Note that we need only consider the edges along the (I, O) -chains, as all other edges are embedded inside gadget bounding boxes.

Notice that for each flipper f in some (I, O) -chain in the embedding, f is joined to other components by a horizontal edge f_H and a vertical edge f_V .

Now, take a horizontal edge e_H on some grid line $y = y_1$. There are three cases to consider. (1) Suppose e_H passes through a flipper f in some (I, O) -chain. Then e_H must be fewer than 4 grid lines apart from f_H . This is a contradiction, as any two horizontal edges in the embedding are at least 9 grid lines apart from each other. (2) Suppose e_H passes through a variable box. If $y_1 > 0$, there is exactly one variable box at $y = y_1$, which e_H connects to at its endpoint. If $y_1 \leq 0$, e_H cannot reach any variable box because all variable boxes are above the x -axis. This is a contradiction. (3) Suppose e_H passes through a clause box. If $y_1 \leq 0$, there is exactly one clause box at $y = y_1$, which e_H connects to at its endpoint. If $y_1 > 0$, e_H cannot reach any clause box because all clause boxes are below the y -axis, hence a contradiction.

Take a vertical edge e_V on some grid line $x = x_1$. Note that e_V cannot pass through a clause box, since all vertical edges lie to the left of the grid line $x = (K + 10a + 2)n$. Secondly, e_V cannot pass through a variable box, since the y -axis separates e_v from variable boxes when $x_1 > 0$, or e_v completely lies within region between two neighboring variable boxes when $x_1 \leq 0$. Finally, e_v cannot pass through flippers, either because the vertical edge f_V for any flipper f is sufficiently far from e_v , or e_v and f lie in different regions separated by variable boxes.

(Property 4.) We say two gadgets *intersect* if the bounding boxes of the two embedded gadgets intersect. Since each bus or connector is embedded within some gadget, if no two gadgets intersect then no buses or connectors may intersect. We categorize the gadgets into 5 types as follows.

1. Type- Q_1 flipper: a flipper embedded in the first quadrant
2. Type- Q_2 flipper: a flipper embedded in the second quadrant
3. Type- Q_4 flipper: a flipper embedded in the fourth quadrant
4. a variable box
5. a clause box

It is easy to check that each gadget belongs the exactly one of these types. By construction, no two gadgets of the same type may intersect. Take a variable box X_i and a Type- Q_2 flipper f_j joined to a variable box X_j . Since f_j is embedded strictly below the variable box X_j and strictly above the variable box X_{j+1} , X_i and f_j cannot intersect, regardless of values for i and j .

Now, take a clause box C_i and a Type- Q_4 flipper f_j joined to a clause box C_j . Observe that the grid line $x = (K + 10a + 2)n$ separates the embedding of flippers and clause boxes. Hence, C_i and f_j may not intersect, regardless of values for i and j .

For any other pair of types, they may not intersect since they belong to different quadrants. \square