

# Numeration-automatic sequences

Jeroen F. J. Laros

July 30, 2018

# Contents

<b>1</b>	<b>Introduction</b>	<b>3</b>
<b>2</b>	<b>Definitions</b>	<b>3</b>
<b>3</b>	<b>Equivalence between substitutions and automata</b>	<b>5</b>
3.1	Substitutions in general . . . . .	5
3.2	Substitutions with fixed points . . . . .	6
<b>4</b>	<b>Numeration-automatism</b>	<b>8</b>
4.1	The Fibonacci substitution . . . . .	8
4.2	Fibonacci's 'brother' . . . . .	10
<b>5</b>	<b>A generalization</b>	<b>10</b>
5.1	The expansion algorithm . . . . .	11
<b>6</b>	<b>Survey</b>	<b>13</b>
<b>7</b>	<b>Combining automata</b>	<b>15</b>
<b>8</b>	<b>Reverse reading</b>	<b>18</b>
<b>9</b>	<b>Numeration systems</b>	<b>22</b>
<b>10</b>	<b>Conclusion</b>	<b>24</b>
<b>11</b>	<b>More on numeration-automatism</b>	<b>24</b>
<b>12</b>	<b>Acknowledgements</b>	<b>25</b>

# 1 Introduction

The Fibonacci substitution [1], page 51 caught our interest because it defines a numeration system and we wondered if there are other substitutions having the same property. We present a class of substitutions which generate numeration systems. For more information about Automata and formal language theory, see [2] and for more on numeration systems see [3].

# 2 Definitions

First we shall give a couple of definitions which we will use in this document.

**Definition 2.0.1 (Finite automaton).** A *finite automaton*  $A = \{\mathcal{S}, \Delta, \delta, I, F, Y, \varphi\}$  is a tuple in which:

- $\mathcal{S}$  is the finite set of *states*.
- $\Delta$  is the finite set of *labels*.
- $\delta \subseteq \mathcal{S} \times \Delta \times \mathcal{S}$  is the collection of *transitions*.
- $I \subseteq \mathcal{S}$  is the collection of *initial states*.
- $F \subseteq \mathcal{S}$  is the collection of *final states*.
- $Y$  the output alphabet.
- $\varphi$  is a function from  $\mathcal{S}$  to  $Y$  named the output function or exit map.

We represent an automaton by a directed graph with a set of vertices  $\mathcal{S}$  called *states*, a set of edges  $\delta$  called *transitions* and specially marked subsets of states  $I$  and  $F$ , the *initial* and *final* states.

All through this document we shall take  $I = \{\iota\}$  as the only initial state and  $F = \mathcal{S}$  as the collection of final states and we shall take  $\Delta \subset \mathbb{N}$  unless stated otherwise.

Furthermore we shall usually take  $Y = \mathcal{S}$  and  $\varphi = Id$  as the output alphabet and the exit map.

Note that the output function applies to the states and not to the labels.

**Definition 2.0.2 (Regular language).** The language  $\mathcal{L}(A)$  of a finite automaton is called a *regular language*. The language of an automaton is the collection of strings that are *accepted* by the automaton (all paths in the automaton that lead from the initial state to a final state).

**Definition 2.0.3 (Regular expression).** Let  $\mathcal{A}$  be an alphabet. Then a *regular expression*  $E$  over  $\mathcal{A}$  is defined recursively as one of the following types:

- $\emptyset$ .
- $\epsilon$ .

- $a$ , where  $a \in \mathcal{A}$ .
- $(E_1 \cup E_2)$ , where  $E_1$  and  $E_2$  are regular expressions and the  $\cup$  operator denotes a union.
- $(E_1 \cdot E_2)$ , where  $E_1$  and  $E_2$  are regular expressions and the  $\cdot$  operator denotes concatenation.

Apart from the types in 2.0.3 we shall use some other notations.

- $E^*$ , where  $E$  is a regular expression and the  $*$  operator denotes the union of all powers of  $E$ , so  $(E^* = \cup_{n \in \mathbb{N}} E^n)$ .
- $E^+$  is an abbreviation for  $E \cdot E^*$ .

We usually omit the  $\cdot$  in a regular expression. The  $\cup$  is sometimes written as ‘+’ or ‘,’.

Note that a regular expression must be of finite length. Otherwise we call it an infinite automaton.

**Definition 2.0.4 (Substitution).** A *substitution*  $\sigma$  is a function from an alphabet  $\mathcal{A}$  to  $\mathcal{A}^* - \{\epsilon\}$  of nonempty finite words on  $\mathcal{A}$ . It extends to a substitution on  $\mathcal{A}^*$  by concatenation. So  $\sigma(ww') = \sigma(w)\sigma(w')$ . We set  $\sigma(\epsilon) = \epsilon$ , with  $\epsilon$  being the empty word.

**Definition 2.0.5 ( $n$ -word).** An  $n$ -word of a substitution  $\sigma$  is the unique word  $\sigma^n(\iota)$ ,  $\iota \in \mathcal{A}$  being the initial letter.

Sometimes we need to refer to an element in an  $n$ -word. We use the notation  $\sigma^n(\iota)_i$  when we want to refer to the  $i$ -th element of  $\sigma^n(\iota)$ .

**Definition 2.0.6 (Fixed point).** A *fixed point* of a substitution  $\sigma$  is an infinite sequence  $u$  with  $\sigma(u) = u$ .

**Definition 2.0.7 ( $k^{\max}$ ).** Let  $\Delta \subset \mathbb{N}$  be the collection of labels. Define  $k^{\max} = |\Delta| - 1$ .

Equivalently, let  $\sigma$  be a substitution. Define  $k^{\max}$  as the greatest length of the images in  $\sigma$  subtracted by 1.

**Definition 2.0.8 (Numeration system).** In general a *numeration system* is a strictly increasing sequence  $U = (U_i)_{i \in \mathbb{N}}$  such that

- $U_0 = 1$  (to represent all  $n \in \mathbb{N}$ ),
- $\sup \frac{U_{i+1}}{U_i} < \infty$  (to have a finite alphabet of digits).

An expansion of an integer  $n \in \mathbb{N}$  in such a numeration system is a finite sequence  $(a_i)_{k \geq i \geq 0}$  such that  $n = \sum_{i=k}^0 a_i U_i$ . We write this expansion as  $a_k \dots a_0$ , the most significant bit is in the first position. Note that there are more than one expansions in general, but one of them is called the *normal* or *greedy* representation. We shall discuss this in Section 5.1.

It is quite natural to express the expansion of  $U_i$  as  $1\underbrace{00\dots0}_i$ . It is also common practice to give the following restriction  $0 \leq a_i \leq \lceil \sup \frac{U_{n+1}}{U_n} \rceil$ . In general more than one expansion can be found for an integer.

**Definition 2.0.9 (Full numeration system).** A *full numeration system* is a numeration system that has the extra property:

- If  $A = a_k a_{k-1} \dots a_0$  and  $B = b_k b_{k-1} \dots b_0$ , with  $a_i + b_i \leq U_i$  for all  $i$ , then the sum  $A + B$  equals  $(a_k + b_k)(a_{k-1} + b_{k-1}) \dots (a_0 + b_0)$ .

For more on numeration systems, see [3], chapter 7 and in particular Section 7.3.

## 3 Equivalence between substitutions and automata

### 3.1 Substitutions in general

A substitution  $\sigma$  on an alphabet  $\mathcal{A}$  defines an automaton in the following way:

- Let  $\mathcal{S} = \mathcal{A}$  be the collection of states.
- Add a transition from state  $a$  to state  $b$  ( $a, b \in \mathcal{S}$ ) labeled  $i$  if  $b$  occurs in  $\sigma(a)$  at position  $(i + 1)$ .
- Let  $\iota$  be the initial state.
- Let all states in  $\mathcal{S}$  be final states.

Every automaton in turn defines a regular language (by definition).

**Lemma 3.1.1 (Automata and substitutions).** *Let  $\sigma$  be a substitution which is in bijection with an automaton  $A$ , let  $\mathcal{L}(A)$  be the language of the automaton and let  $i > 0$ . Then  $\sigma^n(\iota)_i$  is the state the automaton will be in after it is fed with the  $i$ -th word of length  $n$  of its (lexicographical ordered) input language.*

*Proof.* If we write the automaton as a computation tree, the equivalence is easier to see. We find  $\sigma^n(\iota)$  by reading all states at depth  $n$  in the tree. Let us assume that all words in  $\mathcal{L}(A)$  of length  $n$  are in order. Now we look at words of length  $n + 1$ . Every word of length  $n + 1$  comes from a word of length  $n$ . At the  $i$ -th word of length  $n$ , the automaton is in state  $\sigma^n(\iota)_i$ . The words of length  $n + 1$  that are possible by extending the word of length  $n$  are exactly those which are extended with the elements from  $\sigma^n(\iota)_i$ . These are added in order. ■

**Example 3.1.2.** In Figure 3.1.1 we see an automaton  $A$  in bijection with substitution  $\sigma$ .

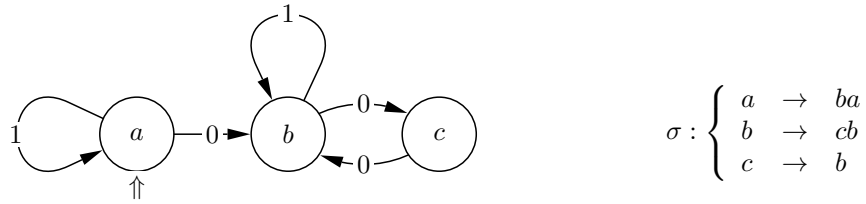

Figure 3.1.1: An automaton in bijection with substitution  $\sigma$

The computation tree of  $A$  accepts the same language as the automaton.

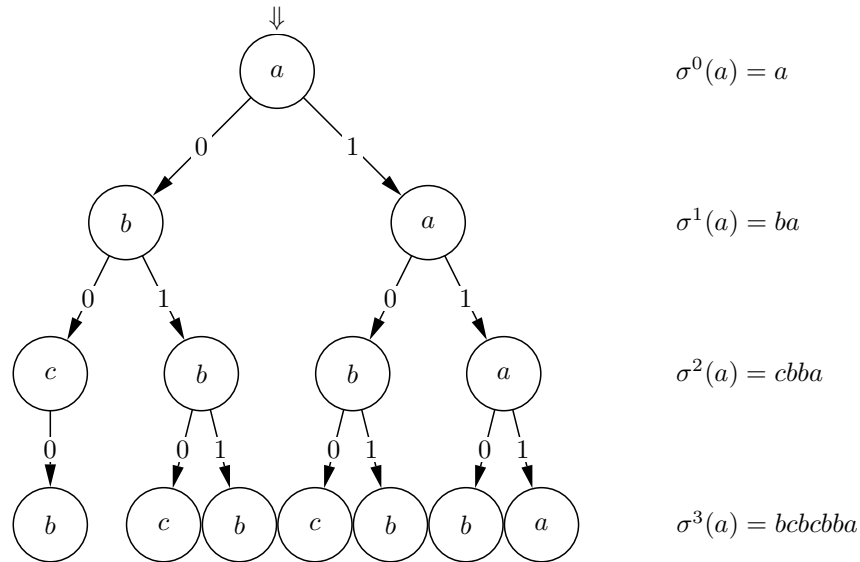

Figure 3.1.2: A computation tree in bijection with  $\sigma$

The language accepted by both automata is  $1^* + (1^*0(1+00)^*(0+\epsilon))$ . The first few elements of this language are:

$$\mathcal{L}(A) = \{ \underbrace{\epsilon}_0, \underbrace{0, 1}_1, \underbrace{00, 01, 10, 11}_2, \underbrace{000, 010, 011, 100, 101, 110, 111, \dots}_3 \}$$

If for example we feed all strings of length 3 of its input language, we shall end respectively in the states b, c, b, c, b, b, a, which is exactly the string  $\sigma^3(a)$ .

### 3.2 Substitutions with fixed points

Of course Lemma 3.1.1 is also valid for substitutions with a fixed point. If we have a fixed point, the resulting automaton will accept leading zeroes in its input









## 4.2 Fibonacci's 'brother'

In Figure: 4.2.6 we see another substitution that is numeration-automatic.

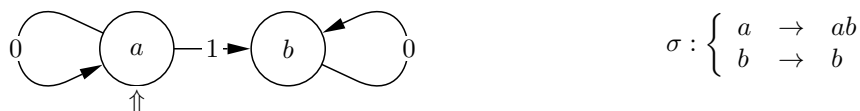

$0^*(\epsilon + 10^*)$

Figure 4.2.6: A Fibonacci-like automaton

**Example 4.2.1.** The numeration system for this substitution is based on the sequence  $(n)_{n \in \mathbb{N}^+}$ . So the first few expansions are as follows:

0  $\rightarrow$  0  
 1  $\rightarrow$  1  
 2  $\rightarrow$  10  
 3  $\rightarrow$  100  
 4  $\rightarrow$  1000  
 ...

## 5 A generalization

Can we find a more general class of automata that have similar properties? We will show that the answer is yes for a (possibly small) class of substitutions. This class can be found by calculating the sequence on which the expansion is based from the substitution itself. If we look at the Fibonacci substitution, we see that for each word  $\sigma_n$ :

$$\begin{aligned} |\sigma_n|_a &= |\sigma_{n-1}|_a + |\sigma_{n-1}|_b \\ |\sigma_n|_b &= |\sigma_{n-1}|_a \end{aligned}$$

Or in matrix form:

$$F = \begin{pmatrix} 1 & 1 \\ 1 & 0 \end{pmatrix}$$

If we now define the initial matrix as:

$$\begin{pmatrix} 1 \\ 0 \end{pmatrix}$$

and multiply it from the left repeatedly with the  $(2 \times 2)$  matrix  $F$ , we obtain:

$$\begin{pmatrix} 1 \\ 0 \end{pmatrix}, \begin{pmatrix} 1 \\ 1 \end{pmatrix}, \begin{pmatrix} 2 \\ 1 \end{pmatrix}, \begin{pmatrix} 3 \\ 2 \end{pmatrix}, \begin{pmatrix} 5 \\ 3 \end{pmatrix}, \begin{pmatrix} 8 \\ 5 \end{pmatrix}, \begin{pmatrix} 13 \\ 8 \end{pmatrix}, \dots$$

and if we add the elements of the matrices we obtain the Fibonacci sequence (note that the elements of the vectors also form the Fibonacci sequence).

The matrix for the ‘brother’ of the Fibonacci sequence is

$$\begin{pmatrix} 1 & 0 \\ 1 & 1 \end{pmatrix},$$

which applied to the initial matrix yields the sequence  $\binom{1}{n}_{n \in \mathbb{N}}$ .

By using this method we find a numeration system for any automaton. And by using a greedy generalized Zeckendorf expansion we can cover all  $k$ -automata, the Fibonacci automaton and its ‘brother’.

**Lemma 5.0.2 (Substitutions and numeration systems).** *If a substitution  $\sigma$  has a fixed point, then the sequence  $|\iota|, |\sigma(\iota)|, |\sigma^2(\iota)|, \dots$  is a numeration system.*

*Proof.* A sequence of integers is a numeration system when it complies to the restrictions of Definition 2.0.8. The first demand is adhered to because  $\iota$  is a letter, so  $|\iota| = 1$ . The second demand is adhered to as well, because  $\sup \frac{U_{i+1}}{U_i} \leq k^{\max}$  and the sequence is infinite, otherwise there would be no fixed point. ■

Note that this proof also holds for most substitutions, as long as  $\sigma_n(\iota) < \sigma^{n+1}(\iota)$ .

## 5.1 The expansion algorithm

From a substitution we can extract a numeration system, but we still need an expansion algorithm to generate  $\mathcal{L}(A)$ .

**Definition 5.1.1 (General Zeckendorf expansion).** Let  $U$  be a full numeration system. If  $n = \sum_{i=0}^k a_i U_i$ , with  $0 \leq a_i \leq k^{\max}$  for  $i = 0, 1, \dots, k-1$  and  $a_k > 0$ , we say that  $a_k a_{k-1} \dots a_0$  is the expansion of  $n$  in the  $U$  numeration system.

This algorithm is also known as the greedy or Euclidean algorithm. Hollander [4] has described the class of recurrent functions which describe a numeration system of which the Euclidean expansion is recognized by automata. This however is not the entire class of numeration-automata. We shall discuss this class in Theorem 9.0.13.

**Automatic expansion** Let  $U$  be a numeration system, let  $A$  be an automaton and let  $A_m$  be the state in which the automaton will be after reading the first  $m$  letters of an input word. Let  $t(A_m)$  be the set of outgoing transitions of state  $A_m$ . Assume that  $t(A_m) = \{0, 1, \dots, |t(A_m)| - 1\}$ . If we can write any integer  $n \geq 0$  as  $n = \sum_{i=0}^k a_i U_i$  with  $a_i \in t(A_i)$  for  $i = 0, 1, \dots, k-1$  and  $a_k > 0$  in a unique way such that the automaton accepts the expansion, then  $\text{Auto}(n) = a_k a_{k-1} \dots a_0$  is said to be the automatic expansion of the integer  $n$ .

Since we are only interested in a mapping from  $\mathbb{N}^+$  to the regular language the automaton accepts, it makes sense to look at it this way: does the automatic expansion of an integer represent the integer itself?

We have devised an algorithm that should answer that question for any substitution:

**Definition 5.1.2 (Automatic expansion).** The automatic expansion is an extension of the standard greedy algorithm.

1. Given  $n$  and the numeration system  $(U_i)_{i \in \mathbb{N}}$ . Let  $U_i$  be the largest element in  $U$  such that  $n \leq U_i(|t(A_0)| - 1)$ . Let  $m = 1$ .
2. Let  $a_i$  be the largest element in  $t(A_m)$  such that  $a_i U_i \leq n$
3. Replace  $n$  by  $n - a_i U_i$ ,  $i$  with  $i - 1$ ,  $m$  with  $m + 1$  and repeat step 2 until  $n = 0$ .

If this algorithm fails, the number  $n$  could not be expanded.

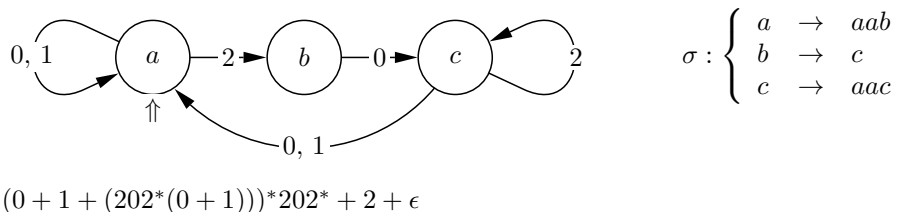

Figure 5.1.7: A numeration-automaton

**Example 5.1.3.** The substitution shown in Figure 5.1.7 defines the following numeration system:

$$\{1, 3, 7, 17, 43, 109, 275, 693, 1747, 4405, 11107, \dots\}$$

Suppose we want to expand the decimal number 41.

$U_i = 17$ , this makes  $i = 3$ . The expansion goes as follows:

The first element is 2 because  $2 \cdot 17 \leq 41 < 3 \cdot 17$ , this leaves  $41 - (2 \cdot 17) = 7$  to be expanded. Go to state  $b$  (follow label 2).

The second element is 0 because this is the only transition going out of state  $b$ . Go to state  $c$ .

The third element is 2 because  $2 \cdot U_1 = 2 \cdot 3 \leq 7$ , this leaves  $7 - (2 \cdot 3) = 1$  to be expanded. Go to state  $c$  (follow label 2).

The last element is 1. We conclude that this automaton can expand the number 41 correctly with the given algorithm.

Observe that the generalized Zeckendorf expansion does not work in this case. The greedy algorithm would have expanded the number as 2100, but this is not accepted by the automaton.

## 6 Survey

Now we look at which substitutions are numeration-automatic. We have already seen that the Fibonacci automaton and the  $k$ -automata have this property.

**The extended Fibonacci automata** Figure 6.0.8 gives another example of a substitution of which we shall prove that it is numeration-automatic.

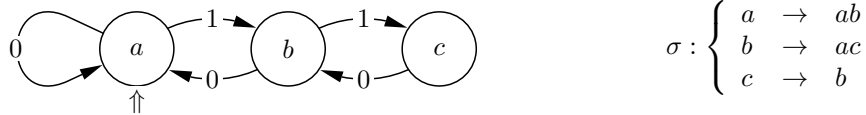

$$(0 + (1(10)^*0))^*(\epsilon + (1(10)^*(\epsilon + 1)))$$

Figure 6.0.8: A numeration-automaton

### Example 6.0.4.

From Figure 6.0.8 on we will omit the regular expressions because it is tedious work and because the automaton gives a more insightful picture of the language than the regular expression.

Just like the Fibonacci automaton, this one has a couple of ‘brothers and sisters’, the most important of which are shown in Figures 6.0.9, 6.0.10 and 6.0.11.

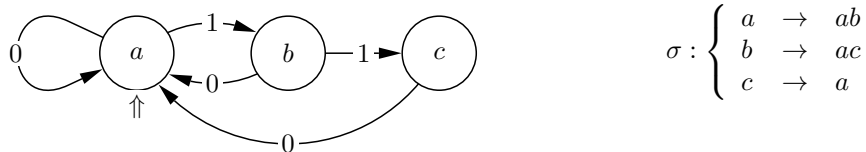

Figure 6.0.9: A numeration-automaton

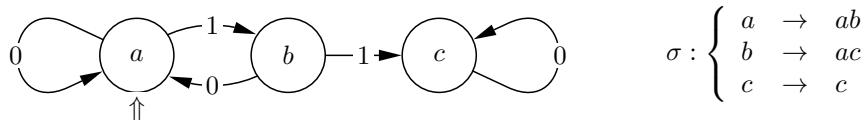

Figure 6.0.10: A numeration-automaton

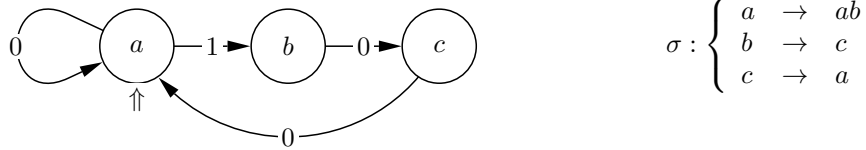

Figure 6.0.11: A numeration-automaton

We can keep adding states as shown in Figure 6.0.12

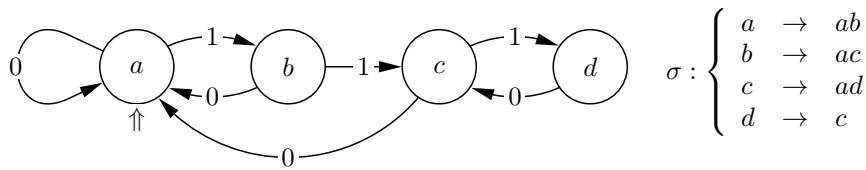

Figure 6.0.12: A numeration-automaton

We can further increase the number of transitions. See e.g. Figure 6.0.13.

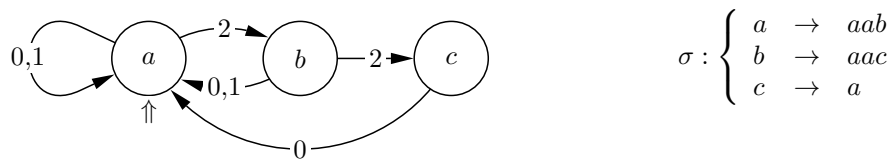

Figure 6.0.13: A numeration-automaton

And here we stumble upon a class of automata which have incidence matrices of the form

$$\begin{pmatrix} x_{0,0} & x_{0,1} & x_{0,2} & x_{0,3} & \dots & x_{0,n} \\ 1 & 0 & 0 & 0 & \dots & x_{1,n} \\ 0 & 1 & 0 & 0 & \dots & x_{2,n} \\ 0 & 0 & 1 & 0 & \dots & x_{3,n} \\ \vdots & \vdots & \vdots & \ddots & \dots & \vdots \\ 0 & 0 & 0 & \dots & 1 & x_{n,n} \end{pmatrix}$$

Here  $x_{0,0}$  must be larger or equal to 1 and  $x_{0,1}, x_{0,1} \dots x_{0,n}$  and  $x_{1,n}, x_{2,n} \dots x_{n,n}$  may be any value between 0 and  $k^{\max}$ .

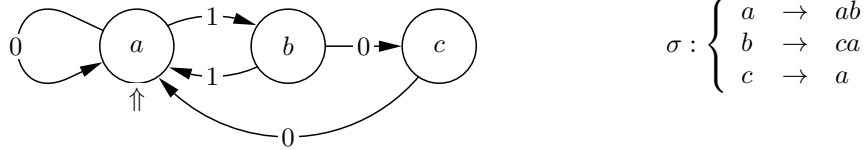

Figure 6.0.14: A non-numeration-automaton

Having an incidence matrix of this form is not sufficient, because the substitution in Figure 6.0.14 has such a matrix, but is not numeration-automatic.

The expansion sequence is as follows:

$$\{1, 2, 4, 7, 13, 24, 44, 81, 149, 274, 504, 927, \dots\}$$

The automaton crashes when we try to expand the number 5.

**Theorem 6.0.5 ( $\sigma_0$ -automatism).** *Let  $\sigma_0, \dots, \sigma_m$  be a substitution and let  $0 < i, j \leq m$ . If*

$$\sigma_0 \rightarrow \sigma_0^+ \sigma_*$$

and

$$\sigma_i \rightarrow \sigma_0^* \sigma_*$$

then the associated automaton is numeration-automatic.

*Proof.* The numeration system  $(U_i)_{i \in \mathbb{N}}$  of  $\sigma$  is given by  $U_i = |\sigma^i(\iota)|$ . Consider a level  $\ell$  of the infinite tree associated with  $\sigma$ , and number the nodes from 0 to  $|\sigma^\ell(\iota)| = U_\ell$ . Consider a string  $a_{\ell-1} \dots a_1 a_0$  leading to state  $x$  with number  $n$  at level  $\ell$ .

Call the states that the path will encounter:  $x_\ell, \dots, x_1, x$ . Each node  $x_i$  has  $a_i$  siblings to the left and all these siblings are labeled by  $\iota$ . In the  $i$  remaining steps these  $a_i$   $\iota$ 's generate  $a_i |\sigma^i(\iota)|$  symbols to the left of  $x$ . The total number is

$$\sum_{i=0}^{\ell-1} a_i |\sigma^i(\iota)| = \sum_{i=0}^{\ell-1} a_i U_i$$

Thus the representation of  $n$  by the automaton is  $a_{\ell-1} \dots a_0$  too. ■

## 7 Combining automata

The automata described above are ‘basic’ automata, which means that the automata define their own numeration system and that the automata are minimal. With minimal we mean that there is no automaton that defines the same numeration system, but has less states. We can use these automata as a basis for other automata.

**The product automaton** Let  $A$  and  $B$  be automata, let  $\iota$  be the initial state of an automaton. Let  $\mathcal{S}_A$  be the states of  $A$  and  $\mathcal{S}_B$  the states of  $B$ . We define a *superstate* as a state consisting of a tuple  $(a, b)$  with  $a \in \mathcal{S}_A$  and  $b \in \mathcal{S}_B$ . We make the product automaton as follows.

- Start in the superstate  $(\iota, \iota)$  and make this state the initial state.
- If both  $A$  and  $B$  have a transition from  $\iota$  labeled  $i$ , make a new superstate  $(a, b)$  (the endpoints of the transitions in both automata) and make a new transition from  $(\iota, \iota)$  to  $(a, b)$  labeled  $i$ .
- Do the same for all other states.

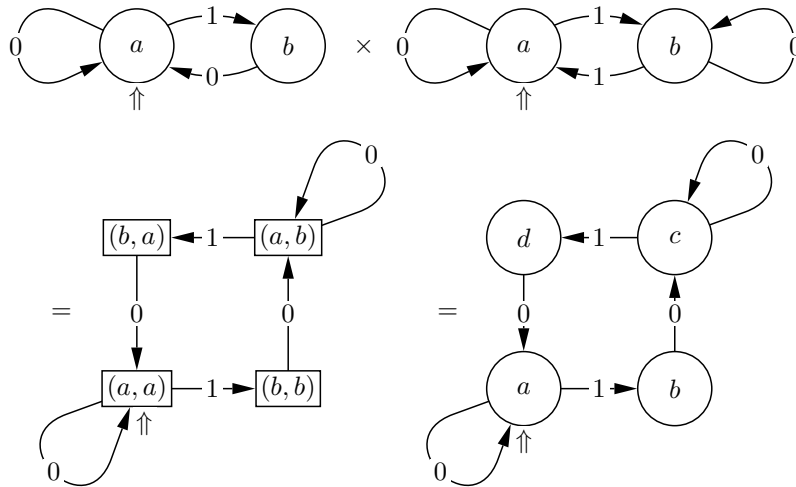

Figure 7.0.15: Combined automata

**Example 7.0.6.** In Figure 7.0.15 we have combined the Fibonacci automaton with the Prouhet-Thue-Morse automaton by applying the product construction to the two automata.

The result is an automaton that generates the Prouhet-Thue-Morse sequence in the Fibonacci numeration system. By using the following exit map (projection on the second coordinate):

$$\varphi : \begin{cases} a \rightarrow a \\ b \rightarrow b \\ c \rightarrow b \\ d \rightarrow a \end{cases}$$

We obtain the Prouhet-Thue-Morse sequence again, and by using this exit map



(projection on the first coordinate):

$$\varphi : \begin{cases} a \rightarrow a \\ b \rightarrow b \\ c \rightarrow a \\ d \rightarrow b \end{cases}$$

We get the Fibonacci sequence again.

Combining automata can result in a substitution for which it is not directly clear that it is numeration-automatic.

**Example 7.0.7.** When we combine the substitutions

$$\sigma_A : \begin{cases} a \rightarrow ab \\ b \rightarrow ac \\ c \rightarrow cc \end{cases}$$

with

$$\sigma_B : \begin{cases} a \rightarrow ab \\ b \rightarrow c \\ c \rightarrow ac \end{cases}$$

we obtain (after renaming  $a := (a, a), b := (b, b), c := (a, c), d := (b, c), e := (c, c), f := (c, a), g := (c, b)$ )

$$\sigma_{A \times B} : \begin{cases} a \rightarrow ab \\ b \rightarrow c \\ c \rightarrow ad \\ d \rightarrow ae \\ e \rightarrow fe \\ f \rightarrow fg \\ g \rightarrow e \end{cases}$$

and the induced incidence matrix is not of the previously defined form

$$\begin{pmatrix} 1 & 0 & 1 & 1 & 0 & 0 & 0 \\ 1 & 0 & 0 & 0 & 0 & 0 & 0 \\ 0 & 1 & 0 & 0 & 0 & 0 & 0 \\ 0 & 0 & 1 & 0 & 0 & 0 & 0 \\ 0 & 0 & 0 & 1 & 1 & 0 & 1 \\ 0 & 0 & 0 & 0 & 1 & 1 & 0 \\ 0 & 0 & 0 & 0 & 0 & 1 & 0 \end{pmatrix}.$$

Still this substitution is numeration-automatic, because this automaton has exactly the same behavior as its ‘parents’.

**Theorem 7.0.8 (Product of  $\sigma_0$ -automata).** *The product automaton of  $\sigma_0$ -automata is  $\sigma_0$ -automatic.*

*Proof.* Every state  $x$  has  $|t(x)|$  outgoing transitions, the first  $|t(x)| - 1$  of them are pointing to the initial state. We determine the product of two states  $x$  and  $y$ . Assume that  $|t(x)| \leq |t(y)|$ , this will result in a node with the first  $|t(x)| - 1$  transitions pointing to  $(\iota, \iota)$ . Therefore the resulting automaton is  $\sigma_0$ -automatic. ■

**Theorem 7.0.9 (Product of  $\sigma_0$ - and  $k$ -automata).** *The product automaton of a  $\sigma_0$ -automaton and a  $k$ -automaton is numeration-automatic.*

*Proof.* If the  $k^{\max}$  of the  $\sigma_0$ -automaton is larger than the  $k$  of the  $k$ -automaton, then the  $k^{\max}$  of the product automaton will be  $k$ . Thus, when we leave out all transitions higher than  $k$  in the original  $\sigma_0$ -automaton, the resulting product automaton will be the same. Therefore we may assume that  $k^{\max} \leq k$ .

Consider the computation tree of the  $\sigma_0$ -automaton. When we apply the product construction to this tree, the structure of the tree does not change but the states are re-labeled. The first coordinate indicate the original state. Thus Theorem 6.0.5 still applies. The fixed point of the substitution is still computed correctly by the automaton because of Lemma 3.1.1. ■

The product automaton of two  $k$ -automata is  $k$ -automatic. If for example we construct the product automaton of a 2- and a 3-automaton, the result will be a 2-automaton.

## 8 Reverse reading

We know from the theory of  $k$ -automata [1], page 15 that if a  $k$ -automaton in direct reading exists, there also exists a  $k$ -automaton in reverse reading that accepts the same input language and gives the same mapping to the output alphabet. The only difference is that the automaton in reverse reading reads the elements of its input from right to left instead of the normal order. The proof of this relies upon the existence of a  $k$ -kernel.

In general we can not make a  $k$ -kernel. However, we can construct an automaton in reverse reading from an automaton in direct reading without having to construct a kernel.

We know this is possible because the theory of formal languages [2], page 419 states that a regular language is closed under the operation of mirroring, but this theory does not give an algorithm to make such an automaton. This is because the theory of formal languages does not apply to  $k$ -automata and numeration-automata directly. For example, the Prouhet-Thue-Morse automaton should be reduced to an automaton with one state and two loops with labels 0 and 1 according to this theory, because this is the minimal automaton that accepts  $\{0, 1\}^*$ . Moreover, all 2-automata should be reduced to this automaton.

**Reversing an automaton** To reverse an automaton, we only have to make all final states initial states and vice versa and we must change the direction of the transitions. By doing this, we probably end up with a non-deterministic

automaton. Fortunately, the non-deterministic automaton can be converted to a deterministic one using the *subset construction* [2], page 118. This construction does not take into account that the set of final states may have partitions. Since our automata have output in their final states, the output induces a partition of the set of final states. General automata do not have an output in their states, a state is simply a final state or not.

Analogous to the subset construction we make our automaton in reverse reading, but we take into account the possibility of partitions by including the output function in the state.

**Example 8.0.10.** We have an automaton shown in Figure 8.0.16. Since the automata we are going to make do not necessarily consist of final states only, we shall mark the final states in the following automata with an inner circle.

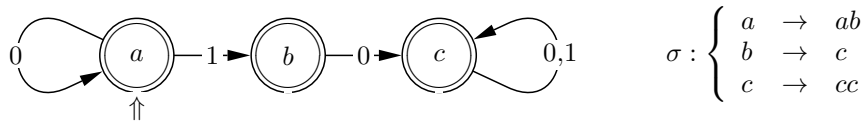

Figure 8.0.16: A deterministic automaton in direct reading

- First we swap final- and initial states and we change the direction of the transitions as shown in Figure 8.0.17.

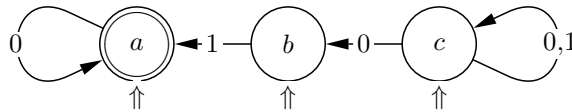

Figure 8.0.17: A non-deterministic automaton in reverse reading

- Now we shall apply the subset construction [2], page 120 on each of the initial states as if we were dealing with three automata. We shall denote the state of the three automata in one state, so if the automata are in states  $\{a\}$ ,  $\{b\}$ ,  $\{c\}$  respectively, we shall notate this as  $\{\{a\}, \{b\}, \{c\}\}$ , because  $a$  is the initial state of the first automaton,  $b$  the initial state of the second and  $c$  is the initial state of the third automaton.

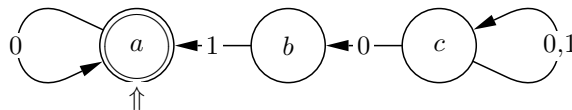

Figure 8.0.18: Automaton 1

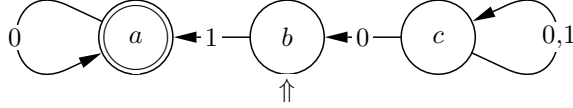

Figure 8.0.19: Automaton 2

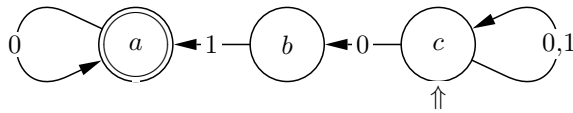

Figure 8.0.20: Automaton 3

Reading a 0 in state  $\{\{a\}, \{b\}, \{c\}\}$  will result in state  $\{\{a\}, \emptyset, \{b, c\}\}$ , because automaton 1 stays in state  $a$  when reading a 0, automaton 2 crashes when reading a 0 in state  $b$  and automaton 3 goes to state  $\{b, c\}$  because there are two outgoing branches labeled 0 in state  $c$ .

We also have to determine the output function of each state. This is done by observing in which coordinate the initial symbol (in this case  $a$ ) of the original automaton is. For example the state  $\{\{a\}, \emptyset, \{b, c\}\}$  will have  $a$  as output and the state  $\{\emptyset, \emptyset, \{a, b, c\}\}$  will have  $c$  as output. This is because when we have reached the initial state in reverse reading, we have also reached a final state in direct reading. For clarity, we write the output preceded by a slash. In the first instance we write  $\{\{a\}, \{b\}, \{c\}/a\}$ . If no output can be found, we use  $\epsilon$  as output. This means that the state in question is not a final state.

When we start in state  $\{\{a\}, \{b\}, \{c\}/a\}$  and follow the labels 0 and 1, we get two new states. We now apply the same construction to these new states. The result is shown in Figure 8.0.21.

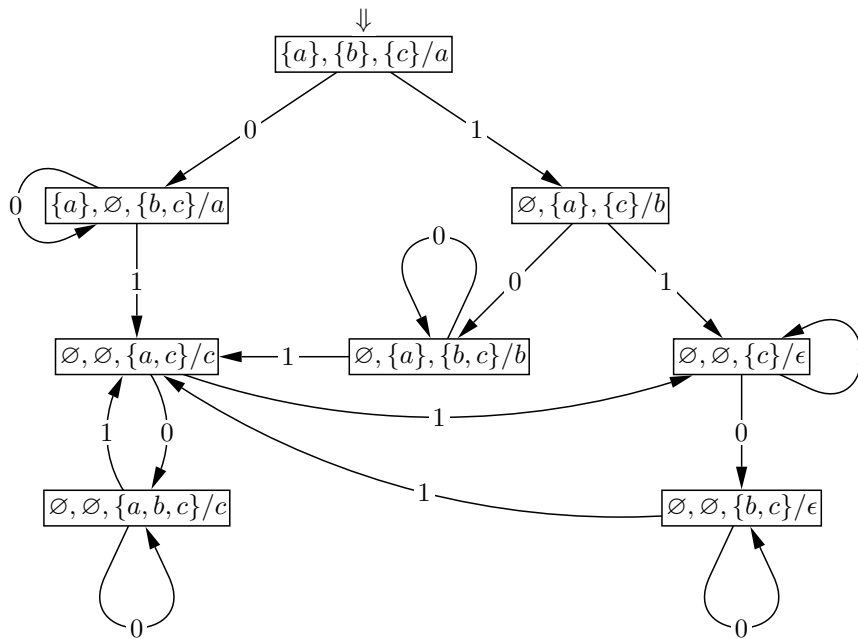

Figure 8.0.21: A deterministic automaton in reverse reading

- If we simplify the nodes to standard notation, we get the automaton as shown in Figure 8.0.22.

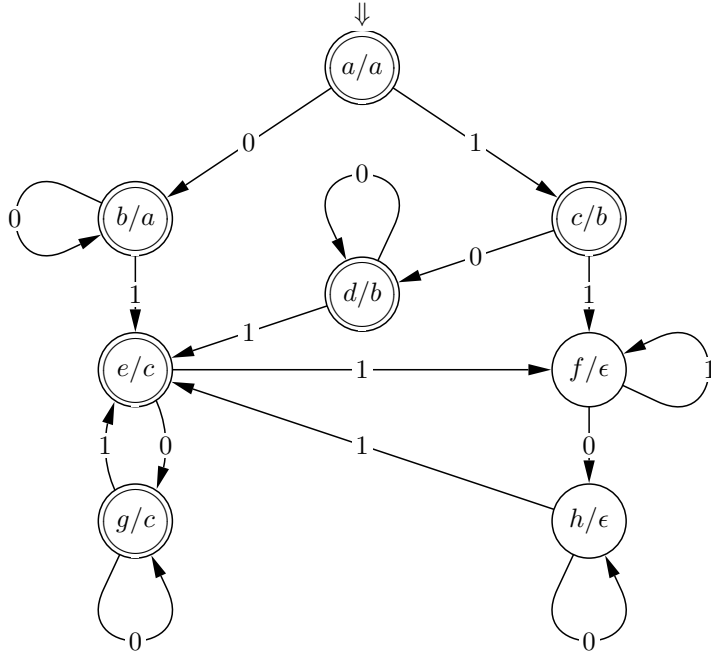

Figure 8.0.22: A simplified deterministic automaton in reverse reading

## 9 Numeration systems

The class of numeration-automatic substitutions has an interesting subclass: the subclass of substitutions that define a full numeration system. We believe that this is the class of  $\sigma_0$ -automata with the restriction that the cardinality of the images of the substitution do not increase, so  $|\sigma_0| \geq |\sigma_1| \geq \dots$ . In this section we show that the condition suffices.

Without loss of generality, we can write a  $\sigma_0$ -substitution in the following way

$$\begin{aligned} \sigma_0 &\rightarrow \sigma_0^+ \sigma_1 \\ &\dots \\ \sigma_{k-1} &\rightarrow \sigma_0^* \sigma_k \\ \sigma_k &\rightarrow \sigma_0^* \sigma_* \end{aligned}$$

We assume this special form throughout this section.

First we derive a lemma for general  $\sigma_0$ -automata.

**Lemma 9.0.11 (The recurrent function of a substitution.)** *If  $\sigma$  is a substitution of  $\sigma_0$ -automatic type with  $k$  substitution rules, then the numeration system is a linear recurrent function of at most order  $k$ .*

*Proof.* Since each substitution rule is of the form

$$\sigma_i \rightarrow \sigma_0^{j_i} \sigma_{i+1}, j_i \geq 0$$

and the first rule is of the form

$$\sigma_0 \rightarrow \sigma_0^{j_0} \sigma_1, j_0 > 0,$$

we can extract part of the recurrent function from the first substitution rule. This results in a relation depending on  $\sigma_0$  and  $\sigma_1$ :  $a_n = j_0 a_{n-1} + b_{n-1}$ . Hence  $b_{n-1}$  can be expressed as  $a_n - j_0 a_{n-1}$ , analogously we can write the next equation as  $b_n = j_1 a_{n-1} + c_{n-1}$ . This yields  $c_{n-1} = b_n - j_1 a_{n-1} = a_{n+1} - j_0 a_n - j_1 a_{n-1}$ . In this way we can successively write  $b_{n-1}, c_{n-1}, d_{n-1}, \dots$  as linear combinations of  $a_n, a_{n+1}, a_{n+2}, \dots$ . Finally we get a linear homogeneous recurrence relation with constant coefficients of the numbers  $a_n$ . The order of this recurrence equals the number of substitution rules. ■

**Example 9.0.12.** Consider the following substitution scheme.

$$\sigma : \begin{cases} a & \rightarrow ab \\ b & \rightarrow aac \\ c & \rightarrow d \\ d & \rightarrow ac \end{cases}$$

First we write the substitution rules as recurrent functions.

$$\begin{aligned} a_n &= a_{n-1} + b_{n-1} \\ b_n &= 2a_{n-1} + c_{n-1} \\ c_n &= d_{n-1} \\ d_n &= a_{n-1} + c_{n-1} \end{aligned}$$

Now we start eliminating

$$\begin{aligned} b_{n-1} &= a_n - a_{n-1} \\ c_{n-1} &= b_n - 2a_{n-1} = a_{n+1} - a_n - 2a_{n-1} \\ d_{n-1} &= c_n = a_{n+2} - a_{n+1} - 2a_n \end{aligned}$$

So

$$\begin{aligned} a_{n+3} - a_{n+2} - 2a_{n+1} &= a_{n-1} + a_{n+1} - a_n - 2a_{n-1} \\ a_{n+3} &= a_{n+2} + 3a_{n+1} - a_n - a_{n-1} \end{aligned}$$

And the final result is:  $a_n = a_{n-1} + 3a_{n-2} - a_{n-3} - a_{n-4}$ , which is the recurrence that generates the sequence 1, 2, 5, 10, 22, 45, 96, 199, 420, 876, ... (with the appropriate initial conditions  $|a|, |\sigma(a)|, |\sigma^2(a)|, |\sigma^3(a)|$ ).

**Theorem 9.0.13 (Full numeration systems and numeration-automatism).**

*If  $\sigma$  is a  $\sigma_0$ -substitution, with  $|\sigma(\sigma_0)| \geq |\sigma(\sigma_1)| \geq \dots \geq |\sigma(\sigma_k)|$ , then the associated automaton generates a full numeration system.*

*Proof.* Consider the computation tree associated with the substitution  $\sigma$ . Choose  $n$  such that  $|\sigma^n(\sigma_0)| \leq x < |\sigma^{n+1}(\sigma_0)|$ .

Let  $a$  be a state with  $\sigma(a) = \sigma_0^{\ell_a} a'$ , with  $a' \in \{\epsilon, \sigma_1, \dots, \sigma_k\}$ .

The state  $a$  results in  $|\sigma^{m+1}(a)|$  states  $m$  levels deeper in the tree. Because  $|\sigma^m(\sigma_0)| = U_m$ , these states can be partitioned in  $\ell_a$  sets of  $U_m$  states and one set of  $|\sigma(a')|$  states with  $|\sigma^m(a')| < U_m$  because  $\sigma(a') < \sigma(\sigma_0)$ .

We now iterate the following procedure starting with the triple  $(x, \sigma_0, n)$ .

Consider the triple  $(x, a, m)$  with  $x$  an integer such that  $x < U_{m+1}$  and  $a$  a state. We write  $x = \ell_m U_m + x'$  with  $0 \leq x' < U_m$ . Then  $\ell_m < \frac{U_{m+1}}{U_m} \leq k^{\max} + 1$ , hence  $\ell_m \leq k^{\max}$ . If  $\ell_m < \ell_a$ , then  $x$  is the result of state  $\sigma_0$  when we go  $m$  levels higher. If  $\ell_m = \ell_a$ , then  $x$  is the result of state  $a'$  when we go  $m$  levels higher. In the former case, we replace the triple  $(x, a, m)$  by  $(x', \sigma_0, m - 1)$ , in the latter case by  $(x', a', m - 1)$ . Recall that if  $a' = \sigma_i, a = \sigma_j$ , then  $i \geq j$  and therefore  $|\sigma(\sigma_i)| \leq |\sigma(\sigma_j)|$ .

Obviously  $x = \ell_n U_n + \ell_{n-1} U_{n-1} + \dots + \ell_0 U_0$ . However, by construction we have that  $\ell_n \ell_{n-1} \dots \ell_0$  is the expansion of  $x$  in the computation tree. Hence the numeration system is full. ■

We remark that the extra condition can not be dropped. See Example 5.1.3.

## 10 Conclusion

We have seen that with the automatic expansion we can successfully find numeration systems for a class of automata. The most important findings are that the substitution defines a numeration system and that the automaton defines an expansion algorithm. Combine them and we get the class of numeration-automatic sequences.

The sequences which are not numeration-automatic remain interesting, because the associated automaton calculates most of the letters in the fixed point correctly, but it leaves gaps. Maybe it is somehow possible to ‘repair’ the automaton to correct this behavior, for example by using a stack automaton, but this is beyond the scope of this document.

## 11 More on numeration-automatism

The following website has a program that checks a substitution for numeration-automatism.

<http://www.liacs.nl/~jlaros/semi/>

The “On-Line Encyclopedia of Integer Sequences” is a huge database of integer sequences. The author has contributed some sequences and commented on some other sequences. See

<http://www.research.att.com/~njas/sequences/Seis.html>



for the main page, or one of the following pages.

<http://www.research.att.com/cgi-bin/access.cgi/as/njas/sequences/eisA.cgi?Anum=A000045>

<http://www.research.att.com/cgi-bin/access.cgi/as/njas/sequences/eisA.cgi?Anum=A101197>

<http://www.research.att.com/cgi-bin/access.cgi/as/njas/sequences/eisA.cgi?Anum=A101168>

<http://www.research.att.com/cgi-bin/access.cgi/as/njas/sequences/eisA.cgi?Anum=A101169>

<http://www.research.att.com/cgi-bin/access.cgi/as/njas/sequences/eisA.cgi?Anum=A101399>

<http://www.research.att.com/cgi-bin/access.cgi/as/njas/sequences/eisA.cgi?Anum=A101400>

## 12 Acknowledgements

The author wishes to thank Dr. Hendrik Jan Hoogeboom and Prof. Dr. R. Tijdeman for their numerous comments and insightful ideas.

## References

- [1] Fogg, N. Pytheas. Substitutions is Dynamics, Arithmetics and Combinatorics, Springer Verlag, 2002.
- [2] Wood, Derick. Theory of Computation, John Wiley & sons, inc, 1987.
- [3] Lothaire, M. Algebraic combinatorics on words, Cambridge, 2002.
- [4] Hollander, M. Greedy numeration systems and regularity. Theory Comput. Systems 31 (1998), 111–133.