

# Quantum Computatinal Gates with Radiation Free Couplings

I. O. Kulik<sup>1</sup>, T. Hakioglu<sup>1</sup> and A. Barone<sup>2</sup>

<sup>1</sup>*Department of Physics, Bilkent University, Ankara 06533, Turkey*

<sup>2</sup>*Department of Physical Sciences, University of Naples Federico II, P. Tecchio 80, Naples 80125, Italy*

## Abstract

We examine a generic three state mechanism which realizes all fundamental single and double qubit quantum logic gates operating under the effect of adiabatically controllable static (radiation free) bias couplings between the states. At the instant of time that the gate operations are defined the third level is unoccupied which, in a certain sense derives analogy with the recently suggested dissipation free qubit subspaces. The physical implementation of the mechanism is tentatively suggested in a form of the Aharonov-Bohm persistent-current loop in crossed electric and magnetic fields, with the output of the loop read out by a (quantum) Hall effect aided mechanism.

*Introduction* Quantum computation is based on the realization of the computational logic gates by the manipulation of the quantum states via turning on and off specific interactions controlled by quantum switches. Recent trends in the experimentation of the small scale quantum logic gates suggested for implementation in the developing quantum computers<sup>1</sup> demands effective gate operations to be performed by more efficient mechanisms based on dissipation free interactions between the qubit states that are designed to reduce environment induced decoherence effects. There are fundamental differences between the well explored classical and the much less explored quantum computation and this primarily arises from the manifestations of the fundamental principles of quantum mechanics. From

the information theory point of view, quantum computation makes full use of such classically peculiar concepts as the superposition and entanglement principles to its maximal advantage to create what is often called the principle of quantum parallelism via which exponentially unsurpassed performances are expected in tackling special algorithmic problems such as the quantum factorization algorithm due to Shor<sup>2</sup>, the Grover's unstructured data search<sup>3</sup>, or, more generally, quantum simulation of the many-body problems (e.g. Ref. [4]). On the physical point of view, making full use of quantum mechanics in a computational frame requires a full control of the interacting quantum system with the *external* classical system including the input-output measurement devices as well as not so fully controllable environmental agents. The delicate susceptibility of the supposedly isolated evolution of the interacting quantum system with the interfering environment as well as the systems own inherent fluctuations lead to the unwanted decoherence effects. Most crudely speaking, decoherence can be summarized in the computational terminology as the loss of computational information stored in the parameters of the quantum state. In turn, decoherence leaves a small room both spatially and temporally to manipulate the quantum system for computational purposes and the conditions to fight decoherence are very severe. In this context, inventing new mechanisms and designing new experimental systems aiming to minimize all sources of decoherence is a major task of the research efforts in the physical aspects of this field.

The environmental coupling can be generally considered to be weak but not weaker than a realistic level in which it becomes difficult to single out the major sources of decoherence. In an opposite context, the coupling to the environment has been suggested to keep the decoherence under control. Lately new theoretical mechanisms based on multi level quantum systems were proposed in which the environment strongly couples to the high levels under certain conditions but not to a subspace in a direct way. It is suggested that a strong environmental coupling can be used to cage the quantum system in the Hilbert space into this subspace free of dissipation and therefore these dissipation free subspaces can provide a shelter away from decoherence where the quantum computational bits (qubits) can be

manipulated. The main requirement in these theories is the preexistence of the dissipation free subspaces<sup>5</sup>. More recently Beige et al.<sup>6</sup> have examined this idea theoretically in a multi-atom three state model with doubly degenerate ground state comprising the mentioned dissipationless subspace where the third levels of the atoms strongly coupled to each other and to a single cavity mode, and Zanardi and Rasetti<sup>7</sup> discussed earlier a somewhat similar four-state model with a decoherence-dissipation free subspaces. When all atoms are in the ground state and the cavity mode is unoccupied, the dissipative interaction is effectively switched off. As result, if the cavity field is in the vacuum state the subspace comprising the doubly degenerate ground state is dissipation free. More recently there is also evidence that dissipation free subspaces can be physically realized and experimentally tested<sup>9</sup>.

In this article we propose a deceptively similar three state idea to Beige et al. with the fundamental exception that the mechanism utilizes radiation free static couplings to perform the quantum logic gates. The operations are defined as static interactions between the first two levels (qubit) with the third (auxiliary) level and, the end of the operation is defined as the instant such that the desired qugate is obtained in the qubit subspace with no probability of occupation in the auxiliary state. Moreover in the proposed model the otherwise independent concepts of qubit and quantum gate are unified within the same quantum unit. Therefore in our model the leakage of the wavefunction into the third level is not avoided, on the contrary, the dynamical occupation of the third level is an essential part of the qubit gate operations. The advantages of the proposed model are that the wavefunction never leaks out of the Hilbert space spanned by the three states and the quantum gates are obtained via radiationless mechanisms as they involve time-independent non-resonant interactions. To our knowledge, similar radiationless qugate operations have not been discussed yet. The advantage of the radiationless coupling is clearly to suppress substantially the otherwise environmental dissipative effects in the case when resonant coherent light pulse (as in the case of ion trap<sup>8</sup> and many other mechanisms) or magnetic pulse (as in the case of superconducting systems) are used to manipulate the quantum states.

*Persistent current qubit.* The realization of such quantum computation schemes can be

attempted with use of macroscopic quantum interference effects in superconducting systems (the Josephson effect<sup>10</sup>), or the Aharonov-Bohm<sup>11</sup> persistent-current states in nonsuperconducting structures of small size<sup>12, 13</sup>. The latter structure naturally realizes the inverted double-degenerate ground state separated from the higher energy state(s) by a finite gap and therefore basically not prone to decoherence. Comparatively to this, the superconducting junctions in the macroscopic quantum regime<sup>14</sup> may suffer from the decoherence due to unavoidable admixture of gapless localized excitations near the barrier area activated at flip transitions between the degenerate states (this is seen in the broad resonances of the Schrodinger Cat states observed experimentally<sup>15-17</sup>). In our paper we suggest the persistent current loops for the physical realization of qubits and qugates. The three-site loop is supplemented by a (macroscopic) nondemolitional measuring device (the quantum Hall bar in this case), which performs both tasks in a coherent, decoherence-free fashion by coupling for a short time the qubit subspace to the third (auxiliary) level.

The three state system in our consideration is defined to be in a  $\Lambda$ -shaped configuration (Fig.1) under zero bias potential, i.e. the ground state is doubly degenerate and there is a third (auxiliary) state. One possible realization is via a three-sectional mesoscopic ring intersected by tunnelling barriers (or consisting of overlapping metallic films separated by thin oxide layers) as shown in Fig.2. The isolated qubit structure can in principle be realized naturally as a three-island defect in an insulating crystal, similar to negative-ion triple vacancy (known as  $F_3$  -center) in the alkali halide crystal which can be found in standard textbooks.<sup>18</sup> The gate manipulations can be performed via an Aharonov-Bohm flux perpendicular to the ring together with a constant electric field within the plane of the ring (Fig.3). The information to be implemented into the computational basis of the quantum computer is stored in the form of amplitudes of the persistent-current states<sup>12, 13</sup> of the normal-state Aharonov-Bohm ring (the qubit), and processed via the radiation free transitions between the states in an invariant subspace, effected by the static bias potentials on the sites of the ring (the qugates).

In the absence of the bias potentials, the dynamics is governed by the pure tunnelling

Hamiltonian

$$H = -\tau \sum_{n=1}^3 (a_n^\dagger a_{n+1} e^{i\alpha} + a_{n+1}^\dagger a_n e^{-i\alpha}) \quad (1)$$

where  $\tau$  is a real tunnelling amplitude between the islands and  $\alpha$  is a controllable phase. Eq. (1) is represented in the diagonal basis by the eigenenergies  $\epsilon_m = -2\tau \cos(\frac{2\pi}{3}m + \alpha)$ . The eigenenergies form the  $\Lambda$  configuration at the symmetric point  $\alpha = \pi/3$  with the energies  $(-1, 2, -1)\tau$  for  $m = 0, 1, 2$  respectively. The three sites interact by a bias *potential* loop with the site *potential*  $V_n = V_0 \cos 2\pi n/3$  where  $n = 0, 1, 2$  is the site index. It is clear that for this choice, the potential can be obtained by a conservative field since the total potential around the loop vanishes, i.e.  $V_0 + V_1 + V_2 = 0$ . The total Hamiltonian is then the sum of Eq. (1) and the site-potential which is represented in the diagonal basis of  $H$  by the matrix (in units of  $\tau$ )

$$H_d + H_1(V_0) = \begin{pmatrix} -1 & \nu & \nu \\ \nu & 2 & \nu \\ \nu & \nu & -1 \end{pmatrix} \quad (2)$$

where  $H_d = \text{diag}(-1, 2, -1)$  is the Hamiltonian (1) in the diagonal form,  $\nu = V_0/2\tau$  is the dimensionless interaction parameter. The proposed mechanism is designed to be radiation free and the quantum gate operations are performed by adiabatically tuning the static potentials. The system is prepared in a particular ground state (no occupation of the auxiliary level) and the time evolution is continued until the instant  $t = t^*$  at which the auxiliary level cycles back to its initial configuration. The other parameters are adjusted so that the desired single-qubit gate is realized at the end of the single cycle of the auxiliary level. The unitary time evolution at  $t = t^*$  is then given by

$$e^{it^*(H_d + H_1(V_0))} = \begin{pmatrix} A & 0 & B \\ 0 & X & 0 \\ C & 0 & D \end{pmatrix} \quad (3)$$

where  $A, B, C, D$  are complex,  $X$  is a pure phase and, other than the unitarity condition, no other restrictions apply on the matrix elements. The form of the unitary matrix in Eq. (3)

leaves the qubit subspace invariant irrespectively of the value of  $X$  as long as the initial wavefunction is confined to the same subspace. The instantaneous vanishing of the certain matrix elements in (3) is due to the destructive interference in the transition amplitudes between the auxiliary level and the qubit subspace. Using the exact expressions describing the absolute level amplitudes, it can be inferred that the destructive interference condition at  $t = t^*$  can be satisfied if the transition energies are commensurate. One way to express this condition is

$$E_3 - E_1 = K (E_2 - E_3) , \quad K = integer \quad (4)$$

where  $E_i = E_i(V_0)$  ,  $i = 1, 2, 3$  are the eigenenergies of (2) plotted against  $V_0$  in Fig.4. In fact, Eq. (4) is a condition on the static potential. Solving the eigenvalues of Eq. (2) we find that the potential is allowed to take a discrete set of values determined by

$$V_0^{(K)} = -\frac{2}{3K} [K^2 + K + 1 + (K - 1)\sqrt{K^2 + 4K + 1}] . \quad (5)$$

*Qugate operations.* We now demonstrate that different values of the integer  $K$  performs different qubit gates. In particular, among the fundamental single qubit gates the bit flip and the Hadamard-like gates can be realized by the time evolution of the Hamiltonian alone in Eq. (2) at certain instants and at specifically tuned values of  $V_0$ . Among the elementary qubit gates, the phase gate requires a control on the relative phase between the degenerate states. In order to induce a relative phase, the otherwise degenerate states in the qubit subspace are made nondegenerate by a shift in their eigenlevels by turning on a degeneracy breaking interaction. This is a relatively well known method in the case of Aharonov-Bohm rings, for instance, by slightly shifting the dc-flux away from the value where doubly degenerate configuration is defined. The net effect of this shift in the adiabatic limit is represented by a diagonal, degeneracy breaking effective term in the total Hamiltonian

$$H_2 = \text{diag}(\Delta\epsilon_1, \Delta\epsilon_2, \Delta\epsilon_3) . \quad (6)$$

The diagonal form of Eq. (6) implies that the phase shift can be obtained independently from the other gates since, due to the diagonal form, the time evolution is manifestly adia-

batic. One other advantage in this diagonal form is that the transformation leaves the qubit subspace invariant and thus it can be conveniently used for phase correction. We demonstrate below the realization of the different single qubit operations by a mere change of the integer  $K$  and letting the system time evolve. The populations of the three eigenstates of the Hamiltonian in Eq. (1) are plotted in Fig.5 as functions of time and for  $K = 1$ . The first observation is that the maximal occupation of the auxiliary state is 20% of the total unit probability. At periodic time intervals, of which period  $t_1$  is indicated on the horizontal axis by an arrow, the population in the auxiliary state vanishes and the wavefunction instantaneously collapses onto the qubit-subspace non-demolitionally. Hence, at  $t = t_1$  the degenerate levels exchange their population. The bit flip should introduce no relative phase between the qubit states, thus, one needs to know not the probabilities but the amplitudes. These can be directly obtained from the unitary time evolution at  $K = 1$  (which corresponds in Eq.(2) to  $V_0^{(1)} = -2$ ). Evolving the Hamiltonian in (2) at this configuration for  $t_1 = \pi/\sqrt{6}$  (in units of  $\hbar/\tau$ ),  $t_1 = \pi/\sqrt{6}$  (in units of  $\hbar/\tau$ ) as

$$\exp\{-it_1 \begin{pmatrix} -1 & -1 & -1 \\ -1 & 2 & -1 \\ -1 & -1 & -1 \end{pmatrix}\} = \begin{pmatrix} 0 & 0 & -1 \\ 0 & 1 & 0 \\ -1 & 0 & 0 \end{pmatrix} \quad (7)$$

and ignoring the overall phase, we obtain a bit-flip in the qubit subspace. The second gate manifested by the commensuration condition is the Hadamard gate which is obtained at  $K = 3$ . In Fig.6 the occupation of the states are plotted as functions of time. The period  $t_3$  at which the instantaneous collapse to the qubit subspace with symmetric occupations occurs is indicated by an arrow. The unitary matrix that performs this operation is

$$\exp\{-it_3 \begin{pmatrix} -1 & V_0^{(3)}/2 & V_0^{(3)}/2 \\ V_0^{(3)}/2 & 2 & V_0^{(3)}/2 \\ V_0^{(3)}/2 & V_0^{(3)}/2 & -1 \end{pmatrix}\} = \frac{e^{i\alpha}}{\sqrt{2}} \begin{pmatrix} 1 & 0 & -i \\ 0 & \sqrt{2}e^{i\beta} & 0 \\ -i & 0 & 1 \end{pmatrix} \quad (8)$$

where  $t_3 = \pi/2 [E_2(V_0^{(3)}) - E_3(V_0^{(3)})] = 0.7043492$  (in units of  $\hbar/\tau$ ) and  $V_0^{(3)} = -2(13 + 2\sqrt{22})/9$ . The  $\alpha$  is an overall phase which is ignored, and,  $\beta$  is the phase of the auxiliary level which is irrelevant for the qubit subspace. The gate in (8), after correcting the phase

by a relative phase shift becomes a Hadamard gate in the qubit subspace. The phase is corrected by a phase gate which is obtained by turning off  $V_0$  and shifting the levels by  $H_2$ . The shifted flux removes the degeneracy with a net effect implied by  $H_2$  and, under the time evolution, phases between the states are induced without changing the populations. The time dependence of the transformation induced by the phase gate is

$$G(\phi) = e^{-it(H_d+H_2)} = \begin{pmatrix} e^{i\phi_1(t)} & 0 & 0 \\ 0 & e^{i\phi_2(t)} & 0 \\ 0 & 0 & e^{i\phi_3(t)} \end{pmatrix} \quad (9)$$

The relative phase  $(\phi_1 - \phi_3)/2 = \phi(t)$  applies to the qubit subspace and the phase induced on the auxiliary level can be totally ignored. The relative phase correction needed in Eq. (8) can be achieved by sandwiching it between the two phase gates  $G(\phi = -\pi/4)$ . By this demonstration it is also clear how to perform a phase flip which can be obtained by producing  $\phi = \pi/2$ .

The realization of the controlled operations with double qubits is an essential requirement of any mechanism of quantum computation. It is possible to obtain a CNOT gate in the quantum system we propose. Both three level systems are initially prepared to be in their qubit subspaces and they are connected by a quantum nondemolitional measurement device which reads the first qubit and depending on its state, it induces a static potential  $V_0^{(1)}$  in the second qubit to perform the bit flip. The experimental scheme is shown in Fig.7 which employs two mesoscopic rings, a Hall bar in the full quantum regime and superconducting loop. The flux in the qubit No.1 (which includes the externally applied flux and the flux created by a persistent current) is extracted from the former by a  $-\Phi_0/2$  compensating coil, and further supplied to the Hall bar with a (large) current passing through it. The Hall voltage generated in the bar is designed so that either  $V_0^{(1)}$  or zero voltage is produced corresponding to the fixed value of the current flowing in one or the other direction. The Hall bar is connected to the  $V$  electrodes of qubit No.2. If the voltage is  $V_0^{(1)}$ , the bit flip of the second qubit is realized after time  $t_1$  or if the voltage is zero no change is made. The procedure may in principle be executed in a totally reversible way if the Hall bar operates



in the manifestly quantum regime.

In more detail, assume that the current  $J_Q$  generated by the qubit-1 loop is  $J_Q = J_0$  when the qubit is in the clockwise direction (the  $|0\rangle$  state), and value of the current  $J_Q = -J_0$  when the direction is counterclockwise (the  $|1\rangle$  state). Shifting the current received from the first qubit by an additional  $J_0$  provided by the "minus" flux ring in Fig.7 the final current becomes binary (i.e. 0 or 1) in units of  $J_0$ . The binary current is fed to the Hall bar which is designed to produce a voltage  $V_Q = k * (J_Q + J_0)$ . Applying this one to the qubit No.2 will produce a voltage  $2kJ_0 = V_0^{(1)} = -2$  (in units of  $T$ ) at a proper choice of the instrumental parameter  $k$  (i.e., the magnitude and the sign of the transport current in the bar  $J_0$ ). The Hall voltage is then  $V_0^{(1)}$  when qubit is  $|0\rangle$ , and zero when it is in the state  $|1\rangle$ .

*Physical implementation.* Among other crucial points in the computation, are a reproducible initialization, storing the information until the final readout, the decoherence effects, and an accurate readout which we examine respectively. For the initialization, the magnetic flux is shifted adiabatically from half flux quantum and the system is allowed to relax to the nondegenerate lowest energy state  $|0\rangle$  by spontaneous emission. We either leave the state there or, by applying a Hadamard gate, a Schrödinger Cat state is obtained which is conventionally the initial state in some quantum computing algorithms, in particular Shor's algorithm for factorizing large integers<sup>2</sup>.

Regarding the decoherence, the gate transformation can be the main source for loss of quantum information since the qubit idling, due to a never-decaying property of a persistent current<sup>12</sup>, does not introduce losses and decoherence whereas the gate manipulation, nevertheless being effected with a time independent Hamiltonian (2), is a time dependent process which, when allowed for coupling to the radiative environment, is a source of decoherence. Since our working medium is an electronic field, the main source of dissipative energy loss is the electric dipole radiation with the average intensity (the energy loss per unit time)  $w = 2 \langle |\ddot{\mathbf{d}}|^2 \rangle / 3c^3 \sim e^2 a^2 \omega^4 / c^3$  where  $a$  is typical size of the persistent-current loop and  $\omega$  the characteristic frequency of switching of the order of the hopping amplitude  $\tau/\hbar$ . Hence, the qugate quality factor  $Q \sim \omega T$  where  $T$  is the time of decoherence, turns out to be of

order

$$Q \sim \left(\frac{e^2/a}{\tau}\right)^2 \frac{1}{\alpha^3} \quad (10)$$

where  $\alpha$  is a fine structure constant  $e^2/\hbar c$ . Therefore, for a properly chosen hopping amplitude such that  $\tau \leq e^2/a$ , the qubit can support about  $10^6$  operations within the computational cycle.

For parallel readout in a large scale computation some of the produced data needs to be read in parallel and simultaneously in a number of qubits. This implies that the information in some qubits must be stored until all necessary operations are performed and during this time the qubit subspace should be free of dissipation. The coherence can be maintained by adopting the  $H_1 = 0, H_2 = 0$  case as the idling configuration in the doubly degenerate eigenbasis of  $H_0$ . The degenerate configuration helps the states to maintain relative phase coherence.

In conclusion, we suggested a radiation free mechanism whose physical Hamiltonian allows for coupled qubit/qugate storage and processing of information in a reversible, scalable way with reduced decoherence effects. The system implementation remains to be a future task which may become less demanding due to high degree of flexibility in setup organization regarding in particular the use of multi-loop qubits and quantum mesoscopic effects other than the original Aharonov-Bohm one, including the Berry phase and spin-orbit interaction induced persistent currents.

## FIGURE CAPTIONS

Fig.1:  $\Lambda$ -shaped level configuration of the persistent-current normal-state Aharonov-Bohm qubit. 1,2,3 are the eigenstates of Hamiltonian (1) at  $\alpha = \pi/3$  where 1 and 3 are the computational basis (qubit) registers  $|0\rangle, |1\rangle$ , whereas 2 is the qugate (control) register  $|c\rangle$ . Arrows show transitions between the degenerate states effected by the potential biases applied to the ring sites.

Fig.2: (a)A sketch of magnetically focused lines of magnetic field (arrows) of the superconducting fluxon with flux  $\Phi_1 = hc/2e$  making one half of the normal-metal flux quantum,  $\Phi_0 = hc/e$ , and effecting the ring **R** with three normal islands into a  $\Lambda$ -shaped configuration. The fluxon  $\Phi_1$  is trapped in the opening of superconducting foil (**S**) and further compressed by a ferromagnetic crystal to fit into the interior of the ring. (b)Schematic of the multi-ring qubit arrangement with the sites (circles) on the surface of cylindrical wall **R** surrounding ferromagnetic cylinder (**F**) which focuses lines of magnetic field in a cylindrical tube inside superconductor (**S**).

Fig.3: A sketch of the electric field (shown by arrows) applied to the ring through the potential electrodes (**V**) in direction perpendicular to the direction of magnetic field. **C** is a coupling loop providing the connection to the nondemolition-measuring setup of the persistent current.

Fig.4: Eigenenergies of the ring biased with a potential  $V_0$ . Eigenstates 1 and 3 are degenerate at  $V_0 = 0$  where they form the qubit states. The commensurate situation, marked by arrows, appears at  $K = 1$  and at  $K = 3$  where it allows for the temporal (virtual) transition to a higher level 2 and back thus effecting the bit-flip transition (at  $K = 1$ ) and the Hadamard-like gate (at  $K = 3$ ).

Fig.5: Bit evolution at  $K = 1$ . At point indicated by an arrow ( $t = t_1$ ), the population of control register ( $|c\rangle$ ) vanishes whereas the populations of the computational registers of qubit ( $|0\rangle$ ) and ( $|1\rangle$ ), interchange.

Fig.6: Bit evolution at  $K = 3$ . At point indicated by an arrow ( $t = t_3$ ), the population of control register ( $|c\rangle$ ) vanishes whereas the computational basis of the qubit, originally in a state ( $|1\rangle$ ), equally populates to states  $|0\rangle$  and  $|1\rangle$ .

Fig.7: A sketch of the **CNOT** quantum gate. The ring No.1 which is pierced by a positive- $\Phi_0/2$  flux (marked “+”), after the subtraction of the negative- $\Phi_0/2$  flux (“-”), couples via the loop **C** to a quantum Hall bar (**H**) through which a fixed current (**J**) is fed. The bar generates a Hall voltage output effecting, through the potential electrodes **V**, the flip transition in the ring No.2.

## REFERENCES

- <sup>1</sup> M. A. Nielsen and I. L. Chuang, Quantum Computation and Quantum Information, Cambridge Univ. Press, 2000.
- <sup>2</sup> P. W. Shor, in: Proc. 35th Annual Symp. Th. Comp. Science, p.124. Ed. S. Goldwasser, IEEE Comp. Soc. Press, Los Alamos, 1994.
- <sup>3</sup> L. Grover, Phys. Rev. Lett. **79**, 325 (1997); M. Boyer, G. Brassard, P. Hoyer and A. Tapp, Fortsch. Phys., **46**, 493 (1998).
- <sup>4</sup> S. Lloyd, Science **273**, 1073 (1996).
- <sup>5</sup> D. Bacon, J. Kempe, D.A. Lidar and K.B. Whaley, Phys. Rev. Lett. **85**, 1758 (2000); J. Kempe, D. Bacon, D.A. Lidar and K.B. Whaley, Phys. Rev. **A 6304**, 2307 (2001).
- <sup>6</sup> Almut Beige, Daniel Braun, Ben Tregenna and Peter L. Knight, Phys. Rev. Lett. **85**, 1762 (2000).
- <sup>7</sup> P. Zanardi and M. Rasetti, Phys. Rev. Lett. **79**, 3306 (1997).
- <sup>8</sup> J.J. Cirac and P. Zoller, Phys. Rev. Lett., **74**, 4091 (1995).
- <sup>9</sup> E.M. Fortunato, L. Viola, J. Hodges, G. Teklemariam and D.G. Cory, N. J. Phys. **4**, 5 (2002).
- <sup>10</sup> A. Barone and G. Paterno, Physics and Applications of the Josephson Effect, J.Wiley, New York, 1982.
- <sup>11</sup> Y. Aharonov and D. Bohm, Phys. Rev. **115**, 485 (1959).
- <sup>12</sup> I. O. Kulik, JETP Lett., **11**, 275 (1970); I. O. Kulik, "Non-decaying currents in normal metals", in: Quantum Mesoscopic Phenomena and Mesoscopic Devices in Microelectronics, p.259. I. O. Kulik and R. Ellialtioglu, eds. Kluwer, Dordrecht, 2000.
- <sup>13</sup> M. Buttiker, Y. Imry and R. Landauer. Phys. Lett., **A96**, 365 (1983).

- <sup>14</sup> T. P. Orlando, J. E. Mooij, C. H. van der Wal, L. S. Levitov, S. Lloyd, and J. J. Mazo, Phys. Rev. **60**, 15398 (1999).
- <sup>15</sup> R. Rouse, S. Han, and J. E. Lukens, Phys. Rev. Lett. **75**, 1614 (1995).
- <sup>16</sup> Y. Nakamura, C. D. Chen, and J. S. Tsai, Phys. Rev. Lett. **79**, 2328 (1997).
- <sup>17</sup> P. Silvestrini, V. G. Palmieri, B. Ruggiero, and M. Russo, Phys. Rev. Lett. **79**, 3046 (1997).
- <sup>18</sup> C. Kittel, Introduction to Solid State Physics, J. Wiley, New York, 1996.

FIGURES

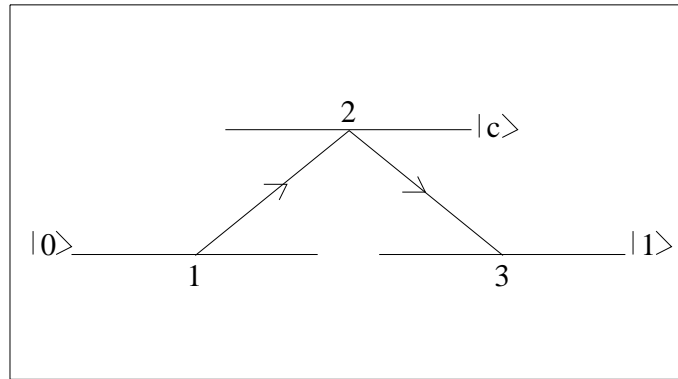

Fig.1

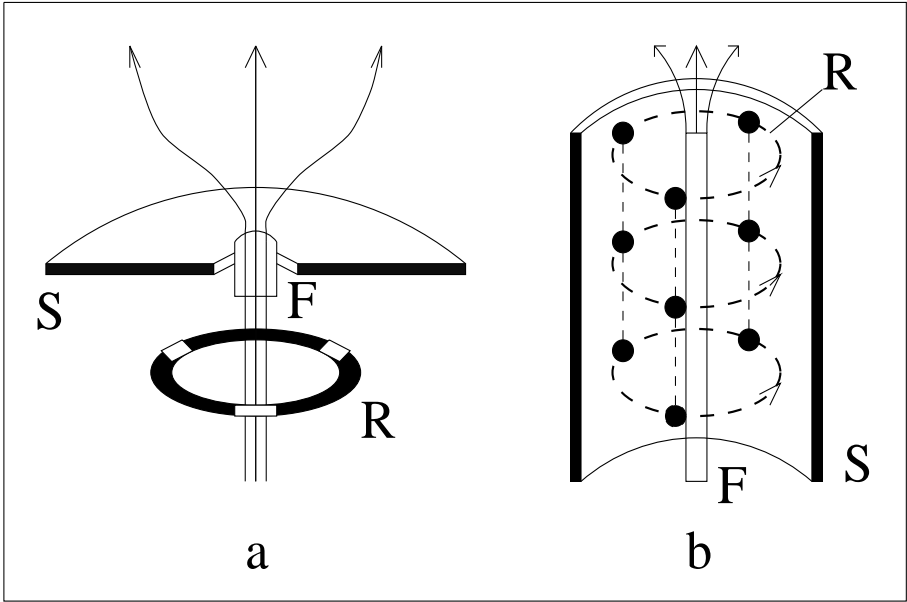

Fig.2



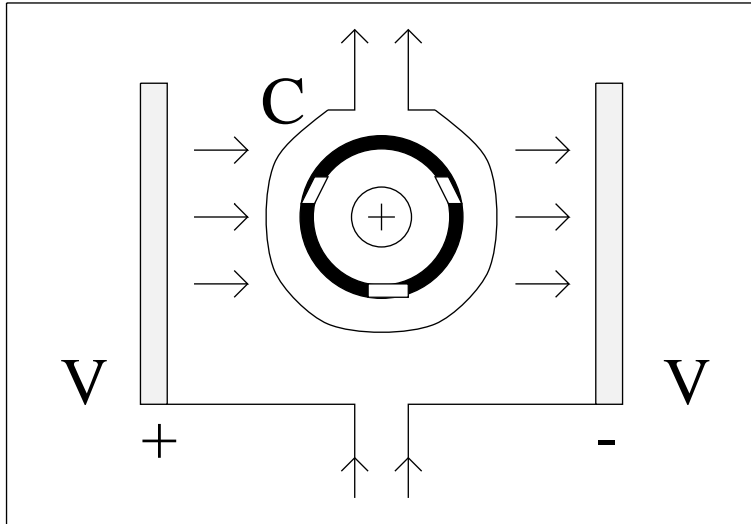

Fig.3

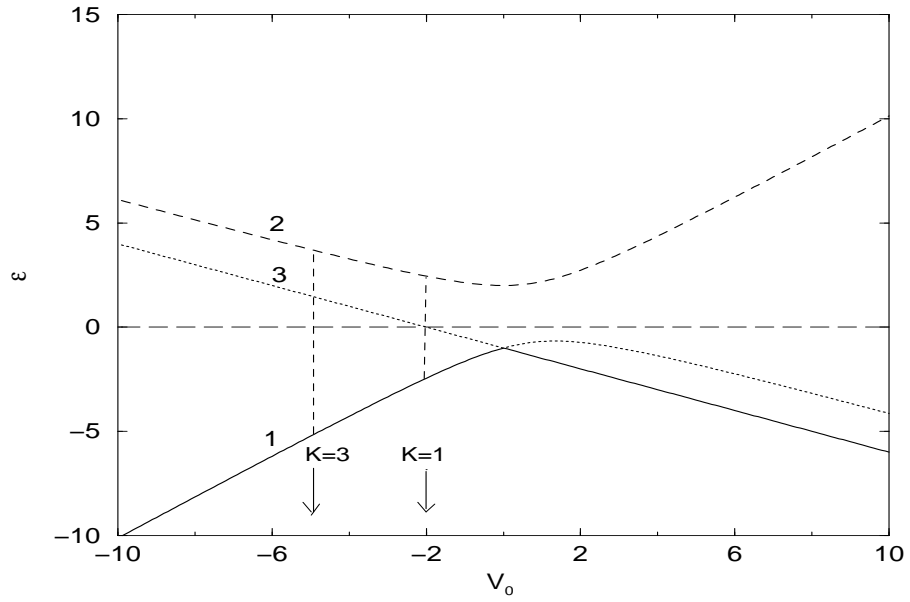

Fig.4

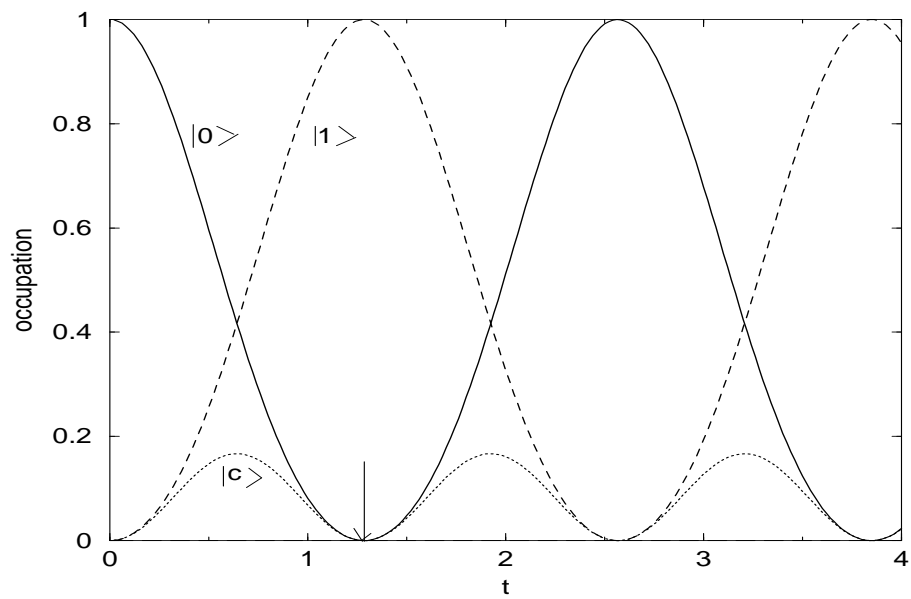

Fig.5

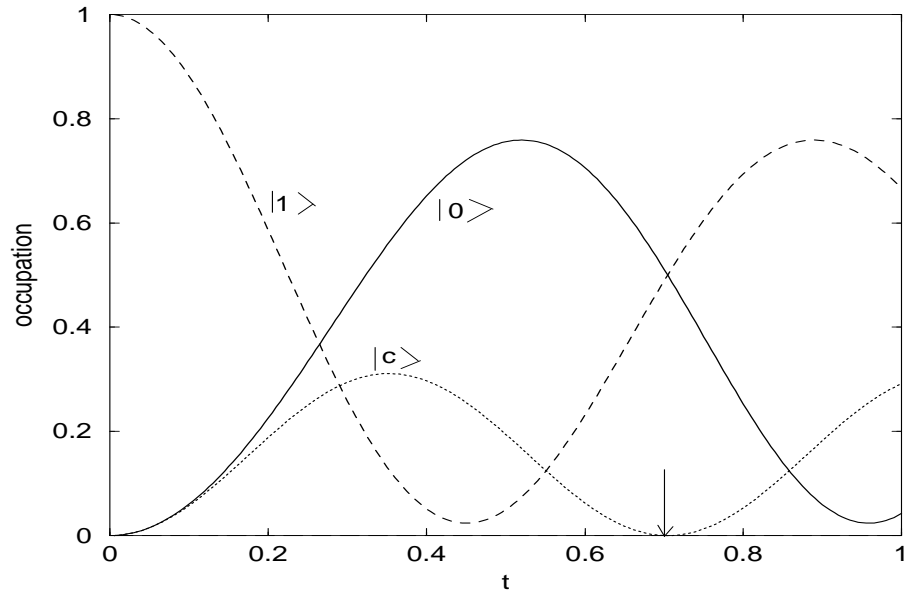

Fig.6

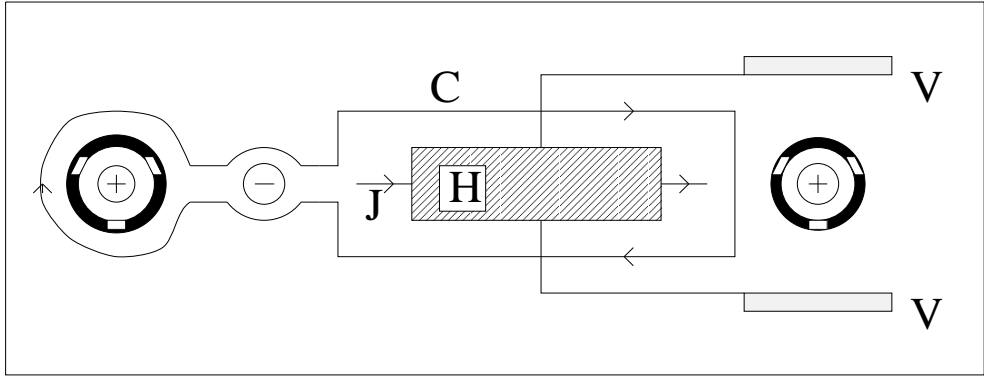

Fig.7