

# Semiclassical theory of quasiparticles in the superconducting state

K.P.Duncan and B.L.Györfy  
H. H. Wills Physics Laboratory,  
University of Bristol,  
Tyndall Avenue,  
Bristol BS8 1TL, UK  
E-mail: kevin.duncan@bris.ac.uk

Version: December 10, 2001

We have developed a semiclassical approach to solving the Bogoliubov - de Gennes equations for superconductors. It is based on the study of classical orbits governed by an effective Hamiltonian corresponding to the quasiparticles in the superconducting state and includes an account of the Bohr-Sommerfeld quantisation rule, the Maslov index, torus quantisation, topological phases arising from lines of phase singularities (vortices), and semiclassical wave functions for multi-dimensional systems. The method is illustrated by studying the problem of an SNS junction and a single vortex.

## 1. INTRODUCTION

A most convenient microscopic theory of superconductivity is provided by the Bogoliubov-de Gennes (BdG) equations [1]. On the one hand it encapsulates all the basic ideas of Bardeen, Cooper and Schrieffer and on the other hand it is the general form of the Kohn-Sham Euler-Lagrange equations of the density functional theory for superconductors. Ever since its formulation semiclassical methods have been used, very successfully, for investigating its solutions under various circumstances [1, 2, 3]. In this paper we wish to contribute to making this method even more effective by developing further the particular approach, based upon effective classical orbits, pioneered by Azbel' [4].

As in the case of the standard Schrödinger equation there are two semiclassical approaches to the problem of solving the BdG equations. The first, initiated by Andreev [2, 3], de Gennes [1], and Bardeen and co workers [5], utilises the WKB form for the wave function and takes advantage of the slowly varying amplitudes to convert the second order equation into one that is first order in the derivatives and hence more readily soluble. However the usual machinations of Schrödinger quantum mechanics e.g. of matching logarithmic derivatives etc. are still employed.

The second approach, initiated by Azbel' [4], uses effective classical Hamiltonians and orbits together with Bohr quantisation conditions to study the quasiparticle energy spectra and the corresponding wave functions. We extend Azbel's approach by including an account of complex order parameters, the origin of the Maslov indices, the construction of a 3-dimensional wave function, and using torus quantisation, that is to say the full machinery of modern semiclassics [6, 7, 8, 9].

The principle motivation behind such systematic development of semiclassical methods for superconductors is the need to adopt this powerful technique to the treatment of Type II superconductors and those with exotic,  $p$ - and  $d$ -wave, pairing. This need arises from the difficulty of solving numerically differential equations, such as the BdG equations, which feature many wildly different length scales, such as lattice parameters,  $a$ , coherence length,  $\xi$ , penetration depth, radii of Landau orbits, and flux lattice unit cell sizes. We hope that the replacement of the numerical problems of integrating differential equations by solving Hamilton's equations for classical orbits can alleviate some of these difficulties.

The layout of this paper is then as follows. In section 2 we present a multicomponent semiclassical theory for the BdG equations. This starts with a discussion of the general form of the semiclassical ansatz before showing how the BdG equations can be reduced, at zeroth order, to the solution of a pair of Hamiltonian systems describing the dynamics of quasiparticles along orbits comprised of both particle-like and hole-like segments. We also include a discussion of topological phases arising from singularities in the phase of pairing potential. We then solve the first order equations and construct the general multicomponent wave function. We briefly discuss torus quantisation and demonstrate that EBK quantisation conditions (a generalisation of Bohr-Sommerfeld quantisation rules) can only be constructed in the absence of the above mentioned singularities. In section 3 we construct an effective semiclassical theory whose Hamiltonian systems are  $\hbar$ -dependent. By extending the semiclassical theory in this way we remove the obstacles to constructing the EBK rules and consequently we present a generalised EBK rule which includes the contribution from both the Maslov index and topological phases. We conclude the section with a discussion of the interpretation of a theory based upon  $\hbar$ -dependent Hamiltonian systems. The remaining parts of the paper are devoted to two applications. Thus in section 4 we apply the theory to a superconductor-normal metal-superconductor junction and include a discussion of Andreev retro-reflection and the semiclassical spectrum. In an accompanying appendix we calculate the Maslov index by analytically continuing the semiclassical wave functions taking into account of Stokes phenomenon. Then in section 5 we investigate a single vortex which is an ideal example for demonstrating the rôle of the  $\hbar$ -dependence in the Hamiltonians and the consequences of the phase singularities in the pairing potential. The paper concludes with a discussion and summary.

## 2. SEMICLASSICAL THEORY FOR SUPERCONDUCTORS

### 2.1. General form for the multicomponent WKB ansatz

To begin, let us recall the conventional semiclassical [2, 3, 1, 5] BCS theory of the superconducting state. The context for the most general version of this is provided by the Bogoliubov-de Gennes equations for the two component wave function for a quasiparticle:

$$\begin{pmatrix} H(\hat{\mathbf{p}}, \mathbf{r}) & |\Delta(\mathbf{r})|e^{i\phi(\mathbf{r})} \\ |\Delta(\mathbf{r})|e^{-i\phi(\mathbf{r})} & -H^*(\hat{\mathbf{p}}, \mathbf{r}) \end{pmatrix} \begin{pmatrix} u_\lambda(\mathbf{r}) \\ v_\lambda(\mathbf{r}) \end{pmatrix} = E_\lambda \begin{pmatrix} u_\lambda(\mathbf{r}) \\ v_\lambda(\mathbf{r}) \end{pmatrix}, \quad (2.1)$$

where

$$H(\hat{\mathbf{p}}, \mathbf{r}) = \frac{1}{2m} (\hat{\mathbf{p}} + e\mathbf{A}(\mathbf{r}))^2 + V(\mathbf{r}) - \epsilon_F, \quad (2.2)$$

$\epsilon_F$  is the Fermi energy,  $V(\mathbf{r})$  is an external potential and  $\Delta(\mathbf{r}) = |\Delta(\mathbf{r})|e^{i\phi(\mathbf{r})}$  is the complex pairing potential satisfying the self-consistency condition

$$\Delta(\mathbf{r}) = g \sum_\lambda u_\lambda(\mathbf{r})v_\lambda^*(\mathbf{r}) (1 - 2f(E_\lambda)). \quad (2.3)$$

(Here  $g$  is the BCS coupling constant and  $f(E_\lambda)$  is the Fermi function.) As usual, the interpretation of the components  $u_\lambda(\mathbf{r})$  and  $v_\lambda(\mathbf{r})$  is that they are the amplitudes for the quasiparticle being a particle and a hole respectively. Moreover, a state is superconducting if the solution of equations (2.1), (2.2), and (2.3) is such that  $\Delta(\mathbf{r}) \neq 0$ .

In what follows, for a prescribed pairing potential  $\Delta(\mathbf{r})$ , we develop a multicomponent WKB approximation for solving equation (2.1). Asymptotically, as  $\hbar \rightarrow 0$ , the order of the multicomponent differential equation changes abruptly, just as for a single component equation, and therefore, we expect the solutions to exhibit the familiar essential singularity in the form of the phase  $e^{iS(\mathbf{r})/\hbar}$ . Thus a reasonable guess at the multicomponent generalisation of the WKB wave function would be

$$\begin{pmatrix} u_\lambda(\mathbf{r}) \\ v_\lambda(\mathbf{r}) \end{pmatrix} = \begin{pmatrix} \tilde{u}_\lambda(\mathbf{r}) \\ \tilde{v}_\lambda(\mathbf{r}) \end{pmatrix} e^{\frac{i}{\hbar}S_0(\mathbf{r})} (1 + \mathcal{O}(\hbar)) \quad (\text{guess}) \quad (2.4)$$

where  $\tilde{u}_\lambda(\mathbf{r})$  and  $\tilde{v}_\lambda(\mathbf{r})$  are slowly varying amplitudes. However, to be systematic, it is more convenient to start with the general complex spinor:

$$\begin{pmatrix} u_\lambda(\mathbf{r}) \\ v_\lambda(\mathbf{r}) \end{pmatrix} = \begin{pmatrix} e^{i(S(\mathbf{r})+\Sigma(\mathbf{r}))} \\ e^{i(S(\mathbf{r})-\Sigma(\mathbf{r}))} \end{pmatrix}, \quad (2.5)$$

where both  $S(\mathbf{r})$  and  $\Sigma(\mathbf{r})$  are complex quantities to allow for the amplitude and phase variation of each of the components. To proceed we expand them in powers of  $\hbar$  by writing  $S$  and  $\Sigma$  as

$$S(\mathbf{r}) = \frac{S_0(\mathbf{r})}{\hbar} + S_1(\mathbf{r}) + \hbar S_2(\mathbf{r}) + \dots, \quad (2.6)$$

and

$$\Sigma(\mathbf{r}) = \frac{\Sigma_0(\mathbf{r})}{\hbar} + \Sigma_1(\mathbf{r}) + \hbar\Sigma_2(\mathbf{r}) + \dots. \quad (2.7)$$

In keeping with the original definition of  $S$  and  $\Sigma$  as complex quantities, at every order the real ( $r$ ) and imaginary ( $i$ ) parts of  $S_j$  and  $\Sigma_j$  must be determined. Up to and including the first order in  $\hbar$  the spinor in equation (2.5) then contains the following quantities

$$\begin{pmatrix} u_\lambda(\mathbf{r}) \\ v_\lambda(\mathbf{r}) \end{pmatrix} = \begin{pmatrix} e^{i(\Sigma_0^r(\mathbf{r})/\hbar + \Sigma_1^r(\mathbf{r}))} e^{-\Sigma_1^i(\mathbf{r})} \\ e^{-i(\Sigma_0^r(\mathbf{r})/\hbar + \Sigma_1^r(\mathbf{r}))} e^{+\Sigma_1^i(\mathbf{r})} \end{pmatrix} e^{iS_0^r(\mathbf{r})/\hbar + iS_1^r(\mathbf{r})} e^{-S_1^i(\mathbf{r})}. \quad (2.8)$$

The question of whether to include  $\Sigma_0^r$  (i.e. a fast degree of freedom for the spinor components) is a subtle one. If  $\phi(\mathbf{r})$  is not expanded in  $\hbar$  (and it is usual in semiclassical theory to regard potentials such as  $V(\mathbf{r})$  and  $\Delta(\mathbf{r})$  as externally imposed potentials - hence not to expand them) then it is found that the BdG equations have no expansion in  $\hbar$  if  $\Sigma_0^r(\mathbf{r}) \neq 0$ . We will return to this point again once we have developed our formalism.

Setting  $\Sigma_0^r(\mathbf{r}) = 0$  in (2.8) we see the wave function does indeed take the form (2.4) where however  $\begin{pmatrix} \tilde{u}_\lambda(\mathbf{r}) \\ \tilde{v}_\lambda(\mathbf{r}) \end{pmatrix}$  is understood to be the *complex* slowly varying spinor:

$$\begin{pmatrix} \tilde{u}_\lambda(\mathbf{r}) \\ \tilde{v}_\lambda(\mathbf{r}) \end{pmatrix} = \begin{pmatrix} u_{0,\lambda}(\mathbf{r}) e^{i\Sigma_1^r(\mathbf{r})} \\ v_{0,\lambda}(\mathbf{r}) e^{-i\Sigma_1^r(\mathbf{r})} \end{pmatrix} e^{iS_1^r(\mathbf{r})} e^{-S_1^i(\mathbf{r})}, \quad (2.9)$$

where  $u_{0,\lambda}(\mathbf{r})$ ,  $v_{0,\lambda}(\mathbf{r})$ , and  $e^{-S_1^i(\mathbf{r})}$  are amplitudes, and  $S_0^r(\mathbf{r})$ ,  $S_1^r(\mathbf{r})$  and  $\Sigma_1^r(\mathbf{r})$  are phases, to be determined by solving the appropriate zeroth order and first order equations obtained by substituting (2.9) into the BdG equations and expanding the result in powers of  $\hbar$ .

## 2.2. Semiclassical solution of the BdG equations to zeroth order

Noting that  $e^{iS_0(\mathbf{r})/\hbar}$  may be regarded as a unitary operator<sup>1</sup> we may write, in the position representation,

$$e^{-iS_0(\mathbf{r})/\hbar} \hat{\mathbf{p}} e^{iS_0(\mathbf{r})/\hbar} = \hat{\mathbf{p}} + \frac{\partial S_0}{\partial \mathbf{r}}. \quad (2.10)$$

Applying this procedure to both sides of equation (2.1) one readily finds

$$\begin{pmatrix} H(\hat{\mathbf{p}} + \frac{\partial S_0}{\partial \mathbf{r}}, \mathbf{r}) & |\Delta(\mathbf{r})| e^{i\phi(\mathbf{r})} \\ |\Delta(\mathbf{r})| e^{-i\phi(\mathbf{r})} & -H^*(\hat{\mathbf{p}} + \frac{\partial S_0}{\partial \mathbf{r}}, \mathbf{r}) \end{pmatrix} \begin{pmatrix} \tilde{u}_\lambda(\mathbf{r}) \\ \tilde{v}_\lambda(\mathbf{r}) \end{pmatrix} = E_\lambda \begin{pmatrix} \tilde{u}_\lambda(\mathbf{r}) \\ \tilde{v}_\lambda(\mathbf{r}) \end{pmatrix} \quad (2.11)$$

<sup>1</sup>Since we will not need the  $r$  suffix on  $S_0^r(\mathbf{r})$  for what follows we drop it from here onwards.

Then, the zeroth order approximation in  $\hbar$  is obtained by neglecting terms containing  $\hbar$  (i.e.,  $\hat{\mathbf{p}} = -i\hbar\nabla$ , whose action upon  $\tilde{u}_\lambda(\mathbf{r})$ ,  $\tilde{v}_\lambda(\mathbf{r})$  is small). Then we observe that  $\phi(\mathbf{r})$  can be removed from the above equation at each  $\mathbf{r}$ -point by a unitary transformation

$$U_\phi(\mathbf{r}) = \begin{pmatrix} e^{-i\phi(\mathbf{r})/2} & 0 \\ 0 & e^{i\phi(\mathbf{r})/2} \end{pmatrix}. \quad (2.12)$$

To zeroth order in  $\hbar$  such transformations of equation (2.11) yield

$$\begin{pmatrix} E_\lambda - H_0^e(\mathbf{p}_0, \mathbf{r}) & -|\Delta(\mathbf{r})| \\ -|\Delta(\mathbf{r})| & E_\lambda + H_0^h(\mathbf{p}_0, \mathbf{r}) \end{pmatrix} \begin{pmatrix} \tilde{u}_\lambda(\mathbf{r})e^{-i\phi(\mathbf{r})/2} \\ \tilde{v}_\lambda(\mathbf{r})e^{+i\phi(\mathbf{r})/2} \end{pmatrix} = 0. \quad (2.13)$$

Here  $H_0^e(\mathbf{p}_0, \mathbf{r})$  is an electron hamiltonian of the form (2.2) with the momentum operator  $\hat{\mathbf{p}}$  replaced by  $\mathbf{p}_0 = \frac{\partial S_0}{\partial \mathbf{r}}$ , and the same is true for the hole Hamiltonian,  $H_0^h(\mathbf{p}_0, \mathbf{r})$ , except  $e \rightarrow -e$ . Since the transformed Hamiltonian matrix in equation (2.13) is real, the spinor wave function is also constrained. Most generally, via equation (2.9), this implies that

$$\Sigma_1^r(\mathbf{r}) - \frac{\phi(\mathbf{r})}{2} = n\frac{\pi}{2}, \quad (2.14)$$

for  $n$  an integer. However self-consistency, equation (2.3), requires that the  $\Delta(\mathbf{r})$  with which we started our calculation, i.e.  $\Delta(\mathbf{r}) = |\Delta(\mathbf{r})| e^{i\phi(\mathbf{r})}$ , and the  $\Delta(\mathbf{r})$  constructed from our solutions  $u_\lambda(\mathbf{r})$  and  $v_\lambda(\mathbf{r})$  be one and the same. Since  $u_\lambda(\mathbf{r})v_\lambda^*(\mathbf{r}) \propto e^{i\phi(\mathbf{r})+in\pi}$ , we must have  $n = 2m$ ,  $m$  an integer, for this to be true. Thus we find

$$\Sigma_1^r(\mathbf{r}) - \frac{\phi(\mathbf{r})}{2} = m\pi. \quad (2.15)$$

But now, since  $m$  introduces the same sign change for both upper and lower components of the spinor it can be factored out. Choosing the sign of the wave function appropriately  $m$  is eliminated and we have determined  $\Sigma_1^r(\mathbf{r})$ .

In the context of a general solution of the BdG equations it has been observed that if the order parameter,  $\Delta(\mathbf{r})$ , contains vortices,  $\nabla\phi(\mathbf{r})$  acquires *global* curvature [10] i.e

$$\oint_c \nabla\phi(\mathbf{r}) \cdot d\mathbf{r} \neq 0, \quad (2.16)$$

for paths,  $c$ , containing vortices. To clarify the nature of the singularity associated with a vortex in three dimensions observe that it is one where  $|\Delta(\mathbf{r})| = 0$  along lines.  $\phi(\mathbf{r})$  is then indeterminate i.e.  $|\Delta(\mathbf{r})| = 0$  defines a line of phase singularities [11]. If we continue  $\phi(\mathbf{r})$  along any path enclosing such a singularity we obtain (2.16) with  $2\pi$  on the right hand side. A unitary transformation of the form  $U_\phi$  is then *multivalued*, as stressed by

Anderson [12]. For instance  $U_\phi$  has two branches and moves from one to the other when continued around a vortex. The same is true for our spinor: if upon the first branch it takes the values

$$\begin{pmatrix} \tilde{u}_\lambda(\mathbf{r}) \\ \tilde{v}_\lambda(\mathbf{r}) \end{pmatrix},$$

then, after a circuit around a vortex, it moves onto the second branch, taking the values

$$-\begin{pmatrix} \tilde{u}_\lambda(\mathbf{r}) \\ \tilde{v}_\lambda(\mathbf{r}) \end{pmatrix}.$$

(A second trip around the vortex is required to return the spinor to the original branch.) Thus, through (2.15), we have discovered that  $\Sigma_1^r(\mathbf{r})$  may contain a contribution topological in origin<sup>2</sup>. This is, however, not a problem for our semiclassical theory. With  $\phi(\mathbf{r})$  removed we must diagonalise the resulting matrix subject to the physical condition that the original wave function in (2.4) is single-valued. As we shall see presently, this constraint will modify the generalised Bohr-Sommerfeld quantisation rule which we will derive.

A non-trivial solution to (2.13) requires the vanishing of the determinant. This yields two equations:

$$E_\lambda^\alpha = E_0^\alpha(\mathbf{p}_0, \mathbf{r}), \quad (2.17)$$

where  $\alpha = \pm$ , and

$$E_0^\alpha(\mathbf{p}_0, \mathbf{r}) = \mathbf{p}_0 \cdot \mathbf{v}_0(\mathbf{r}) + \alpha \sqrt{\left(\frac{p_0^2}{2m} + \frac{1}{2}mv_0^2(\mathbf{r}) + V(\mathbf{r}) - \epsilon_F\right)^2 + |\Delta(\mathbf{r})|^2}, \quad (2.18)$$

where  $\mathbf{v}_0 = e\mathbf{A}(\mathbf{r})/m$ . The constancy of  $E_0^\alpha(\mathbf{p}_0, \mathbf{r})$  defines, implicitly, the functions  $\mathbf{p}_0^\alpha(\mathbf{r}) = \frac{\partial S_0^\alpha}{\partial \mathbf{r}}$ .

We see immediately that each of the equations (2.17) is a (stationary) *Hamilton-Jacobi equation* for a (fictitious) classical mechanics. Its solution (when it exists) is a classical action function  $S_0^\alpha(\mathbf{r}, \mathbf{I})$ , where  $I_1, \dots, I_n$  is a set of action integrals and appears in place of  $\lambda$  which labelled the eigenvalues of the BdG equation.

Thus viewing each  $E_0^\alpha(\mathbf{p}_0, \mathbf{r})$  as a classical Hamiltonian governing the propagation of a quasiparticle excitation the restriction to a constant energy shell in phase space ( $E_{\mathbf{I}}^\alpha = E_0^\alpha(\mathbf{p}_0, \mathbf{r})$ ) define the phase space orbits which we shall label  $(\mathbf{p}_0(\mathbf{r}, \mathbf{I}), \mathbf{r})$ . In general the functions  $\mathbf{p}_0^\alpha(\mathbf{r}, \mathbf{I})$  are many-valued functions of  $\mathbf{r}$  as illustrated in FIG. 1, whose branches shall be indexed by  $j$  when necessary. Mathematically [13] finding a complete

<sup>2</sup>It is the singular part of  $\phi(\mathbf{r})$  which has been called [10] a ‘‘Berry’’ phase although it is in fact simpler depending only upon the topology not the geometry of the path along which it is continued.

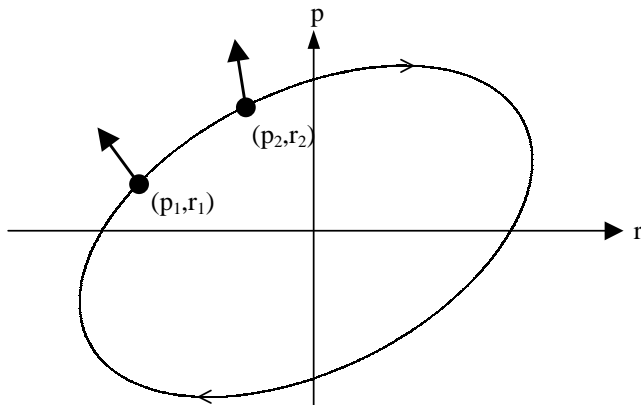

**FIG. 1** Phase space orbits  $(\mathbf{p}_0(\mathbf{r}, \mathbf{I}), \mathbf{r})$  defined implicitly by  $E_{\mathbf{I}}^\alpha = E_0^\alpha(\mathbf{p}_0, \mathbf{r})$ . The vector attached to the orbit changes orientation as the spinor is carried along the trajectory. Notice that  $\mathbf{p}_0^\alpha(\mathbf{r}, \mathbf{I})$  is a many-valued function of  $\mathbf{r}$ .

integral to the Hamilton-Jacobi equation is equivalent to solving Hamilton's equations of motion. So we can write down Hamilton's equations for the quasiparticle excitation:

$$\dot{\mathbf{r}}^\alpha = \left( \frac{\partial E_0^\alpha(\mathbf{p}, \mathbf{r})}{\partial \mathbf{p}} \right), \quad \dot{\mathbf{p}}^\alpha = - \left( \frac{\partial E_0^\alpha(\mathbf{p}, \mathbf{r})}{\partial \mathbf{r}} \right), \quad (2.19)$$

where after differentiation we must substitute  $\mathbf{r} = \mathbf{r}^\alpha(t)$  and  $\mathbf{p} = \mathbf{p}_0^\alpha(\mathbf{r}^\alpha(t))$ . Since our Hamiltonian is conservative, time here is simply a parameter governing the evolution of a quasiparticle along the orbit. Thus the  $2 \times 2$  differential matrix BdG equation (2.1) has been reduced, at zeroth order, to a pair of Hamiltonian systems for a (fictitious) classical mechanics specified by the appropriate Hamiltonian in (2.18).

A solution to (2.17) is obtained as

$$S_0^{\alpha,j}(\mathbf{r}, \mathbf{I}) = \int_{\mathbf{r}_0(t_0)}^{\mathbf{r}(t)} \mathbf{p}_0^{\alpha,j}(\mathbf{r}, \mathbf{I}) \cdot d\mathbf{r}, \quad (2.20)$$

where integration is carried out along a ray of one of the Hamiltonian systems (2.19). (For convenience we have chosen the initial condition  $S_0^{\alpha,j}(\mathbf{r}_0, \mathbf{I}) = 0$ .) This does not complete the zeroth order theory however, since our 'particle' has an internal structure which is represented by the complex spinor defined at every point along the trajectory.

So let us now consider the spinor solution of the BdG equation corresponding to one of these 'classical' orbits. It is useful to view the slowly

changing quasiparticle spinor of (2.13) as an axis of pseudo spin quantisation transported along the trajectory defined by  $\mathbf{p}_0^\alpha(\mathbf{r}, \mathbf{I})$ . Clearly, this axis can be represented by a vector attached to the orbit (FIG. 1) whose orientation changes as it is carried along the path in phase space. This vector represents the internal particle-hole degree of freedom of the excitation. To find how the eigenvectors of (2.13) change as they are carried along the trajectory we diagonalise the Hamiltonian matrix,  $H(\mathbf{r})$ , at every  $\mathbf{r}$ -point

$$U(\mathbf{r})H(\mathbf{r})U^\dagger(\mathbf{r}) = \begin{pmatrix} E_0^+(\mathbf{p}_0, \mathbf{r}) & 0 \\ 0 & E_0^-(\mathbf{p}_0, \mathbf{r}) \end{pmatrix}, \quad (2.21)$$

so that in the locally diagonal frame (2.13) becomes

$$\begin{pmatrix} E_0^+(\mathbf{p}_0, \mathbf{r}) & 0 \\ 0 & E_0^-(\mathbf{p}_0, \mathbf{r}) \end{pmatrix} \begin{pmatrix} u^{\text{diag}} \\ v^{\text{diag}} \end{pmatrix} = E_{\mathbf{I}} \begin{pmatrix} u^{\text{diag}} \\ v^{\text{diag}} \end{pmatrix},$$

giving

$$E_{\mathbf{I}}^+ = E_0^+(\mathbf{p}_0, \mathbf{r}), \quad \begin{pmatrix} u^{\text{diag},+} \\ v^{\text{diag},+} \end{pmatrix} = \begin{pmatrix} 1 \\ 0 \end{pmatrix}, \quad (2.22)$$

$$E_{\mathbf{I}}^- = E_0^-(\mathbf{p}_0, \mathbf{r}), \quad \begin{pmatrix} u^{\text{diag},-} \\ v^{\text{diag},-} \end{pmatrix} = \begin{pmatrix} 0 \\ 1 \end{pmatrix}. \quad (2.23)$$

Rotating back to the common laboratory frame we have two solutions

$$E_{\mathbf{I}}^+ = E_0^+(\mathbf{p}_0, \mathbf{r}), \quad \begin{pmatrix} u_{0,\mathbf{I}}^+(\mathbf{r}) \\ v_{0,\mathbf{I}}^+(\mathbf{r}) \end{pmatrix} = U^\dagger(\mathbf{r}) \begin{pmatrix} 1 \\ 0 \end{pmatrix},$$

$$E_{\mathbf{I}}^- = E_0^-(\mathbf{p}_0, \mathbf{r}), \quad \begin{pmatrix} u_{0,\mathbf{I}}^-(\mathbf{r}) \\ v_{0,\mathbf{I}}^-(\mathbf{r}) \end{pmatrix} = U^\dagger(\mathbf{r}) \begin{pmatrix} 0 \\ 1 \end{pmatrix}.$$

Note that while  $\begin{pmatrix} u_{0,\mathbf{I}}^+(\mathbf{r}) \\ v_{0,\mathbf{I}}^+(\mathbf{r}) \end{pmatrix}$  is a particle in its local frame, (2.22), it is both particle and hole, with amplitudes  $u_{0,\mathbf{I}}^+(\mathbf{r})$  and  $v_{0,\mathbf{I}}^+(\mathbf{r})$ , in the laboratory frame.

If we now substitute  $E_0^\alpha$  into (2.13) we have the ratio

$$\frac{v_{0,\mathbf{I}}^\alpha(\mathbf{r})}{u_{0,\mathbf{I}}^\alpha(\mathbf{r})} = \frac{E_0^\alpha - H_0^e(\mathbf{p}_0, \mathbf{r})}{-|\Delta(\mathbf{r})|}. \quad (2.24)$$

The electron Hamiltonian,  $H_0^e(\mathbf{p}, \mathbf{r})$  is

$$H_0^e(\mathbf{p}_0, \mathbf{r}) = \mathbf{p}_0 \cdot \mathbf{v}_0 + \frac{\mathbf{p}_0^2}{2m} + \frac{1}{2}m\mathbf{v}_0^2 + V(\mathbf{r}) - \epsilon_F,$$

$$= \mathbf{p}_0 \cdot \mathbf{v}_0 + \beta \sqrt{(E_0^\alpha(\mathbf{p}_0, \mathbf{r}) - \mathbf{p}_0 \cdot \mathbf{v}_0)^2 - |\Delta(\mathbf{r})|^2}, \quad (2.25)$$

by (2.18), where  $\beta = \pm$ , and the Hamilton-Jacobi equation  $E_{\mathbf{I}}^\alpha = E_0^\alpha(\mathbf{p}_0, \mathbf{r})$  should be used. Using this to eliminate  $H_0^e(\mathbf{p}, \mathbf{r})$  from (2.24) the amplitudes



are expressed in terms of  $E_0^\alpha$  and the momentum branches,  $\mathbf{p}_0^j(\mathbf{r})$ . It is clear from equation (2.25) that each  $\mathbf{p}_0^j$  determines a unique choice of  $\beta$  (see also Appendix A) so that there is one pair of amplitudes for each branch of the momentum. Then the normalised amplitudes are given by

$$\begin{aligned} u_{0,\mathbf{I}}^{\alpha,j}(\mathbf{r}) &= \sqrt{\frac{1}{2} \left( 1 + \beta \frac{\sqrt{(E_{\mathbf{I}}^\alpha - \mathbf{p}_0^j \cdot \mathbf{v}_0)^2 - |\Delta(\mathbf{r})|^2}}{E_{\mathbf{I}}^\alpha - \mathbf{p}_0^j \cdot \mathbf{v}_0} \right)}, \\ v_{0,\mathbf{I}}^{\alpha,j}(\mathbf{r}) &= \sqrt{\frac{1}{2} \left( 1 - \beta \frac{\sqrt{(E_{\mathbf{I}}^\alpha - \mathbf{p}_0^j \cdot \mathbf{v}_0)^2 - |\Delta(\mathbf{r})|^2}}{E_{\mathbf{I}}^\alpha - \mathbf{p}_0^j \cdot \mathbf{v}_0} \right)}. \end{aligned} \quad (2.26)$$

(By normalising we have of course redefined  $e^{-S_1^i(\mathbf{r},\mathbf{I})}$  but since we are yet to determine this amplitude we shall not introduce new notation for it.) This completes the zeroth order theory.

To summarise our results so far we have shown that a general semiclassical solution for a multicomponent system can be written as a spinor multiplying the familiar phase,  $e^{iS_0/\hbar}$  (2.4), where however the spinor is in general a complex quantity (2.9). Using this solution we derived the zeroth order matrix equation (2.13) and determined one of the spinor phases,  $\Sigma_1^r$ , which may have a topological contribution. We then diagonalised the matrix equations reducing the solution of the BdG equations at zeroth order to the problem of solving a pair of Hamiltonian systems for our excitation specified by the classical Hamiltonians  $E_0^\alpha(\mathbf{p}_0, \mathbf{r})$ . Our excitation has an internal structure which, at zeroth order, is represented by the amplitudes (2.26).

What is the next step? We expect, to first order in  $\hbar$ , to find a transport equation whose solution furnishes us with the amplitude  $A(\mathbf{r}) = e^{-S_1^i(\mathbf{r},\mathbf{I})}$ . We also have the phase  $S_1^r(\mathbf{r},\mathbf{I})$  to determine which, like  $\Sigma_1^r(\mathbf{r})$ , is not familiar from single-component WKB analysis. Once we have determined these quantities our semiclassical wave function will be used to construct the rule which quantises our classical dynamics.

### 2.3. The transport equation and other first order quantities

To derive the first order equations we take the expectation value of equation (2.11) and expand the result in powers of  $\hbar$ . One can then show (see Appendix B) that there are two equations to first order in  $\hbar$ :

$$\mathcal{O}(\hbar) \quad \nabla \cdot \left\{ \begin{pmatrix} \tilde{u}_{\mathbf{I}}^* & \tilde{v}_{\mathbf{I}}^* \end{pmatrix} \begin{pmatrix} -\frac{\mathbf{P}_{\mathbf{I}}^+}{2m} \tilde{u}_{\mathbf{I}} \\ +\frac{\mathbf{P}_{\mathbf{I}}^-}{2m} \tilde{v}_{\mathbf{I}} \end{pmatrix} \right\} = 0, \quad (2.27)$$

$$\mathcal{O}(\hbar) \quad 2 \operatorname{Im} \left( \begin{pmatrix} \tilde{u}_{\mathbf{I}}^* & \tilde{v}_{\mathbf{I}}^* \end{pmatrix} \begin{pmatrix} -\frac{\mathbf{P}_{\mathbf{I}}^+}{2m} \cdot \nabla \tilde{u}_{\mathbf{I}} \\ +\frac{\mathbf{P}_{\mathbf{I}}^-}{2m} \cdot \nabla \tilde{v}_{\mathbf{I}} \end{pmatrix} \right) = 0, \quad (2.28)$$

where  $\mathbf{P}^\pm = \mathbf{p}_0(\mathbf{r}) \pm e\mathbf{A}(\mathbf{r})$ . The first of these equations, (2.27), is the transport equation and can be rewritten (see Appendix B) as

$$\nabla \cdot \left( e^{-2S_1^i(\mathbf{r}, \mathbf{I})} \frac{\partial E_0^\alpha(\mathbf{p}, \mathbf{r})}{\partial \mathbf{p}} \Big|_{\mathbf{p}=\mathbf{p}_0^\alpha(\mathbf{r}, \mathbf{I})} \right) = 0. \quad (2.29)$$

It expresses the fact that the product (amplitude)<sup>2</sup> × velocity, at each point, must be conserved (there are no sources or sinks). Thus if the local velocity of a quasiparticle increases the probability of finding it there decreases, and vice versa. Solving equation (2.29) by the van Vleck [14] method gives

$$e^{-S_1^i(\mathbf{r}, \mathbf{I})} = c \left| \det \frac{\partial^2 S_0^{\alpha, j}(\mathbf{r}, \mathbf{I})}{\partial \mathbf{r} \partial \mathbf{I}} \right|^{1/2}, \quad (2.30)$$

where  $c$  is a constant.

The second equation is more troublesome. It resembles the connection enforcing parallel transport in Berry's theory of geometric phases [15, 16]. However, equation (2.28) cannot be solved to yield a geometric phase. Rather we find (see Appendix B)

$$S_1^r(\mathbf{r}) = -\frac{1}{e} \int_{t_0}^t \mathbf{j}^{\alpha, j}(\mathbf{r}) \cdot \frac{\nabla \phi(\mathbf{r})}{2} dt', \quad (2.31)$$

where

$$-\frac{1}{e} \mathbf{j}^{\alpha, j}(\mathbf{r}) = \frac{\mathbf{p}_0^{\alpha, j}(\mathbf{r})}{m} + \left( (u_{0, \mathbf{I}}^{\alpha, j}(\mathbf{r}))^2 - (v_{0, \mathbf{I}}^{\alpha, j}(\mathbf{r}))^2 \right) \frac{e\mathbf{A}(\mathbf{r})}{m}.$$

Equation (2.31) is not a line integral. A physical interpretation to  $S_1^r(\mathbf{r})$  is given in Appendix B. We should not be surprised that our theory contains both a topological phase and another phase which cannot be expressed either geometrically or topologically. In a different context, it is known [17, 18, 19] that the asymptotics solutions of matrix differential equations can contain such terms.

Bringing all our results together, the multicomponent semiclassical wave functions for the Bogoliubov-de Gennes equations with action  $S_0^{\alpha, j}(\mathbf{r}, \mathbf{I})$  take the form

$$\begin{aligned} \begin{pmatrix} u_{\mathbf{I}}^\alpha(\mathbf{r}) \\ v_{\mathbf{I}}^\alpha(\mathbf{r}) \end{pmatrix} &= A_j^\alpha \left| \det \frac{\partial^2 S_0^{\alpha, j}(\mathbf{r}, \mathbf{I})}{\partial \mathbf{r} \partial \mathbf{I}} \right|^{1/2} \begin{pmatrix} u_{0, \mathbf{I}}^{\alpha, j}(\mathbf{r}) e^{+i\phi(\mathbf{r})/2} \\ v_{0, \mathbf{I}}^{\alpha, j}(\mathbf{r}) e^{-i\phi(\mathbf{r})/2} \end{pmatrix} \times \\ &\times \exp \left( i\hbar^{-1} S_0^{\alpha, j}(\mathbf{r}, \mathbf{I}) + iS_1^{\alpha, j}(\mathbf{r}, \mathbf{I}) \right), \quad (2.32) \end{aligned}$$

where  $A_j^\alpha$  is a constant.

## 2.4. Torus quantisation

To construct a quantisation rule we must consider the behaviour of (2.32) along rays of the Hamiltonian system (2.19). Thus we must first discuss the properties of the underlying classical dynamics.

It is well known [20] that for a classical mechanics with  $N$  degrees of freedom to be integrable there must be  $N$  constants of the motion. For such a system the dynamics takes place on an  $N$ -dimensional (Lagrangian) submanifold in phase space, which has the topology of an  $N$ -torus [13]. To perform a canonical transformation from old coordinates  $(\mathbf{p}, \mathbf{r})$  to new coordinates  $(\mathbf{I}, \boldsymbol{\varphi})$ , where  $\boldsymbol{\varphi}$  are angle coordinates on the torus, one constructs the action function,  $S(\mathbf{r}, \mathbf{I})$ , which is a solution of the Hamilton-Jacobi equation for the given classical mechanics. Then the transformation is specified by

$$\mathbf{p} = \frac{\partial S(\mathbf{r}, \mathbf{I})}{\partial \mathbf{r}}, \quad \boldsymbol{\varphi} = \frac{\partial S(\mathbf{r}, \mathbf{I})}{\partial \mathbf{I}}.$$

The action variables,  $\mathbf{I}$ , which are constants of the motion, are given by

$$I_l = \frac{1}{2\pi} \oint_{\Gamma_l} \mathbf{p} \cdot d\mathbf{r}, \quad (2.33)$$

where  $\Gamma_l$  is the  $l$ th irreducible loop on the  $N$ -torus. The energy can then be expressed solely in terms of these constants,  $E = E(\mathbf{I})$ , and Hamilton's equations of motion can then be integrated explicitly.

It is also well known [6, 7] that the semiclassical approximation to the spectrum of the Schrödinger equation with a Hamiltonian whose classical dynamics is integrable, proceeds via the semiclassical wave function (whose multicomponent generalisation we have given as (2.32)). The single-valuedness of this wave function when followed around each of the irreducible loops upon the torus yields the  $N$  quantisation conditions

$$\oint_{\Gamma_l} \mathbf{p} \cdot d\mathbf{r} = 2\pi I_l = 2\pi\hbar \left( n_l + \frac{m_l}{4} \right), \quad (2.34)$$

where  $n_l$  and  $m_l$  are integers.  $m_l$  is the Maslov index [9], and accounts for a change of  $\pi/2$  in the phase of the wave function each time a caustic is crossed. The Maslov index of a closed curve is defined to be the number of times  $\partial r/\partial p$  changes sign from negative to positive, minus the number of times  $\partial r/\partial p$  changes sign from positive to negative. It is a topological invariant of a Lagrangian torus.

The quantisation conditions (2.34) are the so called Einstein-Brillouin-Keller (EBK) quantisation rules, the generalisation of the Bohr-Sommerfeld quantisation rules of 'old' quantum mechanics to encompass non-separable problems.

What we require is the multicomponent generalisation of the EBK rules. Since the multicomponent theory was reduced to two Hamiltonian systems

one might think that the EBK rules apply to the tori for each Hamiltonian system. We start by writing the most general semiclassical wave function, which due to the multivaluedness of  $\mathbf{p}_0^j(\mathbf{r})$  is given by the superposition principle of quantum mechanics as

$$\begin{pmatrix} u_{\mathbf{I}}^\alpha(\mathbf{r}) \\ v_{\mathbf{I}}^\alpha(\mathbf{r}) \end{pmatrix} = \sum_j A_j^\alpha \left| \det \frac{\partial^2 S_0^{\alpha,j}(\mathbf{r}, \mathbf{I})}{\partial \mathbf{r} \partial \mathbf{I}} \right|^{1/2} \begin{pmatrix} u_{0,\mathbf{I}}^{\alpha,j}(\mathbf{r}) e^{+i\phi(\mathbf{r})/2} \\ v_{0,\mathbf{I}}^{\alpha,j}(\mathbf{r}) e^{-i\phi(\mathbf{r})/2} \end{pmatrix} \times \\ \times \exp \left( i\hbar^{-1} S_0^{\alpha,j}(\mathbf{r}, \mathbf{I}) + iS_1^{\alpha,j}(\mathbf{r}, \mathbf{I}) + im\pi/2 \right), \quad (2.35)$$

where  $j$  runs over all the branches,  $S_0^{\alpha,j}$ , which together make up the torus. Firstly consider a situation where  $S_1^{\alpha,j} = 0$ . Such a situation occurs when  $\nabla\phi = 0$ . Then it is clear that single-valuedness of this wave function does yields a quantisation condition of the form (2.34). Now generalise to the case where  $\nabla\phi(\mathbf{r})$  has global curvature. Then the contribution to the change of phase around a closed path arising from the topologically non-trivial  $\phi(\mathbf{r})$  is  $\pi m^\phi$  where

$$m^\phi = \frac{1}{2\pi} \oint \nabla\phi(\mathbf{r}) \cdot d\mathbf{r}, \quad (2.36)$$

is an integer. However the phase  $S_1^{\alpha,j}(\mathbf{r})$  poses a greater problem since as discussed it is not locally path independent so that it prevents us from constructing an analog of (2.34) in the most general circumstances which we will be interested in. This problem has been discussed in the context of multicomponent wave equations by Littlejohn and Flynn [17]. They proposed using Hamiltonians which include first order terms in  $\hbar$ . For these new Hamiltonians the effect of  $S_1^{\alpha,j}$  is already included in the ‘zeroth order’ theory. Their results were limited to systems with no global degeneracies and, as discussed by Emmrich and Weinstein [19], integrability of the underlying classical dynamics does not guarantee an extension of the EBK rules for degenerate systems. Recently Bolte and Keppeler [21] presented a semiclassical theory for the Dirac equation based on semiclassical trace formulae, rather than multicomponent WKB, at least in part to avoid these difficulties (and also to handle non-integrable dynamics). In our case, at the present time, this will not be necessary. In the next section we will follow a similar procedure to Littlejohn and Flynn which however will differ in that the Hamiltonians we construct will naturally be seen to contain terms up to  $\hbar^2$ . (This takes our work outside of the considerations of the above citations [19, 17].) Later in this paper, when we study the single vortex, the inclusion of  $\hbar^2$  terms in the Hamiltonian turns out to be essential in order to obtain the known (exact) wave function at the origin. (Note that there is no reason to object to  $\hbar$ -dependent terms in the ‘classical’ Hamiltonians since it is an effective (fictitious) classical mechanics that we are considering.)

### 3. AN EFFECTIVE SEMICLASSICAL THEORY

#### 3.1. The zeroth order theory

We start by writing the spinor in terms of amplitudes and phases

$$\begin{pmatrix} u_\lambda(\mathbf{r}) \\ v_\lambda(\mathbf{r}) \end{pmatrix} = \begin{pmatrix} u_{0,\lambda}(\mathbf{r})e^{+i\Sigma(\mathbf{r})} \\ v_{0,\lambda}(\mathbf{r})e^{-i\Sigma(\mathbf{r})} \end{pmatrix} e^{iS(\mathbf{r})} e^{-S_1^i(\mathbf{r})}, \quad (3.37)$$

but this time we *don't* expand  $S$  and  $\Sigma$  in  $\hbar$ . The amplitudes  $u_{0,\lambda}(\mathbf{r})$ ,  $v_{0,\lambda}(\mathbf{r})$  and  $e^{-S_1^i(\mathbf{r})}$  are again determined by the zeroth and first order equations of the theory but these equations will be different from those obtained by asymptotics in  $\hbar$ . Substituting (3.37) into the BdG equations and proceeding as before we obtain, instead of (2.11), the equations

$$\begin{pmatrix} E_\lambda - H(\hat{\mathbf{p}} + \mathbf{p}(\mathbf{r}; \hbar), \mathbf{r}) & -|\Delta(\mathbf{r})|e^{i\phi(\mathbf{r})} \\ -|\Delta(\mathbf{r})|e^{-i\phi(\mathbf{r})} & E_\lambda + H^*(\hat{\mathbf{p}} + \mathbf{p}(\mathbf{r}; \hbar), \mathbf{r}) \end{pmatrix} \begin{pmatrix} u_{0,\lambda}(\mathbf{r})e^{+i\Sigma(\mathbf{r})} \\ v_{0,\lambda}(\mathbf{r})e^{-i\Sigma(\mathbf{r})} \end{pmatrix} \times e^{-S_1^i(\mathbf{r})} = 0,$$

where  $\mathbf{p}(\mathbf{r}; \hbar) = \hbar\nabla S$  is the  $\hbar$ -dependent momentum<sup>3</sup>. We are not yet ready to make any simplifying approximations since the spinor still contains a phase. We use  $U_\phi(\mathbf{r})$  (2.12) to remove  $\phi(\mathbf{r})$  at every  $\mathbf{r}$ -point and obtain

$$\begin{pmatrix} E_\lambda - H(\hat{\mathbf{p}} + \mathbf{p}(\mathbf{r}; \hbar) + \frac{\hbar}{2}\nabla\phi, \mathbf{r}) & -|\Delta(\mathbf{r})| \\ -|\Delta(\mathbf{r})| & E_\lambda + H^*(\hat{\mathbf{p}} + \mathbf{p}(\mathbf{r}; \hbar) - \frac{\hbar}{2}\nabla\phi, \mathbf{r}) \end{pmatrix} \times \begin{pmatrix} u_{0,\lambda}(\mathbf{r})e^{+i\Sigma(\mathbf{r})-i\phi(\mathbf{r})/2} \\ v_{0,\lambda}(\mathbf{r})e^{-i\Sigma(\mathbf{r})+i\phi(\mathbf{r})/2} \end{pmatrix} e^{-S_1^i(\mathbf{r})} = 0. \quad (3.38)$$

For an appropriate zeroth order theory the spinor written in this form is indeed real as we now demonstrate.

To simplify the equations (3.38) we must drop the differential operators whose action upon  $u_{0,\lambda}(\mathbf{r})$  and  $v_{0,\lambda}(\mathbf{r})$  is small. Previously this was achieved by discarding all terms containing  $\hbar$  ( $\hat{\mathbf{p}} = -i\hbar\nabla$ ). However consistency would then require us to replace  $\mathbf{p}(\mathbf{r}; \hbar)$  by  $\mathbf{p}_0(\mathbf{r})$  which we do not want. Rather than use  $\hbar$  as our ordering parameter we instead use  $\hat{\mathbf{p}}$  itself. Thus our zeroth order theory is obtained by dropping  $\hat{\mathbf{p}}$  to give the analog of (2.13) i.e.,

$$\begin{pmatrix} E_\lambda - H^e(\mathbf{p}, \mathbf{r}) & -|\Delta(\mathbf{r})| \\ -|\Delta(\mathbf{r})| & E_\lambda + H^h(\mathbf{p}, \mathbf{r}) \end{pmatrix} \begin{pmatrix} u_{0,\lambda}(\mathbf{r})e^{+i\Sigma(\mathbf{r})-i\phi(\mathbf{r})/2} \\ v_{0,\lambda}(\mathbf{r})e^{-i\Sigma(\mathbf{r})+i\phi(\mathbf{r})/2} \end{pmatrix} = 0,$$

where now  $\mathbf{p} = \mathbf{p}(\mathbf{r}; \hbar)$ ,  $H^e(\mathbf{p}, \mathbf{r})$  is an electron Hamiltonian of the form (2.2) with the momentum operator  $\hat{\mathbf{p}}$  replaced by  $\mathbf{p}(\mathbf{r}; \hbar)$ , and the vector potential  $\mathbf{A}(\mathbf{r})$  replaced by an effective vector potential  $\mathbf{A}^{\text{eff}}(\mathbf{r}) =$

<sup>3</sup>If we wish to recover our previous results we can expand:  $\mathbf{p}(\mathbf{r}; \hbar) = \nabla S_0 + \hbar\nabla S_1^r + \dots = \mathbf{p}_0(\mathbf{r}) + \hbar\mathbf{p}_1(\mathbf{r}) + \dots$ , and proceed with asymptotics in the small parameter  $\hbar$ .

$\frac{\hbar}{2e}\nabla\phi(\mathbf{r}) + \mathbf{A}(\mathbf{r})$ . The hole Hamiltonian,  $H^h(\mathbf{p}, \mathbf{r})$ , is the same as  $H^e(\mathbf{p}, \mathbf{r})$  except  $e \rightarrow -e$ .

Since the resulting matrix Hamiltonian is real we have

$$\Sigma(\mathbf{r}) = \frac{\phi(\mathbf{r})}{2}, \quad (3.39)$$

and again, as a consequence of (2.16), we see that  $\Sigma$  can contain a topological contribution.

Our new theory yields the Hamilton-Jacobi equations

$$E_{\mathbf{I}} = E^\alpha(\mathbf{p}, \mathbf{r}), \quad (3.40)$$

where two new  $\hbar$ -dependent Hamiltonians,  $E^\alpha(\mathbf{p}, \mathbf{r})$ , have replaced the Hamiltonians  $E_0^\alpha(\mathbf{p}_0, \mathbf{r})$  appearing in our previous theory.

Explicitly the new Hamiltonians are

$$E^\alpha(\mathbf{p}, \mathbf{r}) = \mathbf{p} \cdot \mathbf{v}_s(\mathbf{r}) + \alpha \sqrt{\left(\frac{p^2}{2m} + \frac{1}{2}mv_s^2(\mathbf{r}) + V(\mathbf{r}) - \epsilon_F\right)^2 + |\Delta(\mathbf{r})|^2}, \quad (3.41)$$

where  $\alpha = \pm$  and  $m\mathbf{v}_s = \frac{\hbar}{2}\nabla\phi + e\mathbf{A}(\mathbf{r})$ . The constancy of  $E^\alpha(\mathbf{p}, \mathbf{r})$  defines implicitly the functions  $\mathbf{p}^\alpha(\mathbf{r}; \hbar) = \hbar\frac{\partial S^\alpha}{\partial \mathbf{r}}$ , and the solutions of the Hamilton-Jacobi equations, when they exist, have the form

$$S^\alpha(\mathbf{r}, \mathbf{I}) = \frac{1}{\hbar} \int_{\mathbf{r}_0(t_0)}^{\mathbf{r}(t)} \mathbf{p}^\alpha(\mathbf{r}, \mathbf{I}; \hbar) \cdot d\mathbf{r}, \quad (3.42)$$

where the integrals are taken along trajectories of the Hamiltonian systems

$$\dot{\mathbf{r}}^\alpha = \left(\frac{\partial E^\alpha(\mathbf{p}, \mathbf{r})}{\partial \mathbf{p}}\right), \quad \dot{\mathbf{p}}^\alpha = -\left(\frac{\partial E^\alpha(\mathbf{p}, \mathbf{r})}{\partial \mathbf{r}}\right). \quad (3.43)$$

The  $\hbar$ -dependent Hamiltonians (3.41) together with the Hamiltonian systems they define, and the  $\hbar$ -dependent action (3.42) are a central result of this paper.  $S^\alpha(\mathbf{r}, \mathbf{I})$  is clearly a locally path independent quantity since  $\mathbf{p}^\alpha(\mathbf{r}, \mathbf{I}; \hbar)$  is a solution of Hamilton's equations and thus lies in a Lagrangian torus in phase space. If we can prove that no other phases appear in our theory the action can immediately be used to construct a quantisation condition.

You will notice that the Hamiltonians (3.41) include a term in  $v_s^2(\mathbf{r})$ , that is a term of order  $\hbar^2$  as alluded to in the preceding section.

In concluding the zeroth order theory we see that the normalised amplitudes, representing the internal structure of our 'particle' as it is trans-

ported along the trajectory, become

$$\begin{aligned} u_{0,\mathbf{I}}^{\alpha,j}(\mathbf{r}) &= \sqrt{\frac{1}{2} \left( 1 + \beta \frac{\sqrt{(E^\alpha - \mathbf{p}^j \cdot \mathbf{v}_s)^2 - |\Delta(\mathbf{r})|^2}}{E^\alpha - \mathbf{p}^j \cdot \mathbf{v}_s} \right)}, \\ v_{0,\mathbf{I}}^{\alpha,j}(\mathbf{r}) &= \sqrt{\frac{1}{2} \left( 1 - \beta \frac{\sqrt{(E^\alpha - \mathbf{p}^j \cdot \mathbf{v}_s)^2 - |\Delta(\mathbf{r})|^2}}{E^\alpha - \mathbf{p}^j \cdot \mathbf{v}_s} \right)}. \end{aligned} \quad (3.44)$$

Thus the amplitudes too have become  $\hbar$ -dependent.

### 3.2. First order theory

To derive the new first order equation we take the expectation value of equation (3.38). By defining

$$G = \begin{pmatrix} u_{0,\lambda}(\mathbf{r}) e^{+i\Sigma(\mathbf{r}) - i\phi(\mathbf{r})/2} \\ v_{0,\lambda}(\mathbf{r}) e^{-i\Sigma(\mathbf{r}) + i\phi(\mathbf{r})/2} \end{pmatrix} e^{-S_1^i(\mathbf{r})}, \quad (3.45)$$

and introducing  $\hat{D}(\hbar)$  for the  $\hbar$ -dependent matrix differential operator:

$$\hat{D}(\hbar) = \begin{pmatrix} E_\lambda - H(\hat{\mathbf{p}} + \mathbf{p}(\mathbf{r}; \hbar) + \frac{\hbar}{2}\nabla\phi, \mathbf{r}) & -|\Delta(\mathbf{r})| \\ -|\Delta(\mathbf{r})| & E_\lambda + H^*(\hat{\mathbf{p}} + \mathbf{p}(\mathbf{r}; \hbar) - \frac{\hbar}{2}\nabla\phi, \mathbf{r}) \end{pmatrix},$$

we can write this expectation as

$$G^\dagger \hat{D}(\hbar) G = 0.$$

Expanding this equation upto and including first order in  $\hat{\mathbf{p}}$  we find

$$0 = G_0^\dagger D_0(\hbar) G_0 + G_1^\dagger D_0(\hbar) G_0 + G_0^\dagger D_0(\hbar) G_1 + G_0^\dagger \hat{D}_1(\hbar) G_0, \quad (3.46)$$

where  $D_0(\hbar)$  is the zeroth order  $\hbar$ -dependent Hamiltonian matrix

$$D_0(\hbar) = \begin{pmatrix} E_{\mathbf{I}} - H^e(\mathbf{p}, \mathbf{r}) & -|\Delta(\mathbf{r})| \\ -|\Delta(\mathbf{r})| & E_{\mathbf{I}} + H^h(\mathbf{p}, \mathbf{r}) \end{pmatrix}, \quad (3.47)$$

$G_0$  is given by equation (3.45) together with the zeroth order condition (3.39) i.e.

$$G_0 = \begin{pmatrix} u_{0,\mathbf{I}}(\mathbf{r}) \\ v_{0,\mathbf{I}}(\mathbf{r}) \end{pmatrix} e^{-S_1^i(\mathbf{r})}, \quad (3.48)$$

which does not contain any phases,  $G_1$  allows for corrections beyond those considered in  $G_0$  (in analogy with the semiclassical theory (Appendix B)), and  $\hat{D}_1(\hbar)$  is

$$\hat{D}_1 = \begin{pmatrix} -\frac{1}{2m} \left( \frac{\hbar}{i} \nabla \cdot \mathbf{P}^+ + \mathbf{P}^+ \cdot \frac{\hbar}{i} \nabla \right) & 0 \\ 0 & +\frac{1}{2m} \left( \frac{\hbar}{i} \nabla \cdot \mathbf{P}^- + \mathbf{P}^- \cdot \frac{\hbar}{i} \nabla \right) \end{pmatrix},$$

where  $\mathbf{P}^\pm(\hbar) = \mathbf{p}(\mathbf{r}; \hbar) \pm m\mathbf{v}_s(\mathbf{r})$ . Our analysis now parallels our previous semiclassical discussion (Appendix B): the first term in equation (3.46) is the zeroth order equation whilst the second and third terms can both be shown to depend upon  $D_0(\hbar)G_0 = 0$ , so that their vanishing yields no new information. We are left with the first order equation

$$\mathcal{O}(\hat{\mathbf{p}}) \quad 0 = G_0^\dagger \hat{D}_1(\hbar) G_0.$$

Defining the vector matrix  $\mathbf{M}$  by

$$\mathbf{M} = \begin{pmatrix} -\frac{\mathbf{P}^+(\hbar)}{2m} & 0 \\ 0 & +\frac{\mathbf{P}^-(\hbar)}{2m} \end{pmatrix}, \quad (3.49)$$

this can be rewritten as

$$0 = \nabla \cdot \{G_0^\dagger \mathbf{M} G_0\} + 2i \operatorname{Im} \left[ G_0^\dagger \mathbf{M} \cdot \nabla G_0 \right]. \quad (3.50)$$

The first term is purely real, whilst the second is purely imaginary. In our previous semiclassical theory, where we had the spinor  $F_0$  in place of  $G_0$ , the first term led to the transport equation (see (2.27) and (2.29)) whilst the second led to an equation for the first order phase  $S_1^r(\mathbf{r})$ , (see (2.28) and (2.31)). This was because  $F_0$  was complex. In the present effective semiclassical theory  $G_0$  is real (3.48). Consequently the second term in the above is trivially zero. We are left with a new transport equation which can be written as

$$\nabla \cdot \left( e^{-2S_1^i(\mathbf{r}, \mathbf{I})} \left. \frac{\partial E^\alpha(\mathbf{p}, \mathbf{r})}{\partial \mathbf{p}} \right|_{\mathbf{p}=\mathbf{p}^\alpha(\mathbf{r}, \mathbf{I}; \hbar)} \right) = 0, \quad (3.51)$$

in terms of our new  $\hbar$ -dependent Hamiltonians (3.41). Its solution yields the new  $\hbar$ -dependent determinant

$$e^{-S_1^i(\mathbf{r}, \mathbf{I})} = c \left| \det \frac{\partial^2 S^{\alpha, j}(\mathbf{r}, \mathbf{I}; \hbar)}{\partial \mathbf{r} \partial \mathbf{I}} \right|^{1/2}. \quad (3.52)$$

Actually one must be more careful than we have been here in deriving this effective theory. Whilst one would very much like there to be no first order phase corrections ( $S_1^r, \Sigma_1^r$ ) we simply cannot demand that this is the case. As soon as we approximate to obtain a zeroth order theory  $\Sigma$  and  $S$  are only determined to this order and we must allow for the possibility of corrections,  $S_1^r(\mathbf{r}), \Sigma_1^r(\mathbf{r})$ . If we do this  $G$ , equation (3.45), is replaced by

$$G' = \begin{pmatrix} u_{0, \mathbf{I}}(\mathbf{r}) e^{+i\Sigma(\mathbf{r}) + i\Sigma_1^r(\mathbf{r}) - i\phi(\mathbf{r})/2} \\ v_{0, \mathbf{I}}(\mathbf{r}) e^{-i\Sigma(\mathbf{r}) - i\Sigma_1^r(\mathbf{r}) + i\phi(\mathbf{r})/2} \end{pmatrix} e^{+iS_1^r(\mathbf{r})} e^{-S_1^i(\mathbf{r})}, \quad (3.53)$$



and  $G_0$  by

$$G'_0 = \begin{pmatrix} u_{0,\mathbf{I}}(\mathbf{r})e^{+i\Sigma_1^r(\mathbf{r})} \\ v_{0,\mathbf{I}}(\mathbf{r})e^{-i\Sigma_1^r(\mathbf{r})} \end{pmatrix} e^{+iS_1^r(\mathbf{r})} e^{-S_1^i(\mathbf{r})}. \quad (3.54)$$

Then  $\text{Im} \left[ G_0^\dagger \mathbf{M} \cdot \nabla G_0 \right]$  is no longer trivially zero and yields

$$S_1^r(\mathbf{r}) = -\frac{1}{e} \int_{t_0}^t \mathbf{j}^{\alpha,j}(\mathbf{r}) \cdot \nabla \Sigma_1^r(\mathbf{r}) dt', \quad (3.55)$$

where

$$-\frac{1}{e} \mathbf{j}^{\alpha,j}(\mathbf{r}) = \frac{\mathbf{p}^{\alpha,j}(\mathbf{r}; \hbar)}{m} + \left( (u_{0,\mathbf{I}}^{\alpha,j}(\mathbf{r}))^2 - (v_{0,\mathbf{I}}^{\alpha,j}(\mathbf{r}))^2 \right) \frac{e\mathbf{A}^{\text{eff}}(\mathbf{r})}{m}.$$

But there is a crucial difference between (3.55) and (2.31), namely it depends upon  $\nabla \Sigma_1^r$  rather than  $\nabla \phi$ . What can we say about  $\nabla \Sigma_1^r$ ? Appealing to self-consistency we have

$$u_\lambda(\mathbf{r})v_\lambda^*(\mathbf{r}) \propto e^{i2\Sigma(\mathbf{r})+i2\Sigma_1^r(\mathbf{r})} = e^{i\phi(\mathbf{r})+i2\Sigma_1^r(\mathbf{r})}.$$

Thus  $\Sigma_1^r = m\pi$ ,  $m$  an integer, so  $\nabla \Sigma_1^r = 0$ , and hence  $S_1^r = 0$ . Furthermore using the same arguments as followed equation (2.15), the need for  $\Sigma_1^r$  can be eliminated. Since  $S_1^r = 0$ , and  $\Sigma_1^r = 0$  our form for the spinor, equation (3.37), and all that follows up to (3.51) is indeed correct. We have succeeded in constructing a theory where there are no first order phase corrections and have thus removed the obstacle to the derivation of a generalised Bohr-Sommerfeld or EBK quantisation rule.

The general wave function for our effective semiclassical theory now takes the form

$$\begin{aligned} \begin{pmatrix} u_{\mathbf{I}}^\alpha(\mathbf{r}) \\ v_{\mathbf{I}}^\alpha(\mathbf{r}) \end{pmatrix} &= \sum_j A_j^\alpha \left| \det \frac{\partial^2 S^{\alpha,j}(\mathbf{r}, \mathbf{I}; \hbar)}{\partial \mathbf{r} \partial \mathbf{I}} \right|^{1/2} \begin{pmatrix} u_{0,\mathbf{I},\hbar}^{\alpha,j}(\mathbf{r}) e^{+i\phi(\mathbf{r})/2} \\ v_{0,\mathbf{I},\hbar}^{\alpha,j}(\mathbf{r}) e^{-i\phi(\mathbf{r})/2} \end{pmatrix} \times \\ &\times \exp(i\hbar^{-1} S^{\alpha,j}(\mathbf{r}, \mathbf{I}; \hbar) + im\pi/2), \end{aligned} \quad (3.56)$$

and the single-valuedness of this after returning from circuits around each of the irreducible loops,  $\Gamma_l$  on the 3-torus yields the general quantisation conditions

$$\oint_{\Gamma_l} \mathbf{p}^\alpha(\mathbf{r}; \hbar) \cdot d\mathbf{r} = 2\pi\hbar \left( n_l^\pm + \frac{m_l}{4} \mp \frac{m_l^\phi}{2} \right), \quad (3.57)$$

where as before

$$m_l^\phi = \frac{1}{2\pi} \oint_{\Gamma_l} \nabla \phi(\mathbf{r}) \cdot d\mathbf{r}, \quad (3.58)$$

takes integer values. For a given  $\Gamma_l$  the line integral in equation (3.57) is fixed so we must have  $n_l^+ = n_l^- + m_l^\phi$ , i.e. we need only one of  $n_l^\pm$ . Choosing  $n_l^+ = n_l$  equation (3.57) becomes

$$\oint_{\Gamma_l} \mathbf{p}^\alpha(\mathbf{r}; \hbar) \cdot d\mathbf{r} = 2\pi\hbar \left( n_l + \frac{m_l}{4} - \frac{m_l^\phi}{2} \right), \quad (3.59)$$

for  $n_l$ ,  $m_l$ , and  $m_l^\phi$  integers. This is our generalisation of the EBK quantisation condition to apply to the superconducting case. It includes two topological integers. The first is the familiar Maslov index, whilst the second arises from the vortex singularities, which, if present, shift the quantum numbers by half-integers. The action integral itself, as discussed, is defined upon an  $\hbar$ -dependent Lagrangian submanifold in phase space. The trajectories of the Hamiltonian system which wind around this manifold are specified by the  $\hbar$ -dependent Hamiltonians,  $E^\alpha(\mathbf{p}, \mathbf{r})$ , equations (3.41). The question then arises as to the interpretation of a theory depending upon these Hamiltonians. In particular how should the appearance of  $\hbar\nabla\phi(\mathbf{r})/2$  be understood?

### 3.3. Interpretation: A Semiclassical theory in the presence of lines of phase singularities

Consider the BdG equations written in the (exact) form

$$\begin{pmatrix} E_\lambda - \frac{1}{2m} \left( \hat{\mathbf{p}} + \frac{\hbar}{2} \nabla\phi(\mathbf{r}) + e\mathbf{A}(\mathbf{r}) \right)^2 - V(\mathbf{r}) + \epsilon_F & -|\Delta(\mathbf{r})| \\ -|\Delta(\mathbf{r})| & E_\lambda + \frac{1}{2m} \left( \hat{\mathbf{p}} - \frac{\hbar}{2} \nabla\phi(\mathbf{r}) - e\mathbf{A}(\mathbf{r}) \right)^2 + V(\mathbf{r}) - \epsilon_F \end{pmatrix} \times \begin{pmatrix} u_\lambda(\mathbf{r})e^{-i\phi(\mathbf{r})/2} \\ v_\lambda(\mathbf{r})e^{+i\phi(\mathbf{r})/2} \end{pmatrix} = 0. \quad (3.60)$$

The term  $\hbar\nabla\phi(\mathbf{r})/2$  enters into the particle and hole Hamiltonians as an effective vector potential

$$\mathbf{A}^{\text{PS}}(\mathbf{r}) = \frac{\hbar}{2e} \nabla\phi(\mathbf{r}). \quad (3.61)$$

There is a flux associated with this vector potential which we can find by integrating (3.61) along a path enclosing a vortex singularity:

$$\begin{aligned} \oint_c \nabla\phi(\mathbf{r}) \cdot d\mathbf{r} &= \frac{2e}{\hbar} \oint_c \mathbf{A}^{\text{PS}}(\mathbf{r}) \cdot d\mathbf{r}, \\ 2\pi &= \frac{2e}{\hbar} \Phi_0. \end{aligned} \quad (3.62)$$

The left hand side follows from the single-valuedness of  $\Delta(\mathbf{r})$ . On the right hand side we have introduced  $\Phi_0$  for the flux. It takes the value

$$\Phi_0 = \frac{\hbar\pi}{e}, \quad (3.63)$$

i.e it is equal to one superconducting flux quantum. Where is this flux? We can contract the curve,  $c$ , until only the line of phase singularities is left inside. Equation (3.62) remains true. Thus each line of phase singularities, defined by  $|\Delta(\mathbf{r})| = 0$ , carries a flux,  $\Phi_0$ , along it. A similar object was studied by Dirac [22], and is referred to as a Dirac string. However our string has a physical reality, lying along the node of the order parameter unlike a Dirac string which need not lie along a node. Hence we will stick with the ‘line of phase singularities’ terminology.  $\mathbf{A}^{\text{PS}}(\mathbf{r})$  is then the vector potential associated with such a line of singularities. We can then interpret equation (3.60) as describing superconducting quasiparticles in the presence of lines of phase singularities of the pairing potential, each carrying a flux,  $\Phi_0$ . Replacing  $\hat{\mathbf{p}}$  by  $\mathbf{p}$  and diagonalising we obtain the Hamilton-Jacobi equations  $E_{\mathbf{I}} = E^\alpha(\mathbf{p}, \mathbf{r})$ , with  $E^\alpha(\mathbf{p}, \mathbf{r})$  given by equation (3.41). Thus we have constructed a (fictitious) classical mechanics describing quasiparticle excitations in superconductors propagating in the presence of lines of phase singularities carrying flux  $\Phi_0 = h/2e$ .

When the classical mechanics is integrable (a single s-wave vortex is such an example) then the semiclassical wave function takes the form (3.56) and we can apply the quantisation conditions (3.59) to obtain the semiclassical excitation spectrum. If however the classical dynamics is non-integrable then the solution cannot have the form (3.56). We return to this point at the end of the paper.

In the interest of clarity concerning the above discussion we would like to make the following remark. If for a moment we consider a single vortex whose axis lies along the  $z$ -axis, then by symmetry

$$\Delta(\mathbf{r}) = |\Delta(r)|e^{i\theta},$$

in polar coordinates. The vector potential  $\mathbf{A}^{\text{PS}}(\mathbf{r})$  is then explicitly

$$\mathbf{A}^{\text{PS}}(\mathbf{r}) = \frac{\Phi_0}{2\pi r} \hat{\theta}. \quad (3.64)$$

Now the vector potential associated with an Aharonov-Bohm (AB) flux tube is

$$\mathbf{A}^{\text{AB}}(\mathbf{r}) = \frac{\Phi^{\text{AB}}}{2\pi r} \hat{\theta}, \quad (3.65)$$

for  $r > r_c$ , the solenoid radius. If we consider the limit  $r_c \rightarrow 0$  as representing an idealised AB flux tube, or AB flux line then equations (3.64) and (3.65) become identical for the choice  $\Phi^{\text{AB}} = \Phi_0$ . For this reason a vortex has been described in the literature [10] as an effective magnetic Aharonov-Bohm half-flux. However we would like to point out here that there is a crucial difference between an AB flux line and a superconducting vortex, namely that the single-valuedness of the AB wave function does

not quantise the flux,  $\Phi^{\text{AB}}$ , which remains classical [23], whilst single-valuedness of the order parameter,  $\Delta(\mathbf{r})$ , *does* quantise the flux,  $\Phi_0$ . For this reason we prefer the line of phase singularities terminology.

We have one last point to make. In our original discussion of the general form for the wave function we remarked (see the paragraph following equation (2.8)) that if  $\phi(\mathbf{r})$  is not expanded in  $\hbar$ , which we claim to be the correct procedure, then there is no fast component to the spinor i.e.,  $\Sigma_0^r(\mathbf{r}) = 0$ . Conversely had we insisted upon expanding  $\phi(\mathbf{r}) = \hbar^{-1}\phi_0(\mathbf{r}) + \dots$  the zeroth order theory would have included the term  $\hbar\nabla\phi|_{\hbar=0} = \nabla\phi_0$ . In the light of our effective semiclassical theory we now see that even though  $\phi(\mathbf{r})$  is not to be expanded, i.e.,  $\hbar\nabla\phi(\mathbf{r}) \sim \hbar$ , the most useful form for the theory has  $\hbar\nabla\phi$  appearing in the “zeroth order” theory Hamiltonians.

This concludes our formalism for seeking semiclassical solutions to superconducting problems described by the BdG equations (2.1). The general procedure is then as follows: (i) Choose  $\mathbf{A}(\mathbf{r})$  and  $\Delta(\mathbf{r})$  appropriate to the situation of interest. One can then immediately write down the effective Hamiltonians in explicit form. (ii) Investigate the orbits of the Hamiltonian system and identify those of interest. (iii) Compute the relevant Maslov indices and any topological indices arising from vortex singularities. (iv) Deploy the generalised EBK quantisation condition (3.59) to obtain the semiclassical spectrum. (Steps (iii) and (iv) can be interchanged if analytic expressions are being sort.) Depending upon the situation it may also be important to: (v) investigate tunnelling between classical orbits and its effect upon the semiclassical spectrum, for example the lifting of degeneracies to yield ‘avoided crossings’. (vi) One may also deploy the wave function to study properties other than the energy spectrum (for example, quasiparticle current flow).

In the next two sections we will apply this theory to two well known problems. The first we will consider is a superconductor-normal metal-superconductor (SNS) junction. For this system we will focus upon understanding the various branches of  $p_y^\beta(y)$  which make up a trajectory in a superconducting system, and upon the type of quasiparticles they represent. We will then quantise the orbit and obtain the spectrum. Furthermore we will compute the Maslov index, though via the more ‘traditional’ route of asymptotic analysis, and show that it is what one would expect from following Maslov’s topological prescription. Since for the SNS junction we take  $\hbar\nabla\phi = 0$  the two theories presented in sections 2 and 3 are identical. By contrast the second problem we apply our theory to, the single vortex, has  $\hbar\nabla\phi \neq 0$ . The significance of the topological phase and  $\hbar$ -dependent terms in the theory will then become apparent.

#### 4. THE SUPERCONDUCTOR-NORMAL METAL-SUPERCONDUCTOR JUNCTION

A superconductor-normal metal-superconductor junction (SNS) consists of a taking a superconducting wire and replacing a segment with a piece of normal metal. The inclusion of the normal layer makes the order parameter,  $\Delta(\mathbf{r})$ , inhomogeneous along the wire. By assuming the wire is sufficiently thick to neglect finite size effects the profile of  $\Delta(\mathbf{r})$  will only vary along the length of the wire. We choose the  $y$ -axis to lie along this direction and take  $y = 0$  to be at the middle of the normal layer. We shall allow  $|\Delta(y)|$  to have a smoothly varying profile at each interface. This contrasts with the more usual approach in the literature [24, 25] of taking the profile of  $|\Delta|$  to be a step function at each interface. The ‘width’ of the normal layer, as far as an excitation is concerned, is decided by the turning points of the classical trajectory and is thus energy dependent. These turning points will be designated by  $y_-(E)$  and  $y_+(E)$  ( $y_- < y_+$ ), see FIG. 2. The phases of the order parameter are taken to be constant and

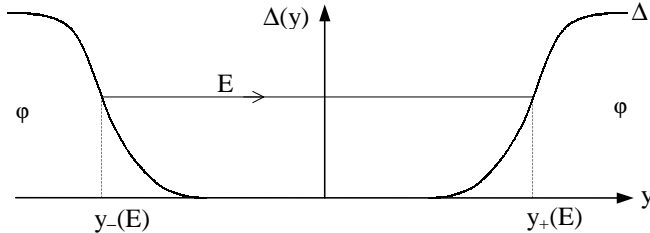

**FIG. 2** Illustration of the profile of  $|\Delta(y)|$  with classical turning points,  $y_{\pm}(E)$ , indicated.

both equal to  $\phi$ , i.e there is no phase gradient across the junction. Then, taking the vector potential  $\mathbf{A}(\mathbf{r})$  to be zero, the classical Hamiltonians,  $E^{\alpha}(\mathbf{p}, \mathbf{r})$ , equations (3.41), are found to be

$$E^{\alpha}(\mathbf{p}, \mathbf{r}) = \alpha \sqrt{\left(\frac{p_x^2}{2m} + \frac{p_y^2}{2m} + \frac{p_z^2}{2m} - \epsilon_F\right)^2 + |\Delta(y)|^2}, \quad (4.66)$$

where  $\alpha = \pm$  distinguishes the two Hamiltonians. However in keeping with the definition of  $E_{\mathbf{I}}$  as an excitation energy ( $E_{\mathbf{I}} \geq 0$ ) we can discard the  $\alpha = -1$  Hamiltonian, and consider only  $E^+(\mathbf{p}, \mathbf{r})$ .

#### 4.1. The $y$ behaviour of the excitation orbits

Setting  $E^+(\mathbf{p}, \mathbf{r}) = E$ , equation (4.66) can be inverted giving  $p_y^\beta(y)$  ( $\beta = \pm$ ) as

$$p_y^\beta(y) = \sqrt{p_F^2 - p_x^2 - p_z^2 + \beta 2m\sqrt{E^2 - |\Delta(y)|^2}}. \quad (4.67)$$

Thus  $E^+(\mathbf{p}, \mathbf{r}) = E$  defines four momentum branches (including  $-p_y^\pm(y)$ ) as a function of position, from which the orbit of the excitation is to be constructed.

Now  $p_y^+$  represents a quasiparticle, and  $p_y^-$  a quasihole (see Appendix A). This is clear from considering (4.67) deep inside the normal layer where  $|\Delta(y)| \rightarrow 0$ :

$$\lim_{|\Delta| \rightarrow 0} p_y^\pm(y) = \sqrt{p_F^2 \pm 2mE - p_x^2 - p_z^2}. \quad (4.68)$$

When  $E$  is non-zero  $p_y^+$  lies outside the Fermi sea - a particle-like excitation - whilst  $p_y^-$  lies inside, so describes a hole-like excitation.

Throughout the normal region, for which  $|\Delta(y)| = 0$ , the momentum branches  $p_y^\pm(y)$  are independent of  $y$ , i.e are straight lines in the  $p_y - y$  phase plane.

Let us write  $p_y^\pm(y)$  in (4.67) as

$$p_y^\beta(y) = \sqrt{p_F^2 - p_x^2 - p_z^2 + \beta\epsilon(y)}, \quad (4.69)$$

where  $\epsilon(y) = 2m\sqrt{E^2 - |\Delta(y)|^2}$ . Approaching the interface  $|\Delta(y)| \rightarrow E$ , so  $\epsilon(y) \rightarrow 0^+$ . Then from (4.69)  $p_y^+$  decreases and  $p_y^-$  increases (FIG. 3). The length scale over which  $\epsilon(y)$  changes is given by the coherence length,  $\xi$ . At the interfaces  $\epsilon(y_\pm) = 0$  and  $p_y^\pm(y)$  are

$$\lim_{|\Delta| \rightarrow E} p_y^\pm(y) = \sqrt{p_F^2 - p_x^2 - p_z^2}. \quad (4.70)$$

Thus at the points  $y_\pm$ , the particle and hole momenta are equal. Notice however that  $p_y^\pm(y_\pm) \neq 0$ .<sup>4</sup> This behaviour at the coalescence of the momentum branches contrasts with typical classical orbits where the turning points are characterised by  $p_y(y_i) = 0$ .

To understand what happens when the two momenta coalesce we consider the velocity associated with an excitation moving along each of the

<sup>4</sup>From equation (4.70),  $p_y^\pm(y_\pm) \neq 0$  unless  $p_F^2 = p_x^2 + p_z^2$ , i.e. unless all the kinetic energy is parallel to the interface - a situation which we shall not consider here. However, see for example Šipr and Györfy [26] for details of how the physics changes radically in this limit.

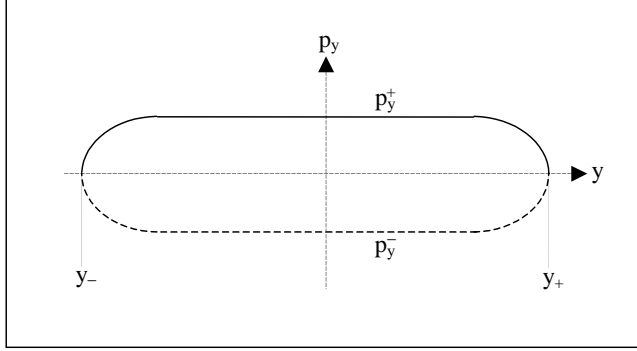

**FIG. 3** The form of  $p_y^\pm(y)$  as  $|\Delta(y)| \rightarrow E$ . The  $p_y^\pm$  are constant and positive deep in the normal layer  $y_- \ll y \ll y_+$ . For  $|\Delta(y)| \rightarrow E$  ( $y \rightarrow y_\pm$ )  $p_y^+$  decreases whilst  $p_y^-$  increases.

trajectories  $p_y^\pm$ . For this we use Hamilton's equations (2.19), together with the Hamiltonian (4.66) for this problem. We have

$$\begin{aligned} \dot{\mathbf{r}} &= \left( \frac{\partial E(\mathbf{p}, \mathbf{r})}{\partial \mathbf{p}} \right), \\ &= \frac{\partial}{\partial \mathbf{p}} \sqrt{\left( \frac{\mathbf{p}^2}{2m} - \epsilon_F \right)^2 + |\Delta(y)|^2}, \\ &= \frac{\left( \frac{\mathbf{p}^2}{2m} - \epsilon_F \right)}{\sqrt{\left( \frac{\mathbf{p}^2}{2m} - \epsilon_F \right)^2 + |\Delta(y)|^2}} \frac{\mathbf{p}}{m}, \end{aligned}$$

all evaluated for  $\mathbf{p} = \mathbf{p}^\pm(\mathbf{r})$  and  $\mathbf{r} = \mathbf{r}^\pm(t)$ . By using equation (4.67) the velocity is

$$\mathbf{v}^\pm = \pm \frac{\sqrt{E^2 - |\Delta(y)|^2}}{E} (p_x, p_y^\pm(y), p_z). \quad (4.71)$$

In the limit  $|\Delta(y)| \rightarrow 0$ ,  $\mathbf{v}^\pm \rightarrow \pm (p_x, p_y^\pm(y), p_z)$ . Let  $p_y^\pm > 0$  as in FIG. 3, then for a particle the velocity  $\mathbf{v}^+$  is directed to the right, whilst the hole velocity is directed to the left. This situation is reversed if the negative branches of  $p_y^\pm$  are considered. FIG. 4 shows all the branches of  $p_y(y)$  together with arrows indicating the velocity of the excitation. Consider a particle travelling along  $p_y^+ > 0$  approaching  $y_+$ . The velocity  $\mathbf{v}^+ > 0$  decreases until it is zero at  $y_+$ . At this point  $p_y^+(y_+) = p_y^-(y_+)$  and the particle converts to a hole. It then moves away from the interface with  $\mathbf{v}^- < 0$ . Thus even though  $p_y^\pm(y) \neq 0$ ,  $y = y_\pm$  is a turning point of the

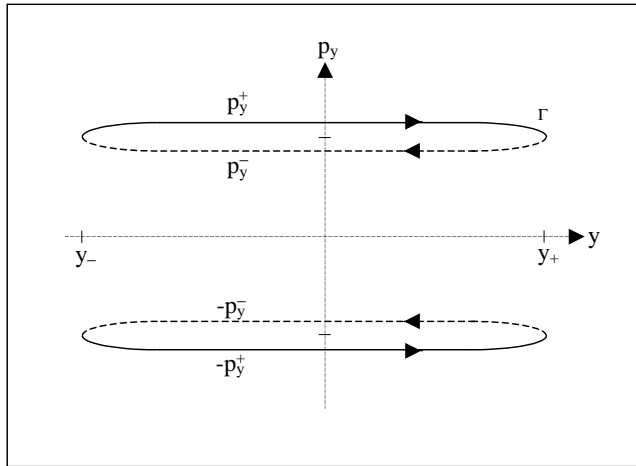

**FIG. 4** The branches of  $p_y(y)$  with the corresponding velocity directions indicated.

orbit. From (4.71) we see the quantity responsible for the change in sign of the velocity is the scalar function  $\pm\sqrt{E^2 - |\Delta(y)|^2}/E$  which multiplies *all three* components of the momentum  $\mathbf{p}$ . Thus at reflection all velocity components reverse their direction despite both  $p_x$  and  $p_z$  being constants of the motion.<sup>5</sup> Such a process is called Andreev reflection [2], and we have demonstrated that our ‘classical’ Hamiltonians describe this remarkable property of quasiparticle excitations in a superconductor.

Once the hole has travelled across the normal layer the reverse process happens, the hole turns into a particle, and the excitation completes a periodic orbit. Thus we have bound excitations in the normal layer whose orbit consists of both quasiparticle and quasihole segments. We call  $y_{\pm}$  (defined implicitly by  $\epsilon(y_{\pm}) = 0$ ) Andreev turning points to distinguish them from normal turning points,  $y_i$ , for which  $p_y^{\pm}(y_i) = 0$ . FIG. 5 conveys this remarkable feature of the reflection in real space.

Now that we have identified the classical orbits we can turn our attention to the semiclassical spectrum.

#### 4.2. Calculation of semiclassical spectrum

We deploy our generalised quantisation rule

$$\oint_{\Gamma} \mathbf{p}^{\alpha}(\mathbf{r}; \hbar) \cdot d\mathbf{r} = 2\pi\hbar \left( n + \frac{m}{4} - \frac{m^{\phi}}{2} \right).$$

<sup>5</sup>It is clear that  $p_x$  and  $p_z$  are constants of the motion because both  $x$  and  $z$  are cyclic coordinates so that  $\dot{p}_x = 0$  and  $\dot{p}_z = 0$ .



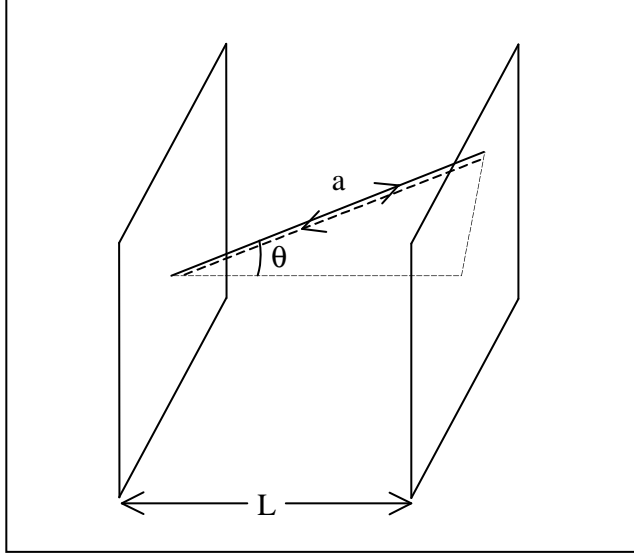

**FIG. 5** Illustration of the unique nature of Andreev scattering - retroreflection.

Since  $p_x$  and  $p_z$  are constant along the orbit, which retraces itself,  $\oint p_x dx = \oint p_z dz = 0$ . Furthermore  $m^\phi = 0$  since there are no vortices. Our quantisation condition becomes

$$\oint_{\Gamma} p_y^\beta(y; \hbar) dy = 2\pi\hbar \left( n + \frac{m}{4} \right), \quad (4.72)$$

with  $\beta = \pm$  along the appropriate segments of the trajectory,  $\Gamma$ , drawn in FIG. 4. If we calculate the right hand side of (4.72), which depends upon  $E$  through  $p_y^\beta$ , we can find the semiclassical spectrum of bound Andreev excitations in the SNS system. This we now do.

For our example we have

$$\oint_{\Gamma} p_y^\beta(y) dy = \int_{y_-}^{y_+} p_y^+(y) dy - \int_{y_-}^{y_+} p_y^-(y) dy. \quad (4.73)$$

At this stage we approximate the momentum branches  $p_y^\pm(y)$  by replacing  $|\Delta(y)|$  by a step  $|\Delta|$ . There is no need to do this<sup>6</sup> other than to facilitate a comparison of our results with Andreev [3]. With this approximation the

<sup>6</sup>In appendix C, when the Maslov index  $m_l$  is calculated, it is done so for a general smoothly varying  $|\Delta(y)|$ , see equation (C.142).

momentum branches  $p_y^\pm$  in the normal layer are given by

$$\begin{aligned} p_y^\pm &= \sqrt{p_F^2 - p_\perp^2 \pm 2mE}, \\ &= \sqrt{(p_F^2 - p_\perp^2)} \left( 1 \pm \frac{2mE}{p_F^2 - p_\perp^2} \right)^{1/2}, \end{aligned}$$

where  $p_\perp^2 = p_x^2 + p_z^2$ . The quantity  $2mE/(p_F^2 - p_\perp^2) \ll 1$  for almost all values of  $p_\perp$  except  $p_\perp \rightarrow p_F$ . The latter limit implies that the excitation hits the interface at glancing incidence which we do not consider here. Let us therefore expand  $p_y^\pm$  in powers of  $E$ . Upto and including first order in  $E$  the  $p_y^\pm$  become

$$p_y^\pm = p_F |\cos \theta| \pm \frac{1}{2} \frac{2mE}{p_F |\cos \theta|}. \quad (4.74)$$

Here we have used  $p_\perp = p_F \sin \theta$  (valid to this order). (The modulus has been inserted to remind us that  $-\pi/2 \leq \theta \leq \pi/2$ .) Returning to (4.73) and using (4.74) we have

$$\int_{y_-}^{y_+} dy (p_y^+(y) - p_y^-(y)) = \frac{2E}{v_F |\cos \theta|} L, \quad (4.75)$$

where  $L = y_+ - y_-$  is the width of the normal layer which is the same for all bound excitations in the step  $|\Delta|$  approximation. Quantising (4.75) directly using (4.72) we find [3]:

$$E_n(\theta) = \pi \hbar v_F \left( n + \frac{m}{4} \right) \frac{|\cos \theta|}{L}. \quad (4.76)$$

This is the well known spectrum of an excitation trapped in the normal layer of an SNS junction (usually obtained by wave function matching). Since the orbits we have quantised are topologically circles the Maslov index is  $m = 2$  (see section 2.4). We will however calculate it explicitly below. A number of text books discuss the spectrum, (4.76), (see for example Abrikosov [27]) so we will not dwell on it further. We do, however, want to draw attention to the following points. Our use of Hamiltons equations, together with a smoothly varying  $|\Delta(y)|$ , gave a simple and clear picture of the ‘particle’ to ‘hole’ conversion at the interface. It is an attractive feature of this theory that our classical Hamiltonian system describes Andreev retroreflection, rather than having it arise from wave function matching. The generalised quantisation rule correctly reproduces the Andreev spectrum. In his book [27] Abrikosov invokes Bohr’s quantisation rule to obtain this spectrum. However the justification for using such a quantisation rule is non-trivial as we have demonstrated.

We now conclude our discussion of the semiclassical theory in the context of the SNS junction by utilizing the wave function to determine the Maslov index.

### 4.3. The semiclassical wave functions for excitations in SNS junctions

The wave function for this example consists of plane waves in the  $x$  and  $z$  directions (since  $p_x$  and  $p_z$  are constants of the motion) together with the one dimensional form of our semiclassical wave function. (Since  $\nabla\phi = 0$  either of the semiclassical wave functions, (2.32) or (3.56) in their one dimensional form can be used because they are identical in this case.) Thus we have

$$\begin{pmatrix} u_{I,p_x,p_z}(\mathbf{r}) \\ v_{I,p_x,p_z}(\mathbf{r}) \end{pmatrix} = \sum_{\beta,j} A_{\beta,j} \left| \frac{\partial^2 S^{\beta,j}(y,I)}{\partial y \partial I} \right|^{1/2} \begin{pmatrix} u_{0,I}^{\beta,j}(y) e^{+i\phi/2} \\ v_{0,I}^{\beta,j}(y) e^{-i\phi/2} \end{pmatrix} \times \\ \times e^{ip_x x/\hbar + ip_z z/\hbar} \exp(i\hbar^{-1} S^{\beta,j}(y,I) + im\pi/2), \quad (4.77)$$

where now  $\beta$  labels the two distinct momentum branches  $p_y^+$  and  $p_y^-$  whilst  $j$  specifies the sign of those branches. It is useful to separate the four branches  $p_y^+, p_y^-, -p_y^+, -p_y^-$ , in this way because both the spinor amplitudes  $u_{0,I}^{\beta,j}(y)$  and  $v_{0,I}^{\beta,j}(y)$ , and the amplitude factor  $|\partial^2 S^{\beta,j}/\partial y \partial I|^{1/2}$  will turn out to be insensitive to the sign of the momentum. The amplitude factor can be rewritten as

$$\left| \frac{\partial^2 S^{\beta,j}(y,I)}{\partial y \partial I} \right|^{1/2} = \omega^{1/2} \left| \frac{\partial E}{\partial p_y} \right|^{-1/2}, \quad (4.78)$$

where  $\omega(I) = \partial E/\partial I$  is a constant which we will absorb into the amplitudes  $A_{\beta,j}$ . We then have  $S_0^{\beta,j}(y,I)$ ,  $u_{0,I}^{\beta,j}(y)$ ,  $v_{0,I}^{\beta,j}(y)$  and  $|\partial E/\partial p_y|^{-1/2}$  to investigate.

#### 4.3.1. Spinor amplitudes

The spinor amplitudes are given by (3.44) with  $\mathbf{v}_s(\mathbf{r}) = 0$  and  $|\Delta(\mathbf{r})| = |\Delta(y)|$  i.e

$$u_{0,I}^\beta(y) = \sqrt{\frac{1}{2} \left( 1 + \frac{\beta \sqrt{E^2 - |\Delta(y)|^2}}{E} \right)}. \quad (4.79)$$

and

$$v_{0,I}^\beta(y) = \sqrt{\frac{1}{2} \left( 1 - \frac{\beta \sqrt{E^2 - |\Delta(y)|^2}}{E} \right)}. \quad (4.80)$$

Equations (4.79) and (4.80) show that the semiclassical expressions for the spinor amplitudes reproduce the familiar form for the SNS junction problem (see for example [28]). Briefly consider the two limiting cases  $|\Delta(y)| \rightarrow 0$ ,

and  $|\Delta(y)| \rightarrow E$ . In the first instance, deep inside the normal layer, the spinor amplitudes corresponding to  $p_y^+$  and  $p_y^-$  are easily seen to be

$$\begin{aligned} \lim_{|\Delta(y)| \rightarrow 0} \begin{pmatrix} u_{0,I}^+(y) \\ v_{0,I}^+(y) \end{pmatrix} &= \begin{pmatrix} 1 \\ 0 \end{pmatrix}, & \text{(particle),} \\ \lim_{|\Delta(y)| \rightarrow 0} \begin{pmatrix} u_{0,I}^-(y) \\ v_{0,I}^-(y) \end{pmatrix} &= \begin{pmatrix} 0 \\ 1 \end{pmatrix}, & \text{(hole),} \end{aligned}$$

so that the spinor amplitude for the particle-like excitation, corresponding to the momentum branch  $p_y^+(y)$  is  $\begin{pmatrix} 1 \\ 0 \end{pmatrix}$ , and for  $p_y^-(y)$ , it is  $\begin{pmatrix} 0 \\ 1 \end{pmatrix}$ . Notice then that particle- and hole-like excitations decouple in the normal layer, as is to be expected. An excitation is either particle or hole, not a mixture. In the second limit,  $|\Delta(y)| \rightarrow E$ , we have

$$\begin{aligned} \lim_{|\Delta(y)| \rightarrow E} \begin{pmatrix} u_{0,I}^+(y) \\ v_{0,I}^+(y) \end{pmatrix} &= \begin{pmatrix} \frac{1}{\sqrt{2}} \\ \frac{1}{\sqrt{2}} \end{pmatrix}, \\ \lim_{|\Delta(y)| \rightarrow E} \begin{pmatrix} u_{0,I}^-(y) \\ v_{0,I}^-(y) \end{pmatrix} &= \begin{pmatrix} \frac{1}{\sqrt{2}} \\ -\frac{1}{\sqrt{2}} \end{pmatrix}. \end{aligned}$$

Thus at the turning point an excitation is an equal mixture of particle and hole. If we assign an effective charge  $e^*(y) = e(u_{0,I}^2(y) - v_{0,I}^2(y))$  to a given spinor then a particle-like excitation has  $e^*(y) > 0$ , a hole-like excitation has  $e^*(y) < 0$  and at the turning point  $e^*(y) = 0$ . (Recall that charge is not a good quantum number in a superconductor.) As a final comment, notice that for  $|\Delta(y)| > E$ ,  $u_{0,I}^\beta(y)$  and  $v_{0,I}^\beta(y)$  become complex conjugates. This coincides with the momenta  $p_y^\beta(y)$  becoming complex.

#### 4.3.2. The velocity dependent amplitude

The wave function (4.77) contains not only the position dependent particle and hole amplitudes  $u_{0,I}^\beta(y)$  and  $v_{0,I}^\beta(y)$ , but also the overall amplitude  $(\partial E / \partial p)^{-1/2}$ . We have

$$\left( \frac{\partial E(\mathbf{p}, y)}{\partial p_y} \right)_{p_y = p_y^\beta(y)}^{-1/2} = \frac{E^{1/2}}{\sqrt[4]{E^2 - |\Delta(y)|^2}} \frac{m^{1/2}}{\sqrt{p_y^\beta(y)}}. \quad (4.81)$$

Here the  $\sqrt{p_y^\beta(y)}$ , familiar from semiclassical theory for one component systems, is supplemented by another term. For the SNS junction we again consider the two limits  $|\Delta(y)| \rightarrow 0$  and  $|\Delta(y)| \rightarrow E$ . In the first instance we have

$$\lim_{|\Delta(y)| \rightarrow 0} \left( \frac{\partial E(\mathbf{p}, y)}{\partial p_y} \right)_{p_y = p_y^\beta(y)}^{-1/2} = \frac{m^{1/2}}{\sqrt{p_y^\beta(y)}},$$

so that a particle-like excitation has an amplitude inversely proportional to the square root of the particle momentum, and the hole-like excitation similarly depends upon the hole momentum. In the second limit as the excitation approaches the interface  $(\partial E/\partial p)^{-1/2}$  diverges, despite  $p_y^\beta(y) \neq 0$ , due to the  $(E^2 - |\Delta(y)|^2)^{-1/4}$  dependence. This divergence signals the breakdown of the semiclassical approximation for the wave function when we are too close to the turning points (i.e., caustics) at which the velocity goes to zero.

#### 4.3.3. The action $S_0^{\beta,j}$

The action appearing in (4.77) is given by the integral of the appropriate momentum branch. We have

$$S_0^{\beta,j}(y) = j \int_{y_0}^y dy' p_y^\beta(y'), \quad (4.82)$$

where  $j = \pm$  gives the sign of the momenta, and  $\beta$  as usual distinguishes the branches  $p_y^+$  and  $p_y^-$ . The lower limit  $y_0$  is an arbitrary constant called the phase reference point.

Although the amplitudes  $u_{0,I}^\beta(y)$ ,  $v_{0,I}^\beta(y)$ , and  $(\partial E/\partial p)^{-1/2}$  acquire their normal state forms as  $|\Delta(y)| \rightarrow 0$ , the action (4.82), being an integrated quantity, retains a ‘memory’ of the interface region encountered by the quasiparticle.

If we consider the form of  $S_0^{\beta,j}(y)$  inside the superconductor ( $|\Delta(y)| > E$ ) then the momenta,  $p_y^\beta(y)$ , become complex and the action correspondingly has both a real and imaginary part:

$$S_0^{\beta,j}(y) = j \int_{y_0}^y dy' p_y^r(y') + i(j\beta) \int_{y_0}^y dy' p_y^i(y'), \quad (4.83)$$

where  $p_y^r$  and  $p_y^i$  are the real and imaginary parts of the momenta.

#### 4.4. Derivation of the quantisation condition and determination of the Maslov index

We now construct a specific solution. In all that follows we will concentrate upon the  $y$ -dependence of the wave functions (i.e., we will drop the plane wave factors for the  $x$  and  $z$  directions since they play no rôle in this derivation). As a consequence of (4.83) the wave function in the superconducting region is comprised of only those solutions which satisfy the physical boundary conditions, decaying as  $y \rightarrow \pm\infty$ . Let us label the three distinct regions of the SNS junction A, B, C FIG. 6 where B is the ‘classical’ region  $y_- < y < y_+$ . Then in region A the wave function will consist of solutions which decay as  $y \rightarrow -\infty$ . These contain the terms

$$\exp\left(\pm \frac{i}{\hbar} \int_y^{y_-} dy' p_y^r(y')\right) \exp\left(-\frac{1}{\hbar} \int_y^{y_-} dy' p_y^i(y')\right), \quad (\text{region A}) \quad (4.84)$$

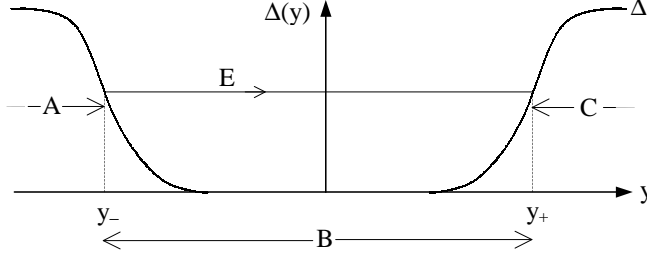

**FIG. 6** The classically forbidden regions, A, C, and the classically allowed region B for an excitation confined by  $\Delta(y)$ .

where  $p_y^i(y) \geq 0$  and the phase reference point has been taken to be  $y_-$ . Similarly in region C solutions will contain the terms

$$\exp\left(\pm \frac{i}{\hbar} \int_{y_{\pm}}^y dy' p_y^r(y')\right) \exp\left(-\frac{1}{\hbar} \int_{y_{\pm}}^y dy' p_y^i(y')\right), \quad (\text{region C}) \quad (4.85)$$

where now the phase reference point is  $y_+$ . Finally, in region B, the eigenfunction will consist of a superposition of all four solutions corresponding to the four actions  $S_0^{\beta,j}(y)$  (4.82), one for each of the classical momentum branches displayed previously in figure 4.

Let us write the appropriate superposition in each region as  $\Psi_A^-$  (phase reference  $y_-$ ),  $\Psi_B^-$ ,  $\Psi_B$  (phase reference  $y_+$ ), and  $\Psi_C$ . Our asymptotic solutions are only valid away from the turning points at  $y_{\pm}$ . We match  $\Psi_C \rightarrow \Psi_B$  and  $\Psi_B^- \rightarrow \Psi_A^-$  by analytically continuing our solutions into the complex coordinate plane in order to circumvent  $y_{\pm}$ . The interested reader is referred to Appendix C for the technical details. Here we summarise the results. Starting from a complex evanescent solution satisfying the boundary conditions at  $y = +\infty$

$$\begin{aligned} \Psi_C(y) = & \frac{A}{\sqrt{\left(\frac{\partial E}{\partial p_y}\right)_{p_y^+(y)}}} \begin{pmatrix} u_{0,I}^+(y)e^{+i\phi/2} \\ v_{0,I}^+(y)e^{-i\phi/2} \end{pmatrix} e^{+\frac{i}{\hbar} \int_{y_+}^y p_y^r(y') dy'} e^{-\frac{1}{\hbar} \left| \int_{y_+}^y p_y^i(y') dy' \right|} \\ & + \frac{B}{\sqrt{\left(\frac{\partial E}{\partial p_y}\right)_{p_y^-(y)}}} \begin{pmatrix} u_{0,I}^-(y)e^{+i\phi/2} \\ v_{0,I}^-(y)e^{-i\phi/2} \end{pmatrix} e^{-\frac{i}{\hbar} \int_{y_+}^y p_y^r(y') dy'} e^{-\frac{1}{\hbar} \left| \int_{y_+}^y p_y^i(y') dy' \right|}, \end{aligned} \quad (4.86)$$

we follow a contour in the upper half of the complex plane around  $y_+$  to

obtain

$$\begin{aligned}
\Psi_B(y) &= \frac{1}{\sqrt{\left(\frac{\partial E}{\partial p_y}\right)_{p_y^+(y)}}} \begin{pmatrix} u_{0,I}^+(y)e^{+i\phi/2} \\ v_{0,I}^+(y)e^{-i\phi/2} \end{pmatrix} \times \\
&\quad \times \left( Ae^{-\frac{i}{\hbar} \int_y^{y_+} p_y^+(y') dy'} - iBe^{+\frac{i}{\hbar} \int_y^{y_+} p_y^+(y') dy'} \right) \\
&+ \frac{1}{\sqrt{\left(\frac{\partial E}{\partial p_y}\right)_{p_y^-(y)}}} \begin{pmatrix} u_{0,I}^-(y)e^{+i\phi/2} \\ v_{0,I}^-(y)e^{-i\phi/2} \end{pmatrix} \times \\
&\quad \times \left( Be^{+\frac{i}{\hbar} \int_y^{y_+} p_y^-(y') dy'} - iAe^{-\frac{i}{\hbar} \int_y^{y_+} p_y^-(y') dy'} \right), \\
\end{aligned} \tag{4.87}$$

for  $y_- < y < y_+$ , and continuing around  $y_-$  we find

$$\begin{aligned}
\Psi_A^-(y) &= \frac{B}{\sqrt{\left(\frac{\partial E}{\partial p_y}\right)_{p_y^-(y)}}} \begin{pmatrix} u_{0,I}^-(y)e^{+i\phi/2} \\ v_{0,I}^-(y)e^{-i\phi/2} \end{pmatrix} \left( e^{\frac{i}{\hbar} \int_{y_-}^{y_+} p_y^+(y') dy'} + e^{\frac{i}{\hbar} \int_{y_-}^{y_+} p_y^-(y') dy'} \right) \\
&\quad \times e^{\frac{i}{\hbar} \int_y^{y_-} p_y^r(y') dy'} e^{+\frac{1}{\hbar} \left| \int_y^{y_-} p_y^i(y') dy' \right|} \\
&- \frac{iA}{\sqrt{\left(\frac{\partial E}{\partial p_y}\right)_{p_y^-(y)}}} \begin{pmatrix} u_{0,I}^-(y)e^{+i\phi/2} \\ v_{0,I}^-(y)e^{-i\phi/2} \end{pmatrix} e^{-\frac{i}{\hbar} \int_{y_-}^{y_+} p_y^-(y') dy'} e^{-\frac{i}{\hbar} \int_y^{y_-} p_y^r(y') dy'} \\
&\quad \times e^{-\frac{1}{\hbar} \left| \int_y^{y_-} p_y^i(y') dy' \right|} \\
&- \frac{iB}{\sqrt{\left(\frac{\partial E}{\partial p_y}\right)_{p_y^+(y)}}} \begin{pmatrix} u_{0,I}^+(y)e^{+i\phi/2} \\ v_{0,I}^+(y)e^{-i\phi/2} \end{pmatrix} e^{+\frac{i}{\hbar} \int_{y_-}^{y_+} p_y^+(y') dy'} e^{+\frac{i}{\hbar} \int_y^{y_-} p_y^r(y') dy'} \\
&\quad \times e^{-\frac{1}{\hbar} \left| \int_y^{y_-} p_y^i(y') dy' \right|} \\
&+ \frac{A}{\sqrt{\left(\frac{\partial E}{\partial p_y}\right)_{p_y^+(y)}}} \begin{pmatrix} u_{0,I}^+(y)e^{+i\phi/2} \\ v_{0,I}^+(y)e^{-i\phi/2} \end{pmatrix} \left( e^{-\frac{i}{\hbar} \int_{y_-}^{y_+} p_y^+(y') dy'} + e^{-\frac{i}{\hbar} \int_{y_-}^{y_+} p_y^-(y') dy'} \right) \\
&\quad \times e^{-\frac{i}{\hbar} \int_y^{y_-} p_y^r(y') dy'} e^{+\frac{1}{\hbar} \left| \int_y^{y_-} p_y^i(y') dy' \right|}, \\
\end{aligned} \tag{4.88}$$

for  $y < y_-$ . (The spinor and square root prefactors in  $\Psi_A^-$  and  $\Psi_C$  which are complex can be found in appendix C, equation (C.188).) To satisfy the

boundary condition at  $y = -\infty$  that our solution vanishes, the coefficients of the first and fourth terms of  $\Psi_A^-(y)$  must be zero, i.e.

$$e^{\frac{i}{\hbar} \int_{y-}^{y+} p_y^+(y') dy'} - \frac{i}{\hbar} \int_{y-}^{y+} p_y^-(y') dy' = e^{i\pi(2n+1)}.$$

Our quantisation condition is then

$$\frac{1}{\hbar} \int_{y-}^{y+} p_y^+(y') - p_y^-(y') dy' = 2\pi \left( n + \frac{1}{2} \right), \quad (4.89)$$

which is precisely the quantisation rule used earlier (equation (4.72)) to derive the spectrum of Andreev quasiparticles. We have also proved that the Maslov index is  $m = 2$  (valid for quasiparticles bound by a smoothly varying order parameter,  $|\Delta(y)|$ ).

## 5. THE SINGLE VORTEX

The single vortex is an ideal problem to demonstrate how our semiclassical theory works since, as will be seen below, both the topological phase and the  $\hbar$ -dependence of the Hamiltonian play important rôles. We will also (in an accompanying appendix) be able to make a direct comparison between the two semiclassical theories.

The order parameter for a single vortex in a cylindrical coordinate system takes the form

$$\Delta(\mathbf{r}) = |\Delta(r)|e^{-i\theta},$$

where the radial profile  $|\Delta(r)|$  is shown in FIG. 7. Since [1]

$$\frac{e\mathbf{A}(\mathbf{r})}{\hbar\nabla\phi} \sim \frac{B}{B_{c2}} \ll 1,$$

for  $r \lesssim \xi$ , in this regime

$$m\mathbf{v}_s(\mathbf{r}) = \frac{\hbar\nabla\phi}{2} = -\frac{\hbar}{2r}\hat{\theta},$$

i.e. the rôle of the superfluid is *entirely* represented through this  $\hbar$ -dependent term. Notice, since  $\mathbf{A}(\mathbf{r}) \cong 0$  the classical dynamics governed by  $E_0^\alpha(\mathbf{p}_0, \mathbf{r})$  is not influenced by the superfluid flow, whose rôle appears in a non-zero phase  $S_1^{\alpha,j}(\mathbf{r})$ . However the classical dynamics governed by  $E^\alpha(\mathbf{p}, \mathbf{r})$  does include the influence of  $\mathbf{v}_s(\mathbf{r})$ . It is the latter which we investigate here.

As already discussed,  $\hbar\nabla\phi/2e$  can be interpreted as the vector potential associated with a line of phase singularities which in the present case runs along the  $z$ -axis carrying a flux,  $\Phi_0$ , from positive to negative  $z$ . From this vantage point we now investigate the behaviour of quasiparticles in the presence of a vortex.



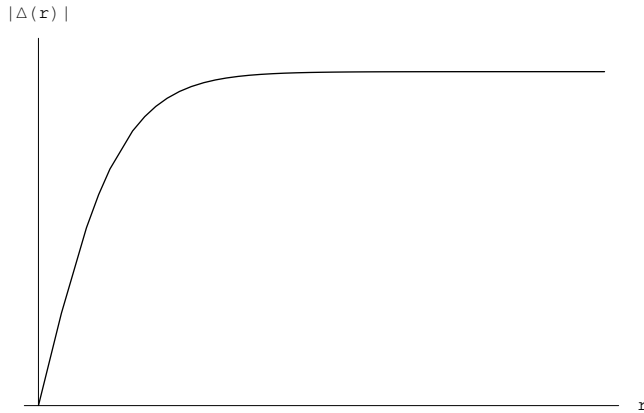

**FIG. 7** Profile of radial dependence of  $\Delta(\mathbf{r})$

We follow Caroli, de Gennes and Matricon [29] by seeking a solution to the positive angular momentum branch of the spectrum, i.e. we take  $p_\theta \geq 0$ . Since then only  $E^+(\mathbf{p}, \mathbf{r}) \geq 0$  our Hamiltonian describing the quasiparticle-hole excitations is

$$E^+(p_r, p_\theta, p_z, r) = -\frac{p_\theta \hbar}{2mr^2} + \sqrt{\left(\frac{p_r^2}{2m} + \frac{p_\theta^2 + \hbar^2/4}{2mr^2} + \frac{p_z^2}{2m} - \epsilon_F\right)^2 + |\Delta(r)|^2}. \quad (5.90)$$

Since it does not depend upon  $\theta$  or  $z$ ,  $p_\theta$  and  $p_z$  are cyclic variables (constants of the motion).  $p_z$  is a continuous variable but  $p_\theta$  must be quantised.

### 5.1. $p_\theta$ quantisation

We apply the generalised EBK quantisation rule (3.59) to a path encircling the origin. For this path the Maslov index is zero, due to the fact that there are no turning points, but the topological phase associated with the vortex (3.58) is important:

$$\frac{1}{\hbar} \int_0^{2\pi} p_\theta d\theta = 2\pi \left( \nu - \frac{m^\phi}{2} \right),$$

where  $\nu$  and  $m^\phi$  are integers. Writing  $p_\theta = \hbar\mu$ ,  $\mu$  an angular momentum quantum number, and using  $m^\phi = \frac{1}{2\pi} \oint \nabla\phi \cdot d\mathbf{r} = -1$ , we find

$$\mu = \nu + \frac{1}{2}, \quad \nu = 0, 1, 2, \dots$$

The topological phase forces  $\mu$  to be *half integer*. This agrees with the classic work of Caroli, de Gennes and Matricon [29] who obtained the result in a very different way, namely by matching wave functions.

From our present vantage point we see that the effect of the half-flux flowing along the  $z$ -axis string is to give both particles and holes an angular momentum ‘kick’.

## 5.2. Radial behaviour of the excitation orbits

Setting  $E = E^+(p_r, p_\theta, p_z, r)$  and inverting, the radial momentum branches are found to be

$$p_r^\pm(r) = \sqrt{p_F^2 - p_z^2 - \frac{\hbar^2(\mu^2 + 1/4)}{r^2} \pm 2m\sqrt{\left(E + \frac{\hbar^2\mu}{2mr^2}\right)^2 - |\Delta(r)|^2}}, \quad (5.91)$$

the  $\pm$  corresponding to particle-like or hole-like excitations respectively. Notice the effect upon  $p_r^\pm(r)$  of having  $\hbar\nabla\phi/2$  in the Hamiltonian is to introduced the two new terms  $\hbar^2/4r^2$  and  $\hbar^2\mu/r^2$ .

FIG. 8 shows the radial form of the orbit. One should notice the fol-

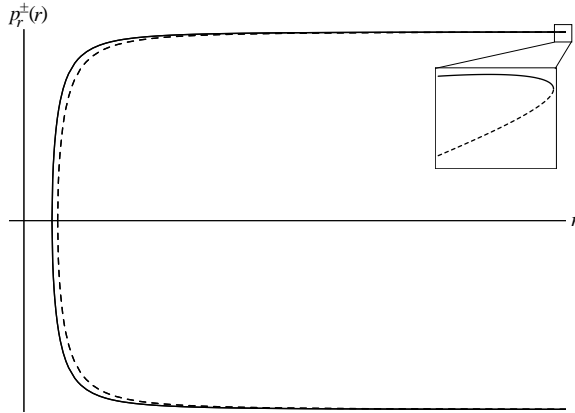

**FIG. 8**  $p_r^\pm(r)$  as a function of  $r$ . Solid line denotes a particle-like branch, a broken line a hole-like branch. The inset shows an enlarged view of the turning point where Andreev reflection occurs.

lowing features: (i) The complete orbit is comprised of both particle-like and hole-like segments. (ii) As  $r \rightarrow 0$  both  $p_r^\pm(r) \rightarrow 0$  i.e. we have classical

turning points. Since, by Hamilton's equations,

$$\dot{r}^\pm = \pm \frac{\sqrt{(E + \hbar^2 \mu / 2mr^2)^2 - |\Delta(r)|^2}}{E} \frac{p_r^\pm(r)}{m},$$

for  $p_r^\pm(r) > 0$  we have  $\dot{r}^+ > 0$  and  $\dot{r}^- < 0$  i.e. upon the positive quasiparticle branch the excitation is moving away from the vortex core whilst along the positive quasihole branch it is moving towards the vortex core. (iii) As the excitation propagates into the superconductor the velocity becomes zero at a point,  $r_d$ , defined by

$$\sqrt{(E + \hbar^2 \mu / 2mr_d^2)^2 - |\Delta(r_d)|^2} = 0, \quad (5.92)$$

and beyond this point  $p_r^\pm$  become *complex*. Thus  $r_d$  is also a turning point. However since  $p_r^+(r_d) = p_r^-(r_d)$ ,  $r_d$  is the point at which a particle-like excitation converts smoothly into a hole-like excitation (see inset in Fig. 8).

### 5.3. Calculating the semiclassical spectrum

Our general quantisation rule for the radial momentum reads:

$$\oint p_r^\beta(r) dr = 2\pi\hbar \left( n + \frac{m}{4} \right), \quad (5.93)$$

where  $\beta = \pm$ .  $p_r^\beta(r)$  stands for the appropriate branches of the momentum along the orbit in Fig. 8. (The Maslov index is  $m = 2$  since the orbit is topologically a circle.) In general we cannot obtain an analytic solution to the integral in equation (5.93). None the less we can make some headway by using a simple model for the profile of  $\Delta$  which retains the essential physics.

#### 5.3.1. Model step profile for $|\Delta(r)|$

The model we adopt replaces the profile shown in Fig. 7 with a step profile. In particular we take:

$$|\Delta(r)| = \begin{cases} 0, & r \leq \xi, \\ \Delta_\infty & r > \xi, \end{cases} \quad (5.94)$$

where  $\xi$  is a length scale characterising the distance over which  $|\Delta(r)|$  rises, i.e. represents the vortex core. For instance we might take it to be the BCS coherence length  $\xi_0 = \hbar v_F / \pi \Delta_\infty$ , but we need not do this. (We have in mind here the work of Gygi and Schlüter [30] who have shown that  $\xi \ll \xi_0$  as the temperature approaches zero, and indeed can end up comparable with the atomic spacing.)

Our model has the following features for the bound states  $E < \Delta_\infty$ : (i) when  $|\Delta(r)| = \Delta_\infty$  the solution of equation (5.92) for the turning point is

$$r_d = \frac{\hbar\mu^{1/2}}{\sqrt{2m(\Delta_\infty - E)}}.$$

We note that  $r_d \rightarrow \infty$  for  $\mu \rightarrow \infty$  or  $E \rightarrow \Delta_\infty$ , i.e a bound excitation with in a high angular momentum state can in principle propagate far inside the superconductor. (ii) when  $|\Delta(r)| = 0$  the only natural turning point encountered away from the core is set by  $\xi$ . Thus all excitations for which  $r_d < \xi$  are confined to the vortex core turning around at  $\xi$ , whilst those which have  $r_d \geq \xi$  penetrate into the bulk of the superconductor, turning around at  $r_d(\mu)$ .

### 5.3.2. Calculation of EBK integrals and Spectrum

(i) For excitations confined to the core the  $p^\pm(r)$  simplify to

$$p_r^\pm(r) = \sqrt{p_F^2 - p_z^2 - \frac{\hbar^2(\mu \mp 1/2)^2}{r^2}} \pm 2mE. \quad (5.95)$$

Integrals of these functions can be done exactly in terms of elementary functions. Thus the integral in (5.93) becomes

$$\oint p_r^\beta(r) dr = \sum_{\beta=\pm} \beta 2\hbar \left( \mu - \beta \frac{1}{2} \right) \times \\ \times \left[ \sqrt{(\xi/L_\beta)^2 - 1} - \arctan \sqrt{(\xi/L_\beta)^2 - 1} \right],$$

where the length,  $L_\beta$ , is defined to be

$$L_\beta = \frac{\hbar \left( \mu - \beta \frac{1}{2} \right)}{\sqrt{p_F^2 \sin^2 \alpha + \beta 2mE}}.$$

Here we introduced the angle  $\alpha$  through  $p_z = p_F \cos \alpha$ . ( $\alpha = 0$  or  $\pi$  corresponds to the excitation travelling along the direction of the vortex axis.) Excluding excitations with high angular momentum or large  $p_z$  ( $\sin \alpha \rightarrow 0$ ), we see this length scale is small compared to  $\xi$ . Thus, for  $(\xi/L_\beta)^2 \gg 1$ , we expand our result to find

$$\oint p_r^\beta(r) dr = \sum_{\beta=\pm} \beta 2\hbar \left( \mu - \beta \frac{1}{2} \right) \times \\ \times \left[ \frac{\xi}{L_\beta} - \frac{\pi}{2} + \frac{L_\beta}{2\xi} + \mathcal{O}((L_\beta/\xi)^3) \right]. \quad (5.96)$$

The energy, entering into this expression through  $L_\beta$ , is quantised using equation (5.93). Taking the first two terms in (5.96), and seeking the energy in the form  $E = E_0 + E_1 + \dots$  we find for  $E_0$

$$E_0 = \frac{\pi \hbar v_F |\sin \alpha|}{2\xi} \left( n + \frac{m}{4} - \frac{1}{2} \right). \quad (5.97)$$

Here we have used  $E \ll p_F^2 \sin^2 \alpha / 2m$ , so that our result is valid for states whose kinetic energy along the field direction is small. (This is consistent with the above approximations.)

We are interested in bound states for which  $E < \Delta_\infty$ . To see how large  $E_0$  is we substitute into (5.97) with  $\xi_0 = \hbar v_F / \pi \Delta_\infty$  and find (remember  $m = 2$ )

$$E_0 = \frac{\pi^2}{2} \Delta_\infty |\sin \alpha| n. \quad (5.98)$$

For states with  $\sin \alpha \sim 1$  only the  $n = 0$  quantum number corresponds to a bound excitation. (This agrees with the findings of Bardeen, Kümmel, Jacobs and Tewordt [5].) Notice our result becomes stronger for  $\xi < \xi_0$ , although for states with a large  $p_z$  component new branches to the spectrum ( $n > 0$ ) may appear. Thus to describe the low lying excitations in the vortex we must take  $n = 0$  and seek the next order correction to the energy,  $E_1$ . Including the  $L_\beta/2\xi$  terms from (5.96), which should be evaluated at  $E = E_0 = 0$ , we find

$$E_1 = \mu \frac{\hbar^2}{2m\xi^2}. \quad (5.99)$$

In particular, for  $\xi = \xi_0$ , the excitation spectrum becomes

$$E = \left( \frac{\pi}{2} \right)^2 \mu \frac{\Delta_\infty^2}{\epsilon_F}. \quad (5.100)$$

We have recovered the famous Caroli, de Gennes, Matricon states [29] of low lying excitations confined to a vortex core which however were found by matching wave functions.

As well as reproducing the excitation spectrum one can also show (see appendix D) that the radial behaviour of the semiclassical wave functions reproduces the correct  $r$ -behaviour near the origin where the exact result was also given by Caroli, de Gennes and Matricon [29].

(ii) Now we turn our attention to states which penetrate into the bulk of the superconductor. For  $\xi < r < r_d$  we must add to our integral a further contribution with  $\Delta(r) = \Delta_\infty$ . In this region  $p^\pm(r)$  are

$$p^\pm(r) = \sqrt{p_F^2 - p_z^2 - \frac{\hbar^2(\mu^2 + 1/4)}{r^2} \pm 2m \sqrt{\left( E + \frac{\hbar^2 \mu}{2mr^2} \right)^2 - \Delta_\infty^2}}. \quad (5.101)$$

The analytic calculation of integrals of nested square root functions is very complicated. For example the Riemann surface upon which  $p^+(r)$  (as defined by (5.101)) is single valued has the topology of a sphere with 5 handles! The problem of evaluating a quantisation rule written as a line integral can be transformed into evaluating contour integrals on these Riemann surfaces. In general, and in the example shown, the answer is not expressible in terms of either elementary or Elliptic functions. The integrals are however rather easy to evaluate numerically. This we have done and quantised the areas to obtain the spectrum,  $E(\mu)$ . The result is shown in figures 9 and 10.

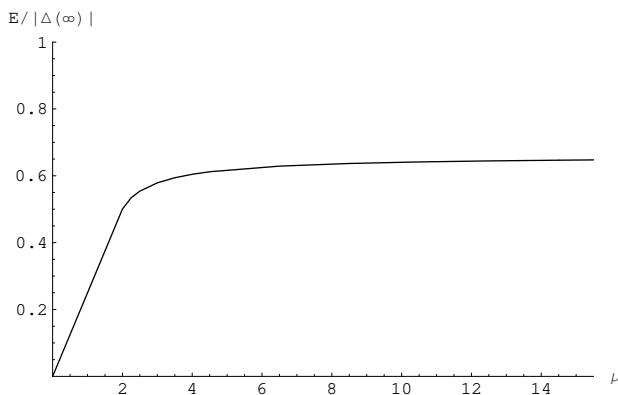

**FIG. 9**  $E(\mu)$  flattens off as  $\mu$  increases.

Observe that whilst for small  $\mu$  the spectrum increases steeply that once the excitation starts to penetrate the superconducting bulk it ‘feels’ less confined and hence  $E$  flattens off. Only very high angular momentum states have their energy approaching  $\Delta_\infty$ .

As stated above, the small  $\mu$  behaviour of  $E(\mu)$  agrees with the work of Caroli, de Gennes and Matricon [29], and now we also see that the global behaviour of  $E(\mu)$  is in agreement with the general findings of Bardeen, Kümmel, Jacobs and Tewordt [5]. However our method of solution differs substantially from the work of these authors.

## 6. SUMMARY AND DISCUSSION

In this paper we have developed a semiclassical theory for quasiparticles in superconductors. In doing so we have pushed semiclassical methods to the limit by constructing a (fictitious) classical mechanics describing the orbits of quasiparticles propagating in the presence of lines of phase singularities. Adopting this approach enabled us to bring the full machinery of

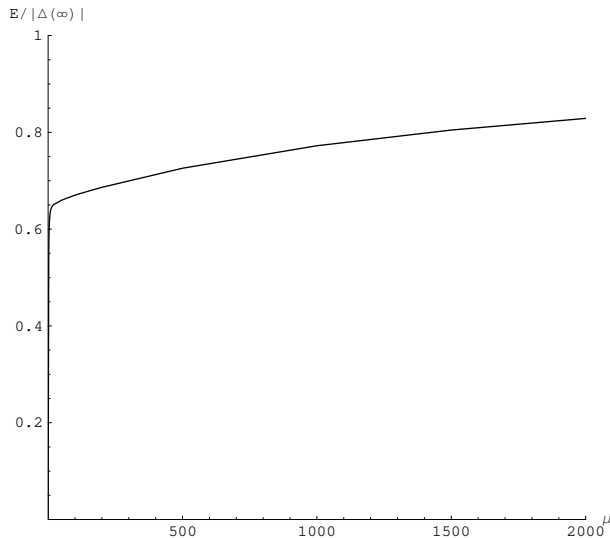

**FIG. 10**  $E(\mu)$  tends towards  $\Delta_\infty$  for very large angular momentum.

modern semiclassics to the problem. In particular we used torus quantisation to construct a generalised EBK quantisation rule for determining the semiclassical spectrum. This rule included both the Maslov index, familiar from modern semiclassics, and a topological integer arising due to the global curvature of the space in which the quasiparticles propagate. The latter is a direct consequence of phase singularities of the pairing potential, i.e., vortices. The power of this approach, first considered by Azbel' in the superconducting context, and extended by us here, lies in the general nature of the Hamiltonian system we have constructed. Unlike the approach of other authors [1, 2, 5] where one must return to the BdG equations for each new problem and consider solving the differential equation across various length scales, here our starting point is with the Hamiltonians, (3.41), and Hamilton's equations of motion. Once the pairing potential, vector potential and crystal lattice potential have been chosen for the problem at hand one can immediately investigate the quasiparticle orbits. In the case where the classical dynamics is integrable one can then proceed, via the generalised EBK rule, to quantise the quasiparticle motion. To make this possible a number of technical challenges needed to be overcome. Most important amongst these was the observation that 'standard' semiclassics (i.e., asymptotics in the small parameter  $\hbar$ ) does not, in the multicomponent case, lead to the construction of a generalised EBK rule. We resolved this problem by constructing a new semiclassical theory whose correspond-

ing Hamiltonian system contains  $\hbar$ -dependent terms. For such a system, as we have shown, a generalised EBK quantisation rule does exist. We demonstrated the power of our approach by solving two well known problems chosen to elucidate those aspects of the theory which are new ( $\hbar$ -dependent Hamiltonians and topological phases due to vortices). Of course the problems we have considered have integrable classical dynamics. However there are many situations one may wish to solve where the classical dynamics is non-integrable. Thus we should examine which aspects of our theory remain valid in this case.

When our Hamiltonian system exhibits chaos our corresponding (stationary) Hamilton-Jacobi equation has no solution, i.e., the eigenstates of the BdG equations cannot have the ‘simple’ multicomponent WKB form. Since our ‘classical’ mechanics was derived in the first place using this ansatz for the wave function one must question whether the Hamiltonian system has any meaning for non-integrable systems. The answer is yes and the reason is as follows. If we start with the time-dependent BdG equations, (replace  $E_\lambda$  by  $i\hbar\partial/\partial t$  in (2.1)), and seek a solution in terms of a time-dependent multicomponent WKB ansatz, then we obtain, in place of the stationary Hamilton-Jacobi equation, the time dependent Hamilton-Jacobi equation:

$$E^\alpha(\nabla S(\mathbf{r}, t), \mathbf{r}) + \frac{\partial S}{\partial t} = 0. \quad (6.102)$$

A solution to this equation always exists unlike for the stationary version. The Hamiltonian system corresponding to (6.102) is identical to the one for the stationary equation and thus we have discovered our (fictitious) classical mechanics is the correct one to describe quasiparticle dynamics in superconductors regardless of the type of the dynamics exhibited. (The same cannot be said of our eigenfunction (3.56), and the generalised EBK rule neither of which have any meaning in chaotic systems for which trace formulae must be derived [6].)

One of our principle motivations for developing the semiclassical theory was to construct a microscopic theory of quasiparticles in superconductors in large magnetic fields. Under such conditions the groundstate of a Type II superconductor adopts a so called Abrikosov flux lattice state [27]. This is a regular lattice of vortices, each carrying one superconducting flux quantum,  $\Phi_0$ , and having supercurrents associated with it. We have developed a simplified model of this state [31, 32, 33], whose dynamics is integrable, and have used it to give an explanation of the origin of de Haas-van Alphen oscillations in Type II superconductors.

Another problem for which the above strategy may be usefully deployed is that of the mesoscopic metals proximity coupled a superconductor. The refined semiclassics we have presented here may serve as a bases for including ‘quantum diffraction’ corrections missing from the naive analysis criticised by Altland, Simons and Taras-Semchuk [34].



Finally we point out that the theory we have presented is restricted to  $s$ -wave pairing. An ongoing ‘hot-topic’ in superconductivity research is exotic superconductivity, in particular  $d$ - and  $p$ - wave pairing. We are in the process of extending our present theory to encompass exotic pairing so that we may study quasiparticle orbits in the presence of  $d$ - and  $p$ -wave pairing potentials in magnetic fields.

## APPENDIX A: APPROPRIATE LABELS FOR THE ZEROth ORDER AMPLITUDES

Our zeroth order spinor amplitudes contain  $\beta = \pm$  which are determined uniquely by  $j$  as follows: For a given branch  $\mathbf{p}_0^j(\mathbf{r})$  of the multivalued momentum function we calculate the left hand side of

$$\frac{\mathbf{p}_0^2}{2m} + \frac{1}{2}m\mathbf{v}_0^2 + V(\mathbf{r}) - \epsilon_F = \beta\sqrt{(E_{\mathbf{I}}^\alpha - \mathbf{p}_0 \cdot \mathbf{v}_0)^2 - |\Delta(\mathbf{r})|^2}. \quad (\text{A.103})$$

Denote this quantity by  $T(\mathbf{p}_0^j)$ . Then if  $T > 0$ ,  $\beta = +$ , whilst for  $T < 0$ ,  $\beta = -$ . In this way each  $\mathbf{p}_0^j$  determines a unique choice of  $\beta$ . To give an interpretation to the sign of  $\beta$  we will need the following definition: If

$$\left(u_{0,\mathbf{I}}^{\alpha,j}(\mathbf{r})\right)^2 - \left(v_{0,\mathbf{I}}^{\alpha,j}(\mathbf{r})\right)^2 > 0$$

we call the excitation quasiparticle-like or simply ‘particle-like’, whilst for

$$\left(u_{0,\mathbf{I}}^{\alpha,j}(\mathbf{r})\right)^2 - \left(v_{0,\mathbf{I}}^{\alpha,j}(\mathbf{r})\right)^2 < 0$$

we call the excitation quasihole-like or simply ‘hole-like’. From equation (2.26) we have

$$\left(u_{0,\mathbf{I}}^{\alpha,j}(\mathbf{r})\right)^2 - \left(v_{0,\mathbf{I}}^{\alpha,j}(\mathbf{r})\right)^2 = \beta \frac{\sqrt{(E_{\mathbf{I}}^\alpha - \mathbf{p}_0^j \cdot \mathbf{v}_0)^2 - |\Delta(\mathbf{r})|^2}}{E_{\mathbf{I}}^\alpha - \mathbf{p}_0^j \cdot \mathbf{v}_0}.$$

Noting  $\text{sgn}(E_{\mathbf{I}}^\alpha - \mathbf{p}_0^j \cdot \mathbf{v}_0) = \alpha$  we construct Table 1 to interpret the sign of  $\beta$ . Since, as we have shown,  $\beta$  is determined by  $\mathbf{p}_0^j$  we can similarly interpret a given  $\mathbf{p}_0^j$  as corresponding to ‘particle-like’ or ‘hole-like’ excitation.

## APPENDIX B: DERIVATION OF THE TRANSPORT EQUATION AND OTHER FIRST ORDER QUANTITIES

Instead of expanding equation (2.11) directly we begin by taking its expectation value:

$$\begin{aligned} & \left( \tilde{u}_\lambda^*(\mathbf{r}) \quad \tilde{v}_\lambda^*(\mathbf{r}) \right) \times \\ & \begin{pmatrix} E_\lambda - H(\hat{\mathbf{p}} + \frac{\partial S_0}{\partial \mathbf{r}}, \mathbf{r}) & -|\Delta(\mathbf{r})|e^{i\phi(\mathbf{r})} \\ -|\Delta(\mathbf{r})|e^{-i\phi(\mathbf{r})} & E_\lambda + H^*(\hat{\mathbf{p}} + \frac{\partial S_0}{\partial \mathbf{r}}, \mathbf{r}) \end{pmatrix} \begin{pmatrix} \tilde{u}_\lambda(\mathbf{r}) \\ \tilde{v}_\lambda(\mathbf{r}) \end{pmatrix} \\ & = F^\dagger \hat{D} F = 0, \quad (\text{B.104}) \end{aligned}$$

Hamiltonian System	Amplitude index	Excitation type
$\alpha = +$	$\beta = +$	particle-like
	$\beta = -$	hole-like
$\alpha = -$	$\beta = +$	hole-like
	$\beta = -$	particle-like

TABLE 1  
Identifying the excitation type

where we have introduced  $\hat{D}$  for the matrix differential operator and  $F$  to represent the spinor. Then expanding the result, equation (B.104), upto and including first order in  $\hbar$  we find

$$0 = F_0^\dagger D_0 F_0 + F_1^\dagger D_0 F_0 + F_0^\dagger D_0 F_1 + F_0^\dagger \hat{D}_1 F_0. \quad (\text{B.105})$$

Here the subscripts denote quantities of zeroth or first order in  $\hbar$ .  $D_0$  is the zeroth order Hamiltonian matrix

$$D_0 = \begin{pmatrix} E_{\mathbf{I}} - H_0^e(\mathbf{p}_0, \mathbf{r}) & -|\Delta(\mathbf{r})|e^{i\phi(\mathbf{r})} \\ -|\Delta(\mathbf{r})|e^{-i\phi(\mathbf{r})} & E_{\mathbf{I}} + H_0^h(\mathbf{p}_0, \mathbf{r}) \end{pmatrix}, \quad (\text{B.106})$$

$F_0$  is the by now familiar spinor (2.9),  $\hat{D}_1$  is the first order matrix differential operator, which we have not yet written down explicitly, but what is  $F_1$ ?  $F_1$  is the spinor obtained by going beyond the first two terms in the expansion of  $S(\mathbf{r})$  and  $\Sigma(\mathbf{r})$ , equations (2.6) and (2.7). Thus the wave function written to include the next order terms is

$$\begin{aligned} \begin{pmatrix} u_{\mathbf{I}}(\mathbf{r}) \\ v_{\mathbf{I}}(\mathbf{r}) \end{pmatrix} &= \begin{pmatrix} \tilde{u}_{\mathbf{I}}(\mathbf{r})e^{i\hbar\Sigma_2(\mathbf{r})} \\ \tilde{v}_{\mathbf{I}}(\mathbf{r})e^{-i\hbar\Sigma_2(\mathbf{r})} \end{pmatrix} e^{i\hbar S_2(\mathbf{r})} e^{iS_0(\mathbf{r})/\hbar} \\ &= \begin{pmatrix} \tilde{u}_{\mathbf{I}}(\mathbf{r}) \\ \tilde{v}_{\mathbf{I}}(\mathbf{r}) \end{pmatrix} e^{iS_0(\mathbf{r})/\hbar} + \begin{pmatrix} \tilde{u}_{\mathbf{I}}(\mathbf{r}) (+i\hbar\Sigma_2(\mathbf{r}) + i\hbar S_2(\mathbf{r})) \\ \tilde{v}_{\mathbf{I}}(\mathbf{r}) (-i\hbar\Sigma_2(\mathbf{r}) + i\hbar S_2(\mathbf{r})) \end{pmatrix} e^{iS_0(\mathbf{r})/\hbar}, \\ &= F_0 e^{iS_0(\mathbf{r})/\hbar} + F_1 e^{iS_0(\mathbf{r})/\hbar}. \end{aligned} \quad (\text{B.107})$$

In (B.107) we used  $\exp(i\hbar\Sigma_2) \approx 1 + i\hbar\Sigma_2$ , for  $i\hbar\Sigma_2 \ll 1$  and so on. Turning our attention back to (B.105) we recognise the first term as the zeroth order equation

$$\mathcal{O}(\hbar^0) \quad 0 = F_0^\dagger D_0 F_0, \quad (\text{B.108})$$

and because  $D_0 F_0 = 0$  the second term is also zero. This leaves

$$0 = F_0^\dagger D_0 F_1 + F_0^\dagger \hat{D}_1 F_0.$$

Since  $D_0^\dagger = D_0$ , the first term can, however, be written as

$$F_0^\dagger D_0 F_1 = \left( D_0^\dagger F_0 \right)^\dagger F_1 = (D_0 F_0)^\dagger F_1 = 0.$$

Consequently the expansion of the matrix elements (B.104) gives the first order equation

$$\mathcal{O}(\hbar) \quad 0 = F_0^\dagger \hat{D}_1 F_0. \quad (\text{B.109})$$

In particular notice that  $F_1$ , the  $\mathcal{O}(\hbar)$  correction to the wave function, does not feature in the expansion of the BdG equations up to first order in  $\hbar$  thus justifying the omission of such terms from the spinor elements  $\tilde{u}_\mathbf{I}(\mathbf{r})$  and  $\tilde{v}_\mathbf{I}(\mathbf{r})$  in (2.9).

To find the explicit form of  $\hat{D}_1$  we require the order  $\hbar$  terms of  $H(\hat{\mathbf{p}} + \frac{\partial S_0}{\partial \mathbf{r}}, \mathbf{r})$ . Writing  $H$  out we have

$$\begin{aligned} H\left(\hat{\mathbf{p}} + \frac{\partial S_0}{\partial \mathbf{r}}, \mathbf{r}\right) &= \frac{1}{2m} \left( \frac{\hbar}{i} \nabla + \mathbf{P}^+ \right)^2 + V(\mathbf{r}) - \epsilon_F, \\ &= H_0^e(\mathbf{p}_0, \mathbf{r}) + \frac{1}{2m} \left( \frac{\hbar}{i} \nabla \cdot \mathbf{P}^+ + \mathbf{P}^+ \cdot \frac{\hbar}{i} \nabla \right) + \mathcal{O}(\hbar^2), \end{aligned}$$

where  $\mathbf{P}^+ = \frac{\partial S_0}{\partial \mathbf{r}} + e\mathbf{A}(\mathbf{r})$ .  $H^*(\hat{\mathbf{p}} + \frac{\partial S_0}{\partial \mathbf{r}}, \mathbf{r})$  is written in similar fashion by replacing  $\mathbf{P}^+$  with  $\mathbf{P}^- = \frac{\partial S_0}{\partial \mathbf{r}} - e\mathbf{A}(\mathbf{r})$ . Then the matrix  $\hat{D}_1$  takes the form

$$\hat{D}_1 = \begin{pmatrix} -\frac{1}{2m} \left( \frac{\hbar}{i} \nabla \cdot \mathbf{P}^+ + \mathbf{P}^+ \cdot \frac{\hbar}{i} \nabla \right) & 0 \\ 0 & +\frac{1}{2m} \left( \frac{\hbar}{i} \nabla \cdot \mathbf{P}^- + \mathbf{P}^- \cdot \frac{\hbar}{i} \nabla \right) \end{pmatrix}$$

so that equation (B.109) becomes

$$\begin{aligned} F_0^\dagger \left( \begin{array}{c} -\frac{1}{2m} \frac{\hbar}{i} \nabla \cdot \mathbf{P}^+ \\ 0 \end{array} + \begin{array}{c} 0 \\ +\frac{1}{2m} \frac{\hbar}{i} \nabla \cdot \mathbf{P}^- \end{array} \right) F_0 + \\ + F_0^\dagger \left( \begin{array}{c} -\frac{1}{2m} \mathbf{P}^+ \cdot \frac{\hbar}{i} \nabla \\ 0 \end{array} + \begin{array}{c} 0 \\ +\frac{1}{2m} \mathbf{P}^- \cdot \frac{\hbar}{i} \nabla \end{array} \right) F_0 = 0, \end{aligned}$$

and if we then pull out the  $\frac{\hbar}{i} \nabla$  from the first term we obtain

$$\frac{\hbar}{i} \nabla \cdot \left\{ F_0^\dagger \mathbf{M} F_0 \right\} - \frac{\hbar}{i} \left\{ \nabla F_0^\dagger \right\} \cdot \mathbf{M} F_0 + \frac{\hbar}{i} F_0^\dagger \mathbf{M} \cdot \nabla F_0 = 0, \quad (\text{B.110})$$

where the vector matrix  $\mathbf{M}$  is given by

$$\mathbf{M} = \begin{pmatrix} -\frac{\mathbf{P}^+}{2m} & 0 \\ 0 & +\frac{\mathbf{P}^-}{2m} \end{pmatrix}. \quad (\text{B.111})$$

The first term is purely imaginary since the differential operator acts on  $F_0^\dagger F_0 = |F_0|^2$  ( $\mathbf{M}$  being diagonal). The remaining two terms taken together are purely real. To see this we rewrite the middle term in equation (B.110):

$$\begin{aligned} \left\{ \nabla F_0^\dagger \right\} \cdot \mathbf{M} F_0 &= [(\mathbf{M} F_0)^\dagger \cdot (\nabla F_0)]^\dagger, \\ &= \left[ F_0^\dagger \mathbf{M}^\dagger \cdot \nabla F_0 \right]^\dagger, \end{aligned}$$

but since  $\mathbf{M} = \mathbf{M}^\dagger$  the last two terms in equation (B.110) take the form

$$-\frac{\hbar}{i} \left[ F_0^\dagger \mathbf{M} \cdot \nabla F_0 \right]^\dagger + \frac{\hbar}{i} \left[ F_0^\dagger \mathbf{M} \cdot \nabla F_0 \right] = \frac{\hbar}{i} 2i \operatorname{Im} \left[ F_0^\dagger \mathbf{M} \cdot \nabla F_0 \right],$$

which is certainly real. Equation (B.110) can therefore be separated into two equations which given explicitly are

$$\mathcal{O}(\hbar) \quad \nabla \cdot \left\{ \begin{pmatrix} \tilde{u}_{\mathbf{I}}^* & \tilde{v}_{\mathbf{I}}^* \end{pmatrix} \begin{pmatrix} -\frac{\mathbf{P}^+}{2m} \tilde{u}_{\mathbf{I}} \\ +\frac{\mathbf{P}^-}{2m} \tilde{v}_{\mathbf{I}} \end{pmatrix} \right\} = 0, \quad (\text{B.112})$$

$$\mathcal{O}(\hbar) \quad 2 \operatorname{Im} \left( \begin{pmatrix} \tilde{u}_{\mathbf{I}}^* & \tilde{v}_{\mathbf{I}}^* \end{pmatrix} \begin{pmatrix} -\frac{\mathbf{P}^+}{2m} \cdot \nabla \tilde{u}_{\mathbf{I}} \\ +\frac{\mathbf{P}^-}{2m} \cdot \nabla \tilde{v}_{\mathbf{I}} \end{pmatrix} \right) = 0, \quad (\text{B.113})$$

with  $\mathbf{P}^\pm = \mathbf{p}_0(\mathbf{r}) \pm e\mathbf{A}(\mathbf{r})$ . The first, (B.112), contains no phases and is the amplitude transport equation as we will show shortly. The other, equation (B.113), determines the phase  $S_1^r(\mathbf{r})$ .

In order to rewrite equations (B.112) and (B.113) in a more tractable form we will need Hamilton's equations (2.19)

$$\dot{\mathbf{r}}^\alpha = \left( \frac{\partial E_0^\alpha(\mathbf{p}, \mathbf{r})}{\partial \mathbf{p}} \right), \quad \dot{\mathbf{p}}^\alpha = - \left( \frac{\partial E_0^\alpha(\mathbf{p}, \mathbf{r})}{\partial \mathbf{r}} \right), \quad (\text{B.114})$$

and also the following relation

$$\mathbf{j}^\alpha(\mathbf{r}) = - \left( \frac{\partial E_0^\alpha(\mathbf{p}, \mathbf{r})}{\partial \mathbf{A}(\mathbf{r})} \right)_{\mathbf{p}=\mathbf{p}_0^\alpha(\mathbf{r}), \mathbf{r}=\mathbf{r}^\alpha(t)}, \quad (\text{B.115})$$

where  $\mathbf{j}^\alpha(\mathbf{r})$  is the current density at the point  $\mathbf{r}$ . We require an expression for Hamilton's equations and the current in terms of the zeroth order quantities already found. For this we use the zeroth order equations (2.13)

$$\begin{aligned} \left( \begin{pmatrix} \tilde{u}_{\mathbf{I}}^\alpha & \tilde{v}_{\mathbf{I}}^\alpha \end{pmatrix} \right)^* E_0^\alpha \begin{pmatrix} \tilde{u}_{\mathbf{I}}^\alpha \\ \tilde{v}_{\mathbf{I}}^\alpha \end{pmatrix} &= \\ \left( \begin{pmatrix} \tilde{u}_{\mathbf{I}}^\alpha & \tilde{v}_{\mathbf{I}}^\alpha \end{pmatrix} \right)^* \begin{pmatrix} H_0^e(\mathbf{p}_0, \mathbf{r}) & |\Delta(\mathbf{r})| e^{i\phi(\mathbf{r})} \\ |\Delta(\mathbf{r})| e^{-i\phi(\mathbf{r})} & -H_0^h(\mathbf{p}_0, \mathbf{r}) \end{pmatrix} \begin{pmatrix} \tilde{u}_{\mathbf{I}}^\alpha \\ \tilde{v}_{\mathbf{I}}^\alpha \end{pmatrix}, \end{aligned}$$

which we differentiate to give

$$e^{-2S_1^i(\mathbf{r})} \left( \frac{\partial E_0^\alpha(\mathbf{p}, \mathbf{r})}{\partial \mathbf{p}} \right) = \begin{pmatrix} \tilde{u}_\mathbf{I}^\alpha(\mathbf{r}) & \tilde{v}_\mathbf{I}^\alpha(\mathbf{r}) \end{pmatrix}^* \begin{pmatrix} \frac{\partial H_0^e}{\partial \mathbf{p}} & 0 \\ 0 & -\frac{\partial H_0^h}{\partial \mathbf{p}} \end{pmatrix} \begin{pmatrix} \tilde{u}_\mathbf{I}^\alpha(\mathbf{r}) \\ \tilde{v}_\mathbf{I}^\alpha(\mathbf{r}) \end{pmatrix}, \quad (\text{B.116})$$

where

$$\begin{pmatrix} \tilde{u}_\mathbf{I}^\alpha & \tilde{v}_\mathbf{I}^\alpha \end{pmatrix}^* \begin{pmatrix} \tilde{u}_\mathbf{I}^\alpha \\ \tilde{v}_\mathbf{I}^\alpha \end{pmatrix} = e^{-2S_1^i(\mathbf{r})} ((u_{0,\mathbf{I}}^\alpha)^2 + (v_{0,\mathbf{I}}^\alpha)^2) = e^{-2S_1^i(\mathbf{r})},$$

has been used. We can do the same for  $\frac{\partial E_0^\alpha(\mathbf{p}, \mathbf{r})}{\partial \mathbf{A}(\mathbf{r})}$ :

$$\frac{\partial E_0^\alpha(\mathbf{p}, \mathbf{r})}{\partial \mathbf{A}(\mathbf{r})} = \begin{pmatrix} u_{0,\mathbf{I}}^\alpha & v_{0,\mathbf{I}}^\alpha \end{pmatrix} \begin{pmatrix} \frac{\partial H_0^e}{\partial \mathbf{A}} & 0 \\ 0 & -\frac{\partial H_0^h}{\partial \mathbf{A}} \end{pmatrix} \begin{pmatrix} u_{0,\mathbf{I}}^\alpha \\ v_{0,\mathbf{I}}^\alpha \end{pmatrix}, \quad (\text{B.117})$$

where the phases and amplitude,  $e^{-2S_1^i}$ , have been cancelled because they shall not be needed. The explicit derivatives of  $H_0^{e/h}$  are

$$\frac{\partial H_0^e}{\partial \mathbf{p}} = \frac{1}{m} (\mathbf{p} + e\mathbf{A}) = \frac{\mathbf{P}^+}{m}, \quad (\text{B.118})$$

$$-\frac{\partial H_0^h}{\partial \mathbf{p}} = -\frac{1}{m} (\mathbf{p} - e\mathbf{A}) = -\frac{\mathbf{P}^-}{m}, \quad (\text{B.119})$$

and

$$\frac{\partial H_0^e}{\partial \mathbf{A}} = \frac{1}{m} (\mathbf{p} + e\mathbf{A}) e = \frac{\mathbf{P}^+}{m} e, \quad (\text{B.120})$$

$$-\frac{\partial H_0^h}{\partial \mathbf{A}} = -\frac{1}{m} (\mathbf{p} - e\mathbf{A}) (-e) = -\frac{\mathbf{P}^-}{m} (-e), \quad (\text{B.121})$$

all evaluated for  $\mathbf{p} = \mathbf{p}_0^\alpha(\mathbf{r})$ .

Now let us use Hamilton's equations and the current relation to rewrite the transport equation (B.112) and the equation for  $S_1^i$  (B.113). Using (B.118) and (B.119) we see that the right hand side of (B.116) is precisely the inner product between the vectors in the order  $\hbar$  equation (B.112). Thus the transport equation can be rewritten as

$$\nabla \cdot \left( e^{-2S_1^i(\mathbf{r})} \frac{\partial E_0^\alpha(\mathbf{p}, \mathbf{r})}{\partial \mathbf{p}} \Big|_{\mathbf{p}=\mathbf{p}_0^\alpha(\mathbf{r})} \right) = 0. \quad (\text{B.122})$$

Manipulating (B.122) into the form

$$\sum_k \left( \frac{\partial E}{\partial p_k} \frac{\partial (e^{-S_1^i})}{\partial x_k} + \frac{1}{2} e^{-S_1^i} \frac{\partial^2 E}{\partial p_k \partial x_k} \right) = 0,$$

we recognise the time independent transport equation of van Vleck [14]. The solution is given by the determinant

$$e^{-S_1^i(\mathbf{r}, \mathbf{I})} = c \left| \det \frac{\partial^2 S_0^{\alpha, j}(\mathbf{r}, \mathbf{I})}{\partial \mathbf{r} \partial \mathbf{I}} \right|^{1/2}, \quad (\text{B.123})$$

where  $c$  is a constant.

All that is left to determine now is  $S_1^r(\mathbf{r})$ . Returning to (B.113) we have

$$\begin{aligned} 0 &= 2 \operatorname{Im} \left( \begin{array}{c} \tilde{u}_{\mathbf{I}}^\alpha \\ \tilde{v}_{\mathbf{I}}^\alpha \end{array} \right)^* \left( \begin{array}{c} -\frac{\mathbf{P}^+}{2m} \cdot \nabla \tilde{u}_{\mathbf{I}}^\alpha \\ +\frac{\mathbf{P}^-}{2m} \cdot \nabla \tilde{v}_{\mathbf{I}}^\alpha \end{array} \right) \\ &= \left( \begin{array}{c} \tilde{u}_{\mathbf{I}}^\alpha \\ \tilde{v}_{\mathbf{I}}^\alpha \end{array} \right)^* \left( \begin{array}{c} -\frac{\mathbf{P}^+}{m} \cdot (\nabla S_1^r + \nabla \Sigma_1^r) \tilde{u}_{\mathbf{I}}^\alpha \\ +\frac{\mathbf{P}^-}{m} \cdot (\nabla S_1^r - \nabla \Sigma_1^r) \tilde{v}_{\mathbf{I}}^\alpha \end{array} \right), \end{aligned}$$

or

$$\begin{aligned} 0 &= \left\{ \frac{e\mathbf{A}}{m} + ((u_{0, \mathbf{I}}^\alpha)^2 - (v_{0, \mathbf{I}}^\alpha)^2) \frac{\mathbf{p}}{m} \right\} \cdot \nabla S_1^r \\ &\quad + \left\{ \frac{\mathbf{p}}{m} + ((u_{0, \mathbf{I}}^\alpha)^2 - (v_{0, \mathbf{I}}^\alpha)^2) \frac{e\mathbf{A}}{m} \right\} \cdot \nabla \Sigma_1^r. \quad (\text{B.124}) \end{aligned}$$

Now use equations (B.116) and (B.117), which written out in full become

$$\begin{aligned} \frac{\partial E_0^\alpha}{\partial \mathbf{p}} &= \frac{e\mathbf{A}}{m} + ((u_{0, \mathbf{I}}^\alpha)^2 - (v_{0, \mathbf{I}}^\alpha)^2) \frac{\mathbf{p}}{m}, \\ \frac{1}{e} \frac{\partial E_0^\alpha}{\partial \mathbf{A}} &= \frac{\mathbf{p}}{m} + ((u_{0, \mathbf{I}}^\alpha)^2 - (v_{0, \mathbf{I}}^\alpha)^2) \frac{e\mathbf{A}}{m}, \quad (\text{B.125}) \end{aligned}$$

so that (B.124) becomes

$$\frac{\partial E_0^\alpha}{\partial \mathbf{p}} \cdot \nabla S_1^r = -\frac{1}{e} \frac{\partial E_0^\alpha}{\partial \mathbf{A}} \cdot \nabla \Sigma_1^r,$$

or

$$\nabla S_1^r \cdot \dot{\mathbf{r}}^\alpha = -\frac{1}{e} \mathbf{j}^\alpha \cdot \nabla \Sigma_1^r,$$

which we integrate along a trajectory of the Hamiltonian system from some initial time  $t_0$  to  $t$

$$\int_{t_0}^t \nabla S_1^r \cdot \frac{d\mathbf{r}^\alpha}{dt'} dt' = -\frac{1}{e} \int_{t_0}^t \mathbf{j}^\alpha(\mathbf{r}) \cdot \nabla \Sigma_1^r dt'.$$

Finally we have found an expression for  $S_1^r$ :

$$S_1^r(\mathbf{r}) = -\frac{1}{e} \int_{t_0}^t \mathbf{j}^\alpha(\mathbf{r}) \cdot \nabla \Sigma_1^r dt',$$

or

$$S_1^r(\mathbf{r}) = -\frac{1}{e} \int_{t_0}^t \mathbf{j}^\alpha(\mathbf{r}) \cdot \frac{\nabla \phi(\mathbf{r})}{2} dt'. \quad (\text{B.126})$$

We interpret this shift to first order in  $\hbar$  of the phase in the following way. From (B.125) we have

$$-\frac{1}{e} \mathbf{j}^\alpha(\mathbf{r}) = \frac{\mathbf{P}^\alpha}{m} + ((u_{0,\mathbf{I}}^\alpha)^2 - (v_{0,\mathbf{I}}^\alpha)^2) \frac{e\mathbf{A}}{m}, \quad (\text{B.127})$$

which is essentially the velocity of an excitation with an effective charge  $e^*(\mathbf{r}) = ((u_{0,\mathbf{I}}^\alpha)^2 - (v_{0,\mathbf{I}}^\alpha)^2) e$ . This effective charge is determined by the relative amounts of particle and hole that the excitation is composed of. As the spinor is transported along the phase space trajectory, figure 1, the particle-hole composition slowly changes giving rise to a changing charge  $e^*(\mathbf{r})$  (charge is not a good quantum number in superconductors) and hence a changing current  $\mathbf{j}^\alpha(\mathbf{r})$ . This varying current interacts with the phase gradient of the order parameter and modifies the phase of the wave function to first order in  $\hbar$ . Notice in particular that if no phase gradient exists, i.e.  $\phi = \text{constant}$ , then  $S_1^r = 0$ .

### APPENDIX C: TECHNICAL DETAILS OF THE ANALYTIC CONTINUATION OF THE SNS JUNCTION EIGENFUNCTIONS TO DETERMINE A QUANTISATION CONDITION

The basic idea of the analytic continuation of solutions is simple: our asymptotic solutions are valid not only along the real axis but for complex coordinates as well, so long as we stay sufficiently far away from  $y_\pm$ . Thus we obtain an approximate solution to the BdG equations throughout the complex plane (excluding discs, radius  $\rho$  say, centred upon  $y_\pm$ ) by continuing our asymptotic solutions to complex coordinates. In particular we can continue a solution valid for  $y > y_+ + \rho$  along a semicircular path, radius  $> \rho$ , in the plane and arrive at  $y < y_+ - \rho$ , thus determining the appropriate amplitudes and phases of the solution for  $y_- + \rho < y < y_+ - \rho$ . Similarly we can circumvent  $y_-$  to obtain the correctly phased solution for  $y < y_- - \rho$ . The situation is however complicated by Stokes phenomenon.

Stokes phenomenon is named after its discoverer Sir George Gabriel Stokes (1819-1903). A general discussion of historical issues can be found in Heading [35]. Stokes, studying Airy's equation, noticed that if a general solution, given in terms of the two power series with arbitrary coefficients, was represented by a certain linear combination of the asymptotic solutions in one region of the complex plane then in an adjacent region the same general solution was represented by a completely different form of linear combination of these asymptotic solutions. He discovered the constants of the linear combination changed discontinuously when crossing certain lines

in the plane - now known as Stokes lines. (Note it is a change in form not the numerical value which takes place.)

For us, this means that if we choose an asymptotic solution, i.e. we set the coefficients of other solutions to zero, and then analytically continue, we will cross Stokes lines where the coefficients can jump, in particular from zero to non-zero, so that solutions which were absent suddenly appear changing the form of our solution. What we need to know is how to locate the Stokes lines and what rule determines the change in the coefficients as the lines are crossed.

### C.1. Stokes phenomenon in the presence of two solutions

Stokes phenomenon occurs when the exponentially subdominant solution out of a pair is at its smallest. Consider the asymptotic (WKB) form for the solutions to Airys equation:

$$\Psi_{\pm} = (z)^{-1/4} e^{\pm i \frac{2}{3} z^{3/2}}, \quad z \rightarrow \infty.$$

For real  $z$  these solutions are oscillatory but for complex  $z$  the solutions acquire the exponential factors  $e^{+|w(z)|}$  or  $e^{-|w(z)|}$ , with  $w(z) = \frac{2}{3} \text{Re}\{iz^{3/2}\}$ . Thus one solution is exponentially dominant, the other exponentially subdominant. Now  $e^{+|w(z)|}$  is maximally dominant when  $\text{Im}\{iz^{3/2}\} = 0$ , and it is then, when the second solution is least visible, that its coefficient can jump. Thus Stokes lines are defined by

$$\text{Im}\{iz^{3/2}\} = 0, \tag{C.128}$$

in the present case.

Anti-Stokes lines are defined by

$$\text{Re}\{iz^{3/2}\} = 0. \tag{C.129}$$

These are the lines along which the effect of the Stokes jump becomes important because both solutions are purely oscillatory. The solutions are said to be neutral, neither being subdominant wrt. the other. Notice that both the Stokes lines and anti-Stokes lines emanate from a branch point at  $z = 0$ .

The general prescription when crossing a Stokes-line is given by

$$\begin{aligned} [\text{New subdominant coeff.}] = & [\text{Old subdominant coeff.}] \\ & + (\text{Stokes constant}) \times \\ & [\text{coeff. of dominant term}]. \end{aligned}$$

By following a given solution along a circuit surrounding the branch point a number of Stokes constants will be introduced. Requiring our initial and final solutions to be the same determines the value of these constants.

The situation we must solve involves four solutions. Before we can proceed we must therefore generalise the above discussion.



## C.2. Stokes phenomenon in the presence of more than two solutions

<sup>7</sup> Suppose now we have  $N$  solutions. Let us change our notation and write each solution as

$$\Psi_i(z) = e^{\phi_i(z)}, \quad (\text{C.130})$$

$i = 1, \dots, N$ . Then one might expect that as we move around in the complex plane a given solution, say  $i$ , could pick up contributions from some or all of the other solutions,  $j \neq i$ . The question we must ask is when can Stokes phenomenon occur? The answer is as follows. Introduce the *singulant* for a pair of solutions as the quantity  $\phi_i - \phi_j$ . Then a necessary condition for  $\Psi_i$  to experience Stokes phenomenon is

$$\text{Im}\{\phi_i - \phi_j\} = 0, \quad i \neq j, \quad (\text{C.131})$$

and sufficiency <sup>8</sup> is ensured by

$$\text{Re}\{\phi_i\} > \text{Re}\{\phi_j\}. \quad (\text{C.132})$$

We can understand the first of these conditions, (C.131), as being a generalisation of the Stokes lines for two solutions. Indeed when we have two solutions so that  $\phi_j = -\phi_i$  (C.131) reduces to

$$\text{Im}\{2\phi_i\} = 0,$$

which is just the usual equation (C.128) for Stokes lines. When there are more than two solutions, so that in general  $\phi_j \neq \phi_i$ , (C.131) says that Stokes lines exist where the imaginary part of the exponents are the same. This ensures that when comparing two solutions the effect of the phase can be discounted. Then we can concentrate on the real parts which must satisfy (C.132). Clearly (C.132) implies

$$e^{\phi_i} > e^{\phi_j},$$

so that  $\Psi_i$  is maximal over  $\Psi_j$  whose coefficient can then change.

Thus Stokes phenomenon occurs where solutions are pair-wise maximally dominant and subdominant.

Anti-Stokes lines are defined by

$$\text{Re}\{\phi_i - \phi_j\} = 0. \quad (\text{C.133})$$

This situation will be clarified in the specific treatment of the semiclassical SNS junction eigenfunctions which follows.

<sup>7</sup>I am indebted to Chris Howls for explaining how Stokes phenomenon is to be understood and treated in the case of more than two solutions.

<sup>8</sup>Assuming the Riemann sheets on which the individual solutions live are not locally disjoint.

### C.3. Conventions and notation

It will be useful to introduce the following compact notation for the semiclassical solutions with phase reference  $y_+$ :

$$\Psi_1(z) = \frac{1}{\sqrt{\left(\frac{\partial E}{\partial p_y}\right)_{p_y^+(z)}}} \begin{pmatrix} u_{0,I}^+(z)e^{+i\phi/2} \\ v_{0,I}^+(z)e^{-i\phi/2} \end{pmatrix} e^{\frac{i}{\hbar} \int_z^{y_+} dz' p_y^+(z')}, \quad (\text{C.134})$$

$$\Psi_2(z) = \frac{1}{\sqrt{\left(\frac{\partial E}{\partial p_y}\right)_{p_y^+(z)}}} \begin{pmatrix} u_{0,I}^+(z)e^{+i\phi/2} \\ v_{0,I}^+(z)e^{-i\phi/2} \end{pmatrix} e^{\frac{i}{\hbar} \int_{y_+}^z dz' p_y^+(z')}, \quad (\text{C.135})$$

$$\Psi_3(z) = \frac{1}{\sqrt{\left(\frac{\partial E}{\partial p_y}\right)_{p_y^-(z)}}} \begin{pmatrix} u_{0,I}^-(z)e^{+i\phi/2} \\ v_{0,I}^-(z)e^{-i\phi/2} \end{pmatrix} e^{\frac{i}{\hbar} \int_z^{y_+} dz' p_y^-(z')}, \quad (\text{C.136})$$

$$\Psi_4(z) = \frac{1}{\sqrt{\left(\frac{\partial E}{\partial p_y}\right)_{p_y^-(z)}}} \begin{pmatrix} u_{0,I}^-(z)e^{+i\phi/2} \\ v_{0,I}^-(z)e^{-i\phi/2} \end{pmatrix} e^{\frac{i}{\hbar} \int_{y_+}^z dz' p_y^-(z')}, \quad (\text{C.137})$$

where the  $\Psi_i(z)$  are analytic continuations of the  $\Psi_i(y)$  to complex coordinates in a domain suitably cut to ensure single-valued definitions (see FIG. 11 and the next section). The same four solutions written with phase reference  $y_-$  are obtained by replacing  $y_+$  by  $y_-$  in equations (C.134)-(C.137) and shall be distinguished from  $\Psi_i(z)$  by appending a minus sign as a superscript thus

$$\Psi_1^-(z) = \frac{1}{\sqrt{\left(\frac{\partial E}{\partial p_y}\right)_{p_y^+(z)}}} \begin{pmatrix} u_{0,I}^+(z)e^{+i\phi/2} \\ v_{0,I}^+(z)e^{-i\phi/2} \end{pmatrix} e^{\frac{i}{\hbar} \int_z^{y_-} dz' p_y^+(z')}, \quad (\text{C.138})$$

etc. Note that

$$\Psi_1(z) = [1]\Psi_1^-(z),$$

where we have introduced  $[1]$  as the pure phase factor

$$[1] = \exp\left(\frac{i}{\hbar} \int_{y_-}^{y_+} dz' p_y^+(z')\right).$$

We also have

$$\begin{aligned} [2] &= [1]^*, \\ [3] &= \exp\left(\frac{i}{\hbar} \int_{y_-}^{y_+} dz' p_y^-(z')\right), \\ [4] &= [3]^*, \end{aligned}$$

where \* indicates complex conjugation. Furthermore we use  $\phi_i$  and  $\phi_i^-$  ( $i = 1, \dots, 4$ ) to indicate the exponents including the asymptotic parameter ( $1/\hbar$ ) thus

$$\phi_1 = \frac{i}{\hbar} \int_z^{y^+} dz' p_y^+(z'), \quad (\text{C.139})$$

$$\phi_1^- = \frac{i}{\hbar} \int_z^{y^-} dz' p_y^+(z'), \quad (\text{C.140})$$

and so on.

#### C.4. Ensuring $p_y^\pm(z)$ and the wave functions are single-valued

In order to construct a solution valid in the complex plane we must have single-valued WKB solutions. The momentum branches for the superconducting state are multivalued functions. Recall  $p_y^\pm(y)$  (4.67):

$$p_y^\beta(y) = \sqrt{p_F^2 - p_x^2 - p_z^2 + \beta 2m\sqrt{E^2 - |\Delta(y)|^2}}.$$

In fact  $p_y^\pm(y)$  are two branches of one function  $p_y(z)$  given by

$$p_y(z) = \sqrt{p_F^2 - p_x^2 - p_z^2 + 2m\sqrt{E^2 - \Delta^2(z)}}, \quad (\text{C.141})$$

which is single-valued on its Riemann surface comprising more than one Riemann sheet. (Here we use  $\Delta(z)$  to represent the analytic continuation of  $|\Delta(y)|$  to complex values.) Suppose we have the branch of (C.141) which is equal to  $p_y^+(y)$  on the real axis, then we obtain  $p_y^-(y)$  by analytically continuing the function around one of the zeros of  $\sqrt{E^2 - |\Delta(y)|^2}$ . We can see this explicitly if we consider a smooth slowly varying  $|\Delta(y)|$  and expand in the vicinity of the turning point

$$|\Delta(y)| = \Delta_0 + \left. \frac{\partial|\Delta|}{\partial y} \right|_{y_\pm} (y - y_\pm) + \dots \quad (\text{C.142})$$

The function  $\sqrt{E^2 - \Delta^2(z)}$  then becomes ( $\Delta_0 = E$ )

$$\sqrt{E^2 - \Delta^2(z)} = \sqrt{2E \left. \frac{\partial|\Delta|}{\partial y} \right|_{y_\pm} \varrho_\pm} e^{i\theta_\pm/2}, \quad (\text{C.143})$$

where  $z_\pm = \varrho_\pm e^{i\theta_\pm/2}$  are the coordinates centred on  $y_\pm$ . Clearly  $\theta_\pm \rightarrow \theta_\pm + 2\pi$  causes the function in (C.143) to change sign so that  $p_y(z_\pm) = p_y^+(y)$  becomes  $p_y(z_\pm e^{i2\pi}) = p_y^-(y)$ . To make  $p_y(z)$  single-valued in the complex plane we insert a branch cut between  $y_+$  and  $y_-$ . Notice that, so long as  $p_F^2 - p_x^2 - p_z^2 > 2m\text{Re}\{\sqrt{E^2 - \Delta^2(z)}\}$ , the Riemann surface of  $p_y(z)$  consists of just two sheets. However our WKB solutions are constructed from  $p_y^\pm$  and  $-p_y^\pm$  so that we must consider the four Riemann sheets of  $p_y(z)$  and

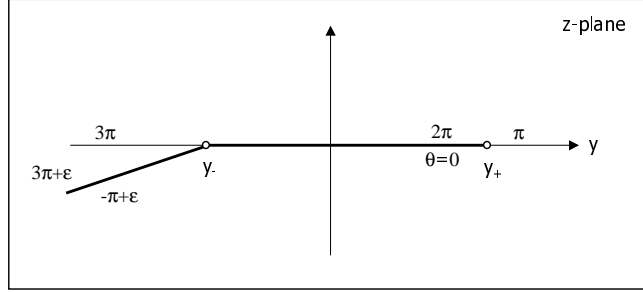

**FIG. 11** Branch cuts which ensure the WKB solutions are single-valued.

$-p_y(z)$  together. FIG. 11 shows the plane in which the WKB solutions are single-valued. The second branch cut emanating from  $y_-$  is necessary because from (4.81)

$$\left(\frac{\partial E}{\partial p_y}\right)^{-1/2} \propto \frac{1}{\sqrt[4]{E^2 - \Delta^2(z)}}, \quad (\text{C.144})$$

which in the vicinity of  $y_-$  is

$$\left(\frac{\partial E}{\partial p_y}\right)^{-1/2} \propto \frac{e^{-i\theta_-/4}}{\sqrt[4]{2E|\frac{\partial \Delta}{\partial y}|_{y_-} - \varrho_-}}. \quad (\text{C.145})$$

Now (C.145) multiplies each of the WKB solutions and changes sign when  $\theta \rightarrow \theta + 4\pi$  even though the momentum is single-valued under this change. The WKB solutions are then only single-valued if a second branch cut is inserted (as shown).

### C.5. Rules for continuing across branch cuts

Let us start with the turning point  $y_+$  (FIG. 11), and consider  $p_y(z) = p_y^+(z)$ . By inserting the branch cut between  $y_+$  and  $y_-$  we have prevented  $p_y(z)$  taking the value  $p_y^-(z)$  at each  $z$ . To display all of the values of  $p_y(z)$  we take two copies of the complex plane, label them sheet 1 and sheet 2 respectively, and assign sheet 1 as the domain of  $p_y^+$  and sheet 2 the domain for  $p_y^-$ . Look at Fig. 12. If a contour respects the branch cut,  $\gamma_1$  for instance, it stays on the first sheet. However if we follow a contour like  $\gamma_2$  when we cross the branch cut of sheet 1  $p_y(z)$  is changing smoothly and so we appear on sheet 2 and  $p_y(z)$  has become  $p_y^-(z)$ . What happens to the eigenfunctions?

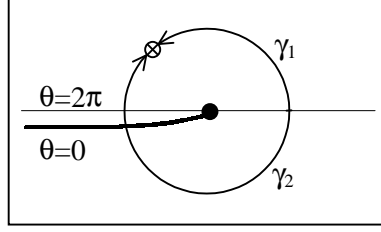

**FIG. 12** Alternative contours in complex plane.  $\gamma_2$  crosses the branch cut.

Consider

$$\Psi_1(z) = \frac{1}{\sqrt{\left(\frac{\partial E}{\partial p_y}\right)_{p_y^+(z)}}} \begin{pmatrix} u_{0,I}^+(z)e^{+i\phi/2} \\ v_{0,I}^+(z)e^{-i\phi/2} \end{pmatrix} e^{\frac{i}{\hbar} \int_z^{y^+} dz' p_y^+(z')}, \quad (\text{C.146})$$

where

$$\left(\frac{\partial E}{\partial p_y}\right)^{-1/2} \propto \frac{E^{1/2}}{\sqrt[4]{E^2 - \Delta^2(z)}} \frac{1}{\sqrt{p_y^+(z)}}, \quad (\text{C.147})$$

and the spinor is given by (see equations (4.79)-(4.80))

$$\begin{pmatrix} u_{0,I}^\beta(z)e^{+i\phi/2} \\ v_{0,I}^\beta(z)e^{-i\phi/2} \end{pmatrix} = \begin{pmatrix} \sqrt{\frac{1}{2} \left(1 + \frac{\beta\sqrt{E^2 - \Delta^2(z)}}{E}\right)} e^{+i\phi/2} \\ \sqrt{\frac{1}{2} \left(1 - \frac{\beta\sqrt{E^2 - \Delta^2(z)}}{E}\right)} e^{-i\phi/2} \end{pmatrix}, \quad (\text{C.148})$$

$\beta = +$  corresponds to  $p_y^+$ . Now suppose we follow the two contours shown in FIG. 12. The first,  $\gamma_1$ , does not cross the branch cut. Let us use  $z_{\text{above}} = re^{i\theta_{\text{above}}}$  to label the  $z$ -coordinate in the plane from following this contour. If instead we follow  $\gamma_2$  we do cross the branch cut. Let the coordinate from following this path be  $z_{\text{below}}$ . We then have  $z_{\text{above}} = z_{\text{below}}e^{+i2\pi}$ . What we require is  $\Psi_1(z_{\text{below}})$  written in terms of  $z_{\text{above}}$ . Let us consider in turn each of the terms entering into  $\Psi_1(z)$ .

### C.5.1. The change in $(\partial E/\partial p_y)^{-1/2}$

Firstly consider (C.147) and note that

$$\sqrt{E^2 - \Delta^2(z)} \approx \sqrt{2E} \left| \frac{\partial \Delta}{\partial y} \right|_{y^+} r e^{i\theta/2}, \quad (\text{C.149})$$

in the vicinity of  $y_+$  so that (C.147) becomes (using  $z_{\text{below}}$ )

$$\left(\frac{\partial E}{\partial p_y}\right)_{p_y^+}^{-1/2} \propto \frac{E^{1/2} e^{-i\theta_{\text{below}}/4}}{\sqrt[4]{2E} \left|\frac{\partial \Delta}{\partial y}\right|_{y_+} r} \frac{1}{\sqrt{p_y^+(z_{\text{below}})}}. \quad (\text{C.150})$$

We then have

$$\begin{aligned} \left(\frac{\partial E}{\partial p_y}\right)_{p_y^+(z_{\text{below}})}^{-1/2} &= \left(\frac{\partial E}{\partial p_y}\right)_{p_y^+(z_{\text{above}} e^{-i2\pi})}^{-1/2} \\ &= \frac{E^{1/2} e^{-i(\theta_{\text{above}} - 2\pi)/4}}{\sqrt[4]{2E} \left|\frac{\partial \Delta}{\partial y}\right|_{y_+} r} \frac{1}{\sqrt{p_y^+(z_{\text{above}} e^{-i2\pi})}}, \\ &= e^{i\pi/2} \left(\frac{\partial E}{\partial p_y}\right)_{p_y^-(z_{\text{above}})}^{-1/2}, \end{aligned} \quad (\text{C.151})$$

where  $p_y^+(z_{\text{above}} e^{-i2\pi}) = p_y^-(z_{\text{above}})$  has been used. We find this amplitude acquires a factor  $+i$ .

### C.5.2. Change in the spinor

Here we also have the spinor (C.148) which using (C.149) becomes

$$\begin{pmatrix} u_{0,I}^+(z_{\text{below}}) e^{+i\phi/2} \\ v_{0,I}^+(z_{\text{below}}) e^{-i\phi/2} \end{pmatrix} = \begin{pmatrix} u_{0,I}^-(z_{\text{above}}) e^{+i\phi/2} \\ v_{0,I}^-(z_{\text{above}}) e^{-i\phi/2} \end{pmatrix}. \quad (\text{C.152})$$

### C.5.3. Change in the phase integral

Finally consider the phase

$$\begin{aligned} \phi_1(z_{\text{below}}) &= \frac{i}{\hbar} \int_{z_{\text{below}}}^{y_+} p_y^+(z') dz', \\ &= \frac{i}{\hbar} \int_{z_{\text{above}} e^{-i2\pi}}^{y_+} p_y^+(z') dz'. \end{aligned} \quad (\text{C.153})$$

Changing the limit  $z_{\text{above}} e^{-i2\pi}$  to  $z_{\text{above}}$  will mean the phase of  $z'$  along a contour is decreased by  $2\pi$ , we must therefore explicitly include  $e^{-i2\pi}$  to maintain the value of (C.153) thus

$$\begin{aligned} \phi_1(z_{\text{below}}) &= \frac{i}{\hbar} \int_{z_{\text{above}}}^{y_+} p_y^+(z'' e^{-i2\pi}) dz'', \\ &= \frac{i}{\hbar} \int_{z_{\text{above}}}^{y_+} p_y^-(z'') dz'', \\ &= \phi_3(z_{\text{above}}). \end{aligned} \quad (\text{C.154})$$

C.5.4. *How the eigenfunctions change*

Putting (C.151), (C.152) and (C.154) together we find the rule for crossing the branch cut to be

$$\begin{aligned}\Psi_1(z_{\text{below}}) &= +i \frac{1}{\sqrt{\left(\frac{\partial E}{\partial p_y}\right)_{p_y^-(z_{\text{above}})}}} \begin{pmatrix} u_{0,I}^-(z_{\text{above}}) \\ v_{0,I}^-(z_{\text{above}}) \end{pmatrix} e^{\phi_3(z_{\text{above}})}, \\ &= +i \Psi_3(z_{\text{above}}).\end{aligned}\tag{C.155}$$

Clearly we also have

$$\Psi_2(z_{\text{below}}) = +i \Psi_4(z_{\text{above}}),\tag{C.156}$$

$$\Psi_3(z_{\text{below}}) = +i \Psi_1(z_{\text{above}}),\tag{C.157}$$

$$\Psi_4(z_{\text{below}}) = +i \Psi_2(z_{\text{above}}).\tag{C.158}$$

These rules apply when crossing the branch cut in the clockwise sense around  $y_+$ . When moving in the positive sense  $+i$  is replaced by  $-i$ . It is also easy to see that  $\Psi_1^- = +i \Psi_3^-$  etc. for solutions with phase reference  $y_-$ .

C.5.5. *A rule for the pure phase factors*

We have previously introduced the definition

$$[1] = \exp\left(\frac{i}{\hbar} \int_{y_-}^{y_+} dz' p_y^+(z')\right).$$

The integral may be taken above or below the cut connecting  $y_+$  to  $y_-$ . Since  $p_y^+(z_{\text{above}}) = p_y^-(z_{\text{below}})$  we have

$$[1]_{\text{above}} = [3]_{\text{below}},$$

or

$$[1] \rightarrow [3].\tag{C.159}$$

Similarly:

$$[2] \rightarrow [4],\tag{C.160}$$

$$[3] \rightarrow [1],\tag{C.161}$$

$$[4] \rightarrow [2].\tag{C.162}$$

We now have all the rules needed for crossing the branch cut.

Our task is now to find the location of the Stokes and anti-Stokes lines as defined by (C.131) and (C.133).

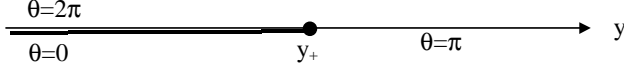

FIG. 13 Branch cut in complex plane.

### C.6. Locating the Stokes and anti-Stokes lines

In order to locate the Stokes and anti-Stokes lines in the vicinity of  $y_+$  and  $y_-$  we require the form of the momentum branches there. These are

$$p_y^\pm(\tilde{z}) = \sqrt{p_F^2 - p_x^2 - p_z^2 \pm 2m\sqrt{2E} \left| \frac{\partial \Delta}{\partial y} \right|_{y_\pm} \tilde{z}}, \quad (\text{C.163})$$

where we have used the expansion for  $\Delta(\tilde{z})$  (equation (C.142)), and  $\tilde{z} = re^{i\theta}$  is the coordinate in the complex plane centred on either  $y_+$  or  $y_-$  (which of these it is should be clear from the context). Firstly consider the vicinity of  $y_+$ , FIG. 13. We require the exponents of the WKB solutions. Let us start by considering  $\phi_1$

$$\begin{aligned} \phi_1(z) &= \frac{i}{\hbar} \int_z^{y_+} p_y^+(z') dz', \\ &= \frac{i}{\hbar} \int_0^{y_+ - z} p_y^+(\tilde{z}) d\tilde{z}. \end{aligned} \quad (\text{C.164})$$

To calculate the form of this integral we note that  $p_F^2 - p_x^2 - p_z^2 \gg 2m\sqrt{2E} \left| \frac{\partial \Delta}{\partial y} \right| \tilde{z}$  so that (C.163) can be further approximated by expanding in powers of  $\tilde{z}^{1/2}$ . (C.163) then becomes

$$p_y^\pm(z) = p^{(0)} \pm p^{(1)} \tilde{z}^{1/2} + \dots, \quad (\text{C.165})$$

where  $p^{(0)} = \sqrt{p_F^2 - p_x^2 - p_z^2}$  and  $p^{(1)} = \left| \frac{\partial p_y^\pm}{\partial \tilde{z}^{1/2}} \right| = \frac{m\sqrt{2E} \left| \frac{\partial \Delta}{\partial y} \right|}{p^{(0)}}$ . Only the first two terms of (C.165) shall be needed. Inserting the  $p_y^+$  expansion into (C.164) we have

$$\begin{aligned} \phi_1(z) &= \frac{i}{\hbar} \int_0^{y_+ - z} d\tilde{z} \left( p^{(0)} + p^{(1)} \tilde{z}^{1/2} \right), \\ &= \frac{i}{\hbar} \left\{ p^{(0)} (y_+ - z) + \frac{2}{3} p^{(1)} (y_+ - z)^{3/2} \right\}, \end{aligned}$$

or using  $\tilde{z} = re^{i\theta}$  ( $\theta = 0$  along bottom of the branch cut in FIG. 13)

$$\phi_1(z) = \frac{i}{\hbar} \left\{ p^{(0)} r e^{i\theta} + \frac{2}{3} p^{(1)} r^{3/2} e^{i3\theta/2} \right\}. \quad (\text{C.166})$$



If we write

$$\{\}_{\pm} = \left\{ p^{(0)} r e^{i\theta} \pm \frac{2}{3} p^{(1)} r^{3/2} e^{i3\theta/2} \right\}, \quad (\text{C.167})$$

then the four exponents of the WKB solutions with phase reference  $y_+$  can be written compactly as

$$\phi_1(z) = +\frac{i}{\hbar} \{\}_+, \quad (\text{C.168})$$

$$\phi_2(z) = -\frac{i}{\hbar} \{\}_+, \quad (\text{C.169})$$

$$\phi_3(z) = +\frac{i}{\hbar} \{\}_-, \quad (\text{C.170})$$

$$\phi_4(z) = -\frac{i}{\hbar} \{\}_-. \quad (\text{C.171})$$

### C.6.1. Stokes and anti-Stokes lines around $y_+$

For the Stokes lines we require  $\text{Im}\{\phi_i - \phi_j\} = 0$  for each distinct pairing of (C.168)-(C.171). We consider one example and then the remaining pairs have their results summarised in table 2.

Consider  $\phi_1 - \phi_2$ :

$$\begin{aligned} \phi_1 - \phi_2 &= \frac{i}{\hbar} \{\}_+ - \frac{-i}{\hbar} \{\}_+, \\ &= \frac{2i}{\hbar} \{\}_+. \end{aligned}$$

The imaginary part is then

$$\text{Im}\{\phi_1 - \phi_2\} = \frac{2}{\hbar} \left( p^{(0)} r \cos \theta + \frac{2}{3} p^{(1)} r^{3/2} \cos \left( \frac{3\theta}{2} \right) \right), \quad (\text{C.172})$$

whilst the real part is

$$\text{Re}\{\phi_1 - \phi_2\} = -\frac{2}{\hbar} \left( p^{(0)} r \sin \theta + \frac{2}{3} p^{(1)} r^{3/2} \sin \left( \frac{3\theta}{2} \right) \right). \quad (\text{C.173})$$

The Stokes lines are determined by the angles  $\theta$  for which  $\text{Im}\{\phi_1 - \phi_2\}$  vanishes. It will be sufficient to locate these lines approximately. Close to  $y_+$  (i.e.  $r \rightarrow 0$ ) we can in the first approximation neglect the second term in (C.172). Then

$$p^{(0)} r \cos \theta^0 = 0,$$

gives  $\theta^0 = \pi/2, 3\pi/2$ . Returning to (C.172) and substituting  $\theta = \theta^0 + \delta\theta$  we can determine how the second term shifts  $\theta$ . Since  $\delta\theta$  is small all we require is its sign. For  $\theta^0 = \pi/2$  we find  $\delta\theta = -|\delta\theta|$  and the Stokes line is

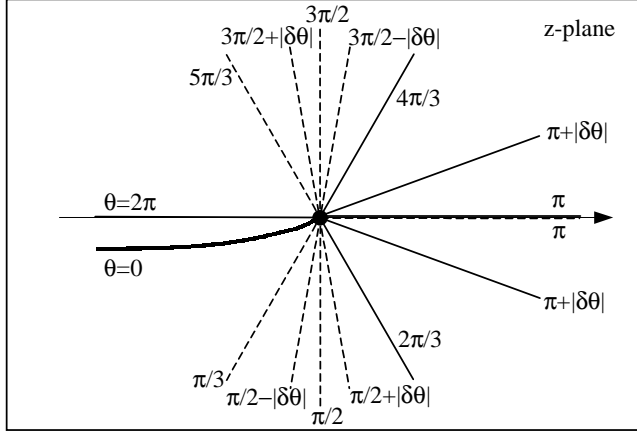

FIG. 14 Stokes and anti-Stokes lines around  $y_+$ .

then located at  $\theta = \pi/2 - |\delta\theta|$ . For  $\theta^0 = 3\pi/2$  we also have  $\delta\theta = -|\delta\theta|$  as can be checked. Thus  $\theta = 3\pi/2 - |\delta\theta|$ .

To decide which function  $\Psi_1$  or  $\Psi_2$  is dominant and which is subdominant on the Stokes line we consider the sign of  $\text{Re}\{\phi_1 - \phi_2\}$ . For this purpose it suffices to ignore the second term in (C.173). For  $\theta = \pi/2 - |\delta\theta|$ ,  $\sin(\pi/2 - |\delta\theta|) > 0$ ,  $\text{Re}\{\phi_1 - \phi_2\} < 0$  so that  $\Psi_2 > \Psi_1$ . At  $\theta = 3\pi/2 - |\delta\theta|$  the opposite is true ( $\Psi_1 > \Psi_2$ ).

We have now located the Stokes lines for the pair of functions  $\Psi_1$  and  $\Psi_2$ , and we know the dominance on each line. Calculating the anti-Stokes lines proceeds similarly. The results are summarised in table 2.

FIG. 14 shows the Stokes and anti-Stokes lines around  $y_+$ . Notice that the anti-Stokes lines at  $+\pi - |\delta\theta|$  and  $+\pi + |\delta\theta|$  are shifted off the real axis ( $|\delta\theta| \neq 0$ ) by the second term in (C.173). These lines are where  $\phi_1 - \phi_2$  and  $\phi_3 - \phi_4$  are neutral but since  $\phi_2 = -\phi_1$ , and  $\phi_4 = -\phi_3$  this neutrality condition reduces to  $\Psi_1, \Psi_2, \Psi_3$  and  $\Psi_4$  being individually neutral (i.e., oscillatory) on the appropriate Stokes line. It is these Stokes lines no longer coinciding with the real  $y$ -axis that ensures the existence of evanescent solutions for  $y \rightarrow +\infty$ , i.e on the real axis.

$\phi_i - \phi_j$	$\phi_1 - \phi_2$	$\phi_1 - \phi_3$	$\phi_4 - \phi_2$	$\phi_1 - \phi_4$	$\phi_3 - \phi_2$	$\phi_3 - \phi_4$
$\phi_i - \phi_j =$	$\frac{i}{\hbar}\{\}_+ - \frac{-i}{\hbar}\{\}_+$	$\frac{i}{\hbar}\{\}_+ - \frac{i}{\hbar}\{\}_-$		$\frac{i}{\hbar}\{\}_+ - \frac{-i}{\hbar}\{\}_-$		$\frac{i}{\hbar}\{\}_- - \frac{-i}{\hbar}\{\}_-$
$\text{Im}\{\phi_i - \phi_j\} \propto$	$\cos \theta + \text{fn}(r) \cos\left(\frac{3\theta}{2}\right)$	$r^{3/2} \cos\left(\frac{3\theta}{2}\right)$		$r \cos \theta$		$\cos \theta - \text{fn}(r) \cos\left(\frac{3\theta}{2}\right)$
$\theta_{\text{Im}\{\phi_i - \phi_j\}=0, \text{ and } \text{Re}\{\phi_m\} > \Psi_m}$ $\text{Re}\{\phi_\ell\} > \Psi_\ell$ $\uparrow$	$\theta_1$ $\frac{\pi}{2} -  \delta\theta , \Psi_2 > \Psi_1$ $\theta_2$ $\frac{3\pi}{2} -  \delta\theta , \Psi_1 > \Psi_2$ $\theta_3$ —	$\frac{\pi}{3}, \Psi_3 > \Psi_1, \Psi_2 > \Psi_4$ $\pi, \Psi_1 > \Psi_3, \Psi_4 > \Psi_2$ $\frac{5\pi}{3}, \Psi_3 > \Psi_1, \Psi_2 > \Psi_4$		$\frac{\pi}{2}, \Psi_4 > \Psi_1, \Psi_2 > \Psi_3$ $\frac{3\pi}{2}, \Psi_1 > \Psi_4, \Psi_3 > \Psi_2$ —		$\frac{\pi}{2} +  \delta\theta , \Psi_4 > \Psi_3$ $\frac{3\pi}{2} +  \delta\theta , \Psi_3 > \Psi_4$ —
$\text{Re}\{\phi_i - \phi_j\} \propto$	$\sin \theta + \text{fn}(r) \sin\left(\frac{3\theta}{2}\right)$	$r^{3/2} \sin\left(\frac{3\theta}{2}\right)$		$r \sin \theta$		$\sin \theta - \text{fn}(r) \sin\left(\frac{3\theta}{2}\right)$
$\theta_{\text{Re}\{\phi_i - \phi_j\}=0} = (\Psi_i, \Psi_j)$ (see column heading for neutral pair)	$\theta_1$ 0 $\theta_2$ $\pi -  \delta\theta ,$ $\theta_3$ $2\pi$ $\theta_4$ —	0 $\frac{2\pi}{3}$ $\frac{4\pi}{3}$ $2\pi$		0 $\pi$ $2\pi$ —		0 $\pi +  \delta\theta $ $2\pi$ —

TABLE 2: Summary of Stokes lines and anti-Stokes lines located around the turning point  $y_+$ .

C.6.2. Stokes and anti-Stokes lines around  $y_-$

So far we have only considered the turning point at  $y_+$ . The situation is very similar at  $y_-$ . Note however that the phases are given by

$$\begin{aligned}\phi_1^-(z) &= \frac{i}{\hbar} \int_z^{y_-} p_y^+(z') dz', \\ &= -\frac{i}{\hbar} \int_0^{z-y_-} p_y^+(\tilde{z}) d\tilde{z}, \\ &= -\frac{i}{\hbar} \left\{ p^{(0)}(z-y_-) + \frac{2}{3} p^{(1)}(z-y_-)^{3/2} \right\},\end{aligned}\tag{C.174}$$

where now  $z - y_- = r e^{i\theta}$  ( $\theta = 0$  below the cut again), i.e.,

$$\phi_1^-(z) = -\frac{i}{\hbar} \{ \}_+, \tag{C.175}$$

and

$$\phi_2^-(z) = +\frac{i}{\hbar} \{ \}_+, \tag{C.176}$$

$$\phi_3^-(z) = -\frac{i}{\hbar} \{ \}_-, \tag{C.177}$$

$$\phi_4^-(z) = +\frac{i}{\hbar} \{ \}_-, \tag{C.178}$$

(compare (C.168)-(C.171)). Using these the Stokes and anti-Stokes lines around  $y_-$  can be calculated. The results are summarised in table 3, and drawn in FIG. 15. The  $z$ -plane containing both  $y_+$  and  $y_-$ , and all the Stokes-lines and dominance changes is shown in Fig. 16. This figure contains no fewer than 18 Stokes lines and 11 anti-Stokes lines. When there are more than two solutions it becomes difficult to label a solution with dominance or subdominance. Dominant with respect to which of the other solutions? The approach we have taken here is to write on the figure either  $\Psi_i > \Psi_j$  (where we use the  $>$  symbol not just to represent greater than but rather to indicate maximal dominance of  $\Psi_i$  over  $\Psi_j$ ) or  $(\Psi_i, \Psi_j)$  which indicates that the pair of solutions are neutral with respect to each other. Clearly  $\Psi_i > \Psi_j$  is needed at each Stokes line and  $(\Psi_i, \Psi_j)$  at each anti-Stokes line. Thus if a  $\Psi_1 > \Psi_2$  Stokes line is crossed the coefficient of  $\Psi_2$  undergoes Stokes phenomenon unless  $\Psi_1$  is not present. Notice that along the real axis for  $y > y_+$  and  $y < y_-$  we have coincident Stokes and anti-Stokes lines. At first this seems like a contradiction but it is not for the following reason. The anti-Stokes line means that the pair  $(\Psi_1, \Psi_4)$  is neutral, as is  $(\Psi_2, \Psi_3)$ . But according to the Stokes line  $\Psi_1 > \Psi_3$  and  $\Psi_4 > \Psi_2$ . Taken together these statements imply  $(\Psi_1, \Psi_4) > (\Psi_2, \Psi_3)$ , or in words, the neutral pair  $(\Psi_1, \Psi_4)$  is maximally dominant and  $(\Psi_2, \Psi_3)$

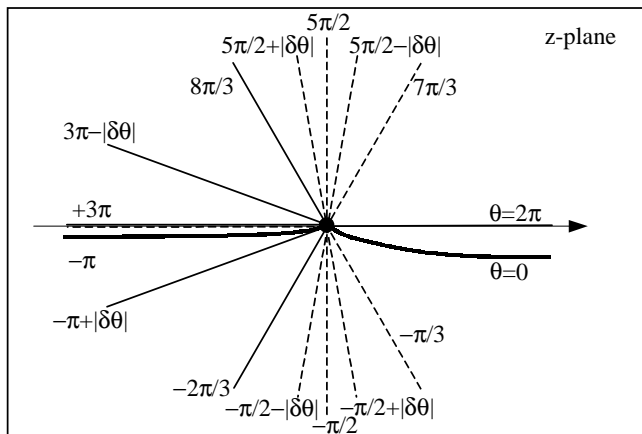

FIG. 15 Stokes and anti-Stokes lines around  $y_-$

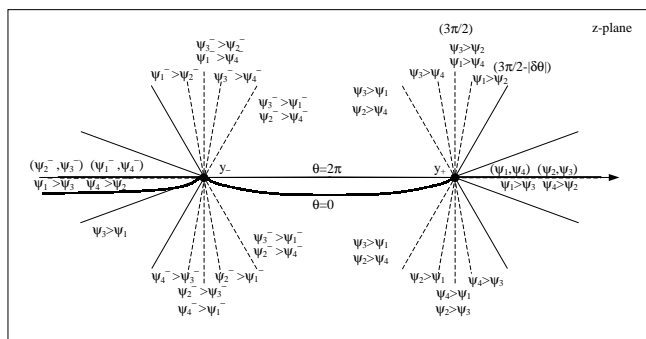

FIG. 16 Location of the Stokes and anti-Stokes lines for the SNS junction problem when there are four WKB solutions to consider.

$\phi_i^- - \phi_j^-$	$\phi_2^- - \phi_1^-$	$\phi_3^- - \phi_1^-$	$\phi_2^- - \phi_4^-$	$\phi_4^- - \phi_1^-$	$\phi_2^- - \phi_3^-$	$\phi_4^- - \phi_3^-$
$\phi_i^- - \phi_j^- =$	$\frac{i}{\hbar}\{\}_+ - \frac{-i}{\hbar}\{\}_+$	$-\frac{i}{\hbar}\{\}_- - \frac{-i}{\hbar}\{\}_+$		$\frac{i}{\hbar}\{\}_+ - \frac{-i}{\hbar}\{\}_-$		$\frac{i}{\hbar}\{\}_- - \frac{-i}{\hbar}\{\}_-$
$\text{Im}\{\phi_i - \phi_j\} \propto$	$\cos \theta + \text{fn}(r) \cos\left(\frac{3\theta}{2}\right)$	$r^{3/2} \cos\left(\frac{3\theta}{2}\right)$		$r \cos \theta$		$\cos \theta - \text{fn}(r) \cos\left(\frac{3\theta}{2}\right)$
$\theta_{\text{Im}(\phi_i^- - \phi_j^-)=0}$ and $\text{Re}\{\phi_\ell^-\} > \text{Re}\{\phi_m^-\}$ $\Psi_\ell > \Psi_m$ $\Updownarrow$	$\theta_1$	$-\frac{\pi}{2} +  \delta\theta , \Psi_2^- > \Psi_1^-$	$-\frac{\pi}{3}, \Psi_3^- > \Psi_1^-, \Psi_2^- > \Psi_4^-$	$\frac{\pi}{2}, \Psi_4^- > \Psi_1^-, \Psi_2^- > \Psi_3^-$	$-\frac{\pi}{2} -  \delta\theta , \Psi_4^- > \Psi_3^-$	
	$\theta_2$	$\frac{5\pi}{2} +  \delta\theta , \Psi_1^- > \Psi_2^-$	$-\pi, \Psi_1^- > \Psi_3^-, \Psi_4^- > \Psi_2^-$	$+\frac{5\pi}{2}, \Psi_1^- > \Psi_4^-, \Psi_3^- > \Psi_2^-$	$\frac{5\pi}{2} -  \delta\theta , \Psi_3^- > \Psi_4^-$	
	$\theta_3$	—	$\frac{5\pi}{3}, \Psi_3^- > \Psi_1^-, \Psi_2^- > \Psi_4^-$	—	—	
$\text{Re}\{\phi_i^- - \phi_j^-\} \propto$	$\sin \theta + \text{fn}(r) \sin\left(\frac{3\theta}{2}\right)$	$-r^{3/2} \sin\left(\frac{3\theta}{2}\right)$		$-r \sin \theta$		$\sin \theta - \text{fn}(r) \sin\left(\frac{3\theta}{2}\right)$
$\theta_{\text{Re}(\phi_i^- - \phi_j^-)=0, \Updownarrow}(\Psi_i^-, \Psi_j^-)$ (see column heading for neutral pair)	$\theta_1$	0	0	0	0	
	$\theta_2$	$-\pi +  \delta\theta ,$	$-\frac{2\pi}{3}$	$-\pi$	$3\pi -  \delta\theta $	
	$\theta_3$	$2\pi$	$\frac{8\pi}{3}$	$2\pi$	$2\pi$	
	$\theta_4$	—	—	$3\pi$	—	

TABLE 3: Summary of Stokes lines and anti-Stokes lines located around the turning point  $y_-$ .

maximally subdominant. Explicitly the solution along  $y > y^+$  which decays is

$$\Psi_{y>y_+}(y) = A\Psi_2 + B\Psi_3, \quad (\text{C.179})$$

$$\begin{aligned} &= \frac{A}{\sqrt{\left(\frac{\partial E}{\partial p_y}\right)_{p_y^+(y)}}} \left( u_{0,I}^+(y)e^{+i\phi/2} \right) e^{+\frac{i}{\hbar} \int_{y_+}^y p_y^r(y') dy'} e^{-\frac{1}{\hbar} \left| \int_{y_+}^{y_+} p_y^i(y') dy' \right|} \\ &+ \frac{B}{\sqrt{\left(\frac{\partial E}{\partial p_y}\right)_{p_y^-(y)}}} \left( u_{0,I}^-(y)e^{+i\phi/2} \right) e^{-\frac{i}{\hbar} \int_{y_+}^y p_y^r(y') dy'} e^{-\frac{1}{\hbar} \left| \int_{y_+}^{y_+} p_y^i(y') dy' \right|}, \end{aligned} \quad (\text{C.180})$$

where the modulus in the exponent ensures an evanescent solution. In (C.180) we have used  $p_y^r$  and  $p_y^i$  to represent the real and imaginary parts respectively of the momentum. Note that  $p_y^+ = (p_y^-)^*$  so that the real parts are the same. Now we can understand fully the more general definitions of the Stokes lines and anti-Stokes lines. The pair  $(\Psi_2, \Psi_3)$  are neutral because they have a common damping factor, neither is more damped than the other. It is only the real part of the exponents,  $\phi_i, \phi_j$ , which control this hence  $\text{Re}\{\phi_i - \phi_j\} = 0$  is the general anti-Stokes condition. The exponentially growing solution is

$$\Psi_{y>y_+}(y) = C\Psi_1 + D\Psi_4, \quad (\text{C.181})$$

$$\begin{aligned} &= \frac{C}{\sqrt{\left(\frac{\partial E}{\partial p_y}\right)_{p_y^+(y)}}} \left( u_{0,I}^+(y)e^{+i\phi/2} \right) e^{-\frac{i}{\hbar} \int_{y_+}^y p_y^r(y') dy'} e^{+\frac{1}{\hbar} \left| \int_{y_+}^{y_+} p_y^i(y') dy' \right|} \\ &+ \frac{D}{\sqrt{\left(\frac{\partial E}{\partial p_y}\right)_{p_y^-(y)}}} \left( u_{0,I}^-(y)e^{+i\phi/2} \right) e^{+\frac{i}{\hbar} \int_{y_+}^y p_y^r(y') dy'} e^{+\frac{1}{\hbar} \left| \int_{y_+}^{y_+} p_y^i(y') dy' \right|}. \end{aligned} \quad (\text{C.182})$$

Comparing this with (C.180) we see that  $\Psi_1$  and  $\Psi_3$  have the same oscillatory part, likewise  $\Psi_4$  and  $\Psi_2$ . Again attention is focused on the real part,  $\text{Re}\{\phi_{1,4}\} > \text{Re}\{\phi_{2,3}\}$ , because we can discount the common phase. The condition for discounting the phase is the general Stokes-line statement  $\text{Im}\{\phi_i - \phi_j\} = 0$ .

Suppose we start along  $y > y_+$  with the decaying solution (C.179). If we follow the solution around  $y_+$  in the upper half plane (see FIG. 14 page 58) we expect the first Stokes jump to occur at  $\theta = +3\pi/2$ . Continuing around to  $\theta = +2\pi$  we expect to have had four Stokes jumps and hence four Stokes constants are introduced. All four solutions are then present on the real  $y$ -axis between the turning points. The solution along  $y < y_-$

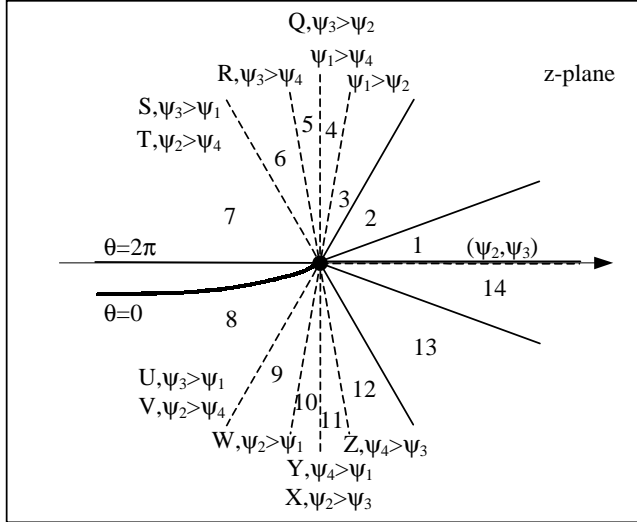

FIG. 17 Stokes - - - and anti-Stokes — lines around  $y_+$ .

would in principle contain 10 Stokes constants. Fortunately there is a quite remarkable simplification as will be seen in the next section when we calculate the Stokes constants.

This concludes our discussion about Stokes and anti-Stokes lines.

### C.7. Calculation of Stokes constants

Stokes constants can be calculated by following the changes of a solution when passing all the way around a turning point and back to the starting point.

We will now calculate the Stokes constants corresponding to the Stokes lines in figures 14 and 15. We shall follow the changes in a solution, evanescent along  $y > y_+$ , as we move around  $y_+$  in the complex plane. We will need to know what to do when crossing the branch cut along  $y < y_+$ .

FIG. 17 shows the various sectors in the complex plane, and we have also included a Stokes constant corresponding to each condition  $\Psi_i > \Psi_j$  which is relevant when starting from the evanescent pair  $(\Psi_2, \Psi_3)$ . Notice that while we require the solution for  $y > y_+$  to decay in order to satisfy the physical boundary conditions any arbitrary combination of  $\Psi_2$  and  $\Psi_3$  have this property. Thus we consider  $\Psi = A\Psi_2 + B\Psi_3$  ( $A, B$  arbitrary). In what follows the numbers indicate the sector under consideration and next



to them we have written the form of the solution in that sector. We have:

$$\begin{aligned}
1-4: & A\Psi_2 + B\Psi_3 \\
5: & (A + BQ)\Psi_2 + B\Psi_3 \\
6: & (A + BQ)\Psi_2 + B\Psi_3 + BR\Psi_4 \\
7: & SB\Psi_1 + (A + BQ)\Psi_2 + B\Psi_3 \\
& + (BR + (A + BQ)T)\Psi_4 \\
8: & -iSB\Psi_3 - i(A + BQ)\Psi_4 - iB\Psi_1 \\
& -i(BR + (A + BQ)T)\Psi_2 \\
9: & -iB(1 + SU)\Psi_1 + \text{same } \Psi_2, \Psi_3, \\
& -i(A + BQ + (BR + (A + BQ)T)V)\Psi_4 \\
10: & -i(B(1 + SU) + W(BR + (A + BQ)T))\Psi_1 \\
& + \text{same } \Psi_2, \Psi_3, \Psi_4 \\
11: & -i(B(1 + SU) + W(BR + (A + BQ)T) \\
& + Y(A + BQ + (BR + (A + BQ)T)V))\Psi_1 \\
& + \text{same } \Psi_2, \Psi_4, \\
& -i(SB + X(BR + (A + BQ)T))\Psi_3 \\
12-14: & -i(B(1 + SU) + W(BR + (A + BQ)T) \\
& + Y(A + BQ + (BR + (A + BQ)T)V))\Psi_1 \\
& -i(BR + (A + BQ)T)\Psi_2 \\
& -i(SB + X(BR + (A + BQ)T) \\
& + Z(A + BQ + (BR + (A + BQ)T)V))\Psi_3 \\
& -i(A + BQ + (BR + (A + BQ)T)V)\Psi_4
\end{aligned} \tag{C.183}$$

Comparing the solution in sector 14 with that in 1 fixes the Stokes constants. To help us here we are allowed to treat each equation obtained by equating coefficients as two equations because the parts depending upon  $A$  and  $B$  can be matched separately (remember  $A$  and  $B$  were arbitrary so we can vary either independently). Thus for instance matching the coefficient of  $\Psi_2$  gives

$$A = -i(BR + (A + BQ)T)$$

or

$$1 = -iT \quad (\text{from varying } A), \tag{C.184}$$

$$0 = R + QT \quad (\text{from varying } B). \tag{C.185}$$

(C.184) gives  $T = +i$ . Proceeding similarly we find

$$\begin{aligned}
S = T = U = V &= +i, \\
Q = R = W = X &= 0.
\end{aligned}$$

$Y$  and  $Z$  are undetermined but this does not matter because we can avoid crossing the corresponding Stokes lines when solving the two turning point problem.

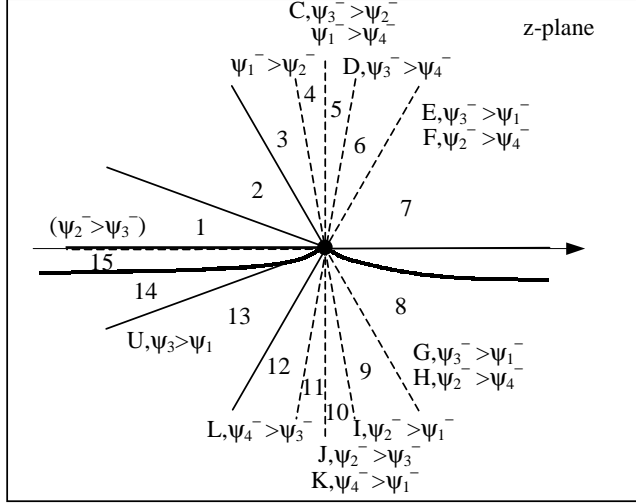

FIG. 18 Stokes - - - and anti-Stokes — lines around  $y_-$ .

Calculating Stokes constants around  $y_-$  proceeds in exactly the same way. FIG. 18 shows the various constants. (The extra branch cut between sectors 14 and 15 means  $\Psi_i^-(z_{14}) = -\Psi_i^-(z_{15})$ .) Note however that moving through the sectors  $1 \rightarrow 14$  we are moving around  $y_-$  in the negative (clockwise) sense and we require Stokes constants in the positive sense. Taking this into account we find

$$E = F = G = H = +i,$$

$$C = D = I = J = 0.$$

$K$  and  $L$  are undetermined, but again they will not be needed.

### C.8. Discussion of Stokes constants

We have found that all the constants are zero apart from those corresponding to  $\theta = +\pi/3, +5\pi/3$  around  $y_+$  and  $\theta = -\pi/3, +7\pi/3$  around  $y_-$ . This is surprising since it appeared that the sufficient condition for Stokes phenomenon to occur was given by (C.132). If we consider again going around  $y_+$  we find the following is true

$$\Psi_3 \text{ only 'sees' } \Psi_1,$$

$$\Psi_2 \text{ only 'sees' } \Psi_4.$$

Return to the definitions of  $\Psi_i$ , equations (C.134)-(C.137), then we observe that the exponent of  $\Psi_1$  depends upon  $+p_y^+$ , and  $\Psi_3$  upon  $+p_y^-$ , whilst  $\Psi_2$  and  $\Psi_4$  depend upon  $-p_y^+$  and  $-p_y^-$  respectively. This is the resolution of

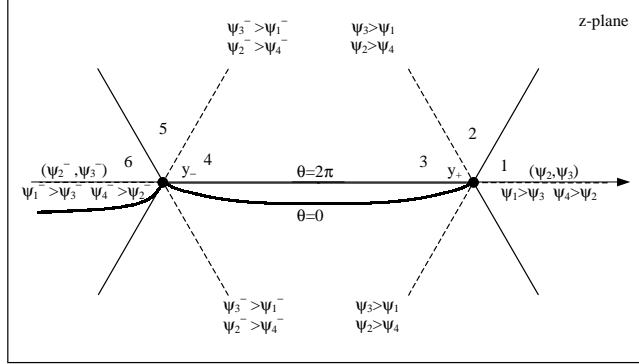

**FIG. 19** Location of Stokes lines and anti-Stokes lines once the simplification due to disjoint Riemann sheets has been taken into account.

the problem. When analytically continuing around the complex plane  $p_y^+$  can be continued to  $p_y^-$  and likewise  $-p_y^+$  to  $-p_y^-$ , but there is no way (at least locally in the plane) for  $p_y^+$  to be continued to  $-p_y^+$ . This would require the real part of  $p_y^+$  to pass through zero, but we have assumed  $p_F^2 - p_x^2 - p_z^2$  is large so that  $\pm 2m\sqrt{E^2 - \Delta^2(z)}$  cannot reduce the momentum to zero. However one might imagine that  $|\Delta(y)|$  analytically continued into the complex plane may have singularities and might therefore reduce  $p_y^+$  to zero somewhere. For the moment at least we had better say that

if *locally* in the complex plane solutions cannot be analytically continued one into another then there will be no Stokes phenomenon between them.

To put it another way, solutions on disjoint pieces of a Riemann surface do not experience Stokes phenomenon. Note that  $p_y(z)$  has two sheets (corresponding to  $p_y(z=y) = p_y^+(y)$  and  $p_y(z=y) = p_y^-(y)$ ) and  $-p_y(z)$  also has two sheets  $-p_y^+$  and  $-p_y^-$ , but although all four sheets make up the Riemann surface for the solution the sheets exist in mutually disjoint pairs.

### C.9. Derivation of a generalised Bohr-Sommerfeld quantisation rule

Returning to the problem at hand it is clear that a significant simplification of FIG. 16 is possible. We need only consider those Stokes lines (shown in figure 19) whose Stokes constants are non-zero. These Stokes constants are all  $+i$  when the lines are crossed in the positive sense. Finally then, let us follow the evolution of an evanescent solution constructed

out of  $\Psi_2$  and  $\Psi_3$  through sectors 1  $\rightarrow$  6. We have:

$$\begin{aligned}
1 - 2 : & A\Psi_2 + B\Psi_3 \\
3 : & iB\Psi_1 + A\Psi_2 + B\Psi_3 + iA\Psi_4 \\
4 : & iB[1]\Psi_1^- + A[2]\Psi_2^- + B[3]\Psi_3^- + iA[4]\Psi_4^- \\
5 - 6 : & iB([1] + [3])\Psi_1^- + A[2]\Psi_2^- + B[3]\Psi_3^- \\
& + iA([4] + [2])\Psi_4^-.
\end{aligned} \tag{C.186}$$

Now for  $y < y_-$  the evanescent solution must consist of  $\Psi_2^-$  and  $\Psi_3^-$  only so the coefficients of  $\Psi_1^-$  and  $\Psi_4^-$  must both be zero. For  $\Psi_1^-$  this yields

$$\begin{aligned}
[1] + [3] &= 0, \\
\frac{[1]}{[3]} &= -1,
\end{aligned}$$

or

$$e^{\frac{i}{\hbar} \int_{y_-}^{y_+} p_y^+(y') dy' - \frac{i}{\hbar} \int_{y_-}^{y_+} p_y^-(y') dy'} = e^{i\pi(2n+1)}.$$

We have derived the quantisation condition

$$\frac{1}{\hbar} \int_{y_-}^{y_+} p_y^+(y') - p_y^-(y') dy' = 2\pi \left( n + \frac{1}{2} \right), \tag{C.187}$$

used earlier (equation (4.72)) to derive the Andreev spectrum but we have also found the turning point correction  $\gamma = 1/2$ , i.e. the Maslov index  $m = 2$ . This is what is expected for the Maslov index of a Lagrangian manifold which is topologically a circle. In the present case, from our approach, we see each turning point introduces a phase change of  $\pi/2$ , i.e. contributes 1 to the Maslov index (see (C.187)), whenever the local topology of the Riemann sheets in the vicinity of the turning point consists of two sheets. This concludes our derivation of the quantisation condition.

Before leaving this section we wish to comment that in the main body of this paper the explicit solutions are written down for each region. Since we require these for  $z = y$ , between the turning points, and our solutions in sector 3 and 4 are for  $z = ye^{i2\pi}$ , we must take the functional forms  $\Psi_i(ye^{i2\pi})$  and rewrite them in terms of  $\Psi_i(y)$  i.e., we must follow the solutions in sector 3 across the branch cut connecting  $y_+$  and  $y_-$ . Again we use the rules (C.155)-(C.158), and (C.159)-(C.162). Thus for example the solution  $\Psi_B(y)$ , equation (4.87), was obtained by following the solution in sector 3:

$$\Psi_B(z_{\text{above}}) = iB\Psi_1 + A\Psi_2 + B\Psi_3 + iA\Psi_4,$$

across the cut to obtain

$$\Psi_B(z_{\text{below}}) = B\Psi_3 - iA\Psi_4 - iB\Psi_1 + A\Psi_2,$$

and then explicitly evaluating this at  $z_{\text{below}} = y$ .

The prefactors

$$\left(\frac{\partial E}{\partial p_y}\right)_{p_y^\beta}^{-1/2} \begin{pmatrix} u_{0,I}^\beta(y)e^{+i\phi/2} \\ v_{0,I}^\beta(y)e^{-i\phi/2} \end{pmatrix},$$

in the regions  $y < y_-$  and  $y_+ < y$  are complex and can be shown to be

$$\left(\frac{\partial E}{\partial p_y}\right)_{p_y^\beta}^{-1/2} \begin{pmatrix} u_{0,I}^\beta(y)e^{+i\phi/2} \\ v_{0,I}^\beta(y)e^{-i\phi/2} \end{pmatrix} = a(y) \begin{pmatrix} e^{+i\beta\delta(y)+i\phi/2} \\ e^{-i\beta\delta(y)-i\phi/2} \end{pmatrix} e^{+i\beta\theta(y)-i\phi/4}, \quad (\text{C.188})$$

where

$$a(y) = \frac{1}{\sqrt{2}} \left( \frac{m^{1/2}}{(p_F^2 - p_\perp^2)^{1/4}} \right) \left( 1 - \frac{E^2}{|\Delta(y)|^2} \right)^{-1/4} \left( 1 + \frac{|\Delta(y)|^2 - E^2}{\epsilon_\perp^2} \right)^{-1/8},$$

$$\theta(y) = -\frac{1}{4} \arctan \frac{\sqrt{|\Delta(y)|^2 - E^2}}{\epsilon_\perp},$$

$$\delta(y) = \frac{1}{2} \arctan \frac{\sqrt{|\Delta(y)|^2 - E^2}}{E}.$$

#### APPENDIX D: LIMITING BEHAVIOUR OF BOTH SEMICLASSICAL WAVE FUNCTIONS AND THE EXACT SOLUTION AT THE ORIGIN OF A VORTEX

We now show that the limiting,  $r \rightarrow 0$ , behaviour of both the semiclassical wave function presented in section 2.3 and the wave function of the effective semiclassical theory derived in section 3.2 agree with the known exact solution of the Bogoliubov-de Gennes equation at the origin of a s-wave vortex.

##### D.1. Asymptotic behaviour of the exact solution

It is well known [1] that in the  $r \rightarrow 0$  limit the BdG equations can be solved exactly. Writing the wave function in the form

$$\begin{pmatrix} u_{\mathbf{I}}(\mathbf{r}) \\ v_{\mathbf{I}}(\mathbf{r}) \end{pmatrix} = \hat{f}(r) e^{ik_z z} e^{i\mu\theta} e^{-i\sigma_z\theta/2},$$

the BdG equations are reduced to a radial equation for  $\hat{f}(r)$ :

$$\sigma_z \frac{-\hbar^2}{2m} \left( \frac{1}{r} \frac{\partial}{\partial r} r \frac{\partial}{\partial r} - \frac{1}{r^2} \left( \mu - \sigma_z \frac{1}{2} \right)^2 + k_\rho^2 + \sigma_z \frac{2mE}{\hbar^2} \right) \hat{f}(r) = 0, \quad (\text{D.189})$$

(since  $|\Delta(r)| \rightarrow 0$  as  $r \rightarrow 0$ .) Here  $k_\rho^2 = k_F^2 - k_z^2$ ,  $k_F$  the Fermi wave vector, and  $\sigma_z$  is a Pauli spin matrix. This equation has the  $J_\nu(z)$  Bessel functions as solutions:

$$\hat{f}(r) = \begin{pmatrix} A_+ J_{\mu-1/2}((k_\rho + q)r) \\ A_- J_{\mu+1/2}((k_\rho - q)r) \end{pmatrix}, \quad (\text{D.190})$$

where,  $\mu \pm 1/2$  are integers, and following de Gennes et al, we use  $k_\rho^2 \pm 2mE/\hbar^2 \approx k_\rho^2 (1 \pm q/k_\rho)^2$ , with  $q = 2mE/\hbar^2 k_\rho$ . Using the asymptotic form [36] for the  $J_\nu(z) \sim (\frac{1}{2}z)^\nu / \Gamma(\nu + 1)$  we see that the  $r \rightarrow 0$  limit for  $\hat{f}(r)$  is

$$\hat{f}(r) = \begin{pmatrix} A_+^\nu r^\nu \\ A_-^\nu r^{\nu+1} \end{pmatrix}, \quad (\text{D.191})$$

where  $\nu = \mu - 1/2$ , i.e. there is integer power law decay of the particle and hole wave functions approaching the origin.

## D.2. Asymptotic behaviour of the semiclassical wave functions

Our two semiclassical wave functions are:

$$\begin{pmatrix} u_{\mathbf{I}(\mathbf{r})} \\ v_{\mathbf{I}(\mathbf{r})} \end{pmatrix}_\alpha = \sum_j A_j^\alpha \left| \det \frac{\partial^2 S_0^{\alpha,j}(\mathbf{r}, \mathbf{I})}{\partial \mathbf{I} \partial \mathbf{r}} \right|^{1/2} \begin{pmatrix} u_{0,\mathbf{I}}^{\alpha,j}(\mathbf{r}) e^{+i\phi(\mathbf{r})/2} \\ v_{0,\mathbf{I}}^{\alpha,j}(\mathbf{r}) e^{-i\phi(\mathbf{r})/2} \end{pmatrix} \\ \times e^{\frac{i}{\hbar} S_0^{\alpha,j}(\mathbf{r}) + i S_1^{\alpha,j}(\mathbf{r})}, \quad \hbar \rightarrow 0,$$

and

$$\begin{pmatrix} u_{\mathbf{I}(\mathbf{r})} \\ v_{\mathbf{I}(\mathbf{r})} \end{pmatrix}_\alpha = \sum_j A_j^\alpha \left| \det \frac{\partial^2 S^{\alpha,j}(\mathbf{r}, \mathbf{I})}{\partial \mathbf{I} \partial \mathbf{r}} \right|^{1/2} \begin{pmatrix} u_{0,\mathbf{I}}^{\alpha,j}(\mathbf{r}; \hbar) e^{+i\phi(\mathbf{r})/2} \\ v_{0,\mathbf{I}}^{\alpha,j}(\mathbf{r}; \hbar) e^{-i\phi(\mathbf{r})/2} \end{pmatrix} \\ \times e^{\frac{i}{\hbar} S^{\alpha,j}(\mathbf{r}; \hbar)}, \quad \hat{\mathbf{p}} \rightarrow 0.$$

For the single vortex problem these become:

$$\begin{pmatrix} u_{\mathbf{I}(\mathbf{r})} \\ v_{\mathbf{I}(\mathbf{r})} \end{pmatrix} = \sum_j \hat{f}^j(r) e^{+ik_z z + i\mu\theta - i\sigma_z \theta}, \quad \hbar \rightarrow 0, \\ \begin{pmatrix} u_{\mathbf{I}(\mathbf{r})} \\ v_{\mathbf{I}(\mathbf{r})} \end{pmatrix} = \sum_j \hat{f}^j(r; \hbar) e^{+ik_z z + i\mu\theta - i\sigma_z \theta}, \quad \hat{\mathbf{p}} \rightarrow 0.$$

with

$$\hat{f}^j(r) = \frac{A^j}{\sqrt{r \frac{\partial E_0(\mathbf{p}, r)}{\partial r}}} \begin{pmatrix} u_{0,\mathbf{I}}^j(r) \\ v_{0,\mathbf{I}}^j(r) \end{pmatrix} e^{\frac{i}{\hbar} S_0^j(r) + i S_1^j(r)}, \quad (\text{D.192})$$

$$\hat{f}^j(r; \hbar) = \frac{A^j}{\sqrt{r \frac{\partial E(\mathbf{p}, r)}{\partial r}}} \begin{pmatrix} u_{0,\mathbf{I}}^j(r; \hbar) \\ v_{0,\mathbf{I}}^j(r; \hbar) \end{pmatrix} e^{\frac{i}{\hbar} S^j(r; \hbar)}. \quad (\text{D.193})$$

Let us investigate these in turn.

D.2.1. The  $r \rightarrow 0$  form for  $\hat{f}^j(r)$

The spinor amplitudes in (D.192) are given by equation (2.26). Expanding as  $r \rightarrow 0$ , and noting that  $\mathbf{v}_0 = e\mathbf{A}/m = 0$ , we obtain

$$\begin{aligned} \begin{pmatrix} u_{0,\mathbf{I}}^+(r) \\ v_{0,\mathbf{I}}^+(r) \end{pmatrix} &= \begin{pmatrix} 1 \\ 0 \end{pmatrix} + \mathcal{O}(r) \begin{pmatrix} 0 \\ 1 \end{pmatrix}, \\ \begin{pmatrix} u_{0,\mathbf{I}}^-(r) \\ v_{0,\mathbf{I}}^-(r) \end{pmatrix} &= \begin{pmatrix} 0 \\ 1 \end{pmatrix} + \mathcal{O}(r) \begin{pmatrix} 1 \\ 0 \end{pmatrix}. \end{aligned}$$

(Here we have assumed  $|\Delta(r)| \propto r$ .) We also have:

$$\begin{aligned} p_r^\pm(r) &= \sqrt{p_F^2 - p_z^2 - \frac{\hbar^2 \mu^2}{r^2} \pm 2m\sqrt{E^2 - |\Delta(r)|^2}}, \\ &= i\hbar \frac{|\mu|}{r} + \mathcal{O}(r), \end{aligned} \tag{D.194}$$

from which it follows that

$$\frac{1}{\sqrt{r \frac{\partial E_0(\mathbf{p}, r)}{\partial r}}} = \frac{e^{-i\pi/4}}{(\hbar\mu)^{1/2}} + \mathcal{O}(r^2),$$

and since

$$\frac{i}{\hbar} \int_r^{r_{a,b}} p_r^\pm(r) dr = \ln \left( \frac{r}{r_{a,b}} \right)^{|\mu|} + \mathcal{O}(r^2),$$

we have

$$e^{\frac{i}{\hbar} S_0^\pm(r)} = \left( \frac{r}{r_{a,b}} \right)^{|\mu|} + \mathcal{O}(r^{|\mu|+2}).$$

In the last two equations the phase reference point  $r_a$  ( $r_b$ ) is chosen to be the classical turning point defined by  $p^+(r_a) = 0$  ( $p^-(r_b) = 0$ ). We have not yet calculated  $S_1(r)$ , but if we assume it can be neglected the appropriate superposition as  $r \rightarrow 0$ , call it  $\hat{f}_{\hbar}(r)$ , takes the form

$$\hat{f}_{\hbar}(r) = \frac{e^{-i\pi/4}}{(\hbar\mu)^{1/2}} \begin{pmatrix} A^+(r/r_a)^{\nu+1/2} \\ A^-(r/r_b)^{\nu+1/2} \end{pmatrix} + \mathcal{O}(r^{\nu+5/2}).$$

In particular we note the *half* integer power law decay of the particle and hole wave functions in contrast to the exact result (D.191). This is completely unsatisfactory. One then hopes that  $S_1^j(r)$  corrects this deficiency. That this is indeed the case can be shown since for this problem  $S_1^j(r)$  can be calculated. Using  $-e^{-1}j_\theta(r) = p_\theta/mr$  We have:

$$\begin{aligned} iS_1^\pm(r) &= \int_t^{t_{a,b}} \frac{ip_\theta}{2mr^2} dt, \\ &= \int_{r(t)}^{r(t_{a,b})} \frac{p_\theta}{2mr^2} \frac{dt}{dr^\pm} dr^\pm, \end{aligned}$$

and using  $\frac{dr^\pm}{dt} = \pm(ip_\theta/mr)(1 + \mathcal{O}(r^2))$

$$\begin{aligned} iS_1^\pm(r) &= \ln\left(\frac{r}{r_{a,b}}\right)^{\mp 1/2} + \mathcal{O}(r^2), \\ \Rightarrow e^{iS_1^\pm(r)} &= \left(\frac{r}{r_{a,b}}\right)^{\mp 1/2} + \mathcal{O}(r^{2\mp 1/2}). \end{aligned} \quad (\text{D.195})$$

Then  $\hat{f}_\hbar(r)$  becomes

$$\hat{f}_\hbar(r) = \frac{e^{-i\pi/4}}{(\hbar\mu)^{1/2}} \begin{pmatrix} A^+(r/r_a)^\nu \\ A^-(r/r_b)^{\nu+1} \end{pmatrix} + \mathcal{O}(r^2).$$

which has the correct integer power law decay as required. By following through this analysis we have discovered the importance of the first order phase,  $S_1^j(r)$ . We have also checked that the semiclassical theory carried out correctly gives not only a quantisation rule but also the wave function as well. Does our effective semiclassical theory do as well?

#### D.2.2. The $r \rightarrow 0$ form for $\hat{f}^j(r; \hbar)$

The spinor amplitudes in (D.193) are given by equation (3.44). Expanding these as  $r \rightarrow 0$  we obtain

$$\begin{aligned} \begin{pmatrix} u_{0,\mathbf{I}}^+(r; \hbar) \\ v_{0,\mathbf{I}}^+(r; \hbar) \end{pmatrix} &= \begin{pmatrix} 1 \\ 0 \end{pmatrix} + \mathcal{O}(r^3) \begin{pmatrix} 0 \\ 1 \end{pmatrix}, \\ \begin{pmatrix} u_{0,\mathbf{I}}^-(r; \hbar) \\ v_{0,\mathbf{I}}^-(r; \hbar) \end{pmatrix} &= \begin{pmatrix} 0 \\ 1 \end{pmatrix} + \mathcal{O}(r^3) \begin{pmatrix} 1 \\ 0 \end{pmatrix}. \end{aligned}$$

The  $r^3$  rather than  $r$  correction arises since  $\mathbf{v}_s = -\hbar/2mr$  so that  $\mathbf{p} \cdot \mathbf{v}_s = -\hbar p_\theta/2mr^2$ .

Now

$$\begin{aligned} p_r^\pm(r; \hbar) &= \sqrt{p_F^2 - p_z^2 - \frac{\hbar^2(\mu^2 + 1/4)}{r^2} \pm 2m\sqrt{\left(E + \frac{\hbar^2\mu}{2mr^2}\right)^2 - |\Delta(r)|^2}}, \\ &= i\hbar \frac{|\mu \mp 1/2|}{r} + \mathcal{O}(r). \end{aligned} \quad (\text{D.196})$$

Notice the appearance of  $|\mu \mp 1/2|$  here rather than  $|\mu|$  in equation (D.194). It follows from this that

$$\frac{1}{\sqrt{r \frac{\partial E(\mathbf{p}, r)}{\partial r}}} = \frac{e^{-i\pi/4}}{\hbar^{1/2}(\mu \mp 1/2)^{1/2}} + \mathcal{O}(r^2),$$



and

$$e^{\frac{i}{\hbar}S^\pm(r)} = \left(\frac{r}{r_{a,b}}\right)^{|\mu \mp 1/2|} + \mathcal{O}(r^{|\mu \mp 1/2|+2}).$$

Thus the appropriate combination, call it  $\hat{f}_{\mathbf{p}}^j(r; \hbar)$ , takes the form

$$\hat{f}_{\mathbf{p}}(r; \hbar) = \frac{e^{-i\pi/4}}{(\hbar\mu)^{1/2}} \begin{pmatrix} A^+ \frac{(\nu-1/2)}{\nu} (r/r_a)^\nu \\ A^- \frac{(\nu+1/2)}{\nu} (r/r_b)^{\nu+1} \end{pmatrix} + \mathcal{O}(r^2).$$

which has the correct integer power law decay agreeing with the previous two solutions. In the present case the inclusion of the  $1/4$  in equation (D.196) was crucial to obtain the dependence upon  $|\mu \pm 1/2|$ . This  $1/4$  appears in the  $p_r^\pm$  due to the inclusion in the Hamiltonian, equation (5.90), of  $\hbar^2$  terms. This confirms that our procedure, differing from that proposed by Littlejohn and Flynn [17], is the correct one for a semiclassical theory of superconductors.

We have successfully verified both versions of the semiclassical wave function derived in this paper.

#### ACKNOWLEDGMENTS

We would like to thank Michael Berry and Chris Howls for advice concerning Stokes phenomenon, and John Hannay for many enlightening discussions about the semiclassical theory. This work was supported by EPSRC, grant No. GR/M53844.

#### REFERENCES

- [1] P. G. de Gennes. *Superconductivity of Metals and Alloys*. Addison-Wesley, 1989.
- [2] A. F. Andreev. *Sov. Phys. JETP*, 19(5):1228–1238, 1964.
- [3] A. F. Andreev. *Sov. Phys. JETP*, 22(2):455–458, 1966.
- [4] M. Ya. Azbel'. *Sov. Phys. JETP*, 32(1):159, 1971.
- [5] J. Bardeen, R. Kümmel, A.E. Jacobs, and L. Tewordt. *Phy. Rev.*, 187(2), 1969.
- [6] M. C. Gutzwiller. *Chaos in Classical and Quantum Mechanics*. Springer-Verlag, 1990.
- [7] A. M. Ozorio de Almeida. *Hamiltonian Systems: Chaos and Quantization*. Cambridge University Press, 1988.

- [8] M. Brack and R. K. Bhaduri. *Semiclassical Physics*. Addison-Wesley, 1997.
- [9] V. P. Maslov and M. V. Fedoriuk. *Semi-Classical Approximation in Quantum Mechanics*. Riedel Publishing Company, 1981.
- [10] O. Vafek, A. Melikyan, M. Franz, and Z. Tešanović. *Phy. Rev. B*, 63, 2000.
- [11] L. M. Pismen. *Vortices in Nonlinear Fields*. Oxford University Press, 1999.
- [12] P. W. Anderson. cond-mat/9812063.
- [13] V. I. Arnold. *Mathematical methods of classical mechanics*. Springer, 2nd edition, 1989.
- [14] J. H. van Vleck. *Proc. Nat. Acad. Sci. USA*, 14(2):178–188, 1928.
- [15] M. V. Berry. *Proc. R. Soc. Lond A*, 392, 1984.
- [16] J. M. Robbins. *Encyclopedia of Applied Physics*, 21:549–584, 1997.
- [17] R. G. Littlejohn and W. G. Flynn. *Phys. Rev. A*, 44(8):5239–5256, 1991.
- [18] K. Yabana and H. Horiuchi. *Prog. Theor. Phys.*, **75**:592–618, 1986.
- [19] C. Emmrich and A. Weinstein. *Comm. Math. Phys.*, 176:701, 1996.
- [20] H. Goldstein. *Classical Mechanics*. Addison-Wesley, 2 edition, 1980.
- [21] J. Bolte and S. Keppeler. *Ann. Phys. (N.Y)*, 274:125, 1999.
- [22] P. A. M. Dirac. *Proc. R. Soc. A*, 133:60–72, 1931.
- [23] M.V.Berry. *Eur. J. Phys*, 1:240–244, 1980.
- [24] I. O. Kulik. *Sov. Phys. JETP*, 30(5):944–950, 1970.
- [25] J. Bardeen and J. L. Johnson. *Phys. Rev. B*, 5(1):72–78, 1972.
- [26] O. Šipr and B. L. Györfy. *J. Low Temp. Phys.*, 106(3/4):315, 1997.
- [27] A. A. Abrikosov. *Fundamentals of the Theory of Metals*. North-Holland, 1988.
- [28] G. E. Blonder, M. Tinkham, and T. M. Klapwijk. *Phys. Rev. B*, 25(7), 1982.
- [29] C. Caroli, P. G. de Gennes, and J. Matricon. *Phys. Letters*, 9:307, 1964.

- [30] F. Gygi and M. Schlüter. *Phys. Rev. B*, 43(10), 1991.
- [31] K. P. Duncan and B. L. Györfy. unpublished, 1998.
- [32] K. P. Duncan. *The semiclassical theory of the de Haas-van Alphen oscillations in type-II superconductors*. PhD thesis, University of Bristol, 1999.
- [33] K. P. Duncan and B. L. Györfy. to be published.
- [34] A. Altland, B. Simons, and D. Taras-Semchuk. *Adv. Phys.*, 49(3):321–394, 2000.
- [35] J. Heading. *An introduction to phase integral methods*. London:Methuen, 1962.
- [36] M. Abramowitz and I. A. Stegun, editors. *Handbook of mathematical functions*. Dover, 1970.