

CATS AND DOGS, HAIR AND A HERO: A QUINTET OF NEW MILKY WAY COMPANIONS[†]

V. BELOKUROV¹, D. B. ZUCKER¹, N. W. EVANS¹, J. T. KLEyna², S. KOPOSOV³, S. T. HODGKIN¹, M. J. IRWIN¹, G. GILMORE¹, M. I. WILKINSON¹, M. FELLHAUER¹, D. M. BRAMICH¹, P. C. HEWETT¹, S. VIDRIH¹, J. T. A. DE JONG³, J. A. SMITH^{4,5}, H.-W. RIX³, E. F. BELL³, R. F. G. WYSE⁶, H. J. NEWBERG⁷, P. A. MAYEUR^{7,8}, B. YANNY⁹, C. M. ROCKOSI¹⁰, O. Y. GNEDIN¹¹, D. P. SCHNEIDER¹², T. C. BEERS¹³, J. C. BARENTINE¹⁴, H. BREWINGTON¹⁴, J. BRINKMANN¹⁴, M. HARVANEK¹⁴, S. J. KLEINMAN¹⁵, J. KRZESINSKI^{14,16}, D. LONG¹⁴, A. NITTA¹⁷, S. A. SNEDDEN¹⁴

SUBMITTED TO *The Astrophysical Journal*

ABSTRACT

We present five new satellites of the Milky Way discovered in Sloan Digital Sky Survey (SDSS) imaging data, four of which were followed-up with either the Subaru or the Isaac Newton Telescopes. They include four probable new dwarf galaxies – one each in the constellations of Coma Berenices, Canes Venatici, Leo and Hercules – together with one unusually extended globular cluster, Segue 1. We provide distances, absolute magnitudes, half-light radii and color-magnitude diagrams for all five satellites. The morphological features of the color-magnitude diagrams are generally well described by the ridge line of the old, metal-poor globular cluster M92. In the last two years, a total of ten new Milky Way satellites with effective surface brightness $\mu_v \gtrsim 28$ mag arcsec⁻² have been discovered in SDSS data. They are less luminous, more irregular and appear to be more metal-poor than the previously-known nine Milky Way dwarf spheroidals. The relationship between these objects and other populations is discussed. We note that there is a paucity of objects with half-light radii between ~ 40 pc and ~ 100 pc. We conjecture that this may represent the division between star clusters and dwarf galaxies.

Subject headings: galaxies: dwarf – Local Group

1. INTRODUCTION

The known satellite galaxies of the Milky Way all lie within ~ 300 kpc and their brightest stars are resolvable from ground-based telescopes. So, it is possible to acquire an enormous wealth of data on their stellar populations, making the satellite galaxies important objects

in many fields of astrophysics (see e.g., Dolphin 1997; Shetrone et al. 2003; Tolstoy et al. 2004; Pritzl et al. 2005). They have also emerged as a battle-ground in Near-Field Cosmology (Freeman & Bland-Hawthorn 2002). A fundamental prediction of cold dark matter (CDM) theories is an abundance of substructure in the non-linear regime. As noted by Klypin et al. (1999) and Moore et al. (1999), galaxy assembly in CDM cosmologies typically yields an order of magnitude more dark haloes than there were known satellites around the Milky Way.

¹ Institute of Astronomy, University of Cambridge, Madingley Road, Cambridge CB3 0HA, UK;vasily,zucker,nwe@ast.cam.ac.uk

² Institute for Astronomy, University of Hawaii, 2680 Woodlawn Drive, Honolulu, HI 96822

³ Max Planck Institute for Astronomy, Königstuhl 17, 69117 Heidelberg, Germany

⁴ Los Alamos National Laboratory, ISR-4, MS D448, Los Alamos, NM 87545

⁵ Department of Physics and Astronomy, Austin Peay State University, P.O. Box 4608, Clarksville, TN 37040

⁶ The Johns Hopkins University, 3701 San Martin Drive, Baltimore, MD 21218

⁷ Rensselaer Polytechnic Institute, Troy, NY 12180

⁸ Department of Physics, Louisiana Technical University, Ruston, LA 71272

⁹ Fermi National Accelerator Laboratory, P.O. Box 500, Batavia, IL 60510

¹⁰ Lick Observatory, University of California, Santa Cruz, CA 95064

¹¹ Department of Astronomy, Ohio State University, 140 West 18th Avenue, Columbus, OH 43210

¹² Department of Astronomy and Astrophysics, Pennsylvania State University, 525 Davey Laboratory, University Park, PA 16802

¹³ Department of Physics and Astronomy, CSCE: Center for the Study of Cosmic Evolution, and JINA: Joint Institute for Nuclear Astrophysics, Michigan State University, East Lansing, MI 48824

¹⁴ Apache Point Observatory, P.O. Box 59, Sunspot, NM 88349

¹⁵ Subaru Telescope, 650 N. A'ohoku Place, Hilo, HI 96720

¹⁶ Mt. Suhora Observatory, Cracow Pedagogical University, ul. Podchorazych 2, 30-084 Cracow, Poland

¹⁷ Gemini Observatory, 670 N. A'ohoku Place, Hilo, HI 96720

[†] Based in part on data collected at Subaru Telescope, which is operated by the National Astronomical Observatory of Japan.

Prior to the Sloan Digital Sky Survey (SDSS; York et al. 2000), there were 9 widely-accepted Milky Way dwarf spheroidals (dSphs), namely Draco, Ursa Minor, Fornax, Carina, Sculptor, Leo I, Leo II, Sextans and Sagittarius. Seven of the Milky Way dSphs were discovered by eye using photographic plates. The eighth, Sextans, was found by Irwin et al. (1990) as part of a search of automated scans of photographic plates, whilst the ninth, Sagittarius, was first identified kinematically from radial velocity surveys of the Galactic bulge (Ibata et al. 1995). The number of known Milky Way dSph satellites had been increasing at a rate of one or two per decade before the advent of SDSS.

The impact of SDSS has been dramatic. Four new Milky Way dSph satellites have been discovered in SDSS data in quick succession: Ursa Major (Willman et al. 2005a), Canes Venatici (Zucker et al. 2006a), Boötes (Belokurov et al. 2006b) and Ursa Major II (Zucker et al. 2006c; Grillmair 2006), together with what appears to be an unusually extended globular cluster (Willman et al. 2005b). None are apparent in SDSS images, but all are very clearly identifiable as overdensities of resolved stellar objects. This paper presents a further five new satellites found in SDSS data, one each

in the constellations of Coma Berenices, Canes Venatici, Hercules, and two in Leo. We have confirmed four of these discoveries with follow-up photometry on the Subaru telescope on Mauna Kea and the Isaac Newton Telescope on La Palma. This brings the total number of Milky Way companions found with SDSS data to ten, eight of them probable dSphs. This roughly doubles the number known prior to SDSS. They have eluded previous discovery because they are all of low surface brightness ($\mu_v \gtrsim 28 \text{ mag arcsec}^{-2}$).

In fact, recent years have seen the discovery of a number of objects that blur the hitherto clear distinction between star clusters and dwarf galaxies. These include the ultra compact dwarf galaxies in the Fornax cluster (e.g., Hilker et al. 1999; Drinkwater et al. 2000; Mieske et al. 2002), the globular clusters with unusually large half-light radii in M31 (Huxor et al. 2005) and the faint dSphs around M31 (Zucker et al. 2006b; Martin et al. 2006). The 10 new SDSS discoveries all lie in this poorly charted territory, where – in the absence of kinematic data – the distinction between star clusters and dwarf galaxies is hazy.

The paper is organised as follows: §2 provides a summary of the SDSS and follow-up photometry on our 5 new discoveries, together with a table of their properties. §3 reviews the relationship between globular clusters and dwarf galaxies in the light of our new data, and considers the implications of our discoveries for Near-Field Cosmology. §4 summarizes our conclusions.

2. DISCOVERY AND FOLLOW-UP

2.1. Data Acquisition and Analysis

SDSS imaging data are produced in five photometric bands, namely u , g , r , i , and z (Fukugita et al. 1996; Gunn et al. 1998; Hogg et al. 2001; Adelman-McCarthy et al. 2006; Gunn et al. 2006). The data are automatically processed through pipelines to measure photometric and astrometric properties (Lupton, Gunn, & Szalay 1999; Stoughton et al. 2002; Smith et al. 2002; Pier et al. 2003; Ivezić et al. 2004; Tucker et al. 2006). For de-reddening, we use the maps of Schlegel, Finkbeiner, & Davis (1998). Data Release 5 (DR5) primarily covers ~ 8000 square degrees around the North Galactic Pole (NGP). A small fraction of SDSS imaging data is not included in DR5 and will be part of the future SDSS II/SEGUE (Newberg 2003) data release. All our satellites bar one (Segue 1) lie in DR5.

Here, we present further results from our ongoing systematic search for Milky Way satellites using a variant of the algorithm described in Belokurov et al. (2006b). We experimented with a number of color cuts, pixel binning and running window sizes in order to detect potential stellar overdensities. The bins that were more than 4σ away from the background were selected and ranked according to statistical significance. Visual inspection discarded a few obvious contaminants, such as resolved stellar associations in background galaxies, on the basis of their color-magnitude diagrams.

Figure 1 shows 5 sets of 4 panels each derived from the SDSS data. Each row refers to a different satellite. For ease of exposition, it is helpful to have a simple name to call each object. Even though the nature of these

objects is at outset still to be established, we will call those objects we believe to be dwarf galaxies after their constellations, and those objects we believe to be globular clusters after the survey. This nomenclature accords with historical precedent.

The first row of Figure 1 refers to a satellite in Coma Berenices (henceforth Com), the second to a satellite in Canes Venatici (henceforth CVn II), the third to a probable globular cluster (henceforth Segue 1), the fourth to a satellite in Hercules (henceforth Her) and the fifth to a satellite in Leo (henceforth Leo IV)¹⁹. For each object, the first column provides a grey-scale image centered on the satellite; no obvious objects can be seen. The second column is a density map of all the objects classified by the SDSS pipeline as stars; a stellar overdensity is visible in the center of each plot. In each case, an inner circle and an outer annulus are shown in dotted lines. The third and fourth columns show color-magnitude diagrams (CMDs) constructed from all stars in the central region and in the annulus, respectively. We will shortly use these to construct Hess diagrams, but first we describe additional data acquired on 4 of the 5 satellites.

Deeper follow-up observations of Com, CVn II and Segue 1 were made at the Subaru telescope on Mauna Kea, using the Suprime-Cam mosaic camera. The data were gathered on 2006 May 25 (UT), using a single pointing to cover each stellar overdensity. In each case, the location of the Subaru field is shown in the panels in the first column of Figure 1. Each pointing was observed in g' and i' bands in a 3-exposure dither to cover the gaps between CCDs. For ease of comparison, the Subaru g' , i' photometry was boot-strapped onto the SDSS g , i photometric system. The Subaru data, although restricted to the central parts, are roughly 2.5 magnitudes deeper in the i band. Further details on the Subaru data acquisition and processing are given in Zucker et al. (2006c).

Follow-up photometric observations of Her were made with the 2.4m Isaac Newton Telescope on the island of La Palma on the night of 2006 June 27 (UT). Images were taken with the prime focus Wide-Field Camera, which has a footprint of 34×34 arcminutes and a pixel scale of 0.33 arcseconds. Exposures comprised three dithered 600 second integrations in each of the g' and i' filters (for a total of 30 minutes of exposure in each filter). Data were processed using a general purpose pipeline for processing wide-field optical CCD data described elsewhere (Irwin & Lewis 2001) and boot-strapped onto the SDSS photometric system. The INT data are roughly a magnitude deeper in the i band than the SDSS data.

Figure 2 shows the CMDs of the central parts (marked on Figure 1 as circles) of Com, CVn II, Segue 1 and Her using the follow-up data. The upper panels of Figure 3 show the difference between the normalized color-magnitude diagrams of the inner and outer parts of Com, CVn II, Segue 1 and Her in SDSS data (the third and fourth columns of Figure 1). The lower panels show the same physical quantity, but this time constructed with the deeper data from Subaru/INT. In these differential Hess diagrams, familiar features, such as giant branches,

¹⁹ There is already a dwarf galaxy known in the constellation of Canes Venatici (Zucker et al. 2006a), and two known in Leo. Leo III is an alternative name for the Leo dwarf irregular, also called Leo A (van den Bergh 2000).

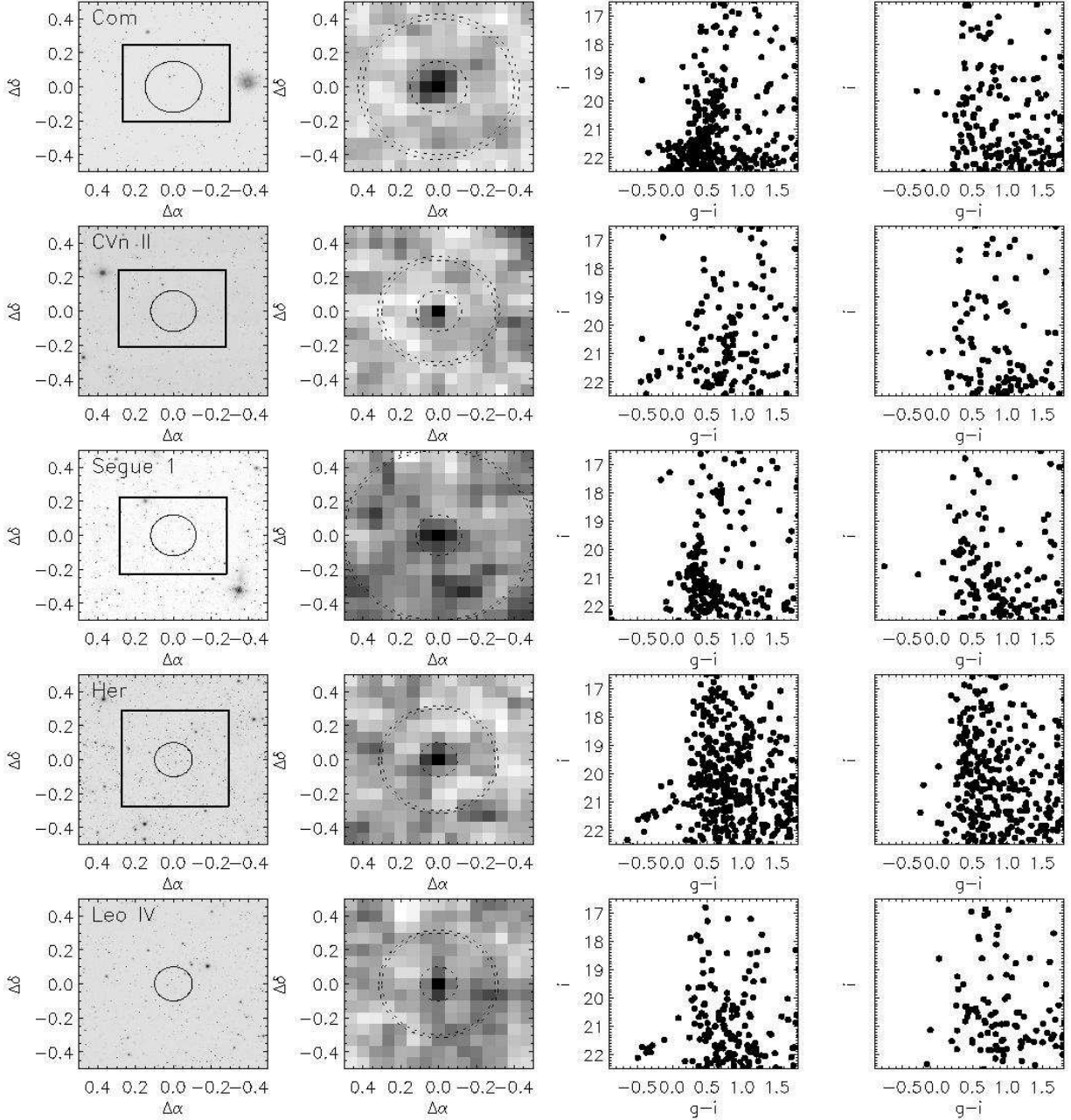

FIG. 1.— Discovery panels for the 5 new satellites. The first column is a cut-out of the SDSS, with a box showing the location of the Subaru field ($34' \times 27'$) or INT field ($34' \times 34'$) and a circle marking the central part of the object. The second column shows the pixelated stellar density. The pixels are $4'$ on each side. For each object, 3 circles are shown of radii r_1 , r_2 and r_3 . The CMD of stars lying within a circle of radius r_1 is given in the third column. The CMD of stars lying in the annulus defined by the outer radii (r_2 and r_3) is given in the fourth column. [r_1, r_2, r_3 for Coma are $0.15^\circ, 0.4^\circ, 0.43^\circ$, for CVn II ($0.12^\circ, 0.3^\circ, 0.32^\circ$), for Segue 1 ($0.12^\circ, 0.5^\circ, 0.51^\circ$), for Her ($0.1^\circ, 0.3^\circ, 0.32^\circ$) and for Leo IV ($0.1^\circ, 0.3^\circ, 0.32^\circ$).

horizontal branches and upper main sequences, can all be discerned. We conclude that each of the 4 objects is localized and has a distinct stellar population. This provides reassuring confirmation that these 4 objects are new satellites.

For the purpose of clarity, the Hess diagrams are converted to contour plots in Figure 4. The ridgelines of the Galactic globular clusters M92 ($[\text{Fe}/\text{H}] \sim -2.24$) and M13 ($[\text{Fe}/\text{H}] \sim -1.65$) are overlaid, using the data of Clem (2005) transformed into the SDSS photometric

system. The ridgeline of very old, metal poor M92 gives a remarkably good representation of the stellar populations. In the cases of Coma and Segue 1, the main sequence and giant branch can be matched well. In the cases of CVn II and Her, the turn-off, giant branch and, most importantly, the horizontal branch are well-fit. This comparison immediately gives us a good estimate of the distance modulus to each object, as listed in Table 1. Segue 1 and Coma are reasonably close, at heliocentric distances of ~ 23 kpc and ~ 44 kpc, whilst CVn II and

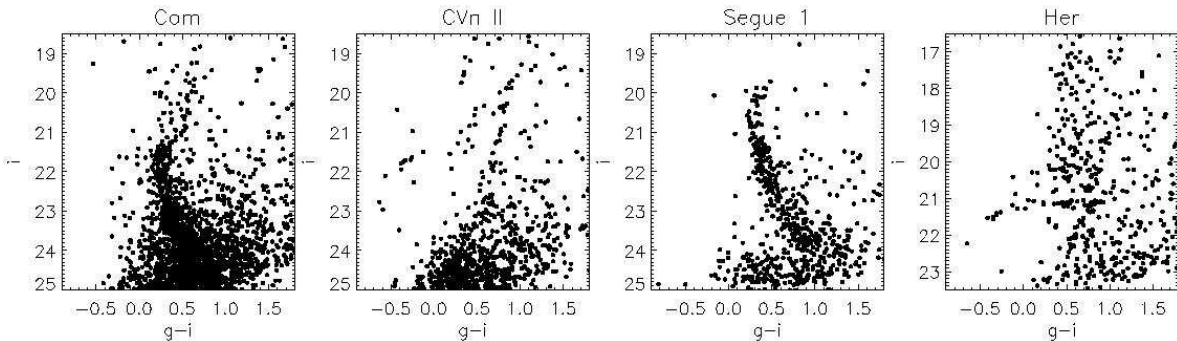

FIG. 2.— CMDs of the central parts of Com, CVn II, Segue 1 and Her from the Subaru/INT follow-up data.

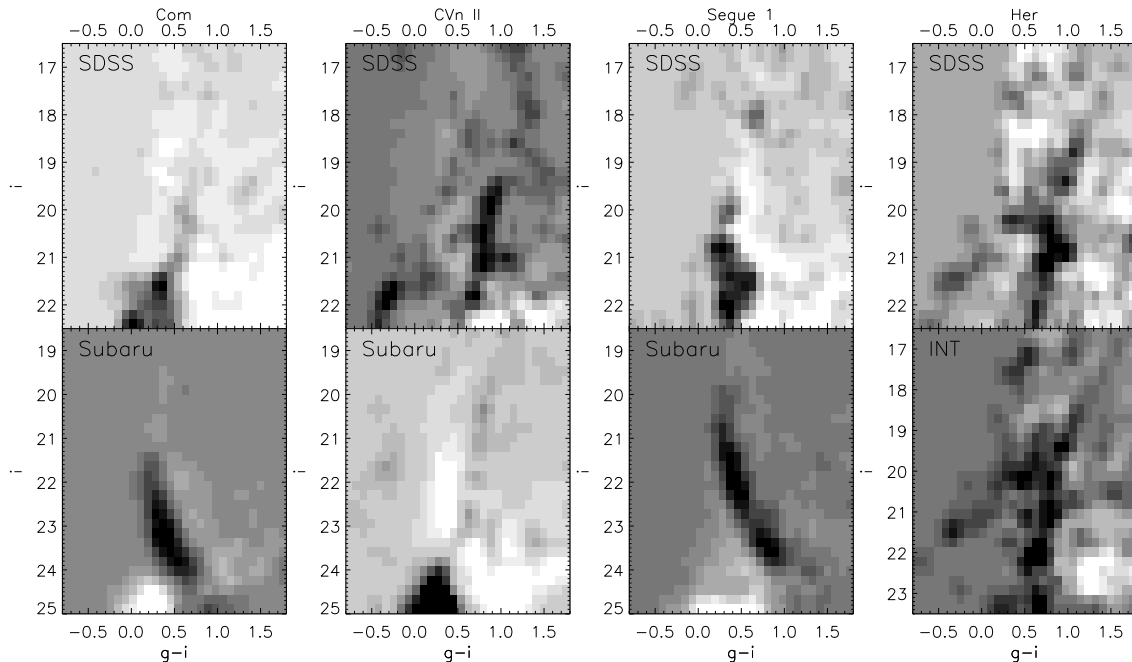

FIG. 3.— Differential Hess diagrams using SDSS (upper panels) and Subaru or INT (lower) data for Com, CVn II, Segue 1 and Her. In each case, the normalized Hess diagram constructed with stars selected within r_1 is subtracted from the normalized Hess diagram constructed with stars selected between r_2 and r_3 .

Her are further away at distances of ~ 150 kpc and ~ 140 kpc, respectively. To define membership of each object, we use the M92 ridgeline to construct a mask at the estimated distance. Figure 5 shows the isodensity contours of stars matching the mask for each object using SDSS and follow-up data. They are all extended and rather irregular in their outer parts. Com is the closest and has the most substructure. CVn II and Her are rounder, but there is evidence for extensions that may be part of streams or tails. Segue 1 is the smallest. Its innermost contours are quite round, but there is clearly a tail visible in the SDSS data.

We have no follow-up data for Leo IV. However, its CMD, shown in Figure 6, reveals a giant branch and blue horizontal branch. As before, the ridgeline of M92 gives a reasonable match (see middle panel of Figure 6), but the width of the giant branch appears to be larger than that of a single stellar population. The isodensity contours are

shown in the right panel. Black dots indicate candidate blue horizontal branch stars. It is reassuring to see that they are concentrated and extended in the same manner as the isodensity contours. In the absence of follow-up data, we regard this as a useful check.

A number of integrated photometric and morphological parameters for Com, CVn II, Segue 1, Her and Leo IV are reported in Table 1. The algorithms for the calculations of position angle, ellipticity, half-light radius, and absolute magnitude are described in detail in our earlier papers (Zucker et al. 2006a; Belokurov et al. 2006b).

2.2. Summary of the New Satellites

Based on their sizes and shapes, our working hypothesis is that Com, CVn II, Her, and Leo IV are new dwarf galaxies, whilst Segue 1 is an extended globular cluster.

Com is located at a heliocentric distance of 44 ± 4 kpc. It has a half-light radius of ~ 70 pc, although this may be

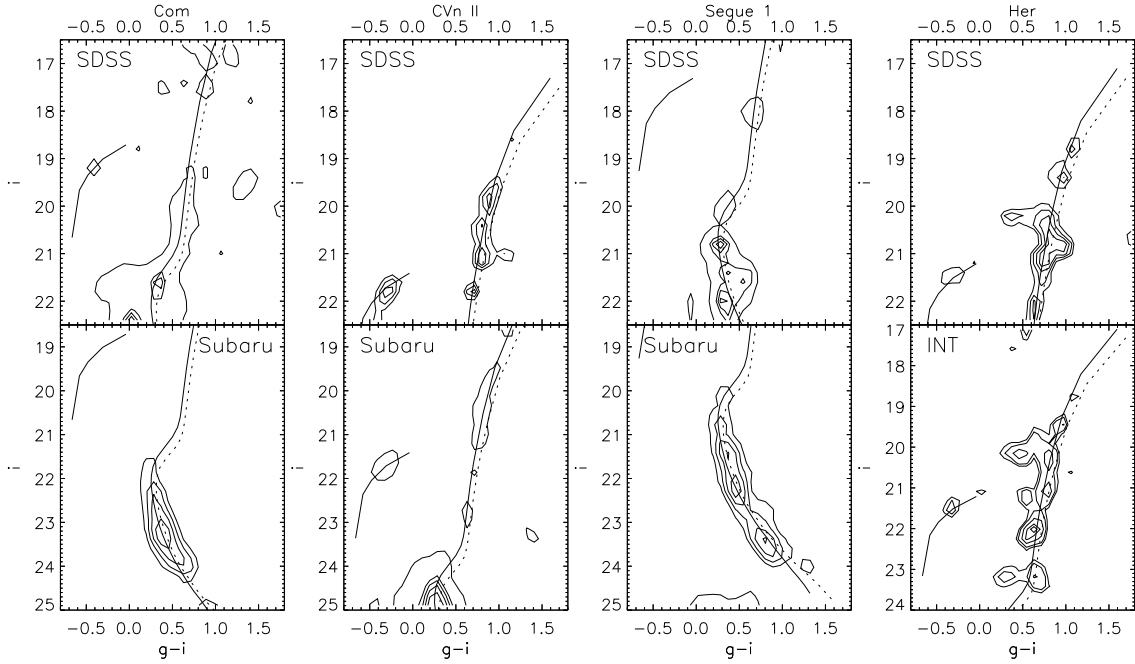

FIG. 4.— Contour levels on the differential Hess diagrams using SDSS (upper panels) and Subaru or INT (lower) data for Com, CVn II, Segue 1 and Her. The ridgeline of M92 (M13) is overlaid as a solid (dotted) line, using the data of Clem (2005).

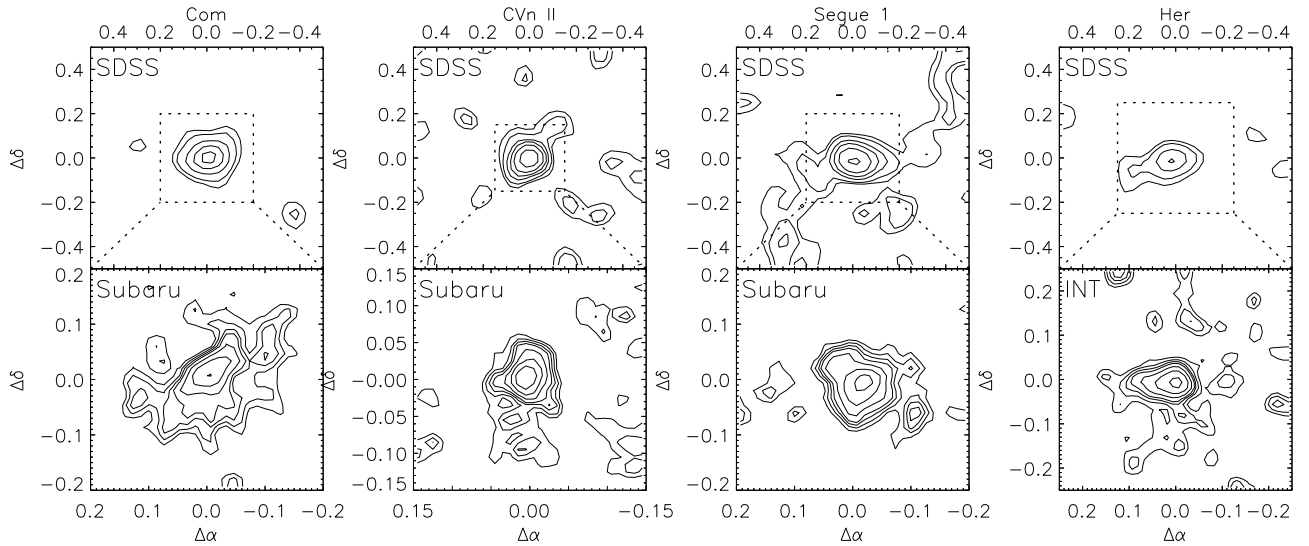

FIG. 5.— Isodensity contours for Com, CVn II, Segue 1 and Her I. Membership is determined using a mask constructed from the M92 ridgeline. The top panels show CMD-selected stars with $18 < i < 22.5$. There are 30×30 pixels, smoothed with a Gaussian with FWHM of 3 pixels. Contour levels are 2, 3, 5, 7, 10, 15 σ above the background. The bottom panels show the central parts of the objects in Subaru/INT data. There are 30×30 pixels, smoothed with a Gaussian with FWHM of 2.2 pixels. Contour levels are 2, 3, 4, 5, 7, 10, 15 σ above the background.

an underestimate given its irregular and extended shape. Its CMD is consistent with that of a single, old stellar population of metallicity $[\text{Fe}/\text{H}] \sim -2$.

CVn II is at a distance of 150_{-14}^{+15} kpc and has a half-light radius of ~ 140 pc. The central density contours are round, but there is a southward extension clearly visible in the deep Subaru data. Its CMD has a clearly defined subgiant branch with a hint of a red clump, a rea-

sonably prominent blue horizontal branch and a narrow giant branch.

Segue 1 is the closest at a distance of 23 ± 2 kpc. Its half-light radius is 30 pc, roughly the same size as the largest Milky Way globular clusters, such as Pal 5 and Pal 14 (Harris 1996). There is evidence for tidal tails in the SDSS data. Its CMD has a poorly populated subgiant branch and no obvious horizontal branch. At

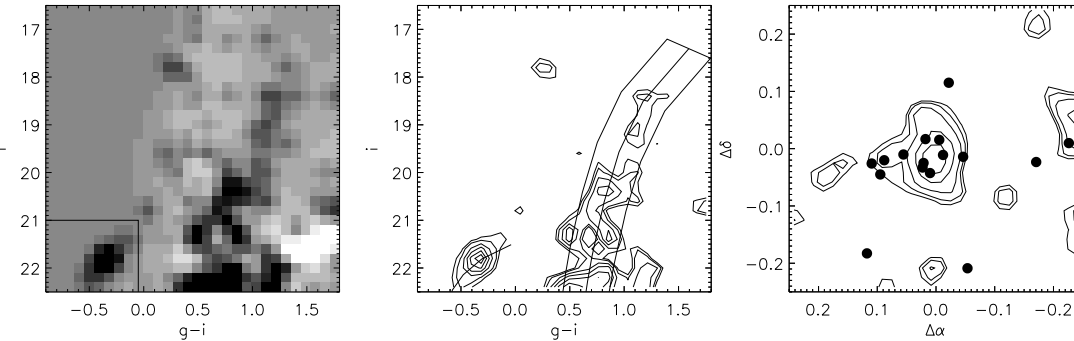

FIG. 6.— Left: Differential Hess diagram for Leo IV, together with the color-magnitude box used to select BHB candidate stars. Middle: Contours of the differential Hess diagram, with overplotted M92 ridgeline and mask used to select members. Right: Isodensity contours of Leo IV, together with locations of BHB candidate stars.

TABLE 1
PROPERTIES OF THE NEW MILKY WAY SATELLITES

Parameter ^a	Coma Berenices	Canes Venatici II	Segue 1	Hercules	Leo IV
Coordinates (J2000)	12:26:59 +23:54:15	12:57:10 +34:19:15	10:07:04 +16:04:55	16:31:02 +12:47:30	11:32:57 -00:32 00
Galactic (ℓ, b)	241.9°, 83.6°	113.6°, 82.7°	220.5°, 50.4°	28.7°, 36.9°	265.4°, 56.5°
Position Angle	120°	0°	60°	125°	355°
Ellipticity	0.5	0.3	0.3	0.5	0.25
r_h (Plummer)	5'0	3'0	4'5	8'0	3'3
r_h (Exponential)	5'9	3'3	4'6	8'4	3'4
V_{tot}	14 ^m 5 ± 0 ^m 5	15 ^m 1 ± 0 ^m 5	13 ^m 8 ± 0 ^m 5	14 ^m 7 ± 0 ^m 5	15 ^m 9 ± 0 ^m 5
($m-M$) ₀	18 ^m 2 ± 0 ^m 2	20 ^m 9 ± 0 ^m 2	16 ^m 8 ± 0 ^m 2	20 ^m 7 ± 0 ^m 2	21 ^m 0 ± 0 ^m 2
Heliocentric distance	44 ⁺⁴ ₋₄ kpc	150 ⁺¹⁵ ₋₁₃ kpc	23 ⁺² ₋₂ kpc	140 ⁺¹³ ₋₁₂ kpc	160 ⁺¹⁵ ₋₁₄ kpc
$M_{\text{tot},V}$	-3 ^m 7 ± 0 ^m 6	-4 ^m 8 ± 0 ^m 6	-3 ^m 0 ± 0 ^m 6	-6 ^m 0 ± 0 ^m 6	-5 ^m 1 ± 0 ^m 6

^aIntegrated magnitudes are corrected for the Galactic foreground reddening reported by Schlegel et al. (1998)

$\alpha \approx 152^\circ, \delta \approx 16^\circ$, Segue 1 is superposed on the Sagittarius stream; at this location Belokurov et al. (2006a) estimated the distance to the Sagittarius stream to be ~ 20 kpc, close to the distance to Segue 1. We conclude that Segue 1 is likely a globular cluster formerly associated with the Sagittarius dSph.

Her lies at a distance of 140_{-12}^{+13} kpc and has a half-light radius of ~ 320 pc. It has an extended morphology. Its CMD shows not just a giant branch, but both blue and red horizontal branches, which may hint at multiple stellar populations.

Leo IV is at a distance of 160_{-14}^{+15} kpc. Its half-light radius is ~ 160 pc. Its CMD is more complex than the others, with an apparent thick giant branch and a blue horizontal branch. The thickness may be caused by multiple stellar populations and/or by depth along the line of sight.

3. DISCUSSION

3.1. Dwarf Galaxies or Globular Clusters

The five objects in this paper, together with the five Milky Way satellites previously discovered in SDSS data – namely Ursa Major I, Willman 1, Canes Venatici I, Bootes and Ursa Major II – can be usefully taken together as a group. They were all discovered in the same dataset with similar methods, although this does not necessarily imply any underlying physical commonality. The locations of the ten SDSS objects in the Galactic sky are shown in Figure 7, together with the 9 previously known

dSphs. Prior to SDSS, it had long been suspected that there may be some missing dSphs at low Galactic latitude in the Zone of Avoidance (see e.g. Mateo 1998). However, the SDSS objects all lie at high Galactic latitude, as the survey is concentrated around the North Galactic Pole. It is difficult to escape the conclusion that there are many more Milky Way companions waiting to be discovered. Assuming (i) all dwarf satellites in the area of sky covered by SDSS have been found and (ii) the distribution of dwarf satellites is isotropic, then there may be ~ 50 dwarfs in all. In fact, both assumptions are surely incorrect. Systematic surveys for all satellites in SDSS DR5 are underway (e.g., Koposov et al. 2006, in preparation) and will undoubtedly uncover further candidates. The spatial distribution of dwarf galaxies is a controversial issue, although the most recent analysis of the simulation data suggests that dwarf satellites may lie preferentially along the major axis of the light distribution of the host galaxy (see e.g., Zentner et al. 2005; Yang et al. 2006, and references therein). If so, then our extrapolation to a total of ~ 50 dwarfs may still be an underestimate.

Figure 8 shows objects plotted in the plane of absolute magnitude and half-light radius. This includes the ten SDSS discoveries in the Milky Way (filled circles) and the eight Milky Way dSphs omitting Sgr (unfilled circles). We have added to the sample of SDSS discoveries two dSphs found around M31, namely And IX and X (Zucker et al. 2004, 2006b). Also shown are a

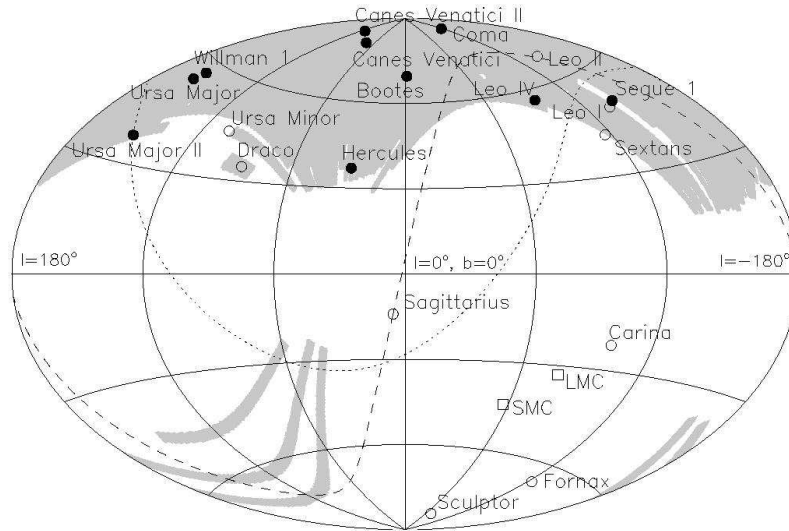

FIG. 7.— The locations of Milky Way satellites in Galactic coordinates. Filled circles are satellites discovered by SDSS, unfilled circles are previously known Milky Way dSphs. The light grey shows the area of sky covered by the Sloan survey and its extensions to date. The dashed and dotted lines show the orbital planes of the Sagittarius and Orphan Streams, respectively, taken from Fellhauer et al. (2006a) and Fellhauer et al. (2006b).

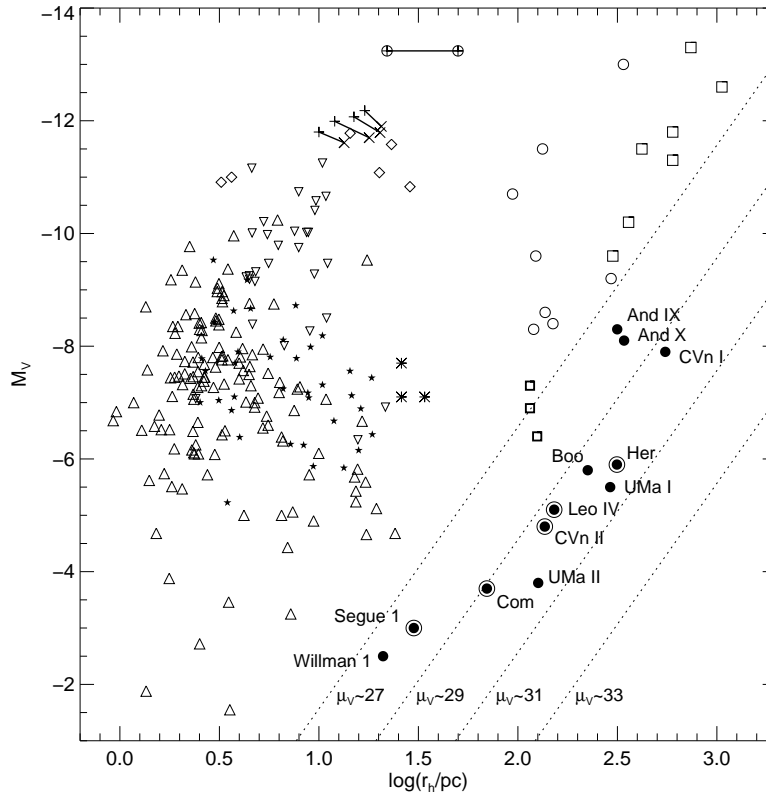

FIG. 8.— Location of different classes of object in the plane of absolute magnitude versus half-light radius. Lines of constant surface brightness are marked. Filled circles are the SDSS discoveries including the 10 Milky Way satellites (Willman et al. 2005a, 2006; Zucker et al. 2006a,c; Belokurov et al. 2006b), as well as And IX and X (Zucker et al. 2004, 2006b). Unfilled circles are eight previously known Milky Way dSphs with Sgr omitted (Irwin & Hatzidimitriou 1995; Mateo 1998), bold squares are three new M31 dSphs recently discovered by Martin et al. (2006), while triangles are the Galactic globular clusters (Harris 1996). A variety of other extragalactic objects are also plotted: asterisks are the extended M31 globular clusters discovered by Huxor et al. (2005), pluses and crosses are UCDs in Fornax from Mieske et al. (2002) and De Propris et al. (2005) respectively, diamonds are the so-called Virgo dwarf-globular transition objects (Hasegan et al. 2005), while filled stars and inverted triangles are globular clusters from the nearby giant elliptical NGC 5128 from Harris et al. (2002) and Gómez et al. (2006) respectively. Different measurements of the same object are connected by straight lines. The straight line connecting the Earth symbols refer to measurements by Mieske et al. (2002) and Drinkwater et al. (2003) of UCD3 in Fornax.

number of populations of extragalactic objects – such as the M31 dSphs, including the most recent 3 discoveries by Martin et al. (2006), the three unusually extended globular clusters found in M31 by Huxor et al. (2005), the ultra-compact dwarf galaxies (UCDs) in the Fornax and Virgo clusters (Mieske et al. 2002; De Propris et al. 2005; Hasegan et al. 2005) and globular clusters from the nearby giant elliptical NGC 5128 (Gómez et al. 2006; Harris et al. 2002). Some lines of constant surface brightness are also marked. This shows why the recent spate of discoveries in SDSS data is occurring – the survey is reaching much lower surface brightnesses than possible before. All the SDSS discoveries lie below, and all the previously known Milky Way dSphs above, the line marking $\mu_V = 27 \text{ mag arcsec}^{-2}$.

Some properties of the SDSS discoveries are apparent from Figure 8. As a group, they are much fainter than the previously known Milky Way and M31 dSphs. They are also less regular in shape, which suggests tidal effects may be important. Of course, caution is needed, as some of the isophotal distortion is due to low object counts and uncertain background subtraction. Nonetheless, there seems to be a rough correlation between irregularity and distance, as Boo, UMa II and Com are the most irregular and also amongst the closest. They all seem to be very metal-poor with $[\text{Fe}/\text{H}] \approx -2$, at least as judged by the fit of M92’s ridgeline to giant branch, main sequence turn-off or horizontal branch of the CMDs. This is supported by the recent measurement of the metallicity of Boo (Munoz et al. 2006) as $[\text{Fe}/\text{H}] \sim -2.5$. The SDSS discoveries are larger and somewhat less luminous than typical Milky Way globular clusters.

The seeming lack of metals in the SDSS discoveries is interesting. The Galactic halo contains a significant fraction of stars more metal-poor than $[\text{Fe}/\text{H}] \sim -2.0$ (see e.g., Christlieb et al. 2004; Beers et al. 2005). The previously known dSphs on the other hand contain very few metal-poor stars (see e.g., Tolstoy et al. 2004; Koch & Grebel 2006). The new SDSS discoveries may be representatives of the population that built the old, metal-poor component of the Milky Way halo.

Also apparent in Figure 8 is the fact that the data-points fall into a number of clumps. The Milky Way globulars form one obvious grouping. A number of unusual objects, such as the extended M31 clusters and the UCDs in Fornax and Virgo, all lie in regions abutting the globulars in the plane of absolute magnitude and half-light radius. For example, UCDs are brighter than Galactic globulars, but they could be the bright tail of the globular cluster systems in the Fornax and Virgo clusters. Separating the globulars from the dwarf galaxies is a sparsely populated vertical band corresponding to half-light radii between $\sim 40 \text{ pc}$ to $\sim 100 \text{ pc}$. Only two objects lie in this gap. The first is Com, which is so irregular that its half-light radius is susceptible to significant uncertainties. The second is UCD3 in Fornax as measured by Mieske et al. (2002). A *Hubble Space Telescope* re-measurement of the half-light radius of this object by Drinkwater et al. (2003) yielded a somewhat smaller answer. The two measurements are connected by a straight line in Figure 8.

The gap is suggestive, but not conclusive, as SDSS DR5 covers only 20 per cent of the night sky around the North Galactic Cap. There are still very few objects in

Figure 8 at low surface brightness. However, it is significant that there are SDSS discoveries on either side of the gap. It is also clear that, if there were a population of extended, luminous star clusters in the Milky Way analogous to those found by Huxor et al. (2005) in M31, then they would have very likely been found already in SDSS data. In this picture, Segue 1 and Willman 1 are unusually faint, extended, globular clusters, whilst the remaining SDSS discoveries are dwarf galaxies. Of course, the separation between clusters and dwarf galaxies would be much clearer on plots of absolute magnitude versus velocity dispersion. It will be interesting to see analogues of Figure 8 once kinematic data become available.

At the moment, all objects to the left of the gap show no evidence of dynamically significant dark matter. All the objects to the right with measured kinematics are consistent with substantial amounts of dark matter. For the classical dSphs, the kinematic data are consistent with a common halo mass scale (e.g., Wilkinson et al. 2006). This is also the case for UMa I (Kleyna et al. 2005). If this holds for all the new SDSS discoveries, it might provide a natural explanation for the existence of a gap.

3.2. Implications for Near-Field Cosmology

The objects discussed in this paper have a number of implications for Near-Field Cosmology. In CDM, dark matter overdensities collapse to form cusped halos, with the smallest and least massive halos being the densest. The simulations of Klypin et al. (1999) and Moore et al. (1999) predicted hundreds of small Galactic satellite halos, as compared to the handful of then known satellite galaxies around the Milky Way. If each small dark matter halo indeed harbors a detectable small galaxy, then there is a dramatic conflict between predictions and observations. It remains unclear whether theory or observations are responsible for this discrepancy. In fact, many theoreticians responded to this result by developing models that suppress gas accretion (see e.g. Efstathiou 1992) or star formation in low mass halos. This produces a large population of entirely dark satellites (see e.g. Bullock et al. 2000; Kravtsov et al. 2004; Moore et al. 2006), together with a much smaller number of dSphs, roughly in accord with the datum of 9 dSphs per large galaxy. However, it is now clear, from the discoveries over the past couple of years, that the observational situation has changed dramatically.

Spectroscopic studies are urgently needed to assess the dark matter content of the SDSS discoveries. So far, only two of the galaxies have kinematic data. Kleyna et al. (2005) measured the velocities of seven UMa I stars and obtained a velocity dispersion of $\sim 9 \text{ kms}^{-1}$ and a mass-to-light ratio of ~ 500 . Munoz et al. (2006) measured the radial velocities of seven Boo stars and obtained a velocity dispersion of $\sim 7 \text{ kms}^{-1}$ and a mass-to-light ratio of between 130 and 680. Caution is needed in interpreting these results as they are calculated under the strong assumption of steady-state, virial equilibrium. Based on these results, UMa I and Boo would be the two most dark matter dominated objects known in the Universe. The implication is that the SDSS discoveries may well be members of the missing population of low stellar mass, dark matter dominated galaxies originally predicted by CDM. Only when a complete census of these objects has

been obtained will we be able to assess whether the properties of the population are consistent with the predictions of the simulations.

Another possibility is that the Milky Way satellites condensed out of the tidal tails of an early merger with a gas-rich progenitor (Barnes & Hernquist 1992); this would make them analogous to the tidal dwarf galaxies observed in interacting systems today (Weilbacher et al. 2000). An attractive facet of this idea is that it naturally accounts for possible streams in the Milky Way dSphs. This phenomenon was originally spotted by Lynden-Bell (1982a,b), who noted that the bright dSphs may be aligned in one or two streams of tidal debris. However, examining Figure 7, it is apparent that the simple model of Kroupa et al. (2005), in which most of the Milky Way satellites are associated with a single disk-like structure, is hard to reconcile with the new data.

Kroupa (1997) has studied the long-time evolution of tidal dwarf galaxies. The idea is that tidal dwarf galaxies with no dark matter suffer destruction at perigalacticon passages to leave orbiting but unbound agglomerations of stars that appear compact near their apocenter, and which constitute some of the present-day dSphs. The absence of velocity gradients and the thinness of the horizontal branch in galaxies like Draco (Kleyna et al. 2002; Klessen et al. 2003), Fornax and Sagittarius (Mackey & Gilmore 2003) means that this theory cannot reproduce the observed properties of the brightest dSphs. However, the irregular shape and the abundance of substructure in the objects presented by Kroupa (1997) do bear a striking resemblance to the new SDSS discoveries, although Kroupa’s objects as a class are much more luminous and may require fortuitous timing and a favorable viewing angle. It would be interesting to see detailed predictions of the properties of these objects at fainter absolute magnitudes ($M_V \approx -6$).

4. CONCLUSIONS

In this paper, we announced the discovery of five new satellites of the Milky Way. One is a probable new globular cluster, which has been named Segue 1 after the survey in which it was found. It is in the Sagittarius stream and was possibly stripped off the Sagittarius progenitor. The remaining four are probably new dwarf galaxies, which have been named according to their constellations as Coma Berenices, Canes Venatici II, Leo IV and Hercules. We have presented SDSS and deeper Subaru/INT photometry (where available) on these objects. We provide color-magnitude diagrams, distances, absolute magnitudes and half-light radii for all the satellites.

Taken together with the earlier announcements of Ursa Major I, Willman 1, Canes Venatici I, Bootes and Ursa Major II, ten new Milky Way satellites have been discovered in SDSS data in very rapid succession. This abundance of discoveries is occurring because the survey is probing down to hitherto uncharted surface brightnesses. All the SDSS discoveries are effective surface brightness fainter than $\mu_V = 27 \text{ mag arcsec}^{-2}$. The obvious conclusion is that there are more low surface brightness Milky Way satellites waiting to be discovered.

The SDSS discoveries occupy a distinct region in the plane of absolute magnitude versus half-light radius. They are typically fainter, more metal-poor and more irregular than the previously-known Milky Way dwarf

spheroidals (dSphs). They are larger, and somewhat less luminous, than typical Galactic globular clusters. Taking the known globular clusters, the previously known Milky Way satellites and the SDSS discoveries, there is still a scarcity of objects with half-light radii between $\sim 40 \text{ pc}$ and $\sim 100 \text{ pc}$. This may represent the division between star clusters and dwarf galaxies.

The SDSS discoveries could have a bearing on the “missing satellite” problem. Preliminary indications from studies of UMa I (Kleyna et al. 2005) and Boo (Munoz et al. 2006) suggest that these objects may be dark matter dominated. It seems possible that a population of ultra-faint, dark dwarf galaxies really does surround the Milky Way. However, it is not yet clear that these are the “missing satellites” predicted by the simulations of Klypin et al. (1999) and Moore et al. (1999). The match of the data to CDM halos should be carried out in the plane of cumulative number versus halo mass or circular velocity.

Kroupa’s (1997) study of the evolution of tidal dwarf galaxies reproduces some of the properties of the new satellites. This opens up the possibility that some of these objects may be tidal dwarf galaxies, or shreds from the violent building phase of the Milky Way. In this case, the satellites will not have substantial dark matter. Kinematic data are now urgently needed to confirm whether or not these objects are dark matter dominated.

We thank Pavel Kroupa and Beth Willman for useful discussions and comments. V.B., D.B.Z., M.I.W., M.F. and D.M.B. acknowledge the financial support of the Particle Physics and Astronomy Research Council of the United Kingdom.

Funding for the SDSS and SDSS-II has been provided by the Alfred P. Sloan Foundation, the Participating Institutions, the National Science Foundation, the U.S. Department of Energy, the National Aeronautics and Space Administration, the Japanese Monbukagakusho, the Max Planck Society, and the Higher Education Funding Council for England. The SDSS Web Site is <http://www.sdss.org/>.

The SDSS is managed by the Astrophysical Research Consortium for the Participating Institutions. The Participating Institutions are the American Museum of Natural History, Astrophysical Institute Potsdam, University of Basel, Cambridge University, Case Western Reserve University, University of Chicago, Drexel University, Fermilab, the Institute for Advanced Study, the Japan Participation Group, Johns Hopkins University, the Joint Institute for Nuclear Astrophysics, the Kavli Institute for Particle Astrophysics and Cosmology, the Korean Scientist Group, the Chinese Academy of Sciences (LAMOST), Los Alamos National Laboratory, the Max-Planck-Institute for Astronomy (MPIA), the Max-Planck-Institute for Astrophysics (MPA), New Mexico State University, Ohio State University, University of Pittsburgh, University of Portsmouth, Princeton University, the United States Naval Observatory, and the University of Washington. This work was based in part on observations made with the Isaac Newton Telescope on the Island of La Palma by the Isaac Newton Group in the Spanish Observatorio del Roque de los Muchachos of the Institutode Astrofisica de Canarias.

REFERENCES

- Adelman-McCarthy, J. K., et al. 2006, *ApJS*, 162, 38
 Barnes, J. E., & Hernquist, L. 1992, *Nature*, 360, 715
 Beers, T. C., et al. 2005, *IAU Symposium*, 228, 175
 Belokurov, V. et al. 2006a, *ApJ*, 642, L137
 Belokurov, V. et al. 2006b, *ApJ*, 647, L111
 Bullock, J. S., Kravtsov, A. V., & Weinberg, D. H. 2000, *ApJ*, 539, 517
 Christlieb, N., Reimers, D., & Wisotzki, L. 2004, *The Messenger*, 117, 40
 Clem, J. L. 2005, PhD Thesis, University of Victoria
 De Propris, R., Phillipps, S., Drinkwater, M. J., Gregg, M. D., Jones, J. B., Evstigneeva, E., & Bekki, K. 2005, *ApJ*, 623, L105
 Dolphin, A. 1997, *New Astronomy*, 2, 397
 Drinkwater, M. J., Jones, J. B., Gregg, M. D., & Phillipps, S. 2000, *Publications of the Astronomical Society of Australia*, 17, 227
 Drinkwater, M. J., Gregg, M. D., Hilker, M., Bekki, K., Couch, W. J., Ferguson, H. C., Jones, J. B., & Phillipps, S. 2003, *Nature*, 423, 519
 Efsthathiou, G. 1992, *MNRAS*, 256, 43P
 Fellhauer, M. et al. 2006, *ApJ*, in press (astro-ph/0605026)
 Fellhauer, M. et al. 2006, *ApJ*, submitted
 Freeman, K., Bland-Hawthorn, J. 2002, *ARA&A*, 40, 487
 Fukugita, M., Ichikawa, T., Gunn, J. E., Doi, M., Shimasaku, K., & Schneider, D. P. 1996, *AJ*, 111, 1748
 Gómez, M., Geisler, D., Harris, W. E., Richtler, T., Harris, G. L. H., & Woodley, K. A. 2006, *A&A*, 447, 877
 Grillmair, C. J. 2006, *ApJ*, 645, L37
 Gunn, J.E. et al. 1998, *AJ*, 116, 3040
 Gunn, J.E. et al. 2006, *AJ*, 131, 2332
 Haşegan, M., et al. 2005, *ApJ*, 627, 203
 Harris, W. E. 1996, *AJ*, 112, 1487
 Harris, W. E., Harris, G. L. H., Holland, S. T., & McLaughlin, D. E. 2002, *AJ*, 124, 1435
 Hilker M., Infante L., & Richtler T., 1999, *A&AS*, 138, 55
 Hogg, D.W., Finkbeiner, D.P., Schlegel, D.J., Gunn, J.E. 2001, *AJ*, 122, 2129
 Huxor, A. P., Tanvir, N. R., Irwin, M. J., Ibata, R., Collett, J. L., Ferguson, A. M. N., Bridges, T., & Lewis, G. F. 2005, *MNRAS*, 360, 1007
 Ibata, R. A., Gilmore, G., & Irwin, M. J. 1995, *MNRAS*, 277, 781
 Irwin, M., & Hatzidimitriou, D. 1995, *MNRAS*, 277, 1354
 Irwin, M. J., Bunclark, P. S., Bridgeland, M. T., & McMahon, R. G. 1990, *MNRAS*, 244, 16P
 Irwin, M., & Lewis, J. 2001, *New Astronomy Review*, 45, 105
 Ivezić, Ž. et al., *AN*, 325, 583
 Klessen, R. S., Grebel, E. K., Harbeck, D. 2003, *ApJ*, 589, 798
 Kleyna, J., Wilkinson, M. I., Evans, N. W., Gilmore, G., & Frayn, C. 2002, *MNRAS*, 330, 792
 Kleyna, J. T., Wilkinson, M. I., Evans, N. W., & Gilmore, G. 2005, *ApJ*, 630, L141
 Klypin, A., Kravtsov, A. V., Valenzuela, O., & Prada, F. 1999, *ApJ*, 522, 82
 Koch, A., & Grebel, E. K. 2006, *AJ*, 131, 1405
 Kravtsov, A. V., Gnedin, O. Y., & Klypin, A. A. 2004, *ApJ*, 609, 482
 Kroupa, P. 1997, *New Astronomy*, 2, 139
 Kroupa, P., Theis, C., & Boily, C. M. 2005, *A&A*, 431, 517
 Lupton, R., Gunn, J., & Szalay, A. 1999, *AJ*, 118, 1406
 Lynden-Bell, D. 1982a, *The Observatory*, 102, 7
 Lynden-Bell, D. 1982b, *The Observatory*, 102, 202
 Mackey, A. D., & Gilmore, G. F. 2003, *MNRAS*, 345, 747
 Martin, N., et al. 2006, *MNRAS*, in press (astro-ph/0607472)
 Mateo, M. L. 1998, *ARA&A*, 36, 435
 McConnachie, A. W., & Irwin, M. J. 2006, *MNRAS*, 365, 1263
 Mieske, S., Hilker, M., & Infante, L. 2002, *A&A*, 383, 823
 Moore, B., Governato, F., Lake, G., Quinn, T., Stadel, J., & Tozzi, P. 1999, *ApJ*, 524, L19
 Moore, B., Diemand, J., Madau, P., Zemp, M., & Stadel, J. 2006, *MNRAS*, 368, 563
 Muñoz, R. R., Carlin, J. L., Frinchaboy, P. M., Nidever, D. L., Majewski, S. R., & Patterson, R. J. 2006, *ApJL*, submitted, astro-ph/0606271
 Newberg, H. J., 2003, American Astronomical Society Meeting Abstracts, 203, #112.11
 Pier, J.R., Munn, J.A., Hindsley, R.B, Hennessy, G.S., Kent, S.M., Lupton, R.H., Ivezić, Z. 2003, *AJ*, 125, 1559
 Pritzl, B. J., Venn, K. A., & Irwin, M. 2005, *AJ*, 130, 2140
 Schlegel, D. J., Finkbeiner, D. P., & Davis, M. 1998, *ApJ*, 500, 525
 Shetrone, M., Venn, K. A., Tolstoy, E., Primas, F., Hill, V., & Kaufer, A. 2003, *AJ*, 125, 684
 Smith, J. A., et al. 2002, *AJ*, 123, 2121
 Stoehr, F., White, S. D. M., Tormen, G., & Springel, V. 2002, *MNRAS*, 335, L84
 Stoughton, C. et al. 2002, *AJ*, 123, 485
 Tolstoy, E., et al. 2004, *ApJ*, 617, L119
 Tucker D., et al. 2006, *AN*, in press
 van den Bergh, S. 2000, *The Galaxies of the Local Group*, Cambridge University Press, Cambridge
 Weilbacher, P. M., Duc, P.-A., Fritze v. Alvensleben, U., Martin, P., & Fricke, K. J. 2000, *A&A*, 358, 819
 Wilkinson, M. I., Kleyna, J. T., Wyn Evans, N., Gilmore, G. F., Read, J. I., Koch, A., Grebel, E. K., & Irwin, M. J. 2006, *EAS Publications Series*, 20, 105
 Willman, B., et al. 2005, *ApJ*, 626, L85
 Willman, B., et al. 2005, *AJ*, 129, 2692
 Willman, B., et al. 2006, *AJ*, in press (astro-ph/0603486)
 Yang, X., van den Bosch, F. C., Mo, H. J., Mao, S., Kang, X., Weinmann, S. M., Guo, Y., & Jing, Y. P. 2006, *MNRAS*, 369, 1293
 York D.G., et al. 2000, *AJ*, 120, 1579
 Zentner, A. R., Kravtsov, A. V., Gnedin, O. Y., & Klypin, A. A. 2005, *ApJ*, 629, 219
 Zucker, D. B. et al. 2004, *ApJ*, 612, L121
 Zucker, D. B., et al. 2006a, *ApJ*, 643, L103
 Zucker, D. B., et al. 2006b, *ApJ*, submitted (astro-ph/0601599)
 Zucker, D. B., et al. 2006c, *ApJ*, submitted (astro-ph/0606633)