

The Photometric Performance and Calibration of the HST Advanced Camera For Surveys

M. Sirianni^{1,2,3}, M.J. Jee³, N. Benítez^{3,4}, J.P. Blakeslee³, A.R. Martel³, G. Meurer³, M. Clampin⁶,
G. De Marchi^{1,2,7}, H.C. Ford³, R. Gilliland², G.F. Hartig², G.D. Illingworth⁵, J. Mack²
& W.J. McCann³

ABSTRACT

We present the photometric calibration of the Advanced Camera for Surveys (ACS). The ACS was installed in the Hubble Space Telescope (HST) in March 2002. It comprises three cameras: the Wide Field Channel (WFC), optimized for deep near-IR survey imaging programs; the High Resolution Channel (HRC), a high resolution imager that fully samples the HST point spread function (PSF) in the visible; and the Solar Blind Channel (SBC), a far-UV imager. A significant amount of data has been collected to characterize the on-orbit performance of the three channels. We give here an overview of the performance and calibration of the two CCD cameras (WFC and HRC), and a description of the best techniques for reducing ACS CCD data. The overall performance is as expected from pre-launch testing of the camera. Surprises were a better than predicted sensitivity in the visible and near-IR for both WFC and HRC and an unpredicted dip in the HRC UV response at $\sim 3200 \text{ \AA}$.

On-orbit observations of spectrophotometric standard stars have been used to revise the pre-launch estimate of the instrument response curves to best match predicted and observed count rates. Synthetic photometry has been used to determine zeropoints for all filters in three magnitude systems and to derive interstellar extinction values for the ACS photometric systems.

Due to the CCD internal scattering of long wavelength photons, the width of the PSF increases significantly in the near-IR and the aperture correction for photometry with near-IR filters depends on the spectral energy distribution of the source. We provide a detailed recipe to correct for the latter effect.

Transformations between the ACS photometric systems and the UBVRI and WFPC2 systems are presented. In general, two sets of transformations are available: one based on the observation of two star clusters; the other on synthetic photometry. We discuss the accuracy of these transformations and their sensitivity to details of the spectra being transformed.

Initial signs of detector degradation due to the HST radiative environment are already visible. We discuss the impact on the data in terms of dark rate increase, charge transfer inefficiency, and hot pixel population.

¹European Space Agency, Research and Scientific Support Department

²Space Telescope Science Institute, 3700 San Martin Drive, Baltimore, MD 21218.

³Department of Physics and Astronomy, Johns Hopkins University, 3400 North Charles Street, Baltimore, MD 21218.

⁴Istituto de Astrofísica de Andalucía, Camino bajo de Huétor 24, Granada 18008, Spain

⁵UCO/Lick Observatory, University of California, Santa Cruz, CA 95064.

⁶NASA Goddard Space Flight Center, Code 681, Greenbelt, MD 20771.

⁷Presently: ESA, Astrophysics Division, Keplerlaan 1, 2200 AG Noordwijk, Netherlands

Subject headings: instrumentation: detectors, photometers, techniques: photometric, methods: data analysis

Contents

1	INTRODUCTION	4
2	ACS DATA FORMAT	6
2.1	WFC Data	6
2.2	HRC Data	7
3	ACS DATA TREATMENT	7
3.1	Subtraction of the Bias Level	8
3.2	Superbias Subtraction	9
3.3	Dark Subtraction	9
3.4	Flat Field	10
3.5	Cosmic Ray Rejection	11
3.6	Geometric Distortion	12
3.7	Charge Transfer Efficiency	13
4	THE ACS POINT SPREAD FUNCTION	14
4.1	Spatial Variations	15
4.2	Encircled Energy Curves	15
4.3	Long Wavelength Scattered Light	17
4.4	Aperture Correction	19
4.5	Aperture Correction In The Near-IR	20
5	GAIN, LINEARITY AND SATURATION	21
6	THE ABSOLUTE FLUX SCALE OF ACS	23
7	ZEROPOINTS	24
7.1	VEGAMAG Magnitude System	26
7.2	STMAG Magnitude System	26
7.3	ABMAG Magnitude System	27

8	PHOTOMETRIC TRANSFORMATIONS	28
8.1	General Notes	30
8.2	ACS Internal Transformations	31
8.3	Transformations from ACS to UBVRI	33
8.4	Transformations from ACS to WFPC2	34
9	The HRC UV RED LEAK	35
10	REDDENING IN THE ACS SYSTEM	35
11	CONCLUSIONS	36
A	Acronyms	38
B	PHOTOMETRIC CALIBRATION COOKBOOK	39
B.1	Point Source Photometry	39
B.2	Resolved Object Photometry	41
B.3	Surface Photometry	42
C	Aperture Correction for Red Objects: EXAMPLES	43
D	Supporting material for color transformations	44
D.1	Example	44
D.2	Transformation from ACS to UBVRI	45
D.3	Transformation from ACS to WFPC2	45
E	Transformation of Galaxy Templates	46
F	Optimal Aperture Size	47

1. INTRODUCTION

The Advanced Camera for Surveys (ACS) was installed in the Hubble Space Telescope (HST) on March 7, 2002, during Servicing Mission 3B, in the axial bay previously occupied by the Faint Object Camera. ACS was built in a collaborative effort between the Johns Hopkins University, Ball Aerospace & Technologies Corporation, the NASA Goddard Space Flight Center (GSFC), and the Space Telescope Science Institute (STScI). The description of the camera and the philosophy underlying its design are presented in Ford et al. (1998, 2002). The status and the on-orbit performance of the camera are described in Clampin et al. (2002). An overview of the capabilities of ACS is provided in the ACS Instrument Handbook (Pavlovsky, et al. 2004a, hereafter referred to as AIHv5).

The ACS consists of three channels, the Wide Field Channel (WFC), the High Resolution Channel (HRC) and the Solar Blind Channel (SBC). The WFC and HRC have separate optical paths and mirrors (Fig. 1). The WFC is a high-throughput, wide field imager ($202'' \times 202''$) designed for deep imaging surveys in the optical and near-IR. WFC provides a factor 10 gain in discovery efficiency (throughput \times field of view) at 8000 \AA compared to the Wide Field Planetary Camera-2 (WFPC2). The primary goal of the WFC design is to maximize the camera throughput in the near-IR, and this has been achieved by using only three reflective optics and by coating the mirrors with Denton protected silver. This configuration provides a reflectivity 50% higher than three aluminum coated mirrors would provide at 800 nm. The three mirrors are designated IM1, IM2, and IM3. The light from the Optical Assembly Telescope (OTA) first encounters IM1, a spherical mirror which images the HST pupil onto the IM2. This mirror is an anamorphic asphere figured with the inverse spherical aberration of the HST primary mirror, and thus corrects the spherical aberration in the HST primary mirror and the field dependent astigmatism of the HST at the center of the WFC field-of-view (FOV). The light from the IM2 mirror is reflected by a Schmidt-like plate (IM3) through the two filter wheels to the WFC CCDs. The Schmidt plate corrects astigmatism over the WFC FOV.

In the near-UV ($< 3700 \text{ \AA}$) the reflectivity of the silver coating falls rapidly and sets the lower limit of the spectral range observable with the WFC at about 3000 \AA . The $f/25$ focal length of the WFC gives a plate scale of $0''.05 \text{ pixel}^{-1}$ and a near critical sampling in the I-band. The focal plane detector array is a mosaic of two Scientific Imaging Technologies (SITe) $2048 \times 4096 \text{ } 15 \mu\text{m}$ Charge Coupled Devices (CCDs) (Clampin et al. 1998, Sirianni et al. 2000, 2003). The two CCDs, although physically separated in the focal plane, have been cut from the same silicon wafer and have gone through similar post-manufacturing processes. There is therefore a significant continuity in responsivity across the focal plane array.

The HRC is a near-UV to near-IR high resolution $f/70$ imager, which provides critically sampled images in the visible over a $29'' \times 26''$ field of view with a resolution of $0''.025 \text{ pixel}^{-1}$. The HRC optical design employs three aluminum coated mirrors with an MgF_2 overcoating. Two mirrors, M1 and M2, shared with the SBC, have a coating optimized for maximum reflectivity at 1216 \AA . M2 is an anamorphic asphere figured with the inverse spherical aberration on the HST primary mirror, to correct the spherical aberration in the HST primary mirror. The third mirror M3, is a fold mirror with reflectivity optimized at wavelengths longer than 2000 \AA and it is inserted at 45° into the light path to redirect the beam through the two filter wheels to the HRC focal plane array. The HRC detector is a SITe $1024 \times 1024 \text{ } 21 \mu\text{m}$ CCD (Clampin et al. 1998), based on the Space Telescope Imaging Spectrograph (STIS) CCD (Kimble et al. 1998).

The SBC is a far-UV imager optimized for high throughput at 1216 \AA , with a $31'' \times 35''$ FOV and a plate scale of $0''.032 \text{ pixel}^{-1}$. In order to maximize far-UV throughput, the SBC optical design is a two mirror system, with its own independent filter wheel. The two mirrors are shared with the HRC. The SBC is selected when the fold mirror is moved out of the light beam. The SBC uses a STIS-based photon-counting

detector with an opaque CsI photocathode Multi Anode Microchannel plate Array (MAMA) (Quijano et al. 2003)

More detailed description of the instruments are available in a series of papers that can be found at <http://acs.pha.jhu.edu/instrument/papers/>.

In addition to the key design goal of each camera, the other main element which determines the quality of the science that ACS can produce is its filter complement. The complement of ACS filters and dispersers is described by Ford et al. (1996) and is listed in Tables 1 and 2. The ACS optical design allows both the WFC and HRC to share two filter wheels. These filter wheels are populated with 17 bandpass filters, a set of five linear ramp filters, a grism, a prism for the HRC, and three visible and three near-UV polarizers. The SBC has its own filter wheel with five long-pass filters, two prisms, a narrow-band Lyman- α filter, and four opaque positions which act as shutters. The CCD camera filter wheels contain filters with two different sizes. Some filters are full-sized and can be used with both the HRC and WFC. Others are smaller, giving a full unvignetted FOV with the HRC, but a vignetted area of $72'' \times 72''$ when used with the WFC. Eleven filters are allocated to broad-band imaging from the near-UV to the near-IR. This includes the Sloan g (F475W), r (F625W), i (F775W) and z (F850LP) filters. The two near-UV high throughput filters F220W and F250W are similar to the F218W and F255W currently in the WFPC2 and provide continuity between the two instruments. These are complemented by one set of broad band U (F330W), B (F435W), V (F555W), broad V (F606W) and I (F814W) filters, also similar to the WFPC2 filters. To complement these filters, there is a medium-band continuum filter F550M, which is centered at $\sim 5500 \text{ \AA}$ with a band width of $\sim 10\%$ ¹.

Narrow-band filters for the CCD cameras in ACS take three forms: standard narrow-band filters which cover the entire field of view of both cameras, linear ramp filters similar to those in WFPC2 and an HRC-size methane band filter designed for the observation of the giant planets. The standard narrow-band filter complement is NeV (F344N), [OIII] (F502N), H α (F658N) and [NII] (F606N). The five ramp filters (four narrow-band $\sim 2\%$ and one broad-band $\sim 9\%$) allow narrow- or medium-band imaging centered at an arbitrary wavelength. The ramp filters cover the wavelength region from $\sim 3700 \text{ \AA}$ to $\sim 1.05 \mu\text{m}$. Each is divided into three strips covering $\sim 500 \text{ \AA}$ per segment. The desired bandpass is selected by a combination of target position and filter wheel rotation. The central strip of each of the five linear ramp filters can be used with the HRC. The transmittance curve for each filter can be obtained at http://acs.pha.jhu.edu/instrument/filters/general/Master_Table.html. The total throughput curve, including the OTA and the ACS optical elements and detector quantum efficiency are available at <http://acs.pha.jhu.edu/instrument/photometry/>

This paper presents data relevant to the photometric performance and calibration of the two CCD cameras of ACS. Information on the SBC photometric performance are available in AIHv5, Tran et al. (2002a, 2002b), and Sirianni et al. (2002a). Section 2 presents a brief description of the WFC and HRC data and FITS file structure. In Section 3 we describe the main steps of the ACS calibration pipeline at STScI, including a discussion of the accuracy of bias and dark subtraction, flat field normalization, geometric distortion and charge transfer efficiency. Section 4 describes the spatial variation of the point spread function, the encircled energy profile and the long wavelength scattered light problem. The analysis of the variation of the encircled energy profile with the effective wavelength is used to estimate the aperture correction in all filters. Section 5 discusses the gain settings, and the linearity and saturation of the CCDs. Section 6 presents the absolute flux calibration of ACS. The definition of the photometric system of ACS and the determination

¹When expressed in percent the full width at half maximum transmittance is divided by the center wavelength of the band and multiplied by 100 percent

of the zeropoints are presented in Section 7. In Section 8 we present observed and synthetic photometric transformations between WFC and HRC. We also discuss transformations from the ACS photometric system to the UBVRI and WFPC2 systems. Sections 9 and 10 discuss the HRC UV red leak and the reddening in the ACS system, respectively. We inserted several sections in the appendix to include material that can be useful to some readers which are also ACS users. We provide a cookbook for the calibration of point source photometry, resolved object photometry and surface photometry, and additional material for transformations to non-ACS photometric systems of stars and galaxy templates.

This document represents our understanding of the CCD cameras of ACS as of Spring 2005. Any of the discussions or results presented here could be subject to revision as our understanding of ACS evolves.

2. ACS DATA FORMAT

The ACS Data Handbook (Pavlovsky et al. 2005, hereafter referred to as ADHv4) contains all the information needed to manipulate, process and analyze data from ACS. In this section we summarize the key elements of the ACS data structure.

2.1. WFC Data

Fig. 2 shows a schematic of the WFC focal plane array and readout amplifiers. The WFC focal plane array consists of two mosaiced CCDs. The imaging area of each of the two chips consists of 4096 columns each containing 2048 pixels. Each pixel is $15 \times 15 \mu\text{m}$ in size. The serial register, along one of the 4096 pixel edges of the device, is split in the middle so that the entire device can be read out through either one or both of the amplifiers that terminate each end of the serial register. There are 24 additional extended pixels (physical overscan) on each side of the serial readout register, just before each amplifier. The WFC raw data also contain a virtual overscan of 20 rows, obtained by over-clocking after the readout of the last CCD row. In order to minimize the readout time and reduce the number of serial transfers the default configuration is a 2-amp readout. Hence, each amplifier is used to read a single 2048×2048 quadrant. WFC-1 uses amplifiers A and B, and WFC-2 uses the amplifiers C and D. The WFC detectors are operated in Multi Pinned Phase (MPP) mode. MPP is used to hold the signal charge away from the surface Si-SiO₂ interface, thus reducing dark current rate, minimizing surface residual image effects and providing better charge transfer efficiency. The WFC detectors are operated in MPP mode only during the integration and not during the readout. Ground testing demonstrated that this configuration allows a higher full well capacity and provides better cosmetics.

The physical separation between the two CCDs is equivalent to 50 pixels, which corresponds to $2.5''$. The structure of the data and data products of the ACS calibration pipeline (CALACS; Hack & Greenfield 2000) is based on the previous HST instruments' file format and consists of multi-extension FITS files which store science (SCI), data quality (DQ) and error (ERR) arrays. Since WFC data come from two CCD chips, they are treated as separate observations with a specific SCI, DQ and ERR array for each chip, and with both chips being stored in the same FITS file. Thus the array SCI-1 in the FITS extension [1] stores data from WFC-2 and the SCI-2 array, in the FITS extension [4] store WFC-1 data. A more detailed description of the ACS file structure is available in ADHv4. At the end of the CALACS steps, when WFC data is

drizzled to combine dithered² exposures and/or remove geometric distortion, both chips are included in a single FITS extension.

2.2. HRC Data

The imaging area of HRC consists of 1024 columns each of 1024 pixels $21 \times 21 \mu\text{m}$ in size. This CCD has four output amplifiers, one at each end of the two serial registers. The array can therefore be divided into 512×512 quadrants to minimize the readout time. The default configuration is a single amplifier readout, namely amplifier C, which was selected for its lower read noise and better cosmetics. The HRC CCD is operated in MPP mode during integration time and readout. There are 19 additional extended pixels (physical overscan) on each side of the serial readout register. The HRC data also contains a virtual overscan, 20 rows on the top of the chip, obtained by overclocking the readout of the last CCD row. The structure of the HRC data is simple; a single HRC exposure comes from a single chip and has only three data extensions. One particularity of all HRC images is the presence of a finger-like shadow departing from one edge of the image (Fig. 2). This is the shadow of a fixed occulting mask called the “Fastie finger”, a $0.8''$ wide, $5''$ long reflecting finger permanently located at the CCD entrance window. This mask, together with the two coronagraphic circular stops that can be flipped in and out of the light path, constitutes the coronagraphic capability of HRC (Krist et al. 2003a).

3. ACS DATA TREATMENT

ACS raw data is processed by the ACS calibration pipeline (CALACS) at the STScI. A detailed description of the individual calibration tasks in CALACS is available in ADHv4. Briefly the CALACS pipeline consists of the following steps performed on the raw CCD scientific data:

- Subtraction of the bias level
- Subtraction of a superbias frame
- Subtraction of a superdark frame
- Application of a flat field
- Cosmic ray rejection of combined CR-split observations

The SITE CCDs are very stable; ground testing have shown that their response does not change over time or after thermal cycling. As consequence the flat fielding strategy for ACS is the same adopted for WFPC2 (Holtzman et al.1995a) which relies on well characterized high signal-to-noise flat fields acquired through all filters during ground testing. Second order adjustment of the ground flat fields are performed with limited on-orbit observations (see §3.4). Additional calibration steps are performed using MultiDrizzle (Koekemoer et al. 2002)³ which applies the correction of the geometric distortion of non-dithered images, and

²For a detailed description of the advantage of using a camera in *dithering* mode and of *drizzling* as image reconstruction technique see Fruchter & Hook, 2002.

³Until September 2004 PyDrizzle (Hack et al. 2003) was used instead of MultiDrizzle.

converts the data units from electrons to electron-rates. When multiple dithered observations are available, MultiDrizzle runs the Drizzle algorithm (Fruchter & Hook 2002) to register them into a single product. In the following, we briefly describe the main steps, as well as relevant instrumental effects not treated by the processing.

3.1. Subtraction of the Bias Level

WFC - Normal WFC images are read out using all four amplifiers, therefore each $2K \times 2K$ quadrant needs to be treated independently in the calibration process. All four amplifiers produce a horizontal ramp in the physical overscan, the region that serves to correct the bias level; it extends up to 18 columns toward the active area (Sirianni et al. 2001). Consequently, for accurate bias subtraction, only the last six columns of the leading physical overscan, those adjacent to the active area, are used by CALACS to estimate the bias level of each amplifier. In CALACS, the *doblev* routine creates a sigma-clipped average column of the selected area of the leading physical overscan, performs a linear fit along this column and subtracts the bias level row-by-row using a single fitted value for each. The virtual overscan is not used to estimate the bias level. This region shows large scale structure which is quadrant and gain dependent. This structure, due to the bias fixed pattern noise, makes the use of the virtual overscan in an automatic routine problematic. Moreover, this region can be contaminated by deferred charge due to degradation in parallel charge transfer efficiency (see §3.7).

Analysis of the active area in bias frames shows small differences in bias level between the leading physical overscan and the active area (Sirianni et al. 2002b). Ideally, no offset would be seen. This offset varies from amplifier to amplifier and it can be as large as 3.5 analog-to-digital converter units (hereafter, ADU).

In principle, if the residual offset between the imaging area and the overscan region were always of the same amplitude, a full-frame superbias subtraction (see next section) would remove any residual difference. Unfortunately, the offset is not constant but shows random variations of the order of a few tenths of an ADU. The cause of the residual offsets and their variation with time are still under investigation. They occur at a level below what could have been tested on the ground. They are likely the result of interference between the WFC integrated electronics module and the telescope and/or scientific instruments. The non-MPP readout mode could also play a role. The accuracy of the bias level subtraction in a single quadrant is limited by this random effect.

The difference between these two bias levels, i.e., the amplitude of the residual offset level, varies between quadrants. Since the bias level is measured in the leading physical overscan and subtracted from the active area of each quadrant, the center of the resulting image shows a “jump” between two adjacent quadrants. This offset is present in all calibration and science frames. Therefore science images, after bias and dark subtraction, may show a quadrant-to-quadrant jump as large as a few ADUs (see Fig. 1 in Sirianni et al. 2002b). For point source photometry, the local background is typically subtracted in an annular region, so the residual offset has essentially no impact on the integrated magnitudes. However, if the objects fall right across the jump, the photometry should be considered as suspect. Similarly, extended objects may spread over two or more quadrants, so their surface brightness profile will suffer from the residual offset. More studies are in progress to better characterize this problem and find a solution or develop a correction to apply directly into the calibration pipeline. At the moment we suggest to fit the sky level in each quadrant separately. A stand alone code, based on the STSDAS *pedsky* task has been written for the first order

removal of the bias offset in observations of sparse fields (Sirianni et al. 2005). This script first reverses the multiplicative flat field correction, then solves iteratively for the bias differences between the quadrants and removes them, before re-applying the flat field. This script has been used to produce sky-flats and for the data reduction of the Ultra Deep Field. It will be made available in the future on the ACS STScI Web site.

Finally, WFC images may show apparent amplifier cross-talks between the four amplifiers, which produces very low level dark “ghosts” evident as mirror images of bright objects in the other quadrants. The amplitude of this effect is usually below any scientifically significant level, and shows dependency on the background level and gain setting. A more detailed characterization of this problem is presented in Giavalisco (2004a, 2004b).

HRC - HRC images are read out using only one amplifier. As in the case of WFC the readout amplifier produces a horizontal ramp in the leading overscan which extends up to 10 columns toward the active area. The bias level is therefore measured in the last six columns of the leading physical overscan. The task *doblev* removes the bias level row-by-row as for the WFC quadrants. There is not a significant difference between the bias level in the overscan area and the active area.

3.2. Superbias Subtraction

Even after the bias level subtraction from the overscan, some structure remains in the bias frames. This structure includes real bias pattern and also some dark current. In every image, including the zero-exposure time bias frames, dark counts accumulate for an additional time beyond the integration time, primarily in the time required to read out the detector. Since WFC is operated in non-MPP readout, the dark current rate during the readout is higher than during integration time. In order to remove this structure, a superbias is subtracted from each image. Bias frames are being taken as part of the ACS daily monitoring program for each supported gain state. Superbiases are created weekly by combining seven daily frames (Mutchler et al. 2004). There is some evidence for intermittent variations in the WFC bias structure at sub-ADU levels. On a few occasions, some frames show bias jumps in one or more quadrants that can run for several hundreds of rows. These effects occur at few tenths of ADU level and they might appear in one or more quadrants simultaneously. The probable source is interference with the electronics by other activities on the spacecraft. At the moment there is no automatic detection of bias jumps within the calibration pipeline. Though bias jumps at the sub-ADU level are not important for most applications, they might exist in processed data and we recommend a careful inspection of the data for their presence.

3.3. Dark Subtraction

CALACS removes the dark current from each scientific frame by subtracting a superdark frame. Every day four 1000 sec long dark frames are acquired for both WFC and HRC. Every two weeks all the daily darks are combined in order to derive an accurate average dark rate for pixels which do not vary. These include normal pixels and hot pixels, i.e., pixels that generate a dark current higher than the average. Permanent hot pixels are due to native silicon lattice imperfections or impurities. During on-orbit operations, CCDs are exposed to radiation sources such as protons and neutrons that induce lattice damage and therefore generate hot pixel. As a consequence the population of hot pixels changes on a daily basis. Therefore, the STScI calibration pipeline uses as baseline a bi-weekly superdark which is updated with the hot pixel population of a specific day (Mutchler et al. 2004). For each science image, CALACS subtracts the appropriate superdark

multiplied by the exposure time and divided by the gain. Any dark current accumulated during the readout time is automatically removed by the superbias subtraction.

Sirianni et al. (2004) analyzed the evolution of the hot pixel population in two years of on-orbit operation from WFC and HRC dark frames. The number of hot pixels increases linearly with time. Pixels with a dark current greater than 0.08 electron/pixel/sec are flagged as “hot” in the data quality array in the FITS file. For this threshold Sirianni et al. (2004) report a daily rate of about 47 and 800 new hot pixels for HRC and WFC, respectively. Most radiation induced hot pixels can be annealed by elevating the temperature of the CCD, thus allowing the reconstruction of the damaged lattice structure. Analysis of the effectiveness of the monthly annealing process in the first two years of ACS operation shows that the annealing rate of new hot pixels with this threshold has been $\sim 82\%$ and $\sim 86\%$ for the WFC and HRC, respectively. Therefore the population of permanent hot pixels is growing at a daily rate of about 6 new pixels and 140 new pixels for the HRC and WFC, respectively. Currently (Apr 2005) about 0.9% of the pixels of the WFC and the HRC CCDs are permanently classified as “hot”. For comparison, a fraction of 1.5% to 3% of the pixels is typically impacted by cosmic rays in a 1000 second exposure. Hot pixels could for the most part be eliminated by the superdark subtraction. However since the dark current in hot pixels is dependent on the signal level (Janesick 2001), this process is not perfect. Moreover, there are indications that the noise in hot pixels is much higher than the normal shot noise (Riess 2002). As a consequence, since the location of hot pixels is known from dark frames, they are flagged and discarded during image combinations. Careful planning of the observations including a dithering strategy will remove the impact of hot pixels on the science frame. See AIHv5 and ADHv4 for the best strategy for hot-pixel removal.

3.4. Flat Field

Appropriate flat fielding normalizes the system illumination pattern together with pixel-to-pixel non-uniformities to generate accurate count rates which are independent of field position. Since in any WFC image each quadrant is read out independently, the ability to combine photometry from different chips/quadrants depends on the accuracy of the cross-quadrant and cross-chip normalization.

Intensive ground testing was devoted to the creation of laboratory flat fields to use for reduction of on-orbit data by simulating sky illumination of the CCDs. The Refractive Aberrated Simulator/Hubble Opto-Mechanical-Simulator (RAS/HOMS) was used to produce high S/N ratio flat fields which include both the low frequency (L-flat) and the high frequency pixel-to-pixel (P-flat) structure (Martel & Hartig, 2001 and Bohlin et al. 2001). The low order structure of the flats over the field of view is mostly due to the variations in the sensitivity of the CCD detectors. Thickness variations, non-uniform doping or anti-reflection coating can result in a different response to incoming photons across the device area. Moreover, since the conversion of photons to electrons occurs at different depths within the CCD photo-sensitive silicon substrate, depending on the energy of the photons, the “cosmetics” of a flat field strongly depends on the wavelength (see AIHv5). Furthermore, since the filters are close to the focal plane, variation in the filter transmission also contribute to the L-flat structure. The HRC CCD shows a typical sensitivity variation from center to edge of $\sim 10\%$, while the large format WFC minimum to maximum sensitivity variation is $\sim 15\%$. To normalize to unity, the flats were normalized by the average number of counts in the central 1% in area of the image. In the case of the WFC frames, the WFC-2 image was divided by the WFC-1 central value, in order to preserve the overall sensitivity difference between the two CCDs across the gap that separates the two chips.

These “ground” flats contain information about the variation in CCD response and spatial structure

in filter transmission, and were expected to differ from on-orbit flats principally by the ratio of the real HST+ACS illumination pattern and the RAS/HOMS illumination pattern. Comparison of the observed count rates for the same star in different positions across the chip, after flat fielding, provides an estimate of the residual errors of the flat field and of the accuracy of the chip-to-chip normalization. Early Servicing Mission Orbital Verification (SMOV) data, both of individual spectro-photometric standards and stellar fields, suggested the presence of a residual low-frequency flat field structure. There are a variety of plausible approaches to calibrate and remove this effect. However, the easiest methods to implement are either improper or not practical. The internal ACS calibration lamps illuminate the back of the calibration door, which is placed in the light path when a calibration lamp is turned on. Hence, the photons arrive at the detector through a different light path from science observations, bypassing the OTA. This results in a significantly different illumination pattern for internal flats relative to a uniform “sky”. So, while internal flatfield lamps exist, they are only used to monitor temporal variations. Bright earth flats prove to be impractical since they saturate in even the shortest exposures except when the HRC or the two narrow band filters are employed. Even then, the resulting images are highly structured and streaky in appearance due to terrestrial and atmospheric features passing through the field of view. The most obvious approach to correct for a residual L-flat structure is to use deep images of “empty” sky fields. However the creation of sky flats with an appropriate S/N ratio requires a very large number of images in each filter, and careful masking to remove galaxies, stars and other sources. Such an effort is currently in progress.

In the interim, a faster approach has been taken by the STScI ACS group. As described by Mack et al. (2002a), a moderately dense star field (NGC 104, in most cases) was observed at typically nine offset positions separated by hundreds of pixels, resulting in flux measurements of each star in nine largely separated positions. Since the entire field of view is well sampled by stars, the flux data is fitted to yield a low order (fourth order) polynomial L-flat as well as the flat-field corrected flux of each star. The resultant polynomial is combined with the high-spatial frequency structure of the ground flats to make new ‘P+L’ flats as described by Mack et al. (2002b) and van der Marel (2003). While the original ground-based P-flat fields produced photometric errors of the order of $\pm 5\%$ from corner to corner. The new ‘P+L’-flats yield a more uniform photometric response (within $\sim 1\%$) for a given star for any position in the field of view. As more data becomes available improvements will be possible with the adoption of sky flats. Updates will be posted in the STScI Web page.

Finally, for the first two years of operation the ACS filter wheel movements were accurate to one motor step, which leads to an error that can exceed one percent in the flat fields over small regions. For seven filters on the WFC and six on the HRC with the worst blemishes, flat fields are available as a function of the filter wheel offset step (Bohlin, et al. 2003). CALACS automatically selects the appropriate flat field corresponding to the offset step of each observation. On March 2004 the flight software has been updated to make the filter wheel movements completely accurate.

3.5. Cosmic Ray Rejection

As any other HST instruments, ACS is subject to cosmic rays and protons from the Earth’s radiation belts. Cosmic rays usually generate significant quantities of electrons in more than one pixel. A first characterization of the cosmic rays in ACS images (Riess, 2002a) shows that the fraction of pixels affected by cosmic rays varies between 1.5% and 3% during a 1000 sec exposure for both HRC and WFC. As consequence great care must be taken in planning and analyzing ACS observation to minimize the impact of cosmic rays on science images.

Cosmic ray rejection in ACS frames can be performed in CALACS with the task ACSREJ or with MULTIDRIZZLE. ADHv4 describes in great detail the two different techniques. Small offsets, even of the order of a few tenths of a pixel between pairs of images, can lead to apparent changes near a bright target that swamp expected Poisson differences. If large enough, these offsets can cause an incorrect flagging and rejection of the center of stars, mistaking the peak of a star for a cosmic ray. This problem is particularly severe for undersampled images. Optimization of the cosmic-ray removal process may require fine tuning of the image alignment process (Mack et al. 2002b).

3.6. Geometric Distortion

By design, the ACS focal plane arrays are tilted with respect to incoming rays (20° for the WFC and 31° for HRC). The result of this design is an image of the sky which is distorted in two different ways: 1) the pixels are elongated with a scale smaller along the radial direction of the OTA field of view than along the tangential direction, and 2) the pixel area varies across the detector.

The distortion affects astrometry and therefore the ability to register images taken at different pointings. Moreover, since the distortion causes pixels to have different effective areas as a function of their position, photometry and the flat fielding are also affected. The geometrical area of each pixel is imprinted in the flat field as well as the photometric sensitivity. PyDrizzle accounts for these effects and the final geometric corrected output is photometrically and astrometrically corrected. *If, however, flat fielded images are analyzed prior to the geometric correction with PyDrizzle, the effective area of each pixel must be accounted for when doing integrated photometry.* The correct total flux can be recovered by multiplying the flat-fielded images by the appropriate pixel area map. Once this correction has been applied and the image transformed in electrons/sec the same zeropoint as applied to drizzled data products may be used to transform to absolute flux units.

The calibration of the geometric distortion in the ACS detectors has been discussed in detail by Meurer et al. (2002,2003) and Anderson (2002). Dithered observations of the rich NGC 104 star cluster have been used to calibrate the distortion. A fourth order polynomial solution was found adequate for characterizing the distortion to an average rms accuracy of $\simeq 0.05$ pixels for the WFC and $\simeq 0.03$ pixels for the HRC over the entire field of view of the two cameras. Although the main distortion characterization was performed using F475W data, wavelength dependency of the solution has been checked with complementary observations in F775W (WFC and HRC) and F220W (HRC). A marginal increase in the rms in the redder filter was observed for the WFC, and little or no increase for the HRC. A more significant increase in the rms fit (up to 0.11 pixels) was observed in the UV HRC filter F220W, quite likely due to the elongation of $0.1''$ of the UV PSF. Similar elongation has been observed also in SBC PSFs, and can be attributed to the optics of either the ACS HRC/SBC mirrors or the HST OTA (Hartig et al. 2003).

Until September 2004 the geometric distortion was removed by PyDrizzle in CALACS using the correction table provided by Meurer et al. (2002) which provides an adequate solution for most of the applications which require an accuracy of the order of 0.1 pixels. A more sophisticated solution, which includes a wavelength dependency based on the Anderson (2002) and Anderson & King (2004) results, has been implemented in CALACS at the end of September 2004 as part of Multidrizzle (Koekemoer et al. 2002). The coefficients of the fit of the geometric distortion and the scripts to transform these coefficients into a pixel area map are available on the STScI/ACS web page.

3.7. Charge Transfer Efficiency

Charge transfer is one of the basic steps of CCD operation. Electrons are transferred from the pixel where they are collected to the readout amplifier. During the transfer of charge from one pixel to the next, defects in the silicon can result in traps that remove small amounts of charge from the charge packet. The Charge Transfer Efficiency (CTE) measures the effectiveness of the charge transfer in a CCD and it is typically measured as the fraction of charge transferred per pixel transfer.

CTE degradation is well known to affect data from previous HST cameras such as WFPC2 and STIS. Several detailed characterizations of the CTE degradation and formulation of empirical correction formulae for WFPC2 and STIS have been published (Whitmore et al. 1999, Stetson 1998, Saha 2000, Dolphin 2000b, Goudfrooij and Kimble 2002).

The total amount of charge lost increases with the number of pixel transfers. Therefore even if ACS has a better CTE per pixel than WFPC2, the impact of CTE degradation is expected to be larger in ACS data given the greater number of transfers (2048 for WFC, 1024 for HRC versus 800 for WFPC2).

During on-orbit operations, CCDs are subject to radiation damage that degrades their ability to transfer charges. CTE degradation can lead to photometric inaccuracy (the magnitude of an object will depend on the position on the chip), astrometric shifts (the shape of the PSF is altered) and decrease in discovery (the brightness of an object is reduced and deferred charges can increase the noise in the background). A comprehensive discussion of the type of radiation damage is beyond the scope of this document. Excellent review papers on the subject can be found in the literature (e.g. Janesick et al. 1991; Hopkinson 1991). The principal factor that influences the charge transfer is the presence of spurious potential pockets and defects in the silicon lattice structure. These defects, more generically called traps, act as trapping sites for the transient electrons: part of the electrons contained in the signal packet can be trapped and if they are released quickly, they rejoin the main packet of charge, but if they fall out of the traps at a slower rate than they go into the traps, they are left behind. The net CTE loss depends upon the trap constants, their relevant variables, and the number density of traps (see Cawley et al. 2001 for a detailed description of the trap characteristics).

In order to reduce the impact of CTE degradation, the ACS CCDs, by design, incorporate a mini-channel, a narrow extra-doped channel inside the buried channel. The higher potential, due to the extra-doping, is designed to store and transfer small charge packets ($<7\text{-}10 \times 10^3$ electrons) entirely within the mini-channel. The possibility of interaction between the charge packet and the traps in the buried channel is therefore minimized resulting in a significant improvement of the CTE at these low signal levels.

A poor CTE has a strong impact on high precision photometry. One of the major manifestations of severely degraded CTE is the presence of tails of charge apparently streaming out of stellar point sources, in a direction away from the serial register. These tails are due to the release of trapped charges on timescales slightly longer than the readout clocking rate. Not all trapped charges are released within a few milliseconds; some traps release the charges in much longer time scales and contribute to the background noise of that same exposure or a subsequent one. This complex mechanism of capture and release, which depends on numerous factors (such as temperature, signal size, readout rate and background level), can result in non-linearity across the device, reduced image quality, reduced sensitivity, and a loss in spatial resolution. The effect of poor CTE on extended sources has been examined by Riess (2000) by subtracting pairs of images of galaxies observed near and far from the output amplifier. As one would expect, the charge is lost primarily from the leading edge of the galaxy image (the one closer to the readout amplifier). The trailing edge does

not suffer significant loss because the traps it sees are filled. It actually might see an increase in signal due to deferred charges. The resulting asymmetry of extended objects may not have negligible consequences for statistical measurements of galaxy morphology, position angle, axial ratio and asymmetry concentration (e.g. such as required for weak gravitational lensing studies of field galaxies). The net loss to a measured galaxy magnitude has small dependence on the size of the aperture used; it is usually in good agreement with the photometric loss expected for point source photometry.

Several programs monitor the CTE performance of the CCDs in ACS. They are based either on calibration images taken with internal lamps (Sirianni et al. 2003; Mutchler et al. 2005) or on the analysis of the cosmic ray tails in dark images (Riess 2002). These tests can track variations in CTE on a timescale of a few weeks. Monitoring CTE degradation is fairly easy, but the calculation of a correction formula based on stellar photometry and on the number of parallel and serial transfers in the CCDs is more difficult. There are several aspects to take into account: background level, signal strength of the source, photometric technique, etc. A large amount of data is necessary to constrain all dependencies. Riess (2003) and Riess and Mack (2004) have presented correction formulae to correct photometric losses as a function of a source’s position, flux, background, time, and aperture size in ACS CCDs.

Riess (2003) found that the observed photometric losses in WFC (HRC) range from $0.0\% \pm 0.2\%$ ($\sim 1\%$) for bright stars ($\sim 10^5$ electrons) on a significant background (\sim tens of electrons) to as much as 7%-10% (5-6%) for faint stars (few hundred electrons) and faint background (< 5 electrons). The observed dependence of the parallel transfer CTE loss (YCTE) versus stellar flux suggests a power-law relation which was utilized in the correction formula. Such a formula includes dependence on the position, stellar flux, background level and time of the observations. At the moment the correction formula does not include a dependence on the number of serial transfers. In general the contribution of CTE degradation in the serial direction to the total charge loss is minimal due to the faster readout clocking as demonstrated by pre-launch testing. While internal calibration data already show a degradation even in the serial direction, it is still too weak to be detected with stellar photometry. Future observations will allow better constraints on the correction for CTE loss in both directions.

In the future, the effects of CTE degradation can be mitigated using the post-flash capability included in the ACS. A relatively low amount of charge is added to the general background and hence mitigate the effects of CTE degradation. However the addition of this charge will of course elevate the background contribution of the noise. Also, HRC can be operated in 4-amps readout, thus reducing the maximum number of parallel transfer from 1024 to 512.

4. THE ACS POINT SPREAD FUNCTION

A detailed analysis of the image quality of the ACS cameras has been presented by Clampin et al. (2002) and Hartig et al. (2003). The latter also discusses the stray light characteristics, describing several ghost images and scattered light features. Naturally, observed Point Spread Functions (PSFs) vary with wavelength, field position and time. Variations within the FOV arise from a combination of defocus, coma, astigmatism and charge diffusion. Time variations occur from focus changes and from spacecraft jitter during the exposures.

4.1. Spatial Variations

In general, PSF field-dependent variations in the ACS cameras are less severe than in other HST cameras. Krist (2003b) performed a very detailed study of the WFC and HRC field dependent PSF variations due to optical and detector effects. Residual optical aberrations reduce the flux within the core of the PSF and redistribute it into the wings, degrading the Encircled Energy (EE). ACS/WFC PSF core width and ellipticity variations across the field are large enough to be a concern in the case of very small aperture photometry. Therefore, when performing PSF-fitting photometry it is more appropriate to assume a spatially variable PSF when computing a PSF model or fitting stars to the PSF model itself. In the smaller FOV of the HRC, the PSF can be essentially regarded as constant.

The major cause of alteration of the FWHM across the FOV is the blurring caused by the detector charge diffusion. All ACS CCDs are thinned backside-illuminated devices, therefore the electrodes are on the rear face of the chip. Since the depth at which a photon is absorbed within the epitaxial layer is proportional to the wavelength, blue photons generate electrons at the top of the photosensitive layer. If the electric field is weak at the depth at which the electrons are generated, they may move and be collected into adjacent pixels. Charge diffusion is expected to be greater in the thicker regions of the CCD and the largest variation in charge diffusion across the FOV are seen at the short wavelengths. Thickness variation in the ACS CCDs have been derived from fringe flat fields obtained during ground tests of the camera (Walsh et al. 2002,2003). These results show that the CCD thickness varies between 12.6-17 μm in the WFC and 12.5-16.0 μm in the HRC.

Analytical modeling of the PSF in any position of the FOV of both ACS CCD cameras is possible with TinyTim (Krist 2003c). Krist (2003b) developed a specific blurring kernel to reproduce the observed amount of charge diffusion observed and these corrections have been implemented in the latest release of his software.

Dithering is a well established technique for HST imaging and has many advantages such as improving the sampling of the PSF and mitigating the impact of hot pixels and detector blemishes (see ADHv4). The choice of the kernel for drizzling can change the shape of the core of the PSF. All our data were processed with the default linear kernel, but a different kernel is possible depending on the data and scientific objectives. For example, if the square kernel is applied to a single image, with the parameters set to perform a bilinear interpolation, the output image will have strongly correlated noise and also degraded resolution. In all cases where correlated noise is a major concern more different drizzle kernel should be considered. For example, the ACS Science Team pipeline (Blakeslee et al. 2003a) processes all Guaranteed-Time-Observation (GTO) data with the Lanczos3 kernel which produces a sharper PSF core and a significant decrease in the apparent noise correlation in adjacent pixels.

4.2. Encircled Energy Curves

In order to measure the encircled energy profile, i.e. the fraction of total source counts as a function of the aperture radius we used the very high S/N observation of the spectrophotometric standard stars used for the zeropoint determinations (see §7). All stars are near the center of the chip. In the case of the WFC the star was first centered in WFC-1 and then in WFC-2. In all cases a couple of images have been taken for cosmic ray rejection. The images have been processed with CALACS and the geometric distortion has been removed with PyDrizzle.

The PSF of any instrument extends essentially to infinity. The far-field PSF can be measured only with

very high S/N observations of isolated stars. Still, it is impossible to measure the flux beyond a certain radius without incurring systematic errors due to background determination, large scale flat field residual errors, nearby objects in the field or detector edges. We have chosen to normalize the encircled energy curves to the light at a $5''.5$ circular radius aperture. Analysis of PSFs of saturated and unsaturated stars in all filters shows that this aperture is a safe assumption to measure the total flux within an “infinite” aperture. It is also the maximum radius allowed for most of the images with stars centered in the HRC FOV due to the presence of the Fastie finger.

One of the most difficult task for the proper measurement of the encircled energy at large apertures is the determination of the sky background. In order to minimize the impact of errors in the sky determination, in all cases where multiple observations are available, we used the following technique. First, using the information in the Data Quality (DQ) array, we masked out the defective pixels in the SCI. This allowed us to exclude bad pixels or pixels masked by aperture features (such as the Fastie finger in HRC) when performing statistics on the sky and the photometry. Then, for each observation and for each filter, we determined the mode sky level in the sky annulus (from $6''$ to $8''$ for WFC and from $5''.6$ to $6''.5$ for HRC) and used this value to derive the total counts inside the $5''.5$ radius aperture. Under the assumption that the flux of a standard is constant and that for large aperture the major source of error should be only the Poisson noise, we calculated the median value of all determinations of total flux and calculated the appropriate sky level in each image necessary to reproduce the median flux level. We then used the new sky level to perform the aperture photometry with DAOPHOT in a wide range of aperture radii.

The mean EE curves for different broadband filters are plotted as a function of the aperture radius in Fig. 3 for the WFC and Fig. 4 for the HRC. All curves are normalized to the mean value at $5''.5$, however in order to show in more detail the structure of the curves at smaller radii, only the values for the inner $3''$ are plotted. The value of the EE for the broad-band filters with errors are tabulated in Tables 3 and 4. In order to better sample the impact of the long wavelength halo in the near IR (see next section) we also include the narrow-band filter F892N, whose effective wavelength falls between F814W and F850LP. The errors in these tables are the standard deviations from the different observations.

There are some variations between different observations. The main one is a commanded focus change operated with a movement ($3.6 \mu\text{m}$) of the HST secondary mirror on December 2, 2002. This focus change has slightly modified the PSF in all wavelengths, but the most significant variation is seen in HRC-UV PSFs which show a slightly sharper core. Normal thermally-induced variations of the HST focus (breathing) may typically produce, within a single orbit, a displacement of the secondary mirror comparable to the one commanded in December 2002. We therefore chose to average the EE profiles before and after the focus change to create the mean EE curves. The larger errors at small aperture radii in the EE curves of the HRC/UV filters reflect this variation in the PSF. On the other hand, the average PSFs at the center of WFC-1 and WFC-2 are remarkably similar and we decide to combine the two datasets to improve the statistics.

Running PyDrizzle with different kernels produces PSF profiles which are significantly different only in the core of the PSF (0-10 pixels). The aperture corrections calculated with the EE can be applied to the photometric data, regardless of the choice of kernel, for aperture radii larger than 10 pixels.

4.3. Long Wavelength Scattered Light

All ACS CCD detectors suffer from scattered light at long wavelengths. They are thinned backside-illuminated CCDs and consequently are relatively transparent to the near-IR wavelength photons. A 16 μm -thinned CCD transmits $\sim 5\%$ of 8000 \AA photons and $\sim 85\%$ of $1\mu\text{m}$ photons. In the case of SITe CCDs the transmitted long wavelength light illuminates and scatters in the CCD header, a soda glass substrate. It is then reflected back from the header’s metalized rear surface and re-illuminates the CCD’s frontside photosensitive surface (Sirianni et al. 1998). The fraction of the integrated light in the scattered light halo increases as a function of wavelength. The onset of the halos occurs at a wavelength of $\sim 7500 \text{\AA}$. The HRC CCD scatters the near-IR light into a broad halo centered on the target; the intensity of the halo increases with the wavelength and reaches about 20% of the total energy at $1 \mu\text{m}$ (Fig. 5).

In order to rectify the long wavelength halo, the WFC CCDs incorporate a special anti-halation aluminum layer between the frontside of the CCD and its glass substrate (Sirianni et al. 1998). While this layer is effective at suppressing the IR halo, it appears to give rise to a relatively strong spike in the row direction toward the edge containing amplifiers AC as illustrated in Fig. 5. This feature, probably due to scatter from the CCD channel stop structure, contains $\sim 20\%$ of the PSF energy at $1\mu\text{m}$ but is almost insignificant at 8000 \AA (Hartig et al. 2003).

The EE profiles change naturally with the wavelength in any diffraction limited optical system, however at the onset of the long wavelength halo, the PSF becomes broader than expected. Figs. 3 and 4 show the variation of the EE profile for the standard stars as a function of the filter in the visible and near-IR for the WFC and HRC, respectively. In the case of the WFC, the long wavelength halo is effectively suppressed by the anti-halation aluminum layer; the EE profiles of all filters from F555W to F814W overlap nicely and only the F850LP EE shows sign of broadening with $\sim 2.3\%$ less flux in a $0''.5$ radius aperture than in the same aperture in F814W. The effect of the scattered light is more severe for HRC (Fig. 4) where the broadening of the PSF is clearly visible at F775W and increases at longer wavelength. With respect to the flux contained in a $0''.5$ radius aperture in the F625W filter, the HRC F775W, F814W and F850LP PSFs contain respectively about 3.3%, 8.5%, and 16.9% less flux.

The same mechanism responsible for the variation of the intensity and extension of the halo as a function of the wavelength is also responsible for the variation of the shape of the PSF as a function of the color of the source. The spectral energy distribution of two stars with different colors is different within any given bandpass. If we take as an example the F850LP filter and we observe a hot star and a cold star which produce the same total counts in this filter, more long wavelength photons are collected from the red star than from the blue star (see Fig. 6). As a result, the number of photons transmitted by the F850LP filter that are scattered in the CCD substrate is larger for the red star than for the blue star. The PSF for the red star will therefore be broader than the one of the blue star. The effective wavelength is a source-dependent passband parameter which represents the mean wavelength of the detected photons and can be used to estimate *shifts* of the average wavelength due to source characteristics (e.g., temperature, reddening and redshift) and is defined as⁴

$$\lambda_{eff} \equiv \frac{\int f_{\lambda}(\lambda)P(\lambda)\lambda^2 d\lambda}{\int f_{\lambda}(\lambda)P(\lambda)\lambda d\lambda}$$

where $P(\lambda)$ is the dimensionless passband transmission curve, and $f_{\lambda}(\lambda)$ is the flux distribution of the object,

⁴This definition include the factor λ/hc to convert the energy flux to photon flux as appropriate for photon-counting detectors.

usually in $\text{ergs cm}^{-2}\text{s}^{-1}\text{\AA}^{-1}$. λ_{eff} can be used to estimate the impact of the light scattering on the aperture correction for any observation.

In order to characterize the ACS throughput in the near-IR and the PSF in the filters affected by the long wavelength halo, a set of intrinsically red stars have been observed with both HRC and WFC (Gilliland & Riess 2002). We used these three stars with spectral types M, L, and T to calculate the near-IR EE curves. For the M and T stars, flux-calibrated spectra are available from the literature, whereas for the L-dwarf a STIS spectrum has been acquired. Spectrophotometric data are used to get information on the wavelength distribution of the flux in the near-IR filters, i.e. to calculate the effective wavelength. Gilliland & Riess (2002) compared the observed flux of the three standard stars within an aperture of $2''.8$ with the prediction of the ACS exposure time calculator and provided a provisional quantum efficiency correction in the near-IR. We derived the EE profile from these stars using the same data but, as in the case of the EE of the standard stars, the curves have been normalized to the counts in a $5''.5$ radius aperture. Figs. 7 and 8 show how the EE profile changes with the spectral type in F850LP for the WFC and HRC respectively. We did not include the curve for the T6.5 star in Fig. 8 because it was impossible to obtain an accurate profile up to $5''.5$. It should be noted that although Fig. 3 shows a broadening only for the WFC F850LP EE, this does not mean that only this filter can be affected by scattered light at long wavelengths. Those curves have been determined from the observations of two spectrophotometric standard stars, both hot white dwarfs. Although its effect is greatly reduced by the anti-halation correction, light scattering occurs also when a very red object is imaged through the F775W and F814W WFC filters. From Figs. 7 and 8 it is evident that for all filters affected by the long wavelength light scattering the aperture correction will be different for objects with different colors (see § 4.5).

The first assessment of the scientific impact of this PSF artifact in the near-IR was made by Sirianni et al. (1998) and Gilliland et al (2002). The presence of an extended halo centered on the core of the target has the obvious effects of reducing the signal-to-noise and the limiting magnitude of the camera in the near-IR. The halo can also have an impact on the photometry on very crowded fields. The effects of the long wavelength halo should also be taken into account when performing morphological studies. The apparent size of a resolved object in any near-IR filter can increase with the intrinsic color of the source.

In general, the effects of the PSF red halo should also be considered in doing surface photometry of extended objects, as significant biases may occur. For example, Tonry et al. (1997, 2001), found that the $(V - I)$ colors of their ground-based survey galaxies measured with thinned SITe CCDs (such as used in ACS) were too red by several hundredths of a magnitude or more. The bias was attributed to this fraction of the I-band light of the standard stars being lost to the red halo. Since the galaxy photometry was measured over larger areas, they appeared too red with respect to the standards. Reobservation of the galaxies with thick CCDs was undertaken to ensure accurate photometry.

In the case of ACS, we have calibrated the standard star photometry to infinite radius, so the integrated colors of extended objects within very large apertures should be correct. However, a bias may still occur for measurements of small aperture colors or gradients, especially for the HRC. Michard (2002) has done experiments convolving model early-type galaxies with empirical PSFs that included the CCD red halo. He found that the bias was large enough to reverse the sense of some $(V - I)$ gradients; the effect on colors involving the z band would be even greater. Michard recommended convolving each image with the PSF from the other bandpass before attempting to measure galaxy color maps. Blakeslee et al. (2003b) took the opposite approach in measuring ACS/WFC $(i-z)$ colors of faint early-type galaxies within the galaxy effective radii. They deconvolved the images in each bandpass using empirical WFC PSFs and an implementation of the CLEAN algorithm (Högbom 1974) that preserved total flux; the mean color correction for their sample

was +0.05 mag, and twice this for the most compact galaxies. Thus, there are various approaches to the problem, but proper care is required to achieve accurate galaxy colors.

4.4. Aperture Correction

In order to reduce errors due to the residual flat fielding error and background variations, and to increase the signal-to-noise ratio, the two most popular photometric techniques, aperture photometry and PSF-fitting photometry, are usually performed by measuring the flux within a small radius around the center of the source. This measurement must be tied to the total count rates by applying an aperture correction. This correction could be the major source of systematic errors in the calibration of PSF fluxes.

For all the photometric calibration measurements, we decided to use an aperture of $5''.5$ radius. This allowed us to estimate the total flux of spectrophotometric standard stars and apply correction to the response curve of the instrument (see §6). Our zeropoints are based on such measurements and therefore they refer to this fiducial aperture. However such a big aperture can be used only for bright and isolated sources and is impractical for most science observations.

A definition of zeropoints linked to a smaller aperture is often more convenient. For example, WFPC2 zeropoints are historically defined in relation to the flux in an aperture of radius $0''.5$ (Holtzman et al. 1995a). Using a non-infinite zeropoint implies an additional correction to the zeropoint for surface photometry. This corresponds to the aperture correction from $0''.5$ to nominal infinity which amounts to 0.1 mag for WFPC2, irrespective of filters (Holtzman et al. 1995a). But even a $0''.5$ aperture is impractical for point source photometry in a number of situations (photometry of crowded stellar fields, faint objects or targets with an uneven background) and smaller apertures need to be used, with the consequent need for aperture corrections. In all these circumstances, it is also impossible to measure the aperture correction from any smaller aperture radius to “infinity”.

A WFPC2-like approach for the zeropoint definition is less practical for ACS because, in both HRC and WFC, the aperture correction from $0''.5$ to “infinity” fluctuates from filter to filter with variations up to 15%. In §7 we therefore provide zeropoints for the fiducial aperture ($5''.5$), which can be used directly for surface photometry. This choice is also dictated by the fact that the photometric calibration defined by STScI and returned by SYNPHOT traditionally refers to an “infinite” aperture, allowing a better conversion between point sources and extended sources.

As part of the ACS calibration we have determined the count rate conversion from an intermediate aperture to “infinity”. In Table 5 we provide the aperture correction from $0''.5$ to “infinity” (AC05) derived from the EE profiles listed in Tables 3 and 4. The offset between photometry within a smaller aperture and that for photometry with a $0''.5$ radius aperture can be easily determined and added to the value listed in Table 5. This is usually done by measuring a few bright stars in an uncrowded region of the FOV and applying such offset to all photometric measurements. If we define the observed magnitude as

$$OBMAG = -2.5 \times \log(\text{total count rate } [e^-/s]) \quad (1)$$

then for point source photometry Equation 1 becomes:

$$OBMAG = -2.5 \times \log(\text{count rate at } r \leq 0''.5 [e^-/s]) - AC05 \quad (2)$$

where AC05 is listed in Table 5. The AC05 values are derived from the photometry of the two spectrophotometric standards stars used in this paper. They are both hydrogen white dwarfs and therefore are not

suitable for deriving the aperture correction for stars with much redder colors (see next section).

One of the problems that must be addressed is that the variation of the PSF as a function of position on the image may require the application of different aperture corrections for different regions of the FOV. Of course, how the photometry is carried out determines how seriously the results are affected by the space and temporal variations of the PSF. If the aperture used is large enough (about $0''.5$ arcsec in radius), then the aperture correction will be both small and fairly constant. When performing photometry in a small aperture, instead, the assumption of a single aperture correction applied to all photometry in the entire chip may lead to large systematic errors. To minimize this effect, an empirical mapping of the aperture correction should be applied. An appropriate dataset will eventually be available but meanwhile it may be possible to compute a suite of PSF models using TinyTim. Unfortunately, the current version of TinyTim does not model the residual long wavelength halo in the WFC and the HRC PSF models include only a rough estimate of the long wavelength scattered light.

Our determination of the EE profiles, and therefore of the aperture correction, is based on aperture photometry and on the measurement of the sky level within an annulus far from the object (from $6''$ to $8''$ for WFC and from $5''.6$ and $6''.5$ for HRC) in order to estimate the “true” sky level if a smaller annulus is chosen, closer to the center of the object, the sky level will include more light from the wings of the stars and therefore the sky-subtracted counts will be lower. From the tabulated EE in this paper or from PSFs created with TinyTim and assuming a stable PSF, it is possible to calculate the correction to apply to a measurement with any choice of sky annulus to correct it for the true sky level.

Finally, we must stress that accurate aperture corrections are a function of time and location on the chip. A blind application of the data tabulated in this paper should be avoided, especially at small radii, and when using small apertures for the photometry, the aperture correction should be derived for each frame on which measurements are made. Avoiding this necessary step can introduce systematic errors in the photometry up to several percents. The tables provided here should be used to estimate approximate aperture corrections when it is otherwise impossible to determine such corrections directly from the image.

4.5. Aperture Correction In The Near-IR

In order to assess when the broadening of the PSF due to the long wavelength halo should be taken into account and to estimate the aperture correction for red stars we combined the information from the EE profiles of all the stars used for the characterization of the long wavelength light scattering. We first calculated the effective wavelength in all filters for each star. The effective wavelength can change significantly within the same filter; for instance, in the WFC/F850LP there is a difference of ~ 760 Å between the effective wavelength of the hot white dwarfs and the cold T dwarf. Then we calculated the aperture correction from a few selected aperture radii to the nominal infinite aperture using the EE profile of each star. We finally correlated the aperture correction and the effective wavelength for each filter/aperture combination as shown in Fig. 9 and 10 for WFC and HRC respectively, for a few selected apertures (3,5, and 10 pixel radii equivalent to $0''.125$, $0''.25$, and $0''.5$, for WFC and 3,5,10 and 20 pixel radius, equivalent to $0''.075$, $0''.125$, $0''.25$, and $0''.50$ for the HRC). The values for each star are represented with a different symbol. Not all the stars have a complete set of observations in all filters. For each star we display only the points relative to broad-band and narrow-band filters for which it was possible to determine an EE profile up to $5''.5$. For any choice of aperture radii there is a fairly smooth variation of the aperture correction as a function of wavelength. For both the WFC and the HRC, the aperture correction is fairly uniform in the visible but increases in the blue

and in the near-IR. The increase of aperture correction in the blue is due to charge diffusion (see §4.2), while the increase in the red is due to the long wavelength halo (see §4.3). Naturally, the smaller the aperture, the stronger the variation in aperture correction with the effective wavelength. In Tables 6 and 7 we list the aperture correction to the fiducial aperture for a regular grid of effective wavelengths and several aperture radii obtained after interpolation of the plotted data.

In order to use these tables, the effective wavelength for a specific observation need to be calculated. If an empirical spectrum or a model of the SED of the object is available, the effective wavelength can be easily calculated for any filter, for example with the task CALCPHOT in SYNPHOT. Table 8 lists the effective wavelength of a sample of stars of different spectral types in the near-IR filters for WFC and HRC.

If the SED of the object is totally unknown but observations in at least two filters exist with the same ACS camera, it is still possible to get an estimate of the effective wavelength. First the count rates of the target should be measured in both filters using the same aperture radii and in such a way that the instrumental color for the selected apertures can be calculated:

$$color_r = -2.5 \log((count\ rate)_{flt1,r} / [count\ rate]_{flt2,r})$$

where flt1 and flt2 are the two filters and r is the radius of the aperture where both fluxes have been measured. Then a $color_r$ vs effective wavelength relation can be created with SYNPHOT for any combination of filters and aperture radii using an atlas of synthetic spectra covering a large range of spectral types. Several spectral atlases are available in STSDAS but any atlas can be used. Both effective wavelength and $color_r$ can be computed with the routine CALCPHOT in SYNPHOT. In fact, a new keyword “aper” has been implemented to call for the encircled energy tables in the OBSMODE for ACS. This keyword allows one to estimate the flux of a star within a selected aperture and not just the total flux in an infinite aperture, which is the default for SYNPHOT. As an example we show the $color_r$ vs. effective wavelength relation for three near-IR filters for the WFC using the $color_r$ F814W-F850LP and an aperture of $r=0''.5$ in Fig. 11. In order to produce this plot, we ran CALCPHOT using the Bruzual, Perrson, Gunn and Stryker (BPGS) stellar atlas available in STSDAS to calculate the effective wavelength and the synthetic $color_r$ with $r=0''.5$. We also plot in the same figure the position of the five stars used for the EE study. This approach can be applied to any camera, color and aperture. From plots of this type it is possible to estimate the effective wavelength of an object and get the aperture correction from any choice of aperture radius to the nominal “infinite” aperture from Tables 6 and 7.

In order to better quantify the impact that the near-IR scattered light has on ACS photometry we present two cases in Appendix C, the first one for a high redshift galaxy and the second for point source photometry of an extremely red star.

5. GAIN, LINEARITY AND SATURATION

Both WFC and HRC can be operated at multiple gain settings, nominally at 1, 2, 4 and 8 e^-/ADU . However only two settings are fully supported for each camera, gain 1 and 2 for WFC, and 2 and 4 for HRC. On-orbit calibration is not available for unsupported gain settings, and therefore they will not be covered in this paper (see AIHv5 for more information on all available gain settings). The default gain values of $\sim 1 e^-/ADU$ for WFC and $\sim 2 e^-/ADU$ for HRC have been used to establish the adjustment to the quantum efficiency curves.

The absolute gain value for the WFC and HRC were derived during the ground calibration campaign

at GSFC in the spring/summer 2001. Details on the procedure and analysis is available in Martel et al. (2001a, 2001b) respectively for WFC and HRC. The measured gain had a typical accuracy of 0.6%. Bohlin et al. (2002) improved the determination of the relative gain between the pair of amplifiers on the same CCD chip and the gain ratio between the two WFC chips. The authors used pre-flight flat fields and maintained the same mean value over all amplifiers at a given gain setting by imposing a continuity constraint across quadrant boundaries on each chip and at the adjacent edges of the gap between the two chips. This provided an improvement in amplifier-to-amplifier gains to better than 0.1%.

Since all the photometric calibration data are taken with the default gains, it is important to know the accurate ratio between different gain settings to transform the current calibration to non-default gain observations. Gilliland (2004) performed an accurate adjustment of the major gain values relative to the default gain levels through the analysis of repeated observations in the same filter of the same stellar field, at different gain settings. Gilliland’s findings improved the relative calibration of gains to better than 0.1%, removing errors that average about 1% for both HRC and WFC. The corrections to the gain value for WFC gain 2 and 4 and HRC gain 1 and 4 were implemented in CALACS on January 6, 2004. The new values (see Table 9) are being used for the calibration of any data retrieved from the HST archive after that date. Table 9 shows the corrective coefficient to add to the zeropoints for data processed before January 6, 2004.

Absolute errors of $\sim 0.6\%$ are still possible in the default gain values. However, these absolute errors have no impact in the photometric calibration of ACS because the adjustments to the detector quantum efficiency, and therefore the zeropoints, were based on data acquired with the default gain settings. The use of the appropriate relative gain ratios between quadrants and between the default and the supported settings will assure that the photometric calibration accuracy is maintained in all modes. Since the output of CALACS is an image already converted to electrons (FLT files) or electrons/sec (DRZ files), there is no need to differentiate the photometric calibration for different gains. For the current paper we assume that the image has already been converted to electrons and therefore $1 \text{ ADU} \equiv 1 \text{ e}^-$.

The default gain settings for WFC and HRC do not sample the full well depth of the CCDs. Both WFC and HRC employ 16-bit analog-to-digit converters (ADC), which can produce a maximum of $2^{16} - 1 = 65,535$ ADU. The largest number of electrons representable by these ADCs is therefore given by $gain \times 2^{16} - 1$. Any charge packet containing more electrons than $gain \times 2^{16} - 1$ will therefore reach digital saturation. At the default gain setting the digital saturation occurs for charge packets of $\sim 65,535 \text{ e}^-$ and $\sim 131,072 \text{ e}^-$ for the WFC and HRC, respectively.

The physical full well of the CCDs has been measured on the ground with flat field illumination (Sirianni & Clampin, 1999a,b) and on-orbit with observations of star fields (Gilliland, 2004). The measured full well is $\sim 84,000 \text{ e}^-$ for the WFC and $\sim 165,000 \text{ e}^-$ for the HRC, with variations of the order of 10% and 18% in the FOV for the WFC and HRC respectively (Gilliland, 2004). Once the physical saturation is reached, pixels lose their ability to collect additional charges. The additional charge will then spread into adjacent pixels along the same column (blooming). Since in both cameras the digital saturation is reached before the physical saturation, the use of higher gain settings can be beneficial for very bright objects.

Gilliland (2004) also analyzed the linearity of the response beyond the physical saturation level for both ACS CCDs. They found that with the use of a gain setting that samples the full well depth, the response of the CCD remains linear well beyond saturation. It is therefore possible to perform $< 1\%$ -accuracy *aperture* photometry of isolated saturated stars by selecting an aperture big enough to contain all pixels that received charge from the saturated pixels. On the contrary, if $gain = 1$ is set, any information on the charge content of pixels that reached the digital saturation is lost. In some cases, however, is still possible obtain an estimate

(with an accuracy of 2-10%) of the magnitude of the object (Maíz-Apellániz, 2002).

6. THE ABSOLUTE FLUX SCALE OF ACS

Considerable effort has been devoted to the determination of accurate response functions for the photometric passbands of ACS. These curves are the product of the characteristic functions of all the individual components in the optical path of the combination of telescope and scientific instrument. In particular, in the case of the ACS, this includes the reflection efficiency of the optical telescope assembly (OTA) and of the internal ACS mirrors, the transmission efficiency of the filters, the transmittance of the dewar window(s) and the quantum efficiency of the detectors. This means that although the HRC and WFC channels share the same filters, the different optimization of the optics and detectors (see §1) can yield a quite different response function for the same photometric passband. These curves are implemented in SYNPHOT, which is used by the ACS pipeline to populate the image header, to estimate exposure times for ACS observations, and to provide synthetic photometry calibration. The sensitivity curves are also used to translate physical quantities from stellar models, such as isochrones, into the observational plane. The ACS system response curves represent the basis of the ACS synthetic photometric system.

Estimates of the transmission, reflectance, and response of all components of ACS were made on the ground (see Ford et al. 1998). Modification to the pre-launch response curve, made by comparison with the observed count rates of spectrophotometric standard stars, are often needed to improve the accuracy of the predicted sensitivity curves.

The first check of the on-orbit sensitivity of the ACS was made during SMOV (Sirianni et al. 2002b). The throughput of the WFC was found to be higher than expected from ground measurements: from a few percent in the red up to $\sim 20\%$ in the blue. Similarly the HRC sensitivity was higher than predicted in the visual and in the red but it also showed an unexpected dip in the UV at $\sim 3200\text{ \AA}$. These first observations were used to derive rough corrections to the pre-flight sensitivity curves for a preliminary SYNPHOT update in August 2002.

Additional observations have permitted a fine tuning of these corrections with an average improvement of $\sim 2\%$ in the uncertainty. The data consist of an extended set of observations of the spectrophotometric standard stars GRW +70 5824 and GD71, both DA dwarves, taken between May, 2002, and January, 2003. Of these, only GD71 is a primary HST spectrophotometric standard. Its data were collected in May, 2002, during the SMOV program, in all filters with both the WFC and HRC cameras. GRW+70 5824 was observed in July, August and September of 2002 through most of the filters with both channels. Additional observations were collected in the course of the HST cycle 11: GRW+70 5824 was observed through all WFC filters in January, 2003, and all HRC filters in February, 2003. Finally, observations of GRW+70 5824 in the three bluest HRC filters were gathered in December, 2002 and January, 2003. In all cases, WFC images were collected by reading out a 512×512 subarray around the target, whereas for the HRC the default was a full frame configuration. In order to remove cosmic ray hits, at each epoch, a pair of images was obtained for each combination of camera and filter. The default gain settings were used for WFC and HRC, namely 1 and 2. A synopsis of the observations used, with the measured count rates, and a more detailed explanation of the data reduction are given in De Marchi et al. (2004).

All the data have been processed with the standard CALACS pipeline. The analysis was carried out on the geometrically corrected files. Aperture photometry has been performed on the reduced dataset as described in § 4.2.

In order to calculate precisely the total flux of the standard stars and check simultaneously the stability of the photometric performance of the camera we chose to perform aperture photometry in all frames from all epochs in a radius smaller than the “infinite” aperture ($5''.5$). We selected an aperture of $1''$ radius (20 pixels for WFC, 40 for HRC). This aperture is large enough to be fairly independent of changes in the PSF core with focus and position on the chip, and to include most of the flux, yet not so large that errors are dominated by the background. The observed count rates in the $1''$ radius aperture were converted to an “infinite” aperture by applying the aperture correction calculated from the mean EE profiles.

This analysis has also permitted a first check on the stability of the photometry with time. Since launch the ACS has proved to be an extremely stable and repeatable instrument. In the selected aperture radius the stability is better than 0.4% for the WFC and better than 0.5% for the HRC. The larger scatter in the HRC is limited in the UV where the image quality is very sensitive to focus changes especially in the PSF core. No significant throughput variations are observed in the UV (Boffi et al. 2004).

The observed count rates were compared with the ones predicted using the currently available sensitivity curves of the HST+ACS system, so that the latter could be updated. Given the photometric stability of the instrument, and in order to reduce the statistical uncertainties associated with the measurement process, all the data for the same combination of detector and filter were averaged together. We also averaged the results of WFC-1 and WFC-2 because the variations between the two are consistent with the temporal variation of the count rate in each chip. We therefore use the standard deviation of the various epochs/chips as a measure of the observational uncertainty.

Although it is not possible to independently measure corrections for any of the sensitivity curves, we decided to hold fixed the mirror reflectivity and window transmission curves and apply any correction to the detector responsivity quantum efficiency (RQE) or filter throughput. We assumed the wavelength dependence of each filter’s throughput curves to be as measured on the ground and allowed for an overall scaling factor for each filter. Since the same wavelength range is often covered by more than one filter, it was necessary to simultaneously compare observed and predicted count rates over the whole wavelength domain and derive incremental sensitivity updates to be applied simultaneously to all modes. However, since the filters are shared between the two cameras, these scaling factors have been taken as the average of the two corrections (see De Marchi et al. 2004). Finally, although we decided to apply all the large scale corrections to the RQE curves, even if not just detector-related, we required the solution to be smooth, without bumps and wiggles. This procedure has been repeated iteratively until convergence. The derived RQE curves (Fig. 12) can now reproduce the count rates in broad band filters with an accuracy better than 0.5%. The new RQE curves and the corrected filter curves were implemented in the ACS pipeline on December 10, 2003. The new files can be downloaded at the STScI/ACS reference files Web page and were included in the last release of STSDAS.

7. ZEROPOINTS

The photometric system based on the ACS filters is, by definition, the natural photometric system of ACS. The knowledge of the response of the instrument allows us to define a synthetic system. Synthetic photometry refers to magnitudes and fluxes computed from a spectral energy flux distribution and the response function of a photometric system. The approach taken here deals with the determination of the absolute flux scale of the ACS, as opposed to a conversion from ACS to standard filters. The transformation between ACS and other photometric systems is discussed in §8.

If $P(\lambda)$ is the dimensionless passband transmission curve in the interval $[\lambda_1, \lambda_2]$, the apparent magnitude of an object with energy flux distribution $f_\lambda(\lambda)$ is

$$m_P = -2.5 \log \frac{\int_{\lambda_1}^{\lambda_2} \lambda f_\lambda P(\lambda) d\lambda}{\int_{\lambda_1}^{\lambda_2} \lambda f_\lambda^* P(\lambda) d\lambda} + m_P^* \quad (3)$$

where m_P^* is a known apparent magnitude from a reference spectrum f_λ^* . f_λ^* and m_P^* completely define the zero-point of a synthetic photometric system⁵.

Several different photometric systems can be defined for the same instrument. For example, the photometric systems based on the WFPC2 filters are the WFPC2 flight system and the synthetic system. The WFPC2 flight system (Holtzman et al. 1995a) is defined so that stars of zero color in the Landolt UB-VRI system have color zero between any pair of WFPC2 filters, and have the same magnitude in V and WFPC2/F555W. In the synthetic photometric system, the zeropoints were determined so that the magnitude of Vega, when observed through the appropriate WFCP2 filters would be identical in the closest equivalent filters in the Johnson-Cousins system. This system was later implemented in the STSDAS SYNPHOT package as the VEGAMAG system where the zeropoints are defined by the magnitude of Vega being exactly zero in all filters. The VEGAMAG system, although also related to the absolute flux scale, is designed to resemble closely the standard Johnson-Cousins system.

For the ACS, we present three different versions of a synthetic photometric system. The first one is the VEGAMAG system, the analog of the WFPC2 synthetic system implemented in SYNPHOT and the standard-based system. The other two, STMAG and ABMAG, are flux-based systems. Their zeropoints are defined in terms of a reference flux in physical units rather than the flux of Vega. These two flux-based systems define an *equivalent flux density* for a source, corresponding to the flux density of a source of predefined spectral shape that would produce the observed count rate. The equivalent flux is then converted into a magnitude with the use of a constant chosen such that the magnitude in the V band corresponds roughly to that in the Johnson system. The advantage of the ABMAG and STMAG magnitude systems is that the magnitude is directly related to physical units, and they are therefore much simpler and cleaner. The basic equation in their definition is the *mean flux density* per unit wavelength, f_λ (STMAG), or per unit frequency, f_ν (ABMAG). The choice between flux-based and standard-based system is mostly a matter of personal preference.

The zeropoint of an instrument, by definition, is the magnitude of an object that produces one count per second. We use this definition and SYNPHOT to calculate the zeropoints in this paper. Any zeropoint must refer to a count rate measured in a specific way. In this paper they refer to a nominal “infinite” aperture of 5''5 radius. Independently of the different definitions, the magnitude in the bandpass P in any of the ACS systems is given by:

$$ACSmag(P) = -2.5 \log (\text{total count rate} [e^-/s]) + Zpt(P) = OBMAG(P) + Zpt(p) \quad (4)$$

and the choice of the zeropoint $Zpt(P)$ determines the photometric system of ACSmag.

⁵The energy flux distribution f_λ in equation 3 is multiplied by λ/hc in order to convert it into photon flux distribution as appropriate for a photon-counting detector.

7.1. VEGAMAG Magnitude System

The VEGAMAG system makes use of Vega (α Lyr) as the standard star. Calibrated empirical spectra are available covering the wavelength range from 3300 Å to 1.05 μm (Hayes 1985). Bohlin et al. (1990) have extended this spectral coverage down to 1150 Å using IUE spectra. Since its initial release, SYNPHOT adopted as reference the synthetic spectrum of Vega computed by Kurucz (1993) models with a normalization at $V = +0.034$ mag, assuming 3670 Jy for $V=0$. Composite spectra of Vega have been constructed by assembling empirical and synthetic spectra (e.g. Colina et al. 1996). The most recent absolute calibration of Vega from the far-UV to the IR is a composite spectrum with IUE data from 1140 to 1700 Å and HST/STIS from 1700 Å to 4200 Å (Bohlin & Gilliland 2004). Longward of 4200 Å the Kurucz (2003) model of Vega is used. The normalization has been done to the observed flux level of $3.46 \times 10^{-9} \text{ erg cm}^{-2} \text{ s}^{-1} \text{ Å}^{-1}$ at 5556 Å, corresponding to $V=0.026$. Since this new spectrum has been adopted as the Vega reference spectrum in SYNPHOT, we decided to use it to calculate the zeropoints for the ACS VEGAMAG system.

In the VEGAMAG system, by definition, Vega has magnitude 0 in all filters. Since the zeropoints in all VEGAMAG systems are tied to the observed Vega fluxes, their synthetic absolute magnitude may have systematic errors (probably up to 2%). Smaller errors, however, are expected in the colors. The values of the VEGAMAG_Zpt(P) are listed in Tables 10 and 11 for both the WFC and HRC filters.

7.2. STMAG Magnitude System

The STMAG magnitude system (Koorneef et al. 1986) is based on the definition of mean flux density per unit wavelength as:

$$f_{\lambda}(P) \equiv \frac{\int f_{\lambda} P(\lambda) \lambda d\lambda}{\int P(\lambda) \lambda d\lambda} \quad (5)$$

and the selection of a flat reference spectrum in f_{λ} . f_{λ} is expressed in $\text{erg s}^{-1} \text{ cm}^{-2} \text{ Å}^{-1}$. The magnitudes in the STMAG system are given by

$$STMAG(P) = -2.5 \log(f_{\lambda}(P)) + K \quad (6)$$

The zeropoint K is defined by setting the magnitude of a source that has a flux density of $1 \text{ erg s}^{-1} \text{ cm}^{-2} \text{ Å}^{-1}$ to -21.10. Another way to express this zeropoint is to say that an object with a flux density of $3.631 \times 10^{-9} \text{ erg cm}^{-2} \text{ s}^{-1} \text{ Å}^{-1}$ will have magnitude $Stag = 0$ in every filter.

Historically, the spectral flux density per unit wavelength that would generate 1 count/sec (within the nominal infinite aperture defined above) is stored in HST image headers as the keyword entry PHOTFLAM. Calling PHOTFLAM(P) the value of PHOTFLAM for the passband P, then to convert directly count rates to average flux density:

$$f_{\lambda}(P) = PHOTFLAM(P) \times (\text{count rate}).$$

where the count rate is in $e^{-} \text{ s}^{-1}$. The value of PHOTFLAM(P) can be derived directly by the passband function $P(\lambda)$:

$$PHOTFLAM(P) = \frac{hc/A}{\int P(\lambda) \lambda d\lambda}$$

where A is the telescope collecting area in square centimeters. We listed the value of PHOTFLAM(P) for all ACS filters in Tables 1 and 2. These values are also reported in the photometry keyword section in the header of the SCI extension of the calibrated ACS FITS file.

Thus, following the standard definition of any zeropoint, the STMAG zeropoint is:

$$STMAG_Zpt(P) = -2.5 \log (PHOTFLAM(P)) - 21.10$$

and the STMAG is therefore defined as:

$$\begin{aligned} STMAG(P) &= -2.5 \log (f_\lambda(P)) - 21.10 \\ &= -2.5 \log (totalcounts \times s^{-1}) + STMAG_Zpt(P) \end{aligned} \quad (7)$$

The $STMAG_Zpt(P)$ are listed in Tables 10 and 11 for both WFC and HRC filters.

7.3. ABMAG Magnitude System

The ABMAG magnitude system is the analog of STMAG for a constant flux density per unit frequency f_ν (Oke 1964). The reference spectrum is flat in f_ν expressed in $erg\ s^{-1}\ cm^{-2}\ Hz^{-1}$. The magnitudes in the ABMAG system are given by

$$ABMAG(P) = -2.5 \log (f_\nu(P)) - 48.60 \quad (8)$$

The constant is chosen so that ABMAG matches the Johnson V magnitude for an object with a flat spectrum. Another way to express this zeropoint is to say that an object with a flux density of $3.631 \times 10^{-20}\ erg\ cm^{-2}\ s^{-1}\ Hz^{-1}$ will have magnitude ABMAG = 0 in every filter. There is a simple relation between the STMAG and the ABMAG due to their own definition ($f_\lambda = f_\nu\ c/\lambda^2$) and the pivot wavelength definition:

$$\lambda_p(P) \equiv \sqrt{\frac{c\ f_\nu(P)}{f_\lambda(P)}} = \sqrt{\frac{\int P(\lambda)\lambda d\lambda}{\int P(\lambda)d\lambda/\lambda}}$$

. Thus, STMAG can be converted into ABMAG as:

$$ABMAG(P) = STMAG(P) - 5 \log \lambda_p(P) + 18.6921 \quad (9)$$

where λ_p is in Å. This can also be rewritten as

$$ABMAG(P) = STMAG(P) - 5 \log (\lambda_p(P)/5475.4) \quad (10)$$

therefore the two flux-based systems will give the same magnitude at $\lambda = 5475.4\ \text{Å}$. This transformation provides an easy way to calculate the zeropoints in the ABMAG system starting from PHOTFLAM(P):

$$ABMAG_Zpt(P) = -2.5 \log (PHOTFLAM(P)) - 21.10 - 5 \log \lambda_p(P) + 18.6921$$

Eq. 10 can therefore be rewritten as:

$$ABMAG(P) = -2.5 \log (totalcounts \times s^{-1}) + ABMAG_Zpt(P) \quad (11)$$

ACS $ABMAG_Zpt(P)$ are listed in Tables 10 and 11 for both WFC and HRC filters.

8. PHOTOMETRIC TRANSFORMATIONS

Since the ACS filters do not have exact counterparts in any other “standard” filter set, we strongly recommend that ACS photometric results be referred to a system based on its own filters. Sensitivity curves can be used to translate physical quantities from stellar models, such as surface luminosity and effective temperature T_{eff} , into the ACS observational plane. This conversion is done by means of a bolometric correction and T_{eff} -color relations. For example Girardi et al. (2002) have published theoretical bolometric corrections and color transformations for any broad-band photometric system and have converted several sets of Padova isochrones into the ACS photometric system (Girardi 2003, private communication). Bedin et al. (2004) transformed the entire set of evolutionary models by Pietrinferni et al. (2004) into the WFC observational photometric system. The total throughput curves of the ACS cameras⁶ can be implemented in the isochrone synthesis code of Bruzual & Charlot (2003) to compute the spectral evolution of stellar populations directly in the ACS observational plane.

Transformation between even nominally similar photometric systems presents difficult and poorly-understood problems (Young 1993). Manfroid & Sterken (1992) identify two kinds of error associated with the transformations: *Conformity errors* that arise from the fact that passbands in two systems are different, and there is no rigorous way to evaluate the corrections needed to properly transform data from one system to another, and *reduction errors*, caused by wrong values in the estimated transformation coefficients due to inevitable measurement errors.

In the traditional empirical approach the difference between a magnitude in the natural system and the “standard” system is plotted against a convenient color index, and the fit is performed using a straight line or a low-order polynomial. This approach has numerous problems. It requires many accurate observations of standard stars, which might not be feasible (for example in the case of HST). Moreover the validity of the obtained transformations will always be limited to an homogeneous group of stars. Different fitting-functions are required for reddened stars, for metal-poor (or metal-rich) stars, and for such effects as age, rotation, magnetic field, etc. Furthermore, in order to increase the throughput at the central wavelength and make the entire system more efficient, modern filter transmission curves are steep-sided and ripple-topped (see for example the comparison between ACS and UBVR filters or even between ACS and WFPC2 in Figs. 13). This adds enormously to the complexity of the color-transformation problems (Sterken & Manfroid, 1992), because the transformations become even more sensitive to spectral features.

A photometric transformation theory has been developed in the last thirty years trying to find a mathematical relation between integrals involving various functions, such as the spectral response of the instrument, and the spectral distribution of stellar flux (Young, 1992a, 1992b, Sterken & Manfroid, 1992, Young, 1994). Although these methods have been very useful in identifying several causes of conformity errors, they have shown that an exact solution is not possible for the existing photometric systems. It is, however, important to note some of their conclusions. Although high-order terms are usually absent from low-order empirical transformations, they are responsible for significant systematic errors (Young, 1992a). These high-order terms are not linear functions of a color index, but involve both higher power and cross products of color, curvature and derivative-like indices. Those terms are different for objects with different spectra. To accurately estimate the high order terms a better sampling of the wavelength space is required, with overlapping bands. Two ideal systems are exactly transformable if the passbands of one are linear combinations of the passbands of the other, i.e. bandpasses need to overlap with each filter peak close to the steepest slope of

⁶available at <http://acs.pha.jhu.edu/instrument/photometry/>

the neighbors (Young 1992a). All existing photometric systems, including the ACS, are undersampled and consequently non-transformable.

Finally, the errors that arise from the use of any color transformation for stars having color indices that fall outside the range of stars used to derive the transformations have been discussed by Manfroid et al. (1992). These authors show the inherent difficulty of peculiar objects such as Wolf-Rayet stars, luminous blue variables, cataclysmic variables, supernovae and quasars.

Although some of the passbands of ACS will eventually establish a standard in their own right, the scientific community, at least initially, will sometimes require the comparison of observations obtained through ACS passbands with those obtained in other systems. In the following pages we provide the coefficients to translate ACS photometry to other well known photometric systems. They should be used with extreme caution. Internal consistency between the WFC and HRC photometry is granted by the provided transformation between the two systems. We also provide conversion from ACS to WFPC2 and from ACS to the Landolt UBVRI photometric system. ACS has also a subset of the SDSS filters; the conversion to this system will be presented in a separate paper.

In general, transformations between two different photometric systems rely upon the spectral energy distribution of the targeted objects as well as the absolute response function of the instruments. There are two routes to establishing the transformations. One approach is to make direct use of observations of the same object (typically stars in well-studied globular clusters) in the two systems. In principle, this straightforward determination is believed to provide an unbiased approximation to the real shape of the transformation curve (for the selected stars) and can be directly used without any knowledge of the instrumental throughputs. However, because of the limited HST time that can be allocated to calibration programs, the current database of ACS observations is still insufficient to produce transformations that are valid over a large color range. In the future, this deficiency will be remedied as more and more ACS data become public.

The other method is to deduce transformation curves based on synthetic photometry. This method takes advantage of the well-established response curves of the ACS and the BPGS catalog of stellar spectra. The transformations obtained in this way can span much wider color ranges, but their accuracy is, of course, limited by the fidelity of the ACS throughput curves and the quality of the spectra in the atlas. In this paper, we present the results from both approaches and show that in most cases the transformations using these two approaches are consistent with each other. Therefore, synthetic transformations based on larger color range can be safely employed and should be considered the norm, unless otherwise indicated.

Although the current WFC and HRC throughput curves can predict the observed count rates of the spectrophotometric standard stars with an accuracy of $\sim 1\%$, strictly speaking they are valid for the specific stellar properties of the standard star used. When the transformation coefficients presented in this paper are employed, account must be taken of the different spectral shapes (e.g. due to surface gravity, metallicity, extinction, redshift, etc.) of the targets under investigation. Passband differences may not be evident from the photometry of the object used to derive the transformations. If these transformations are used for bluer or redder objects, for objects with different gravities or for any object not well represented by the targets used to derive the transformations, then systematic magnitude differences are possible (see also Bessel 1990, Holtzman et al. 1995a).

8.1. General Notes

In the following sections we define *SOURCE* (S) as the photometric system of the observed data that we want to transform, and *TARGET* (T) as the photometric system after the transformation. Following this definition SMAG is the magnitude in the SOURCE system, and TMAG and TCOL are the magnitude and color in the TARGET system. Since several photometric systems can be defined for each instrument, we need to clarify the default magnitude system used in the following transformations. In order to minimize the possible confusion and reduce the redundancy among different zeropoints, we only provide OB-MAG-to-OB-MAG (see Eq. 1) transformations, except for the transformation to the Landolt photometric system. The OB-MAG-to-OB-MAG transformations can be used to convert magnitudes to any photometric system by simply subtracting (adding) the corresponding zeropoints before (after) the transformation. We present an example in § D.1.

The transformations have the following format:

$$TMAG = SMAG + c0 + c1 \times TCOL + c2 \times TCOL^2 \quad (12)$$

where SMAG is the OB-MAG in the source system and TMAG and TCOL are the OB-MAG magnitude and color (as difference of two OB-MAGs) in the target system, and $c0$, $c1$, and $c2$ are the coefficients for the transformation. Please note that in the transformation equation the color term is in the TARGET system and not in the SOURCE system. The same approach was used by Holtzman et al. (1995a) for the transformations from WFCP2 to UBVRI because this formalism carries several advantages as discussed by Stetson (1992). Consequently TCOL must be derived iteratively using ACS observations in two colors unless the target color is known.

The number of objects used for the observational transformations varies greatly depending on the area of the FOV, the photometric quality of the data and the brightness of the stars. Photometric errors have been used as initial criteria to select stars for the transformations. Depending on the numbers of stars available, the error threshold was set between 0.02 and 0.06 mag. We divided the color range in equally sized bins and calculated the median and standard deviation for each bin. Outliers have been rejected based on the local median and standard deviation, using a σ -clipping criterion. In transformation plots where observed stars are used, we show only representative points which are just local medians in any given color bin.

To estimate the uncertainties of the transformation parameters, we followed the approach employed by Holtzman et al. (1995a). For transformations derived from the observational data, we weighted stars equally and iterated the χ^2 minimization by adjusting the magnitude errors until χ^2 reached unity. In order to avoid over-estimation of the uncertainty of synthetic stars, we measured the scatter from the fit and used this as a weight for the χ^2 minimization. This procedure not only prevents the fit from being partially weighted by a few bright stars, but also provides realistic errors which are not modeled by synthetic photometry.

In deriving the transformation between two photometric systems the functional form of the transformation should be addressed. Although in principle, a quadratic least-square fit is preferable, we found that for observational transformations, given the limited color range and limited statistics, a linear fit was more appropriate. In the case of observational transformations between the CCD cameras of the ACS that use the same filters we also decided to perform a linear least-squares fitting with iterative rejection. For all synthetic transformations we performed a quadratic least-squares fitting.

A single set of coefficients does not always fit the data over the large color range of the stellar atlas. Sudden differences in the response curves can produce discontinuities in the color term dependencies and force us to limit the color range for which a set of coefficients can be used. When this happens, we divide

the color range into two regions and provide separate coefficients for each segment.

Finally, the precision of the synthetic transformations depends on the accuracy of the total response function of the photometric passbands of ACS. As we discussed in §6, a fairly significant revision of the pre-launch RQE has been necessary in order to reproduce the observed on-orbit sensitivity. Although the derived RQE curves can now reproduce the count rates in all broad band filters with an accuracy better than 0.5%, it is possible that the shape of the total response of the bluest and reddest passbands is not a perfect representation of the real response curve. This could introduce systematic errors in the color transformations. In these cases (F435W and F850LP for the WFC, and F220W and F850LP for the HRC), we suggest to use the observed transformations, if available.

8.2. ACS Internal Transformations

The WFC and the HRC share all the visual and near-IR filters of the ACS. The transformation between the two systems is therefore expected to be quite simple. However the different optimization of the cameras (mirrors and CCDs) produces different total throughput curves in particular in the blue and near-IR (Fig. 13). Therefore the transformation between filters in these wavelength regions could have a significant dependence on the color term.

For these “internal” transformations between the two CCD cameras we used observations of two globular clusters, NGC 104 (Programs 9018,9656,9666) and NGC 2419 (Program 9666). These globular clusters have very different metallicities ($[\text{Fe}/\text{H}] \sim -0.7$ for NGC 104 and $[\text{Fe}/\text{H}] \sim -2.2$ for NGC 2419), essentially spanning the whole metallicity distribution of the Galactic globular cluster system.

The raw data have been processed through the CALACS pipeline at the STScI. For moderately crowded fields ($\sim 6'$ west of the core) of NGC 104, we simply performed 5-pixel radius aperture photometry using the IRAF/APPHOT package. Because the NGC 104 data were originally acquired for the assessment of the geometric distortion and low frequency residuals in the flat field, each filter observation consists of multiple pointings offsets by large dithers. We decided to select only stars present in at least three pointings and to use the sigma-clipped averages of the magnitude in the multiple observations as an estimate of the brightness of the star.

The photometry of NGC 2419 required more complicated field-dependent handling. Due to the larger distance of the cluster a single pointing of WFC covers both the compact core and the moderately crowded outer regions. In the external regions of NGC 2419 we can safely perform 5-pixel radius aperture photometry. However, PSF-fitting photometry is required for the crowded region of NGC 2419 common to the HRC and WFC. While the PSF of the HRC can be assumed to be nearly constant across the field, the PSF varies significantly across the WFC FOV (see §4.2), thus preventing us from applying in the crowded area the PSF extracted from isolated stars in the external regions. We confirmed this fact by performing our initial PSF photometry assuming a spatially constant PSF and the result showed systematic errors up to $\sim 4\%$. Although in principle a PSF can be iteratively constructed even for an extremely crowded field, the task to achieve calibration-quality photometry becomes prohibitively impractical if not impossible. An alternative is to use TinyTim (Krist 2003c) to model the PSF on the crowded area. However, it is difficult to determine the time-varying behavior of the PSF, mainly due to focus offset changes. Besides, most PSF photometry packages cannot readily make use of PSF images from Tiny Tim. We therefore decided to create position-dependent PSF templates using the sparser observations of NGC 104. The PSFs were easily sampled from isolated stars over the entire field of view and then applied to the NGC 2419 field. In order to avoid effects

due to PSF time variations, when possible, we used the NGC 104 images which were closest to the date of the NGC 2419 observations. After checking the residuals in PSF-subtracted images as well as various goodness-of-fit criteria, such as χ^2 , best-matching PSF templates were determined for each filter. This technique allowed us to remove any systematic effect on the photometry of the crowded regions.

Examining the NGC 104 and NGC 2419 data separately, one does not see strong evidence for a metallicity dependence in the transformation relations. Due to the different metallicities and distance moduli of the two clusters ((m-M)=13.27 for NGC 104 (Zoccali et al. 2001) and (m-M)=19.88 for NGC 2419 (Harris et al. 1997)) the range of colors that our selection criteria allow are not the same in both clusters. In particular, for NGC 2419 we used stars on the horizontal branch, the asymptotic giant branch and on the red and sub-giant branches. The NGC 104 data allow an extension to the red since we can use main sequence stars at least 4 magnitudes fainter than the turn-off point.

Fig. 14 shows the observed color-magnitude diagrams for the two clusters for the WFC and HRC. In order to look for metallicity effects, we must compare stars of similar colors in the two clusters. In most transformations, the data of the two clusters overlap only in a quite narrow color range spanning ≤ 0.6 magnitudes. We therefore used the model atmospheres of Kurucz (1993) to investigate the metallicity dependency. We compared synthetic transformations using three different metallicities, $[\text{Fe}/\text{H}] = 0$, $[\text{Fe}/\text{H}] = -0.5$ and $[\text{Fe}/\text{H}] = -2.0$ and find that in the color range covered by the observational data, the systematic differences between the three metallicities are at most 0.3%. We therefore decided to combine the data for both clusters and also include the observations of the two spectrophotometric standards to determine the final transformations.

Even when combining all the observational data, the color range covered by all the stars (WDs + NGC2419 + NGC 104) were generally limited to $0.0 < F435W - F555W < 1.2$ or $-0.4 < F555W - F814W < 1.2$ in the HRC VEGAMAG system; the transformation from observed stars cannot be assumed to be corrected for stars outside this color range. Synthetic transformations cover a larger color range and should be used instead.

We list the transformation coefficients to use in Eq. 12 for different combinations of most of the full-sized filters in Tables 12 and 13 for the transformations from WFC to HRC and from HRC to WFC, respectively. The transformations between the primary filters from WFC to HRC are shown in Figs. 15.

These figures show that the synthetic system matches the observations fairly well, usually within 1% for all stars within the range of colors in which our observations were made. There are however a few cases, F435W and F625W for example, where the discrepancy can rise up to a couple of percent for the reddest stars. In principle, one could argue that since the long wavelength light scattering is more severe in the HRC than in the WFC an incorrect aperture correction could be the reason for this discrepancy. However, this is not the case, because these filters are not affected by this problem, which starts at $\lambda > 7000 \text{ \AA}$. Also, the near-IR filters, which suffer from extended PSF wings, and therefore could be more affected by aperture correction errors, do not show any systematic differences.

Although the BPGS atlas does not include stars with high surface gravities, but only main-sequence stars and giants, the agreement with the two spectrophotometric white dwarfs does not show any systematics. This analysis suggests that we have a good understanding of the ACS synthetic system and that the derived transformations are accurate to 1-2% or better in all filters. The synthetic curves can thus be used in place of the observational ones to produce transformations for objects with spectra different from the observed stars.

8.3. Transformations from ACS to UBVRI

ACS filters differ significantly from the UBVRI bandpasses. The ACS filters are usually narrower, start at shorter wavelengths and, apart from F814W, extend less to the red (see Fig. 13). As a consequence the transformations between the two systems may be very sensitive to details in the underlying stellar spectrum and show strong dependencies on metallicity and surface gravity.

We compared ACS observations with ground-based photometry of NGC 2419. In particular, we retrieved BVRI data from Stetson (2002) and an independent BVRI dataset was provided by Saha et al. (2005). The two NGC 2419 photometric control datasets are the same recently used to examine the accuracy of the WFPC2 zeropoints (Heyer et al. 2002, 2004). The two observational CMDs from the two different sources are shown in Fig. 20. In order to have a large number of common stars in the HRC and WFC FOV, ACS observations were centered in a region fairly close to the center of NGC 2419. As a consequence, the match with ground observations - centered in a more sparse region - resulted in only 30 to 60 stars depending on the filter and camera.

We compared the two NGC 2419 control datasets and find a significant color term between them: red stars tend to be brighter in Stetson (2002) than in Saha et al. (2005) with differences up to 3-4% for stars with $V-I > 1.0$ in the I band. Such differences, also discussed in Saha et al. (2005), could be due to different filter throughput curves, red-leak control and systematic effects in the transformation from the instrumental system to the standard system for the low surface gravity stars in NGC 2419.

For the synthetic UBVRI photometry we first used the Landolt UBVRI filter set (i.e., Johnson UBV + Cousins RI) defined in SYNPHOT. In particular the throughput data for the Johnson UBV bands are the U3, B2 and V synthetic bandpass data of Buser & Kurucz (1978), while the Cousins R and I throughputs are taken from Bessel (1983). However we got poor agreement with the observed transformation using the B2 filter. We then tried using other B synthetic bandpasses and found a much better agreement when using the B filter from the Harris set in use at KPNO and WIYN⁷.

For both ACS cameras, we compared the observed transformations using the two NGC 2419 control datasets with the corresponding synthetic transformations. We obtained poor agreement with the I bands of Stetson’s dataset with systematic offsets of the order of a few percent between the two curves. The observed R-band transformation also shows some departures for the reddest stars. Finally the V band shows a good match between observed and synthetic transformations. Using Saha’s dataset we have significantly better results in V, R and I available bands. The B band show a similar agreement using either Stetson’s or Saha’s dataset. The observed and synthetic transformation provide similar results for stars with $B-V > 0.5$, whereas for bluer stars the discrepancy between the two transformation can be as high as 5%. Given the possible uncertainties in the shape of the blue side of the total response curve with the F435W filter, our bluest filter with WFC, we suggest to use the observed transformations when this filter is involved.

We decided to use only the Saha photometric dataset of NGC 2419 to calculate the coefficients for the observational transformations. However, in determining the new zeropoints for WFPC2, Heyer et al.(2002), find that Stetson’s photometry produces values slightly closer to the historical zeropoints of WFPC2 than Saha’s photometry. Unfortunately, no color term was taken into account.

We list the observational and synthetic transformation coefficients to use in Eq. 12 for different combinations of most filters in Tables 18 and 19 for WFC-to-BVRI and HRC-to-UBVRI, respectively. The

⁷The curves used for the synthetic UBVRI are available at <http://acs.pha.jhu.edu/instrument/photometry/>

transformations between primary filters are shown in Figs. 21 and 22. An example on how to calculate the transformation is provided in D.1

As expected, Figs. 21 and 22 show large scatter in the synthetic transformation. The BPGS atlas includes stars with a wide range of surface gravity and possibly metallicity. We used the synthetic system to investigate dependencies of the main transformations on gravity and metallicity. For the gravity we use the Bruzual Spectrum Synthesis Atlas (BZ77) implemented in SYNPHOT. It provides solar metallicity spectra for main-sequence stars (from spectral class O5 to M6), giant stars (from O8 to M6) and supergiants (from O9 to M1). For the metallicity dependence we use the model atmosphere of Kurucz (1993). We selected models to cover the main sequence from O3 to M2 for the solar metallicity, and for $[\text{Fe}/\text{H}] = +0.5, -1.0$ and -2.0 . The results are shown in Figs. 23 and 24 for the WFC and HRC, respectively. In both figures the column on the left shows the dependence on the surface gravity; filled circles represent data for a synthetic main-sequence. The sequences of giant and supergiant stars are represented with gray stars and boxes, respectively. The column on the right shows the dependence on the metallicity for main sequence stars: black dots show the solar metallicity, filled triangles are $[\text{Fe}/\text{H}] = 0.5$, gray-filled stars are $[\text{Fe}/\text{H}] = -1$ and squares are $[\text{Fe}/\text{H}] = -2$.

These figures show that the dependency of the transformations on these quantities can be quite large. Gravity provides a large spread in short and long wavelength filters for stars around zero color and for low temperature stars. Metallicity causes more spread for redder stars. Significant departures from the relation derived from stellar spectra are expected for the transformation of non-stellar objects, especially for galaxies at high redshift.

The derived transformations from the ACS systems to UBVRI can be applied to main-sequence and giant stars without introducing errors of more than a few percent. However, it should not be expected that the 1-2% accuracy of ACS photometry will be preserved on the transformed data. Transformation to U, B and I filters are highly dependent on the object spectral details and Tables 18 and 19 should be used with extreme caution for objects different from those used to derive the relations. Therefore, whenever possible, we strongly recommend working with the ACS system.

8.4. Transformations from ACS to WFPC2

Most ACS broad-band filters have, at least nominally, a close match in the vast WFPC2 filter complement. However, the different response of the two instruments and specific filter designs create significant differences between the ACS and WFPC2, as shown in Fig. 13.

Since the installation of WFPC2 on HST a decade ago, a large amount of WFPC2 data have become public and therefore available through the HST archives for calibration purposes. Now many characteristics of the instrument are well understood, although the refinement is still in progress (Baggett et al. 2001; Casertano & Wiggs 2001; Whitmore & Heyer 2002; Dolphin 2002a).

In order to derive transformations between ACS and WFPC2, we retrieved WFPC2 observations of NGC 104 (programs 7465,6114,6660,6114) and NGC 2419 (programs 7268,7630,9601) from the STScI archive. Accurate stellar photometry on WFPC2 images requires a careful treatment of the undersampling effect, of position-dependent pixel size variations, and of the charge transfer efficiency (CTE) degradation. We found HSTPHOT, an automatic stellar photometry software specifically designed for WFPC2 data (Dolphin 2000b), to account for all these issues with acceptable accuracy. The dependability of the package was tested

by first performing PSF-fitting photometry with IRAF DAOPHOT on a subsample of the data, applying aperture corrections measured from isolated stars in the same images, and CTE correction from Dolphin (2002a) and comparing the results with HSTPHOT results. Since the results from these two methods did not show any systematic difference, we decided to use HSTPHOT to automatically process all the WFPC2 observations.

The detailed description and usage of HSTPHOT can be found at <http://www.noao.edu/staff/dolphin/hstphot/>. We used the “multiphot” photometry feature of HSTPHOT instead of performing photometry on combined images. This method, although reducing the detectability of faint stars, increased the photometric accuracy for the bright stars that we used to estimate the transformation coefficients. Finally, the HSTPHOT output flight system magnitudes were converted into OBMags by subtracting flight system zeropoints (Dolphin 2000b). Fig. 25 shows the observed color magnitude diagram for the two clusters.

There is a subtlety involved in the determination of OBMAG in the WFPC2 photometric system, because WFPC2 zeropoints are slightly different depending on the chip. We choose the WF3 chip as a basis for our OBMAG definition. For the synthetic transformation, we used the sensitivity curves for all WFPC2/WF3 components currently available in SYNPHOT (Bagget et al. 1997).

We list the observational and synthetic transformation coefficients to use in Eq. 12 for different combinations of most filters in Tables 20 and 21 for WFC-to-WFPC2 and HRC-to-WFPC2 conversions, respectively. The appropriate WFPC2/WF3 zeropoints for gain = 15 must be added when transforming the WFPC2_OBMAG into any WFPC2 photometric system. The transformations between primary filters are shown in Figs. 26 and 27.

9. The HRC UV RED LEAK

We investigated the red leak of the UV filters of the HRC. When designing a UV filter, the high suppression of the red off-band transmission has to be traded with the in-band throughput. The elevated quantum efficiency of the HRC makes it possible to design UV filters with limited red leak. We defined all contributions from $\lambda > 4000 \text{ \AA}$, as red leak. In order to quantify the red-leak contribution as a function of the stellar color, we used the BPGS library of stellar spectra and the HRC throughput curves. Figure 16 shows the amount of light contributed by red leak as a function of color for the three filters. Clearly there is no red leak in F330W, but it becomes important in F250W and particularly in F220W. Accurate UV photometry in the F250W and F220W filters will require red-leak corrections for objects with a spectrum as red as that of an F5V star or colder and will be essentially impossible for objects with a spectrum later than M. In addition to the majority of the flux being off-band, the red photons will contribute to create an extended halo (see §4.3) which will superimpose on the sharper UV PSF.

10. REDDENING IN THE ACS SYSTEM

The ACS filters can differ significantly from the Johnson-Cousins UBVRI bandpasses (see §8.3), and these differences need to be taken into account when calculating reddening corrections. ACS magnitudes should be corrected with extinction coefficients calculated in the native photometric system. For the same reason, any reddening correction should be applied before transforming to any other photometric system. We calculated a grid of extinction coefficients for all ACS filters as a function of $E(B-V)$ up to $E(B-V)=5.5$. The

extinction was computed using the synthetic throughput curves in SYNPHOT and adopting the Galactic extinction law presented by Cardelli et al. (1989). For medium- and broad-band filters the extinction depends on the object’s color. We therefore selected three template stars (O5V, G2V, M0V) from the BPGS atlas and three galaxy templates (E, Sc, Im) from Benítez et al. (2004) and computed the extinction coefficient for the grid of $E(B-V)$ values. Fig. 17 shows the extinction in a few primary ACS filters as a function of $E(B-V)$ computed for three stars of different types. Tables 14 and 15 list the extinction $A(P)$ normalized to the photometric measurement of $E(B-V)=A(V)/3.1$ for all ACS filters using the interstellar extinction of Cardelli et al. (1989). Due to the difference in the filter transmission curves between the ground-based system and the ACS systems, there could be systematic differences in the extinction coefficients for the two systems. Fig. 18 shows that the extinction in F330W, F435W and F555W is systematically higher than in U, B and V because the effective wavelength in these ACS band is shorter than in the corresponding Johnson filters. On the contrary the extinction in F814W is systematically lower than in the I band because the effective wavelength in the F814W is longer than in I.

11. CONCLUSIONS

We have presented the current status and the photometric calibration of the two CCD channels of ACS. The overall performance is as expected from pre-launch testing of the instrument. A positive surprise was the discovery that the ground throughput prediction underestimated the overall sensitivity of the camera by a few percent in the red, up to $\sim 20\%$ in the blue for WFC and in the visual and the near-IR for HRC. HRC also showed an unpredicted dip in the UV response at $\sim 3200 \text{ \AA}$.

Initial signs of degradation due to the HST radiative environment are already visible in terms of dark rate increase, charge transfer efficiency degradation and growth of the permanent hot pixels population. The detailed effect of CTE losses as a function of brightness and background level is being determined with a continuous effort at STScI. The correction formula to be applied to photometric measurements is constantly kept up to date on the ACS web server at STScI.

The long wavelength light scattering in ACS CCDs has a twofold effect: the width of the PSF increases significantly in the near-IR filters and the aperture correction in the near-IR depends on the SED of the object. Recipes to calculate the aperture correction have been presented.

Photometric calibration data of spectrophotometric standard stars have been obtained for all ACS filters to provide transformation to physical fluxes. The HRC and the WFC synthetic photometric systems have been constructed and reproduce count rates of spectrophotometric standards to within 0.5% in all broadband filters. Zeropoints are provided in three different magnitude systems.

Transformations between HRC and WFC photometric systems are given. Although ground observation and synthetic photometry have been used for the determination of the transformation to UBVR and WFPC2 photometric systems, we strongly recommend that ACS photometric results be referred to a system based on its own filters. Synthetic photometry can be used to construct isochrones and to safely convert models into the ACS observational plane. In some instances a direct comparison with previous results in a different photometric system may still be needed. We warn the reader that transformations to UBVR and WFPC2 depend on details of the stellar spectra and should be used with caution. Generally, transformed data will be accurate within a few percent, but differences could be significantly larger for peculiar spectra. We also provide tables for the color transformation for a few galaxy templates as a function of the redshift.

The effective wavelength of the ACS filters can differ significantly from their counterparts in the WFPC2 and UBVRI systems. As a consequence, accurate reddening corrections must be made in the ACS system, before transforming the magnitude to other photometric systems. Extinction curves for the ACS filters for a standard interstellar reddening law have been presented for a sample of stellar and galaxy templates. Extinction for other reddening laws can be derived using the synthetic ACS system.

The process of understanding and calibrating ACS is ongoing. More calibration programs are currently planned and more data are being analyzed. ACS users are encouraged to stay posted for future reports from the STScI and to contact the ACS Instrument Scientists with questions (help@stsci.edu).

Many people have contributed to this work. ACS was engineered, built and tested by a dedicated team at Ball Aerospace, Boulder, CO. We thank the entire ACS Investigation Definition Team and all personnel at GSFC who have supported ground calibration and pre-launch testing. Special thanks to the entire crew of STS-109 who did a superb job during an extraordinarily demanding servicing mission.

Thanks to ACS personnel at STScI, the ACS photometric calibration group and the ACS science team. They have prepared many of the calibration proposals and were always available to discuss results. Among these people, we specially appreciate the comments and work we received from Ralph Bohlin, Francesca Boffi, Nick Cross, David Golimowski, Inge Heyer, John Krist, Adam Riess and Roeland van der Marel.

We are indebted to Abhijit Saha for providing unpublished magnitudes and data relating to the UBVRI system. We also thank Tom Brown, Stefano Casertano, Leo Girardi, Brad Whitmore and Manuela Zoccali for their useful suggestions and insightful discussion.

The entire paper has been modelled after equivalent WFPC2 calibration papers by John Holtzman and collaborators. We are indebted with them for setting a bench mark in comprehensive calibration paper making our job much easier.

MS is particularly grateful to the ACS IDT team and all personnel of the JHU Physics and Astronomy department for five years of pleasant and productive work. Finally, we are grateful to K. Anderson, S. Busching, A. Framarini, S. Barkhouser, and T. Allen for their invaluable contributions to the ACS project at JHU.

We have much appreciated the many useful suggestions and constructive criticism of Gordon Walker, the referee of this paper, whose valuable help has considerably improved the presentation of our work.

ACS was developed under NASA contract NAS 5-32865, and this research has been supported by NASA grant NAG5-7697 and by equipment grant from Sun Microsystems, Inc. The Space Telescope Science Institute is operated by AURA Inc., under NASA contract NAS 5-26555.

A. Acronyms

ACS	Advanced Camera for Surveys
ADHv4	ACS Data Handbook version 4.0
ADU	Analog-to-Digital Unit
AIHv5	ACS Instrument Handbook version 5.0
BPGS	Bruzual, Perrson, Gunn and Stryker stellar atlas
CALACS	CALibration pipeline for ACS data
CCD	Charge Coupled Device
CTE	Charge Transfer Efficiency
EE	Encircled Energy
FOV	Field Of View
FWHM	Full Width at Half Maximum
GSFC	Goddard Space Flight Center
HRC	High Resolution Channel
HST	Hubble Space Telescope
IR	Infra Red
MPP	Multi Pinned Phase
OTA	Optical Telescope Assembly
PSF	Point Spread Function
RQE	Responsive Quantum Efficiency
SED	Spectral Energy Distribution
SMOV	Servicing Mission Orbital Verification
STIS	Space Telescope Imaging Spectrograph
STScI	Space Telescope Science Institute
SBC	Solar Blind Channel
TinyTim	Program which produces simulated HST point spread functions
UV	Ultra Violet
WFC	Wide Field Channel
WFPC2	Wide Field and Planetary Camera 2

B. PHOTOMETRIC CALIBRATION COOKBOOK

Here we briefly summarize the steps required to perform photometry on an ACS image. See also ADHB03.

B.1. Point Source Photometry

1. Retrieve the image(s) from the HST archive or proceed with the manual recalibration of the data following the recipe given in ADHv4. Be sure to use the best reference files usually available a few weeks after the data acquisition.
2. After running CALACS on the association file the main output is the flat fielded corrected *FLT* image and/or the geometric corrected *DRZ* image.
 - If CR-SPLIT observations are available, the *FLT* images are combined to produce a *CRJ* frame free of cosmic rays. We draw the reader’s attention to the fact that the default settings for the CR rejection routine are quite conservative. If the images in the CR-SPLIT pair do not show any significant offset (< 0.05 pixel), the *scalenoise* parameter may be reduced a more efficient CR rejection (see §3.5). However, in the case of undersampled images, one should verify that the peak of the PSF is not affected (i.e. truncated) by a more “aggressive” CR-removal technique.
 - If instead the observation consisted of dithered images but without CR-SPLIT the resulting *FLT* images will still have cosmic rays which are removed during the combination of the dithered observations. *MultiDrizzle* performs a better CR-rejection on non CR-split observations than *PyDrizzle*.⁸
3. Perform photometry of objects in the field using any choice of photometry technique.
 - If work is carried out on the *FLT* image instead of the distortion corrected *DRZ* file, it is necessary to multiply each SCI (and ERR) frame of the *FLT* file by the appropriate pixel area map file (see §3.6). This operation will ensure that the total integrated flux of the star is conserved. We underline here that even after the application of the pixel area map, the PSF of the stars will be distorted and the amount of distortion is position dependent. The encircled energy profiles published in this paper were calculated from non-distorted PSFs. As a consequence the aperture correction that can be derived from the EE profile cannot be directly applied to non-drizzled images, at least for small radius apertures. The zeropoints published in this paper refer to an “infinite” aperture and can be used once the aperture correction to a “total” flux has been applied.
 - The units of the *FLT* and *DRZ* images are electrons and electrons/sec respectively. Many photometry packages for PSF fitting use an optimal weighting scheme which depends on the readout noise, gain and the true counts in the pixels. As a consequence, in order to compute the weights correctly, the image should not be divided by the exposure time. Therefore the *DRZ* image should be multiplied by the exposure time before running such packages. The total number of electrons, instead of the electron rate, is also needed in order to properly calculate the CTE correction. For the same reasons the background sky should not be subtracted from the image.

⁸Since September 2004 *MultiDrizzle* is part of CALACS. See ADHB03 for more information on running *MultiDrizzle* on ACS images

- When performing aperture or PSF fitting photometry, possible systematic errors due to the spatial variation of the PSF should be addressed. This is particularly important when the photometry is carried out using a small radius aperture (< 5 pixels). For very small aperture ($r < 2$ pixels) the systematic variations in aperture correction can be as high as 10-15%. An example of the analysis of the optimal aperture is provided in Appendix B.

This step should give you a set of measurements in units of electrons or electron/sec in your selected aperture for all your objects. The instrumental magnitude can be calculated as $-2.5 \times \log(\text{electrons} \times \text{s}^{-1})$.

4. Consider correcting the photometry for CTE degradation. Unless your data were acquired in the first semester of 2002, the effects of CTE degradation are probably present in your data. Check on the STScI ACS web page for updates on the CTE degradation correction. There are several things to keep in mind when calculating the correction for CTE degradation in your image:

- the flux level and the background level to use in the formula are in electrons and not electrons/second. When working with DRZ images it is necessary to multiply the measured value by the exposure time.
- when applying the CTE correction to combined images, each of the combined images must have the same or very similar exposure times. The output of CALACS, when CR-SPLIT or DRZ observations are available, is the sum of the combined images. In this case, if all the combined images have the same exposure time the measured values in the equation, such as SKY and FLUX should be divided by the number of images used to create the add-combine image. Determining the CTE correction for a combined image created with unequal exposure times (for example, one long exposure and one short exposure) cannot easily be done.
- In particular for WFC observations the FOV is big enough that the background sky might present gradients. In general, the use of a constant sky value for the determination of CTE correction in different regions of the FOV is not recommended. This is particularly true for all filters where the PSF wings are broadened by the long wavelength halo. Depending on the brightness of the star, the signal in the PSF wings can enhance the "local" sky and reduce the amount of lost signal within the aperture where the flux is measured. In such instances a global sky value would overestimate the CTE correction.

5. Apply the aperture correction to all photometric measurements to transform the instrumental magnitudes into OBMAG:

- (a) for filters bluer than F775W: determine the offset between your photometry and aperture photometry with a $0''.5$ radius aperture. This is usually done by measuring a few bright isolated objects in the field. Apply this offset to all the photometric measurements. Use Table 5 to get the value of AC05 for each filter. Add AC05 to the instrumental magnitude or insert the count rate at $r=0''.5$ and the value of AC05 in Eq. 2 to get OBMAG.
- (b) for all near-IR filters: if your object is a blue star proceed as in (a). For all other objects you need to estimate the impact of the *red halo*: first estimate the effective wavelength of the observation using the recipe in §4.5, SYNPHOT or Table 8. Then calculate the aperture correction from a $0''.5$ aperture radius to infinity using the relation in Figs. 9 and 10 and Tables 6 and 7 and compare the results with the values in Table 5. If the calculated aperture correction is similar, within a few tenths of a percent to the corresponding value in Table 5, then the red halo has little or no

impact in your observations and you should proceed as in case (a). If however the difference is larger, then you should use the relation in Figs. 9 and 10 and Tables 6 and 7 to directly calculate the aperture correction from your aperture radius to infinity.

6. Apply the appropriate zeropoint from Tables 10 and 11 to transform OB MAG to any choice of magnitude system.
7. If your observations were processed with CALACS before January 6, 2004 and the gain is different from the default setting (1 for WFC, 2 for HRC), use Table 9 to correct the photometry.
8. The magnitude can be corrected for interstellar extinction using Tables 14 and 15. Given $E(B-V)$, the extinction $A(P)$ in the passband P is calculated by multiplying $E(B-V)$ by the value in the table which correspond to the correct passband and spectral type.
9. If you want to transform the data to a different photometric system use Eq.12 with the coefficients in §8 which are appropriate for the source and target systems. You should apply the correction for interstellar extinction (see §10) before applying the transformations.

B.2. Resolved Object Photometry

1. Retrieve the image(s) from the HST archive or proceed with the manual recalibration of the data following the recipe given in ADHv4. Be sure to use the best reference files usually available a few weeks after the data acquisition.
2. After running CALACS on the association file the main output is the flat fielded corrected *FLT* image and/or the geometrically corrected *DRZ* image (see Point 2 in §B.1).
3. Perform photometry of objects in the field using any choice of photometry technique (see Point 3 in §B.1). This step should give you a set of measurements in units of electrons or electron/sec in your selected aperture for all your objects. The instrumental magnitude can be calculated as $-2.5 \times \log(\text{electrons} \times s^{-1})$
4. Consider correcting the photometry for CTE degradation. Unless your data were acquired in the first semester of 2002, due to the large amount of transfers, the effects of CTE degradation are probably present in your data. Check on the STScI ACS web page for updates on the CTE degradation correction (see Point 4 in §B.1).
5. Apply the aperture corrections to transform the instrumental magnitudes into OB MAG: these will of course be different in general for extended objects than for stars, so the corrections given in the tables should not be applied blindly. However, for barely resolved galaxies, the aperture corrections may be similar to the stellar ones if the apertures are at least several pixels in radius. If high accuracy is required, consider simulating galaxy profiles and convolving them with the PSFs of the appropriate bandpasses to determine the amount of light lost through the adopted aperture. If one is only interested in galaxy colors for a given aperture, and the PSFs of the two bandpasses are nearly identical, this step is unnecessary; however, for colors involving the near-IR filters, particularly F850LP, there will in general be more light lost through the redder filter. In this case, one can determine the size of the differential aperture correction for the two bands by convolving galaxy models with the respective PSFs or else deconvolving the images and measuring the color change for the given aperture.

6. Apply the appropriate zeropoint from Tables 10 and 11 to transform OB MAG to any choice of magnitude system.
7. If your observations were processed with CALACS before January 6, 2004, and the gain is different from the default setting (1 for WFC, 2 for HRC), use Table 9 to correct the photometry.
8. The magnitude can be corrected for interstellar extinction using Tables 14 and 15. Given $E(B-V)$, the extinction $A(P)$ in the passband P is calculated by multiplying $E(B-V)$ by the value in the table which correspond to the correct passband and spectral type.
9. If you want to transform the data to a different photometric system see §E. You should apply the correction for interstellar extinction (see §10) before applying the transformations.

B.3. Surface Photometry

1. Retrieve the image(s) from the HST archive or proceed with the manual recalibration of the data following the recipe given in ADHv4. Be sure to use the best reference files usually available a few weeks after the data acquisition.
2. After running CALACS on the association file the main output is the flat fielded, corrected *FLT* image and/or the geometrically corrected *DRZ* image (see Point 2 in §B.1).
3. Measure the surface brightness in units of $e^-/\text{sec}/\text{pixel}$. If one is interested in absolute surface photometry within a single bandpass, we recommend using the distortion-corrected (*DRZ*) image and converting from flux per pixel to flux per arcsec^2 via the output pixel scale used in the drizzling process. The *FLT* images may also be used, and since the pixel area variation has been divided out by applying the flat field, it is not necessary to apply the pixel area map. However, in this case, the appropriate factor to use in the conversion from pixel area to arcsec^2 depends on the mean pixel scale over the detector region used in normalization of the flat fields. Of course, if one is only interested in surface colors, this factor cancels (since the flat fields for different bandpasses were normalized in the same way), and the colors can be determined simply from the flux per pixel in the two bands.
4. The effect of the PSF red halo should also be considered in doing surface photometry of extended objects in near-IR filters (see discussion in §4.3).
5. Convert the count rate into $\text{OB MAG}/\text{arcsec}^2$ using the appropriate pixel scale.
6. Apply the appropriate zeropoint from Tables 10 and 11 to transform $\text{OB MAG}/\text{square arcsec}$ to a surface brightness in your choice of magnitude system.
7. If your observations were processed with CALACS before January 6, 2004 and the gain was different from the default setting, use Table 9 to correct the photometry.
8. If you want to transform the data to a different photometric system use Eq.12 with the coefficients in §8 which are appropriate for the source and target systems. For the color conversion of galaxies use the instructions in §E. You should apply the correction for interstellar extinction before applying the transformations.

C. Aperture Correction for Red Objects: EXAMPLES

CASE 1: Photometry of a High-Redshift Galaxy

The red “halo” can affect both the magnitude and the color of a galaxy. The most commonly used software for performing photometry of galaxies is SExtractor (Bertin & Arnouts, 1996) which provides several measurements of the magnitude. The most commonly used for faint galaxy photometry is MAG_AUTO, an aperture magnitude measured within an elliptical aperture adapted to the shape of the object and with a width scaled n times the isophotal radius. Other common choices are MAG_ISO, an isophotal magnitude that measures the integrated light above a certain threshold, and MAG_APER, a circular aperture. MAG_AUTO is the best choice for estimating total magnitudes but even for filters not affected by long wavelength light scattering it excludes a significant amount of the light (Benítez et al. 2004). In order to accurately measure the color of galaxies it is quite common to adopt a single aperture defined by a detection image⁹ and selecting MAG_ISO or MAG_APER. If all filters have similar PSFs then the magnitude measurements in all filters will be affected by the same systematic errors that cancel out when subtracting the magnitudes to calculate the colors. If the PSFs are different, then an aperture correction ought to be applied to the magnitudes in each filter.

For this simulation we use a model of a SB2 galaxy at redshift $z=5.8$ normalized to a magnitude ABMAG = 26.0 in the F850LP filter. The color of this galaxy is F775W-F850LP = 1.65 (1.71) in ABMAG WFC (HRC) system. Using the data of the characterization of the long wavelength light scattering and SYNPHOT, we estimate that the effective wavelength λ_{eff} and the fraction of the total light enclosed in a 0.3” aperture radius at the calculated λ_{eff} .

		F775W	F850LP
WFC	$\lambda_{eff}(\text{\AA})$	8026.2	9125.4
	EE($r=0''.3$)	0.879	0.816
HRC	$\lambda_{eff}(\text{\AA})$	7997.0	9210.8
	EE($r=0''.3$)	0.809	0.674

If we remove the AB zeropoints and scale the total counts for the EE for an aperture of 0''.3 radius we obtain the following OBMAG:

	F775W	F850LP
WFC	2.14	1.36
HRC	2.99	2.04

At this point there are two options: treat the measured counts as total counts, or decide to apply an aperture correction. The aperture correction can be calculated from different sources, from stars in the FOV, from the tabulated EE for the standard stars, using SYNPHOT or calculating the effective wavelength and Tables 6 and 7. In Table 16 we report the different cases and show the different results.

CASE 2: Photometry of a L-dwarf Star

For this example we simulate observations of a L3.5 star with magnitude VEGAMAG = 22.00 in the WFC F775W filter. The color of this star is F775W-F850LP = 1.84 (1.99) in VEGAMAG WFC (HRC) system. For this example we perform photometry in a 0''.2 (4 pixels) radius aperture for WFC, and a 0''.1 (4

⁹A detection image is either an image from one chose band, or the weighted sum of images obtained in different bands

pixels) radius aperture for HRC. Using the observed spectra of the L3.5 star 2M0036+18 and SYNPHOT, we estimate the effective wavelength λ_{eff} of the observations and the fraction of the total light enclosed in the selected aperture radius.

		F775W	F850LP
WFC	$\lambda_{eff}(\text{\AA})$	8003.7	9383.5
	EE($r=0'.2$)	0.829	0.718
HRC	$\lambda_{eff}(\text{\AA})$	7980.4	9445.2
	EE($r=0'.1$)	0.629	0.414

If we remove the VEGAMAG zeropoints and scale the total counts for the EE an aperture of 4 pixels radius we obtain the following instrumental magnitude:

	F775W	F850LP
WFC	-3.05	-3.81
HRC	-2.00	-2.70

At this point it is important to address the issue of the aperture correction. The aperture correction can be calculated from different sources, from stars in the FOV, from the tabulated EE for the standard stars, using SYNPHOT or calculating the effective wavelength and using Tables 6 and 7. In Table 17 we report the different cases and show the different results.

D. Supporting material for color transformations

All figures and tables in this appendix are in support of sections 8.3 and 8.4. Readers should read the appropriate section before using the coefficient listed in these tables in Eq. 12.

D.1. Example

Here we present, as an example, a transformation between the HRC and the WFC photometric systems. Suppose we observed the globular cluster NGC 2419 with ACS/HRC in F555W and F814W and have stored the photometric tables in the ABMAG HRC photometric system. We want to compare this result with previous WFC observations of the same cluster in the VEGAMAG system. This is the procedure that we need to follow, step by step:

1) Transform the HRC ABMAG photometry to OB MAG

This is simply done by subtracting the ABmag zeropoints (Table 11) from our dataset:

$$F555W_{HRC,OBMAG} = F555W_{HRC,ABMAG} - 25.248$$

$$F814W_{HRC,OBMAG} = F814W_{HRC,ABMAG} - 25.287$$

2) Compute the first estimate of TCOL

This is the less critical step and can be done by simply assuming

$$F555W_{WFC,OBMAG} = F555W_{HRC,OBMAG} \text{ and}$$

$$F814W_{WFC,OBMAG} = F814W_{HRC,OBMAG}$$

$$TCOL \equiv F555W_{HRC,OBMAG} - F814W_{HRC,OBMAG} \simeq F555W_{WFC,OBMAG} - F814W_{WFC,OBMAG}$$

3) Transform $F555W_{HRC,OBMAG}$ to $F555W_{WFC,OBMAG}$

From Table 13, we select the coefficients in the *synthetic* column for SMAG=F555W TMAG=F555W and TCOL=F555W-F814W and use them in eq. 12:

$$F555W_{WFC,OBMAG} = F555W_{HRC,OBMAG} - 0.470 - 0.004 TCOL + 0.000 TCOL^2$$

4) Transform $F814W_{HRC,OBMAG}$ to $F814W_{WFC,OBMAG}$

We proceed similarly to Step 3 for the F555W but in the *synthetic* column for SMAG=F814W, TMAG=F814W and TCOL=F555W-F814W there are two sets of coefficients depending on the value of TCOL:

for $TCOL < -0.2$

$$F814W_{WFC,OBMAG} = F814W_{HRC,OBMAG} - 0.655 - 0.012 TCOL - 0.031 TCOL^2$$

for $TCOL > -0.2$

$$F814W_{WFC,OBMAG} = F814W_{HRC,OBMAG} - 0.651 + 0.003 TCOL + 0.003 TCOL^2$$

5) Now we have better estimate of $F555W_{WFC,OBMAG}$ and $F814W_{WFC,OBMAG}$ from steps (2) and (3). Obviously, TCOL should be updated.

$$TCOL = F555W_{WFC,OBMAG} - F814W_{WFC,OBMAG}$$

6) Repeat Steps 3 through 5 until convergence is reached. Usually not more than 10 iterations are needed.

7) Convert $F555W_{WFC,OBMAG}$ and $F814W_{WFC,OBMAG}$ into the VEGAMAG by adding the zeropoints from Table 10:

$$F555W_{WFC,VEGAMAG} = F555W_{WFC,OBMAG} + 25.711$$

$$F814W_{WFC,VEGAMAG} = F814W_{WFC,OBMAG} + 25.487$$

In Fig. 19 we show the comparison between the HRC-to-WFC transformed magnitude and the WFC photometry over plotting the transformed magnitudes in the observed WFC color magnitude diagram and plotting the differences in magnitude in the two filters as a function of the color.

D.2. Transformation from ACS to UBVRI

NOTE FOR EDITORS: insert here:

Fig. 20

Tables 18 and 19

Figs. 21 and 22. Figs. 23 and 24

D.3. Transformation from ACS to WFPC2

NOTE FOR EDITORS: insert here:

Fig. 25

Tables 20 and 21

Figs. 26 and 27.

E. Transformation of Galaxy Templates

The color transformations described in the previous sections cannot offer accurate results for all spectral shapes, especially when the effects of redshift and intergalactic absorption are taken into account. Therefore it is desirable to describe the colors of observed galaxies at different redshifts in the different systems as accurately as possible. To do so, we use a variation of the CWWSB templates library, introduced in Benítez (2000) to calculate photometric redshifts and formed by the main types (E/S0, Sbc, Scd and Im) from Coleman, Wu and Weedman 1980 and two starbursts (SB2 and SB3) of Kinney et al. 1996. Benítez et al. (2004; hereafter B2004) presented a variant of this library, which has been calibrated using spectroscopic redshift catalogs with good quality photometry. By definition, the new templates agree much better with the observed colors of real galaxies, and for instance reduce the photometric redshift scatter by a factor of 25% in the HDFN, although they have not been optimized for that goal.

We generate estimated colors for the B2004 library in intervals of 0.05 in redshift, using the ACS WFC F606W filter as reference, for the WFC, HRC, WFPC2 and Johnson-Cousins systems. We apply corrections for intergalactic hydrogen extinction using the prescriptions of Madau (1995). All colors, except the Johnson-Cousins ones, correspond to the AB system. The colors were calculated using the functions included in the module `bpz_tools` from the BPZ package (Benítez 2000, <http://acs.pha.jhu.edu/~txitxo/bayesian.html>) which offers similar accuracy to SYNPHOT. The Vega reference spectrum is that of Bohlin & Gilliland (2004).

We present here only the tables relative to the E/S0, Sbc and Im templates for the WFC and Johnsons-Cousins system. Tables for other templates are available on-line at <http://acs.pha.jhu.edu/instrument/photometry/>

Tables 22-29 must be used with caution, however, because obviously these 6 “atomic” spectral templates cannot represent all the possible variations of real galaxy spectra except for some limited populations. Moreover, the colors at given redshifts obtained here are evaluated without the consideration of the spectral evolution, whose absence may introduce significant systematics particularly at high redshifts. Nevertheless, despite all these limitations, one can still use these tables as a guide to transform galaxy colors between different photometric systems for a given spectral type and redshift. To this aim, we need to find the closest possible match in redshift and spectral type in the electronic tables, using as many colors as possible. Then, we look up the corresponding color in the table corresponding to the spectral type and filter of interest, using interpolation between spectral types and redshifts if needed.

For example, let us suppose we have ACS/WFC photometry of an elliptical galaxy at redshift $z = 1$ with ACS/WFC ABmag $F606W - F814W = 1.82$. If we want to know the $F606W - F814W$ color in the HRC ABmag system, from Table 25 we can read the following multi-instrument colors for $z = 1$:

$$HRC_{F606W} - WFC_{F606W} = 0.04 \text{ and}$$

$$HRC_{F814W} - WFC_{F606W} = -1.87$$

Therefore we can directly calculate the ACS/HRC ABmag color for this galaxy: $F606W - F814W = 1.91$.

Moreover, if we need to compare the ACS observations with ground-based observations, for example in the R-I color, from Table 28 we derive for $z = 1$:

$$R - WFC_{F606W} = -0.59 \text{ and}$$

$$I - WFC_{F606W} = -1.59$$

and therefore $R-I = 1.00$.

F. Optimal Aperture Size

There are several factors to take into account when selecting the size of the aperture when measuring the flux of stars. For stellar photometry, the largest signal-to-noise ratios (i.e., the smallest photometric errors) are generally obtained with relatively small apertures (Howell 1989). Large apertures can have large photometric errors when the total signal from the source become comparable to the total background signal. They also can suffer from measurement errors from the background flux. On the other hand, very small apertures can suffer from small-number statistics because of the low measured signal.

There are a number of trade-offs to consider when selecting the optimal aperture size. The signal level of the source and the background noise are the main components. Several other factors can impact the choice of the aperture radius, such as the PSF spatial variations, the EE profile, the read noise and the crowding. In order to provide a more quantitative analysis of the various dependencies, we can develop a case study. Consider an isolated star that, in a given exposure, produces ~ 1000 electrons in an image taken with WFC/F606W. The default gain is $1 \text{ e}^-/\text{ADU}$ and the background (sky+dark current) is $\sim 10 \text{ ADU}$. The read noise is $\sim 5 \text{ e}^-$. We can predict the S/N ratio in different aperture radii, by calculating the fraction of source flux enclosed in the aperture area, and the total noise associated with the measurement. The total noise is obtained by adding in quadrature the Poisson noise of the star signal, the read noise, the Poisson noise of the background signal, plus two more noise contributions. The first one is related to breathing and focus variations on orbital timescales that can cause small variations in the aperture corrections. As an initial estimate, we used the data published for WFPC2 (Suchkov & Casertano, 1997). The second noise contribution, $\sim 10\%$ of the aperture correction, is related to uncertainties in the aperture correction and its variation due to the PSF spatial variation across the chip. In both cases, we express their impact as percentage of the source flux in the aperture. They are included in the noise calculation in the form of additional Poisson noise.

According to this simulation, the highest S/N ratio is obtained with a 4 pixel aperture radius. Small variations from the optimal radius by ± 1 pixel make little difference. We repeated the same test for the F435W and F850LP filter and we find similar results. The slightly larger PSF in the F850LP tends to produce the highest S/N at slightly bigger aperture. The comparison for these filters is shown in Fig. 28. A similar test for HRC shows that an aperture of 4-5 pixels is also the optimal choice for the HRC where the effect of the broadening of the PSF in the near-IR is more evident (Fig. 29). Brighter stars have larger optimal aperture sizes than do fainter stars. For a point source object with signal $> 20000 \text{ ADU}$, the optimal choice is a radius of $\sim 1''$. If one must use only one aperture size, it is clearly advantageous to chose an aperture size that produces the smallest photometric errors for the sources of most scientific interest.

REFERENCES

- Anderson, J. 2002, in Proc. 2002 HST Calibration Workshop, eds. S. Arribas, A. Koekemoer, & B. Whitmore (Baltimore, MD:STScI), 13
- Anderson, J. & King, I. 2004 Instrument Science Report ACS 04-15, (Baltimore, MD:STScI)
- Baggett, S., Casertano, S., Gonzaga, S., & Ritchie C. 1997, Instrument Science Report, WFCP2 97-10, (Baltimore, MD: STScI)
- Baggett, S., Gonzaga, S., Biretta, J., Casertano, S., Heyer, I., Mack, J., McMaster, M., Riess, A., Schultz, A., and Wiggs, M.S. 2001 Instrument Science Report, WFPC2 01-06, (Baltimore, MD: STScI)

- Bedin, L.R., Cassisi, S., Castelli, F., Piotto, G., Salaris, M., Momany, Y., & Pietrinferni, A. 2004, MNRAS, 357, 1038.
- Benítez, N. 2000, ApJ, 536, 571
- Benítez N. et al. 2004 (B2004), ApJS, 150, 1
- Bertin, E., Arnouts, S. 1966, A&AS, 117, 393
- Bessel, M.S. 1983, PASP, 95, 480
- Bessel, M.S. 1990, PASP, 102, 1181
- Blakeslee, J.P., Anderson, K.R., Meurer, G.R., Benítez, N. & Magee, D. 2003 in ASP Conf. Ser. 295, Astronomical Data Analysis Software and Systems XII, ed. H.E. Payne, R.I., Jedrzejewski, & R.N. Hook (San Francisco:ASP), 257
- Blakeslee, J. P. et al. 2003b, ApJ, 596, L143
- Boffi, F., De Marchi, G., & Bohlin, R.C. 2004 Instrument Science Report ACS 04-05, (Baltimore, MD: STScI)
- Bohlin, R.C., Harris, A.W., Holm, A.V., & Gry, C. 1990, ApJS, 73, 413
- Bohlin, R.C., Hartig, G.F., & Tzvetanov, Z. 2001, Instrument Science Report ACS 00-10, (Baltimore, MD: STScI)
- Bohlin, R.C., Hartig, G., & Sparks, Wm. 2002, Instrument Science Report ACS 02-03, (Baltimore, MD: STScI)
- Bohlin, R.C., Wheeler, T., & Mack, J. 2003, Instrument Science Report ACS 03-11, (Baltimore, MD: STScI)
- Bohlin, R.C. & Gilliland, R. 2004, AJ, 127, 3508
- Bruzual, Persson, Gunn, Stryker stellar atlas (BPGS), http://www.stsci.edu/hst/observatory/cdbs/astromical_catalogs.html
- Bruzual spectrum synthesis Atlas (BZ77), http://www.stsci.edu/hst/observatory/cdbs/astromical_catalogs.html
- Bruzual, C. & Charlot, S. 2003, MNRAS, 344, 1000
- Buser, R. & Kurucz, R.L. 1978, A&A, 70, 555
- Cardelli, J.A., Clayton, G.C., & Mathis, J. S. 1989, ApJ, 345, 245
- Casertano, S., & Wiggs, M.S., 2001, Instrument Science Report, WFPC2, 01-10, (Baltimore, MD: STScI)
- Cawley, L., Goudfooij, P., Withmore, B., Stiavelli, M., & CTE working group 2001, Instrument Science Report, WFC3 01-05, (Baltimore, MD: STScI)
- Clampin, M., et al. 1998, Proc. SPIE, 3356, 332
- Clampin, M., Hartig, G.F., Ford, H.C., Sirianni, M., Meurer, G., Martel, A.R., Blakeslee, J.P., Illingworth, G.D., Krist, J., Gilliland, R., & Bohlin, R., 2002, in Proceeding of the 2002 HST Calibration Workshop, 3, eds. Arribas, S., Koekemoer, A., & Whitmore, B., (Baltimore, MD:STScI)

- Coleman G.D., Wu, C.C., & Weedman, D.W. 1980, *ApJS*, 43, 393
- Colina, L., Bohlin, R., & Castelli, F. 1996, Instrument Science Report CAL/SCS-008, (Baltimore, MD: STScI)
- De Marchi, G., Sirianni, M., Gilliland, R., Bohlin, R., Pavlovsky, C., Jee, M.J., Mack, J., van der Marel, R., & Boffi, F. 2004, Instrument Science Report ACS 04-08, (Baltimore, MD: STScI)
- Dolphin, A.E. 2000a, *PASP*, 112, 1383
- Dolphin, A.E. 2000b, *PASP*, 112, 1397
- Ford, H.C., et al. 1996, *Proc. SPIE*, 2807, 184
- Ford, H.C., et al. 1998, *Proc. SPIE*, 3356, 234
- Ford, H.C., et al. 2002, *Proc. SPIE*, 4854, 81
- Fruchter, A.S., & Hook, R.N. 2002, *PASP* 114, 144
- Giavalisco, M. 2004a, ACS ISR04-12, (Baltimore, MD: STScI)
- Giavalisco, M. 2004b, ACS ISR04-13, (Baltimore, MD: STScI)
- Gilliland, R.L., & Riess, A. 2002, in *Proc. 2002 HST Calibration Workshop*, eds. S. Arribas, A. Koekemoer, & B. Whitmore (Baltimore, MD: STScI), 61
- Gilliland, R.L. 2004, Instrument Science Report ACS 04-01, (Baltimore, MD: STScI)
- Girardi, L., Bertelli, G., Bressan, A., Chiosi, C., Groenewegen, M.A.T., Marigo, P., Salasnich, B., & Weiss, A. 2002, *A&A*, 391, 195
- Goudfrooij P., & Kimble, R.A. 2002, in *Proc. 2002 HST Calibration Workshop*, eds. S. Arribas, A. Koekemoer, & B. Whitmore (Baltimore, MD: STScI), 105
- Hack, W.J. & Greenfield, P. 2000, in *ASP Conf. Ser. 216, Astronomical Data Analysis Software and Systems IX*, ed N. Manset, C. Veillet, & D. Crabtree (San Francisco: ASP), 433
- Hack, W.J, Busko, I. & Jedrzejewski, R.I. 2003 in *ASP Conf. Ser. 295, Astronomical Data Analysis Software and Systems XII*, ed. H.E. Payne, R.I., Jedrzejewski, & R.N. Hook (San Francisco: ASP), 453
- Harris, W.E., Bell, R.A., Vanderberg, D.A., Bolte, M., Stetson, P., Hesser, J.E., van der Bergh, S., Bond, H.E., Fahlman, G.G., & Richer, H.B. 1997, *AJ* 114, 1030
- Hartig, G.F., Krist, J.E., Martel, A.R., Ford, H.C. & Illingworth, G.D. 2003, *Proc SPIE*, 4854, 532
- Hayes, D.S. 1985, in *Calibration of Fundamental Stellar Quantities*, *Proc. of IAU Symposium No. 111*, edited by D.S. Hayes, L.E. Pasinetti, and A.G. Davis Phillip (Reidel, Dordrecht), p. 225
- Heyer I., Richardson, M., Whitmore, B.C., & Lubin, L.M. 2002, in *Proc. 2002 HST Calibration Workshop*, eds. S. Arribas, A. Koekemoer, & B. Whitmore (Baltimore, MD: STScI), 333
- Heyer I., Richardson, M., Whitmore, B.C., & Lubin, L.M. 2004, Instrument Science Report, WFPC2 04-01, (Baltimore, MD: STScI)

- Högbom, J. A. 1974, *A&AS*, 15, 417
- Holtzman, J.A., Burrows, C.J., Casertano, S., Hester, J.J., Trauger, J.T., Watson, A.M., & Worthey, G. 1995a, *PASP*, 107, 1065
- Holtzman, J.A. et al. 1995b, *PASP*, 107, 156.
- Hopkinson, G.R. 1991, in *Proceeding ESA Electronic Components Conference*, ESA SP-313, 301
- Howell, S.B. 1989, *PASP*, 101, 616
- Janesick, J., Soli, G., Elliot, T., & Collins, S. 1991, *Proc SPIE*, 1447, 87
- Janesick, J.R. 2001, *Scientific Charge-Coupled Devices*, SPIE Press Monograph
- Kimble, R.A., et al. 1998, *Proc. SPIE*, 3356, 188
- Kinney et al. 1996, *ApJ*, 467, 38
- Koekemoer, A.M., Fruchter, A.S., Hook, R. & Hack W. 2002, in *Proc. 2002 HST Calibration Workshop*, ed. S. Arribas, A. Koekemoer, & B. Whitmore (Baltimore, MD: STScI), 337
- Koorneef, J., Bohlin, R., Buser, R., Horne, K. & Turnshek, D. 1986, in *Highlights of Astronomy (IAU)*, Vol.7, 833, ed. S.-P.Swinggs
- Krist, J. E., Hartig, G.F., Clampin, M., Golimowski, D.A., Ford, H.C., & Illingworth, G.D. 2003a, *Proc. SPIE*, 4860, 20
- Krist, J.E. 2003b ACS Instrument Science Report 2003-06, (Baltimore, MD: STScI)
- Krist, J.E. 2003c, (Baltimore, MD: STScI),
<http://www.stsci.edu/software/tinytim>
- Kurucz, R.L. 1993, *ATLAS9 Stellar Atmosphere Programs and 2 km/s grid*, Smithsonian Astrophysical Observatory. CD-ROM No. 13
- Kurucz, R. 2003, <http://kurucz.harvard.edu/>
- Mack, J., Bohlin, R.C., Gilliland, R.L., van der Marel, R., De Marchi, G., & Blakeslee, J.P. 2002a, *Proc. 2002 HST Calibration Workshop*, ed. S. Arribas, A. Koekemoer, & B. Whitmore (Baltimore, MD: STScI), 23
- Mack, J., Bohlin, R.C., Gilliland, R.L., van der Marel, R., Blakeslee, J.P., & De Marchi, G. 2002b, *Instrument Science Report ACS 02-08*, (Baltimore, MD: STScI)
- Madau, P. 1995, *ApJ*, 441, 18
- Maíz-Apellániz, J. 2002. *Proc. 2002 HST Calibration Workshop*, ed. S. Arribas, A. Koekemoer, & B. Whitmore (Baltimore, MD: STScI), 346
- Manfroid, J., & Sterken, C. 1992, *A&A* 258, 600
- Manfroid, J., Sterken, C. & Gosset, E. 1992, *A&A* 264, 345

- Martel, A.R., & Hartig, G.F. 2001 http://acs.pha.jhu.edu/instrument/calibration/results/by_item/flat_fields/internal_lamps/d2tung/
- Martel, A.R., Hartig, G.F. & Sirianni, M. 2001a, WFC#4: Gain, Noise, Linearity, Saturation
http://acs.pha.jhu.edu/instruments/calibration/results/by_item/detector/wfc/build4/gain
- Martel, A.R., Hartig, G.F. & Sirianni, M. 2001b, HRC#1: Gain, Noise, Linearity, Saturation
http://acs.pha.jhu.edu/instruments/calibration/results/by_item/detector/hrc/build1/gain
- Meurer, G.R., et al. 2002, in Proc. 2002 HST Calibration Workshop, ed. S. Arribas, A. Koekemoer, & B. Whitmore (Baltimore, MD: STScI), 65
- Meurer, G.R., et al. 2003, Proc. SPIE, 4854, 507
- Michard, R. 2002, A&A, 384, 763
- Mutchler, M., Sirianni, M., Van Orsow, D., & Riess, A. 2004, ACS-ISR04-07, (Baltimore, MD: STScI)
- Mutchler, M., Sirianni, M. 2005, Instrument Science Report ACS 05-03, (Baltimore, MD: STScI).
- Oke J.B. 1964, ApJ140, 689
- Pavlovsky, C., et al. 2004a, ACS Instrument Handbook Version 5.0, (Baltimore, MD: STScI), [AIHv5]
- Pavlovsky, C., et al. 2005, ACS Data Handbook Version 4.0, (Baltimore MD: STScI) [ADHv4]
- Pietrinferni, A., Cassisi, S., Salaris, M., Castelli, F. 2004, ApJ, 612, 168
- Quijano, K.J., et al. 2003, STIS Instrument Handbook Version 7.0 (Baltimore MD: STScI)
- Riess, A., 2000, Instrument Science Report, WFPC2 00-04, (Baltimore, MD: STScI)
- Riess, A. 2002a, Instrument Science Report, ACS 02-07, (Baltimore, MD: STScI)
- Riess, A., 2002 in Proc. 2002 HST Calibration Workshop, ed. S. Arribas, A. Koekemoer, & B. Whitmore (Baltimore, MD : STScI), 47
- Riess, A. 2003, Instrument Science Report, ACS 03-09, (Baltimore, MD: STScI)
- Riess, A., & Mack, J. 2004, Instrument Science Report, ACS 03-06, (Baltimore, MD: STScI)
- Saha, A., Labhardt, L., & Prosser, C. 2000, PASP, 112, 163
- Saha, A., Dolphin, A.E., Thim, F., & Whitmore, B. 2005, PASP, 117, 37
- Sirianni, M., Clampin, M., Hartig, G.F., Rafal, M., Ford, H.C., Golimowski, D.A., Tremonti, C., Illingworth, G.D., Blouke, M., Lesser, M., Burmester, B., Kimble, R., Sullivan, P., Krebs, C., Proc SPIE, 3355, 608
- Sirianni, M., Clampin, M. 1999a, http://acs.pha.jhu.edu/instrument/detectors/WFC/lot7b_1001/report1001.pdf
- Sirianni, M., Clampin, M. 1999b, http://acs.pha.jhu.edu/instrument/detectors/WFC/lot7b_1002/report1002.pdf

- Sirianni, M., et al. 2000, Proc. SPIE, 4008, 669
- Sirianni, M., Martel, A.R., Hartig, G.F. 2001, http://acs.pha.jhu.edu/instrument/calibration/results/by_item/detector/wfc/build4/overscan/
- Sirianni, M., De Marchi, G., Gilliland, R., Pavlovsky, C. & Mack, J. 2002a in Proc. 2002 HST Calibration Workshop, ed. S. Arribas, A. Koekemoer, & B. Whitmore (Baltimore, MD: STScI), 31
- Sirianni, M., Martel, A.R., Jee, M.J., Van Orsow, D., & Sparks, W.B. 2002b in Proc. 2002 HST Calibration Workshop, ed. S. Arribas, A. Koekemoer, & B. Whitmore (Baltimore, MD: STScI), 82
- Sirianni, M., et al. 2003, Proc. SPIE, 4854, 496
- Sirianni, M., Mutchler, M., Clampin, M., Ford, H.C., Illingworth, G., Hartig, G.F., Van Orsow, D., & Wheeler, T. 2004, Proc. SPIE, 5499, 173
- Sirianni, M., Mutchler, M. & Lucas, R. 2005 ACS-ISR, (Baltimore, MD: STScI) *in preparation*
- Sterken, C., & Manfroid, J., 1992, Astronomical Photometry - A GUIDE, Kluwer Academic Publisher, (Kluwer Academic)
- Stetson, P.B. 1992, JRASC, 86,71
- Stetson, P.B. 1998, PASP, 110. 1448
- Stetson, P.B. 2002, <http://cadwww.hia.nrc.ca/cadcbn/wdb/astrocat/stetson/query>
- Tonry, J. L., Blakeslee, J. P., Ajhar, E. A., & Dressler, A. 1997, ApJ, 475, 399
- Tonry, J. L., Dressler, A., Blakeslee, J. P., Ajhar, E. A., Fletcher, A., Luppino, G. A., Metzger, M. R. & Moore, C. B. 2001, ApJ, 546, 681
- Tran, H.D., et al. 2002a, Proc. SPIE, Vol. 4854, 686
- Tran, H.D., et al. 2002b, in Proc. 2002 HST Calibration Workshop, ed. S. Arribas, A. Koekemoer, & B. Whitmore (Baltimore, MD: STScI), 86
- van der Marel, R. 2003, Instrument Science Report ACS 03-10, (Baltimore, MD: STScI)
- Walsh, J.R., Pirzkal, N., & Pasquali, A. 2002, in Proc. of the 2002 HST Calibration Workshop, 90, ed. Arribas, S., Koekemoer, A., & Whitmore, B., (Baltimore, MD: STScI)
- Walsh, J.R., Freudling, W., Pirzkal, N., & Pasquali, A. 2003 Instrument Science Report, ACS 03-12, (Baltimore, MD: STScI)
- Whitmore, B., Heyer, I., & Casertano, S. 1999, PASP, 111, 1559
- Whitmore, B. & Heyer, I. 2002, Instrument Science Report, WFPC2 02-03, (Baltimore, MD: STScI)
- Young, A.T. 1992a, in ASP Conf. Ser. 28, Automated Telescope for Photometry and Imaging, ed. S.J. Adelman, R.J. Dukes, Jr., & C.J. Adelman (San Francisco: ASP), 73
- Young, A.T. 1992b A&A 257, 366
- Young, A.T., 1993, in Precision Photometry, SAAO, eds. D. Kilkeny, Lastovica, E & J.W. Menzies, 25

Young, A.T. 1994 A&A 288, 683

Zoccali, M., Renzini, A., Ortolani, S., Bragaglia, A., Bohlin, R., Carretta, E., Ferraro, F.R., Gilmozzi, R., Holberg, J.B., Marconi, G., Rich, R.M., & Wesemael, F. 2001, ApJ 553, 733

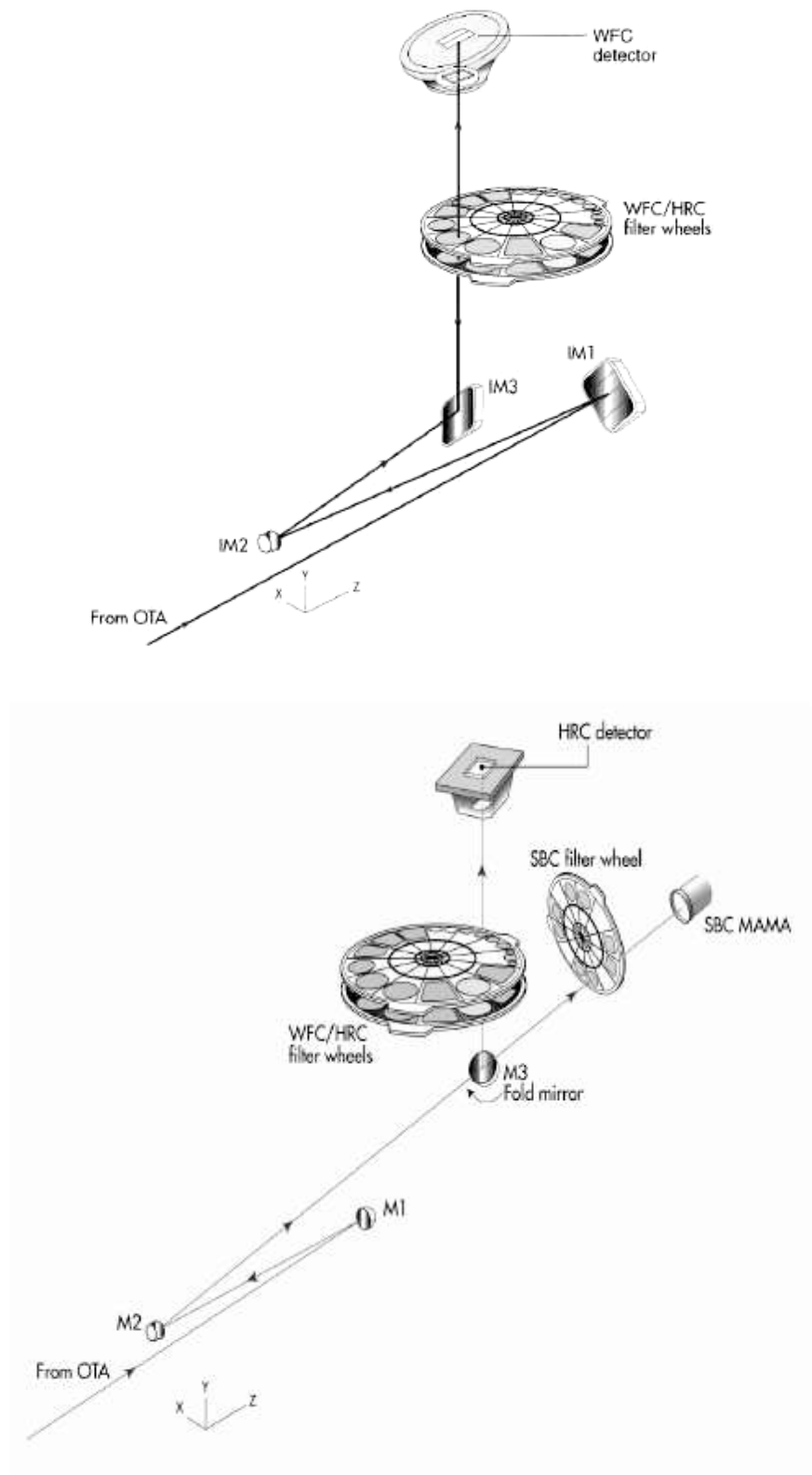

Fig. 1.— Schematic showing the optical design for the WFC (top) and HRC/SBC (bottom).

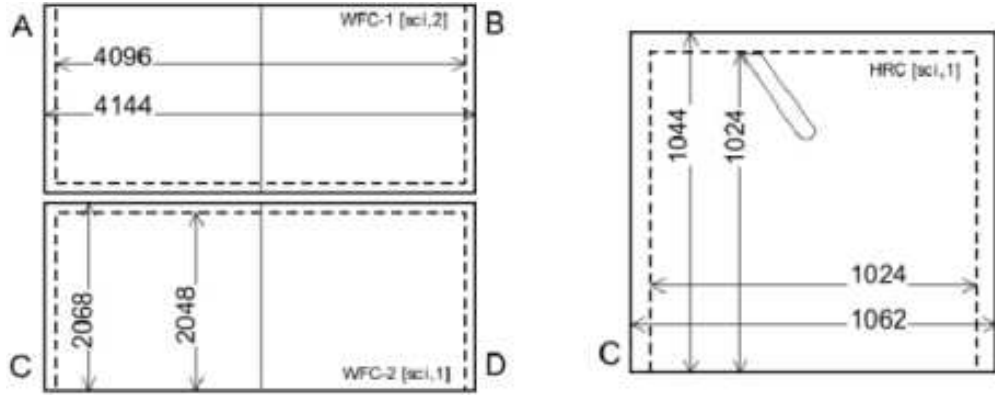

Fig. 2.— Structure of the WFC and HRC chips (not scaled). Dashed lines show the overscan regions, dotted lines show the quadrant division. The dimension in pixels are shown. The gap between the two WFC chips is about 50 pixel wide. The position of the readout amplifiers used in the default configuration and the approximate size and position of the HRC Fastie finger are also shown.

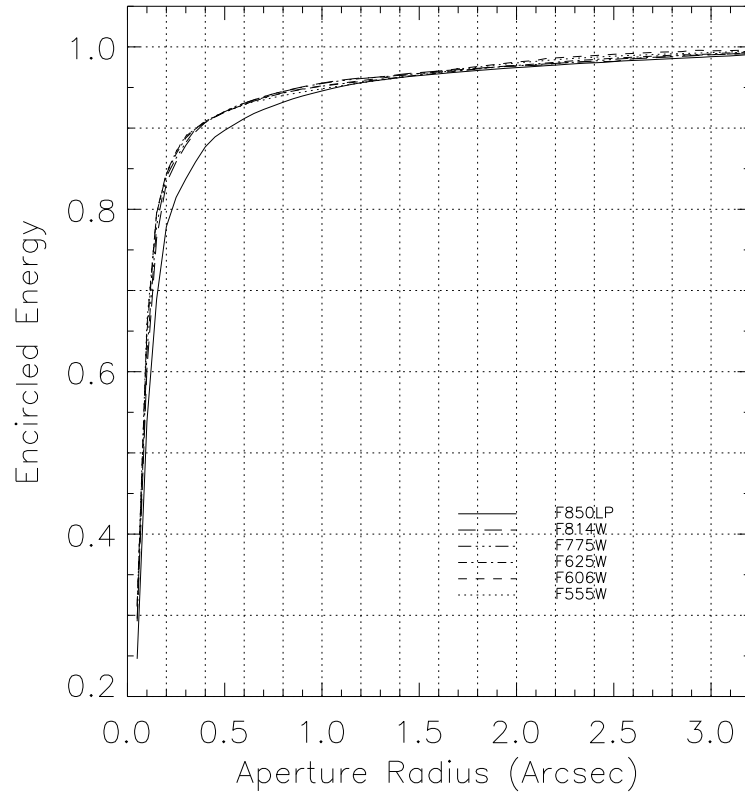

Fig. 3.— Comparison of EE profiles derived from multiple observations of two white dwarves in visual and near-IR filters of the WFC.

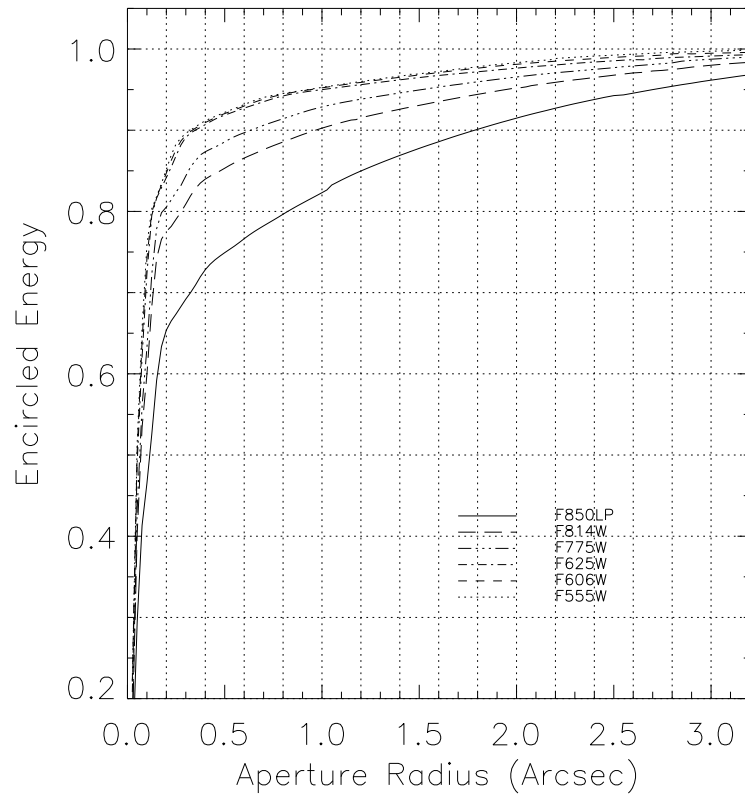

Fig. 4.— Comparison of EE profiles derived from multiple observations of two white dwarves in visual and near-IR filters of the HRC.

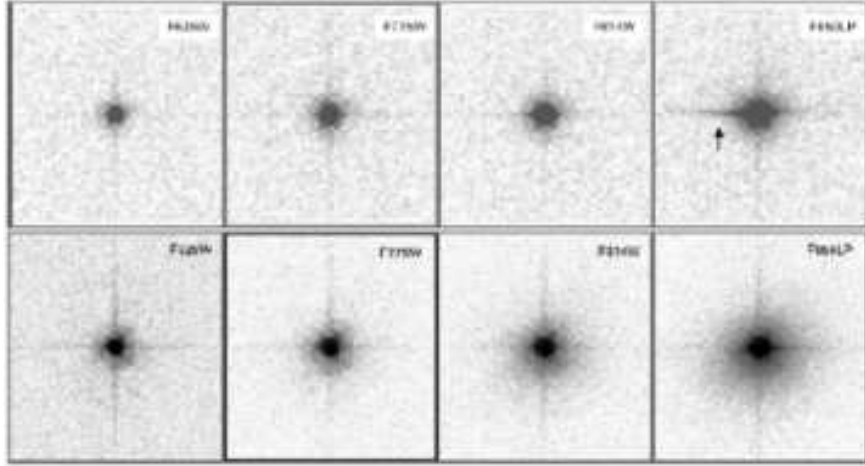

Fig. 5.— WFC (top) and HRC (bottom) images ($7.5'' \times 7.5''$) taken through the near-IR broad-band filters showing the long wavelength scattered halo. The halo grows considerably in the HRC from left to right. The anti-halation aluminum layer of the WFC effectively reduces the halo in the WFC but it gives rise to a spike in the row direction toward the edge containing amplifiers AC as indicated by the arrow.

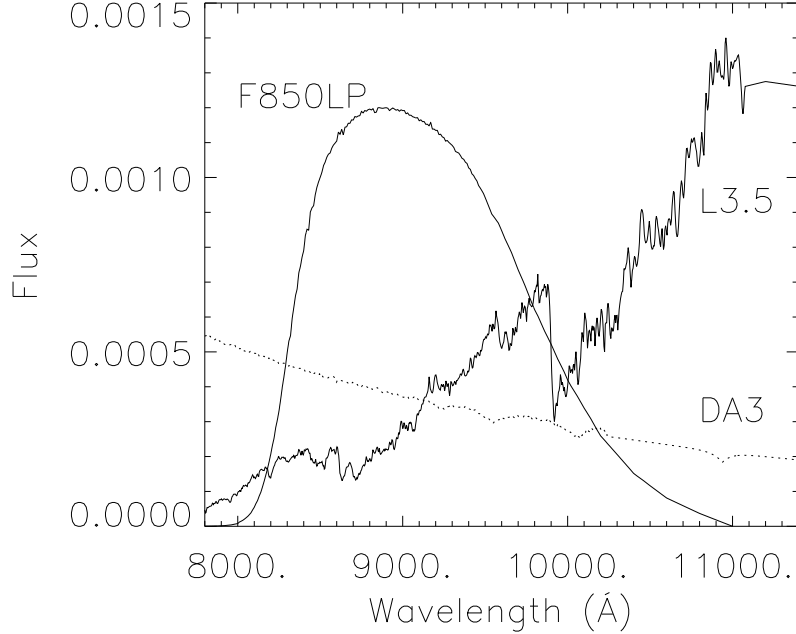

Fig. 6.— SED of the hot GRW+70 (DA3) star (dotted line) and the cold 2M0036+18 (L3.5) dwarf star (solid line) normalized to produce the same arbitrary magnitude within the HRC F850LP filter, also shown. The wavelength-dependent contribution to counts within the same passband changes dramatically for these stars. The effective wavelength is 9107\AA for GRD+70 and 9445\AA for 2M0036+18.

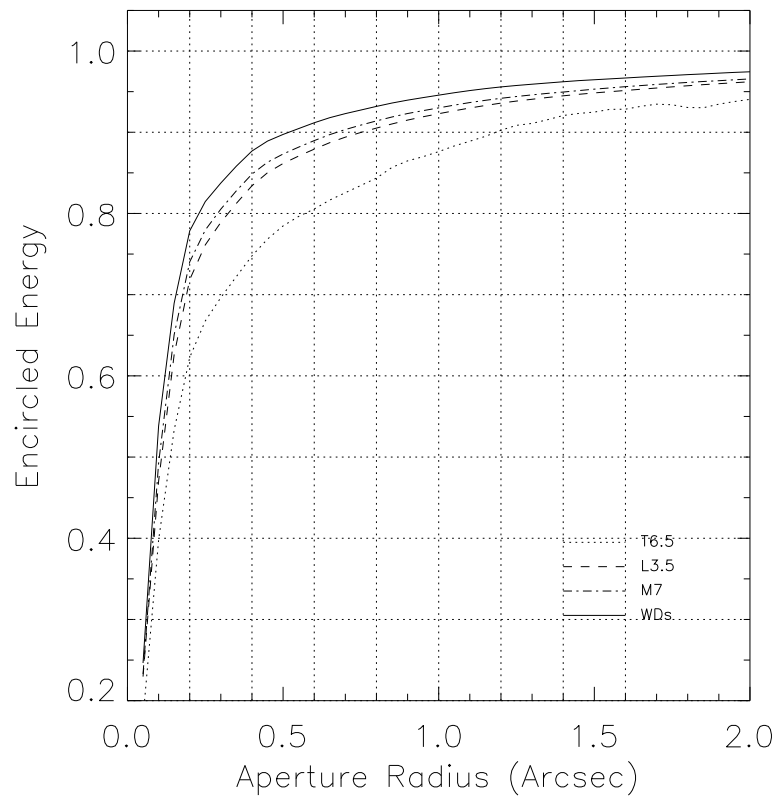

Fig. 7.— Variation of the EE in the WFC F850LP filter for different types of stars.

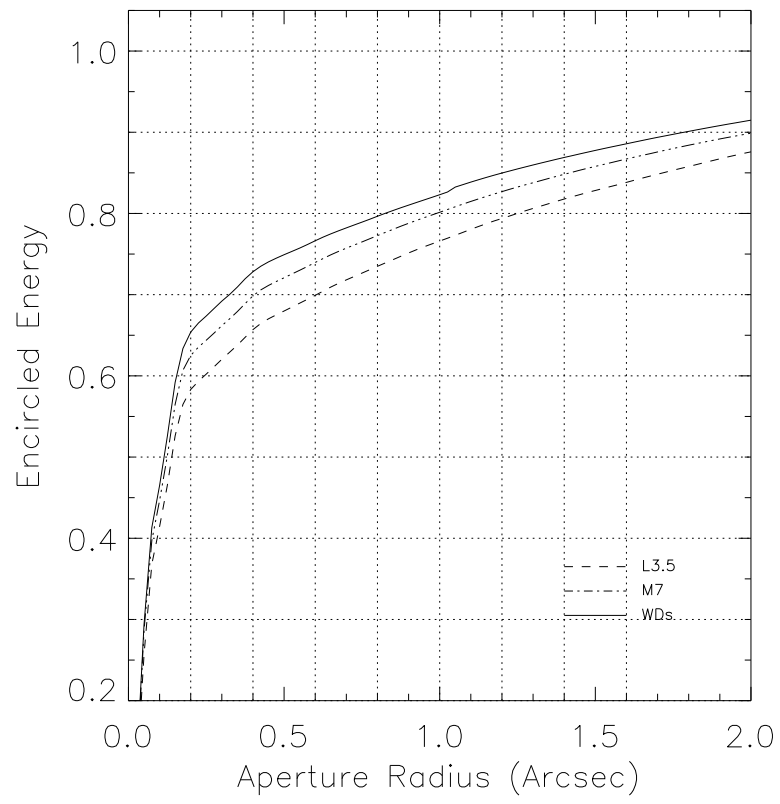

Fig. 8.— Variation of the EE in the HRC F850LP filter for different types of stars.

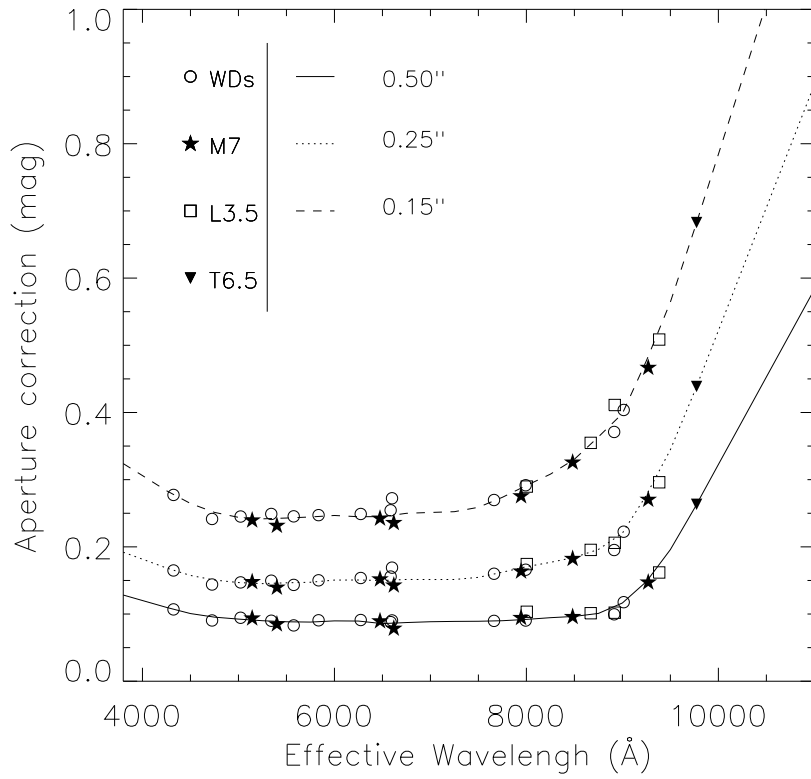

Fig. 9.— Aperture corrections *vs* effective wavelength for the WFC. Three different aperture radii are shown here. The aperture correction is from the selected aperture to the nominal infinite aperture. Different stars are represented with different symbols.

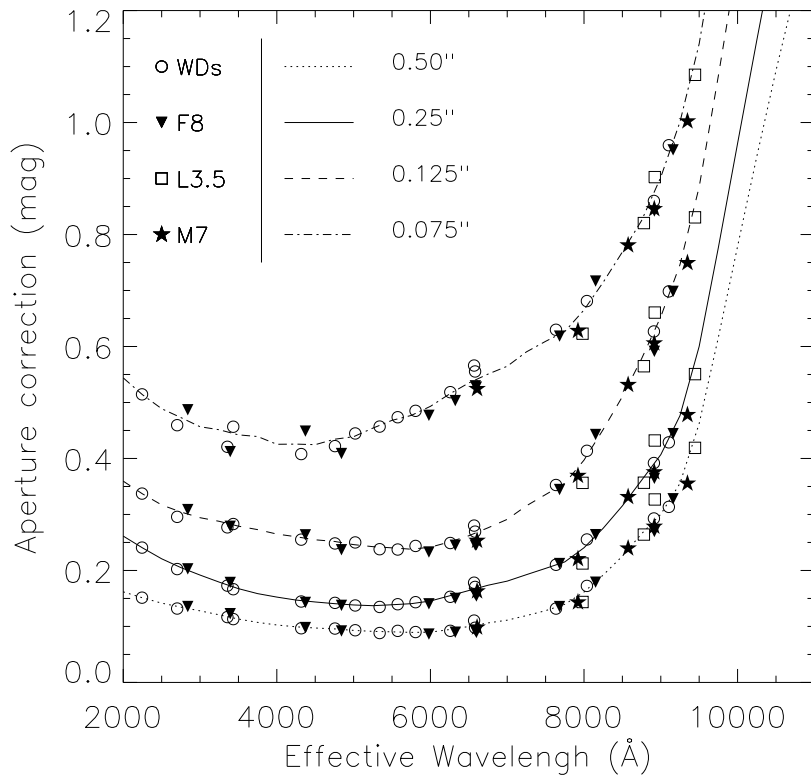

Fig. 10.— Same as Fig. 9 but for the HRC.

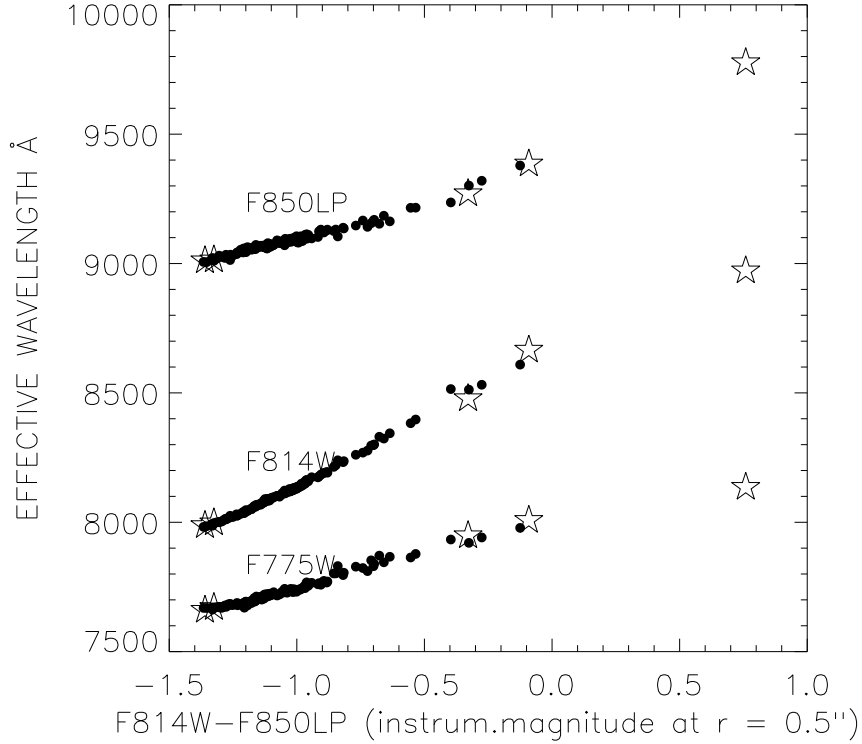

Fig. 11.— Effective wavelength *vs* color relation for three near-IR filters of WFC. The color $F814W-F850LP$ is defined as $-2.5 \log([counts/sec]_{F814W,0''.5} / [counts/sec]_{F850LP,0''.5})$, where $[counts/sec]_{filter,0''.5}$ is the count rate within an aperture radius of $0''.5$. The dots represent the Bruzual, Persson, Gunn & Stryker stellar atlas. The stars are the five stars used for the EE study.

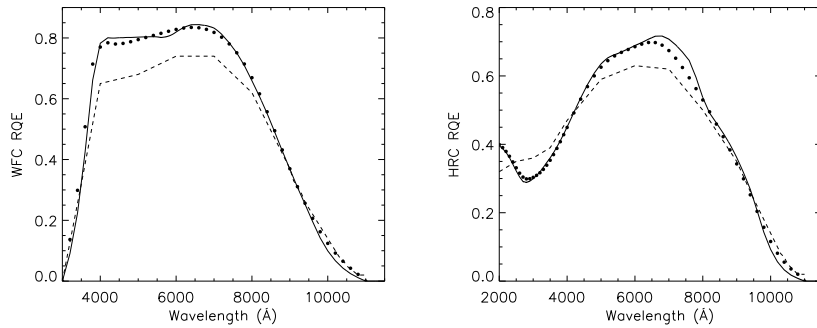

Fig. 12.— Responsive quantum efficiency curves for the WFC (left) and HRC (right) CCDs. The dashed lines show the pre-flight measurements, while the dotted lines show the first on-orbit correction (Siriani et al. 2002). The final RQE curves resulting from the iterative process are shown as a solid line (De Marchi et al. 2004).

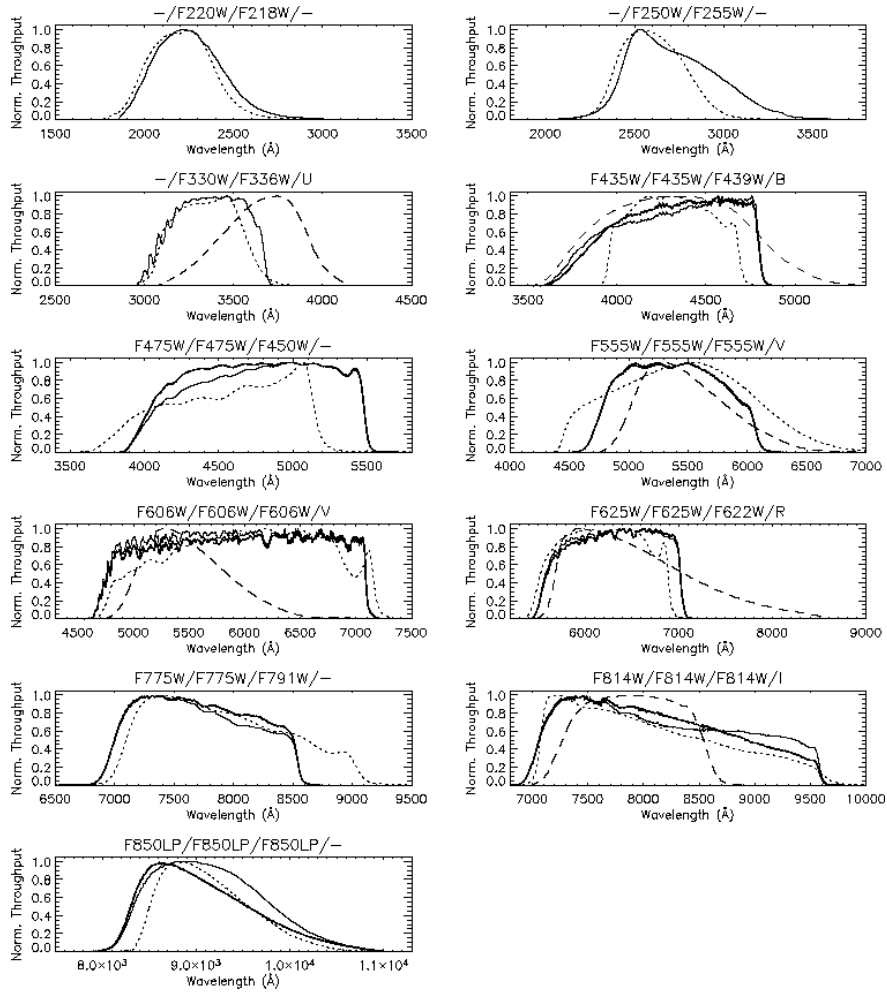

Fig. 13.— Comparison between the total response curve for several filters of WFC (solid thick line), HRC (solid thin line), WFPC2 (dotted line) and the LANDOLT filters (dashed line). All curves have been normalized to their peak value. The title of each panel shows the name of the filter WFC/HRC/WFPC2/LANDOLT.

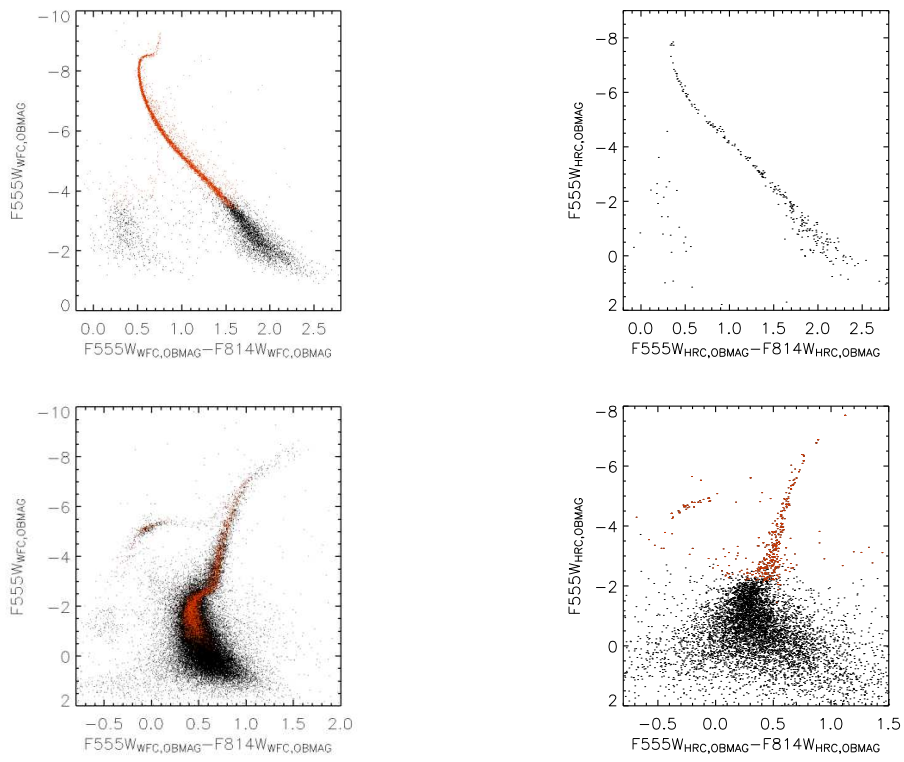

Fig. 14.— Observed color magnitude diagrams for NGC 104 (top) and NGC 2419 (bottom) with WFC (left) and HRC (right).

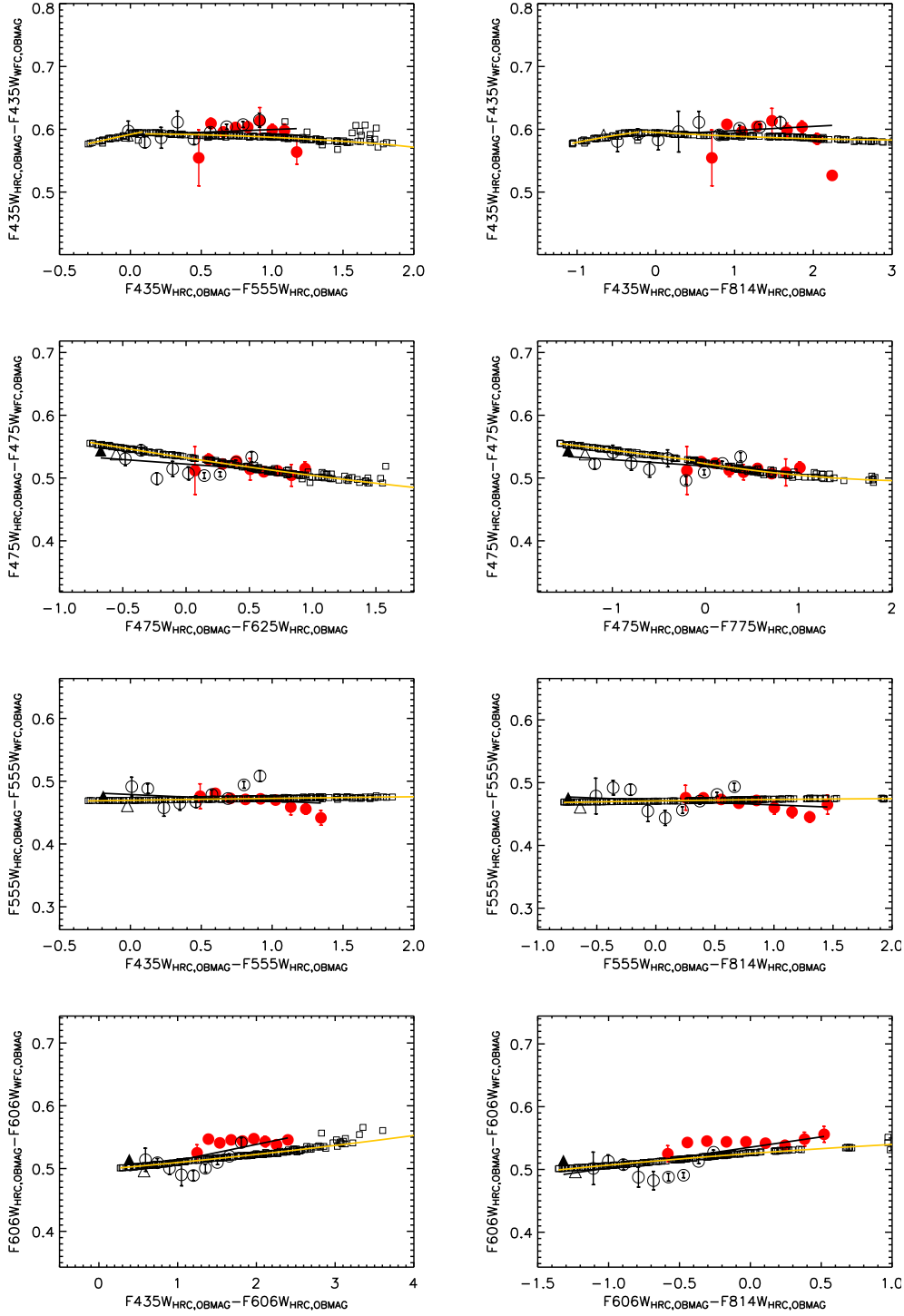

Fig. 15.— Observed and synthetic WFC-to-HRC transformations for primary photometric filters. Squares show the synthetic measurements for the BPGS atlas. The circles are observational data (filled for NGC104, open for NGC2419). The two standard stars are shown with triangles. The black line shows the linear fit to the observational points, the yellow curve (light gray in B&W) shows the synthetic transformations.

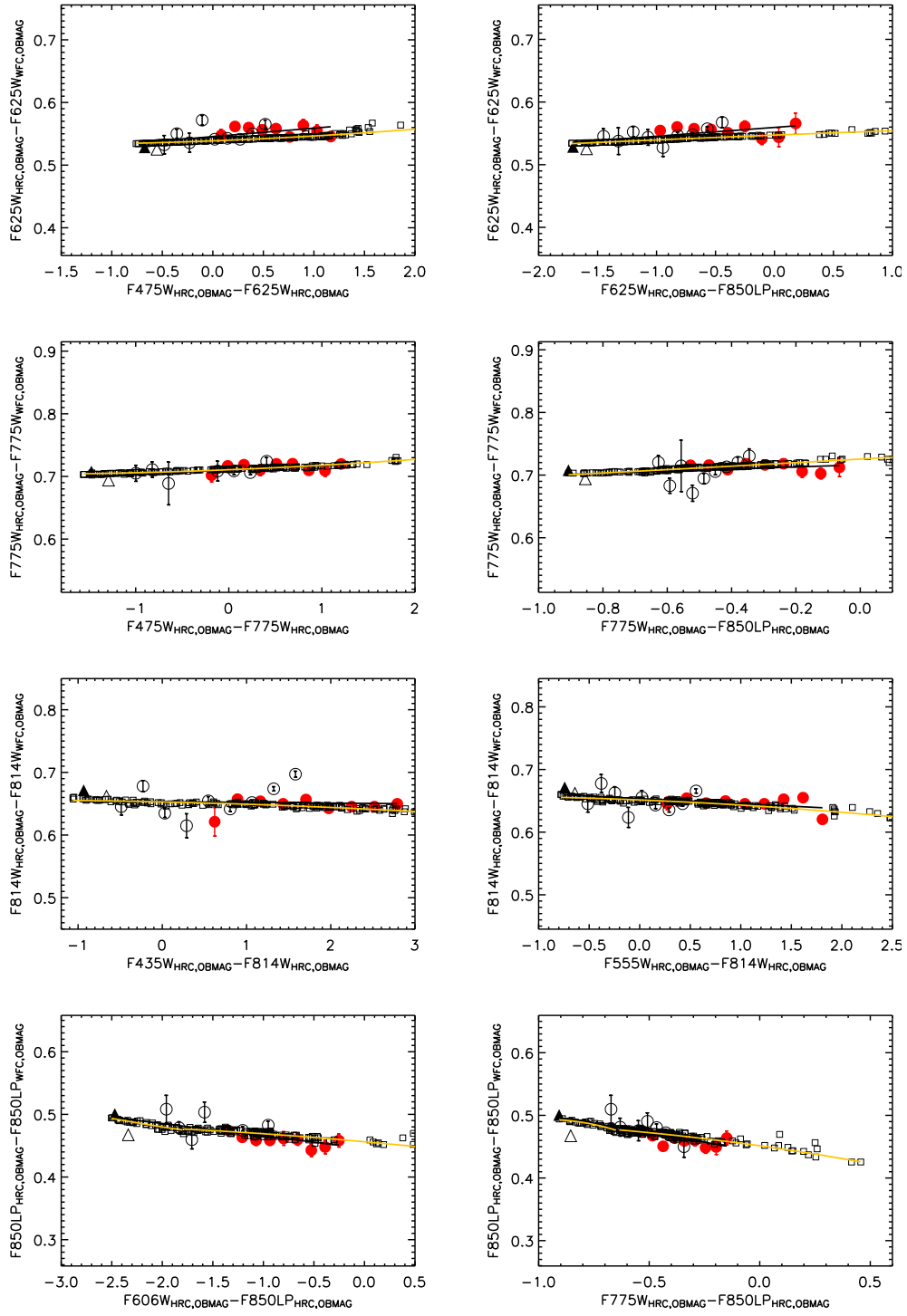

Fig. 15.— Continued.

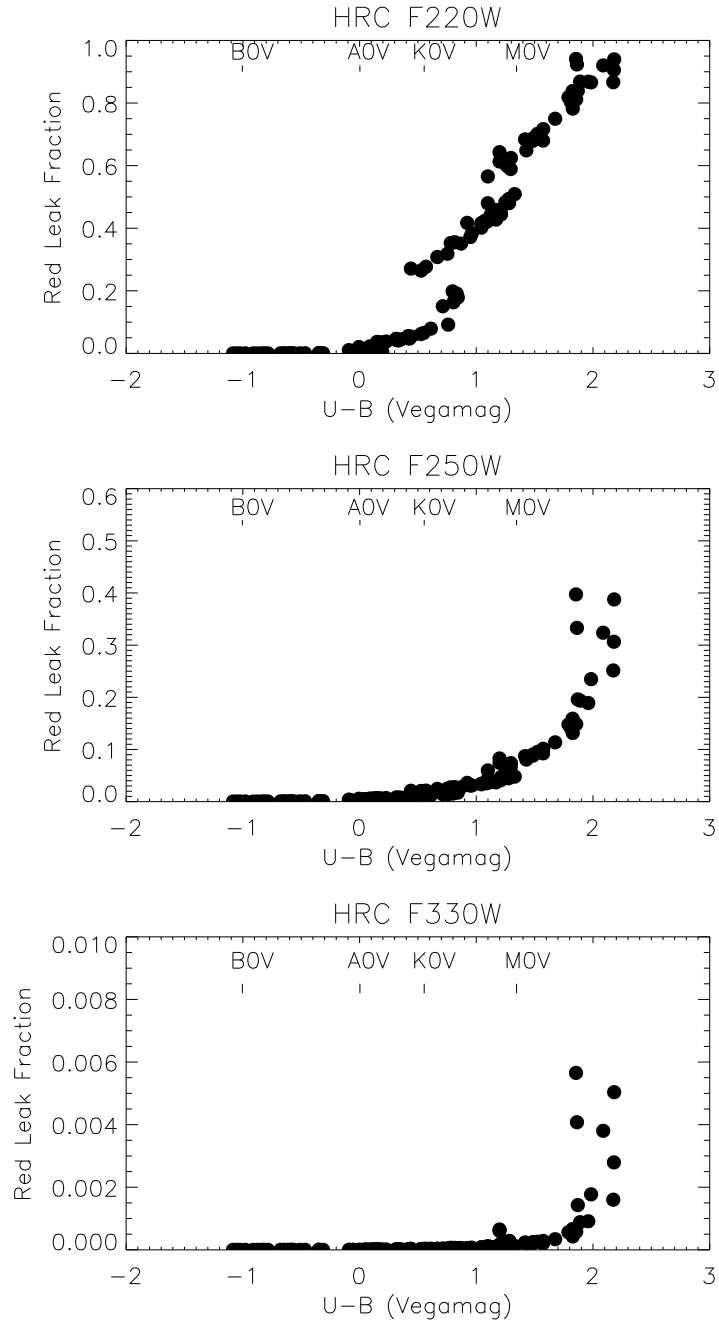

Fig. 16.— Amount of light contributed by red leak ($\lambda > 4000 \text{ \AA}$) as a function of color.

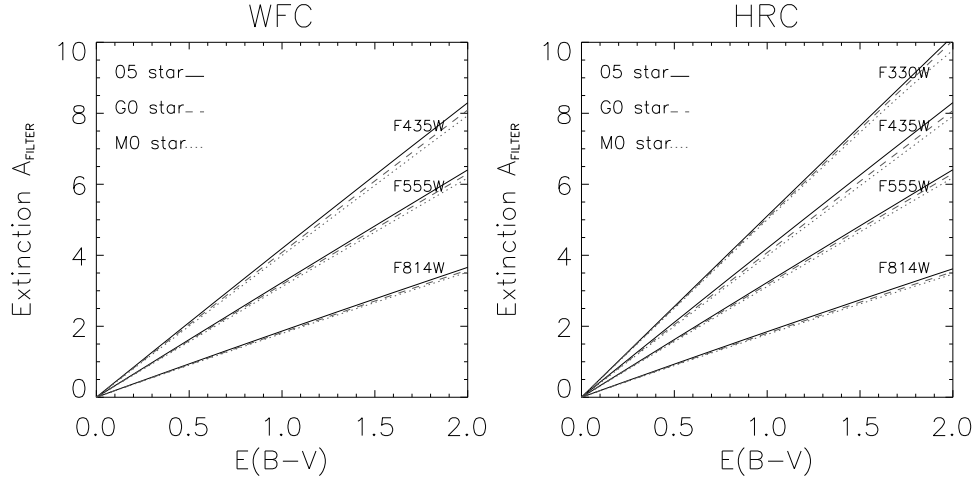

Fig. 17.— Extinction in ACS WFC and HRC filters as a function of $E(B-V)$ for three stars of different spectral types. We used the interstellar extinction curve from Cardelli et al. (1989) with $R_v=3.1$

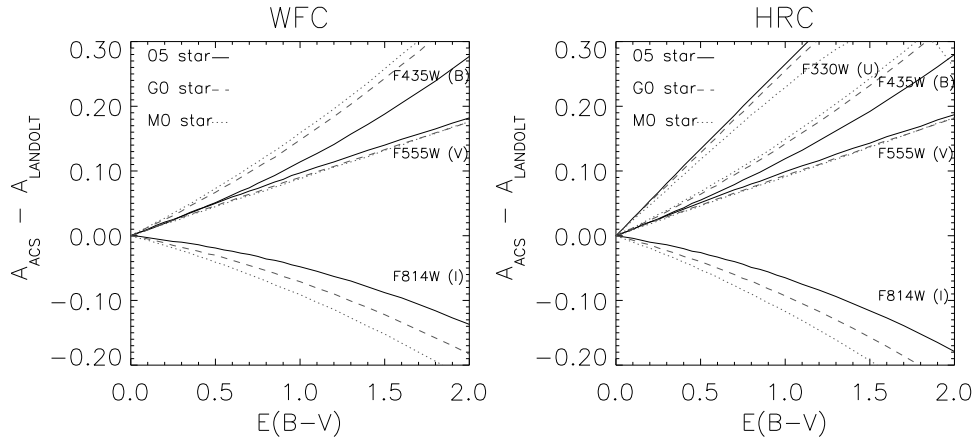

Fig. 18.— Difference in extinction between the ACS system and the ground system as a function of $E(B-V)$.

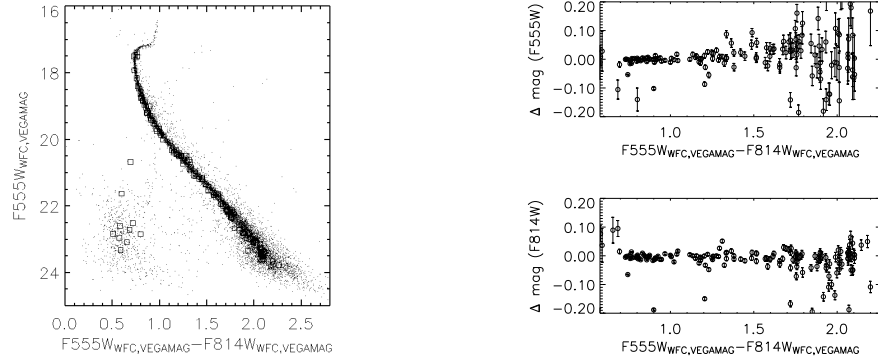

Fig. 19.— Left: HRC photometry of NGC 104 (open square) transformed into the WFC observational plane of WFC. Right: Difference in magnitude (Transformed HRC - WFC) in the two filters as a function of color.

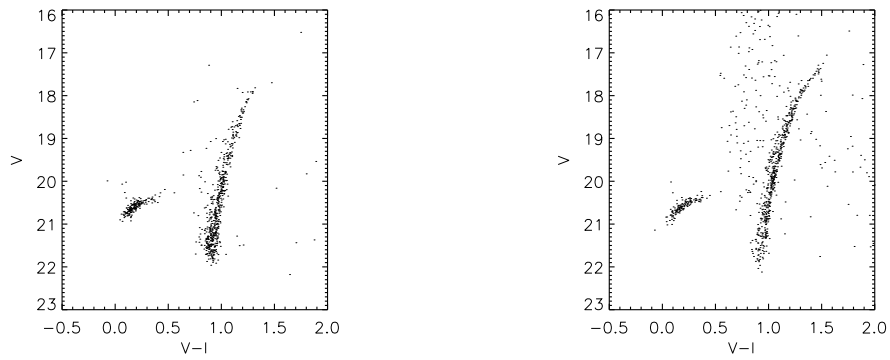

Fig. 20.— Observed color magnitude diagrams for NGC 2419 from Saha (2005) (left) and Stetson (2002) (right)

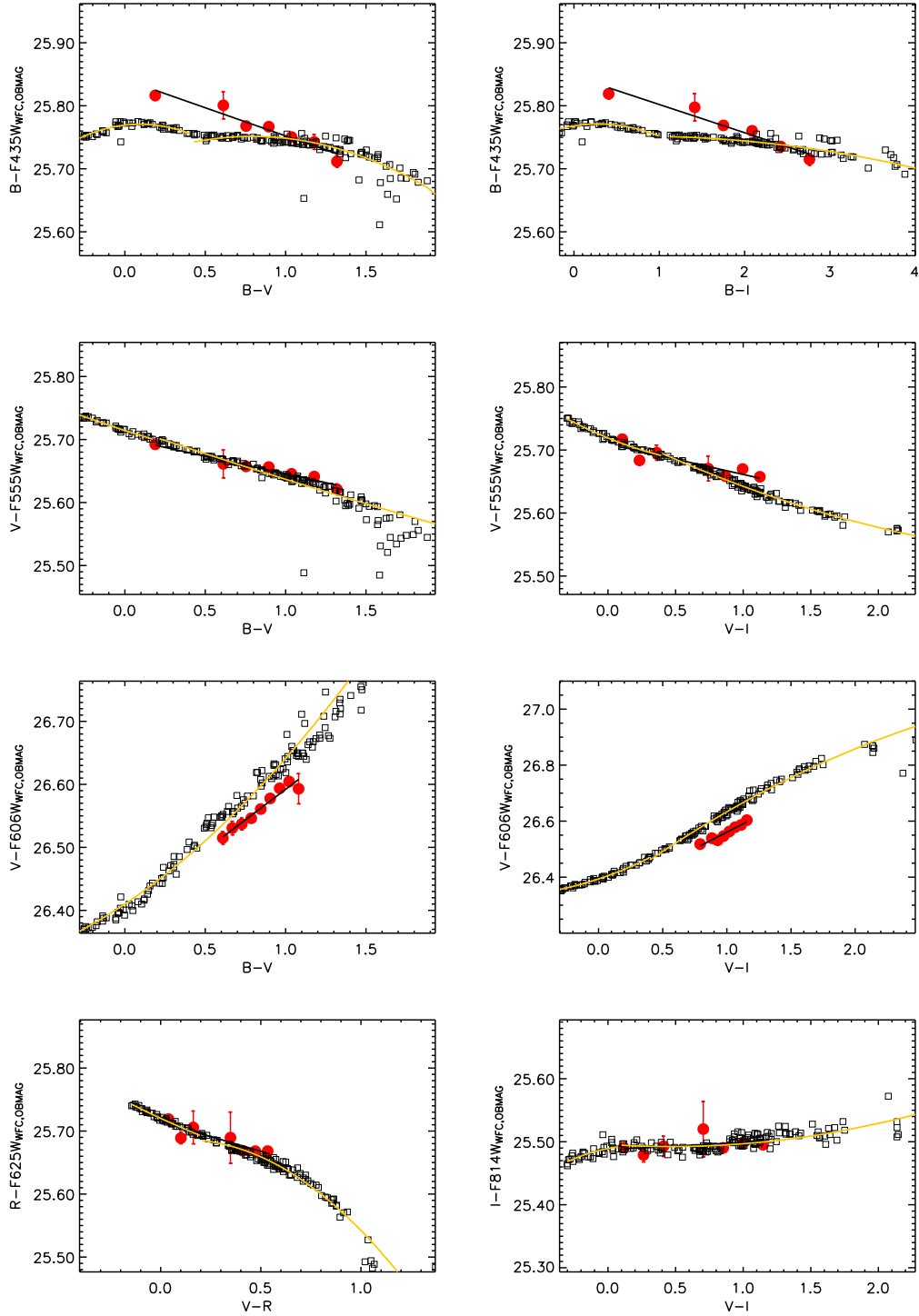

Fig. 21.— Observed and synthetic WFC-to-BVRI transformations for primary photometric filters. Squares show the synthetic measurements for the BPGS atlas. The circles are observational data (filled for NGC 104, open for NGC 2419). The black line shows the linear fit to the observational points, the light curve shows the synthetic transformations.

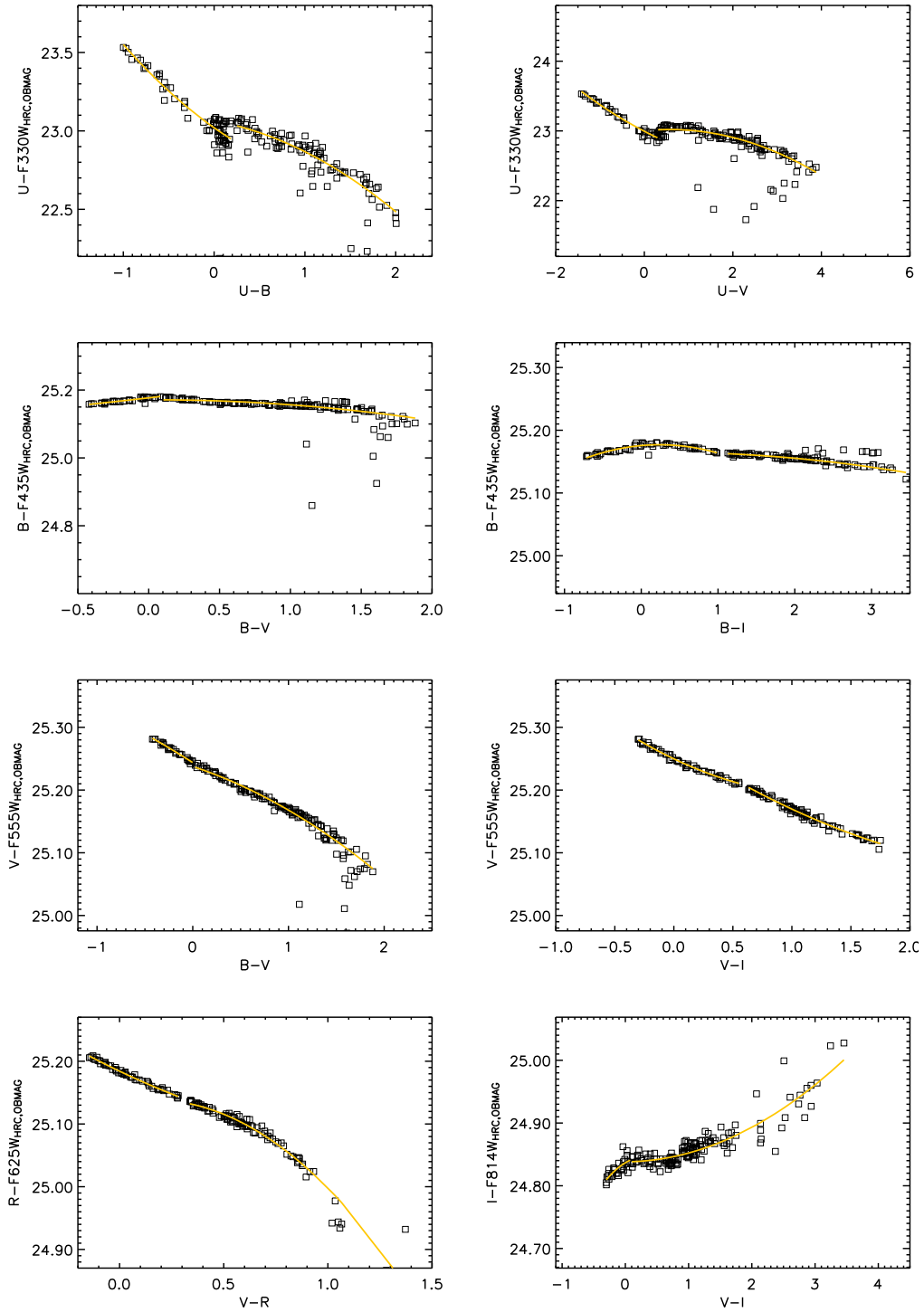

Fig. 22.— Observed and synthetic HRC-to-UBVRI transformations for primary photometric filters. Squares show the synthetic measurements for the BPGS atlas. The circles are observational data (filled for NGC 104, open for NGC 2419). The black line shows the linear fit to the observational points, the light curve shows the synthetic transformations.

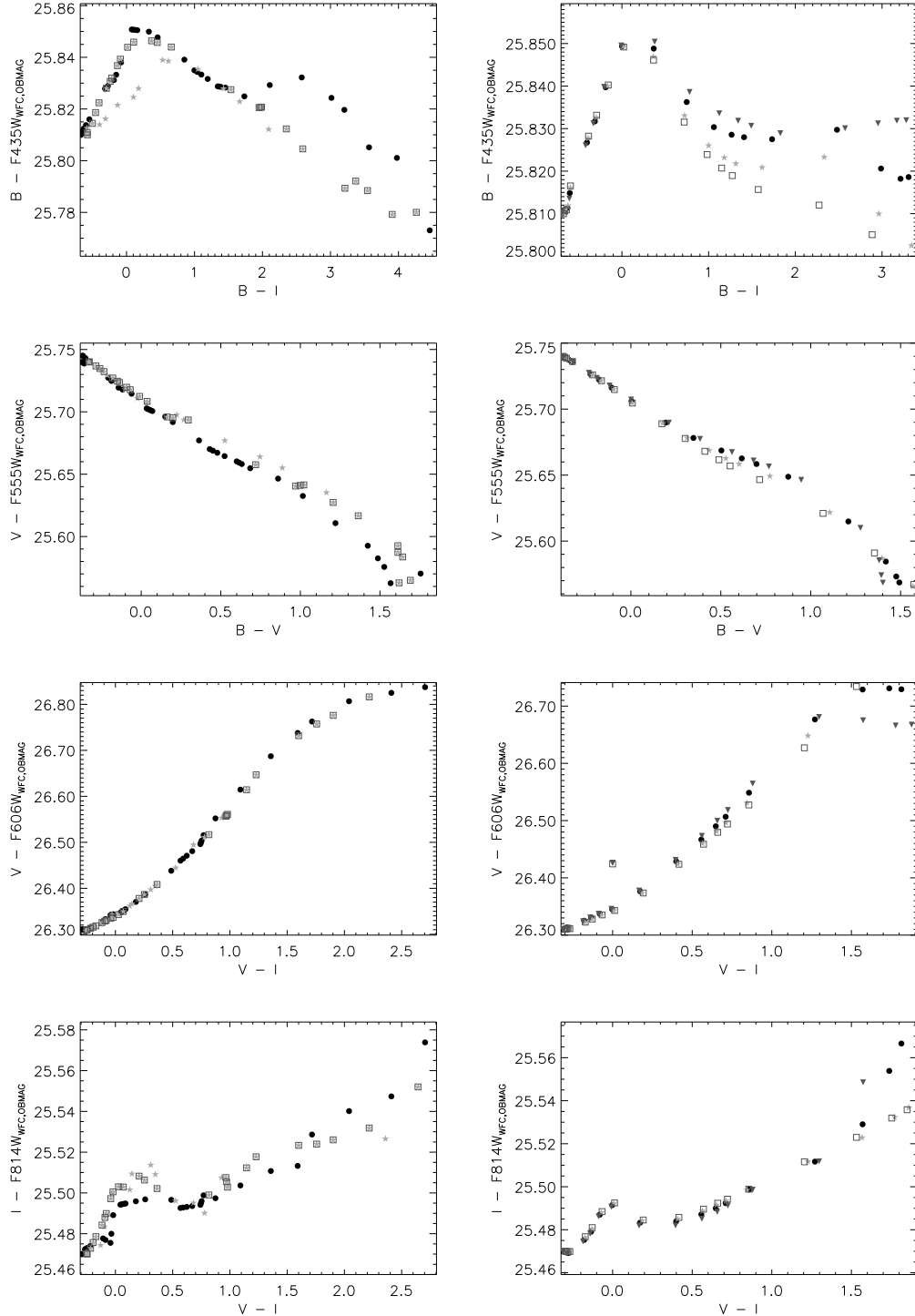

Fig. 23.— Effect of surface gravity (left) and metallicity (right) on synthetic transformation WFC-to-BVRI for a few primary photometric filters. Left: black circles are for main-sequence stars, gray stars and boxes are for giants and supergiants, respectively (all from BZ77). Right: Black circles are for MS stars with solar metallicity, filled triangles are $[\text{Fe}/\text{H}] = 0.5$, gray-filled stars are $[\text{Fe}/\text{H}] = -1$ and squares are $[\text{Fe}/\text{H}] = -2$ (all from Kurucz).

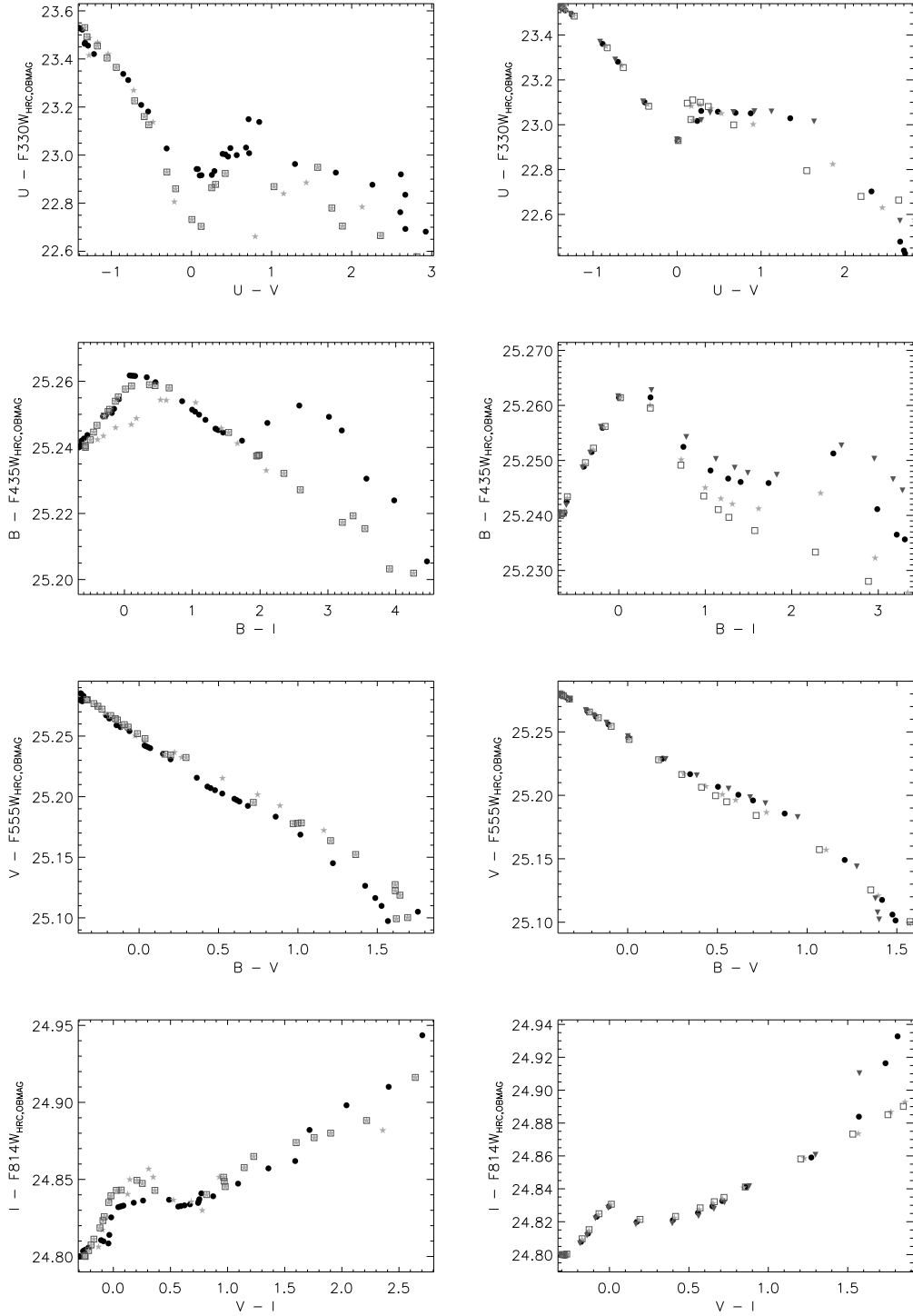

Fig. 24.— Effect of surface gravity (left) and metallicity (right) on synthetic transformation HRC-to-UBVRI for a few primary photometric filters. Left: black circles are for main-sequence stars, gray stars and boxes are for giants and supergiants, respectively (all from BZ77). Right: Black circles are for MS stars with solar metallicity, filled triangles are $[Fe/H] = 0.5$, gray-filled stars are $[Fe/H] = -1$ and squares are $[Fe/H] = -2$ (all from Kurucz).

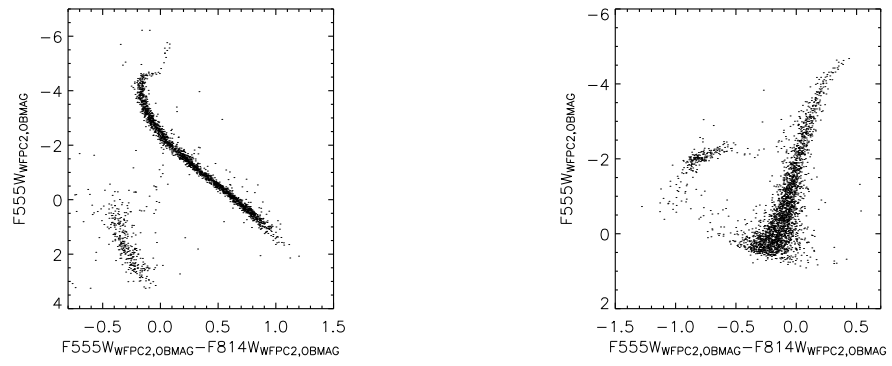

Fig. 25.— Observed WFPC2 Color Magnitude Diagrams for NGC 104 (left) and NGC 2419 (right).

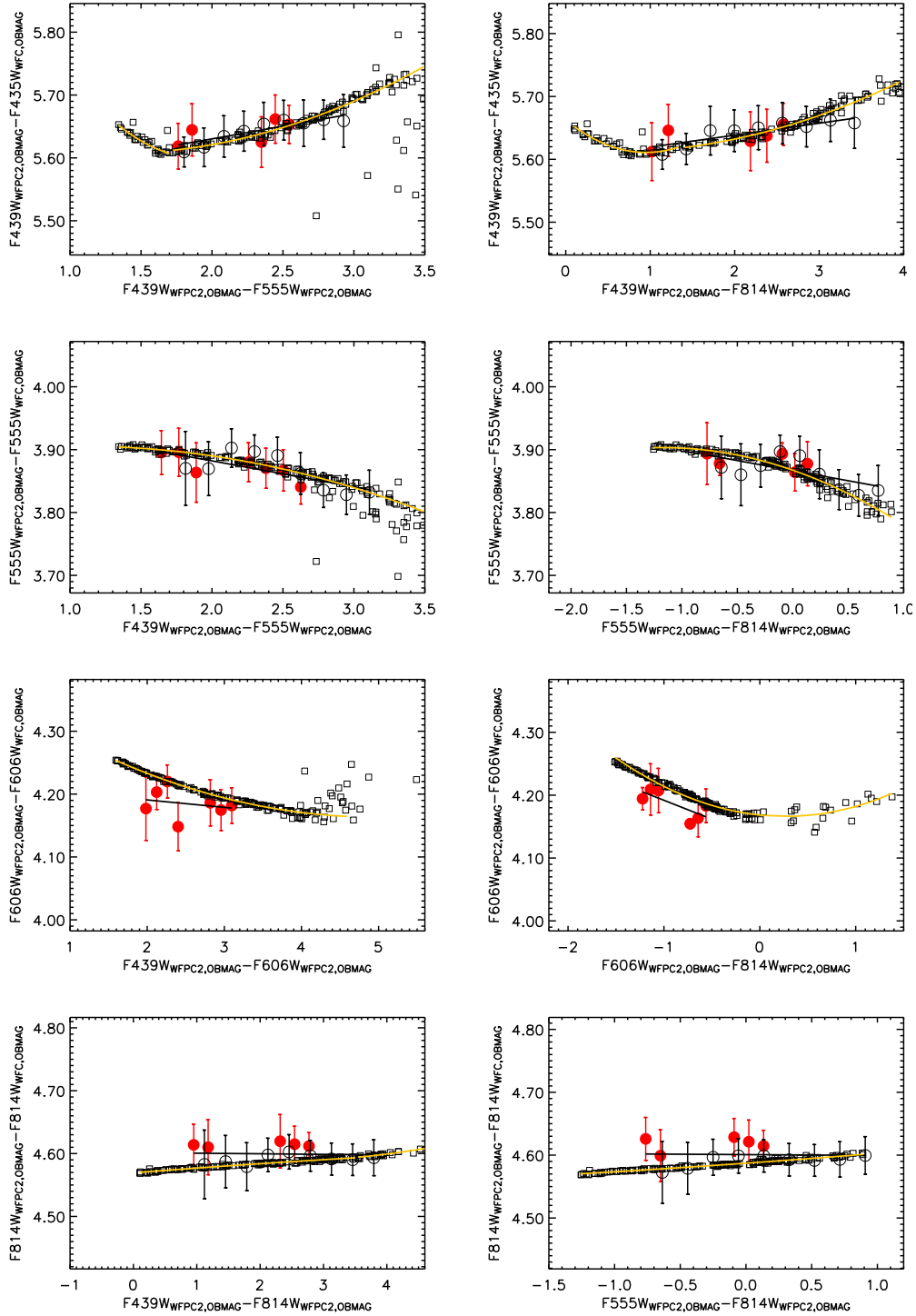

Fig. 26.— Observed and synthetic WFC-to-WFPC2 transformations for primary photometric filters. Squares show the synthetic measurements for the BPGS atlas. The circles are observational data (filled for NGC 104, open for NGC 2419). The black line shows the linear fit to the observational points, the light curve shows the synthetic transformations.

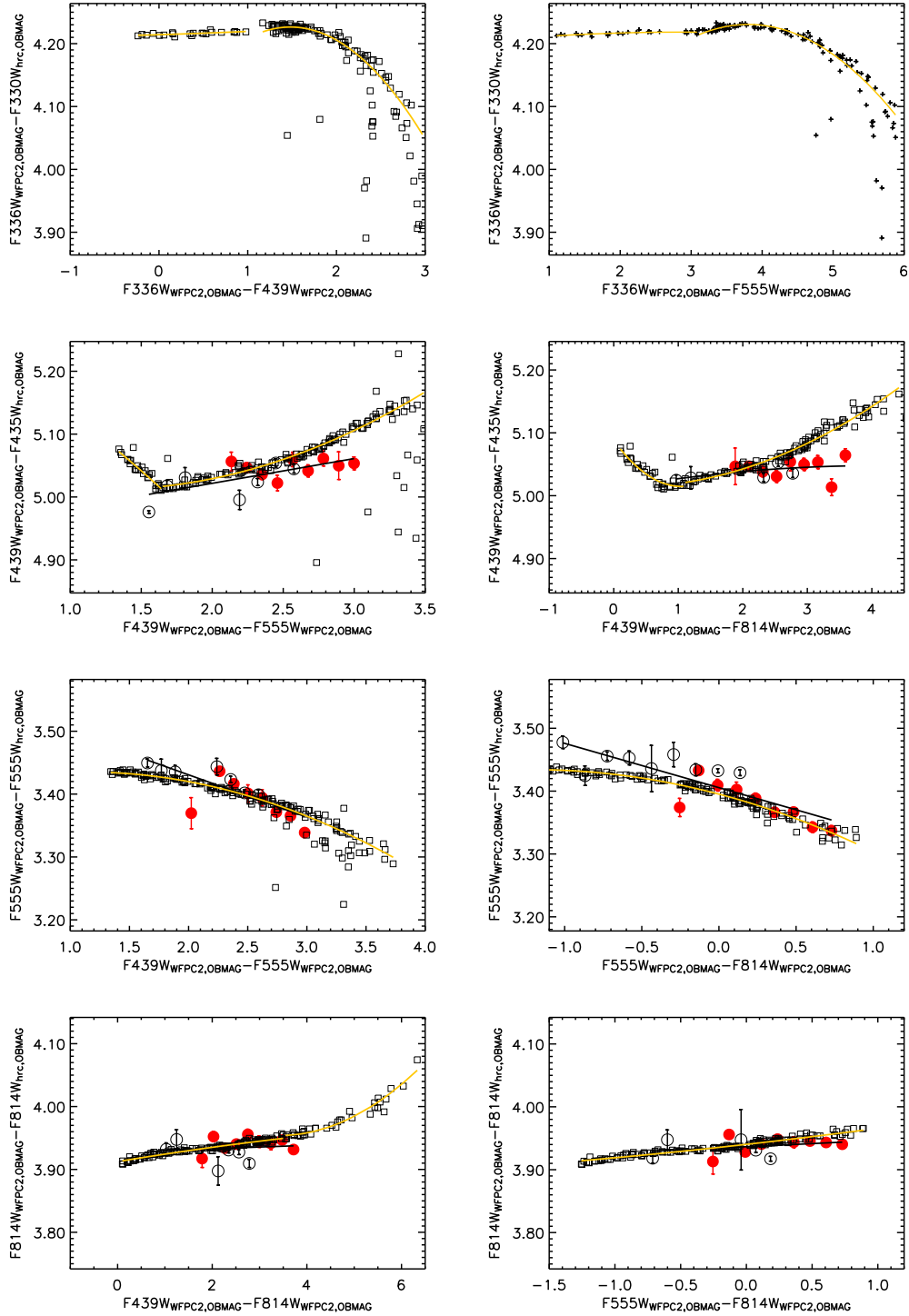

Fig. 27.— Observed and synthetic HRC-to-WFPC2 transformations for primary photometric filters. Squares show the synthetic measurements for the BPGS atlas. The circles are observational data (filled for NGC 104, open for NGC 2419). The black line shows the linear fit to the observational points, the light curve shows the synthetic transformations.

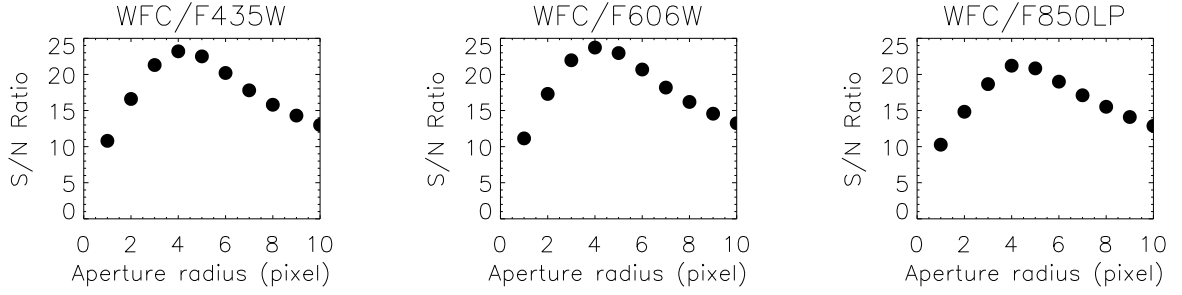

Fig. 28.— S/N ratio as a function of the size of the photometric aperture for three filters in the WFC. A star which produces 1000 electrons in the nominal infinite aperture and a background of 10 electrons have been assumed for this test.

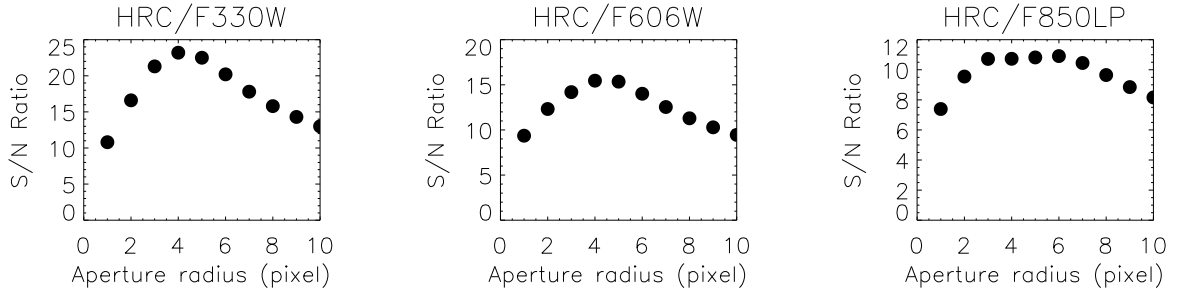

Fig. 29.— Same as Fig. 28 but for the HRC.

Table 1. WFC Filters

FILTER	PIVOT λ (\AA)	WIDTH (\AA)	PHOTFLAM ¹ ($\text{erg s}^{-1} \text{cm}^{-2} \text{\AA}^{-1}$)	DESCRIPTION
F435W	4317.398	293.47	3.141250E-19	Johnson B
F475W	4744.356	420.11	1.808802E-19	SDSS g'
F502N	5022.475	41.89	5.326231E-18	[OIII]
F550M	5581.205	163.27	3.860100E-19	Narrow V
F555W	5359.547	360.02	1.955929E-19	Johnson V
F606W	5917.678	672.31	7.906457E-20	Broad V
F625W	6310.454	415.46	1.195394E-19	SDSS r'
F658N	6584.015	37.15	1.999181E-18	H α
F660N	6599.374	35.53	5.347431E-18	[NII]
F775W	7693.026	434.60	1.006545E-19	SDSS i'
F814W	8059.761	654.64	7.072360E-20	Broad I
F850LP	9054.768	539.43	1.507456E-19	SDSS z'
F892N	8914.875	72.95	1.542548E-18	Methane

¹Flux density per unit wavelength that generates 1 count/sec

Table 2. HRC Filters

FILTER	PIVOT λ (\AA)	WIDTH (\AA)	PHOTFLAM ¹ ($\text{erg s}^{-1} \text{cm}^{-2} \text{\AA}^{-1}$)	DESCRIPTION
F220W	2255.426	187.28	8.113312E-18	Near-UV broadband
F250W	2715.875	239.40	4.781345E-18	Near-UV broadband
F330W	3362.675	173.82	2.236720E-18	HRC U
F344N	3432.847	42.62	2.139635E-17	Ne V
F435W	4310.986	309.68	5.368556E-19	Johnson B
F475W	4775.740	418.81	2.937020E-19	SDSS g'
F502N	5021.072	83.01	8.034045E-18	[OIII]
F550M	5579.729	168.05	5.985392E-19	Narrow V
F555W	5355.946	357.19	3.020066E-19	Johnson V
F606W	5887.935	664.88	1.278104E-19	Broad V
F625W	6295.498	415.31	1.973001E-19	SDSS r'
F658N	6581.980	162.69	3.357119E-18	H α
F660N	6582.439	468.30	8.976461E-18	[NII]
F775W	7665.083	432.03	1.949664E-19	SDSS i'
F814W	8115.338	703.45	1.269102E-19	Broad I
F850LP	9145.236	538.95	2.286987E-19	SDSS z'
F892N	8913.882	270.92	2.447032E-18	Methane

¹Flux density per unit wavelength that generates 1 count/sec

Table 3. Encircled Energy - WFC

Aperture radius pixel	"	F435W 4323.36 ^a	F475W 4725.23	F555W 5342.00	F606W 5834.71	F625W 6273.77	F775W 7662.67	F814W 7992.32	F850LP 9013.50	F892N 8914.36
1	0.05	0.289±0.011	0.318±0.006	0.311±0.005	0.313±0.003	0.312±0.004	0.296±0.001	0.293±0.009	0.246±0.004	0.241±0.002
2	0.10	0.626±0.011	0.669±0.006	0.662±0.003	0.656±0.005	0.648±0.004	0.623±0.005	0.603±0.006	0.538±0.001	0.546±0.007
3	0.15	0.775±0.004	0.801±0.003	0.795±0.002	0.796±0.003	0.795±0.002	0.780±0.003	0.764±0.004	0.689±0.003	0.711±0.007
4	0.20	0.832±0.002	0.850±0.002	0.843±0.001	0.845±0.001	0.844±0.000	0.840±0.001	0.833±0.002	0.779±0.002	0.802±0.004
5	0.25	0.859±0.000	0.876±0.002	0.871±0.001	0.871±0.000	0.868±0.001	0.863±0.001	0.858±0.001	0.815±0.000	0.835±0.001
6	0.30	0.875±0.000	0.890±0.002	0.891±0.000	0.890±0.001	0.888±0.000	0.882±0.001	0.879±0.000	0.837±0.001	0.858±0.000
7	0.35	0.884±0.001	0.900±0.002	0.899±0.001	0.900±0.000	0.899±0.000	0.899±0.001	0.895±0.001	0.858±0.001	0.878±0.000
8	0.40	0.892±0.001	0.907±0.002	0.908±0.000	0.908±0.001	0.907±0.000	0.909±0.001	0.907±0.001	0.877±0.001	0.895±0.000
9	0.45	0.900±0.000	0.914±0.002	0.915±0.000	0.914±0.000	0.914±0.000	0.914±0.001	0.914±0.001	0.889±0.001	0.906±0.000
10	0.50	0.906±0.000	0.920±0.002	0.920±0.000	0.920±0.000	0.920±0.000	0.921±0.001	0.920±0.001	0.897±0.001	0.912±0.000
11	0.55	0.912±0.000	0.925±0.002	0.924±0.001	0.925±0.000	0.924±0.000	0.926±0.001	0.926±0.001	0.905±0.001	0.917±0.000
12	0.60	0.916±0.001	0.930±0.002	0.929±0.001	0.929±0.000	0.929±0.000	0.931±0.001	0.931±0.001	0.912±0.001	0.923±0.000
13	0.65	0.920±0.001	0.934±0.002	0.933±0.001	0.933±0.000	0.933±0.000	0.935±0.001	0.935±0.001	0.918±0.001	0.927±0.000
14	0.70	0.923±0.001	0.937±0.002	0.935±0.001	0.938±0.000	0.937±0.000	0.939±0.001	0.939±0.001	0.923±0.001	0.930±0.000
15	0.75	0.926±0.001	0.940±0.002	0.938±0.001	0.941±0.000	0.940±0.000	0.942±0.001	0.942±0.001	0.927±0.001	0.934±0.000
16	0.80	0.929±0.001	0.943±0.002	0.940±0.001	0.944±0.000	0.943±0.000	0.945±0.001	0.945±0.001	0.932±0.001	0.937±0.000
17	0.85	0.931±0.001	0.945±0.002	0.942±0.001	0.946±0.000	0.946±0.000	0.948±0.001	0.948±0.001	0.936±0.001	0.940±0.000
18	0.90	0.934±0.001	0.948±0.002	0.944±0.001	0.948±0.000	0.948±0.000	0.950±0.001	0.951±0.001	0.940±0.001	0.943±0.000
19	0.95	0.937±0.001	0.950±0.002	0.946±0.001	0.950±0.000	0.950±0.000	0.953±0.001	0.953±0.001	0.943±0.001	0.945±0.000
20	1.00	0.940±0.001	0.952±0.002	0.948±0.001	0.952±0.000	0.952±0.000	0.955±0.001	0.955±0.001	0.946±0.001	0.947±0.000
25	1.25	0.952±0.001	0.968±0.000	0.957±0.001	0.960±0.000	0.959±0.000	0.962±0.001	0.962±0.000	0.958±0.001	0.957±0.000
30	1.50	0.964±0.001	0.974±0.002	0.965±0.001	0.967±0.000	0.965±0.000	0.967±0.001	0.968±0.001	0.965±0.001	0.963±0.001
35	1.75	0.973±0.001	0.983±0.002	0.973±0.001	0.974±0.000	0.972±0.000	0.972±0.001	0.973±0.001	0.970±0.001	0.968±0.001
40	2.00	0.980±0.001	0.989±0.002	0.980±0.001	0.981±0.000	0.977±0.000	0.977±0.001	0.976±0.000	0.974±0.001	0.972±0.001
45	2.25	0.983±0.001	0.994±0.002	0.985±0.001	0.987±0.001	0.982±0.000	0.980±0.001	0.980±0.001	0.978±0.001	0.976±0.001
50	2.50	0.986±0.001	0.997±0.002	0.989±0.001	0.991±0.001	0.986±0.000	0.985±0.001	0.982±0.000	0.982±0.001	0.979±0.001
55	2.75	0.991±0.001	0.998±0.002	0.991±0.001	0.994±0.001	0.989±0.000	0.988±0.001	0.987±0.001	0.985±0.001	0.982±0.001
60	3.00	0.993±0.001	1.000±0.002	0.993±0.001	0.995±0.001	0.991±0.000	0.990±0.001	0.990±0.001	0.988±0.001	0.984±0.001
65	3.25	0.995±0.001	1.001±0.001	0.995±0.001	0.996±0.001	0.994±0.000	0.993±0.000	0.991±0.001	0.991±0.001	0.986±0.001
70	3.50	0.995±0.001	1.001±0.001	0.996±0.001	0.997±0.001	0.997±0.001	0.995±0.000	0.994±0.000	0.994±0.001	0.989±0.001
75	3.75	0.997±0.000	1.003±0.001	0.996±0.001	0.999±0.001	0.997±0.001	0.995±0.000	0.996±0.001	0.996±0.001	0.989±0.000
80	4.00	0.997±0.001	1.002±0.001	0.998±0.001	0.998±0.001	0.998±0.001	0.998±0.001	0.997±0.001	0.997±0.001	0.992±0.000
85	4.25	0.999±0.000	1.002±0.001	1.000±0.000	0.999±0.001	0.999±0.001	0.999±0.001	0.999±0.001	0.997±0.000	0.993±0.000
90	4.50	1.000±0.000	1.002±0.001	0.999±0.001	1.000±0.001	1.000±0.001	1.000±0.001	0.999±0.001	1.000±0.001	0.995±0.000
95	4.75	1.000±0.001	1.001±0.001	1.000±0.001	1.000±0.001	1.000±0.001	1.000±0.001	1.000±0.001	1.001±0.000	0.997±0.001
100	5.00	0.999±0.000	1.001±0.001	1.001±0.000	1.001±0.001	1.001±0.001	1.001±0.000	1.000±0.001	1.001±0.000	0.997±0.000
110	5.50	1.000±0.000	1.000±0.000	1.000±0.000	1.000±0.000	1.000±0.000	1.000±0.000	1.000±0.000	1.000±0.000	1.000±0.000

^a Average effective wavelength (Å) for the two spectrophotometric standard stars, both white dwarves

Table 4. Encircled Energy - HRC

Aperture radius pixel	"	F220W 2244.64 ^a	F250W 2702.15	F330W 3356.23	F435W 4317.55	F475W 4756.77	F555W 5338.72	F606W 5806.35	F625W 6258.62	F775W 7634.95	F814W 8037.84	F850LP 9104.70	F892N 8910.36
1	0.025	0.235±0.014	0.245±0.013	0.250±0.011	0.254±0.005	0.230±0.005	0.222±0.002	0.221±0.006	0.208±0.003	0.171±0.004	0.158±0.002	0.109±0.003	0.118±0.001
2	0.050	0.506±0.010	0.534±0.010	0.542±0.008	0.532±0.003	0.523±0.006	0.514±0.003	0.505±0.004	0.490±0.003	0.433±0.001	0.403±0.008	0.294±0.006	0.324±0.003
3	0.075	0.623±0.007	0.655±0.006	0.679±0.005	0.687±0.005	0.678±0.002	0.656±0.003	0.640±0.003	0.620±0.003	0.560±0.001	0.534±0.001	0.413±0.008	0.453±0.002
4	0.100	0.686±0.007	0.720±0.003	0.736±0.004	0.762±0.003	0.764±0.001	0.759±0.002	0.742±0.004	0.723±0.003	0.632±0.002	0.599±0.001	0.465±0.007	0.498±0.005
5	0.125	0.733±0.001	0.762±0.002	0.775±0.002	0.791±0.001	0.796±0.001	0.803±0.001	0.799±0.002	0.795±0.002	0.723±0.002	0.683±0.001	0.526±0.007	0.561±0.005
6	0.150	0.758±0.002	0.788±0.001	0.805±0.000	0.813±0.001	0.813±0.002	0.818±0.002	0.818±0.002	0.816±0.003	0.779±0.002	0.742±0.000	0.592±0.008	0.631±0.006
7	0.175	0.771±0.001	0.803±0.001	0.825±0.002	0.837±0.001	0.833±0.002	0.835±0.001	0.832±0.001	0.829±0.002	0.798±0.001	0.766±0.001	0.634±0.007	0.669±0.006
8	0.200	0.782±0.002	0.814±0.001	0.837±0.003	0.858±0.000	0.853±0.003	0.852±0.001	0.847±0.001	0.842±0.001	0.805±0.002	0.775±0.001	0.654±0.005	0.683±0.006
9	0.225	0.791±0.002	0.823±0.001	0.846±0.003	0.870±0.001	0.868±0.003	0.869±0.001	0.863±0.001	0.855±0.001	0.814±0.002	0.782±0.002	0.665±0.005	0.691±0.006
10	0.250	0.801±0.002	0.830±0.002	0.853±0.003	0.875±0.002	0.877±0.003	0.883±0.001	0.876±0.001	0.869±0.001	0.824±0.001	0.790±0.002	0.674±0.005	0.697±0.006
11	0.275	0.811±0.002	0.837±0.002	0.858±0.003	0.881±0.002	0.883±0.003	0.890±0.000	0.887±0.001	0.882±0.001	0.832±0.001	0.799±0.002	0.683±0.004	0.705±0.006
12	0.300	0.821±0.002	0.844±0.002	0.863±0.003	0.887±0.001	0.888±0.003	0.896±0.001	0.894±0.001	0.891±0.001	0.844±0.001	0.809±0.002	0.692±0.004	0.713±0.006
13	0.325	0.829±0.002	0.852±0.002	0.868±0.003	0.892±0.001	0.893±0.003	0.900±0.001	0.899±0.002	0.897±0.001	0.855±0.002	0.819±0.002	0.700±0.004	0.720±0.006
14	0.350	0.836±0.002	0.859±0.002	0.873±0.003	0.895±0.001	0.897±0.003	0.904±0.001	0.903±0.002	0.900±0.001	0.863±0.001	0.828±0.002	0.709±0.004	0.728±0.006
15	0.375	0.842±0.002	0.865±0.002	0.878±0.003	0.899±0.001	0.900±0.003	0.908±0.001	0.906±0.002	0.903±0.001	0.870±0.001	0.835±0.002	0.720±0.004	0.739±0.006
16	0.400	0.848±0.002	0.869±0.002	0.883±0.003	0.902±0.001	0.903±0.003	0.912±0.001	0.909±0.002	0.907±0.001	0.873±0.001	0.840±0.001	0.728±0.004	0.748±0.006
17	0.425	0.854±0.002	0.874±0.002	0.888±0.003	0.905±0.001	0.906±0.003	0.914±0.001	0.912±0.001	0.910±0.001	0.877±0.001	0.843±0.001	0.735±0.004	0.753±0.006
18	0.450	0.859±0.002	0.878±0.002	0.892±0.003	0.908±0.001	0.909±0.003	0.917±0.001	0.915±0.001	0.914±0.001	0.879±0.001	0.847±0.001	0.740±0.004	0.756±0.006
19	0.475	0.865±0.002	0.882±0.002	0.895±0.003	0.911±0.001	0.912±0.003	0.919±0.001	0.918±0.001	0.916±0.001	0.882±0.001	0.850±0.001	0.745±0.004	0.760±0.006
20	0.500	0.870±0.002	0.886±0.002	0.898±0.003	0.915±0.001	0.915±0.003	0.922±0.001	0.920±0.001	0.919±0.001	0.886±0.001	0.853±0.001	0.749±0.004	0.764±0.006
25	0.625	0.895±0.002	0.904±0.002	0.910±0.003	0.927±0.001	0.928±0.003	0.934±0.001	0.932±0.001	0.929±0.001	0.899±0.001	0.868±0.001	0.771±0.004	0.784±0.006
30	0.750	0.919±0.002	0.921±0.002	0.921±0.003	0.934±0.001	0.935±0.003	0.943±0.001	0.941±0.002	0.939±0.001	0.910±0.001	0.881±0.001	0.789±0.004	0.801±0.006
35	0.875	0.939±0.002	0.936±0.001	0.932±0.003	0.941±0.001	0.941±0.003	0.948±0.001	0.948±0.002	0.946±0.001	0.920±0.001	0.892±0.001	0.807±0.003	0.818±0.006
40	1.000	0.952±0.002	0.951±0.001	0.942±0.003	0.948±0.001	0.947±0.003	0.953±0.001	0.952±0.002	0.950±0.001	0.929±0.001	0.903±0.001	0.823±0.003	0.831±0.006
45	1.125	0.961±0.002	0.962±0.001	0.952±0.003	0.954±0.001	0.953±0.003	0.957±0.001	0.957±0.002	0.954±0.001	0.935±0.001	0.911±0.001	0.842±0.001	0.846±0.006
50	1.250	0.967±0.002	0.969±0.001	0.961±0.003	0.960±0.001	0.958±0.003	0.962±0.001	0.961±0.002	0.958±0.001	0.940±0.001	0.918±0.001	0.855±0.001	0.858±0.006
55	1.375	0.971±0.002	0.975±0.002	0.968±0.003	0.964±0.001	0.963±0.003	0.966±0.001	0.964±0.001	0.961±0.001	0.945±0.001	0.925±0.001	0.867±0.001	0.869±0.005
60	1.500	0.975±0.002	0.979±0.002	0.973±0.002	0.970±0.001	0.968±0.003	0.969±0.001	0.968±0.001	0.965±0.001	0.950±0.001	0.931±0.001	0.878±0.001	0.879±0.005
65	1.625	0.977±0.002	0.982±0.002	0.977±0.003	0.975±0.001	0.972±0.003	0.973±0.001	0.972±0.001	0.968±0.001	0.954±0.001	0.936±0.001	0.888±0.001	0.888±0.005
70	1.750	0.980±0.002	0.984±0.002	0.980±0.002	0.979±0.001	0.976±0.003	0.977±0.001	0.975±0.001	0.971±0.001	0.958±0.001	0.942±0.001	0.897±0.000	0.897±0.005
75	1.875	0.981±0.002	0.986±0.002	0.984±0.002	0.982±0.001	0.979±0.003	0.980±0.001	0.978±0.001	0.974±0.001	0.962±0.001	0.947±0.001	0.906±0.000	0.905±0.005
80	2.000	0.983±0.002	0.988±0.002	0.984±0.002	0.984±0.002	0.982±0.003	0.983±0.001	0.981±0.001	0.976±0.001	0.966±0.001	0.952±0.001	0.915±0.000	0.913±0.005
85	2.125	0.985±0.002	0.989±0.002	0.987±0.002	0.986±0.001	0.985±0.003	0.986±0.001	0.984±0.001	0.979±0.001	0.969±0.001	0.957±0.001	0.923±0.001	0.919±0.004
90	2.250	0.987±0.002	0.990±0.002	0.988±0.002	0.988±0.001	0.987±0.003	0.989±0.000	0.986±0.001	0.981±0.001	0.972±0.001	0.961±0.001	0.930±0.001	0.926±0.004
95	2.375	0.988±0.002	0.991±0.002	0.989±0.002	0.989±0.001	0.988±0.003	0.991±0.000	0.988±0.001	0.984±0.001	0.974±0.001	0.964±0.000	0.937±0.001	0.932±0.004
100	2.500	0.989±0.002	0.992±0.002	0.990±0.002	0.990±0.001	0.990±0.003	0.992±0.000	0.990±0.001	0.985±0.001	0.977±0.001	0.968±0.001	0.943±0.001	0.938±0.004
110	2.750	0.991±0.002	0.993±0.002	0.992±0.002	0.992±0.001	0.992±0.002	0.995±0.000	0.993±0.001	0.989±0.001	0.982±0.001	0.974±0.000	0.952±0.001	0.948±0.004
120	3.000	0.993±0.001	0.995±0.002	0.994±0.001	0.993±0.001	0.994±0.002	0.997±0.000	0.995±0.001	0.991±0.001	0.987±0.000	0.980±0.001	0.962±0.001	0.957±0.004
130	3.250	0.995±0.001	0.996±0.002	0.995±0.001	0.993±0.000	0.995±0.002	0.999±0.000	0.996±0.001	0.993±0.001	0.991±0.000	0.984±0.000	0.970±0.001	0.964±0.004
140	3.500	0.996±0.001	0.996±0.001	0.996±0.001	0.995±0.000	0.997±0.002	1.000±0.000	0.997±0.001	0.995±0.001	0.993±0.000	0.988±0.001	0.977±0.001	0.970±0.004
150	3.750	0.997±0.001	0.997±0.001	0.996±0.001	0.997±0.001	0.998±0.002	0.999±0.001	0.998±0.001	0.996±0.001	0.994±0.001	0.991±0.000	0.982±0.001	0.976±0.003
160	4.000	0.998±0.001	0.997±0.001	0.997±0.001	0.998±0.000	0.998±0.001	0.999±0.001	0.998±0.001	0.997±0.001	0.996±0.001	0.993±0.000	0.987±0.001	0.981±0.002
170	4.250	0.998±0.001	0.999±0.001	0.998±0.001	0.998±0.000	0.998±0.001	1.000±0.000	0.999±0.000	0.997±0.001	0.996±0.000	0.995±0.000	0.990±0.001	0.985±0.002
180	4.500	0.999±0.001	0.999±0.001	0.998±0.000	0.998±0.000	0.998±0.001	0.999±0.001	0.999±0.000	0.998±0.001	0.997±0.000	0.996±0.000	0.994±0.001	0.988±0.002
190	4.750	0.998±0.000	0.999±0.000	0.998±0.000	0.999±0.001	0.999±0.001	1.000±0.000	0.999±0.000	0.998±0.001	0.998±0.000	0.997±0.000	0.996±0.001	0.992±0.002
200	5.000	0.999±0.001	0.999±0.001	0.999±0.001	1.000±0.000	0.999±0.000	1.000±0.000	1.000±0.000	0.999±0.001	0.999±0.000	0.999±0.000	0.998±0.001	0.996±0.001
210	5.250	1.000±0.000	1.000±0.000	1.000±0.000	1.000±0.000	1.000±0.000	1.000±0.000	1.000±0.000	0.999±0.000	1.000±0.000	1.000±0.000	0.999±0.000	0.998±0.000
220	5.500	1.000±0.000	1.000±0.000	1.000±0.000	1.000±0.000	1.000±0.000	1.000±0.000	1.000±0.000	1.000±0.000	1.000±0.000	1.000±0.000	1.000±0.000	1.000±0.000

^aAverage effective wavelength (Å) for the two spectrophotometric standard stars, both white dwarves

Table 5. Aperture Correction from $0''.5$ Aperture Radius to Infinite (AC05)

FILTER	HRC		WFC	
	mag	err	mag	err
F220W	0.151	0.002
F250W	0.132	0.002
F330W	0.117	0.003
F334N	0.113	0.004
F435W	0.097	0.001	0.107	0.004
F475W	0.096	0.004	0.095	0.002
F502N	0.093	0.001	0.094	0.001
F550M	0.092	0.001	0.083	0.001
F555W	0.088	0.001	0.092	0.001
F606W	0.090	0.002	0.088	0.000
F625W	0.092	0.001	0.088	0.001
F658N	0.098	0.001	0.085	0.003
F660N	0.110	0.001	0.090	0.003
F775W	0.132	0.001	0.087	0.001
F814W	0.172	0.002	0.087	0.001
F850LP	0.314	0.006	0.117	0.000
F892N	0.293	0.009	0.100	0.002

OBMAG=-2.5 log(count rate $r \leq 0''.5$ [e^-/s]) - AC05

Table 6. WFC - Effective Wavelength Aperture Correction Relation

Effective Wavelength ^a Å	Aperture radius											
	0.10"	0.15"	0.20"	0.25"	0.30"	0.40"	0.50"	0.60"	0.80"	1.00"	1.50"	2.00"
3500	0.651	0.351	0.246	0.208	0.184	0.162	0.140	0.129	0.113	0.096	0.061	0.044
3750	0.610	0.328	0.233	0.195	0.173	0.152	0.130	0.119	0.104	0.088	0.056	0.038
4000	0.566	0.306	0.218	0.182	0.161	0.140	0.120	0.108	0.093	0.080	0.049	0.031
4250	0.521	0.284	0.204	0.169	0.149	0.128	0.110	0.099	0.083	0.071	0.042	0.024
4500	0.481	0.265	0.192	0.157	0.139	0.117	0.101	0.089	0.074	0.063	0.036	0.019
4750	0.454	0.251	0.183	0.151	0.131	0.111	0.095	0.083	0.069	0.057	0.034	0.016
5000	0.443	0.244	0.182	0.147	0.129	0.107	0.093	0.081	0.067	0.056	0.035	0.018
5250	0.446	0.242	0.182	0.145	0.127	0.105	0.091	0.079	0.065	0.055	0.035	0.019
5500	0.451	0.243	0.183	0.146	0.125	0.104	0.088	0.078	0.063	0.053	0.034	0.019
5750	0.458	0.244	0.183	0.147	0.125	0.102	0.088	0.076	0.061	0.051	0.034	0.019
6000	0.461	0.247	0.183	0.151	0.127	0.105	0.089	0.079	0.063	0.052	0.035	0.021
6250	0.461	0.245	0.183	0.151	0.128	0.105	0.089	0.079	0.063	0.053	0.038	0.024
6500	0.468	0.245	0.180	0.150	0.125	0.101	0.086	0.075	0.059	0.050	0.035	0.024
6750	0.474	0.250	0.182	0.152	0.128	0.102	0.087	0.076	0.060	0.051	0.036	0.025
7000	0.490	0.251	0.184	0.151	0.130	0.104	0.088	0.078	0.061	0.051	0.038	0.026
7250	0.507	0.252	0.188	0.151	0.134	0.104	0.089	0.078	0.061	0.051	0.038	0.026
7500	0.523	0.259	0.193	0.155	0.136	0.105	0.089	0.078	0.060	0.051	0.036	0.026
7750	0.533	0.274	0.197	0.162	0.139	0.106	0.091	0.078	0.061	0.050	0.036	0.026
8000	0.538	0.291	0.200	0.170	0.143	0.108	0.092	0.079	0.061	0.051	0.036	0.027
8250	0.549	0.308	0.205	0.177	0.147	0.111	0.094	0.081	0.064	0.052	0.038	0.027
8500	0.584	0.330	0.217	0.184	0.155	0.114	0.096	0.083	0.065	0.053	0.038	0.029
8750	0.639	0.364	0.238	0.196	0.168	0.122	0.101	0.087	0.068	0.056	0.039	0.029
9000	0.687	0.398	0.270	0.220	0.191	0.141	0.117	0.100	0.079	0.064	0.043	0.032
9250	0.768	0.477	0.328	0.277	0.237	0.180	0.149	0.128	0.099	0.080	0.052	0.038
9500	0.874	0.564	0.409	0.345	0.302	0.237	0.196	0.171	0.134	0.106	0.066	0.050
9750	0.989	0.673	0.505	0.431	0.384	0.308	0.257	0.229	0.180	0.140	0.083	0.065
10000	1.106	0.784	0.605	0.522	0.473	0.384	0.323	0.291	0.229	0.176	0.101	0.081
10250	1.224	0.896	0.704	0.613	0.558	0.461	0.387	0.351	0.278	0.213	0.118	0.096
10500	1.340	1.008	0.804	0.705	0.645	0.537	0.453	0.412	0.327	0.249	0.136	0.113
10750	1.454	1.120	0.904	0.796	0.733	0.612	0.517	0.473	0.376	0.285	0.154	0.129
11000	1.572	1.231	1.003	0.888	0.820	0.689	0.584	0.535	0.425	0.321	0.171	0.145

^aValues for $\lambda < 4300$ Å and $\lambda > 9800$ Å are extrapolated.

Table 7. HRC - Effective Wavelength Aperture Correction Relation

Effective Wavelength ^a Å	Aperture radius												
	0.075"	0.10"	0.125"	0.20"	0.25"	0.30"	0.40"	0.50"	0.60"	0.80"	1.00"	1.50"	2.00"
2000	0.544	0.438	0.359	0.289	0.261	0.231	0.193	0.161	0.134	0.081	0.052	0.031	0.021
2250	0.514	0.409	0.337	0.266	0.240	0.214	0.179	0.151	0.127	0.081	0.053	0.027	0.019
2500	0.489	0.384	0.317	0.244	0.221	0.198	0.165	0.141	0.120	0.082	0.055	0.026	0.016
2750	0.473	0.370	0.304	0.226	0.205	0.187	0.155	0.135	0.117	0.085	0.059	0.027	0.018
3000	0.457	0.358	0.294	0.212	0.192	0.176	0.146	0.128	0.113	0.086	0.063	0.029	0.019
3250	0.451	0.348	0.288	0.198	0.179	0.165	0.139	0.120	0.108	0.085	0.064	0.030	0.018
3500	0.442	0.333	0.279	0.187	0.167	0.155	0.131	0.113	0.102	0.081	0.064	0.030	0.016
3750	0.439	0.323	0.273	0.179	0.159	0.145	0.125	0.107	0.096	0.078	0.061	0.030	0.016
4000	0.425	0.311	0.265	0.173	0.152	0.139	0.119	0.102	0.091	0.075	0.060	0.031	0.016
4250	0.426	0.305	0.260	0.171	0.147	0.134	0.116	0.099	0.087	0.073	0.060	0.033	0.018
4500	0.425	0.299	0.255	0.170	0.144	0.130	0.112	0.098	0.085	0.071	0.059	0.034	0.019
4750	0.434	0.298	0.252	0.174	0.141	0.128	0.110	0.095	0.083	0.069	0.059	0.036	0.020
5000	0.439	0.295	0.246	0.175	0.138	0.125	0.106	0.093	0.081	0.066	0.057	0.035	0.020
5250	0.454	0.299	0.242	0.178	0.137	0.122	0.104	0.092	0.080	0.064	0.056	0.035	0.020
5500	0.468	0.308	0.240	0.178	0.139	0.120	0.102	0.091	0.080	0.063	0.055	0.035	0.021
5750	0.477	0.315	0.238	0.178	0.141	0.120	0.102	0.089	0.079	0.061	0.053	0.035	0.021
6000	0.493	0.330	0.242	0.180	0.145	0.122	0.104	0.089	0.079	0.063	0.053	0.035	0.022
6250	0.515	0.352	0.251	0.187	0.155	0.128	0.110	0.094	0.085	0.067	0.058	0.041	0.027
6500	0.535	0.373	0.262	0.194	0.164	0.135	0.116	0.100	0.089	0.072	0.061	0.045	0.032
6750	0.551	0.397	0.276	0.202	0.174	0.144	0.122	0.106	0.095	0.078	0.066	0.049	0.034
7000	0.565	0.417	0.291	0.208	0.181	0.152	0.127	0.111	0.100	0.081	0.068	0.049	0.034
7250	0.590	0.449	0.315	0.218	0.192	0.165	0.135	0.119	0.107	0.087	0.073	0.051	0.035
7500	0.609	0.478	0.336	0.229	0.204	0.178	0.144	0.128	0.114	0.094	0.079	0.055	0.038
7750	0.627	0.502	0.356	0.238	0.215	0.191	0.155	0.140	0.125	0.102	0.086	0.060	0.042
8000	0.665	0.542	0.397	0.263	0.240	0.217	0.178	0.161	0.145	0.120	0.101	0.071	0.050
8250	0.715	0.591	0.452	0.298	0.275	0.252	0.210	0.192	0.174	0.146	0.124	0.087	0.061
8500	0.769	0.645	0.510	0.339	0.315	0.291	0.245	0.226	0.206	0.175	0.150	0.105	0.072
8750	0.825	0.712	0.578	0.384	0.361	0.336	0.288	0.266	0.244	0.209	0.179	0.125	0.087
9000	0.902	0.786	0.653	0.433	0.407	0.380	0.327	0.301	0.277	0.237	0.204	0.140	0.096
9250	1.001	0.874	0.746	0.509	0.477	0.446	0.389	0.355	0.328	0.282	0.242	0.168	0.117
9500	1.141	1.011	0.885	0.637	0.600	0.566	0.502	0.463	0.430	0.372	0.323	0.231	0.164
9750	1.343	1.207	1.084	0.820	0.777	0.737	0.663	0.616	0.578	0.503	0.441	0.323	0.231
10000	1.554	1.414	1.291	1.014	0.963	0.916	0.834	0.779	0.735	0.643	0.567	0.420	0.304
10250	1.768	1.624	1.499	1.204	1.147	1.094	1.003	0.939	0.889	0.781	0.691	0.517	0.373
10500	1.992	1.838	1.711	1.390	1.325	1.265	1.165	1.094	1.036	0.911	0.811	0.607	0.440
10750	2.233	2.060	1.929	1.568	1.493	1.426	1.318	1.234	1.175	1.034	0.919	0.685	0.498
11000	2.498	2.284	2.156	1.737	1.647	1.572	1.454	1.359	1.296	1.140	1.011	0.746	0.544

^aValues for $\lambda > 9500$ Å are extrapolated.

Table 8. Effective Wavelength (\AA) for Stars of Different Spectral Types in the Near-IR

STAR TYPE	WFC			HRC		
	F775W	F814W	F850LP	F775W	F814W	F850LP
O5V	7659.4	7986.0	9012.0	7631.7	8030.7	9103.2
B0V	7663.0	7995.1	9017.6	7635.3	8041.7	9108.5
B5V	7672.4	8015.4	9028.7	7644.6	8064.7	9119.3
A0V	7678.4	8044.3	9056.2	7650.5	8099.1	9146.2
A5V	7688.1	8061.4	9062.7	7660.2	8118.2	9152.2
F2V	7703.7	8085.1	9064.7	7675.8	8144.3	9154.3
F6V	7707.8	8088.0	9069.8	7679.8	8147.5	9159.7
G0V	7713.6	8097.7	9074.9	7685.7	8158.3	9164.9
G5V	7714.9	8105.0	9082.6	7687.0	8167.2	9172.4
K0V	7717.3	8106.5	9077.1	7689.4	8168.4	9166.6
K5V	7743.9	8156.3	9093.1	7716.3	8223.8	9181.8
M0V	7767.2	8205.4	9120.2	7740.0	8279.7	9207.8
M6V	7837.3	8326.2	9166.2	7812.4	8412.7	9249.6
L3.5	8003.7	8669.6	9383.5	7980.4	8779.7	9445.2
T6.6	8133.6	8974.3	9772.9	8118.1	9045.6	9788.0

Table 9. Gain Correction

Nominal Gain	Amplifier	Gain (e^-/ADU)		Correction ^a
		old	new	$-2.5 \log(G_{\text{new}}/G_{\text{old}})$
WFC				
2	A	2.018	2.002	0.0086
2	B	1.960	1.945	0.0083
2	C	2.044	2.028	0.0085
2	D	2.010	1.994	0.0087
4	A	4.005	4.011	-0.0016
4	B	3.897	3.902	-0.0014
4	C	4.068	4.074	-0.0016
4	D	3.990	3.996	-0.0016
HRC				
1	C	1.185	1.163	0.0203
4	C	4.289	4.235	0.0138

^aCorrection to apply to zeropoints **only** for data retrieved from the HST archive before January 6, 2004.

Table 10. Synthetic Zeropoints for WFC

FILTER	VEGAMAG	ABMAG	STMAG
F435W	25.779	25.673	25.157
F475W	26.168	26.068	25.757
F502N	22.352	22.271	22.084
F550M	24.867	24.892	24.934
F555W	25.724	25.718	25.672
F606W	26.398	26.486	26.655
F625W	25.731	25.898	26.206
F658N	22.365	22.747	23.148
F660N	21.389	21.676	22.081
F775W	25.256	25.654	26.393
F814W	25.501	25.937	26.776
F850LP	24.326	24.862	25.954
F892N	21.865	22.371	23.429

Table 11. Synthetic Zeropoints for HRC

FILTER	VEGAMAG	ABMAG	STMAG
F220W	21.871	23.553	21.627
F250W	22.288	23.724	22.201
F330W	22.904	24.085	23.026
F344N	20.439	21.588	20.574
F435W	25.185	25.095	24.575
F475W	25.623	25.527	25.230
F502N	21.906	21.826	21.638
F550M	24.392	24.416	24.457
F555W	25.255	25.248	25.200
F606W	25.893	25.976	26.134
F625W	25.195	25.359	25.662
F658N	21.803	22.185	22.585
F660N	20.827	21.116	21.516
F775W	24.551	24.945	25.675
F814W	24.849	25.287	26.141
F850LP	23.850	24.388	25.502
F892N	21.366	21.870	22.928

Table 12. Coefficients for the Transformation from WFC to HRC

SOURCE		TARGET		Observed			Synthetic			TCOL range ^a
SMAG	TMAG	TCOL	c0	c1	c2	c0	c1	c2		
F435W	F435W	F435W-F475W	0.580 ± 0.061	0.018 ± 0.088	0.000 ± 0.000	0.525 ± 0.042	0.273 ± 0.227	-0.266 ± 0.299	< 0.5	
						0.592 ± 0.008	0.007 ± 0.016	-0.014 ± 0.008	> 0.5	
	F435W	F435W-F550M	0.580 ± 0.061	0.018 ± 0.088	0.000 ± 0.000	0.584 ± 0.073	-0.046 ± 0.154	-0.043 ± 0.080	< -0.7	
						0.589 ± 0.001	-0.007 ± 0.002	-0.002 ± 0.002	> -0.7	
	F435W	F435W-F555W	0.591 ± 0.031	0.009 ± 0.044	0.000 ± 0.000	0.592 ± 0.002	0.047 ± 0.035	-0.011 ± 0.159	< 0.1	
						0.593 ± 0.003	-0.001 ± 0.005	-0.005 ± 0.002	> 0.1	
	F435W	F435W-F606W	0.586 ± 0.059	0.006 ± 0.040	0.000 ± 0.000	0.565 ± 0.028	0.044 ± 0.115	-0.003 ± 0.112	< 0.7	
						0.596 ± 0.005	-0.002 ± 0.005	-0.001 ± 0.001	> 0.7	
	F435W	F435W-F625W	0.592 ± 0.032	0.005 ± 0.031	0.000 ± 0.000	0.593 ± 0.003	0.023 ± 0.025	-0.019 ± 0.060	< 0.1	
						0.594 ± 0.003	-0.003 ± 0.003	-0.001 ± 0.001	> 0.1	
	F435W	F435W-F775W	0.591 ± 0.020	0.004 ± 0.020	0.000 ± 0.000	0.602 ± 0.027	0.008 ± 0.063	-0.008 ± 0.034	< -0.5	
						0.593 ± 0.002	-0.007 ± 0.002	0.001 ± 0.000	> -0.5	
	F435W	F435W-F814W	0.591 ± 0.031	0.007 ± 0.025	0.000 ± 0.000	0.599 ± 0.011	0.013 ± 0.038	-0.006 ± 0.030	< -0.2	
						0.595 ± 0.002	-0.007 ± 0.002	0.001 ± 0.000	> -0.2	
F435W	F435W-F850LP	0.596 ± 0.010	0.004 ± 0.011	0.000 ± 0.000	0.618 ± 0.067	0.018 ± 0.080	-0.000 ± 0.023	< -1.2		
					0.590 ± 0.001	-0.005 ± 0.001	0.001 ± 0.000	> -1.2		
F475W	F475W	F435W-F475W	0.564 ± 0.029	-0.054 ± 0.042	0.000 ± 0.000	0.578 ± 0.004	-0.087 ± 0.009	0.017 ± 0.005	...	
						0.489 ± 0.002	-0.041 ± 0.006	0.003 ± 0.004	...	
	F475W	F475W-F550M	0.519 ± 0.017	-0.025 ± 0.078	0.000 ± 0.000	0.521 ± 0.001	-0.063 ± 0.003	0.005 ± 0.008	...	
						0.543 ± 0.036	-0.026 ± 0.044	0.000 ± 0.000	...	
	F475W	F475W-F555W	0.519 ± 0.017	-0.025 ± 0.078	0.000 ± 0.000	0.521 ± 0.001	-0.063 ± 0.003	0.005 ± 0.008	...	
						0.543 ± 0.036	-0.026 ± 0.044	0.000 ± 0.000	...	
	F475W	F475W-F606W	0.543 ± 0.036	-0.026 ± 0.044	0.000 ± 0.000	0.560 ± 0.002	-0.057 ± 0.004	0.012 ± 0.002	...	
						0.522 ± 0.013	-0.015 ± 0.026	0.000 ± 0.000	...	
	F475W	F475W-F625W	0.522 ± 0.013	-0.015 ± 0.026	0.000 ± 0.000	0.532 ± 0.001	-0.030 ± 0.002	0.002 ± 0.001	...	
						0.519 ± 0.010	-0.010 ± 0.014	0.000 ± 0.000	< -0.1	
F475W	F475W-F775W	0.519 ± 0.010	-0.010 ± 0.014	0.000 ± 0.000	0.526 ± 0.004	-0.019 ± 0.012	-0.000 ± 0.007	< -0.1		
					0.523 ± 0.002	-0.023 ± 0.002	0.005 ± 0.001	> -0.1		
F475W	F475W-F814W	0.523 ± 0.010	-0.009 ± 0.012	0.000 ± 0.000	0.532 ± 0.007	-0.019 ± 0.021	-0.001 ± 0.014	< -0.2		
					0.531 ± 0.002	-0.024 ± 0.002	0.004 ± 0.000	> -0.2		
F475W	F475W-F850LP	0.518 ± 0.014	-0.012 ± 0.013	0.000 ± 0.000	0.510 ± 0.072	-0.026 ± 0.075	-0.003 ± 0.019	< -1.4		
					0.514 ± 0.001	-0.015 ± 0.001	0.003 ± 0.000	> -1.4		
F555W	F555W	F435W-F555W	0.479 ± 0.025	-0.010 ± 0.034	0.000 ± 0.000	0.470 ± 0.001	0.003 ± 0.002	-0.000 ± 0.001	...	

Table 12—Continued

SOURCE	TARGET		Observed			Synthetic			TCOL range ^a
	SMAG	TMAG	TCOL	c0	c1	c2	c0	c1	
F606W	F555W	F475W-F555W	0.465 ± 0.012	-0.025 ± 0.046	0.000 ± 0.000	0.472 ± 0.001	0.006 ± 0.002	0.001 ± 0.005
	F555M	F550M-F555W				0.482 ± 0.020	-0.011 ± 0.057	-0.004 ± 0.040
	F555W	F555W-F606W	0.487 ± 0.066	-0.023 ± 0.077	0.000 ± 0.000	0.459 ± 0.006	0.020 ± 0.011	-0.006 ± 0.004
	F555W	F555W-F625W	0.473 ± 0.019	-0.011 ± 0.047	0.000 ± 0.000	0.470 ± 0.001	0.006 ± 0.004	-0.002 ± 0.002
	F555W	F555W-F775W	0.466 ± 0.014	-0.006 ± 0.025	0.000 ± 0.000	0.472 ± 0.001	0.003 ± 0.001	-0.001 ± 0.000
	F555W	F555W-F814W	0.472 ± 0.015	-0.007 ± 0.021	0.000 ± 0.000	0.471 ± 0.001	0.003 ± 0.001	-0.000 ± 0.000
	F555W	F555W-F850LP	0.468 ± 0.015	-0.005 ± 0.017	0.000 ± 0.000	0.472 ± 0.001	0.001 ± 0.001	0.000 ± 0.000
	F606W	F435W-F606W	0.487 ± 0.039	0.026 ± 0.026	0.000 ± 0.000	0.498 ± 0.002	0.011 ± 0.002	0.001 ± 0.000
	F606W	F475W-F606W	0.496 ± 0.028	0.036 ± 0.033	0.000 ± 0.000	0.500 ± 0.002	0.021 ± 0.004	-0.000 ± 0.002
	F606W	F555W-F606W	0.445 ± 0.057	0.095 ± 0.066	0.000 ± 0.000	0.465 ± 0.007	0.070 ± 0.013	-0.010 ± 0.006
	F606W	F606W-F625W	0.589 ± 0.074	0.129 ± 0.135	0.000 ± 0.000	0.569 ± 0.010	0.131 ± 0.038	0.056 ± 0.036
	F606W	F606W-F775W	0.548 ± 0.033	0.034 ± 0.037	0.000 ± 0.000	0.533 ± 0.001	0.017 ± 0.001	-0.002 ± 0.001
	F606W	F606W-F814W	0.535 ± 0.021	0.033 ± 0.031	0.000 ± 0.000	0.525 ± 0.001	0.016 ± 0.001	-0.002 ± 0.001
	F606W	F606W-F850LP	0.553 ± 0.030	0.021 ± 0.021	0.000 ± 0.000	0.534 ± 0.001	0.011 ± 0.001	-0.001 ± 0.000
F625W	F625W	F435W-F625W	0.537 ± 0.015	0.012 ± 0.013	0.000 ± 0.000	0.536 ± 0.001	0.005 ± 0.001	-0.000 ± 0.000
	F625W	F475W-F625W	0.546 ± 0.011	0.013 ± 0.020	0.000 ± 0.000	0.539 ± 0.001	0.006 ± 0.002	0.002 ± 0.001
	F625W	F555W-F625W	0.546 ± 0.018	0.016 ± 0.042	0.000 ± 0.000	0.537 ± 0.001	0.010 ± 0.004	0.004 ± 0.002
	F625W	F606W-F625W	0.588 ± 0.050	0.063 ± 0.084	0.000 ± 0.000	0.562 ± 0.009	0.052 ± 0.036	0.021 ± 0.034
	F625W	F625W-F775W	0.553 ± 0.012	0.026 ± 0.030	0.000 ± 0.000	0.545 ± 0.001	0.012 ± 0.002	-0.001 ± 0.001
	F625W	F625W-F814W	0.546 ± 0.010	0.024 ± 0.025	0.000 ± 0.000	0.540 ± 0.001	0.011 ± 0.002	-0.001 ± 0.001
	F625W	F625W-F850LP	0.559 ± 0.017	0.014 ± 0.019	0.000 ± 0.000	0.547 ± 0.001	0.007 ± 0.001	-0.000 ± 0.000
	F625W	F435W-F775W	0.706 ± 0.015	0.005 ± 0.014	0.000 ± 0.000	0.707 ± 0.001	0.003 ± 0.001	0.001 ± 0.000
F775W	F775W	F475W-F775W	0.710 ± 0.007	0.007 ± 0.010	0.000 ± 0.000	0.711 ± 0.001	0.006 ± 0.001	0.001 ± 0.000
	F775W	F555W-F775W	0.711 ± 0.012	0.007 ± 0.020	0.000 ± 0.000	0.711 ± 0.001	0.008 ± 0.001	0.001 ± 0.001
	F775W	F606W-F775W	0.718 ± 0.028	0.011 ± 0.031	0.000 ± 0.000	0.722 ± 0.001	0.015 ± 0.001	0.002 ± 0.001
	F775W	F625W-F775W	0.713 ± 0.010	0.007 ± 0.024	0.000 ± 0.000	0.716 ± 0.001	0.016 ± 0.002	0.000 ± 0.001
	F775W	F775W-F814W	0.665 ± 0.061	0.115 ± 0.164	0.000 ± 0.000	0.677 ± 0.007	0.106 ± 0.026	-0.029 ± 0.022
	F775W	F775W-F850LP	0.716 ± 0.031	0.017 ± 0.063	0.000 ± 0.000	0.726 ± 0.001	0.029 ± 0.002	0.001 ± 0.004
F814W	F814W	F435W-F814W	0.653 ± 0.025	-0.001 ± 0.018	0.000 ± 0.000	0.653 ± 0.002	-0.003 ± 0.001	-0.001 ± 0.000

Table 12—Continued

SOURCE	TARGET		Observed			Synthetic			TCOL range ^a
	SMAG	TMAG	TCOL	c0	c1	c2	c0	c1	
	F814W	F475W-F814W	0.652 ± 0.014	-0.003 ± 0.015	0.000 ± 0.000	0.651 ± 0.001	-0.005 ± 0.002	-0.001 ± 0.001	...
	F814W	F555W-F814W	0.654 ± 0.014	-0.008 ± 0.017	0.000 ± 0.000	0.651 ± 0.001	-0.007 ± 0.002	-0.002 ± 0.001	...
	F814W	F606W-F814W	0.646 ± 0.023	-0.010 ± 0.032	0.000 ± 0.000	0.643 ± 0.002	-0.013 ± 0.002	-0.002 ± 0.002	...
	F814W	F625W-F814W	0.649 ± 0.012	-0.010 ± 0.025	0.000 ± 0.000	0.649 ± 0.001	-0.014 ± 0.004	-0.002 ± 0.002	...
	F814W	F775W-F814W	0.699 ± 0.044	-0.132 ± 0.112	0.000 ± 0.000	0.674 ± 0.017	-0.054 ± 0.078	-0.047 ± 0.085	...
	F814W	F814W-F850LP	0.633 ± 0.057	-0.026 ± 0.070	0.000 ± 0.000	0.578 ± 0.016	-0.119 ± 0.042	-0.044 ± 0.027	...
F850LP	F850LP	F435W-F850LP	0.472 ± 0.010	-0.009 ± 0.010	0.000 ± 0.000	0.469 ± 0.045	-0.005 ± 0.060	0.003 ± 0.019	> -0.9
						0.474 ± 0.002	-0.003 ± 0.002	-0.001 ± 0.000	> -0.9
	F850LP	F475W-F850LP	0.465 ± 0.011	-0.011 ± 0.010	0.000 ± 0.000	0.378 ± 0.251	-0.084 ± 0.245	-0.015 ± 0.059	> -1.7
						0.470 ± 0.002	-0.007 ± 0.001	-0.002 ± 0.001	> -1.7
	F850LP	F555W-F850LP	0.465 ± 0.011	-0.014 ± 0.012	0.000 ± 0.000	0.459 ± 0.187	-0.010 ± 0.238	0.004 ± 0.075	> -1.2
						0.469 ± 0.002	-0.009 ± 0.002	-0.002 ± 0.001	> -1.2
	F850LP	F606W-F850LP	0.446 ± 0.029	-0.020 ± 0.021	0.000 ± 0.000	0.448 ± 0.307	-0.007 ± 0.287	0.004 ± 0.066	> -1.8
						0.456 ± 0.002	-0.014 ± 0.002	-0.002 ± 0.002	> -1.8
	F850LP	F625W-F850LP	0.455 ± 0.015	-0.023 ± 0.017	0.000 ± 0.000	0.433 ± 0.271	-0.037 ± 0.374	-0.001 ± 0.128	> -1.2
						0.461 ± 0.002	-0.014 ± 0.002	-0.001 ± 0.002	> -1.2
	F850LP	F775W-F850LP	0.442 ± 0.030	-0.060 ± 0.060	0.000 ± 0.000	0.333 ± 0.295	-0.332 ± 0.778	-0.172 ± 0.508	> -0.6
						0.451 ± 0.003	-0.049 ± 0.009	-0.015 ± 0.018	> -0.6
	F850LP	F814W-F850LP	0.400 ± 0.072	-0.088 ± 0.086	0.000 ± 0.000	0.531 ± 2.168	0.149 ± 4.034	0.102 ± 1.874	< -1.0
						0.390 ± 0.020	-0.141 ± 0.058	-0.052 ± 0.041	> -1.0

^aTCOL range applies only to synthetic transformations.

Table 13. Coefficients for the Transformation from HRC to WFC

SOURCE	TARGET		Observed			Synthetic			TCOL range ^a
	SMAG	TMAG	TCOL	c0	c1	c2	c0	c1	
F435W	F435W	F435W-F475W	-0.573 ± 0.073	-0.045 ± 0.111	0.000 ± 0.000	-0.513 ± 0.031	-0.378 ± 0.178	0.439 ± 0.244	< 0.5
		F435W-F550M				-0.592 ± 0.008	-0.006 ± 0.017	0.015 ± 0.008	> 0.5
	F435W	F435W-F555W	-0.592 ± 0.022	-0.016 ± 0.036	0.000 ± 0.000	-0.550 ± 0.369	0.100 ± 0.629	0.060 ± 0.267	< -1.0
		F435W-F606W	-0.580 ± 0.041	-0.014 ± 0.028	0.000 ± 0.000	-0.588 ± 0.001	0.008 ± 0.001	0.002 ± 0.002	> -1.0
	F435W	F435W-F625W	-0.591 ± 0.025	-0.009 ± 0.023	0.000 ± 0.000	-0.594 ± 0.002	-0.010 ± 0.009	0.089 ± 0.040	< 0.3
		F435W-F775W	-0.586 ± 0.009	-0.007 ± 0.008	0.004 ± 0.003	-0.590 ± 0.004	-0.002 ± 0.007	0.006 ± 0.003	> 0.3
	F435W	F435W-F814W	-0.591 ± 0.004	-0.000 ± 0.004	0.002 ± 0.001	-0.563 ± 0.008	-0.076 ± 0.024	0.047 ± 0.017	< 1.2
		F435W-F850LP	-0.599 ± 0.009	-0.004 ± 0.010	0.000 ± 0.000	-0.586 ± 0.009	-0.007 ± 0.008	0.004 ± 0.002	> 1.2
	F435W	F435W-F814W	-0.592 ± 0.023	-0.006 ± 0.018	0.000 ± 0.000	-0.594 ± 0.002	-0.010 ± 0.007	0.040 ± 0.021	< 0.4
		F435W-F850LP	-0.599 ± 0.009	-0.004 ± 0.010	0.000 ± 0.000	-0.591 ± 0.004	-0.000 ± 0.004	0.002 ± 0.001	> 0.4
F475W	F475W	F435W-F475W	-0.520 ± 0.050	-0.005 ± 0.074	0.000 ± 0.000	-0.593 ± 0.002	0.009 ± 0.009	0.019 ± 0.008	< 0.3
		F475W-F550M				-0.596 ± 0.003	0.009 ± 0.002	-0.002 ± 0.000	> 0.3
	F475W	F475W-F555W	-0.517 ± 0.012	0.033 ± 0.045	0.000 ± 0.000	-0.594 ± 0.002	0.000 ± 0.007	0.019 ± 0.009	< 0.4
		F475W-F606W	-0.539 ± 0.023	0.021 ± 0.028	0.000 ± 0.000	-0.597 ± 0.003	0.008 ± 0.002	-0.001 ± 0.000	> 0.4
	F475W	F475W-F625W	-0.526 ± 0.012	0.020 ± 0.023	0.000 ± 0.000	-0.579 ± 0.011	0.028 ± 0.017	0.013 ± 0.006	< -0.5
		F475W-F775W	-0.525 ± 0.010	0.011 ± 0.013	0.000 ± 0.000	-0.590 ± 0.001	0.006 ± 0.001	-0.001 ± 0.000	> -0.5
	F475W	F475W-F814W	-0.528 ± 0.012	0.012 ± 0.014	0.000 ± 0.000	-0.577 ± 0.004	0.093 ± 0.009	-0.020 ± 0.006
		F475W-F850LP	-0.515 ± 0.010	0.011 ± 0.009	0.000 ± 0.000	-0.488 ± 0.002	0.040 ± 0.006	-0.003 ± 0.004
	F475W	F475W-F814W	-0.528 ± 0.012	0.012 ± 0.014	0.000 ± 0.000	-0.518 ± 0.001	0.059 ± 0.003	-0.004 ± 0.007
		F475W-F850LP	-0.515 ± 0.010	0.011 ± 0.009	0.000 ± 0.000	-0.557 ± 0.002	0.052 ± 0.003	-0.011 ± 0.002
F555W	F555W	F435W-F555W	-0.478 ± 0.021	0.006 ± 0.034	0.000 ± 0.000	-0.532 ± 0.001	0.029 ± 0.002	-0.002 ± 0.001
		F475W-F555W	-0.469 ± 0.014	0.010 ± 0.054	0.000 ± 0.000	-0.529 ± 0.006	0.019 ± 0.016	0.001 ± 0.010	< -0.1
	F555M	F550M-F555W				-0.528 ± 0.002	0.025 ± 0.002	-0.005 ± 0.001	> -0.1
		F555W-F606W	-0.506 ± 0.045	0.038 ± 0.049	0.000 ± 0.000	-0.533 ± 0.010	0.020 ± 0.029	0.002 ± 0.019	< -0.2
	F555W	F555W-F625W	-0.478 ± 0.019	0.015 ± 0.041	0.000 ± 0.000	-0.534 ± 0.002	0.025 ± 0.002	-0.004 ± 0.000	> -0.2
		F555W-F775W	-0.473 ± 0.014	0.008 ± 0.023	0.000 ± 0.000	-0.513 ± 0.065	0.021 ± 0.066	0.002 ± 0.017	< -1.4
	F555W	F555W-F814W	-0.479 ± 0.017	0.012 ± 0.021	0.000 ± 0.000	-0.514 ± 0.001	0.015 ± 0.001	-0.003 ± 0.000	> -1.4
		F555W-F814W	-0.479 ± 0.017	0.012 ± 0.021	0.000 ± 0.000	-0.470 ± 0.001	-0.003 ± 0.002	0.000 ± 0.001
F555W	F555W-F555W	-0.469 ± 0.014	0.010 ± 0.054	0.000 ± 0.000	-0.472 ± 0.001	-0.006 ± 0.002	-0.002 ± 0.004	
	F555M-F555W				-0.483 ± 0.021	0.013 ± 0.059	0.002 ± 0.041	
F555W	F555W-F606W	-0.506 ± 0.045	0.038 ± 0.049	0.000 ± 0.000	-0.459 ± 0.006	-0.019 ± 0.010	0.006 ± 0.004	
	F555W-F625W	-0.478 ± 0.019	0.015 ± 0.041	0.000 ± 0.000	-0.470 ± 0.001	-0.006 ± 0.004	0.002 ± 0.002	
F555W	F555W-F775W	-0.473 ± 0.014	0.008 ± 0.023	0.000 ± 0.000	-0.471 ± 0.001	-0.003 ± 0.001	0.001 ± 0.000	
	F555W-F814W	-0.479 ± 0.017	0.012 ± 0.021	0.000 ± 0.000	-0.470 ± 0.001	-0.003 ± 0.001	0.000 ± 0.000	

Table 13—Continued

SOURCE	TARGET		Observed			Synthetic			TCOL range ^a	
	SMAG	TMAG	TCOL	c0	c1	c2	c0	c1		c2
F606W	F555W	F555W-F850LP		-0.469 ± 0.014	0.008 ± 0.015	0.000 ± 0.000	-0.473 ± 0.001	-0.002 ± 0.001	0.000 ± 0.000	...
	F606W	F435W-F606W		-0.482 ± 0.035	-0.031 ± 0.024	0.000 ± 0.000	-0.499 ± 0.002	-0.011 ± 0.002	-0.001 ± 0.000	...
	F606W	F475W-F606W		-0.493 ± 0.033	-0.040 ± 0.039	0.000 ± 0.000	-0.502 ± 0.002	-0.018 ± 0.003	-0.001 ± 0.001	...
	F606W	F555W-F606W		-0.447 ± 0.062	-0.084 ± 0.069	0.000 ± 0.000	-0.465 ± 0.007	-0.067 ± 0.013	0.010 ± 0.006	...
	F606W	F606W-F625W		-0.554 ± 0.071	-0.062 ± 0.136	0.000 ± 0.000	-0.570 ± 0.010	-0.139 ± 0.040	-0.064 ± 0.040	...
	F606W	F606W-F775W		-0.543 ± 0.027	-0.032 ± 0.036	0.000 ± 0.000	-0.530 ± 0.001	-0.018 ± 0.001	0.003 ± 0.001	...
	F606W	F606W-F814W		-0.532 ± 0.016	-0.026 ± 0.027	0.000 ± 0.000	-0.523 ± 0.001	-0.018 ± 0.001	0.002 ± 0.001	...
F625W	F606W	F606W-F850LP		-0.552 ± 0.031	-0.021 ± 0.021	0.000 ± 0.000	-0.535 ± 0.001	-0.012 ± 0.001	0.001 ± 0.000	...
	F625W	F435W-F625W		-0.543 ± 0.016	-0.013 ± 0.015	0.000 ± 0.000	-0.537 ± 0.001	-0.005 ± 0.001	0.000 ± 0.000	...
	F625W	F475W-F625W		-0.549 ± 0.012	-0.011 ± 0.023	0.000 ± 0.000	-0.539 ± 0.001	-0.006 ± 0.002	0.000 ± 0.001	...
	F625W	F555W-F625W		-0.544 ± 0.020	-0.020 ± 0.041	0.000 ± 0.000	-0.536 ± 0.001	-0.010 ± 0.004	-0.004 ± 0.002	...
	F625W	F606W-F625W		-0.607 ± 0.043	-0.113 ± 0.083	0.000 ± 0.000	-0.563 ± 0.009	-0.056 ± 0.038	-0.024 ± 0.038	...
	F625W	F625W-F775W		-0.549 ± 0.010	-0.017 ± 0.030	0.000 ± 0.000	-0.543 ± 0.001	-0.013 ± 0.002	0.001 ± 0.001	...
	F625W	F625W-F814W		-0.547 ± 0.012	-0.018 ± 0.027	0.000 ± 0.000	-0.539 ± 0.001	-0.011 ± 0.002	0.001 ± 0.001	...
F775W	F625W	F625W-F850LP		-0.567 ± 0.018	-0.017 ± 0.019	0.000 ± 0.000	-0.548 ± 0.001	-0.008 ± 0.001	0.000 ± 0.000	...
	F775W	F435W-F775W		-0.708 ± 0.011	-0.005 ± 0.010	0.000 ± 0.000	-0.707 ± 0.001	-0.003 ± 0.001	-0.001 ± 0.000	...
	F775W	F475W-F775W		-0.710 ± 0.010	-0.005 ± 0.013	0.000 ± 0.000	-0.710 ± 0.001	-0.005 ± 0.001	-0.001 ± 0.000	...
	F775W	F555W-F775W		-0.709 ± 0.010	-0.008 ± 0.014	0.000 ± 0.000	-0.709 ± 0.001	-0.008 ± 0.001	-0.001 ± 0.001	...
	F775W	F606W-F775W		-0.715 ± 0.017	-0.012 ± 0.024	0.000 ± 0.000	-0.719 ± 0.001	-0.014 ± 0.001	-0.002 ± 0.001	...
	F775W	F625W-F775W		-0.710 ± 0.014	-0.016 ± 0.040	0.000 ± 0.000	-0.713 ± 0.001	-0.016 ± 0.002	-0.000 ± 0.001	...
	F775W	F775W-F814W		-0.732 ± 0.053	0.066 ± 0.162	0.000 ± 0.000	-0.677 ± 0.007	-0.128 ± 0.032	0.041 ± 0.033	...
F814W	F775W	F775W-F850LP		-0.726 ± 0.035	-0.019 ± 0.048	0.000 ± 0.000	-0.734 ± 0.002	-0.032 ± 0.004	-0.002 ± 0.004	...
	F814W	F435W-F814W		-0.650 ± 0.026	0.002 ± 0.020	0.000 ± 0.000	-0.650 ± 0.005	0.007 ± 0.024	-0.002 ± 0.025	< 0.1
							-0.650 ± 0.004	-0.001 ± 0.003	0.002 ± 0.000	> 0.1
	F814W	F475W-F814W		-0.653 ± 0.015	0.005 ± 0.017	0.000 ± 0.000	-0.638 ± 0.079	0.025 ± 0.179	0.006 ± 0.098	< -0.6
							-0.650 ± 0.002	0.002 ± 0.003	0.002 ± 0.001	> -0.6
	F814W	F555W-F814W		-0.649 ± 0.020	0.002 ± 0.024	0.000 ± 0.000	-0.655 ± 0.059	-0.012 ± 0.290	-0.031 ± 0.338	< -0.2
							-0.651 ± 0.002	0.003 ± 0.004	0.003 ± 0.001	> -0.2
	F814W	F606W-F814W		-0.646 ± 0.016	0.004 ± 0.027	0.000 ± 0.000	-0.655 ± 0.191	-0.020 ± 0.389	-0.020 ± 0.195	< -0.8
							-0.645 ± 0.002	0.012 ± 0.003	0.004 ± 0.003	> -0.8
	F814W	F625W-F814W		-0.653 ± 0.017	0.010 ± 0.037	0.000 ± 0.000	-0.647 ± 0.018	0.020 ± 0.144	-0.014 ± 0.255	< -0.1
						-0.650 ± 0.002	0.014 ± 0.008	0.002 ± 0.004	> -0.1	
F814W	F775W-F814W					-0.702 ± 0.377	0.248 ± 3.172	-0.212 ± 6.634	< 0.2	
						-0.666 ± 0.032	0.023 ± 0.164	0.121 ± 0.200	> 0.2	

Table 13—Continued

SOURCE	TARGET		Observed			Synthetic			TCOL range ^a
	SMAG	TMAG	TCOL	c0	c1	c2	c0	c1	
	F814W	F814W-F850LP	-0.614 ± 0.062	0.035 ± 0.060	0.000 ± 0.000	-0.897 ± 3.138	-0.425 ± 5.047	-0.186 ± 2.028	< -1.1
						-0.539 ± 0.032	0.175 ± 0.073	0.067 ± 0.041	> -1.1
F850LP	F850LP	F435W-F850LP	-0.471 ± 0.012	0.008 ± 0.012	0.000 ± 0.000	-0.465 ± 0.083	0.007 ± 0.097	-0.002 ± 0.028	< -1.2
						-0.474 ± 0.002	0.003 ± 0.002	0.001 ± 0.000	> -1.2
	F850LP	F475W-F850LP	-0.464 ± 0.017	0.010 ± 0.016	0.000 ± 0.000	-0.450 ± 0.097	0.015 ± 0.100	-0.001 ± 0.025	< -1.4
						-0.470 ± 0.002	0.007 ± 0.002	0.002 ± 0.001	> -1.4
	F850LP	F555W-F850LP	-0.463 ± 0.015	0.012 ± 0.016	0.000 ± 0.000	-0.375 ± 0.258	0.112 ± 0.325	0.026 ± 0.101	< -1.3
						-0.469 ± 0.002	0.009 ± 0.002	0.001 ± 0.001	> -1.3
	F850LP	F606W-F850LP	-0.447 ± 0.028	0.015 ± 0.019	0.000 ± 0.000	-0.425 ± 0.475	0.026 ± 0.431	-0.001 ± 0.097	< -1.9
						-0.455 ± 0.002	0.015 ± 0.002	0.002 ± 0.002	> -1.9
	F850LP	F625W-F850LP	-0.448 ± 0.019	0.021 ± 0.019	0.000 ± 0.000	-0.388 ± 0.371	0.091 ± 0.490	0.018 ± 0.161	< -1.3
						-0.460 ± 0.002	0.015 ± 0.002	0.001 ± 0.002	> -1.3
	F850LP	F775W-F850LP	-0.451 ± 0.058	0.027 ± 0.079	0.000 ± 0.000	-0.229 ± 0.752	0.449 ± 1.511	0.190 ± 0.757	< -0.9
						-0.435 ± 0.005	0.064 ± 0.019	0.018 ± 0.020	> -0.9
	F850LP	F814W-F850LP	-0.407 ± 0.117	0.062 ± 0.115	0.000 ± 0.000	-0.605 ± 3.138	-0.259 ± 5.047	-0.132 ± 2.028	< -1.1
						-0.362 ± 0.032	0.161 ± 0.073	0.053 ± 0.041	> -1.1

^aTCOL range applies only to synthetic transformations.

Table 14. Extinction Ratios A(P)/E(B-V) in WFC Filters for Different SEDs

SED	F435W	F475W	F502N	F550M	F555W	F606W	F625W	F658N	F660N	F775W	F814W	F850LP	F892N
O5	4.192	3.773	3.459	3.052	3.233	2.936	2.673	2.525	2.518	2.005	1.864	1.498	1.509
G2	4.081	3.634	3.458	3.042	3.177	2.809	2.637	2.525	2.517	1.982	1.825	1.485	1.508
M0	3.994	3.555	3.458	3.030	3.115	2.716	2.616	2.525	2.517	1.965	1.796	1.471	1.508
E	4.044	3.591	3.458	3.040	3.158	2.764	2.623	2.525	2.517	1.973	1.803	1.472	1.508
Sc	4.103	3.637	3.459	3.041	3.176	2.799	2.633	2.525	2.517	1.981	1.822	1.477	1.508
Im	4.127	3.659	3.460	3.044	3.200	2.830	2.637	2.525	2.517	1.979	1.818	1.476	1.508

Table 15. Extinction Ratios A(P)/E(B-V) in HRC Filters for Different SEDs

SED	F220W	F250W	F330W	F344N	F435W	F475W	F502N	F550M	F555W	F606W	F625W	F658N	F660N	F775W	F814W	F850LP	F892N
O5	8.350	6.353	5.105	4.991	4.197	3.741	3.461	3.053	3.235	2.953	2.681	2.528	2.546	2.018	1.847	1.473	1.513
G2	5.735	5.676	5.046	4.987	4.075	3.608	3.458	3.043	3.180	2.825	2.644	2.525	2.518	1.995	1.803	1.460	1.508
M0	2.809	4.965	5.000	4.953	3.984	3.535	3.458	3.031	3.118	2.730	2.623	2.525	2.517	1.978	1.770	1.447	1.507
E	5.479	5.654	5.043	4.980	4.036	3.569	3.458	3.041	3.160	2.780	2.630	2.525	2.518	1.985	1.779	1.447	1.508
Sc	7.773	6.133	5.066	4.987	4.100	3.611	3.459	3.042	3.179	2.816	2.640	2.525	2.518	1.994	1.800	1.452	1.508
Im	7.995	6.207	5.070	4.988	4.126	3.632	3.460	3.044	3.203	2.847	2.644	2.525	2.519	1.992	1.795	1.451	1.508

Table 16. Aperture Correction - Case 1

Assumption	WFC				HRC			
	apt _c F775W	apt _c F850LP	F775W-F850LP	F775W-F850LP	apt _c F775W	apt _c F850LP	F775W-F850LP	F775W-F850LP
input data	26.00	1.65	26.00	1.71
1- The counts in 0.3'' are the total counts	26.22	1.57	26.43	1.51
2- The counts in 0.3'' need to be corrected using the same correction for both filters								
a) F775W apt _c from the EE of WDs	0.14	0.14	26.08	1.57	0.18	0.18	26.25	1.51
b) F850LP apt _c from the EE of WDs	0.19	0.19	26.03	1.57	0.40	0.40	26.03	1.51
3- The counts in 0.3'' need to be corrected using the different corrections in different filters								
a) apt _c from the EE of WDs	0.14	0.19	26.03	1.62	0.18	0.40	26.03	1.73
b) apt _c from Tables 6 and 7	0.15	0.22	26.00	1.64	0.22	0.45	26.02	1.74
c) using SYNPHOT	0.14	0.24	25.98	1.66	0.23	0.47	25.96	1.75

Table 17. Aperture Correction - Case 2

Assumption	WFC				HRC			
	apt _c F775W	apt _c F850LP	F775W-F850LP	F775W-F850LP	apt _c F775W	apt _c F850LP	F775W-F850LP	F775W-F850LP
input data	22.00	1.84	22.05	1.99
measured data in aperture	22.20	1.69	22.55	1.54
apt _c from the EE of WDs	0.19	0.27	22.01	1.77	0.50	0.83	22.06	1.88
apt _c from Tables 6 and 7	0.20	0.37	22.00	1.86	0.54	0.98	22.02	1.98
using SYNPHOT	0.20	0.39	22.00	1.87	0.55	1.00	22.01	1.99

Table 18. Coefficients for the Transformation from WFC to BVRI

SOURCE	TARGET		Observed			Synthetic			TCOL range ^a
	SMAG	TMAG TCOL	c0	c1	c2	c0	c1	c2	
F435W	B	B-V	25.842 ± 0.023	-0.089 ± 0.024	0.000 ± 0.000	25.769 ± 0.004	0.029 ± 0.012	-0.156 ± 0.055	< 0.4
		25.709 ± 0.007				0.108 ± 0.009	-0.068 ± 0.002	> 0.4	
	B	B-R	25.847 ± 0.021	-0.045 ± 0.011	0.000 ± 0.000	25.769 ± 0.004	0.027 ± 0.008	-0.073 ± 0.028	< 0.6
		25.743 ± 0.008				0.022 ± 0.007	-0.013 ± 0.001	> 0.6	
		B-I				25.768 ± 0.004	0.022 ± 0.006	-0.038 ± 0.011	< 1.0
					25.749 ± 0.009	0.008 ± 0.006	-0.005 ± 0.001	> 1.0	
F475W	B	B-V	26.146 ± 0.002	-0.056 ± 0.013	0.000 ± 0.000	26.146 ± 0.002	0.389 ± 0.004	0.032 ± 0.001
		26.150 ± 0.004				0.291 ± 0.008	-0.110 ± 0.028	< 0.6	
	B	B-R	26.015 ± 0.008	0.433 ± 0.007	-0.046 ± 0.001	26.145 ± 0.004	0.220 ± 0.006	-0.050 ± 0.011	< 1.0
		B-I				25.875 ± 0.009	0.456 ± 0.006	-0.053 ± 0.001	> 1.0
F555W	V	B-V	25.701 ± 0.012	-0.056 ± 0.013	0.000 ± 0.000	25.714 ± 0.004	-0.083 ± 0.032	0.020 ± 0.115	< 0.2
		25.720 ± 0.005				-0.087 ± 0.007	0.004 ± 0.002	> 0.2	
	V	V-R	25.703 ± 0.009	-0.100 ± 0.016	0.000 ± 0.000	25.720 ± 0.005	-0.197 ± 0.062	0.159 ± 0.756	< 0.1
		25.724 ± 0.005				-0.159 ± 0.010	0.018 ± 0.004	> 0.1	
	V	V-I	25.704 ± 0.020	-0.054 ± 0.020	0.000 ± 0.000	25.719 ± 0.004	-0.088 ± 0.014	0.043 ± 0.068	< 0.4
		25.735 ± 0.006				-0.106 ± 0.007	0.013 ± 0.001	> 0.4	
F606W	V	B-V	26.399 ± 0.038	0.193 ± 0.045	0.000 ± 0.000	26.410 ± 0.003	0.170 ± 0.005	0.061 ± 0.002
		26.392 ± 0.006				0.310 ± 0.077	0.266 ± 0.945	< 0.1	
	V	V-R	26.341 ± 0.041	0.444 ± 0.083	0.000 ± 0.000	26.372 ± 0.006	0.477 ± 0.013	-0.001 ± 0.005	> 0.1
		V-I				26.325 ± 0.057	0.236 ± 0.058	0.000 ± 0.000	26.394 ± 0.005
					26.331 ± 0.008	0.340 ± 0.008	-0.038 ± 0.002	> 0.4	
F625W	R	B-R	25.720 ± 0.009	-0.098 ± 0.021	0.000 ± 0.000	25.717 ± 0.003	-0.041 ± 0.003	-0.003 ± 0.001
		25.720 ± 0.005				-0.147 ± 0.041	0.043 ± 0.404	< 0.2	
	V-R	25.684 ± 0.007	0.042 ± 0.014	-0.184 ± 0.005	> 0.2				
F775W	R	R-I	25.726 ± 0.017	-0.110 ± 0.041	0.000 ± 0.000	25.720 ± 0.003	-0.107 ± 0.009	-0.101 ± 0.005
		25.239 ± 0.008				-0.030 ± 0.012	-0.002 ± 0.023	< 1.0	
	I	B-I	25.216 ± 0.019	-0.002 ± 0.012	-0.007 ± 0.002	> 1.0			
	I	V-I	25.240 ± 0.013	-0.054 ± 0.015	0.000 ± 0.000	25.241 ± 0.005	-0.061 ± 0.021	0.002 ± 0.021	< 1.2

Table 18—Continued

SOURCE	TARGET		Observed			Synthetic			TCOL range ^a	
	SMAG	TMAG	TCOL	c0	c1	c2	c0	c1		c2
F814W		I	R-I	25.242 ± 0.013	-0.106 ± 0.030	0.000 ± 0.000	25.292 ± 0.033	-0.105 ± 0.026	0.007 ± 0.004	> 1.2
							25.240 ± 0.008	-0.119 ± 0.052	0.001 ± 0.499	< 0.2
							25.242 ± 0.012	-0.133 ± 0.030	0.002 ± 0.013	> 0.2
		I	B-I				25.490 ± 0.011	0.013 ± 0.060	-0.028 ± 0.112	< 0.3
							25.495 ± 0.014	-0.010 ± 0.010	0.006 ± 0.002	> 0.3
		I	V-I	25.495 ± 0.015	-0.002 ± 0.017	0.000 ± 0.000	25.489 ± 0.013	0.041 ± 0.211	-0.093 ± 0.803	< 0.1
							25.496 ± 0.010	-0.014 ± 0.013	0.015 ± 0.003	> 0.1
		I	R-I	25.492 ± 0.013	0.002 ± 0.030	0.000 ± 0.000	25.489 ± 0.010	0.068 ± 0.065	-0.295 ± 0.624	< 0.2
						25.478 ± 0.016	0.042 ± 0.038	0.012 ± 0.017	> 0.2	

^aTCOL range applies only to synthetic transformations.

Table 19. Coefficients for the Transformation from HRC to UBVRI.

SOURCE	TARGET	Observed TCOL	Observed			Synthetic			TCOL range ^a
			c0	c1	c2	c0	c1	c2	
F330W	U	U-B	23.020 ± 0.008	-0.406 ± 0.058	0.125 ± 0.079	< 0.2			
		U-V	23.064 ± 0.029	-0.104 ± 0.058	-0.093 ± 0.026	> 0.2			
	U	U-R	22.995 ± 0.012	-0.328 ± 0.043	0.052 ± 0.040	< 0.3			
		U-I	23.001 ± 0.017	0.065 ± 0.021	-0.056 ± 0.006	> 0.3			
		U-I	23.012 ± 0.012	-0.222 ± 0.024	0.095 ± 0.024	< 0.6			
	F435W	B	U-B	23.050 ± 0.023	0.017 ± 0.019	-0.028 ± 0.004	> 0.6		
			B-U	23.014 ± 0.012	-0.216 ± 0.022	0.065 ± 0.020	< 0.7		
B		B-V	23.040 ± 0.024	0.015 ± 0.018	-0.019 ± 0.003	> 0.7			
		B-R	25.171 ± 0.005	0.005 ± 0.037	-0.007 ± 0.046	< 0.1			
		B-I	25.166 ± 0.008	-0.003 ± 0.019	-0.010 ± 0.010	> 0.1			
F475W		B	B-V	25.177 ± 0.008	0.048 ± 0.101	0.004 ± 0.280	< 0.1		
			B-R	25.171 ± 0.010	0.001 ± 0.023	-0.016 ± 0.012	> 0.1		
	B	B-I	25.176 ± 0.006	0.014 ± 0.012	-0.041 ± 0.031	< 0.8			
		B-I	25.135 ± 0.023	0.042 ± 0.025	-0.017 ± 0.006	> 0.8			
		B-I	25.176 ± 0.006	0.011 ± 0.009	-0.023 ± 0.017	< 1.0			
F555W	V	B-V	25.165 ± 0.037	0.002 ± 0.036	-0.003 ± 0.008	> 1.0			
		B-R	25.601 ± 0.004	0.444 ± 0.010	0.013 ± 0.006			
	V	B-R	25.604 ± 0.006	0.310 ± 0.012	-0.108 ± 0.041	< 0.6			
		B-I	25.463 ± 0.019	0.464 ± 0.021	-0.050 ± 0.005	> 0.6			
F606W	V	B-V	25.599 ± 0.006	0.233 ± 0.009	-0.049 ± 0.017	< 1.1			
		V-R	25.229 ± 0.046	0.611 ± 0.047	-0.097 ± 0.012	> 1.1			
	V	V-R	25.244 ± 0.013	-0.098 ± 0.157	-0.014 ± 0.384	< 0.0			
		V-I	25.238 ± 0.008	-0.050 ± 0.020	-0.019 ± 0.011	> 0.0			
		V-I	25.251 ± 0.005	-0.191 ± 0.049	0.184 ± 0.271	< 0.3			
F625W	R	B-R	25.269 ± 0.019	-0.205 ± 0.048	0.043 ± 0.027	> 0.3			
		V-R	25.250 ± 0.005	-0.090 ± 0.021	0.034 ± 0.066	< 0.6			
	R	V-I	25.275 ± 0.041	-0.124 ± 0.075	0.018 ± 0.032	> 0.6			
		V-I	25.904 ± 0.005	0.156 ± 0.014	0.059 ± 0.009			
F775W	I	B-V	25.887 ± 0.008	0.287 ± 0.070	0.306 ± 0.389	< 0.3			
		V-R	25.848 ± 0.043	0.495 ± 0.132	-0.028 ± 0.096	> 0.3			
	I	V-I	25.888 ± 0.009	0.139 ± 0.031	0.094 ± 0.145	< 0.4			
		V-I	25.805 ± 0.027	0.364 ± 0.044	-0.054 ± 0.016	> 0.4			
		V-I	25.180 ± 0.006	-0.053 ± 0.013	0.003 ± 0.008	< 2.0			
F814W	R	B-R	25.561 ± 2.659	-0.333 ± 2.408	0.047 ± 0.544	> 2.0			
		V-R	25.184 ± 0.008	-0.158 ± 0.070	0.054 ± 0.389	< 0.3			
	R	R-I	25.133 ± 0.036	0.065 ± 0.107	-0.201 ± 0.074	> 0.3			
		R-I	25.183 ± 0.006	-0.143 ± 0.039	-0.060 ± 0.079	< 0.7			
F814W	I	B-I	25.136 ± 0.623	-0.026 ± 1.399	-0.136 ± 0.759	> 0.7			
		B-I	24.534 ± 0.009	-0.034 ± 0.015	-0.003 ± 0.028	< 1.0			
	I	V-I	24.491 ± 0.039	0.012 ± 0.032	-0.011 ± 0.006	> 1.0			
		V-I	24.535 ± 0.007	-0.069 ± 0.026	0.003 ± 0.026	< 1.2			
		V-I	24.597 ± 0.095	-0.121 ± 0.095	0.008 ± 0.022	> 1.2			
F814W	I	R-I	24.535 ± 0.007	-0.142 ± 0.026	-0.005 ± 0.023			
		B-I	24.838 ± 0.012	0.023 ± 0.019	-0.028 ± 0.046	< 0.8			
	I	B-I	24.824 ± 0.039	0.009 ± 0.033	0.003 ± 0.006	> 0.8			
		V-I	24.837 ± 0.016	0.060 ± 0.253	-0.099 ± 0.963	< 0.1			
		R-I	24.838 ± 0.016	0.001 ± 0.024	0.013 ± 0.007	> 0.1			
I	R-I	24.836 ± 0.036	0.110 ± 0.973	-0.212 ± 5.308	< 0.0				
	R-I	24.834 ± 0.014	0.035 ± 0.050	0.023 ± 0.038	> 0.0				

^aTCOL range applies only to synthetic transformations.

Table 20. Coefficients for the Transformation from WFC to WFCP2

SOURCE SMAG	TARGET TMAG	TARGET TCOL	c0	Observed c1	c2	c0	Synthetic c1	c2	TCOL range ^a
F435W	F439W	F439W-F555W	5.550 ± 0.067	0.040 ± 0.029	0.000 ± 0.000	6.180 ± 1.210	-0.605 ± 1.589	0.158 ± 0.520	< 1.7
	F439W	F439W-F606W	5.783 ± 2.031	-0.153 ± 1.594	0.036 ± 0.304	5.655 ± 0.076	-0.074 ± 0.060	0.029 ± 0.011	> 1.7
	F439W	F439W-F675W	5.567 ± 0.176	0.030 ± 0.074	0.000 ± 0.000	5.772 ± 1.384	-0.054 ± 1.537	-0.014 ± 0.425	< 2.0
	F439W	F439W-F814W	5.600 ± 0.033	0.019 ± 0.015	0.000 ± 0.000	5.638 ± 0.061	-0.046 ± 0.039	0.016 ± 0.006	> 2.0
	F439W	F439W-F850LP	5.626 ± 0.058	0.020 ± 0.062	0.000 ± 0.000	5.694 ± 0.195	-0.066 ± 0.436	-0.007 ± 0.237	< 1.2
F555W	F555W	F439W-F555W	3.965 ± 0.090	-0.041 ± 0.038	0.000 ± 0.000	5.627 ± 0.031	-0.030 ± 0.025	0.015 ± 0.005	> 1.2
	F555W	F555W-F606W	3.911 ± 0.162	-0.067 ± 0.292	0.000 ± 0.000	5.662 ± 0.016	-0.108 ± 0.053	0.057 ± 0.037	< 1.4
	F555W	F555W-F675W	3.875 ± 0.025	-0.047 ± 0.126	0.000 ± 0.000	5.614 ± 0.041	-0.010 ± 0.031	0.009 ± 0.006	> 1.4
	F555W	F555W-F814W	3.867 ± 0.016	-0.032 ± 0.036	0.000 ± 0.000	5.558 ± 0.170	-0.063 ± 0.265	-0.007 ± 0.100	< -0.9
	F555W	F555W-F850LP	3.826 ± 0.159	-0.028 ± 0.094	0.000 ± 0.000	5.621 ± 0.004	0.019 ± 0.006	0.008 ± 0.003	> -0.9
F606W	F606W	F439W-F606W	4.214 ± 0.129	-0.012 ± 0.051	0.000 ± 0.000	3.886 ± 0.038	0.037 ± 0.033	-0.018 ± 0.007
	F606W	F555W-F606W	4.291 ± 0.569	0.815 ± 1.782	0.038 ± 1.389	3.889 ± 0.021	0.120 ± 0.078	-0.250 ± 0.067
	F606W	F606W-F675W	4.128 ± 0.046	-0.093 ± 0.070	0.000 ± 0.000	3.875 ± 0.003	-0.086 ± 0.006	-0.069 ± 0.012
	F606W	F606W-F814W	4.132 ± 0.050	-0.060 ± 0.053	0.000 ± 0.000	3.867 ± 0.003	-0.061 ± 0.006	-0.026 ± 0.007
	F606W	F606W-F850LP	4.084 ± 0.084	-0.044 ± 0.034	0.000 ± 0.000	3.765 ± 0.010	-0.089 ± 0.013	-0.014 ± 0.004
F625W	F675W	F439W-F675W	4.553 ± 0.038	-0.144 ± 0.053	0.011 ± 0.016	4.359 ± 0.031	-0.079 ± 0.021	0.008 ± 0.004
	F675W	F555W-F675W	3.567 ± 0.268	0.499 ± 0.161	-0.092 ± 0.024	4.291 ± 0.569	0.815 ± 1.782	0.038 ± 1.389
	F675W	F606W-F675W	4.280 ± 0.008	-0.243 ± 0.063	0.023 ± 0.096	4.182 ± 0.005	0.077 ± 0.015	0.165 ± 0.017
	F675W	F675W-F675W	4.257 ± 0.022	-0.030 ± 0.130	-0.365 ± 0.163	4.168 ± 0.004	-0.016 ± 0.005	0.030 ± 0.004
	F675W	F675W-F814W	4.015 ± 0.068	-0.457 ± 0.211	0.011 ± 0.156	4.178 ± 0.012	0.029 ± 0.013	0.016 ± 0.003
F775W	F814W	F439W-F814W	4.367 ± 0.047	-0.030 ± 0.020	0.000 ± 0.000	4.553 ± 0.038	-0.144 ± 0.053	0.011 ± 0.016	< 2.6
	F814W	F555W-F814W	4.297 ± 0.019	-0.064 ± 0.038	0.000 ± 0.000	3.567 ± 0.268	0.499 ± 0.161	-0.092 ± 0.024	> 2.6
	F814W	F606W-F814W	4.260 ± 0.110	-0.093 ± 0.170	0.000 ± 0.000	4.280 ± 0.008	-0.243 ± 0.063	0.023 ± 0.096	< 0.1
	F814W	F675W-F814W	4.309 ± 0.036	-0.116 ± 0.309	0.000 ± 0.000	4.257 ± 0.022	-0.030 ± 0.130	-0.365 ± 0.163	> 0.1
	F814W	F814W-F850LP	4.602 ± 0.035	-0.001 ± 0.015	0.000 ± 0.000	4.015 ± 0.068	-0.457 ± 0.211	0.011 ± 0.156	< -0.4
F814W	F814W	F439W-F814W	4.601 ± 0.016	-0.001 ± 0.032	0.000 ± 0.000	3.884 ± 0.010	-0.778 ± 0.029	0.093 ± 0.113	> -0.4
	F814W	F555W-F814W	4.623 ± 0.105	0.004 ± 0.160	0.000 ± 0.000	4.194 ± 0.025	-0.664 ± 0.176	-0.330 ± 0.272	< -0.1
	F814W	F606W-F814W	4.622 ± 0.032	0.012 ± 0.264	0.000 ± 0.000	4.225 ± 0.005	-0.327 ± 0.050	0.011 ± 0.069	> -0.1
	F814W	F675W-F814W	4.622 ± 0.032	0.012 ± 0.264	0.000 ± 0.000	2.638 ± 0.681	-1.464 ± 0.665	-0.294 ± 0.161	< -1.7
	F814W	F814W-F850LP	4.602 ± 0.035	-0.001 ± 0.015	0.000 ± 0.000	3.950 ± 0.226	-0.159 ± 0.321	0.022 ± 0.113	> -1.7
F850LP	F850LP	F439W-F850LP	5.082 ± 0.018	-0.004 ± 0.010	0.000 ± 0.000	4.369 ± 0.019	-0.075 ± 0.048	0.022 ± 0.026	< 1.9
	F850LP	F555W-F850LP	5.082 ± 0.011	-0.004 ± 0.010	0.000 ± 0.000	4.337 ± 0.086	-0.012 ± 0.058	-0.004 ± 0.009	> 1.9
	F850LP	F606W-F850LP	5.488 ± 0.931	0.299 ± 0.639	0.054 ± 0.109	4.323 ± 0.098	0.069 ± 0.232	0.080 ± 0.130	< -0.5
	F850LP	F675W-F850LP	5.049 ± 0.011	-0.012 ± 0.017	0.000 ± 0.007	4.280 ± 0.005	-0.069 ± 0.018	-0.006 ± 0.032	> -0.5
	F850LP	F814W-F850LP	5.655 ± 1.632	0.738 ± 1.968	0.236 ± 0.592	4.408 ± 0.313	0.233 ± 0.520	0.134 ± 0.213	< -0.9
									> -0.9
									> -0.2
									> -0.2
									< -0.2
									< 3.5
									> 3.5
								
								
								
								
									< -1.0
									> -1.0
									< 0.0
									> 0.0
									< -2.0
									> -2.0
									< -2.5
									> -2.5
									< -1.8
									> -1.8
									< -1.5
									> -1.5

^aTCOL range applies only to synthetic transformations.

Table 21. Coefficients for the Transformation from HRC to WFPC2

SOURCE SMAG	TARGET TMAG	TARGET TCOL	Observed			Synthetic			TCOL range
			c0	c1	c2	c0	c1	c2	
F330W	F336W	F336W-F439W				4.214 ± 0.018	0.004 ± 0.083	0.001 ± 0.104	< 1.1
						4.056 ± 0.097	0.229 ± 0.100	-0.077 ± 0.024	> 1.1
	F336W	F336W-F555W	5.820 ± 6.690	-0.868 ± 3.329	0.118 ± 0.412	4.203 ± 0.142	0.011 ± 0.139	-0.002 ± 0.032	< 3.1
						3.745 ± 0.192	0.255 ± 0.089	-0.034 ± 0.010	> 3.1
	F336W	F336W-F606W				4.206 ± 0.160	0.006 ± 0.134	-0.001 ± 0.026	< 3.6
						3.832 ± 0.345	0.186 ± 0.148	-0.022 ± 0.015	> 3.6
	F336W	F336W-F675W				4.217 ± 0.148	-0.002 ± 0.146	0.001 ± 0.033	< 3.1
					3.946 ± 0.200	0.153 ± 0.093	-0.021 ± 0.010	> 3.1	
F336W	F336W-F814W				4.232 ± 0.125	-0.017 ± 0.115	0.005 ± 0.025	< 3.3	
					3.940 ± 0.295	0.155 ± 0.131	-0.021 ± 0.014	> 3.3	
F336W	F336W-F850LP				4.188 ± 0.158	0.044 ± 0.185	-0.012 ± 0.051	< 2.6	
					3.962 ± 0.185	0.183 ± 0.090	-0.033 ± 0.011	> 2.6	
F435W	F439W	F336W-F439W				5.718 ± 1.408	-0.946 ± 1.995	0.324 ± 0.704	< 1.6
						4.945 ± 0.200	0.052 ± 0.175	0.005 ± 0.038	> 1.6
	F439W	F439W-F555W	4.943 ± 0.100	0.039 ± 0.042	0.000 ± 0.000	5.265 ± 3.528	-0.099 ± 4.717	-0.033 ± 1.572	< 1.6
						5.060 ± 0.132	-0.077 ± 0.106	0.031 ± 0.021	> 1.6
	F439W	F439W-F606W				5.273 ± 2.769	-0.107 ± 3.074	-0.011 ± 0.850	< 2.0
						5.042 ± 0.122	-0.048 ± 0.078	0.017 ± 0.012	> 2.0
	F439W	F439W-F675W				5.140 ± 0.390	-0.104 ± 0.871	-0.004 ± 0.474	< 1.2
					5.010 ± 0.050	-0.010 ± 0.038	0.011 ± 0.007	> 1.2	
F439W	F439W-F814W	5.011 ± 0.103	0.018 ± 0.094	-0.002 ± 0.020	5.088 ± 0.038	-0.140 ± 0.150	0.067 ± 0.126	< 1.1	
					5.014 ± 0.054	-0.003 ± 0.042	0.009 ± 0.008	> 1.1	
F439W	F439W-F850LP				4.943 ± 0.341	-0.088 ± 0.531	-0.008 ± 0.201	< -0.9	
					5.033 ± 0.007	0.030 ± 0.009	0.002 ± 0.003	> -0.9	
F555W	F555W	F336W-F555W				3.430 ± 0.035	0.011 ± 0.018	-0.004 ± 0.002
						3.410 ± 0.068	0.045 ± 0.058	-0.020 ± 0.012
	F555W	F555W-F606W	3.565 ± 0.130	-0.067 ± 0.054	0.000 ± 0.000	3.421 ± 0.034	0.118 ± 0.112	-0.257 ± 0.087
						3.404 ± 0.006	-0.091 ± 0.011	-0.070 ± 0.019
	F555W	F555W-F814W	3.406 ± 0.022	-0.070 ± 0.046	0.000 ± 0.000	3.395 ± 0.007	-0.065 ± 0.011	-0.027 ± 0.015
						3.291 ± 0.190	-0.093 ± 0.170	-0.015 ± 0.037	< -1.5
			3.314 ± 0.013	-0.026 ± 0.013	0.021 ± 0.014	> -1.5			
F606W	F606W	F336W-F606W				3.718 ± 0.081	0.033 ± 0.062	-0.009 ± 0.011	< 4.0
						3.826 ± 0.133	-0.045 ± 0.047	0.003 ± 0.004	> 4.0
	F606W	F439W-F606W				3.895 ± 0.041	-0.106 ± 0.028	0.011 ± 0.004
						3.846 ± 0.019	-0.406 ± 0.058	0.196 ± 0.040
	F606W	F555W-F606W				3.580 ± 0.141	-0.169 ± 0.399	0.011 ± 0.274	< -0.5
						3.638 ± 0.009	0.045 ± 0.023	0.184 ± 0.067	> -0.5
	F606W	F606W-F814W				3.605 ± 0.215	-0.115 ± 0.371	-0.011 ± 0.157	< -0.8
					3.633 ± 0.007	-0.032 ± 0.009	0.045 ± 0.010	> -0.8	
			3.383 ± 0.343	-0.175 ± 0.253	-0.019 ± 0.046	< -2.2			
F625W	F675W	F336W-F675W				3.643 ± 0.011	0.032 ± 0.020	0.021 ± 0.010	> -2.2
						3.661 ± 0.132	0.227 ± 0.104	-0.057 ± 0.020	< 3.6
	F675W	F439W-F675W				3.705 ± 0.135	0.037 ± 0.052	-0.008 ± 0.005	> 3.6
						4.022 ± 0.041	-0.148 ± 0.057	0.011 ± 0.018	< 2.6
	F675W	F555W-F675W				3.394 ± 0.297	0.266 ± 0.179	-0.056 ± 0.027	> 2.6
						3.741 ± 0.005	-0.261 ± 0.010	-0.002 ± 0.025
	F675W	F606W-F675W				3.417 ± 0.029	-0.617 ± 0.102	-0.090 ± 0.083
					3.645 ± 0.082	-0.729 ± 0.452	-0.401 ± 0.591	< -0.2	
			3.682 ± 0.006	-0.381 ± 0.040	0.156 ± 0.248	> -0.2			
F775W	F814W	F336W-F814W				2.087 ± 0.557	-1.470 ± 0.554	-0.294 ± 0.136	< -1.7
						3.445 ± 0.055	-0.083 ± 0.096	0.055 ± 0.041	> -1.7
	F814W	F439W-F814W				3.655 ± 0.012	-0.018 ± 0.007	-0.001 ± 0.001
						3.665 ± 0.018	-0.071 ± 0.039	0.017 ± 0.018	< 2.0
	F814W	F555W-F814W				3.565 ± 0.046	0.032 ± 0.025	-0.012 ± 0.003	> 2.0
						3.609 ± 0.098	0.057 ± 0.232	0.078 ± 0.130	< -0.5
	F814W	F606W-F814W				3.568 ± 0.005	-0.076 ± 0.018	-0.007 ± 0.032	> -0.5
					3.682 ± 0.313	0.210 ± 0.520	0.130 ± 0.213	< -0.9	
			3.498 ± 0.007	-0.116 ± 0.009	-0.005 ± 0.015	> -0.9			
F814W	F814W	F675W-F814W				3.594 ± 0.082	0.064 ± 0.452	0.332 ± 0.591	< -0.2
						3.551 ± 0.004	-0.192 ± 0.032	0.021 ± 0.038	> -0.2
	F814W	F814W-F850LP				2.638 ± 0.070	-0.906 ± 0.106	-0.191 ± 0.040
						3.911 ± 0.010	0.006 ± 0.008	0.000 ± 0.002	< 5.0
	F814W	F336W-F814W				4.221 ± 0.135	-0.100 ± 0.040	0.009 ± 0.003	> 5.0
						3.912 ± 0.009	0.012 ± 0.011	-0.001 ± 0.003	< 3.5
	F814W	F439W-F814W	3.928 ± 0.054	0.003 ± 0.021	0.000 ± 0.000	4.095 ± 0.199	-0.083 ± 0.086	0.012 ± 0.009	> 3.5
					3.940 ± 0.003	0.023 ± 0.006	0.002 ± 0.007	
F814W	F555W-F814W	3.937 ± 0.012	0.010 ± 0.031	0.000 ± 0.000	3.962 ± 0.004	0.037 ± 0.005	0.004 ± 0.005	
					3.945 ± 0.003	0.060 ± 0.008	-0.002 ± 0.013	
F850LP	F850LPW	F336W-F850LP				4.243 ± 0.113	0.295 ± 0.156	0.062 ± 0.054	< -1.0
						4.183 ± 0.074	0.177 ± 0.245	0.001 ± 0.185	> -1.0
	F850LP	F439W-F850LP				4.599 ± 0.019	-0.000 ± 0.043	0.001 ± 0.021	< 0.0
						4.603 ± 0.008	0.001 ± 0.004	0.000 ± 0.001	> 0.0
	F850LP	F555W-F850LP				4.608 ± 0.013	0.016 ± 0.032	0.008 ± 0.018	< 0.0
						4.608 ± 0.007	-0.003 ± 0.007	0.001 ± 0.001	> 0.0
				4.763 ± 0.315	0.124 ± 0.247	0.023 ± 0.048	< -2.0		
			4.606 ± 0.005	0.003 ± 0.003	0.002 ± 0.001	> -2.0			

Table 21—Continued

SOURCE SMAG	TARGET		Observed			c0	Synthetic			TCOL range
	TMAG	TCOL	c0	c1	c2		c1	c2		
	F850LP	F606W-F850LP		4.931 ± 0.649	0.222 ± 0.446	0.037 ± 0.076	< -2.5			
				4.609 ± 0.008	0.004 ± 0.012	0.001 ± 0.005	> -2.5			
	F850LP	F675W-F850LP		4.945 ± 0.633	0.323 ± 0.611	0.076 ± 0.146	< -1.8			
				4.609 ± 0.007	0.006 ± 0.011	0.002 ± 0.007	> -1.8			
	F850LP	F814W-F850LP		5.034 ± 1.139	0.497 ± 1.373	0.143 ± 0.413	< -1.5			
				4.683 ± 0.038	0.117 ± 0.076	0.044 ± 0.036	> -1.5			

Table 22. AB Colors of the E/S0 Template from Benítez et al. (2004) in the WFC Filter System

z	F435W-F606W	F475W-F606W	F555W-F606W	F625W-F606W	F775W-F606W	F814W-F606W	F850LP-F606W
0.01	1.06	0.63	0.24	-0.16	-0.52	-0.58	-0.74
0.06	1.26	0.72	0.25	-0.16	-0.56	-0.63	-0.79
0.11	1.46	0.80	0.27	-0.17	-0.61	-0.68	-0.86
0.16	1.60	0.93	0.30	-0.19	-0.65	-0.73	-0.93
0.21	1.76	1.06	0.34	-0.23	-0.71	-0.80	-1.01
0.26	1.75	1.17	0.42	-0.26	-0.77	-0.87	-1.10
0.31	1.79	1.25	0.52	-0.29	-0.84	-0.94	-1.19
0.36	1.83	1.34	0.62	-0.32	-0.91	-1.01	-1.28
0.41	1.90	1.39	0.70	-0.33	-0.96	-1.07	-1.36
0.46	1.99	1.36	0.74	-0.32	-1.05	-1.16	-1.46
0.51	2.10	1.37	0.74	-0.30	-1.16	-1.28	-1.58
0.56	2.19	1.36	0.69	-0.28	-1.28	-1.41	-1.72
0.61	2.28	1.36	0.62	-0.27	-1.39	-1.52	-1.84
0.66	2.40	1.41	0.59	-0.27	-1.47	-1.61	-1.95
0.71	2.50	1.48	0.58	-0.27	-1.53	-1.69	-2.06
0.76	2.54	1.55	0.56	-0.27	-1.59	-1.78	-2.20
0.81	2.57	1.61	0.60	-0.32	-1.59	-1.82	-2.30
0.86	2.60	1.74	0.71	-0.35	-1.51	-1.80	-2.35
0.91	2.57	1.84	0.82	-0.35	-1.46	-1.80	-2.40
0.96	2.50	1.89	0.90	-0.38	-1.45	-1.82	-2.46
1.01	2.44	1.94	0.98	-0.39	-1.44	-1.82	-2.50

Table 23. AB Colors of the Sbc Template from Benítez et al. (2004) in the WFC Filter System^a

z	F435W-F606W	F475W-F606W	F555W-F606W	F625W-F606W	F775W-F606W	F814W-F606W	F850LP-F606W
0.01	0.75	0.47	0.18	-0.13	-0.42	-0.48	-0.64
0.06	0.86	0.52	0.19	-0.13	-0.45	-0.51	-0.66
0.11	0.98	0.57	0.21	-0.14	-0.48	-0.54	-0.70
0.16	1.11	0.65	0.22	-0.15	-0.51	-0.58	-0.74
0.21	1.26	0.74	0.24	-0.16	-0.54	-0.61	-0.79
0.26	1.38	0.82	0.27	-0.18	-0.58	-0.66	-0.85
0.31	1.48	0.90	0.31	-0.21	-0.63	-0.71	-0.91
0.36	1.54	1.00	0.37	-0.23	-0.67	-0.75	-0.96
0.41	1.58	1.08	0.43	-0.26	-0.72	-0.80	-1.03
0.46	1.58	1.12	0.49	-0.27	-0.78	-0.87	-1.10
0.51	1.54	1.14	0.54	-0.28	-0.85	-0.94	-1.19
0.56	1.47	1.13	0.58	-0.29	-0.93	-1.03	-1.27
0.61	1.39	1.11	0.60	-0.29	-1.01	-1.11	-1.36
0.66	1.30	1.07	0.61	-0.29	-1.08	-1.18	-1.44
0.71	1.20	0.99	0.60	-0.28	-1.15	-1.26	-1.54
0.76	1.10	0.91	0.57	-0.25	-1.22	-1.34	-1.63
0.81	1.00	0.82	0.53	-0.24	-1.26	-1.40	-1.72
0.86	0.91	0.74	0.48	-0.22	-1.28	-1.44	-1.80
0.91	0.83	0.67	0.42	-0.20	-1.28	-1.47	-1.86
0.96	0.76	0.60	0.38	-0.19	-1.27	-1.47	-1.90
1.01	0.70	0.55	0.33	-0.16	-1.24	-1.46	-1.93

Table 24. AB Colors of the Im Template from Benítez et al. (2004) in the WFC Filter System

z	F435W-F606W	F475W-F606W	F555W-F606W	F625W-F606W	F775W-F606W	F814W-F606W	F850LP-F606W
0.01	0.36	0.19	0.06	-0.04	-0.20	-0.23	-0.31
0.06	0.42	0.21	0.05	-0.03	-0.21	-0.24	-0.32
0.11	0.50	0.28	0.05	-0.04	-0.22	-0.25	-0.33
0.16	0.59	0.34	0.06	-0.08	-0.22	-0.26	-0.35
0.21	0.68	0.40	0.10	-0.10	-0.23	-0.27	-0.36
0.26	0.76	0.47	0.15	-0.11	-0.23	-0.27	-0.38
0.31	0.87	0.52	0.18	-0.13	-0.24	-0.28	-0.40
0.36	0.86	0.57	0.21	-0.15	-0.27	-0.31	-0.43
0.41	0.84	0.60	0.24	-0.14	-0.35	-0.37	-0.47
0.46	0.77	0.58	0.24	-0.16	-0.46	-0.48	-0.55
0.51	0.72	0.60	0.27	-0.20	-0.52	-0.54	-0.59
0.56	0.66	0.56	0.30	-0.20	-0.57	-0.59	-0.64
0.61	0.60	0.52	0.32	-0.19	-0.62	-0.64	-0.69
0.66	0.53	0.47	0.33	-0.18	-0.65	-0.68	-0.77
0.71	0.47	0.42	0.30	-0.17	-0.66	-0.72	-0.87
0.76	0.40	0.36	0.26	-0.14	-0.66	-0.75	-0.93
0.81	0.34	0.31	0.23	-0.12	-0.68	-0.78	-0.97
0.86	0.28	0.25	0.19	-0.10	-0.70	-0.79	-1.00
0.91	0.22	0.19	0.13	-0.06	-0.72	-0.82	-1.03
0.96	0.18	0.15	0.10	-0.07	-0.70	-0.80	-1.03
1.01	0.16	0.13	0.09	-0.05	-0.64	-0.75	-1.02

Table 25. Multi-instrument Colors of the E/S0 Template from Benítez et al. (2004) in the HRC System (AB mag) and WFC F606W (AB mag)

z	H _{F220W} - W _{F606W}	H _{F250W} - W _{F606W}	H _{F330W} - W _{F606W}	H _{F435W} - W _{F606W}	H _{F475W} - W _{F606W}	H _{F555W} - W _{F606W}	H _{F606W} - W _{F606W}	H _{F625W} - W _{F606W}	H _{F775W} - W _{F606W}	H _{F814W} - W _{F606W}	H _{F850LP} - W _{F606W}
0.01	5.42	4.08	2.54	1.06	0.61	0.24	0.01	-0.15	-0.51	-0.59	-0.76
0.06	5.53	4.39	2.69	1.26	0.69	0.25	0.01	-0.16	-0.56	-0.64	-0.80
0.11	5.61	4.64	2.88	1.45	0.77	0.27	0.01	-0.16	-0.60	-0.68	-0.87
0.16	5.67	4.82	3.14	1.59	0.89	0.31	0.02	-0.18	-0.64	-0.74	-0.95
0.21	5.70	4.92	3.39	1.76	1.02	0.34	0.02	-0.22	-0.70	-0.81	-1.03
0.26	5.69	4.98	3.66	1.76	1.14	0.43	0.02	-0.26	-0.76	-0.88	-1.12
0.31	5.64	5.00	3.91	1.79	1.22	0.53	0.03	-0.28	-0.83	-0.95	-1.21
0.36	5.55	5.00	4.09	1.83	1.31	0.63	0.03	-0.31	-0.90	-1.03	-1.30
0.41	5.46	4.99	4.17	1.90	1.36	0.71	0.03	-0.32	-0.95	-1.09	-1.38
0.46	5.33	4.95	4.14	1.98	1.33	0.75	0.03	-0.30	-1.04	-1.18	-1.48
0.51	5.17	4.87	4.05	2.10	1.33	0.75	0.04	-0.28	-1.16	-1.30	-1.61
0.56	5.00	4.75	3.95	2.19	1.32	0.69	0.03	-0.26	-1.28	-1.43	-1.74
0.61	4.84	4.62	3.87	2.27	1.32	0.62	0.03	-0.25	-1.38	-1.54	-1.87
0.66	4.69	4.48	3.82	2.38	1.36	0.60	0.03	-0.26	-1.45	-1.63	-1.98
0.71	4.55	4.34	3.78	2.48	1.43	0.59	0.03	-0.26	-1.52	-1.71	-2.09
0.76	4.41	4.17	3.72	2.53	1.50	0.57	0.03	-0.26	-1.58	-1.80	-2.22
0.81	4.29	4.03	3.66	2.57	1.57	0.61	0.03	-0.32	-1.57	-1.85	-2.33
0.86	4.23	3.94	3.64	2.60	1.70	0.72	0.03	-0.34	-1.49	-1.83	-2.38
0.91	4.16	3.83	3.57	2.58	1.81	0.83	0.04	-0.34	-1.44	-1.85	-2.44
0.96	4.06	3.70	3.46	2.51	1.87	0.91	0.04	-0.36	-1.43	-1.87	-2.51
1.01	3.98	3.59	3.35	2.44	1.91	1.00	0.04	-0.37	-1.43	-1.87	-2.56

Table 26. Multi-instrument Colors of the Sbc Template from Benítez et al. (2004) in the HRC System (AB mag) and WFC F606W (AB mag)

z	H _{F220W} - W _{F606W}	H _{F250W} - W _{F606W}	H _{F330W} - W _{F606W}	H _{F435W} - W _{F606W}	H _{F475W} - W _{F606W}	H _{F555W} - W _{F606W}	H _{F606W} - W _{F606W}	H _{F625W} - W _{F606W}	H _{F775W} - W _{F606W}	H _{F814W} - W _{F606W}	H _{F850LP} - W _{F606W}
0.01	3.12	2.78	2.05	0.75	0.46	0.19	0.01	-0.12	-0.42	-0.48	-0.65
0.06	3.10	2.79	2.20	0.86	0.50	0.19	0.01	-0.13	-0.45	-0.51	-0.67
0.11	3.08	2.78	2.31	0.98	0.55	0.21	0.01	-0.13	-0.48	-0.55	-0.71
0.16	3.06	2.76	2.35	1.11	0.62	0.22	0.01	-0.14	-0.51	-0.58	-0.75
0.21	3.05	2.73	2.35	1.26	0.71	0.24	0.01	-0.16	-0.54	-0.62	-0.80
0.26	3.04	2.68	2.33	1.38	0.79	0.27	0.02	-0.18	-0.58	-0.67	-0.86
0.31	3.03	2.63	2.28	1.47	0.87	0.32	0.02	-0.20	-0.63	-0.72	-0.93
0.36	3.03	2.58	2.23	1.53	0.97	0.38	0.02	-0.23	-0.66	-0.76	-0.98
0.41	3.02	2.52	2.17	1.58	1.05	0.44	0.02	-0.25	-0.71	-0.82	-1.05
0.46	3.00	2.47	2.10	1.58	1.10	0.50	0.02	-0.26	-0.77	-0.88	-1.12
0.51	2.98	2.41	2.01	1.54	1.12	0.55	0.03	-0.27	-0.84	-0.96	-1.21
0.56	2.94	2.35	1.91	1.47	1.12	0.59	0.03	-0.27	-0.92	-1.04	-1.30
0.61	2.90	2.28	1.80	1.39	1.09	0.61	0.03	-0.28	-1.00	-1.13	-1.38
0.66	2.86	2.23	1.70	1.30	1.05	0.62	0.03	-0.27	-1.07	-1.20	-1.47
0.71	2.81	2.17	1.59	1.20	0.98	0.60	0.03	-0.26	-1.14	-1.28	-1.56
0.76	2.76	2.11	1.49	1.10	0.90	0.57	0.03	-0.24	-1.21	-1.35	-1.66
0.81	2.72	2.06	1.40	1.00	0.81	0.53	0.03	-0.23	-1.25	-1.42	-1.75
0.86	2.69	2.02	1.33	0.91	0.73	0.48	0.03	-0.21	-1.27	-1.46	-1.82
0.91	2.67	1.99	1.28	0.83	0.66	0.43	0.02	-0.19	-1.27	-1.49	-1.89
0.96	2.66	1.98	1.25	0.76	0.59	0.38	0.02	-0.18	-1.25	-1.50	-1.93
1.01	2.66	1.97	1.23	0.70	0.54	0.33	0.02	-0.15	-1.22	-1.49	-1.96

Table 27. Multi-instrument Colors of the Im Template from Benítez et al. (2004) in the HRC System (AB mag) and WFC F606W (AB mag)

z	H _{F220W} - W _{F606W}	H _{F250W} - W _{F606W}	H _{F330W} - W _{F606W}	H _{F435W} - W _{F606W}	H _{F475W} - W _{F606W}	H _{F555W} - W _{F606W}	H _{F606W} - W _{F606W}	H _{F625W} - W _{F606W}	H _{F775W} - W _{F606W}	H _{F814W} - W _{F606W}	H _{F850LP} - W _{F606W}
0.01	1.41	1.34	1.12	0.36	0.18	0.06	0.00	-0.03	-0.20	-0.24	-0.32
0.06	1.38	1.32	1.15	0.43	0.19	0.05	0.00	-0.03	-0.21	-0.24	-0.33
0.11	1.36	1.30	1.17	0.50	0.27	0.05	0.00	-0.04	-0.21	-0.25	-0.34
0.16	1.34	1.27	1.18	0.59	0.33	0.07	0.00	-0.08	-0.22	-0.26	-0.36
0.21	1.33	1.23	1.16	0.68	0.39	0.10	0.01	-0.10	-0.23	-0.27	-0.37
0.26	1.33	1.20	1.13	0.76	0.45	0.15	0.01	-0.11	-0.23	-0.28	-0.39
0.31	1.32	1.17	1.10	0.87	0.51	0.18	0.01	-0.13	-0.24	-0.29	-0.41
0.36	1.30	1.13	1.05	0.86	0.55	0.21	0.01	-0.15	-0.26	-0.32	-0.44
0.41	1.28	1.08	0.99	0.84	0.59	0.25	0.02	-0.13	-0.35	-0.38	-0.48
0.46	1.21	1.00	0.88	0.77	0.57	0.25	0.01	-0.16	-0.47	-0.49	-0.56
0.51	1.18	0.95	0.81	0.72	0.59	0.28	0.01	-0.19	-0.52	-0.54	-0.60
0.56	1.15	0.90	0.74	0.66	0.56	0.31	0.02	-0.19	-0.57	-0.59	-0.65
0.61	1.12	0.86	0.68	0.60	0.51	0.32	0.02	-0.18	-0.61	-0.64	-0.70
0.66	1.09	0.82	0.61	0.53	0.47	0.34	0.02	-0.17	-0.64	-0.68	-0.77
0.71	1.07	0.78	0.55	0.47	0.41	0.30	0.02	-0.16	-0.65	-0.72	-0.86
0.76	1.04	0.75	0.49	0.40	0.36	0.26	0.02	-0.13	-0.66	-0.76	-0.93
0.81	1.03	0.72	0.45	0.34	0.30	0.23	0.01	-0.11	-0.67	-0.79	-0.97
0.86	1.02	0.70	0.41	0.28	0.25	0.19	0.01	-0.10	-0.69	-0.81	-1.01
0.91	1.00	0.66	0.36	0.22	0.19	0.13	0.01	-0.06	-0.72	-0.84	-1.05
0.96	1.01	0.66	0.35	0.18	0.15	0.10	0.01	-0.06	-0.69	-0.81	-1.06
1.01	1.04	0.68	0.35	0.16	0.13	0.09	0.01	-0.05	-0.63	-0.76	-1.04

Table 28. Multi-instrument Colors of the E/S0 Template from Benítez et al. (2004) in the Landolt System (VEGAMAG) and WFC F606W (VEGAMAG)

z	U-F606W	B-F606W	V-F606W	R-F606W	I-F606W
0.01	1.57	1.14	0.27	-0.33	-0.89
0.06	1.65	1.30	0.27	-0.34	-0.94
0.11	1.74	1.46	0.26	-0.36	-1.00
0.16	1.86	1.61	0.27	-0.38	-1.04
0.21	2.02	1.72	0.31	-0.42	-1.10
0.26	2.22	1.80	0.37	-0.47	-1.17
0.31	2.43	1.86	0.46	-0.51	-1.23
0.36	2.65	1.90	0.56	-0.54	-1.31
0.41	2.87	1.96	0.64	-0.55	-1.37
0.46	3.03	2.01	0.68	-0.57	-1.44
0.51	3.09	2.06	0.67	-0.58	-1.56
0.56	3.05	2.12	0.62	-0.61	-1.68
0.61	2.96	2.19	0.57	-0.64	-1.81
0.66	2.86	2.28	0.53	-0.66	-1.91
0.71	2.78	2.36	0.51	-0.68	-1.99
0.76	2.70	2.41	0.49	-0.72	-2.07
0.81	2.65	2.47	0.51	-0.73	-2.09
0.86	2.66	2.54	0.60	-0.70	-2.03
0.91	2.65	2.57	0.69	-0.69	-1.97
0.96	2.59	2.55	0.76	-0.70	-1.95
1.01	2.54	2.53	0.85	-0.71	-1.93

Table 29. Multi-instrument Colors of the Sbc Template from Benítez et al. (2004) in the Landolt System (VEGAMAG) and WFC F606W (VEGAMAG)^a

z	U-F606W	B-F606W	V-F606W	R-F606W	I-F606W
0.01	0.96	0.88	0.22	-0.29	-0.79
0.06	1.15	0.97	0.22	-0.30	-0.83
0.11	1.30	1.07	0.22	-0.31	-0.86
0.16	1.42	1.19	0.23	-0.32	-0.89
0.21	1.50	1.31	0.24	-0.34	-0.92
0.26	1.52	1.42	0.26	-0.37	-0.96
0.31	1.49	1.52	0.29	-0.40	-1.02
0.36	1.46	1.60	0.34	-0.42	-1.06
0.41	1.40	1.65	0.40	-0.45	-1.11
0.46	1.34	1.66	0.45	-0.48	-1.17
0.51	1.25	1.64	0.49	-0.50	-1.24
0.56	1.16	1.60	0.53	-0.53	-1.32
0.61	1.06	1.53	0.55	-0.55	-1.41
0.66	0.96	1.46	0.57	-0.55	-1.49
0.71	0.85	1.36	0.57	-0.57	-1.57
0.76	0.74	1.26	0.55	-0.58	-1.64
0.81	0.63	1.17	0.51	-0.58	-1.70
0.86	0.54	1.08	0.48	-0.57	-1.73
0.91	0.47	1.00	0.43	-0.55	-1.74
0.96	0.41	0.93	0.39	-0.53	-1.73
1.01	0.37	0.87	0.35	-0.50	-1.71

Table 30. Multi-instrument Colors of the Im Template from Benítez et al. (2004) in the Landolt System (VEGAMAG) and WFC F606W (VEGAMAG)^a

z	U-F606W	B-F606W	V-F606W	R-F606W	I-F606W
0.01	0.18	0.52	0.13	-0.18	-0.56
0.06	0.34	0.57	0.09	-0.17	-0.57
0.11	0.43	0.65	0.09	-0.17	-0.58
0.16	0.46	0.73	0.12	-0.22	-0.58
0.21	0.47	0.82	0.15	-0.24	-0.59
0.26	0.46	0.90	0.18	-0.25	-0.60
0.31	0.44	0.96	0.21	-0.25	-0.61
0.36	0.40	1.00	0.21	-0.27	-0.63
0.41	0.34	1.00	0.24	-0.29	-0.67
0.46	0.24	0.94	0.25	-0.34	-0.79
0.51	0.17	0.90	0.29	-0.37	-0.88
0.56	0.10	0.85	0.32	-0.39	-0.94
0.61	0.03	0.79	0.34	-0.38	-1.00
0.66	-0.04	0.73	0.34	-0.37	-1.05
0.71	-0.11	0.67	0.33	-0.36	-1.05
0.76	-0.17	0.61	0.31	-0.35	-1.04
0.81	-0.23	0.55	0.28	-0.33	-1.06
0.86	-0.28	0.49	0.24	-0.32	-1.08
0.91	-0.34	0.43	0.19	-0.32	-1.10
0.96	-0.36	0.39	0.17	-0.30	-1.11
1.01	-0.36	0.37	0.16	-0.27	-1.08

Table 31. S/N Calculation for Different Aperture Radii for WFC/F606W

Aperture radius		Area pix	EE %	Signal ADU	Main Noise Sources (ADU)			Other Noise (%)		Total Noise	S/N Ratio
Pix	arcsec				Source	Read Noise	Background	Breathing	Aperture corr.		
1	0.05	3.1	31.30	313.0	17.7	4.0	5.6	0.05	0.07	28.1	11.1
2	0.10	12.6	65.60	656.0	25.6	7.9	11.2	0.04	0.03	37.9	17.3
3	0.15	28.3	79.60	796.0	28.2	11.9	16.8	0.03	0.02	36.3	22.0
4	0.20	50.3	84.50	845.0	29.1	15.9	22.4	0.02	0.02	35.6	23.7
5	0.25	78.5	87.10	871.0	29.5	19.8	28.0	0.01	0.01	37.9	23.0
6	0.30	13.1	89.00	890.0	29.8	23.8	33.6	0.00	0.01	43.0	20.7
7	0.35	153.9	90.00	900.0	30.0	27.7	39.2	0.00	0.01	49.5	18.2
8	0.40	201.1	90.80	908.0	30.1	31.7	44.8	0.00	0.01	56.1	16.2
9	0.45	254.5	91.40	914.0	30.2	35.7	50.4	0.00	0.01	62.8	14.6
10	0.50	314.2	92.00	920.0	30.3	39.6	56.0	0.00	0.01	69.5	13.2
15	0.75	706.8	94.10	941.0	30.7	59.4	84.1	0.00	0.01	103.4	9.1
20	1.00	1256.6	95.20	952.0	30.9	79.3	112.1	0.00	0.00	137.6	6.9

^aFor this simulation we assumed a flux of 1000 electrons in the infinite aperture and a background level of 10 electrons.