

# Cosmic-Ray Detection System using Internet

T. Hamaguchi<sup>a</sup>, M. Katsumata<sup>a</sup>, E. Nakano<sup>a</sup>, T. Takahashi<sup>a</sup>, Y. Teramoto<sup>a</sup>, Y. Saito<sup>b</sup>,  
Y. Sasaki<sup>c</sup>, M. Honda<sup>d</sup>, Y.S. Honda<sup>d</sup>

<sup>a</sup>*Institute for Cosmic Ray Physics, Osaka City University, Osaka 558-8585, Japan*

<sup>b</sup>*Osaka Science Museum, Osaka 530-0005, Japan*

<sup>c</sup>*Izumiootsu High School, Osaka 595-0012, Japan*

<sup>d</sup>*Kinki University Technical College, Mie 519-4395, Japan*

## Abstract

A cosmic ray detection system, consisting of standardized detector stations connected through the Internet, is described. The system can be used for detecting air showers that arrive over a wide area with correlated time. The data at each site are exchanged in (quasi) real time, which makes the system suitable for displaying cosmic ray arrivals at museums and schools.

PACS: 95.55.Vj

## 1 Introduction

Hints of a time correlation between cosmic ray air showers have been observed using detectors placed over a  $100 \times 100 \text{ km}^2$  area (1; 2). Kitamura et al. (2) reported evidence for time-correlated events that were detected by two air shower arrays located 115 km apart; one at Kinki University, located in Osaka, and the other at the Mitsuishi Observatory of Osaka City University, located in Okayama. This report raised the question of the possible existence of high energy cosmic ray phenomena that extend over large distances. In the United States and Canada, a network of cosmic ray detector: the North American Large Area Time Coincidence Array (NALTA) has been built and is now being operated (3; 4). In Europe, before the large LEP detectors were closed, studies of cosmic ray muons had been done by the ALEPH and L3 detectors with an extended air shower array (5; 6). Our project was started with the similar motivation. The system consists of standardized detector stations. Each station has four scintillation counters and it can locally detect and reconstruct air showers. We call this station a “cosmic ray station (CRS)”. These stations are connected through the Internet. They exchange data in (quasi) real time. This makes the system suitable for displaying the arriving cosmic rays over a wide area at the museums and schools. The network can be extended by simply adding more stations.

Detecting time-correlated cosmic rays are usually done by observing the signs of the event rate enhancements or observing the chaotic behavior in the arrival time series. Both phenomena, however, could also happen accidentally. If the observation is done at one location, it is difficult to distinguish the real ones from fakes. To reject these fakes, simultaneous measurements at multiple locations are crucial.

## 2 Detector

One station consists of four scintillation counters, a data acquisition box (DA box) that has all the electronics for the station, a Windows PC with a network interface, and a Global Positioning System (GPS) antenna, as shown in Fig. 1. Each scintillation counter is comprised of a pyramid-shaped vessel containing  $70 \times 70 \times 4 \text{ cm}^3$  plastic scintillator at the bottom and a Hamamatsu

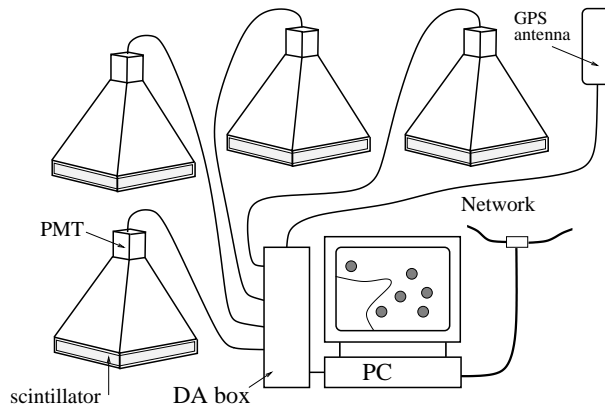

Figure 1: Schematics of one Cosmic Ray Station (CRS).

H6410 2" Photo-Multiplier Tube (PMT) at the top facing down to the scintillator. Each counter is equipped with a Light Emitting Diode (LED) for calibration by test pulses. The vessel is covered by a soft white polyvinyl chloride sheet for protecting the detector from rain. The DA box has 4 channels of ADCs and TDCs, each having 12-bit resolution, to measure the pulse height and timing of the signals from the four scintillation counters, as shown in Fig. 2. Triggers are made of coincidences of hits (100 ns width) in either two or three out of four counters. The selection is done by a switch on the front panel. The box has LED drivers, a GPS receiver, a precision clock IC and a 1 MHz oscillator with a counter that is synchronized to the GPS signals. The system can measure the trigger time with an accuracy of  $1 \mu\text{s}$ . The box also has a high voltage power supply for the PMTs. The control circuit is made with an Altera Field Programmable Gate Array (FPGA) and it is externally controlled by a PC via the IO registers.

The IO registers are used to communicate with the PC through a commercially available 16-bit IO board connected to the PCI bus. The assignments of the functions and data to the IO registers are shown in Fig. 3. In the READ mode, a trigger (T) sets the bit 8 in the "Time L" register. The trigger time is stored in the "RT" register (clock IC) and in the "Time L" and "Time H" registers ( $1 \mu\text{s}$  counter). Four 4-bit data in the "RT" register, starting from the LSB, show the first digit ( $10^0$ ) of the seconds, the second digit ( $10^1$ ) of the seconds, the first digit ( $10^0$ ) of the minutes, and the second digit ( $10^1$ ) of the minutes. The "Time L" register (L, M) and the low order byte (H) in the "Time H" register have the GPS time in  $\mu\text{s}$ , measured by the 1 MHz oscillator. In the WRITE mode, one can start or stop a run by setting or resetting bit 8 in the "Control 1" register. By setting the bit 1 in the same register, a test pulse is generated. Bit 0 in the same register is used to reset the system. The clock IC is forced to synchronize to the GPS by setting the bit 0 in the "Control 2" register.

The online software consists of three processes: a data acquisition process, an event display process, and a histogram display process, as shown in Fig. 4. They are written in Microsoft Visual C++ 6.0 (VC++6.0) and intended to run on a Windows 2000 PC. The data acquisition process is a multi-thread system. It is controlled through a control panel made of a dialog box of VC++6.0 (Fig. 5). The histograms and event displays are multi-window type applications of the document-view scheme.

When the data acquisition process is evoked, it reads a site configuration file, which is specific to the station. It includes the site ID, group ID, the site location (latitude, longitude, altitude), scintillator positions in the local coordinate system, TDC gains, TDC T0s, ADC gains, ADC pedestals, and the HTTP\_center's IP address to connect. The HTTP\_center is a server process to

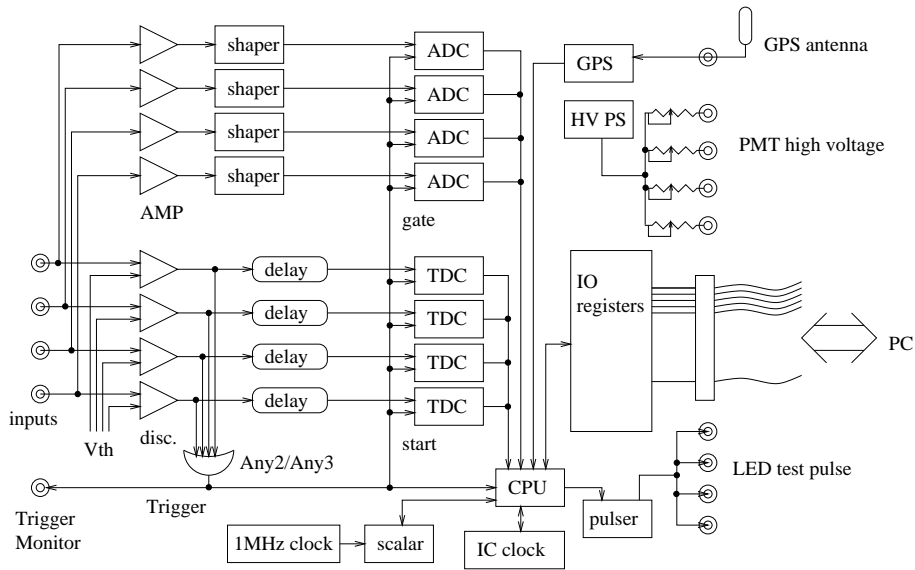

Figure 2: Block diagram of the circuit in a DA box.

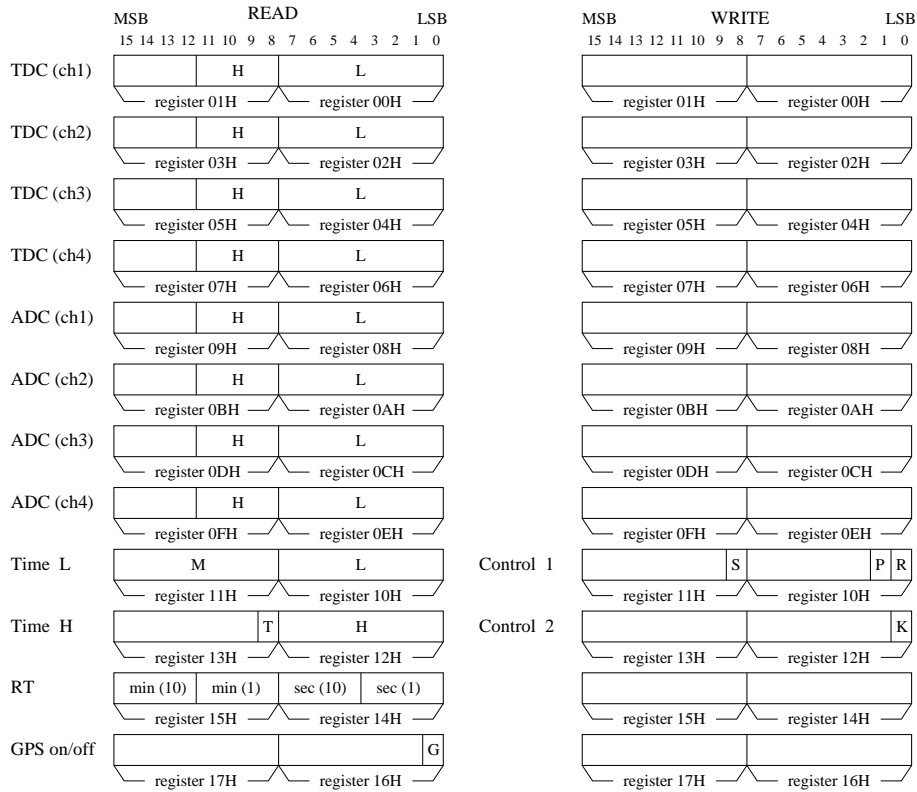

Figure 3: Functions and data assignments of the IO registers. T: trigger (yes/no)=(1/0), S: run (start/stop)=(1/0), P: generate a test pulse (1), R: reset the system (1), K: set the clock IC (1).

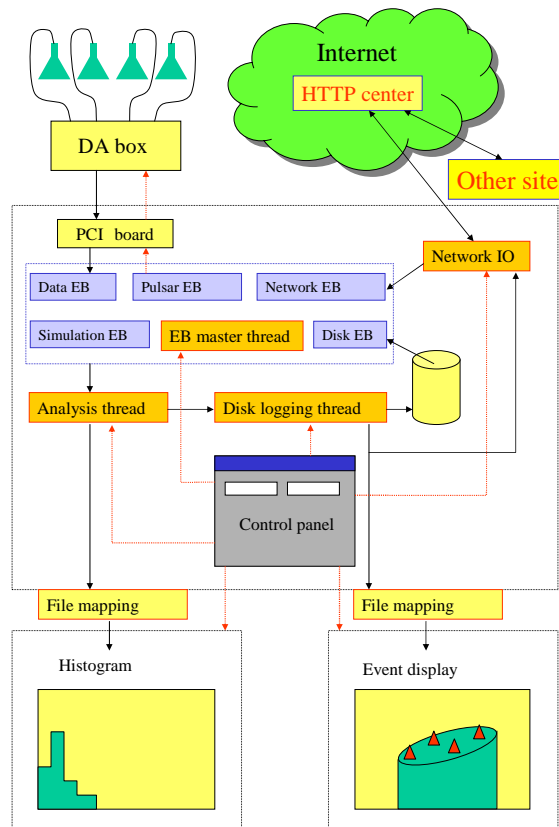

Figure 4: Block diagram of the online software. The arrows with solid lines show the data flows. The command (message) flows are shown by the arrows with broken lines.

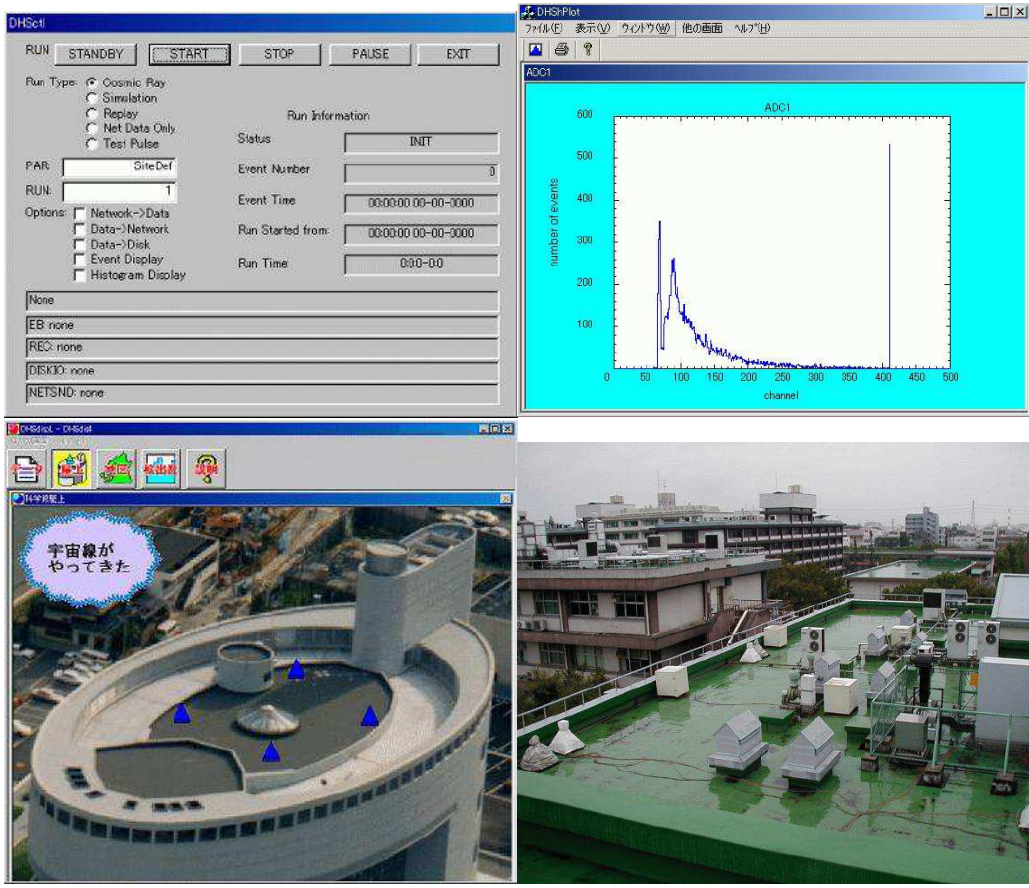

Figure 5: Examples of displays and a detector array. Control panel (top left), histogram (top right) and event display (bottom left). In the event display, four scintillation counters are shown by small triangles on the roof. When triggers are made, these triangles change color for a few seconds with a phrase in Japanese at the top left corner of the window. Scintillation counters (ones with brighter white covers) on the roof of the Faculty of Science building at the Osaka City University (bottom right).

Table 1: Data format.

m_Length			
m_ID			
m_GPS_Stat	m_groupID	m_runN	
m_eventN			
m_runType	m_eventType	m_Sec	m_Min
m_Hour	m_Day	m_Month	m_Year
m_Latitude			
m_Longitude			
m_Altitude			
m_SciLoc[0].x()			
m_SciLoc[0].y()			
m_SciLoc[0].z()			
:			
m_SciLoc[3].x()			
m_SciLoc[3].y()			
m_SciLoc[3].z()			
m_ADCpedestal[0]		m_ADCpedestal[1]	
m_ADCpedestal[2]		m_ADCpedestal[3]	
m_TDctzero[0]		m_TDctzero[1]	
m_TDctzero[2]		m_TDctzero[3]	
m_ADC[0]		m_ADC[1]	
m_ADC[2]		m_ADC[3]	
m_TDC[0]		m_TDC[1]	
m_TDC[2]		m_TDC[3]	
m_ADCgain[0]			
m_ADCgain[1]			
m_ADCgain[2]			
m_TDCgain[3]			
m_TDCgain[0]			
m_TDCgain[1]			
m_TDCgain[2]			
m_TDCgain[3]			
m_uSecData			
m_SecData		m_MinData	
m_ASzenith			
m_ASazimuth			
m_ASchi2			
Delineating			

receive and distribute the data to and from each station.

Data are handled as C++ objects, which are common among the data acquisition program running in a Windows PC and the analysis program running in a Linux PC. The data format is listed in Table 1. At transferring data from one thread to another one in the program, the data objects are queued at each receiving thread with a specified depth (typically set to 10). This enables us to detect burst-type cosmic ray events. In the event display, the depth of the data queue is set to one since we do not have to display all the events.

Data exchange between the stations is done through the Internet via a server (the HTTP\_center) using HTTP as the protocol. The reason for using HTTP is to pass the firewall of the site. It can transfer the data through the HTTP proxies to and from the center. To send data from a station to the center, the POST command of the protocol is issued by the network IO thread in the DA process. In the center, the received data are stored in a queue. To receive the data from the center, a polling scheme is used. The station periodically issues a GET command (currently two seconds in the Windows PCs). To keep track of the last sent event number to the station, the center has a list of entries that have the last event positions in the queue for all stations. By receiving the GET command, the center looks at this number for the station. It then sends all the data stored in the queue after that number. By this scheme, we distribute the data to all

Table 2: Site locations.

station name	location		altitude
	latitude	longitude	
Osaka City Univ.	34.35'20"	135.30'20"	sea level
Osaka Science Museum	34.41'10"	135.29'30"	sea level
Izumiootsu High School	34.29'20"	135.28'00"	sea level
Kinki Univ. Technical College	33.40'40"	136.02'50"	sea level

stations in the “quasi-real” time. In addition, since the link between the station and the center is a one-time connection, each station can start or stop at any time without disturbing the entire observation network.

Analysis programs use the same protocol to receive the data from the center. It runs in a Linux PC and is written with gnu C++ (g++). We use an analysis program frame to store (or read) the data of all stations in the disk.

### 3 Operation and Performance

The system has been operated using the stations at the Osaka City University and Osaka Science Museum since 2000. At both sites, the scintillation counters were placed on the roof. They are positioned at the corners of an approximately  $10 \times 10 \text{ m}^2$  square, as shown in Fig. 5.

For data taking, the operating voltages of the PMTs are set to approximately 1.6 kV and the discriminator levels are set to 25 mV. The trigger condition is selected as three-out-of-four. The trigger rates in both locations are approximately 3 per minute.

At the museum, only the event displays are shown to the visitors with the descriptions of the system as well as the general cosmic-ray information. The visitors can select the windows using the touch panel.

Two more stations were added in 2002 at the Izumiootsu High School and Kinki University Technical College. The geometric parameters for the four sites are listed in Table 2.

To adjust the operating voltage and to monitor the noise, the ADC data (Fig 6) of each scintillation counter at each site are monitored via the network at the Osaka City University. TDC data are used to obtain the arrival directions of the air showers assuming the shower fronts are flat. The sharp bump in the TDC distribution at 210 ns in Fig. 6 shows the events that the signal of this channel was the third in arrival time among the four channels; each corresponds to one scintillation counter. Since a trigger is generated by the signals in any three channels, the signal timing of this channel determined the trigger timing, thus giving the constant TDC count. The broad distribution is made of the signals arriving in the other time ordering (i.e. “non-third” in the arrival time). The front planes of the showers are obtained by the least squares method. From the residual of the fit, the angle resolution was obtained as  $8^\circ$ . The measured zenith angles,  $\theta$ 's, are shown in Fig. 7. The distribution can be fit by  $\cos^n \theta$  with  $n = 10.1$  for  $0.6 \leq \cos \theta \leq 1.0$ . The zenith angles  $\cos \theta < 0.6$  has a flatter distribution. Therefore, we only accepted the events with  $\cos \theta \geq 0.6$  for the analysis. After this cut, the background are estimated to be less than a few percent.

The arrival time distribution is shown in Fig. 8 using the events observed at the Osaka City University. The exponential behavior shows that the events are randomly observed with a rate of 2.7 per minute. Figure 9 shows the arrival time interval of the events at the Osaka Science Museum with respect to the ones at the Osaka City University. The used data were collected at

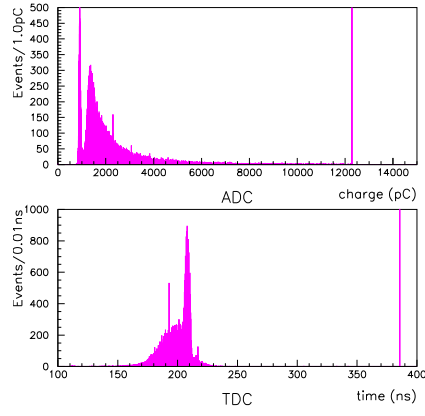

Figure 6: ADC (top) and TDC (bottom) of scintillator signals.

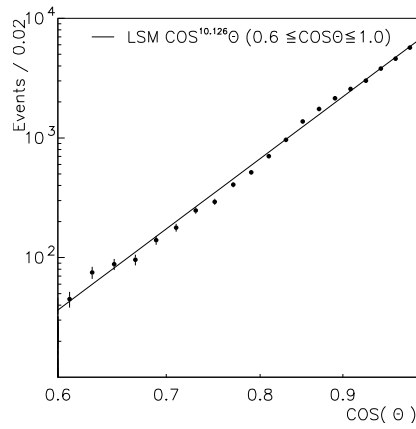

Figure 7: Zenith angles.



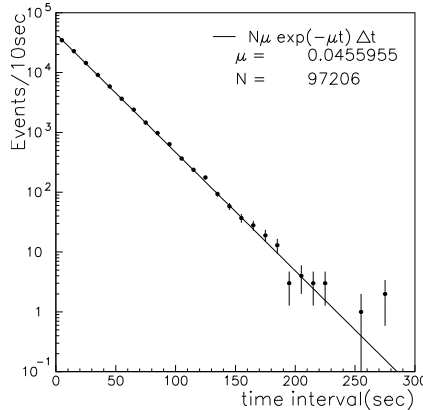

Figure 8: Arrival time intervals at Osaka City University.

the Osaka City University via the Internet for a period of one month. The negative or positive time in the distribution show the cases when the events at the museum are earlier (negative) or later (positive) than the ones at the university. This indicates that the events at both locations were observed by the network data-taking with no biasing.

## 4 Summary

We have developed a cosmic ray detection system suitable for detecting air showers arriving over a wide area with correlated time. The system consists of detector stations connected by the Internet. Each station is comprised of four scintillation counters with an electronics box and a PC, which can reconstruct the local air showers. For data communication, HTTP is used as the protocol to pass the firewalls. Each station polls the HTTP server at the Osaka City University, which collects and distributes the data to each site.

The system is currently operating with four sites. It can be expanded by simply adding stations. A typical trigger rate at each station is 3 per minute. The measured arrival direction resolution is  $8^\circ$ . The measured arrival time of cosmic rays are consistent with random, indicating that the system has no biasing. We plan to expand the system and cover a larger detection area in order to search for time-correlated events whose frequency is expected to be less than a few per year.

*Acknowledgments.*

We thank Prof. T. Kitamura and W. Unno of Kinki University for encouraging us to build this system. We also thank Prof. H. Fujii of the National Laboratory for High Energy Physics (KEK) for the useful discussions in developing the software. This project is partially funded by a Grant-in-Aid for Scientific Research on Priority Areas by the Japanese Ministry of Education, Culture, Sports, Science and Technology (MEXT).

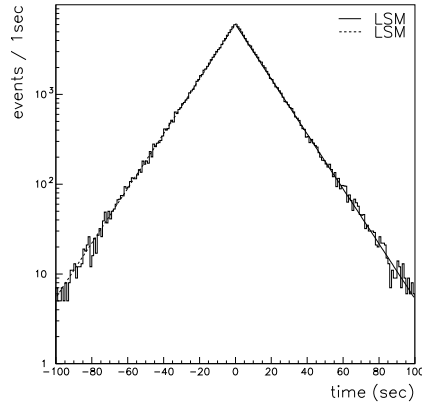

Figure 9: Time correlation between the events at the Osaka City University and Osaka Science Museum.

## References

- [1] O. Carrel, M. Martin, Phys. Lett. **B 325** (1994) 526.
- [2] T. Kitamura, S. Ohara, T. Konishi, K. Tsuji, M. Chikawa, W. Unno, I. Masaki, K. Urata, Y. Kato, Astroparticle Phys. **6** (1997) 279.
- [3] J. Kumagai, “High School Students Will Soon Join in the Hunt for High-Energy Cosmic Rays”, Physics Today, Oct. 1998, p. 73.
- [4] G. Snow, “High Schools Join the Search for Most Energetic Particles in the Universe”, Fermi News, Feb. 1, 2002, p. 8. An information of NALTA can be found at the website, <http://csr.phys.ualberta.ca/nalta/>.
- [5] “Looking at cosmic rays with accelerator detectors”, “ALEPH experiments go cosmic”, “L3+C=new tool set to study cosmic-ray muons”, CERN courier, Oct., 1999, p. 29-33.
- [6] B. Besier et al., Nucl. Instr. and Meth. A 454, (2000) 201.