

STACKS OF STABLE MAPS AND GROMOV-WITTEN INVARIANTS

K. BEHREND AND YU. MANIN

To Professor Friedrich Hirzebruch

October 18, 1995

ABSTRACT. We construct the motivic tree-level system of Gromov-Witten invariants for convex varieties.

0. INTRODUCTION

Let V be a projective algebraic manifold. In [11], Sec. 2, Gromov-Witten invariants of V were described axiomatically as a collection of linear maps

$$I_{g,n,\beta}^V : H^*(V)^{\otimes n} \longrightarrow H^*(\overline{M}_{g,n}, \mathbb{Q}), \quad \beta \in H_2(V, \mathbb{Z})$$

satisfying certain axioms, and a program to construct them by algebro-geometric (as opposed to symplectic) techniques was suggested. The program is based upon Kontsevich's notion of a stable map (C, x_1, \dots, x_n, f) , $f : C \rightarrow V$. This data consists of an algebraic curve C with n labeled points on it and a map f such that if an irreducible component of C is contracted by f to a point, then this component together with its special points is Deligne-Mumford stable. For more details, see [10] and below.

The construction consists of three major steps.

A. Construct an orbispace (or rather a stack) of stable maps $\overline{M}_{g,n}(V, \beta)$ such that $g = \text{genus of } C$, $f_*([C]) = \beta$, and its two morphisms to V^n and $\overline{M}_{g,n}$. On the level of points, these morphisms are given respectively by

$$\begin{aligned} p : (C, x_1, \dots, x_n, f) &\longmapsto (f(x_1), \dots, f(x_n)), \\ q : (C, x_1, \dots, x_n, f) &\longmapsto [(C, x_1, \dots, x_n)]^{\text{stab}}, \end{aligned}$$

where the last expression means the stabilization of (C, x_1, \dots, x_n) .

B. Construct a "virtual fundamental class" $[\overline{M}_{g,n}(V, \beta)]_{\text{virt}}$, or "orientation" (see Definition 7.1 below) and use it to define a correspondence in the Chow ring $C_{g,n,\beta}^V \in A(V^n \times \overline{M}_{g,n})$.

This step suggested in [10] is quite subtle and has not been spelled out in full detail. It can be bypassed for $g = 0$ and $V = G/P$ (generalized flag spaces) where the virtual class coincides with the usual one (see [11]).

In general, it involves a definition of a new \mathbb{Z} -graded supercommutative structure sheaf on $\overline{M}_{g,n}(V, \beta)$. The virtual class is obtained as a product of the class of this sheaf and the inverse Todd class of an appropriate tangent complex. Geometrically, it serves as a general position argument furnishing the Dimension Axiom of [11] and replacing the deformation of the complex structure used in the symplectic context.

C. Use $C_{g,n,\beta}^V$ in order to construct the induced maps $I_{g,n,\beta}^V$ on any cohomology satisfying some version of the standard properties making it functorial on the category of correspondences.

In this approach, the main features of $I_{g,n,\beta}^V$ axiomatized in [11] reflect functorial properties of $\overline{M}_{g,n}(V, \beta)$ and the cotangent complex with respect to degenerations of stable maps. In particular, the key ‘‘Splitting Axiom’’ (or Associativity Equations for $g = 0$) expresses the compatibility between the divisors at infinity of $\overline{M}_{g,n}(V, \beta)$ and $\overline{M}_{g,n}$.

A neat way to organize this information is to introduce the category of marked stable modular graphs indexing degeneration types of stable maps and to treat various modular stacks $\overline{M}_{g,n}(V, \beta)$ as values of this modular functor on the simplest one-vertex graphs. Then the check of the axioms in [11] essentially boils down to a calculation of this functor on a family of generating morphisms and objects in the graph category.

The degeneration type of (C, x_1, \dots, x_n, f) is described by the graph whose vertices are the irreducible components of C , edges are singular points of C , and tails (‘‘one-vertex edges’’) are x_1, \dots, x_n . In addition, each vertex is marked by the homology class in V which is the f -image of the fundamental class of the respective component of C and by the genus of the normalization of this component. The description of morphisms is somewhat more delicate, cf. Sec. 1 below.

This philosophy is an extension of the operadic picture which already gained considerable importance from various viewpoints. In turn, it leads to a new notion of a Γ -operad as a monoidal functor on an appropriate category Γ of graphs, and an algebra over an operad as a morphism of such functors. This approach will be developed elsewhere (see [7]). It clarifies the origin of the proliferation of the types of operads considered recently (May’s, Markl’s, modular, cyclic, ...)

In Part I of the present paper we treat in this way Step A, stressing the functoriality not only with respect to the degeneration types with fixed V but also with respect to V , expressed by the change of the marking semigroup of abstract non-negative homology classes. We hope also that our approach will help to introduce quantum cohomology with coefficients and to understand better the Künneth formula for quantum cohomology from [12].

Part II is devoted to Steps B and C for $g = 0$ and convex manifolds V . The formalism of orientation classes is introduced axiomatically, but we did not attempt

to justify the relevant claims of [10] in general.

A word of warning and apology is due. The reader will meet several different categories of marked graphs in this paper of which the most important are \mathfrak{G}_s (cf. Definition 1.12), $\mathfrak{G}_s(A)$ (cf. Definition 6.9 and the preceding discussion) and $\tilde{\mathfrak{G}}_s(V)_{\text{cart}}$ (cf. Definition 6.10). They differ mainly by their classes of morphisms. Specifically, certain elementary arrows which are combinatorially “the same”, run in opposite directions in different categories, which affects the whole structure of the morphism semigroups. The reason is that functorial properties of moduli stacks of maps considered *by themselves* are different from the functorial properties of their virtual fundamental classes treated *as correspondences*. Since graphs are used mainly as a bookkeeping device, their categorical properties must reflect this distinction.

Acknowledgements. The authors are grateful to the Max-Planck-Institut für Mathematik in Bonn where this work was done for support and stimulating atmosphere.

Part I. Stacks of Stable Maps

1. GRAPHS

Definition 1.1. A *graph* τ is a quadruple $(F_\tau, V_\tau, j_\tau, \partial_\tau)$, where F_τ and V_τ are finite sets, $\partial_\tau : F_\tau \rightarrow V_\tau$ is a map and $j_\tau : F_\tau \rightarrow F_\tau$ an involution. We call F_τ the set of *flags*, V_τ the set of *vertices*, $S_\tau = \{f \in F_\tau \mid j_\tau f = f\}$ the set of *tails* and $E_\tau = \{\{f_1, f_2\} \subset F_\tau \mid f_2 = j_\tau f_1\}$ the set of edges of τ . For $v \in V_\tau$ let $F_\tau(v) = \partial_\tau^{-1}(v)$ and $|v| = \#F_\tau(v)$, the *valence* of v .

Definition 1.2. Let τ be a graph. We define the *geometric realization* $|\tau|$ of τ as follows. We start with the disjoint union of closed intervals and singletons

$$\coprod_{f \in F_\tau} [0, \frac{1}{2}] \amalg \coprod_{v \in V_\tau} \{|v|\}.$$

We denote the real number $x \in [0, \frac{1}{2}]$ in the component indexed by $f \in F_\tau$ by x_f . Then for every $v \in V_\tau$ we identify all elements of $\{0_f \mid f \in F_\tau(v)\}$ with $|v|$ and for every edge $\{f_1, f_2\}$ of τ , we identify $\frac{1}{2}_{f_1}$ and $\frac{1}{2}_{f_2}$. Finally, we remove for every tail $f \in S_\tau$ the point $\frac{1}{2}_f$. We consider $|\tau|$ as a topological space with base points given by $\{|v| \mid v \in V_\tau\}$, the *vertices* of $|\tau|$. It should always be clear from the context whether $|v|$ denotes the geometric realization of a vertex or it's valence.

Definition 1.3. Let τ and σ be graphs. A *contraction* $\phi : \tau \rightarrow \sigma$ is a pair of maps $\phi^F : F_\tau \rightarrow F_\sigma$ and $\phi_V : V_\tau \rightarrow V_\sigma$ such that the following conditions are satisfied.

- (1) ϕ^F is injective and ϕ_V is surjective.
- (2) The diagram

$$\begin{array}{ccc} F_\tau & \xrightarrow{\partial_\tau} & V_\tau \\ \phi^F \uparrow & & \downarrow \phi_V \\ F_\sigma & \xrightarrow{\partial_\sigma} & V_\sigma \end{array}$$

commutes.

- (3) $\phi^F \circ j_\sigma = j_\tau \circ \phi^F$, so that ϕ induces injections $\phi^S : S_\sigma \rightarrow S_\tau$ and $\phi^E : E_\sigma \rightarrow E_\tau$ on tails and edges.
- (4) ϕ^S is a bijection, so $F_\tau - \phi^F(F_\sigma)$ consists entirely of edges, the edges being contracted.
- (5) Call two vertices $v, w \in V_\tau$ *equivalent*, if there exists an $f \in F_\tau - \phi^F(F_\sigma)$ such that $f \in F_\tau(v)$ and $j_\tau f \in F_\tau(w)$. Then pass to the associated equivalence relation on V_τ . The map $\phi_V : V_\tau \rightarrow V_\sigma$ induces a bijection $V_\tau / \sim \rightarrow V_\sigma$.

For a vertex $v \in V_\sigma$ the graph whose set of flags is

$$\{f \in F_\tau \mid f \notin \phi^F(F_\sigma) \text{ and } \phi_V(\partial_\tau f) = v\},$$

whose set of vertices is $\phi_V^{-1}(v)$ and whose j and ∂ are obtained from j_τ and ∂_τ by restriction, is called the *graph being contracted onto* v . If the graphs being contracted have together exactly one edge, we call ϕ an *elementary contraction*.

Remarks 1.4. (1) It is clear how to compose contractions, and that the composition of contractions is a contraction.

- (2) If $\phi : \tau \rightarrow \sigma$ and $\phi' : \tau \rightarrow \sigma'$ are contractions with the same set of edges being contracted, then there exists a unique isomorphism $\psi : \sigma \rightarrow \sigma'$ such that $\psi \circ \phi = \phi'$.
- (3) Every contraction is a composition of elementary contractions.
- (4) To carry out a construction for contractions of graphs, which is compatible with composition of contractions, it suffices to perform this construction for elementary contractions and check that the construction is independent of the order in which it is realized for two elementary contractions.

Definition 1.5. A *modular graph* is a graph τ endowed with a map $g_\tau : V_\tau \rightarrow \mathbb{Z}_{\geq 0}; v \mapsto g(v)$. The number $g(v)$ is called the *genus* of the vertex v .

We say that a semigroup A has *indecomposable zero*, if $a + b = 0$ implies $a = 0$ and $b = 0$, for any two elements $a, b \in A$.

Definition 1.6. Let τ be a modular graph and A a semigroup with indecomposable zero. An *A-structure* on τ is a map $\alpha : V_\tau \rightarrow A$. The element $\alpha(v)$ is called the *class* of the vertex v . The pair (τ, α) is called a *modular graph with A-structure* (or *A-graph*, by abuse of language).

A *marked graph* is a pair (A, τ) , where A is a semigroup with indecomposable zero and τ an *A-graph*.

Definition 1.7. Let (σ, α) and (τ, β) be *A-graphs*. A *combinatorial morphism* $a : (\sigma, \alpha) \rightarrow (\tau, \beta)$ is a pair of maps $a_F : F_\sigma \rightarrow F_\tau$ and $a_V : V_\sigma \rightarrow V_\tau$, satisfying the following conditions.

- (1) The diagram

$$\begin{array}{ccc} F_\sigma & \xrightarrow{\partial_\sigma} & V_\sigma \\ a_F \downarrow & & \downarrow a_V \\ F_\tau & \xrightarrow{\partial_\tau} & V_\tau \end{array}$$

commutes. In particular, for every $v \in V_\sigma$, letting $w = a_V(v)$, we get an induced map $a_{V,v} : F_\sigma(v) \rightarrow F_\tau(w)$.

- (2) With the notation of (1), for every $v \in V_\sigma$ the map $a_{V,v} : F_\sigma(v) \rightarrow F_\tau(w)$ is injective.
- (3) Let $f \in F_\sigma$ and $\bar{f} = j_\sigma(f)$. If $f \neq \bar{f}$, there exists an $n \geq 1$ and $2n$ (not necessarily distinct) flags $f_1, \dots, f_n, \bar{f}_1, \dots, \bar{f}_n \in F_\tau$ such that
 - (a) $f_1 = a_F(f)$ and $\bar{f}_n = a_F(\bar{f})$,
 - (b) $j_\tau(f_i) = \bar{f}_i$, for all $i = 1, \dots, n$,
 - (c) $\partial_\tau(\bar{f}_i) = \partial_\tau(f_{i+1})$ for all $i = 1, \dots, n - 1$,
 - (d) for all $i = 1, \dots, n - 1$ we have

$$\bar{f}_i \neq f_{i+1} \implies g(v_i) = 0 \text{ and } \beta(v_i) = 0,$$

where $v_i = \partial(\bar{f}_i) = \partial(f_{i+1})$,

- (4) for every $v \in V_\sigma$ we have $\alpha(v) = \beta(a_V(v))$,
- (5) for every $v \in V_\sigma$ we have $g(v) = g(a_V(v))$.

A *combinatorial morphism of marked graphs* $(B, \sigma, \beta) \rightarrow (A, \tau, \alpha)$ is a pair (ξ, a) , where $\xi : A \rightarrow B$ is a homomorphism of semigroups and $a : (\sigma, \beta) \rightarrow (\tau, \xi \circ \alpha)$ is a combinatorial morphism of B -graphs.

Usually, we will suppress the subscripts of a .

- Remarks.*
- (1) The composition of two combinatorial morphisms is again a combinatorial morphism.
 - (2) We say that a combinatorial morphism $a : \sigma \rightarrow \tau$ is *complete*, if for every $v \in V_\sigma$ the map $a_{V,v} : F_\sigma(v) \rightarrow F_\tau(a(v))$ is bijective. Examples of complete combinatorial morphism are
 - (a) the inclusion of a connected component,
 - (b) the morphism $\sigma \rightarrow \tau$, where σ is obtained from τ by *cutting an edge*, i.e. changing j in such a way as to turn a two element orbit into two one element orbits.
 - (3) Let τ be an A -graph and $f \in S_\tau$ a tail of τ . Let $F_\sigma = F_\tau - \{f\}$, $V_\sigma = V_\tau$ and define ∂_σ and j_σ by restricting ∂_τ and j_τ . Then σ is naturally an A -graph called *obtained from τ by forgetting the tail f* . There is a canonical combinatorial morphism $\sigma \rightarrow \tau$.
 - (4) Every combinatorial morphism $a : \sigma \rightarrow \tau$ is a composition $a = b \circ c$, where b is complete and c is a finite composition of morphisms forgetting tails. If σ and τ are stable (Definition 1.9), all intermediate graphs in such a factorization are stable.
 - (5) Condition (3) of Definition 1.7 can be rephrased in a more geometric way—see the remark after Proposition 5.2.

Definition 1.8. A *contraction* $\phi : (\tau, \alpha) \rightarrow (\sigma, \beta)$ of A -graphs is a contraction of graphs $\phi : \tau \rightarrow \sigma$ such that for every $v \in V_\sigma$ we have

(1)

$$g(v) = \sum_{w \in \phi_v^{-1}(v)} g(w) + \dim H^1(|\tau_v|),$$

(2) where τ_v is the graph being contracted onto v ,

$$\beta(v) = \sum_{w \in \phi_v^{-1}(v)} \alpha(w).$$

Definition 1.9. A vertex v of a modular graph with A -structure (τ, α) is called *stable*, if $\alpha(v) = 0$ implies $2g(v) + |v| \geq 3$. Otherwise, v is called *unstable*. The A -graph τ is called *stable*, if all its vertices are stable.

We now come to an important construction which we shall call *stable pullback*. Consider the following setup. We suppose given a homomorphism of semigroups $\xi : A \rightarrow B$, a contraction of A -graphs $\phi : \sigma \rightarrow \tau$ and a combinatorial morphism $a : (B, \rho) \rightarrow (A, \tau)$ of marked graphs. Moreover, we assume that ρ is a *stable* B -graph. We shall construct a stable B -graph π , together with a contraction of

B -graphs $\psi : \pi \rightarrow \rho$ and a combinatorial morphism of marked graphs $b : \pi \rightarrow \sigma$. This B -graph π will be called the *stable pullback* of ρ under ϕ .

$$\begin{array}{ccccc} B & \pi & \xrightarrow{\psi} & \rho & \\ \varepsilon \uparrow & b \downarrow & & \downarrow a & \\ A & \sigma & \xrightarrow{\phi} & \tau & \end{array}$$

According with Remark 1.4(4), we shall assume that ϕ is elementary and contracts the edge $\{f, \bar{f}\}$ of σ . Let $v_1 = \partial_\sigma(f)$, $v_2 = \partial_\sigma(\bar{f})$ and $v_0 = \phi(v_1) = \phi(v_2)$.

Case I (Contracting a loop). In this case $v_1 = v_2$. Let w_1, \dots, w_n be the vertices of ρ that map to v_0 under a . Note that $g(w_i) \geq 1$, since $g(v_0) \geq 1$. Let π be equal to ρ with a loop $\{f_i, \bar{f}_i\}$ attached to w_i , for each $i = 1, \dots, n$ and $g_\pi(w_i) = g_\rho(w_i) - 1$. Clearly, π is stable, the drop in certain genera is made up for by the addition of flags. The morphism $b : \pi \rightarrow \sigma$ is the obvious combinatorial morphism mapping every one of the loops $\{f_i, \bar{f}_i\}$ to $\{f, \bar{f}\}$. The contraction $\psi : \pi \rightarrow \rho$ simply contracts all the added loops.

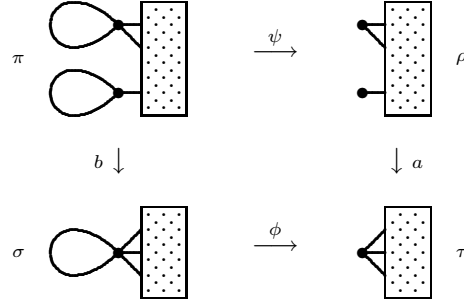

Case II (Contracting a non-looping edge). In this case $v_1 \neq v_2$. Again, let w_1, \dots, w_n be the vertices of ρ that map to v_0 under a . First we shall construct an intermediate graph π' . Let us fix an $i = 1, \dots, n$. Construct π' from ρ by replacing w_i with two vertices w'_i and w''_i , connected by an edge $\{f_i, \bar{f}_i\}$, such that $\partial(f_i) = w'_i$ and $\partial(\bar{f}_i) = w''_i$. Let f be a flag of ρ such that $\partial_\rho(f) = w_i$. If $\partial_\sigma \phi^F(a(f)) = v_1$ we attach f to w'_i and if $\partial_\sigma \phi^F(a(f)) = v_2$ we attach f to w''_i . Set $g(w'_i) = g(v_1)$, $g(w''_i) = g(v_2)$, $\beta(w'_i) = \xi(\alpha(v_1))$ and $\beta(w''_i) = \xi(\alpha(v_2))$. This defines the B -graph π' . The problem with π' is that it might not be stable. So to construct π we proceed as follows. Fix an $i = 1, \dots, n$. If w'_i and w''_i are stable vertices of π' we do not change anything. If either of w'_i or w''_i is unstable, we go back to where we started, by contracting $\{f_i, \bar{f}_i\}$ again, obtaining the stable vertex w_i . This finally finishes the construction of π . The contraction $\psi : \pi \rightarrow \rho$ is defined by contracting all the edges that were just inserted into ρ to construct π . There is an obvious combinatorial morphism $b' : \pi' \rightarrow \sigma$ mapping the edge $\{f_i, \bar{f}_i\}$ to $\{f, \bar{f}\}$. Moreover, we define a combinatorial morphism $c : \pi \rightarrow \pi'$ as follows. If $i = 1, \dots, n$ is an index such that either of w'_i or w''_i is an unstable vertex of π' , we map the vertex w_i of π to the stable one of the two, say w'_i , to fix notation. If f is a flag of ρ such that $\partial f = w_i$, then f is also considered as a flag of π and π' , and under c we map

f to itself, if $\partial_{\pi'}(f) = w'_i$, and to f_i , otherwise. Finally, $b : \pi \rightarrow \sigma$ is defined as the composition $b = b' \circ c$.

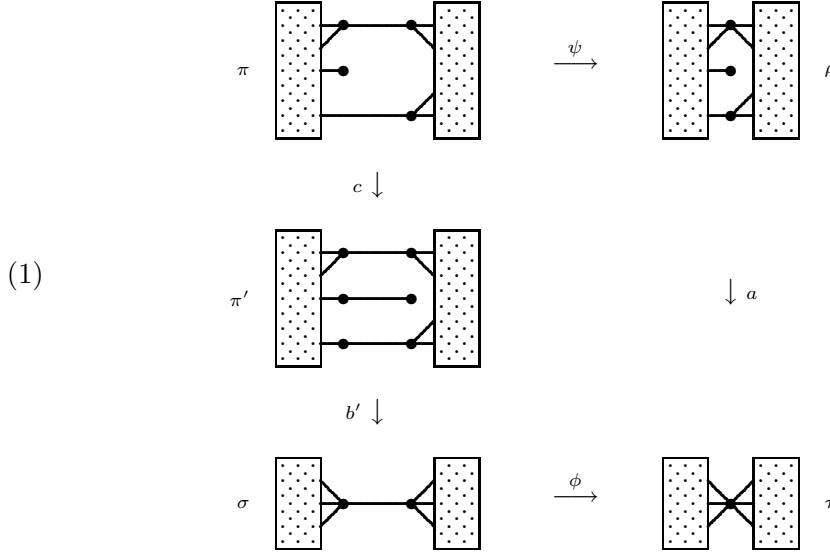

Iterating this construction leads to the construction of a stable pullback for arbitrary contractions of A -graphs.

Remark. Let

$$\begin{array}{ccccc}
 B & & \pi & \xrightarrow{\psi} & \rho \\
 \xi \uparrow & & b \downarrow & & \downarrow a \\
 A & & \sigma & \xrightarrow{\phi} & \tau
 \end{array}$$

be a stable pullback.

(1) The diagram

$$\begin{array}{ccc}
 V_\pi & \xrightarrow{\psi_V} & V_\rho \\
 b \downarrow & & \downarrow a \\
 V_\sigma & \xrightarrow{\phi_V} & V_\tau
 \end{array}$$

commutes.

(2) The diagram

$$\begin{array}{ccc}
 F_\pi & \xleftarrow{\psi^F} & F_\rho \\
 b \downarrow & & \downarrow a \\
 F_\sigma & \xleftarrow{\phi^F} & F_\tau
 \end{array}$$

does *not* commute (except for special cases, e.g. if the B -graph π' constructed above is stable).

Proposition 1.10. *Stable pullback is independent of the order in which ϕ is decomposed into elementary contractions. Moreover, if*

$$\begin{array}{ccccc} B & \pi & \xrightarrow{\psi} & \rho & \\ \xi \uparrow & b \downarrow & & \downarrow a & \\ A & \sigma & \xrightarrow{\phi} & \tau & \end{array}$$

and

$$\begin{array}{ccccc} B & \pi' & \xrightarrow{\psi'} & \pi & \\ \xi \uparrow & b' \downarrow & & \downarrow b & \\ A & \sigma' & \xrightarrow{\phi'} & \sigma & \end{array}$$

are stable pullbacks, then

$$\begin{array}{ccccc} B & \pi' & \xrightarrow{\psi \circ \psi'} & \rho & \\ \xi \uparrow & b' \downarrow & & \downarrow a & \\ A & \sigma' & \xrightarrow{\phi \circ \phi'} & \tau & \end{array}$$

is a stable pullback, too.

Proof. To check that stable pullback is well-defined, it suffices by Remark 1.4(4) to check that the above construction yields the same result for both orders in which two elementary contractions can be composed. This is a straightforward, though maybe slightly tedious calculation. The compatibility of stable pullback with compositions of contractions follows trivially from the definition. \square

Proposition 1.11. *If*

$$\begin{array}{ccccc} B & \pi & \xrightarrow{\psi} & \rho & \\ \xi \uparrow & b \downarrow & & \downarrow a & \\ A & \sigma & \xrightarrow{\phi} & \tau & \end{array}$$

and

$$\begin{array}{ccccc} C & \pi' & \xrightarrow{\chi} & \rho' & \\ \eta \uparrow & b' \downarrow & & \downarrow a' & \\ B & \pi & \xrightarrow{\psi} & \rho & \end{array}$$

are stable pullbacks, then

$$\begin{array}{ccccc} C & \pi' & \xrightarrow{\chi} & \rho' & \\ \eta \circ \xi \uparrow & b \circ b' \downarrow & & \downarrow a \circ a' & \\ A & \sigma & \xrightarrow{\phi} & \tau & \end{array}$$

is a stable pullback, too.

Proof. Of course, it suffices to consider the case that ϕ is an elementary contraction. Then the claim follows immediately from the construction. \square

We are now ready to define the notion of *morphism* of marked stable graphs.

Definition 1.12. Let (A, τ) and (B, σ) be marked stable graphs. A *morphism* from (A, τ) to (B, σ) is a quadruple (ξ, a, τ', ϕ) , where $\xi : A \rightarrow B$ is a homomorphism of semigroups, τ' is a stable B -graph, $a : \tau' \rightarrow \tau$ makes (ξ, a) a combinatorial morphism of marked graphs, and $\phi : \tau' \rightarrow \sigma$ is a contraction of B -graphs. We also say that (a, τ', ϕ) is a morphism of marked stable graphs *covering* ξ .

Let $(\xi, a, \tau', \phi) : (A, \tau) \rightarrow (B, \sigma)$ and $(\eta, b, \sigma', \psi) : (B, \sigma) \rightarrow (C, \rho)$ be morphisms of stable marked graphs. Then we define the *composition* $(\eta, b, \sigma', \psi) \circ (\xi, a, \tau', \phi) : (A, \tau) \rightarrow (C, \rho)$ to be $(\eta\xi, ac, \tau'', \psi\chi)$, where (c, τ'', χ) is the stable pullback of σ' under ϕ .

$$\begin{array}{ccccc} C & & \tau'' & \xrightarrow{\chi} & \sigma' & \xrightarrow{\psi} & \rho \\ \eta \uparrow & & c \downarrow & & \downarrow b & & \\ B & & \tau' & \xrightarrow{\phi} & \sigma & & \\ \xi \uparrow & & a \downarrow & & & & \\ A & & \tau & & & & \end{array}$$

Remarks. (1) In reality a morphism is an isomorphy class of quadruples as in this definition. But we shall always stick to the abuse of language begun here.

- (2) The composition of morphisms is associative by Propositions 1.10 and 1.11.
- (3) Every combinatorial morphism of marked graphs whose source and target are stable defines a morphism of marked stable graphs, but in the *opposite* direction.
- (4) Every contraction of A -graphs whose source (and hence target) is stable defines a morphism of marked stable graphs (in the same direction).

The category of stable marked graphs shall be denoted by \mathfrak{G}_s . Let \mathfrak{A} be the category of (additive) semigroups with indecomposable zero element. By projecting onto the first component, we get a functor $\mathfrak{a} : \mathfrak{G}_s \rightarrow \mathfrak{A}$. For $A \in \text{ob } \mathfrak{A}$ let $\mathfrak{G}_s(A)$ be the fiber of \mathfrak{a} over A , i.e. the category of stable A -graphs.

Proposition 1.13. *Let τ be an A -graph. Then there exists a stable A -graph τ^s , together with a combinatorial morphism $\tau^s \rightarrow \tau$, such that every combinatorial morphism $\sigma \rightarrow \tau$, where σ is a stable A -graph, factors uniquely through τ^s . We call τ^s the stabilization of τ .*

Proof. let α denote the A -structure of τ .

Case I. Assume that τ has a vertex v_0 such that $g(v_0) = 0$, $\alpha(v_0) = 0$, v_0 has a unique flag f_1 , and $f_2 := j(f_1) \neq f_1$. Let $\tau' \rightarrow \tau$ be the ‘subgraph’ defined by $F_{\tau'} = F_\tau - \{f_1\}$, $V_{\tau'} = V_\tau - \{v_0\}$, $\partial_{\tau'} = \partial_\tau|_{F_{\tau'}}$, $j_{\tau'}|_{F_{\tau'} - \{f_2\}} = j_\tau|_{F_{\tau'} - \{f_2\}}$ and $j_{\tau'}(f_2) = f_2$.

Case II. Assume that τ has a vertex v_0 such that $g(v_0) = 0$, $\alpha(v_0) = 0$, v_0 has exactly two flags, f_1 and f_2 , f_1 is a tail of τ and $f_3 := j(f_2) \neq f_2$. Let $\tau' \rightarrow \tau$ be the ‘subgraph’ defined by $F_{\tau'} = F_\tau - \{f_1, f_2\}$, $V_{\tau'} = V_\tau - \{v_0\}$, $\partial_{\tau'} = \partial_\tau|_{F_{\tau'}}$, $j_{\tau'}|_{F_{\tau'} - \{f_3\}} = j_\tau|_{F_{\tau'} - \{f_3\}}$ and $j_{\tau'}(f_3) = f_3$.

Case III. Assume that τ has a vertex v_0 such that $g(v_0) = 0$, $\alpha(v_0) = 0$, v_0 has exactly two flags, f_1 and f_2 , $\bar{f}_1 := j(f_1) \neq f_1$ and $\bar{f}_2 := j(f_2) \neq f_2$. Let $\tau' \rightarrow \tau$

be the ‘subgraph’ defined by $F_{\tau'} = F_{\tau} - \{f_1, f_2\}$, $V_{\tau'} = V_{\tau} - \{v_0\}$, $\partial_{\tau'} = \partial_{\tau}|_{F_{\tau'}}$, $j_{\tau'}|_{F_{\tau'} - \{\bar{f}_1, \bar{f}_2\}} = j_{\tau}|_{F_{\tau'} - \{\bar{f}_1, \bar{f}_2\}}$ and $j_{\tau'}(\bar{f}_1) = \bar{f}_2$.

Case IV. Assume that τ has a vertex v_0 such that $2g(v_0) + |v_0| < 3$, $\alpha(v_0) = 0$ and $F_{\tau}(v_0)$ is a union of orbits of j_{τ} . Let $\tau' \rightarrow \tau$ be the ‘subgraph’ defined by $F_{\tau'} = F_{\tau} - F_{\tau}(v_0)$, $V_{\tau'} = V_{\tau} - \{v_0\}$, $\partial_{\tau'} = \partial_{\tau}|_{F_{\tau'}}$ and $j_{\tau'} = j_{\tau}|_{F_{\tau'}}$.

In each of these four cases every combinatorial morphism $\sigma \rightarrow \tau$, with σ stable factors uniquely through τ' . By induction on the number of vertices of τ , the graph τ' has a stabilization, which is thus also a stabilization of τ . If τ has no vertices v_0 of the kind covered by the above four cases, τ is stable and τ itself may serve as stabilization of τ . \square

See Section 10 in [6, Exp. VI]) for the definition of *cofibration* of categories.

Proposition 1.14. *The functor $\mathfrak{a} : \mathfrak{G}_s \rightarrow \mathfrak{A}$ is a cofibration.*

Proof. Let $\xi : A \rightarrow B$ be a homomorphism in \mathfrak{A} , and (τ, α) a stable A -graph. We need to construct a stable B -graph $\sigma = \xi_*\tau$, together with a morphism $(a, \tau', \phi) : (A, \tau) \rightarrow (B, \sigma)$ covering ξ , with the following universal mapping property. Whenever $\eta : B \rightarrow C$ is another homomorphism in \mathfrak{A} , ρ is a stable C -graph and $(b, \tau'', \psi) : (A, \tau) \rightarrow (C, \rho)$ is a morphism covering $\eta \circ \xi$, there exists a unique morphism $(c, \sigma', \chi) : (B, \sigma) \rightarrow (C, \rho)$ covering η , such that $(c, \sigma', \chi) \circ (a, \tau', \phi) = (b, \tau'', \psi)$, i.e. such that τ'' is the stable pullback of σ' under ϕ .

In fact, it is not difficult to see that the stabilization of $(\tau, \xi \circ \alpha)$ satisfies this universal mapping property. \square

Remark 1.15. Choosing a *clivage normalisé* (see Definition 7.1 in [6, Exp. VI]) of \mathfrak{G}_s over \mathfrak{A} amounts to choosing a pushforward functor $\xi_* : \mathfrak{G}_s(A) \rightarrow \mathfrak{G}_s(B)$ for any homomorphism $\xi : A \rightarrow B$ in \mathfrak{A} . We may call ξ_* *stabilization* with respect to ξ . If $B = \{0\}$, we speak of *absolute stabilization* (or simply *stabilization*, if no confusion seems likely to arise).

2. PRESTABLE CURVES

We recall the definition of prestable curves. A morphism of prestable curves is defined in such a way that it has degree at most one and contracts at most rational components.

Definition 2.1. A *prestabile curve* over the scheme T is a flat proper morphism $\pi : C \rightarrow T$ of schemes such that the geometric fibers of π are reduced, *connected*, one-dimensional and have at most ordinary double points (nodes) as singularities. The *genus* of a prestable curve $C \rightarrow T$ is the map $t \mapsto \dim H^1(C_t, \mathcal{O}_{C_t})$, which is a locally constant function $g : T \rightarrow \mathbb{Z}_{\geq 0}$. If L is a line bundle on C , then the *degree* of L is the locally constant function $\deg L : T \rightarrow \mathbb{Z}_{\geq 0}$ given by $t \mapsto \chi(L_t) + g - 1$.

A *morphism* $p : C \rightarrow D$ of prestable curves over T is a T -morphism of schemes, such that for every geometric point t of T we have

- (1) if η is the generic point of an irreducible component of D_t , then the fiber of p_t over η is a finite η -scheme of degree at most one,

- (2) if C' is the normalization of an irreducible component of C_t , then $p_t(C')$ is a single point only if C' is rational.

If V is a scheme and $f : C \rightarrow V$ a morphism, then $L \mapsto \deg f^*L$ defines a locally constant function $T \rightarrow \text{Hom}_{\mathbb{Z}}(\text{Pic } V, \mathbb{Z})$ which we shall call the *homology class* of f , by abuse of language, denoted $f_*[C]$.

If V is a scheme admitting an ample invertible sheaf let

$$H_2(V)^+ = \{\alpha \in \text{Hom}_{\mathbb{Z}}(\text{Pic } V, \mathbb{Z}) \mid \alpha(L) \geq 0 \text{ whenever } L \text{ is ample}\}.$$

Note that $H_2(V)^+$ is a semigroup with indecomposable zero. This is because if V admits an ample invertible sheaf then $\text{Pic } V$ is generated by ample invertible sheaves (see Remarque 4.5.9 in [4]). So if $f : C \rightarrow V$ is a morphism from a prestable curve into V , then the homology class is a locally constant function $T \rightarrow H_2(V)^+$.

Lemma 2.2. *Let $f : X \rightarrow Y$ be a proper surjective morphism of T -schemes such that $f_*\mathcal{O}_X = \mathcal{O}_Y$. Let $g : X \rightarrow U$ be another morphism of T -schemes, such that for every geometric point t of T the map $g_t : X_t \rightarrow U_t$ is constant (as a map of underlying Zariski topological spaces) on the fibers of $f_t : X_t \rightarrow Y_t$. Then g factors uniquely through f .*

Proof. This follows easily, for example, from Lemma 8.11.1 in [4]. \square

Corollary 2.3. *Let C be a prestable curve over T and $f : C \rightarrow V$ a morphism, where V is a scheme admitting an ample invertible sheaf. Then $f_*[C] = 0$ if and only if f factors through T . \square*

We shall need the following two results about gluing marked prestable curves at the marks.

Proposition 2.4. *Let T be a scheme and C_1, C_2 two prestable curves over T . Let $x_1 \in C_1(T)$ and $x_2 \in C_2(T)$ be sections such that for every geometric point t of T we have that $x_1(t)$ and $x_2(t)$ are in the smooth locus of $C_{1,t}$ and $C_{2,t}$, respectively. Then there exists a prestable curve C over T , together with T -morphisms $p_1 : C_1 \rightarrow C$ and $p_2 : C_2 \rightarrow C$, such that*

- (1) $p_1(x_1) = p_2(x_2)$,
- (2) C is universal among all T -schemes with this property.

The curve C is uniquely determined (up to unique isomorphism) and will be called obtained by gluing C_1 and C_2 along the sections x_1 and x_2 , notation

$$C = C_1 \amalg_{x_1, x_2} C_2.$$

If $u : S \rightarrow T$ is a morphism of schemes, then C_S is the curve obtained by gluing $C_{1,S}$ and $C_{2,S}$ along $x_{1,S}$ and $x_{2,S}$. If g_i is the genus of C_i , for $i = 1, 2$, then for the genus g of C we have $g = g_1 + g_2$. If, for $i = 1, 2$, $f_i : C_i \rightarrow V$ is a morphism into a scheme such that $f_1(x_1) = f_2(x_2)$, and $f : C \rightarrow V$ is the induced morphism, we have $f_[C] = f_{1*}[C_1] + f_{2*}[C_2]$ in $\text{Hom}_{\mathbb{Z}}(\text{Pic } V, \mathbb{Z})$. \square*

Proposition 2.5. *Let T be a scheme and C a prestable curve over T . Let $x_1 \in C(T)$ and $x_2 \in C(T)$ be sections such that for every geometric point t of T we have that $x_1(t)$ and $x_2(t)$ are in the smooth locus of C_t and $x_1(t) \neq x_2(t)$. Then there exists a prestable curve \tilde{C} over T , together with a T -morphism $p : C \rightarrow \tilde{C}$, such that*

- (1) $p(x_1) = p(x_2)$,
- (2) \tilde{C} is universal among all T -schemes with this property.

The curve \tilde{C} is uniquely determined (up to unique isomorphism) and will be called obtained by gluing C with itself along the sections x_1 and x_2 , notation

$$\tilde{C} = C/x_1 \sim x_2.$$

If $u : S \rightarrow T$ is a morphism of schemes, then $(\tilde{C})_S$ is the curve obtained by gluing C_S with itself along $x_{1,S}$ and $x_{2,S}$. If g is the genus of C , then for the genus \tilde{g} of \tilde{C} we have $\tilde{g} = g + 1$. If $f : C \rightarrow V$ is a morphism into a scheme such that $f(x_1) = f(x_2)$, and $\tilde{f} : \tilde{C} \rightarrow V$ is the induced morphism, we have $\tilde{f}_*[\tilde{C}] = f_*[C]$ in $\text{Hom}_{\mathbb{Z}}(\text{Pic } V, \mathbb{Z})$. \square

Definition 2.6. Let τ be a modular graph. A τ -marked prestable curve over T is a pair (C, x) , where $C = (C_v)_{v \in V_\tau}$ is a family of prestable curves $\pi_v : C_v \rightarrow T$ and $x = (x_i)_{i \in F_\tau}$ is a family of sections $x_i : T \rightarrow C_{\partial_\tau(i)}$, such that for every geometric point t of T we have

- (1) $x_i(t)$ is in the smooth locus of $C_{\partial_\tau(i),t}$, for all $i \in F_\tau$,
- (2) $x_i(t) \neq x_j(t)$, if $i \neq j$, for $i, j \in F_\tau$,
- (3) $g(C_{v,t}) = g(v)$ for all $v \in V_\tau$.

We define a *marked prestable curve over T* to be a triple (τ, C, x) , where τ is a modular graph and (C, x) a τ -marked prestable curve over T .

3. STABLE MAPS

We now come to the definition of stable maps, the central concept of this work, which is due to Kontsevich.

Fix a field k and let \mathfrak{V} be the category of smooth projective (not necessarily connected) varieties over k . Consider the covariant functor

$$\begin{aligned} H_2^+ : \mathfrak{V} &\longrightarrow \mathfrak{A} \\ V &\longmapsto H_2(V)^+, \end{aligned}$$

where \mathfrak{A} is the category of semigroups with indecomposable zero (see Section 1). Define the category \mathfrak{VG}_s as the fibered product (see Section 3 in [6, Exp. VI])

$$\begin{array}{ccc} \mathfrak{VG}_s & \longrightarrow & \mathfrak{G}_s \\ \downarrow & \square & \downarrow \alpha \\ \mathfrak{V} & \xrightarrow{H_2^+} & \mathfrak{A}. \end{array}$$

To spell this definition out, we have

- (1) objects of $\mathfrak{V}\mathfrak{G}_s$ are pairs (V, τ) , where V is a smooth projective variety over k and τ is a stable $H_2(V)^+$ -graph,
- (2) a morphism $(V, \tau) \rightarrow (W, \sigma)$ is a quadruple (ξ, a, τ', ϕ) , where $\xi : V \rightarrow W$ is a morphism of k -varieties and $(H_2^+(\xi), a, \tau', \phi)$ is a morphism in \mathfrak{G}_s as defined in Definition 1.12.

Remark 3.1. By Corollary 6.9 of [6, Exp. VI] and Proposition 1.14 the category $\mathfrak{V}\mathfrak{G}_s$ is a cofibered category over \mathfrak{V} .

Definition 3.2. Let (V, τ, α) be an object of $\mathfrak{V}\mathfrak{G}_s$ and T a k -scheme. A *stable* (V, τ, α) -map over T is a triple (C, x, f) , where (C, x) is a τ -marked prestable curve over T and $f = (f_v)_{v \in V_\tau}$ is a family of k -morphisms $f_v : C_v \rightarrow V$, such that the following conditions are satisfied.

- (1) For every $i \in F_\tau$ we have $f_{\partial_\tau(i)}(x_i) = f_{\partial_\tau(j_\tau(i))}(x_{j_\tau(i)})$ as k -morphisms from T to V .
- (2) For all $v \in V_\tau$ we have that $f_{v*}[C_v] = \alpha(v)$ in $H_2(V)^+$.
- (3) For every geometric point t of T and every $v \in V_\tau$ the *stability condition* is satisfied. This means that if C' is the normalization of a component of $C_{v,t}$ that maps to a point under $f_{v,t} : C_{v,t} \rightarrow V_t$, then
 - (a) if the genus of C' is zero, then C' has at least three special points,
 - (b) if the genus of C' is one, then C' has at least one special point.

Here, a point of C' is called *special*, if it maps in $C_{v,t}$ to a marked point or a node.

We define a *stable map over T* to be a sextuple $(V, \tau, \alpha, C, x, f)$, where (V, τ, α) is an object of $\mathfrak{V}\mathfrak{G}_s$ and (C, x, f) is a stable (V, τ, α) -map over T .

A *morphism* $(V, \tau, \alpha, C, x, f) \rightarrow (W, \sigma, \beta, D, y, h)$ of stable maps over T is a quintuple (ξ, a, τ', ϕ, p) , where $(\xi, a, \tau', \phi) : (V, \tau, \alpha) \rightarrow (W, \sigma, \beta)$ is a morphism in $\mathfrak{V}\mathfrak{G}_s$ and $p = (p_v)_{v \in V_{\tau'}}$ is a family of morphisms of prestable curves $p_v : C_{a(v)} \rightarrow D_{\phi_V(v)}$, such that the following are true.

- (1) For every $i \in F_\sigma$ we have $p_{\partial(\phi^F(i))}(x_{a\phi^F(i)}) = y_i$,
- (2) If $\{i_1, i_2\}$ is an edge of τ' which is being contracted by ϕ , then $p_{v_1}(x_{a(i_1)}) = p_{v_2}(x_{a(i_2)})$, where $v_1 = \partial i_1$ and $v_2 = \partial i_2$. So, in particular, if $v_1 \neq v_2$ there exists an induces morphism

$$p_{12} : C_{a(v_1)} \amalg_{x_{a(i_1)}, x_{a(i_2)}} C_{a(v_2)} \rightarrow D_w,$$

where $w = \phi(v_1) = \phi(v_2)$.

- (3) With the notation of (2), if $v_1 \neq v_2$, the morphism p_{12} is a morphism of prestable curves.
- (4) For every $v \in V_{\tau'}$ the diagram

$$\begin{array}{ccc} C_{a(v)} & \xrightarrow{f_{a(v)}} & V \\ p_v \downarrow & & \downarrow \xi \\ D_{\phi(v)} & \xrightarrow{h_{\phi(v)}} & W \end{array}$$

commutes.

In this situation we also say that $p : (C, x, f) \rightarrow (D, y, h)$ is a morphism of stable maps *covering* the morphism (ξ, a, τ', α) in \mathfrak{MG}_s .

To define the *composition* of morphisms, let $(\xi, a, \tau', \phi, p) : (V, \tau, \alpha, C, x, f) \rightarrow (W, \sigma, \beta, D, y, h)$ and $(\eta, b, \sigma', \psi, q) : (W, \sigma, \beta, D, y, h) \rightarrow (U, \rho, \gamma, E, z, e)$ be morphisms of stable maps over T . We already know how to compose the morphisms (ξ, a, τ', ϕ) and (η, b, σ', ψ) in \mathfrak{MG}_s . Use notation as in Definition 1.12. Then this composition is $(\eta\xi, ac, \tau'', \psi\chi)$. Define the family $r = (r_u)_{u \in V_{\tau''}}$ of morphisms of prestable curves $r_u : C_{ac(u)} \rightarrow E_{\psi\chi(u)}$ as $r_u = q_{\chi(u)} \circ p_{c(u)}$, which is well-defined, since $\phi_V c(u) = a\chi_V(u)$. Then we define our composition as

$$(\eta, b, \sigma', \psi, q) \circ (\xi, a, \tau', \phi, p) = (\eta\xi, ac, \tau'', \psi\chi, r).$$

Proposition 3.3. *The composition of morphisms of stable maps is a morphism of stable maps.*

Proof. The proof will be given at the same time as the proof of Theorem 3.6 below. \square

Definition 3.4. Let $V \in \text{ob } \mathfrak{V}$ be a variety, $\beta \in H_2(V)^+$ a homology class and $g, n \geq 0$ integers. Then (V, g, n, β) shall denote the object (V, τ, β) of \mathfrak{MG}_s whose modular graph τ is given by $F_\tau = \underline{n}$, $V_\tau = \{\emptyset\}$, $\partial_\tau : F_\tau \rightarrow V_\tau$ the unique map, $j_\tau = \text{id}_{\underline{n}}$ and $g(\emptyset) = g$. The $H_2(V)^+$ -structure on τ is given by $\beta(\emptyset) = \beta$. A stable (V, g, n, β) -map is also called a *stable map from an n -pointed curve (of genus g) to V (of class β)*. Here we use the notation $\underline{n} = \{1, \dots, n\}$.

Lemma 3.5. *Over an algebraically closed field, let (C, x, f) be a stable map from an n -pointed curve of genus g to V of class β and let (D, y, h) be a stable map from an m -pointed curve of genus g to V of class β , where $m \leq n$. Let $p : C \rightarrow D$ be a morphism such that $p(x_i) = y_i$ for $i \leq m$ and $hp = f$. If $C' \subset C$ is a subcurve (a connected union of irreducible components), such that*

- (1) *letting C'' be the closure of the complement of C' in C , the curves C' and C'' have exactly one node in common,*
- (2) *$g(C') = 0$,*
- (3) *$f(C')$ is a point,*
- (4) *for $i \leq m$ the x_i do not lie on C' except for at most one of them,*

then p maps C' to a point in D . \square

Let us denote the category of stable maps over T by $\overline{M}(T)$. It comes together with a functor

$$\overline{M}(T) \longrightarrow \mathfrak{MG}_s,$$

defined by projecting onto the first components. For a morphism $u : S \rightarrow T$, pulling back defines a \mathfrak{MG}_s -functor

$$u^* : \overline{M}(T) \longrightarrow \overline{M}(S).$$

Theorem 3.6. *For every k -scheme T the functor $\overline{M}(T) \rightarrow \mathfrak{V}\mathfrak{G}_s$ is a cofibration, whose fibers are groupoids. In other words, $\overline{M}(T)$ is cofibered in groupoids over $\mathfrak{V}\mathfrak{G}_s$.*

For every base change $u : S \rightarrow T$ the $\mathfrak{V}\mathfrak{G}_s$ -functor $u^ : \overline{M}(T) \rightarrow \overline{M}(S)$ is cocartesian.*

Proof. To prove that $\overline{M}(T) \rightarrow \mathfrak{V}\mathfrak{G}_s$ is a cofibration, we need to prove the following. Let $(\xi, a, \tau', \phi) : (V, \tau) \rightarrow (W, \sigma)$ be a morphism in $\mathfrak{V}\mathfrak{G}_s$ and (C, x, f) a stable (V, τ) -map over T . Then there exists a *pushforward* (D, y, h) of (C, x, f) under (ξ, a, τ', ϕ) . This pushforward comes with a morphism $p : (C, x, f) \rightarrow (D, y, h)$ of stable maps covering (ξ, a, τ', ϕ) and is characterized by the following universal mapping property. Whenever $(\eta, b, \sigma', \psi) : (W, \sigma) \rightarrow (U, \rho)$ is another morphism in $\mathfrak{V}\mathfrak{G}_s$, (E, z, e) a stable (U, ρ) -map over T and $r : (C, x, f) \rightarrow (E, z, e)$ a morphism of stable maps covering $(\eta\xi, ac, \tau'', \psi\chi) : (V, \tau) \rightarrow (U, \rho)$ (in the notation of Definition 1.12), there exists a unique morphism of stable maps $q : (D, y, h) \rightarrow (E, z, e)$ covering $(\eta, b, \sigma', \psi) : (W, \sigma) \rightarrow (U, \rho)$ such that $r = q \circ p$.

$$(2) \quad \begin{array}{ccccc} & & \xrightarrow{\quad r \quad} & & \\ & & \curvearrowright & & \\ (C, x, f) & \xrightarrow{p} & (D, y, h) & \xrightarrow{q} & (E, z, e) \\ | & & | & & | \\ (V, \tau) & \xrightarrow{(\xi, a, \tau', \phi)} & (W, \sigma) & \xrightarrow{(\eta, b, \sigma', \psi)} & (U, \rho) \\ & & \curvearrowleft & & \\ & & \xrightarrow{\quad (\eta\xi, ac, \tau'', \psi\chi) \quad} & & \end{array}$$

To prove that $u^* : \overline{M}(T) \rightarrow \overline{M}(S)$ is always cocartesian, we need to prove that this pushforward commutes with base change.

Recall that we also wish to prove Proposition 3.3, i.e. that if morphisms of stable maps $p : (C, x, f) \rightarrow (D, y, h)$ and $q : (D, y, h) \rightarrow (E, z, e)$ are given as in (2), then the composition $r : (C, x, f) \rightarrow (E, z, e)$ is also a morphism of stable maps.

Purely formal considerations tell us that to prove these three facts, we may decompose the morphism $(\xi, a, \tau', \phi) : (V, \tau) \rightarrow (W, \sigma)$ into a composition of other morphisms in any way we wish and prove the three facts for the factors of this decomposition. We shall thus consider the following five cases.

Case I (Changing V). In this case $\sigma = \xi_*\tau$. This means that σ is the pushforward of τ under $\xi : V \rightarrow W$, using the fact that $\mathfrak{V}\mathfrak{G}_s \rightarrow \mathfrak{V}$ is a cofibration (Remark 3.1). In other words, σ is the stabilization of τ with respect to the induced $H_2(W)^+$ -structure (Proposition 1.13). Thus $\tau' = \sigma$ and $\phi = \text{id}_\sigma$.

In all other cases $W = V$ and ξ is the identity. In the next two cases $a = \text{id}_\tau$ and $\tau' = \tau$.

Case II (Contracting an edge). The contraction $\phi : \tau \rightarrow \sigma$ contracts exactly one edge $\{i_1, i_2\} \subset F_\tau$ and we have $v_1 \neq v_2$, where $v_1 = \partial(i_1)$ and $v_2 = \partial(i_2)$. To fix notation, let $v_0 = \phi(v_1) = \phi(v_2)$.

Case III (Contracting a loop). This is the same as Case II, except that we have $v_1 = v_2$.

In the last two cases $\tau' = \sigma$ and $\phi = \text{id}_\sigma$.

Case IV (Complete combinatorial). The combinatorial morphism $a : \sigma \rightarrow \tau$ has the property that $a : F_\sigma(v) \rightarrow F_\tau(a(v))$ is a bijection, for all $v \in V_\sigma$.

Case V (Removing a tail). In this case, $V_\sigma = V_\tau$, we have given a vertex $v_0 \in V_\tau$ and a tail $i_0 \in F_\tau(v_0)$ of τ and we have

- (1) $F_\sigma = F_\tau - \{i_0\}$,
- (2) $\partial_\sigma = \partial_\tau|_{F_\sigma}$,
- (3) $j_\sigma = j_\tau|_{F_\sigma}$.

Note that the proof of Proposition 3.3 is only interesting (if at all) for Case II, since only in this case carrying out the composition of (ξ, a, τ', ϕ) and (η, b, σ', ψ) involves the second case of the construction of stable pullback (Section 1).

Case I. First we note the following trivial lemma.

Lemma 3.7. *Assume that τ is stable with respect to the induced $H_2(W)^+$ -structure, so that $\sigma = \tau$ and $a = \text{id}_\tau$. Then if $(C, x, \xi \circ f)$ satisfies the stability condition it may serve as pushforward of (C, \tilde{x}, f) under ξ . \square*

We shall now reduce Case I to Cases IV and V. By the claimed compatibility with base change, we may construct the pushforward locally, and pass to an étale cover of T , whenever desirable. Thus we add tails to τ , obtaining $\tilde{\tau}$, and corresponding sections of C , obtaining (C, \tilde{x}) until $\tilde{\tau}$ with the induced $H_2(W)^+$ -structure is stable and $(C, \tilde{x}, \xi \circ f)$ satisfies the stability condition. Then we have the commutative diagram

$$(3) \quad \begin{array}{ccc} (V, \tilde{\tau}) & \longrightarrow & (V, \tau) \\ \downarrow & & \downarrow \\ (W, \tilde{\tau}) & \longrightarrow & (W, \sigma) \end{array}$$

in $\mathfrak{V}\mathfrak{G}_s$. The top row of (3) is covered by $(C, \tilde{x}, f) \rightarrow (C, x, f)$, and clearly (C, x, f) is the pushforward of (C, \tilde{x}, f) under $(V, \tilde{\tau}) \rightarrow (V, \tau)$ (see also Case V). The first column of (3) is covered by $(C, \tilde{x}, f) \rightarrow (C, \tilde{x}, \xi \circ f)$, which is a pushforward by Lemma 3.7. Now the pushforward of $(C, \tilde{x}, \xi \circ f)$ under $(W, \tilde{\tau}) \rightarrow (W, \sigma)$ will also be the sought after pushforward of (C, x, f) under $(V, \tau) \rightarrow (W, \sigma)$. But $(W, \tilde{\tau}) \rightarrow (W, \sigma)$ is covered by Cases IV and V, achieving the reduction. \square

Case II. The diagram defining the composition of ϕ and (b, σ', ψ) is

$$\begin{array}{ccccc} \tau' & \xrightarrow{x} & \sigma' & \xrightarrow{\psi} & \rho \\ c \downarrow & & \downarrow b & & \\ \tau & \xrightarrow{\phi} & \sigma & & \end{array}$$

Let us first deal with the proof of Proposition 3.3.

Lemma 3.8. *For every $i \in F_{\sigma'}$ we have*

$$q_{\partial(i)} p_{\partial c \chi^F(i)}(x_{c \chi^F(i)}) = q_{\partial(i)} p_{\partial \phi^F b(i)}(x_{\phi^F b(i)}).$$

Proof. Assume that $c\chi^F(i) \neq \phi^F b(i)$, since otherwise there is nothing to prove. In this case, necessarily, $c\chi^F(i)$ is being contracted by ϕ . Without loss of generality, let $c\chi^F(i) = i_1$, so the situation is as in the following diagram (cf. (1)).

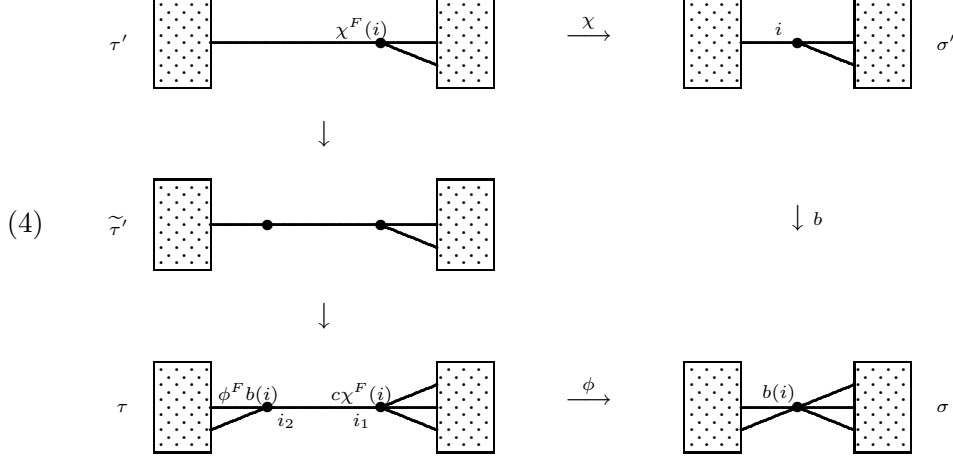

Here, τ' is the stable pullback and $\tilde{\tau}'$ the intermediate graph used in the construction of τ' . Using the fact that p is a morphism of stable maps we get a morphism $p_{12} : C_{12} \rightarrow D_{v_0}$ of prestable curves, where

$$C_{12} = C_{v_1} \amalg_{x_{i_1}, x_{i_2}} C_{v_2}.$$

Compose this with $q_{\partial(i)} : D_{v_0} \rightarrow E_{\psi\partial(i)}$. Let $f_{12} : C_{12} \rightarrow V$ be the map induced from f_{v_1} and f_{v_2} and $\tilde{x} = x|_{F_\tau(v_1) \cup F_\tau(v_2) - \{i_1, i_2\}}$. Then $(C_{12}, \tilde{x}, f_{12})$ is a stable map and

$$q_{\partial(i)} \circ p_{12} : (C_{12}, \tilde{x}, f_{12}) \longrightarrow (E_{\psi\partial(i)}, z|_{F_\rho(\psi\partial(i))}, e_{\psi\partial(i)})$$

is a morphism of stable maps to which Lemma 3.5 applies, with $C' = C_{v_2}$ and $x_{\phi^F b(i)} \in C'$ being the only marked point coming from $F_\rho(\psi\partial(i))$, if there exists such a point at all (this is because $\tau' \neq \tilde{\tau}'$). So by Lemma 3.5 $q_{\partial(i)} p_{v_2}(C_{v_2})$ is a point in $E_{\psi\partial(i)}$. To be precise, this holds if T is the spectrum of an algebraically closed field. For the general case, applying Lemma 2.2 yields that $q_{\partial(i)} \circ p_{v_2}$ factors through T . In particular,

$$q_{\partial(i)} p_{v_2}(x_{\phi^F b(i)}) = q_{\partial(i)} p_{v_2}(x_{i_2}) = q_{\partial(i)} p_{v_1}(x_{i_1}),$$

which is what we set out to prove. \square

Let us check that $r : (C, x, f) \rightarrow (E, z, e)$ is a morphism of stable maps, i.e. satisfies Properties (1) through (4) from Definition 3.2.

Property (1). Let $i \in F_\rho$. Then we have

$$r_{\partial\chi^F\psi^F(i)}(x_{c\chi^F\psi^F(i)}) = q_{\partial\psi^F(i)} p_{\partial c\chi^F\psi^F(i)}(x_{c\chi^F\psi^F(i)})$$

by Definition 3.2,

$$= q_{\partial\psi^F(i)} p_{\partial\phi^F b\psi^F(i)}(x_{\phi^F b\psi^F(i)})$$

by Lemma 3.8,

$$\begin{aligned} &= q_{\partial\psi^F(i)}(y_{b\psi^F(i)}) \\ &= z_i, \end{aligned}$$

since p and q are morphisms of stable maps.

Property (2). Let $\{j_1, j_2\}$ be an edge of τ' which is being contracted by $\psi\chi$. Let $u_1 = \partial j_1$ and $u_2 = \partial j_2$.

Case 1. Let $\{j_1, j_2\}$ be contracted by χ . Then $\{c(j_1), c(j_2)\}$ is being contracted by ϕ . So without loss of generality $c(j_1) = i_1$ and $c(j_2) = i_2$. Then

$$\begin{aligned} r_{u_1}(x_{i_1}) &= q_{\chi(u_1)}p_{v_1}(x_{i_1}) \\ &= q_{\chi(u_2)}p_{v_2}(x_{i_2}) \\ &= r_{u_2}(x_{i_2}), \end{aligned}$$

since p is a morphism of stable maps and $\chi(u_1) = \chi(u_2)$.

Case 2. If $\{j_1, j_2\}$ is not contracted by χ , then there exists a unique edge $\{j'_1, j'_2\}$ of σ' being contracted by ψ , such that $j_1 = \chi^F(j'_1)$ and $j_2 = \chi^F(j'_2)$. Then

$$\begin{aligned} r_{u_1}(x_{c(j_1)}) &= q_{\chi(u_1)}p_{c(u_1)}(x_{c(j_1)}) \\ &= q_{\chi(u_1)}p_{\partial\phi^F b(j'_1)}(x_{\phi^F b(j'_1)}) \end{aligned}$$

by Lemma 3.8,

$$\begin{aligned} &= q_{\chi(u_1)}(y_{b(j'_1)}) \\ &= q_{\chi(u_2)}(y_{b(j'_2)}) \end{aligned}$$

since q is a morphism of stable maps,

$$= r_{u_2}(x_{c(j_2)}),$$

by symmetry.

Property (3). This follows from the fact that the composition of morphisms of prestable curves is again a morphism of prestable curves.

Property (4). Straightforward.

This finishes the proof of Proposition 3.3 in Case II. Let us now construct the pushforward (D, y, h) of (C, x, f) under ϕ .

Let $w \in V_\sigma$. If $w \neq v_0$, let v be the unique vertex $v \in V_\tau$ such that $\phi_V(v) = w$ and set $D_w = C_v$. If $w = v_0$ set

$$D_{v_0} = C_{v_1} \amalg_{x_{i_1}, x_{i_2}} C_{v_2}.$$

This defines a family of prestable curves D . For every $v \in V_\tau$ let $p_v : C_v \rightarrow D_{\phi(v)}$ be the canonical map. Define sections y_i , for $i \in F_\sigma$, by

$$y_i = p_{\partial\phi^F(i)}(x_{\phi^F(i)}).$$

Finally, define for every $w \in V_\sigma$ a map $g_w : D_w \rightarrow V$ from f (by using Proposition 2.4, if $w = v_0$). Essentially by definition, (D, y, h) is a stable (V, σ) -map and

$p : (C, x, f) \rightarrow (D, y, h)$ is a morphism of stable maps covering $\phi : (V, \tau) \rightarrow (V, \sigma)$. It remains to check that (D, y, h) satisfies the universal mapping property of a pushforward under ϕ . So let $r : (C, x, f) \rightarrow (E, z, e)$ as in Diagram (2) be given.

Let $u \in V_{\sigma'}$. We need to define a unique morphism $q_u : D_{b(u)} \rightarrow E_{\psi(u)}$ such that for every $u' \in V_{\tau'}$, satisfying $\chi(u') = u$, the diagram

$$\begin{array}{ccc} C_{C(u')} & & \\ p_{C(u')} \downarrow & \searrow r_{u'} & \\ D_{b(u)} & \xrightarrow{q_u} & E_{\psi(u)} \end{array}$$

commutes. If $b(u) \neq v_0$, necessarily, $q_u = r_{u'}$. So let $b(u) = v_0$. If there are two vertices u'_1 and u'_2 such that $\chi(u'_1) = \chi(u'_2) = u$, then we have two maps $r_{u'_1} : C_{v_1} \rightarrow E_{\psi(u)}$ and $r_{u'_2} : C_{v_2} \rightarrow E_{\psi(u)}$ giving rise to a unique map $q_u : D_{v_0} \rightarrow E_{\psi(u)}$. If there is only one vertex u'_1 of τ' such that $\chi(u'_1) = u$, then we are in a situation as in Diagram (4), and by Lemma 3.5 q_u has to map $C_{v_2} \subset D_{v_0}$ to a single point of $E_{\psi(u)}$ and $r_{u'_1} : C_{v_1} \rightarrow E_{\psi(u)}$ suffices to determine $q_u : D_{v_0} \rightarrow E_{\psi(u)}$ uniquely. This defines $q : D \rightarrow E$ satisfying all properties required of a morphism of stable maps, as some routine considerations reveal. This finishes Case II. \square

Case III. This case is similar to Case II, but much simpler, because the construction of the composition of ϕ and (b, σ, ψ) is simpler, and thus for every $i \in F_{\sigma'}$ we have $c\chi^F(i) = \phi^F b(i)$. We use Proposition 2.5 instead of Proposition 2.4 to construct the pushforward of (C, x, f) under ϕ , gluing the two sections x_{i_1} and x_{i_2} of $C_{v_1} = C_{v_2}$ to obtain D_{v_0} . \square

Case IV. To construct the pushforward, set $D_v = C_{a(v)}$, $p_v : C_{a(v)} \rightarrow D_v$ the identity and $h_v = f_{a(v)}$, for every $v \in V_{\sigma}$. Moreover, for $i \in F_{\sigma}$ set $y_i = x_{a(i)}$. To check that (D, y, h) is a stable map and $p : (C, x, f) \rightarrow (D, y, h)$ a morphism of stable maps, the only fact to check is that for every $i \in F_{\sigma}$ we have $h_{\partial(i)}(y_i) = h_{\partial(j(i))}(y_{j(i)})$, in other words

$$f_{\partial a(i)}(x_{a(i)}) = f_{\partial(j(i))}(x_{a(j(i))}).$$

Here, Condition (3) in the definition of combinatorial morphism of A -graphs (Definition 1.7) enters in. It implies this claim together with Corollary 2.3. The universal mapping property of (D, y, h) is easily verified. \square

Case V. Before we can treat this case, we need a few preparations.

Proposition 3.9. *Let (C, x_1, \dots, x_n, f) be a stable map over a field from a curve of genus g to V and M an ample invertible sheaf on V . Then*

$$L = \omega_C(x_1 + \dots + x_n) \otimes f^*M^{\otimes 3}$$

is ample on C . Here ω_C is the dualizing sheaf of C .

Proof. Let us first consider the case that C has no nodes, so that C is irreducible and non-singular. Then it suffices to prove that $\deg L > 0$.

Case 1. The image $f(C)$ is a point. Then $\deg f^*M = 0$ and we have

$$\deg L = \deg \omega_C + n = 2g - 2 + n \geq 1,$$

by the stability condition.

Case 2. The image $f(C)$ is not a point. Then $\deg f^*M \geq 1$ and so

$$\deg L = 2g - 2 + n + 3 \deg f^*M \geq 2g - 2 + n + 3 = 2g + n + 1 > 0.$$

So suppose now that C has a node P . Let $q : C' \rightarrow C$ be the curve obtained by blowing up P and let $P_1, P_2 \in C'$ be the two points lying over P . Let $L' = q^*L$ and $f' = f \circ q$.

Case 1. The curve C' is connected. Then $(C', x_1, \dots, x_n, P_1, P_2, f')$ is a stable map and

$$L' = \omega_{C'}(x_1 + \dots + x_n + P_1 + P_2) \otimes f'^*M^{\otimes 3}.$$

Case 2. The curve C' is disconnected. Let C'_1 and C'_2 be the two components of C' and L'_1, L'_2 the restriction of L' to C'_1 and C'_2 , respectively. Let $f'_i : C'_i \rightarrow V$ for $i = 1, 2$ be the map induced by f' . Without loss of generality assume that $x_1, \dots, x_r \in C'_1$ and $x_{r+1}, \dots, x_n \in C'_2$, for some $0 \leq r \leq n$ and $P_1 \in C'_1, P_2 \in C'_2$. Then $(C'_1, x_1, \dots, x_r, P_1, f'_1)$ and $(C'_2, x_{r+1}, \dots, x_n, P_2, f'_2)$ are stable maps and

$$\begin{aligned} L'_1 &= \omega_{C'_1}(x_1 + \dots + x_r + P_1) \otimes f'^*_1 M^{\otimes 3} \\ L'_2 &= \omega_{C'_2}(x_{r+1} + \dots + x_n + P_2) \otimes f'^*_2 M^{\otimes 3}. \end{aligned}$$

Thus by induction on the the number of nodes we may assume that L' is ample on C' . Let \mathcal{F} be a coherent sheaf on C and $\mathcal{F}' = q^*\mathcal{F}$. Then there exists an n_0 such that for all $n \geq n_0$ we have that $\mathcal{F}' \otimes L'^{\otimes n}(-P_1)$, $\mathcal{F}' \otimes L'^{\otimes n}(-P_2)$ and $\mathcal{F}' \otimes L'^{\otimes n}(-P_1 - P_2)$ are generated by global sections. This implies that $\mathcal{F} \otimes L^{\otimes n}$ is generated by global sections. So L is ample. \square

We will now consider the following setup. Let $(C, x_1, \dots, x_{n+1}, f)$ be a stable map over T from an $(n+1)$ -pointed curve of genus g to V of class $\beta \in H_2(V)^+$, where $2g + n \geq 3$ if $\beta = 0$ (otherwise, $n \geq 0$).

If t is a geometric point of T and C' a component of C_t , then we say that C' is to be contracted, if, after removing x_{n+1} , the normalization of C' violates the stability condition. Equivalently,

- (1) C' is rational without self intersection (so that C' is equal to its normalization),
- (2) $x_{n+1} \in C'$,
- (3) C' has exactly two special points besides x_{n+1} , at least one of which is not a marked point, but a node,
- (4) $f_t(C')$ is a single point of V .

Pictorially, the only two possible components to be contracted look as follows.

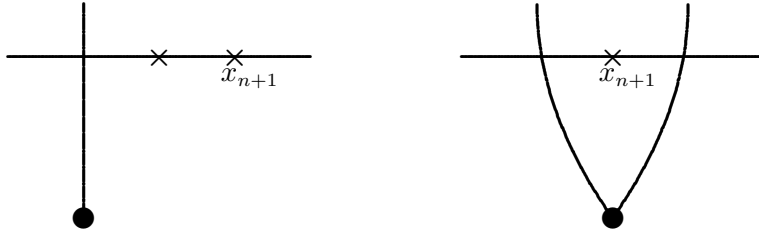

Note that every geometric fiber of $\pi : C \rightarrow T$ has at most one component to be contracted.

We say a T -morphism $q : C \rightarrow U$, for a T -scheme U , *contracts the components to be contracted*, if for every geometric point t of T the map (of underlying Zariski topological spaces) $q_t : C_t \rightarrow U_t$ maps every component to be contracted to a single point in U_t . For example, $f : C \rightarrow V_T$ contracts the components to be contracted.

Proposition 3.10. *There exists a universal morphism $p : C \rightarrow \tilde{C}$ contracting the components to be contracted. Let $\tilde{f} : \tilde{C} \rightarrow V$ be the unique map given by the universal mapping property of (\tilde{C}, p) . Then $(\tilde{C}, p(x_1), \dots, p(x_n), \tilde{f})$ is a stable map from an n -pointed curve of genus g to V of class β .*

Proof. This is a variation on Section 1 of [9]. Let us first prove the proposition for the case that T is the spectrum of an algebraically closed field. Let C' be a component to be contracted.

Case 1. The component C' has one node. We define $\tilde{C} = C - (C' - C)$ and let $p : C \rightarrow \tilde{C}$ be the obvious map. Clearly, $\mathcal{O}_{\tilde{C}} = p_*\mathcal{O}_C$, so \tilde{C} satisfies the universal mapping property by Lemma 2.2. The rest is trivial.

Case 2. The component C' has two nodes. We define $\overline{C} = C - (C' - C)$ and let P_1 and P_2 be the two points of \overline{C} that intersect C' . Then we set $\tilde{C} = \overline{C}/P_1 \sim P_2$, i.e. we identify the two points P_1 and P_2 . We then proceed similarly as in Case 1.

Lemma 3.11. *Let T be the spectrum of an algebraically closed field and let \tilde{C} be the universal curve contracting the components of C to be contracted. Choose an ample invertible sheaf M on V . Let*

$$L = \omega_C(x_1 + \dots + x_n) \otimes f^*M^{\otimes 3}$$

and

$$\tilde{L} = \omega_{\tilde{C}}(p(x_1) + \dots + p(x_n)) \otimes \tilde{f}^*M^{\otimes 3}.$$

Then for all $k \geq 0$ we have

- (1) $\tilde{L}^{\otimes k} = p_*L^{\otimes k}$,
- (2) $p^*\tilde{L}^{\otimes k} = L^{\otimes k}$,
- (3) $R^1f_*L^{\otimes k} = 0$,
- (4) $H^i(\tilde{C}, \tilde{L}^{\otimes k}) = H^i(C, L^{\otimes k})$, for $i = 0, 1$.

Proof. This is analogous to Lemma 1.6 of [9]. \square

Lemma 3.12. *Let T be the spectrum of an algebraically closed field and let L be defined as in Lemma 3.11. Define the open subset U of C by*

$$U = \{x \in C \mid x \text{ is smooth and } x \text{ is not in any component to be contracted}\}.$$

Then for k sufficiently large we have

- (1) $L^{\otimes k}$ is generated by global sections,
- (2) $H^1(C, L^{\otimes k}) = 0$,
- (3) $L^{\otimes k}$ is normally generated,
- (4) $L^{\otimes k}(-P)$ is generated by global sections for all $P \in U$.

(The sheaf L is normally generated if $\Gamma(C, L)^{\otimes k} \rightarrow \Gamma(C, L^{\otimes k})$ is surjective, for all $k \geq 1$.)

Proof. Let \tilde{C} and \tilde{L} be as in Lemma 3.11. Note that one can apply Proposition 3.9 to \tilde{C} and \tilde{L} . Then the results are implied by Lemma 3.11. \square

We can now proceed with the proof of Proposition 3.10 for general base T . Choose an ample invertible sheaf M on V and consider on C the invertible sheaf

$$L = \omega_{C/T}(x_1 + \dots + x_n) \otimes f^*M^{\otimes 3},$$

where $\omega_{C/T}$ is the relative dualizing sheaf of C over T . Then form

$$\mathcal{S} = \bigoplus_{k \geq 0} \pi_* L^{\otimes k},$$

where $\pi : C \rightarrow T$ is the structure map, and let

$$\tilde{C} = \text{Proj } \mathcal{S}.$$

Claim 1. The formation of \tilde{C} commutes with base change.

Proof. Clearly, the formation of $L^{\otimes k}$ commutes with base change. That the formation of $\pi_* L^{\otimes k}$ commutes with base change for k sufficiently large follows from the fact that $H^1(C_t, L^{\otimes k}) = 0$, for all $t \in T$, by Lemma 3.12. For $k = 0$ this is trivially true. Thus the formation of

$$\mathcal{S}^{(d)} = \bigoplus_{d|k} \mathcal{S}_k$$

commutes with base change, for a suitable $d > 0$. This implies the claim for \tilde{C} , since

$$\tilde{C} = \text{Proj } \mathcal{S} = \text{Proj } \mathcal{S}^{(d)}. \quad \square$$

Claim 2. The structure map $\tilde{\pi} : \tilde{C} \rightarrow T$ is flat and projective.

Proof. The flatness of $\text{Proj } \mathcal{S}^{(d)}$ follows from the fact that $\pi_* L^{\otimes k}$ is locally free, for $d | k$, which follows from the fact that its formation commutes with base change. By passing to a larger d if necessary, we may assume that for every $k \geq 0$ the homomorphism

$$\pi_*(L^{\otimes d})^{\otimes k} \longrightarrow \pi_*(L^{\otimes dk})$$

is surjective. This may be checked on fibers and thus follows from Lemma 3.12(3). So $\mathcal{S}^{(d)}$ is generated by $\mathcal{S}_1^{(d)}$ and hence $\text{Proj } \mathcal{S}^{(d)}$ is projective by Proposition 5.5.1 in [4]. \square

Claim 3. The canonical morphism from an open subset of C to \tilde{C} is everywhere defined, proper and surjective.

Proof. This canonical morphism is defined by $\pi^*\mathcal{S} \rightarrow \bigoplus_k L^{\otimes k}$, or equivalently by $\mathcal{S} \rightarrow \bigoplus_k \pi_* L^{\otimes k}$ (see Section 3.7 in [4]). For it to be everywhere defined, it suffices to prove that $\pi^*\pi_* L^{\otimes k} \rightarrow L^{\otimes k}$ is an epimorphism, for k sufficiently large. This may be checked on fibers and thus follows from Lemma 3.12(1). That the canonical morphism is dominant follows immediately, since $\mathcal{S} \rightarrow \bigoplus \pi_* L^{\otimes k}$ is an isomorphism. That it is proper, is clear. So it has to be surjective. \square

We call this canonical morphism $p : C \rightarrow \tilde{C}$.

Claim 4. Let x be a geometric point of \tilde{C} and $p^{-1}(x)$ the fiber of p over x . Then either the cardinality of $p^{-1}(x)$ is one or $p^{-1}(x)$ is a component of $C_{\tilde{\pi}(x)}$ to be contracted.

Proof. Without loss of generality we may assume that T is the spectrum of an algebraically closed field. Then with the notation of Lemma 3.12 and by Property (4) of the same lemma, we have that $p|U : U \rightarrow \tilde{C}$ is an open immersion. If C' is to be contracted, then $L|C' \cong \mathcal{O}_{C'}$, and so C' is mapped to a point in \tilde{C} . These facts clearly imply Claim 4. \square

Claim 5. We have $p_*\mathcal{O}_C = \mathcal{O}_{\tilde{C}}$.

Proof. With the notation of Claim 4, note that

$$H^1(p^{-1}(x), \mathcal{O}_C \otimes_{\mathcal{O}_{\tilde{C}}} \kappa(x)) = 0,$$

since $p^{-1}(x)$ is rational if it is one and not zero dimensional. So by Corollary 1.5 in [9], the formation of $p_*\mathcal{O}_C$ commutes with base change in T . So to prove the claim, we may assume that T is the spectrum of an algebraically closed field, but then it is clear. \square

Now by Lemma 2.2 the last three claims imply that $p : C \rightarrow \tilde{C}$ is a universal morphism contracting the components to be contracted. In particular, we get a unique morphism $\tilde{f} : C \rightarrow V$ such that $\tilde{f} \circ p = f$. The fact that $(\tilde{C}, p(x_1), \dots, p(x_n), \tilde{f})$ is a stable map from an n -pointed curve of genus g to V of class β may now be checked on fibers, which has already been done. This finishes the proof of Proposition 3.10. \square

We now proceed with the proof of Theorem 3.6 in Case V. Let $n = \#F_\sigma(v_0)$. Choose an identification $\underline{n+1} \rightarrow F_\tau(v_0)$ mapping $n+1$ to i_0 , the flag being removed. Then $(C_{v_0}, x_1, \dots, x_{n+1}, f_{v_0})$ is a stable map to which Proposition 3.10 applies and we let $p_{v_0} : C_{v_0} \rightarrow D_{v_0}$ be the universal morphism contracting the components to be contracted. For $v \neq v_0$ we let $D_v = C_v$ and $p_v : C_v \rightarrow D_v$ be the identity. It is then clear how to define y and h to get a stable map (D, y, h) satisfying the universal mapping property of a pushforward under the graph morphism $\tau \rightarrow \sigma$ given by $a : \sigma \rightarrow \tau$. This completes the proof of Case V. \square

To complete the proof of Theorem 3.6 we need to show that if (V, τ, α) is an object of $\mathfrak{V}\mathfrak{G}_s$ and $p : (C, x, f) \rightarrow (D, y, h)$ is a morphism of stable (V, τ, α) -maps (covering the identity of (V, τ, α)), then p is an isomorphism.

This is immediately reduced to the case that $(V, \tau, \alpha) = (V, g, n, \alpha)$ and using Lemma 2.2 to the case that T is the spectrum of an algebraically closed field.

Then it follows from the stability condition that p cannot contract any rational components, so it is injective. To prove that p is surjective use induction on the number of nodes of D . So let P be a node of D and let D' be the curve obtained from D by blowing up P and let $p' : C' \rightarrow D'$ by the pullback of $p : C \rightarrow D$ under $D' \rightarrow D$.

Case 1. The curve D' is disconnected, $D' = D'_1 \amalg D'_2$. Then $C' = C'_1 \amalg C'_2$ with induced maps $p'_i : C'_i \rightarrow D'_i$, for $i = 1, 2$. Let $g_i = g(D'_i)$ and $\alpha_i = f_*[D'_i]$, for $i = 1, 2$. Then $g = g_1 + g_2$ and $\alpha = \alpha_1 + \alpha_2$. Now $g_i(C'_i) \leq g_i(D'_i)$ and $f_*[C'_i] \leq f_*[D'_i]$ imply that $g_i(C'_i) = g_i$ and $f_*[C'_i] = \alpha_i$ and thus we may apply the induction hypothesis to p'_1 and p'_2 , proving the surjectivity of p .

Case 2. The curve D' is connected. Then C' is connected, since otherwise we would have two curves contradicting the induction hypothesis. So we may apply the induction hypothesis to $p' : C' \rightarrow D'$.

This finally completes the proof of Theorem 3.6. \square

Definition 3.13. For a given object (V, τ) of \mathfrak{VG}_s , we let $\overline{M}(V, \tau)(T)$ be the fiber of $\overline{M}(T)$ over (V, τ) under the cofibration of Theorem 3.6.

Letting T vary we get a stack $\overline{M}(V, \tau)$ on the category of k -schemes with the fppf-topology.

For $(V, \tau) = (V, g, n, \beta)$ we denote $\overline{M}(V, \tau)$ by $\overline{M}_{g,n}(V, \beta)$.

If $\text{char } k \neq 0$, let L be a very ample invertible sheaf on V . Consider only stable V -graphs for which $\beta(v)(L) < \text{char } k$, for all $v \in V_\tau$. If this condition is satisfied, we say that τ or (V, τ) is *bounded by the characteristic*. If $\text{char } k = 0$, we call *every* (V, τ) bounded by the characteristic, so that we have uniform terminology.

Theorem 3.14. *For every (V, τ) , bounded by the characteristic, the stack $\overline{M}(V, \tau)$ is a proper algebraic Deligne-Mumford stack over k .*

Proof. The proof will be postponed to a later section (see Corollary 4.8). \square

Every time we refer to $\overline{M}(V, \tau)$ as a Deligne-Mumford stack, we shall tacitly assume that (V, τ) is bounded by the characteristic.

Remark. Theorems 3.6 and 3.14 give rise to a functor

$$\begin{aligned} \overline{M} : \mathfrak{VG}_s &\longrightarrow (\text{proper algebraic DM-stacks over } k) \\ (V, \tau) &\longmapsto \overline{M}(V, \tau), \end{aligned}$$

by choosing for every k -scheme T a *clivage normalisé* (see Definition 7.1 in [6, Exp. VI]) of the cofibered category $\overline{M}(T)$ over \mathfrak{VG}_s . Of course, this functor \overline{M} is essentially independent of the choice of the *clivage normalisé*.

Another way of stating this would be to construct a fibered category \overline{M} over $\mathfrak{VG}_s^{\text{op}} \times (k\text{-schemes})$, such that $\overline{M}(V, \tau)(T)$ is the fiber of \overline{M} over (V, τ, T) and $\overline{M}(T)$ is the fiber of \overline{M} over T .

4. FURTHER STUDY OF \overline{M}

Proposition 4.1. *Let (V, τ) be an object of $\mathfrak{V}\mathfrak{G}_s$, bounded by the characteristic of k . Then the diagonal*

$$\Delta : \overline{M}(V, \tau) \longrightarrow \overline{M}(V, \tau) \times \overline{M}(V, \tau)$$

is representable, finite and unramified.

Proof. The assumption that (V, β) is bounded by the characteristic implies that all stable maps of class β are separable. So by Lemma 4.2 we may reduce the case of stable maps to the case of stable curves, which is well-known. \square

Lemma 4.2. *Let (C, x, f) and (D, y, h) be n -pointed stable maps to V over the base T , and $t \in T(K)$ a geometric point of T . Assume that $f_t : C_t \rightarrow V$ and $h_t : D_t \rightarrow V$ are separable morphisms. Then there exists an étale neighborhood $S \rightarrow T$ of t , an integer N , markings $x' = (x'_1, \dots, x'_N)$ of C_S and $y' = (y'_1, \dots, y'_N)$ of D_S such that (C_S, x_S, x') and (D_S, y_S, y') are stable marked curves over S and a closed immersion of sheaves on $(S$ -schemes)*

$$\underline{\text{Isom}}((C, x, f), (D, y, h))_S \longrightarrow \underline{\text{Isom}}((C_S, x_S, x'), (D_S, y_S, y')).$$

Proof. Without loss of generality assume that C and D have the same genus g and f and h have the same class β . Choose an embedding $\mu : V \hookrightarrow \mathbb{P}^r$, let $d = \mu_*\beta$ and reduce to the case $V = \mathbb{P}^r$ and $d = \beta$. Let $N = d(r+1)$. Choose linearly independent hyperplanes H_0, \dots, H_r in \mathbb{P}^r such that for each $i = 0, \dots, r$

- (1) no special point of C_t or D_t is mapped into $H_{i,K}$ under f_t or g_t ,
- (2) f_t and g_t are transversal to $H_{i,K}$.

Then there exists an étale neighborhood $S \rightarrow T$ of t such that

- (1) for each $i = 0, \dots, r$
 - (a) $H_{i,S} \cap C_S$ gives rise to d sections $x'_{di+1}, \dots, x'_{di+d}$ of C_S over S ,
 - (b) $H_{i,S} \cap D_S$ gives rise to d sections $y'_{di+1}, \dots, y'_{di+d}$ of D_S over S ,
- (2) (C_S, x_S, x') and (D_S, y_S, y') are marked prestable curves.

Then (C_S, x_S, x') and (D_S, y_S, y') are in fact stable and there exists an obvious morphism

$$\underline{\text{Isom}}((C, x, f), (D, y, h))_S \longrightarrow \underline{\text{Isom}}((C_S, x_S, x'), (D_S, y_S, y')),$$

which is clearly a closed immersion. \square

Lemma 4.3. *Let $(C, x_1, \dots, x_{n+1}, f)$ be a stable map and (D, y_1, \dots, y_n, h) the stabilization under forgetting x_{n+1} . Let $p : C \rightarrow D$ be the structure morphism. Then any section y_0 of D making (D, y_0, \dots, y_n) a marked prestable curve lifts uniquely to a section x_0 of C making (C, x_0, \dots, x_n) a marked prestable curve. If y_0 avoids $p(x_{n+1})$, then (C, x_0, \dots, x_{n+1}) is a marked prestable curve.*

Proof. Let $V \subset D$ be the open subset consisting of smooth points of D which are not in the image of y_i , for any $i = 1, \dots, n$. Let $U = p^{-1}(V)$. Then p induces an isomorphism $p|_U : U \xrightarrow{\sim} V$. Moreover, U is smooth and x_{n+1} is the only section of C which may meet U . \square

Proposition 4.4. *Let $(C, x_1, \dots, x_{n+1}, f)$ and $(\tilde{C}, \tilde{x}_1, \dots, \tilde{x}_{n+1}, \tilde{f})$ be stable maps with isomorphic stabilizations forgetting the $(n+1)$ -st section. Let (C, y_1, \dots, y_n, h) be such a stabilization, with structure maps $p : C \rightarrow D$ and $\tilde{p} : \tilde{C} \rightarrow D$. If $p(x_{n+1}) = \tilde{p}(\tilde{x}_{n+1})$ then there exists a unique isomorphism $q : C \rightarrow \tilde{C}$ of stable maps such that $\tilde{p} \circ q = p$.*

Proof. This is local over the base, so we may freely choose sections as necessary. In fact, choose sections z_1, \dots, z_N of D in the smooth locus, avoiding y_1, \dots, y_n and $\Delta = p(x_{n+1}) = \tilde{p}(\tilde{x}_{n+1})$ and making

$$(D, z_1, \dots, z_N, y_1, \dots, y_n)$$

a stable marked curve. By Lemma 4.3 these lift uniquely to sections w_1, \dots, w_N of C and $\tilde{w}_1, \dots, \tilde{w}_N$ of \tilde{C} making

$$(C, w_1, \dots, w_N, x_1, \dots, x_{n+1})$$

and

$$(\tilde{C}, \tilde{w}_1, \dots, \tilde{w}_N, \tilde{x}_1, \dots, \tilde{x}_{n+1})$$

marked prestable curves. Moreover, these are clearly marked *stable* curves with a common stabilization

$$(D, z_1, \dots, z_N, y_1, \dots, y_n)$$

forgetting the last section, such that $p(x_{n+1}) = \tilde{p}(\tilde{x}_{n+1})$. Then they have to be isomorphic by Knutson's theorem (see [9]) that $\overline{M}_{g, N+n+1}$ is the universal curve over \overline{M}_{N+n} . \square

Proposition 4.5. *Let (C, x_1, \dots, x_n, f) be a stable map and Δ a section of C . Then there exists up to isomorphism a unique stable map $(\tilde{C}, \tilde{x}_1, \dots, \tilde{x}_{n+1}, \tilde{f})$ such that (C, x_1, \dots, x_n, f) is the stabilization of $(\tilde{C}, \tilde{x}_1, \dots, \tilde{x}_{n+1}, \tilde{f})$ forgetting the $(n+1)$ -st section and $p(\tilde{x}_{n+1}) = \Delta$, where $p : \tilde{C} \rightarrow C$ is the structure map.*

Proof. Uniqueness follows from Proposition 4.4, hence existence is a local question. Thus we may choose sections z_1, \dots, z_N of C such that

$$(C, z_1, \dots, z_N, x_1, \dots, x_n)$$

is a stable marked curve. By Knudsen's result again, there exists a stable curve

$$(C', z'_1, \dots, z'_N, x'_1, \dots, x'_{n+1})$$

whose stabilization forgetting the last section is

$$(C, z_1, \dots, z_N, x_1, \dots, x_n)$$

and such that $q(x'_{n+1}) = \Delta$, where $q : C' \rightarrow C$ is the structure map. Clearly,

$$(C', z'_1, \dots, z'_N, x'_1, \dots, x'_{n+1}, f \circ q)$$

is a stable map. Then let $(\tilde{C}, \tilde{x}_1, \dots, \tilde{x}_{n+1}, \tilde{f})$ be the stabilization of

$$(C', z'_1, \dots, z'_N, x'_1, \dots, x'_{n+1}, f \circ q)$$

forgetting the sections z'_1, \dots, z'_N . By its universal mapping property there exists a morphism $p : \tilde{C} \rightarrow C$ which makes (C, x_1, \dots, x_n, f) the stabilization of $(\tilde{C}, \tilde{x}_1, \dots, \tilde{x}_{n+1}, \tilde{f})$ forgetting \tilde{x}_{n+1} . \square

Corollary 4.6. *Let $C_{g,n}(V, \beta)$ be the universal curve over $\overline{M}_{g,n}(V, \beta)$. Then the canonical morphism $\overline{M}_{g,n+1}(V, \beta) \rightarrow C_{g,n}(V, \beta)$ induced by the $(n+1)$ -st section is an isomorphism. \square*

Proposition 4.7. *Let (C, x, f) be a stable (V, g, n, β) -map over T . Then the set of $t \in T$ such that (C, x) is a stable marked curve is open in T .*

Proof. The set of such t is the set of all $t \in T$ for which (C, x) is isomorphic to its stabilization. For any morphism of schemes, the set of elements of its source at which it is an isomorphism is always open. Finally, use properness of prestable curves. \square

By this proposition we may define

$$U_{g,n}(V, \beta) \subset \overline{M}_{g,n}(V, \beta)$$

to be the open substack of those stable maps, whose underlying marked curve is stable. The canonical morphism $U_{g,n}(V, \beta) \rightarrow \overline{M}_{g,n}$ has as fiber over the marked curve (C, x) the scheme of morphisms from C to V of class β . By results of Grothendieck in [3] this is a quasi-projective scheme. Hence $U_{g,n}(V, \beta)$ is an algebraic k -stack of finite type. Now, for given n there exists an $N > n$ such that $U_{g,N}(V, \beta) \rightarrow \overline{M}_{g,n}(V, \beta)$ is surjective. Since this morphism is flat by Corollary 4.6, it is a flat epimorphism, hence a presentation of $\overline{M}_{g,n}(V, \beta)$. Together with Proposition 4.1 this implies that $\overline{M}_{g,n}(V, \beta)$ is a finite type separated algebraic Deligne-Mumford stack over k . This is then true for all objects of \mathfrak{MG}_s , bounded by the characteristic.

Corollary 4.8. *Theorem 3.14 is true.*

Proof. It only remains to show properness. This is easily reduced to the case $(V, \tau) = (\mathbb{P}^r, g, n, d)$ and follows from Proposition 3.3 of [13]. \square

5. AN OPERADIC PICTURE

Definition 5.1. Let (τ, α) be an A -graph. Let $R_\tau \subset F_\tau \times F_\tau$ be defined by $(f, \bar{f}) \in R_\tau$ if and only if one of the conditions

- (1) $\bar{f} = j_\tau(f)$,
- (2) $\partial f = \partial \bar{f}$ and for $v = \partial f = \partial \bar{f}$ we have $g(v) = \alpha(v) = 0$

is satisfied. Let \sim be the equivalence relation on F_τ generated by R_τ and let

$$P_\tau = F_\tau / \sim .$$

(In fact, $P_{(\tau, \alpha)}$ would be better notation, but we will stick with the abuse of notation P_τ .)

Proposition 5.2. Let $a : (B, \sigma) \rightarrow (A, \tau)$ be a combinatorial morphism of marked graphs. Then $a_F : F_\sigma \rightarrow F_\tau$ preserves equivalence. \square

Remark. In fact, Condition (3) of Definition 1.7 may be replaced by requiring a_F to preserve equivalence.

Proposition 5.3. Let $\phi : \tau \rightarrow \sigma$ be a contraction of A -graphs. Then $\phi^F : F_\sigma \rightarrow F_\tau$ preserves equivalence. \square

Proposition 5.4. If

$$\begin{array}{ccccc} B & & \pi & \xrightarrow{\psi} & \rho \\ \xi \uparrow & & b \downarrow & & \downarrow a \\ A & & \sigma & \xrightarrow{\phi} & \tau \end{array}$$

is a stable pullback, then the induced diagram

$$\begin{array}{ccc} P_\pi & \xleftarrow{\psi^F} & P_\rho \\ b \downarrow & & \downarrow a \\ P_\sigma & \xleftarrow{\phi^F} & P_\tau \end{array}$$

commutes. \square

By Propositions 5.2, 5.3 and 5.4, we have a contravariant functor

$$P : \mathfrak{G}_s \longrightarrow (\text{finite sets})$$

given by $P(A, \tau) = P_\tau$ on objects. Composing with the functor $\mathfrak{V}\mathfrak{G}_s \rightarrow \mathfrak{G}_s$ we get a contravariant functor

$$\begin{aligned} P : \mathfrak{V}\mathfrak{G}_s &\longrightarrow (\text{finite sets}) \\ (V, \tau) &\longmapsto P_\tau. \end{aligned}$$

There is an obvious functor

$$\begin{aligned} \mathfrak{V} \times (\text{finite sets}) &\longrightarrow \mathfrak{V} \\ (V, P) &\longmapsto V^P, \end{aligned}$$

contravariant in the second argument, and composing with P times the natural functor $\mathfrak{V}\mathfrak{G}_s \rightarrow \mathfrak{V}$ gives rise to a covariant functor

$$\begin{aligned} P : \mathfrak{V}\mathfrak{G}_s &\longrightarrow \mathfrak{V} \\ (V, \tau) &\longmapsto V^{P\tau}, \end{aligned}$$

still denoted P , by abuse of notation. We may consider \mathfrak{V} as a subcategory of the 2-category of proper algebraic Deligne-Mumford stacks over k and consider this as a functor

$$P : \mathfrak{V}\mathfrak{G}_s \longrightarrow (\text{proper algebraic DM-stacks over } k).$$

Now fix an object (V, τ) of $\mathfrak{V}\mathfrak{G}_s$. Let (C, x, f) be a stable (V, τ) -map over T . Then x and f define a morphism

$$\begin{aligned} f(x) : T &\longrightarrow V^{F\tau} \\ t &\longmapsto (f(x_i(t)))_{i \in F\tau}. \end{aligned}$$

By Corollary 2.3 this morphism $f(x)$ factors through $V^{P\tau} \subset V^{F\tau}$, so we consider it as a morphism

$$f(x) : T \longrightarrow V^{P\tau}.$$

Thus we get a map $\overline{M}(V, \tau)(T) \rightarrow P(V, \tau)(T)$. Since it is compatible with base change $S \rightarrow T$, we have a morphism of k -stacks

$$\text{ev}(V, \tau) : \overline{M}(V, \tau) \longrightarrow P(V, \tau).$$

Proposition 5.5. *We have defined a natural transformation of functors from $\mathfrak{V}\mathfrak{G}_s$ to (proper algebraic DM-stacks over k)*

$$\text{ev} : \overline{M} \longrightarrow P,$$

called evaluation.

In the general framework of Γ -operads, this allows us to consider (appropriate subfunctors of) \overline{M} and P as a modular operad and a cyclic endomorphism operad, respectively. The evaluation functor then induces a structure of \overline{M} -algebra on V .

Part II. Gromov-Witten Invariants

6. ISOGENIES

Definition 6.1. Let τ be a stable A -graph.

- (1) The *class* of τ is

$$\beta(\tau) = \sum_{v \in V_\tau} \beta(v).$$

- (2) The *Euler characteristic* of τ is

$$\chi(\tau) = \chi(|\tau|) - \sum_{v \in v_\tau} g(v).$$

- (3) If $|\tau|$ is non-empty and connected the *genus* of τ is

$$g(\tau) = 1 - \chi(\tau).$$

Definition 6.2. Let τ be a stable V -graph, where V is of pure dimension.

- (1) The *dimension* of τ is

$$\dim(V, \tau) = \chi(\tau)(\dim V - 3) - \beta(\tau)(\omega_V) + \#S_\tau - \#E_\tau,$$

where ω_V is the canonical line bundle on V .

- (2) The *degree* of τ is

$$\begin{aligned} \deg(V, \tau) = & \beta(\tau)(\omega_V) + (\dim V - 3)(\chi(\tau^s) - \chi(\tau)) + (\#S_{\tau^s} - \#S_\tau) - (\#E_{\tau^s} - \#E_\tau), \end{aligned}$$

where τ^s is the absolute stabilization of τ .

Note that

$$\dim(V, \tau) - \dim(\tau^s) = \chi(\tau^s) \dim V - \deg(V, \tau).$$

Definition 6.3. The stable A -graph with one vertex of genus and class zero and three tails (no edges) shall be called the A -*tripod*, or simply a *tripod*.

Definition 6.4. Let $a : \tau' \rightarrow \tau$ be a combinatorial morphism of stable A -graphs. A *tail map* for a is a map $m : S_{\tau'} \rightarrow S_\tau$. Let $(a, \tau', \phi) : \tau \rightarrow \sigma$ be a morphism of stable A -graphs. A *tail map* for (a, τ', ϕ) is a tail map for a .

Since for a contraction $\phi : \tau' \rightarrow \sigma$ the map $\phi^F : F_\sigma \rightarrow F_{\tau'}$ induces a bijection $\phi^S : S_\sigma \rightarrow S_{\tau'}$, there is an obvious way to compose morphisms with tail map of stable A -graphs. By abuse we will also call the composition $m \circ \phi^S$ the tail map of (a, τ', ϕ, m) .

Definition 6.5. Let $a : \tau' \rightarrow \tau$ be a combinatorial morphism of stable A -graphs with tail map $m : S_{\tau'} \rightarrow S_\tau$. We say that (a, m) is of type *stably forgetting a tail*, or that τ' is obtained from τ by *stably forgetting a tail*, if there exists a tail f of τ such that

- (1) τ' is the stabilization of τ'' , where τ'' is obtained from τ by forgetting the tail f ,

- (2) for all $h \in S_{\tau'}$, such that $a(h)$ is a tail, we have $m(h) = a(h)$,
 (3) $f \notin m(S_{\tau'})$.

Note that the tail f is uniquely determined by (a, m) and f determines (a, m) uniquely. We say that (a, m) stably forgets the tail f .

Remark 6.6. Every combinatorial morphism (with tail map) of type stably forgetting a tail is of one of the following types (notation of Definition 6.5).

Type I (Incomplete case). No stabilization is needed, i.e. $\tau' = \tau''$.

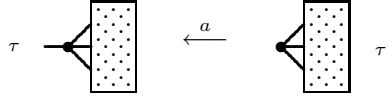

Type II (Removing a tripod from a tail). Only in this case does the tail map m contain any information. It serves to ‘remember’ which of the two tails in the following diagram is being forgotten by a .

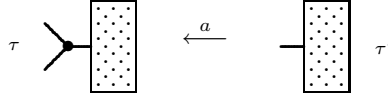

Type III (Removing a tripod from an edge).

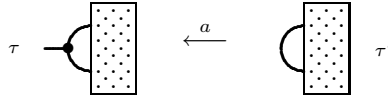

Type IV (Forgetting a lonely tripod or a lonely elliptic component.) Only in this case does the number of connected components of the geometric realization change.

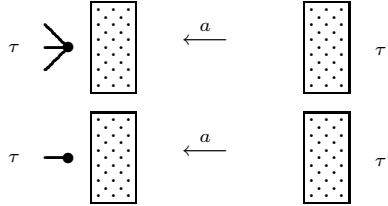

Here, the genus of the vertex displayed in the last diagram is equal to one.

Definition 6.7. Let $(a, \tau', \phi, m) : \tau \rightarrow \sigma$ be a morphism of stable A -graphs with tail map. We call (a, τ', ϕ, m) an *isogeny*, if

- (1) (a, m) is a composition of morphisms of type stably forgetting a tail,
- (2) $\pi_0|\sigma| \rightarrow \pi_0|\tau|$ is bijective.

We call the isogeny $\Phi : \tau \rightarrow \sigma$ an *elementary isogeny*, if it is an elementary contraction, or if σ is obtained from τ by stably forgetting a tail.

Note. If $\Phi : \tau \rightarrow \sigma$ is an isogeny of stable A -graphs, then $\chi(\sigma) = \chi(\tau)$.

An elementary isogeny either contracts a loop, or a non-looping edge or is of type stably forgetting a tail I, II, or III.

If we write $\Phi : \tau \rightarrow \sigma$ for an isogeny of stable A -graphs, we denote the tail map of Φ by $\Phi^S : S_\sigma \rightarrow S_\tau$.

Proposition 6.8. *The composition of isogenies is an isogeny.*

Proof. Let

$$\begin{array}{ccccc} A & & \pi & \xrightarrow{\psi} & \rho \\ \text{id} \uparrow & & b \downarrow & & \downarrow a \\ A & & \sigma & \xrightarrow{\phi} & \tau \end{array}$$

be a stable pullback, where a stably forgets the tail f of τ , $\pi_0|\rho| \rightarrow \pi_0|\tau|$ is bijective and ϕ is an elementary contraction of stable A -graphs. Then b stably forgets the tail $\phi^F(f)$ of σ . Even if there is a vertex v_0 of τ which does not appear in ρ , this vertex v_0 cannot be the vertex onto which ϕ contracts an edge. \square

Fix a semi-group with indecomposable zero A . We shall define a category $\tilde{\mathfrak{G}}_s(A)$ from $\mathfrak{G}_s(A)$, retaining only isogenies and morphisms of type cutting edges, but reversing the direction of the latter, making them morphisms *gluing tails*.

In fact, define the category $\tilde{\mathfrak{G}}_s(A)$ as follows. Objects of $\tilde{\mathfrak{G}}_s(A)$ are stable A -graphs. A morphism $\sigma \rightarrow \tau$ is a triple (a, σ', Φ) , where $a : \sigma \rightarrow \sigma'$ is a combinatorial morphism of A -graphs of type cutting edges and $\Phi : \sigma' \rightarrow \tau$ is an isogeny of stable A -graphs. To compose $(a, \sigma', \Phi) : \sigma \rightarrow \tau$ and $(b, \tau', \Psi) : \tau \rightarrow \rho$, we need to construct a diagram

$$(5) \quad \begin{array}{ccccc} \sigma'' & \xrightarrow{\Xi} & \tau' & \xrightarrow{\Psi} & \rho \\ c \uparrow & & \uparrow b & & \\ \sigma' & \xrightarrow{\Phi} & \tau & & \\ a \uparrow & & & & \\ \sigma, & & & & \end{array}$$

where $c : \sigma' \rightarrow \sigma''$ is a combinatorial morphism of type cutting edges and $\Xi : \sigma'' \rightarrow \tau'$ is an isogeny of stable A -graphs.

Let f and \bar{f} be two tails of τ such that $\{b(f), b(\bar{f})\}$ is an edge of τ' . Then construct σ'' from σ' by gluing the two tails $\Phi^S(f)$ and $\Phi^S(\bar{f})$ to an edge. If b , cuts more than one edge, iterate this process to construct σ'' . This defines composition of morphisms in $\tilde{\mathfrak{G}}_s(A)$, which is clearly associative.

Note. In the situation of (5), we get a diagram in $\mathfrak{G}_s(A)$

$$\begin{array}{ccccc} \sigma'' & \xrightarrow{\Xi} & \tau' & & \\ \bar{c} \downarrow & & \downarrow \bar{b}, & & \\ \sigma' & \xrightarrow{\Phi} & \tau & & \end{array}$$

which is easily seen to commute. Here, \bar{b} and \bar{c} are the morphisms of stable A -graphs induced by b and c , respectively.

Definition 6.9. We call $\tilde{\mathfrak{G}}_s(A)$ the *extended category of isogenies of stable A -graphs*, or the *extended isogeny category* over A .

The morphisms in $\tilde{\mathfrak{G}}_s(A)$ are called *extended isogenies*. An extended isogeny is called *elementary*, if it is an elementary isogeny or glues two tails to an edge.

Now consider the following situation. Fix a smooth projective variety V of pure dimension. Let $\Phi : \tau \rightarrow \sigma$ be an elementary extended isogeny of stable modular graphs. Let σ' be a stable V -graph and $b : \sigma \rightarrow \sigma'$ a combinatorial morphism identifying σ as the absolute stabilization of σ' . Note that b is injective on vertices and complete, so that $b : F_\sigma(v) \rightarrow F_{\sigma'}(b(v))$ is bijective, for all $v \in V_\sigma$. Let $(a_i, \tau_i)_{i \in I}$ be a family of pairs, where I is a finite set and for each $i \in I$ we have a combinatorial morphism $a_i : \tau \rightarrow \tau_i$ identifying τ as the absolute stabilization of τ_i . Finally, let for every $i \in I$ be given an extended isogeny of stable V -graphs $\Phi_i : \tau_i \rightarrow \sigma'$. In particular, for each $i \in I$ we have a diagram of stable marked graphs (but note that the horizontal and vertical morphisms live in different categories)

$$\begin{array}{ccc} \tau_i & \xrightarrow{\Phi_i} & \sigma' \\ \bar{\pi}_i \downarrow & & \downarrow \bar{b} \\ \tau & \xrightarrow{\Phi} & \sigma \end{array}$$

We shall now define what we mean by $(a_i, \tau_i, \Phi_i)_{i \in I}$ to be *cartesian*, or a *pullback* of σ' under Φ . We have to distinguish six cases, according to which kind of elementary extended isogeny Φ is.

Let us first consider the case that Φ is an elementary contraction $\phi : \tau \rightarrow \sigma$, contracting the edge $\{f, \bar{f}\}$ of τ . As usual, let $v_1 = \partial f$, $v_2 = \partial \bar{f}$ and $w_0 = \phi(v_1) = \phi(v_2)$. Let $w_0 = b(v_0)$.

Case I (Contracting a loop). In this case $v_1 = v_2$. The set I has one element, say 0, and (a_0, τ_0, Φ_0) is cartesian, if Φ_0 is a contraction contracting a single loop $\{a_0(f), a_0(\bar{f})\}$ onto w_0 .

Case II (Contracting a non-looping edge). In this case $v_1 \neq v_2$. We require each Φ_i to contract exactly one edge, namely $\{a_i(f), a_i(\bar{f})\}$ onto w_0 . In particular, this means that the only way the various (a_i, τ_i, Φ_i) differ is in the classes of $a_i(v_1)$ and $a_i(v_2)$. We require that $(\beta(a_i(v_1)), \beta(a_i(v_2)))_{i \in I}$ be a complete and non-repetitive list of all pairs of elements of $H_2(V)^+$ adding up to $\beta(w_0)$.

Case III (Forgetting a tail). Let us now deal with the case that $\Phi : \tau \rightarrow \sigma$ stably forgets the tail $f \in S_\tau$. We require I to have one element, say 0, and call (a_0, τ_0, Φ_0) cartesian if Φ_0 stably forgets the tail $a_0(f)$ (and does nothing else).

Case IV (Gluing two tails to an edge). Finally, let us consider the case that Φ is given by a combinatorial morphism $c : \tau \rightarrow \sigma$, gluing the two tails f and \bar{f} of τ to an edge $\{c(f), c(\bar{f})\}$ of σ . Again, I is required to have one element, say 0, and (a_0, τ_0, Φ_0) is called cartesian if Φ_0 glues two tails of τ_0 to an edge of σ' (and does

nothing else). Moreover, we require that $\Phi_0 \circ a_0 = b \circ c$. An example:

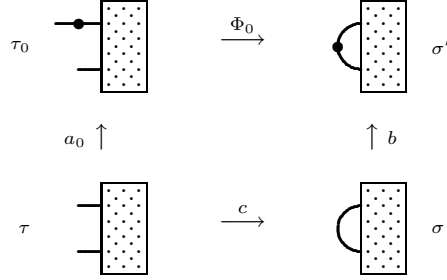

Note that in each case pullbacks exist, even though they are not necessarily unique, even up to isomorphism, in the last two cases. Note also, that for each $i \in I$ we have $\deg(\tau_i) = \deg(\sigma')$.

We shall now define still another category, denoted $\tilde{\mathfrak{G}}_s(V)_{\text{cart}}$, called the *cartesian extended isogeny category* over V .

Definition 6.10. Objects of $\tilde{\mathfrak{G}}_s(V)_{\text{cart}}$ are pairs $(\tau, (a_i, \tau_i)_{i \in I})$, where τ is a stable modular graph, I is a finite set and for each $i \in I$ the pair (a_i, τ_i) is a stable V -graph τ_i , together with a combinatorial morphism $a_i : \tau \rightarrow \tau_i$, identifying τ as the absolute stabilization of τ_i .

A *pre-morphism* from $(\tau, (a_i, \tau_i)_{i \in I})$ to $(\sigma, (b_j, \sigma_j)_{j \in J})$ is a triple $(\Phi, \lambda, (\Phi_i)_{i \in I})$, where $\Phi : \tau \rightarrow \sigma$ is an extended isogeny of stable modular graphs, $\lambda : I \rightarrow J$ is a map and for each $i \in I$ we have an extended isogeny of stable V -graphs $\Phi_i : \tau_i \rightarrow \sigma_{\lambda(i)}$. It is clear how to compose such pre-morphisms and that composition is associative.

A *morphism* in $\tilde{\mathfrak{G}}_s(V)_{\text{cart}}$ is defined to be a pre-morphism which can be factored into a composition of elementary morphisms and isomorphisms. It is clear what an isomorphism is. An *elementary morphism* is a pre-morphism $(\Phi, \lambda, (\Phi_i)_{i \in I})$, as above, such that

- (1) Φ is an elementary extended isogeny,
- (2) for each $j \in J$ we have that $(a_i, \tau_i, \Phi_i)_{i \in \lambda^{-1}(j)}$ is cartesian in the sense defined in Cases I through IV, above.

Remark 6.11. Projecting onto the first component defines a functor

$$\tilde{\mathfrak{G}}_s(V)_{\text{cart}} \longrightarrow \tilde{\mathfrak{G}}_s(0).$$

Despite the notation, this is not a fibration of categories.

We shall, in what follows, often shorten the notation $(\tau, (a_i, \tau_i)_{i \in I})$ to $(\tau, (\tau_i)_{i \in I})$ or even $(\tau_i)_{i \in I}$.

Call an object $(\tau_i)_{i \in I}$ of $\tilde{\mathfrak{G}}_s(V)_{\text{cart}}$ *homogeneous* of degree $n \in \mathbb{Z}$, if for all $i \in I$ we have $\deg(V, \tau_i) = n$.

For a stable modular graph τ , we may consider the fiber $\tilde{\mathfrak{G}}_s(V)_{\text{cart}/\tau}$ of the functor $\tilde{\mathfrak{G}}_s(V)_{\text{cart}} \rightarrow \tilde{\mathfrak{G}}_s(0)$ over τ . In every such fiber $\tilde{\mathfrak{G}}_s(V)_{\text{cart}/\tau}$ we have a functor

$$\oplus : \tilde{\mathfrak{G}}_s(V)_{\text{cart}/\tau} \times \tilde{\mathfrak{G}}_s(V)_{\text{cart}/\tau} \longrightarrow \tilde{\mathfrak{G}}_s(V)_{\text{cart}/\tau},$$

given by

$$(\tau_i)_{i \in I} \oplus (\sigma_j)_{j \in J} = ((\tau_i)_{i \in I}, (\sigma_j)_{j \in J}),$$

where we think of the object on the right hand side as a family parametrized by $I \amalg J$. The functor \oplus satisfies some obvious properties, which we shall not list.

Every object $X = (\tau_i)_{i \in I}$ of $\tilde{\mathfrak{G}}_s(V)_{\text{cart}}$ has a unique decomposition $X = \bigoplus_{n \in \mathbb{Z}} X_n$ into homogeneous components. Every morphism in $\tilde{\mathfrak{G}}_s(V)_{\text{cart}}$ respects this decomposition.

Finally, $\tilde{\mathfrak{G}}_s(V)_{\text{cart}}$ is a tensor category (in the sense of [1]) with tensor product given by

$$\otimes : \tilde{\mathfrak{G}}_s(V)_{\text{cart}} \times \tilde{\mathfrak{G}}_s(V)_{\text{cart}} \longrightarrow \tilde{\mathfrak{G}}_s(V)_{\text{cart}},$$

which is defined by the formula

$$(\tau, (\tau_i)_{i \in I}) \otimes (\sigma, (\sigma_j)_{j \in J}) = (\tau \times \sigma, (\tau_i \times \sigma_j)_{(i,j) \in I \times J}).$$

For two graphs σ and τ we denote by $\sigma \times \tau$ the graph whose geometric realization is the disjoint union of $|\sigma|$ and $|\tau|$. This notion extends in an obvious way to marked graphs. The identity object for \otimes is the one element family with value the empty graph.

There are obvious compatibilities between these various structures on $\tilde{\mathfrak{G}}_s(V)_{\text{cart}}$. For example, if $X = \bigoplus_n X_n$ and $Y = \bigoplus_m Y_m$ are objects of $\tilde{\mathfrak{G}}_s(V)_{\text{cart}}$, then the decomposition of $X \otimes Y$ into homogeneous components is given by

$$X \otimes Y = \bigoplus_r \left(\bigoplus_{n+m=r} X_n \otimes Y_m \right).$$

We summarize these properties by saying that $\tilde{\mathfrak{G}}_s(V)_{\text{cart}}$ has \oplus , \otimes and deg structures.

A formally similar situation arises, for example, if we consider the category of morphisms of an additive tensor category \mathfrak{C} in which all homomorphism groups are graded. If we denote this morphism category by \mathfrak{MC} , there is a functor $\mathfrak{MC} \rightarrow \mathfrak{C} \times \mathfrak{C}$, given by source and target, whose fibers have a graded \oplus -structure as above. Also, \mathfrak{MC} becomes a tensor category compatible with deg and \oplus . So \mathfrak{MC} has \oplus , \otimes and deg structures. In fact, Gromov-Witten invariants may be thought of as a functor from $\tilde{\mathfrak{G}}_s(V)_{\text{cart}}$ to \mathfrak{MC} respecting the \oplus , \otimes and deg structures. In this case \mathfrak{C} will be a category of motives.

Definition 6.12. A full subcategory $\tilde{\mathfrak{T}}_s(A) \subset \tilde{\mathfrak{G}}_s(A)$ is called *admissible*, if it satisfies the following axioms.

- (1) If $\Phi : \sigma \rightarrow \tau$ is an extended isogeny in $\tilde{\mathfrak{G}}_s(A)$ and $\tau \in \text{ob } \tilde{\mathfrak{T}}_s(A)$, then $\sigma \in \text{ob } \tilde{\mathfrak{T}}_s(A)$.
- (2) If σ and τ are in $\tilde{\mathfrak{T}}_s(A)$, then so is $\sigma \times \tau$.

For an admissible subcategory $\tilde{\mathfrak{T}}_s(A) \subset \tilde{\mathfrak{G}}_s(A)$ and a homomorphism $\xi : A \rightarrow B$, the full subcategory $\tilde{\mathfrak{T}}_s(B) \subset \tilde{\mathfrak{G}}_s(B)$ of graphs which are stabilizations of objects of $\tilde{\mathfrak{T}}_s(A)$ is admissible.

For a smooth projective variety V of pure dimension, we may construct the full subcategory $\tilde{\mathfrak{F}}_s(V)_{\text{cart}} \subset \tilde{\mathfrak{G}}_s(V)_{\text{cart}}$, called the *associated cartesian category*, which may be characterized as the subcategory of $\tilde{\mathfrak{G}}_s(V)_{\text{cart}}$ such that for each object $(\tau, (a_i, \tau_i)_{i \in I})$ we have that $\tau \in \text{ob } \tilde{\mathfrak{F}}_s(0)$ and for all $i \in I$ that $\tau_i \in \text{ob } \tilde{\mathfrak{F}}_s(V)$. Note that $\tilde{\mathfrak{F}}_s(V)_{\text{cart}}$ inherits the \oplus , \otimes and deg structures from $\tilde{\mathfrak{G}}_s(V)_{\text{cart}}$.

Examples. I. Call a marked graph τ a *forest*, if

- (1) $H^1(|\tau|) = 0$,
- (2) $g(v) = 0$, for all $v \in V_\tau$.

Let $\tilde{\mathfrak{F}}_s(A) \subset \tilde{\mathfrak{G}}_s(A)$ be the full subcategory whose objects are forests. Then $\tilde{\mathfrak{F}}_s(A)$ is an admissible subcategory, called the *tree level* subcategory of $\tilde{\mathfrak{G}}_s(A)$.

II. Let $\tilde{\mathfrak{F}}_s(A) \subset \tilde{\mathfrak{G}}_s(A)$ be an admissible subcategory. Let $d : A \rightarrow \mathbb{Z}_{\geq 0}$ be an additive map and $N > 0$ an integer. Then let $\tilde{\mathfrak{F}}_s(A)_{d < N}$ be the full subcategory of $\tilde{\mathfrak{F}}_s(A)$ given by the condition

$$\tau \in \text{ob } \tilde{\mathfrak{F}}_s(A)_{d < N} \iff d(\beta(v)) < N, \text{ for all } v \in V_\tau.$$

The subcategory $\tilde{\mathfrak{F}}_s(A)_{d < N} \subset \tilde{\mathfrak{G}}_s(A)$ is admissible.

If $A = H_2(V)^+$, then a very ample invertible sheaf L on V gives rise to $d : H_2(V)^+ \rightarrow \mathbb{Z}_{\geq 0}$, by setting $d(\beta) = \beta(L)$. If $\text{char } k \neq 0$, we shall always pass to $\tilde{\mathfrak{F}}_s(V)_{d < \text{char } k}$, in other words assume that

$$\tilde{\mathfrak{F}}_s(V) = \tilde{\mathfrak{F}}_s(V)_{d < \text{char } k}.$$

But for emphasis, we may say that $\tilde{\mathfrak{F}}_s(V)$ is *bounded by the characteristic*.

7. ORIENTATIONS

Fix a smooth projective variety V of pure dimension. Recall the following five basic properties of \overline{M} .

Property I (Mapping to a point). Let τ be a stable V -graph of class zero. Then τ is absolutely stable. The evaluation morphism factors through $V^{\pi_0|\tau|} \subset V^{P_\tau}$ and the canonical morphism

$$\overline{M}(V, \tau) \longrightarrow V^{\pi_0|\tau|} \times \overline{M}(\tau)$$

is an isomorphism. This follows immediately from Corollary 2.3. In particular, $\overline{M}(V, \tau)$ is smooth.

Assume that $|\tau|$ is non-empty and connected. Let (C, x) be the universal family of stable marked curves over $\overline{M}(\tau)$. Glue the $(C_v)_{v \in F_\tau}$ according to the edges of τ to obtain a stable marked curve $\pi : \tilde{C} \rightarrow \overline{M}(\tau)$ over $\overline{M}(\tau)$. Denote the vector bundle of rank $g(\tau) \dim V$ on $\overline{M}(V, \tau)$ given by $T_V \boxtimes R^1\pi_* \mathcal{O}_{\tilde{C}}$ by $\mathcal{T}^{(1)}$.

Property II (Products). Let σ and τ be stable V -graphs and $\sigma \times \tau$ the obvious stable V -graph whose geometric realization is the disjoint union of $|\sigma|$ and $|\tau|$. There are obvious combinatorial morphisms $\sigma \rightarrow \sigma \times \tau$ and $\tau \rightarrow \sigma \times \tau$ giving rise

to morphisms of stable V -graphs $\sigma \times \tau \rightarrow \sigma$ and $\sigma \times \tau \rightarrow \tau$ called the *projections*. The induced morphism

$$\overline{M}(V, \sigma \times \tau) \longrightarrow \overline{M}(V, \sigma) \times \overline{M}(V, \tau)$$

is an isomorphism. This follows directly from the definitions.

Property III (Cutting edges). Let $\Phi : \sigma \rightarrow \tau$ be a morphism of stable V -graphs of type cutting an edge. So Φ is induced by a combinatorial morphism $a : \tau \rightarrow \sigma$. Let f and \overline{f} be the tails of τ that come from the edge of σ which is being cut by Φ . So this edge is $\{a(f), a(\overline{f})\}$. The diagram of algebraic k -stacks

$$(6) \quad \begin{array}{ccc} \overline{M}(V, \sigma) & \xrightarrow{\text{ev}_{\{a(f), a(\overline{f})\}}} & V \\ \overline{M}(\Phi) \downarrow & & \downarrow \Delta \\ \overline{M}(V, \tau) & \xrightarrow{\text{ev}_f \times \text{ev}_{\overline{f}}} & V \times V, \end{array}$$

where the horizontal maps are evaluations at the indicated flags, is cartesian. In particular, $\overline{M}(\Phi)$ is a closed immersion. Again, this follows directly from the definitions.

Property IV (Forgetting tails). Let $\Phi : \sigma \rightarrow \tau$ be a morphism of stable V -graphs stably forgetting a tail. Denote the combinatorial morphism giving rise to Φ by $a : \tau \rightarrow \sigma$ and the forgotten tail by $f \in F_\sigma$.

If Φ is of Type I (i.e. incomplete), let $v = \partial_\sigma(f)$. Let $\pi' : C' \rightarrow \overline{M}(V, \sigma)$ be the universal curve indexed by v and $x : \overline{M}(V, \sigma) \rightarrow C'$ the universal section given by f . Let $\pi : C \rightarrow \overline{M}(V, \tau)$ be the universal curve indexed by the unique vertex w of τ such that $a(w) = v$. Then by definition there is a commutative diagram

$$\begin{array}{ccc} C' & \longrightarrow & C \\ \pi' \downarrow & & \downarrow \pi \\ \overline{M}(V, \sigma) & \xrightarrow{\overline{M}(\Phi)} & \overline{M}(V, \tau), \end{array}$$

and the section x induces an $\overline{M}(V, \tau)$ -morphism

$$\overline{M}(V, \sigma) \rightarrow C.$$

This is an isomorphism. In particular, $\overline{M}(\Phi)$ is proper and flat of relative dimension one. This follows from Corollary 4.6.

If $\Phi : \sigma \rightarrow \tau$ removes a tripod, then

$$\overline{M}(\Phi) : \overline{M}(V, \sigma) \rightarrow \overline{M}(V, \tau)$$

is an isomorphism. This is because $\overline{M}(0\text{-tripod}) = \overline{M}_{0,3} = \text{Spec } k$.

Property V (Isogenies). Let

$$(\Phi, \lambda, (\Phi_i)_{i \in I}) : (\tau, (a_i, \tau_i)_{i \in I}) \longrightarrow (\sigma, (b_j, \sigma_j)_{j \in J})$$

be a morphism in $\tilde{\mathfrak{G}}_s(V)_{\text{cart}}$, where Φ (and hence all Φ_i) is an isogeny, i.e. free of any tail gluing factors. For each $j \in J$ we have a commutative diagram

$$\begin{array}{ccc} \prod_{\substack{i \in I \\ \lambda(i)=j}} \overline{M}(V, \tau_i) & \xrightarrow{\Pi \overline{M}(\Phi_i)} & \overline{M}(V, \sigma_j) \\ \Pi \overline{M}(\overline{\alpha}_i) \downarrow & & \downarrow \overline{M}(\overline{b}) \\ \overline{M}(\tau) & \xrightarrow{\overline{M}(\Phi)} & \overline{M}(\sigma). \end{array}$$

This diagram should be considered close to being cartesian. See Definition 7.1 for a more precise statement. For the moment let us note that the induced morphism

$$\prod_{\substack{i \in I \\ \lambda(i)=j}} \overline{M}(V, \tau_i) \longrightarrow \overline{M}(\tau) \times_{\overline{M}(\sigma)} \overline{M}(V, \sigma_j)$$

is surjective.

If X is a separated algebraic Deligne-Mumford stack, by $A_*(X)$ we shall mean the rational Chow group of X (see [15]). If $X \rightarrow Y$ is a morphism of separated algebraic Deligne-Mumford stacks, $A^*(X \rightarrow Y)$ will denote the rational bivariant intersection theory defined in [15].

Definition 7.1. Let $\tilde{\mathfrak{X}}_s(V) \subset \tilde{\mathfrak{G}}_s(V)$ be an admissible subcategory (bounded by the characteristic). Let for each $\tau \in \text{ob } \tilde{\mathfrak{X}}_s(V)$ be given a cycle class

$$J(V, \tau) \in A_{\dim(V, \tau)}(\overline{M}(V, \tau)).$$

This collection of cycle classes is called an *orientation* of \overline{M} over $\tilde{\mathfrak{X}}_s(V)$, if the following axioms are satisfied.

(1) (*Mapping to a point*). We have

$$J(V, \tau) = c_{g(\tau) \dim V}(\mathcal{T}^{(1)}) \cdot [\overline{M}(V, \tau)],$$

for every stable $\tau \in \text{ob } \tilde{\mathfrak{X}}_s(V)$ of class zero such that $|\tau|$ is non-empty and connected.

(2) (*Products*). In the situation of Property II we have

$$J(V, \sigma \times \tau) = J(V, \sigma) \times J(V, \tau).$$

(3) (*Cutting edges*). In the situation of Property III the following is true. Let $[\overline{M}(\Phi)] \in A^{\dim V}(\overline{M}(V, \sigma) \rightarrow \overline{M}(V, \tau))$ be the orientation class of $\overline{M}(\Phi)$ obtained by pullback (using Diagram (6)) from the canonical orientation $[\Delta] \in A^{\dim V}(V \rightarrow V \times V)$. Then we have

$$J(V, \sigma) = [\overline{M}(\Phi)] \cdot J(V, \tau).$$

In other words,

$$J(V, \sigma) = \Delta^! J(V, \tau),$$

where $\Delta^!$ is the Gysin homomorphism given by the complete intersection morphism Δ .

- (4) (*Forgetting tails*). In the situation of Property IV the morphism $\overline{M}(\Phi)$ has a canonical orientation $[\overline{M}(\Phi)] \in A^*(\overline{M}(V, \sigma) \rightarrow \overline{M}(V, \tau))$. We require that

$$J(V, \sigma) = [\overline{M}(\Phi)] \cdot J(V, \tau).$$

In other words,

$$J(V, \sigma) = \overline{M}(\Phi)^* J(V, \tau),$$

where $\overline{M}(\Phi)^*$ is given by flat pullback.

- (5) (*Isogenies*). In the situation of Property V, we have for every $j \in J$ a class

$$\overline{M}(\Phi)^! J(V, \sigma_j) \in A_{\dim(V, \sigma_j)}(\overline{M}(\tau) \times_{\overline{M}(\sigma)} \overline{M}(V, \sigma_j)),$$

since $\overline{M}(\Phi)$ has a canonical orientation, $\overline{M}(\tau)$ and $\overline{M}(\sigma)$ being smooth of pure dimension. We also have a morphism

$$h : \prod_{\lambda(i)=j} \overline{M}(V, \tau_i) \longrightarrow \overline{M}(\tau) \times_{\overline{M}(\sigma)} \overline{M}(V, \sigma_j),$$

which is proper. The requirement is that

$$h_* \left(\sum_{\lambda(i)=j} J(V, \tau_i) \right) = \overline{M}(\Phi)^! J(V, \tau).$$

Remark 7.2. To check Axiom (5), it suffices to do so for Φ an elementary isogeny, $\#J = 1$ and $(a_i, \tau_i, \Phi_i)_{i \in I}$ a pullback. This follows from the projection formula.

Example. If τ is a stable V -graph such that $|\tau|$ is non-empty and connected, define

$$J_0(V, \tau) = \begin{cases} c_{g(\tau) \dim V}(\mathcal{T}^{(1)}) \cdot [\overline{M}(V, \tau)] & \text{if } \beta(\tau) = 0, \\ 0 & \text{otherwise.} \end{cases}$$

For an arbitrary stable V -graph τ , let $\tau = \tau_1 \times \dots \times \tau_n$, for stable V -graphs τ_1, \dots, τ_n , such that $|\tau| = |\tau_1| \amalg \dots \amalg |\tau_n|$ is the decomposition of $|\tau|$ into connected components. Then set

$$J_0(V, \tau) = J_0(V, \tau_1) \times \dots \times J_0(V, \tau_n).$$

We claim that J_0 is an orientation of \overline{M} over $\tilde{\mathfrak{G}}_s(V)$, called the *trivial orientation*.

Definition 7.3. Call a smooth projective variety V *convex*, if for every morphism $f : \mathbb{P}^1 \rightarrow V$ (defined over an extension K of k) we have $H^1(\mathbb{P}^1, f^*T_V) = 0$.

Proposition 7.4. *Let V be convex and τ a stable V -forest. Then $\overline{M}(V, \tau)$ is smooth of dimension $\dim(V, \tau)$. Moreover, the morphism*

$$\overline{M}(V, \tau) \longrightarrow \overline{M}(\tau^s)$$

is flat of relative dimension $\chi(\tau^s) \dim V - \deg(V, \tau)$.

Proof. Let us start with some general remarks. Let τ be an absolutely stable V -graph. Then we define

$$U(V, \tau) \subset \overline{M}(V, \tau)$$

to be the open substack of those stable maps (C, x, f) , such that $(C_v, (x_i)_{i \in F_\tau(v)})$ is a stable marked curve, for all $v \in V_\tau$. Let $(C, x) : T \rightarrow \overline{M}(\tau)$ be a T -valued point of $\overline{M}(\tau)$, i.e. $(C_v, (x_i)_{i \in F_\tau(v)})_{v \in V_\tau}$ is a family of stable marked curves parametrized by T . Let (\tilde{C}, \tilde{x}) be the stable marked curve over T obtained by gluing the C_v according to the edges of τ . The diagram

$$\begin{array}{ccc} \text{Mor}_T(\tilde{C}, V_T) & \longrightarrow & T \\ \downarrow & & \downarrow \\ U(V, \tau) & \longrightarrow & \overline{M}(\tau) \end{array}$$

is cartesian. In particular, by Grothendieck [3], the morphism $U(V, \tau) \rightarrow \overline{M}(\tau)$ is representable, separated and of finite type. Moreover, let (C, x, f) be a K -valued point of $U(V, \tau)$. Let (\tilde{C}, \tilde{x}) be the marked curve obtained by gluing the C_v and $\tilde{f} : \tilde{C} \rightarrow V$ the morphism induced by the f_v . If $H^1(\tilde{C}, \tilde{f}^*T_V) = 0$, then (C, x, f) is a smooth point of $U(V, \tau) \rightarrow \overline{M}(\tau)$ and we have

$$T_{U(V, \tau)/\overline{M}(\tau)}(C, x, f) = H^0(\tilde{C}, \tilde{f}^*T_V)$$

for the relative tangent space. (This is the case, if τ is a V -forest and V is convex.)

In this smooth case we may calculate the relative dimension of $U(V, \tau)$ over $\overline{M}(\tau)$ at (C, x, f) as

$$\begin{aligned} \dim_K H^0(\tilde{C}, \tilde{f}^*T_V) &= \chi(\tilde{f}^*T_V) \\ &= \deg \tilde{f}^*T_V + \text{rk}(\tilde{f}^*T_V)\chi(\tilde{C}) \\ &= -\beta(\tau)(\omega_V) + \dim V\chi(\tau) \\ &= \dim(V, \tau) - \dim(\tau). \end{aligned}$$

Since $\overline{M}(\tau)$ is smooth of dimension $\dim(\tau)$, we get that $U(V, \tau)$ is smooth of dimension $\dim(V, \tau)$ at (C, x, f) .

Now let τ be an arbitrary stable V -graph. Then there exists an absolutely stable V -graph τ' , together with a morphism $\tau' \rightarrow \tau$ of type forgetting tails, such that the morphism

$$U(V, \tau') \longrightarrow \overline{M}(V, \tau)$$

is surjective, hence a flat epimorphism of relative dimension $\#S_{\tau'} - \#S_\tau$. So if $U(V, \tau')$ is smooth of dimension $\dim(V, \tau')$, then $\overline{M}(V, \tau)$ is smooth of dimension

$$\dim(V, \tau') - \#S_{\tau'} + \#S_\tau = \dim(V, \tau).$$

Finally, by considering the commutative diagram

$$\begin{array}{ccc} U(V, \tau') & \longrightarrow & \overline{M}(V, \tau) \\ \downarrow & & \downarrow \\ \overline{M}(\tau') & \longrightarrow & \overline{M}(\tau^s), \end{array}$$

we see that in this case $\overline{M}(V, \tau) \rightarrow \overline{M}(\tau^s)$ is flat of relative dimension $\chi(\tau^s) \dim V - \deg(V, \tau)$. \square

Theorem 7.5. *Let V be a convex variety and $\tilde{\mathfrak{X}}_s(V) \subset \tilde{\mathfrak{G}}_s(V)$ the admissible subcategory of V -forests bounded by the characteristic. Then the collection*

$$J(V, \tau) = [\overline{M}(V, \tau)]$$

is an orientation of \overline{M} over $\tilde{\mathfrak{X}}_s(V)$.

Proof. Let us check the axioms.

(1) *Mapping to a point.* This follows from the fact that $g(\tau) = 0$ and hence

$$c_{g(\tau) \dim V}(\mathcal{T}^{(1)}) = c_0(0) = 1.$$

(2) *Products.* In complete generality we have for smooth proper Deligne-Mumford stacks X and Y that

$$[X \times Y] = [X] \times [Y]$$

in $A_*(X \times Y)$.

(3) *Cutting edges.* Again we have a general fact to the following effect. Consider the cartesian diagram of separated Deligne-Mumford stacks

$$\begin{array}{ccc} X & \xrightarrow{f} & V \\ j \downarrow & & \downarrow i \\ Y & \longrightarrow & W, \end{array}$$

where i and j are regular embeddings such that for the normal bundles we have

$$f^* N_{V/W} = N_{X/Y}.$$

Then $i^! [Y] = [X]$. If all four participating stacks are smooth and i and j are closed immersions of the same codimension, then these conditions are automatically satisfied (see for example Proposition 17.13.2 in [5]). Thus we may apply this fact in our case.

More generally, we have that $i^! [Y] = [X]$ if all participating stacks are smooth and

$$\dim X + \dim W = \dim Y + \dim V.$$

(4) *Forgetting tails.* Again, there is a general fact that $f^! [Y] = [X]$ if $f : X \rightarrow Y$ is a flat morphism of smooth and proper Deligne-Mumford stacks.

(5) *Isogenies.* In accordance with Remark 7.2 we assume that Φ is an elementary isogeny, $\#J = 1$ and that $(a_i, \tau_i, \Phi_i)_{i \in I}$ is a pullback. There are five cases to consider, according to what type of elementary isogeny Φ is. We use notation as in the definition of pullback.

Case I (Contracting a loop). This case does not occur, since σ and τ are forests.

Case II (Contracting an edge). We will start with some general remarks. Let τ be a stable V -graph, and v_1, \dots, v_n absolutely stable vertices of τ , i.e. vertices v such that $2g(v) + |v| \geq 3$. (To avoid ill-defined notation we assume that $n \geq 1$.) Let

$$U_{v_1, \dots, v_n}(V, \tau) \subset \overline{M}(V, \tau)$$

be the open substack of all those stable maps $(C, x, f) \in \overline{M}(V, \tau)$ such that

$$(C_{v_\nu}, (x_i)_{i \in F_\tau(v_\nu)})$$

is a stable marked curve, for all $\nu = 1, \dots, n$.

With this notation the diagram

$$\begin{array}{ccc} \prod_{i \in I} U_{a_i(v_1), a_i(v_2)}(V, \tau_i) & \longrightarrow & U_{b(v_0)}(V, \sigma') \\ \downarrow & & \downarrow \\ \overline{M}(\tau) & \longrightarrow & \overline{M}(\sigma) \end{array}$$

is cartesian. Consider for a fixed $i \in I$ the open immersion

$$U_{a_i(v_1), a_i(v_2)}(V, \tau_i) \subset \overline{M}(V, \tau_i).$$

Let

$$Z_{a_i(v_1), a_i(v_2)}(V, \tau_i) \subset \overline{M}(V, \tau_i)$$

be the closed complement. We have

$$\dim Z_{a_i(v_1), a_i(v_2)}(V, \tau_i) < \dim \overline{M}(V, \tau_i).$$

Thus, to prove the equality of two cycles of degree $\dim(V, \tau_i)$ in $\overline{M}(\tau) \times_{\overline{M}(\sigma)} \overline{M}(V, \sigma')$, it suffices to prove the equality of the cycles restricted to $\prod_i U_{a_i(v_1), a_i(v_2)}(V, \tau_i)$. This reduces us to proving that

$$\overline{M}(\Phi)^! [U_{b(v_0)}(V, \sigma')] = \sum_i [U_{a_i(v_1), a_i(v_2)}(V, \tau_i)].$$

This claim finally follows from the general fact already mentioned in the proof of Axiom (3).

Case III (Forgetting a tail, incompletely). Let $f \in F_\tau$ be the forgotten flag, $v = \partial_{\tau_0}(a_0(f))$ and $w \in V_{\sigma'}$ the vertex of σ' corresponding to v via Φ_0 . We have an open immersion

$$U_v(V, \tau_0) \subset \overline{M}(V, \tau_0)$$

with closed complement

$$Z_v(V, \tau_0) \subset \overline{M}(V, \tau_0)$$

of strictly smaller dimension. Thus, as in the previous case, we may reduce to proving that

$$\overline{M}(\Phi)^! [U_w(V, \sigma')] = [U_v(V, \tau_0)].$$

This follows from the fact that the diagram

$$\begin{array}{ccc} U_v(V, \tau_0) & \longrightarrow & U_w(V, \sigma') \\ \downarrow & & \downarrow \\ \overline{M}(\tau) & \xrightarrow{\overline{M}(\Phi)} & \overline{M}(\sigma) \end{array}$$

is cartesian.

Cases IV and V (Removing a tripod). These cases are trivial, since $\overline{M}(\Phi_0)$ and $\overline{M}(\Phi)$ are isomorphisms. \square

8. DELIGNE-MUMFORD-CHOW MOTIVES

We shall imitate the usual construction of the category of Chow motives, as described for example in [14].

Fix a ground field k . Let \mathfrak{W} be the category of smooth and proper algebraic Deligne-Mumford stacks over k . For an object X of \mathfrak{W} , let $A^*(X)$ be the rational Chow ring of X defined by Vistoli [15]. Then A^* is a generalized cohomology theory with coefficient field \mathbb{Q} in the sense of [8]. Moreover, it is a graded global intersection theory with Poincaré duality and cycle map in the terminology of [8].

If X and Y are objects of \mathfrak{W} we define $S^d(Y, X)$, the group of *correspondences* from Y to X of degree d , to be

$$S^d(Y, X) = A^{n+d}(Y \times X),$$

if Y is purely n -dimensional and

$$S^d(Y, X) = \bigoplus_i S^d(Y_i, X),$$

if $Y = \coprod_i Y_i$ is the decomposition of Y into irreducible components. Note that $S^d(Y, X) \subset A^*(Y \times X)$. The isomorphism $Y \times X \cong X \times Y$ exchanging components induces an isomorphism

$$S^d(Y, X) \cong S^{d+n-m}(X, Y),$$

if $\dim Y = n$ and $\dim X = m$. We call this isomorphism *transpose* of correspondences. For objects Z, Y and X of \mathfrak{W} we define composition of correspondences by the usual formula

$$g \circ f = p_{13*}(p_{12}^* f \cdot p_{23}^* g),$$

for $f \in S^d(Z, Y)$ and $g \in S^e(Y, X)$. Then $g \circ f \in S^{d+e}(Z, X)$.

The category $\overline{\mathfrak{W}}$ of *Deligne-Mumford-Chow motives* (or DMC-motives) is now defined to be the category of triples (X, p, n) , where $X \in \text{ob } \mathfrak{W}$, $p \in S^0(X, X)$ such that $p^2 = p$ and $n \in \mathbb{Z}$. Homomorphisms are defined by

$$\text{Hom}_{\overline{\mathfrak{W}}}((Y, q, m), (X, p, n)) = pS^{n-m}(Y, X)q.$$

Note that $\text{Hom}_{\overline{\mathfrak{W}}}((Y, q, m), (X, p, n)) \subset S^{n-m}(Y, X)$. Composition of homomorphisms in $\overline{\mathfrak{W}}$ is defined as composition of correspondences.

There is a contravariant involution $\overline{\mathfrak{M}} \rightarrow \overline{\mathfrak{M}}$, denoted $M \mapsto M^\vee$, defined by $(X, p, n)^\vee = (X, {}^t p, \dim X - n)$, where ${}^t p$ is the transpose of p , on objects and by transpose of correspondences on homomorphisms.

Proposition 8.1. *The category $\overline{\mathfrak{M}}$ is a \mathbb{Q} -linear pseudo-abelian category. \square*

Every morphism $f : X \rightarrow Y$ in \mathfrak{M} defines a correspondence of degree zero $\overline{f} \in S^0(Y, X)$ by

$$\overline{f} = \Gamma_{f_*}[X] \in A^*(Y \times X),$$

where $\Gamma_f : X \rightarrow Y \times X$ is the graph of f . We define the contravariant functor $h : \mathfrak{M} \rightarrow \overline{\mathfrak{M}}$ by $h(X) = (X, \overline{\text{id}}_X, 0)$ and $h(f) = \overline{f}$. We usually write f^* for $h(f)$ and f_* for $h(f)^\vee$.

Let $\mathbb{L} = (\text{Spec } k, \overline{\text{id}}, -1)$ be the *Lefschetz motive*. We shall use the notation

$$M(n) = M \otimes \mathbb{L}^{-n}.$$

We set

$$\text{Hom}_{\overline{\mathfrak{M}}}^i(M, N) = \text{Hom}_{\overline{\mathfrak{M}}}(M \otimes \mathbb{L}^i, N)$$

and

$$\text{Hom}_{\overline{\mathfrak{M}}}^*(M, N) = \bigoplus_{i \in \mathbb{Z}} \text{Hom}_{\overline{\mathfrak{M}}}^i(M, N).$$

The category with the same objects as $\overline{\mathfrak{M}}$, but with homomorphism groups given by $\text{Hom}_{\overline{\mathfrak{M}}}^*(M, N)$ will be called the category of *graded DMC-motives*.

For a DMC-motive M , define

$$A^i(M) = \text{Hom}(\mathbb{L}^i, M)$$

and

$$A^*(M) = \bigoplus_i A^i(M).$$

Proposition 8.2 (Identity principle). *If $f, g : M \rightarrow N$ are two homomorphisms of DMC-motives, such that the induced homomorphisms*

$$A^*(M \otimes h(X)) \longrightarrow A^*(N \otimes h(X))$$

agree, for all $X \in \text{ob } \mathfrak{M}$, then $f = g$. \square

Let $\overline{\mathfrak{V}}$ be the category of Chow motives (which is defined as $\overline{\mathfrak{M}}$ is above, but starting with \mathfrak{V} instead of \mathfrak{M}). There is a natural fully faithful functor $\overline{\mathfrak{V}} \rightarrow \overline{\mathfrak{M}}$.

Question 8.3. *Is the functor $\overline{\mathfrak{V}} \rightarrow \overline{\mathfrak{M}}$ an equivalence of categories?*

Let H be a graded generalized cohomology theory on \mathfrak{M} with a coefficient field Λ of characteristic zero, possessing a cycle map such that \mathbb{P}^1 satisfies epu (see [8]). Then H induces a covariant functor (called a *realization functor*)

$$\overline{H} : (\text{graded DMC-motives}) \longrightarrow (\text{graded } \Lambda\text{-algebras}),$$

such that for $X \in \text{ob } \mathfrak{W}$ we have $\overline{H}(h(X)) = H(X)$ and for a correspondence $\xi \in S^d(Y, X)$ we have an induced homomorphism

$$\begin{aligned} \overline{H}(\xi) : H(Y) &\longrightarrow H(X) \\ \alpha &\longmapsto p_{X*}(p_Y^*(\alpha) \cup \text{cl}_{Y \times X}(\xi)). \end{aligned}$$

The functor \overline{H} doubles the degree of a homomorphism.

The following are examples of such a cohomology theory H .

- (1) If $k = \mathbb{C}$, consider to X the associated topological stack X^{top} . This is a stack on the category of topological spaces with the étale topology. It has an associated étale topos $X_{\text{ét}}^{\text{top}}$. Set

$$H_B(X) = H^*(X_{\text{ét}}^{\text{top}}, \mathbb{Q})$$

and call it the *Betti cohomology* of X . Here $\Lambda = \mathbb{Q}$.

- (2) If $\ell \neq \text{char } k$ set

$$H_\ell(X) = H^*(\overline{X}_{\text{ét}}, \mathbb{Q}_\ell) = \varprojlim_n H^*(\overline{X}_{\text{ét}}, \mathbb{Z}/\ell^n),$$

where $\overline{X} = X \times_{\text{Spec } k} \text{Spec } \overline{k}$ is the lift of X to an algebraic closure of k and $\overline{X}_{\text{ét}}$ denotes the étale topos of \overline{X} . We call $H_\ell(X)$ the ℓ -*adic cohomology* of X . In this case $\Lambda = \mathbb{Q}_\ell$.

- (3) If $\text{char } k = 0$, let Ω_X^\bullet be the algebraic deRham complex of X and set

$$H_{dR}(X) = \mathbb{H}^*(X, \Omega_X^\bullet).$$

We call $H_{dR}(X)$ the *algebraic deRham cohomology* of X . Here $\Lambda = k$.

9. MOTIVIC GROMOV-WITTEN CLASSES

Define the contravariant tensor functor

$$h(\overline{M}) : \tilde{\mathfrak{G}}_s(0) \longrightarrow (\text{DMC-motives})$$

by $h(\overline{M})(\tau) = h(\overline{M}(\tau))$ on objects. For a morphism $(a, \sigma', \Phi) : \sigma \rightarrow \tau$ we have $\overline{M}(\overline{a}) : \overline{M}(\sigma') \rightarrow \overline{M}(\sigma)$ and $\overline{M}(\Phi) : \overline{M}(\sigma') \rightarrow \overline{M}(\tau)$. Then let

$$h(\overline{M})(a, \sigma', \Phi) = \overline{M}(\overline{a})_* \circ \overline{M}(\Phi)^*.$$

This makes sense, because $\overline{M}(\overline{a})_*$ is of degree zero, $\overline{M}(\overline{a})$ being an isomorphism. This is also why $h(\overline{M})$ is functorial.

Now fix a smooth projective variety V of pure dimension and consider the contravariant tensor functor

$$h(V)^{\otimes S}(\chi \dim V) : \tilde{\mathfrak{G}}_s(0) \longrightarrow (\text{DMC-motives})$$

defined on objects by

$$\tau \longmapsto h(V)^{\otimes S_\tau}(\chi(\tau) \dim V).$$

For a morphism $(a, \sigma', \Phi) : \sigma \rightarrow \tau$ let E be the set of edges of σ' which are cut by $a : \sigma \rightarrow \sigma'$. Then we have $V^{S_\sigma} = V^{S_{\sigma'}} \times (V \times V)^E$. Let $p : V^{S_{\sigma'}} \times V^E \rightarrow V^{S_{\sigma'}}$ be the projection, $\Delta : V^{S_{\sigma'}} \times V^E \rightarrow V^{S_{\sigma'}} \times (V \times V)^E = V^{S_\sigma}$ the identity times the

E -fold power of the diagonal. Finally, we have an injection $\Phi^S : S_\tau \rightarrow S_{\sigma'}$ giving rise to $\Phi^S : V^{S_{\sigma'}} \rightarrow V^{S_\tau}$. We define the homomorphism

$$h(V)^{\otimes S_\tau}(\chi(\tau) \dim V) \longrightarrow h(V)^{\otimes S_{\sigma'}}(\chi(\sigma') \dim V)$$

as the composition of the three homomorphisms

$$\begin{aligned} (\Phi^S)^* &: h(V)^{\otimes S_\tau}(\chi(\tau) \dim V) \longrightarrow h(V)^{\otimes S_{\sigma'}}(\chi(\sigma') \dim V), \\ p^* &: h(V)^{\otimes S_{\sigma'}}(\chi(\sigma') \dim V) \longrightarrow h(V)^{\otimes S_{\sigma' \cup E}}(\chi(\sigma') \dim V) \end{aligned}$$

and

$$\Delta_* : h(V)^{\otimes S_{\sigma' \cup E}}(\chi(\sigma') \dim V) \longrightarrow h(V)^{\otimes S_\sigma}(\chi(\sigma) \dim V),$$

noting that $\chi(\tau) = \chi(\sigma')$ and $\chi(\sigma') = \chi(\sigma) - \#E$. Functoriality is a straightforward check using the identity principle.

Pulling back $h(\overline{M})$ and $h(V)^{\otimes S}(\chi \dim V)$ to the cartesian extended isogeny category over V via the functor of Remark 6.11, we get two contravariant tensor functors

$$\tilde{\mathfrak{G}}_s(V)_{\text{cart}} \longrightarrow (\text{graded DMC-motives}).$$

Now let $\tilde{\mathfrak{X}}_s(V) \subset \tilde{\mathfrak{G}}_s(V)$ be an admissible subcategory (bounded by the characteristic) and J an orientation of \overline{M} over $\tilde{\mathfrak{X}}_s(V)$. For every object τ of $\tilde{\mathfrak{X}}_s(V)$ we have a morphism

$$\phi_{(V,\tau)} : \overline{M}(V, \tau) \longrightarrow V^{S_{\tau^s}} \times \overline{M}(\tau^s).$$

The first component is given by evaluation, noting that we have a map $F_{\tau^s} \rightarrow F_\tau$. Then

$$\begin{aligned} \phi_{(V,\tau)_*} J(V, \tau) &\in \mathcal{S}^{\dim(\tau^s) - \dim(V,\tau)}(V^{S_{\tau^s}}, \overline{M}(\tau^s)) \\ &= \text{Hom}_{\frac{\text{deg}(V,\tau)}{\mathbb{M}}}^{\text{deg}(V,\tau)}(h(V^{S_{\tau^s}})(\chi(\tau^s) \dim V), h(\overline{M}(\tau^s))). \end{aligned}$$

Definition 9.1. Define

$$I(V, \tau) = \phi_{(V,\tau)_*} J(V, \tau),$$

so that we have a homomorphism

$$I(V, \tau) : h(V)^{\otimes S_{\tau^s}}(\chi(\tau^s) \dim V) \longrightarrow h(\overline{M}(\tau^s))(\text{deg}(V, \tau))$$

of DMC-motives over k . We call I the system of *Gromov-Witten classes* associated to the orientation J .

Restricting the two functors $h(\overline{M})$ and $h(V)^{\otimes S}(\chi \dim V)$ to $\tilde{\mathfrak{X}}_s(V)_{\text{cart}}$, we get two contravariant tensor functors

$$\tilde{\mathfrak{X}}_s(V)_{\text{cart}} \longrightarrow (\text{graded DMC-motives}).$$

We shall now define a natural transformation

$$I : h(V)^{\otimes S}(\chi \dim V) \longrightarrow h(\overline{M}).$$

So let $(\tau, (\tau_i)_{i \in I})$ be an object of $\tilde{\mathfrak{X}}_s(V)_{\text{cart}}$, and define

$$I(\tau, (\tau_i)_{i \in I}) = \sum_{i \in I} I(V, \tau_i) : h(V)^{\otimes S_\tau}(\chi(\tau) \dim V) \longrightarrow h(\overline{M}(\tau)).$$

Theorem 9.2. *The Gromov-Witten transformation I is a natural transformation compatible with the \oplus , \otimes and \deg structures. Moreover,*

- (1) (Mapping to a point). *The triangle*

$$\begin{array}{ccc} h(V)^{\otimes S_\tau}(\chi(\tau) \dim V) & \xrightarrow{\text{mult}} & h(V)(\chi(\tau) \dim V) \\ & \searrow^{I(V,\tau)} & \downarrow c_{g(\tau) \dim V}(\mathcal{T}^{(1)}) \\ & & h(\overline{M}(\tau)) \end{array}$$

commutes, for any stable V -graph τ of class zero in $\widetilde{\mathfrak{T}}_s(V)$, such that $|\tau|$ is non-empty and connected.

- (2) (Divisor). *Let $\mathcal{L} \in \text{Pic}(V)$ be a line bundle, so its Chern class induces a homomorphism $c_1(\mathcal{L}) : \mathbb{L} \rightarrow h(V)$. Let $\Phi : \sigma \rightarrow \tau$ be a morphism in $\widetilde{\mathfrak{T}}_s(V)$ of type forgetting a tail, such that the corresponding vertex of τ is absolutely stable. Then the square*

$$\begin{array}{ccc} h(V)^{\otimes S_{\sigma^s}}(\chi(\sigma^s) \dim V) & \xrightarrow{I(V,\sigma)} & h(\overline{M}(\sigma^s))(\deg(V, \sigma)) \\ c_1(\mathcal{L}) \uparrow & & \downarrow \overline{M}(\Phi)_* \\ h(V)^{\otimes S_{\tau^s}}(\chi(\tau^s) \dim V) \otimes \mathbb{L} & \xrightarrow{\beta(\mathcal{L})I(V,\tau)} & h(\overline{M}(\tau^s))(\deg(V, \tau)) \otimes \mathbb{L} \end{array}$$

commutes.

Remark. To make this statement more precise, consider to (graded DMC-motives) the associated category of morphisms. Then the natural transformation I may be considered as a functor

$$I : \widetilde{\mathfrak{T}}_s(V)_{\text{cart}} \longrightarrow (\text{graded morphisms of DMC-motives}).$$

Both categories have \oplus , \otimes and \deg structures and I preserves them. This essentially means that

- (1) $I((\tau_i) \oplus (\sigma_j)) = I((\tau_i)) + I((\sigma_j))$,
- (2) $\deg I((\tau_i)) = \deg(\tau_i)$, if (τ_i) is homogeneous,
- (3) $I((\tau, \tau_i) \otimes (\sigma, \sigma_j)) = I(\tau, \tau_i) \otimes I(\sigma, \sigma_j)$.

Proof. All this follows formally from Definition 7.1 using the identity principle and the bivariant formalism (as explained for example in [2]). \square

Remarks. (1) Applying Theorem 7.5 we get the tree level system of Gromov-Witten invariants for convex varieties.

- (2) By applying a realization functor, we get Betti, ℓ -adic or deRham Gromov-Witten classes.

- (3) Theorem 9.2 implies all the axioms for Gromov-Witten classes listed in [11]. Perhaps only Formula (2.7) is not quite evident. In view of its importance (it implies that the fundamental class remains the identity with respect to quantum multiplication), we will show that it follows from the rest of the axioms. In fact, assume that

$$(7) \quad \langle I_{0,3,\beta} \rangle(\gamma_1 \otimes \gamma_2 \otimes e^0) \neq 0.$$

Choose a divisorial class δ with nonvanishing intersection with β . In view of the Divisor Axiom, we must then have

$$\langle I_{0,4,\beta} \rangle (\gamma_1 \otimes \gamma_2 \otimes \delta \otimes e^0) \neq 0.$$

In view of (2.6), the last class is the lift of

$$\langle I_{0,3,\beta} \rangle (\gamma_1 \otimes \gamma_2 \otimes \delta).$$

But this cannot be non-vanishing simultaneously with (7) because the Grading Axiom does not allow this.

More generally, this argument shows that whenever e^0 is among the arguments, then $\langle I \rangle = 0$ for $\beta \neq 0$, any genus, any n . Geometrically: ‘if one of the points on C is unconstrained, the problem cannot have finitely many (and non-zero) solutions.’

REFERENCES

1. P. Deligne and J. Milne. Tannakian categories. In *Hodge Cycles, Motives and Shimura Varieties*, Lecture Notes in Mathematics Vol. 900, pages 101–228. Springer, Berlin, Heidelberg, New York, 1982.
2. W. Fulton and R. MacPherson. *Categorical framework for the study of singular spaces*. Memoirs of the American Mathematical Society No. 243. American Mathematical Society, Providence, 1981.
3. A. Grothendieck. Techniques de construction et théorèmes d’existence en géométrie algébrique IV: Les schémas de Hilbert. *Séminaire Bourbaki*, 13e année(221), 1960–61.
4. A. Grothendieck. *Elements de Géométrie Algébrique II: Etude globale élémentaire de quelques classes de morphismes*, **EGA2**. Publications Mathématiques No. 8. Institut des Hautes Études Scientifiques, Bois-Marie Bures-sur-Yvette, 1961.
5. A. Grothendieck. *Elements de Géométrie Algébrique IV: Etude Locale des Schémas et des Morphismes de Schémas*, **EGA4**. Publications Mathématiques Nos. 20, 24, 28, 32. Institut des Hautes Études Scientifiques, Bois-Marie Bures-sur-Yvette, 1964, 65, 66, 67.
6. A. Grothendieck et al. *Revêtements Étales et Groupe Fondamental* **SGA1**. Lecture Notes in Mathematics No. 224. Springer, Berlin, Heidelberg, New York, 1971.
7. M. Kapranov and Yu. Manin. Paper in preparation.
8. S. Kleiman. Motives. In F. Oort, editor, *Algebraic Geometry, Oslo 1970*, pages 53–96. Wolters-Noordhoff, 1972.
9. F. Knudsen. The projectivity of the moduli space of stable curves, II: The stacks $M_{g,n}$. *Math. Scand.*, 52:161–199, 1983.
10. M. Kontsevich. Enumeration of rational curves via torus actions. Preprint, Max-Planck-Institut für Mathematik, Bonn, 1994.
11. M. Kontsevich and Yu. Manin. Gromov-Witten classes, quantum cohomology, and enumerative geometry. *Communications in Mathematical Physics*, 164:525–562, 1994.
12. M. Kontsevich and Yu. Manin. Quantum cohomology of a product. Preprint, Max-Planck-Institut für Mathematik, Bonn, 1995.
13. R. Pandharipande. Notes on Kontsevich’s compactification of the space of maps. Preprint, preliminary version, March 7, 1995.

14. A. J. Scholl. Classical motives. In *Motives*, Proceedings of Symposia in Pure Mathematics Vol. 55, Part I, pages 163–187. American Mathematical Society, Providence, 1994.
15. A. Vistoli. Intersection theory on algebraic stacks and on their moduli spaces. *Inventiones mathematicae*, 97:613–670, 1989.

UNIVERSITY OF BRITISH COLUMBIA, MATHEMATICS DEPARTMENT, 121–1984 MATHEMATICS ROAD, VANCOUVER, B.C. CANADA V6T 1Z2
E-mail address: behrend@math.ubc.ca

MAX-PLANCK-INSTITUT FÜR MATHEMATIK, GOTTFRIED-CLAREN-STR. 26, D–53225 BONN
E-mail address: manin@mpim-bonn.mpg.de