

## Spectral Geometry and Bosonic–Bloch Probes: Explorations in Quantum Learning

Santanu Ganguly<sup>†</sup>, Xing Liang<sup>\*</sup> and Dimitrios Makris

*Quantum AI Research Group,*

*School of Computer Science and Mathematics,*

*Kingston University London,*

*Penrhyn Road, Kingston upon Thames, KT1 2EE, United Kingdom*

<sup>†</sup>*e-mail address:* [ganguly.santanu@kingston.ac.uk](mailto:ganguly.santanu@kingston.ac.uk)

<sup>\*</sup>*e-mail address:* [x.liang@kingston.ac.uk](mailto:x.liang@kingston.ac.uk)

This paper investigates how spectral geometry emerges in quantum learning models and how it can be diagnosed through physically grounded probes. In graph-regularized quantum networks, training reorganizes the output similarity graph, increasing its effective spectral dimension ( $\Delta S = +0.23$ ) and reshaping the Laplacian spectrum. Edge-resolved two-boson interference provides a direct probe of this restructuring: the bosonic enhancement  $\Delta P_{uv}$  correlates with the Fiedler edge split  $|\Delta v_2|(r = -0.50)$ , establishing a quantitative link between learned spectral partitions and interference signatures. A phase diagram reveals a non-monotonic dependence of performance on coupling strength  $\gamma$  and noise  $\delta$ , with graph regularization improving fidelity only within a restricted regime; hardware experiments confirm the predicted interference behavior within shot-noise uncertainty. *In a complementary setting*, we analyze a hybrid quantum autoencoder and introduce Bloch-space drift as a geometric diagnostic of its latent representation. Using an unsupervised threshold derived from benign data, the model achieves high ranking performance (ROC–AUC  $\approx 0.99$ ) with negligible false-negative rates. Absolute Bloch drift yields strong discrimination (ROC–AUC  $\gtrsim 0.9$ ), whereas consecutive drift produces near-random classification (ROC–AUC  $\approx 0.5$ ), indicating that detection arises from persistent state-space displacement rather than local fluctuations. Interpreted through the geometry of reduced single-qubit states and their associated quantum Fisher information, these results demonstrate that learning-induced spectral organization manifests as measurable structure in quantum state space. Together, these findings establish a unified spectral–geometric framework for diagnosing quantum learning systems using bosonic and Bloch probes.

**Keywords:** graph neural networks, boson sampling, quantum autoencoder, Bloch drift, security, spectral geometry, quantum learning.

### I. INTRODUCTION

A quantum network connected via suitable nodes can be represented by graphs and be used to implement quantum computations, quantum-to-classical interfaces for measurements, quantum-to-quantum interfaces for different quantum physical systems, and quantum sensors [1, 2], just to name a few. The cost vectors associated with links could include measures that are uniquely quantum, such as fidelity, purity or entanglement measures, none of which are applicable to classical digital data [3]. In the quantum context costs is defined and optimised (minimised) via an entirely different approach leveraging in quantum machine learning (QML) fundamentals owing to the quantum nature of the information being handled [2, 4]. Graph-structured data is one of the commonest in the field of quantum networking and data communication [2, 5, 8, 15, 21]. Graphs consist of sets that are in some way connected or related

objects [2, 3]. We develop a hybrid quantum–classical framework in which bosonic sampling [8, 28] devices generate nonclassical graph features that are processed by a graph neural network for scalable inference. Rather than treating boson sampling as a complexity-theoretic primitive, we use multiphoton interference [5, 43, 55, 93] as a physically grounded probe of relational structure. In addition, we show that the geometry and stability of learned quantum representations are central to performance, demonstrated through the analysis of denial-of-service (DoS) attack data [98, 99] using Bloch-space drift as a diagnostic of the latent quantum layer. These results highlight spectral geometry and physically interpretable probes as key tools for assessing hybrid quantum learning systems.

#### A. Spectral structure in graph learning

Learning over structured data is fundamentally geometric [12, 18]. In graph-based models, relational

inductive biases govern information propagation and representation organization [7, 57]. Spectral graph theory [19, 21, 52] provides a natural language for this structure: the Laplacian eigenvalues and eigenvectors encode connectivity, mixing, and partitioning, with algebraic connectivity and the Fiedler vector [24] characterizing global coherence and principal graph cuts [11, 13, 19, 24, 52]. In classical machine learning, this spectral viewpoint underlies graph convolutional networks and message-passing architectures [15, 21, 67], where propagation can be interpreted as filtering in the Laplacian eigenbasis [7, 10, 12]. Graph neural networks (GNNs) formalize this paradigm through permutation invariance and local aggregation rules [24, 50, 52, 59].

### B. Bosonic probes as structural diagnostics

Multiphoton interference in linear optical systems – originally studied in boson sampling [5, 28, 55, 93] – is highly sensitive to global unitary structure. Recent work has explored photonic protocols such as Gaussian boson sampling for graph-aware feature generation and combinatorial tasks [8, 28, 43]. These developments suggest that interference can serve not only as a computational primitive but also as a diagnostic of structural organization [108-111]. Here we adopt the same general philosophy without making a complexity-theoretic claim: *bosonic interference* is used as a *physically grounded probe of learned structure*. *Edge-resolved two-boson enhancement* provides a *local observable* whose heterogeneity mirrors the partitions and mode structure extracted from the Laplacian spectrum. In this way, global spectral organization and local interference signatures become two views of the same learned geometry. We demonstrate that training modifies spectral entropy and effective spectral dimension, and that the bosonic enhancement observable  $\Delta P_{uv}$  correlates with Laplacian-derived partitions. In contrast to complexity-focused interpretations of boson sampling, we treat interference as a physically interpretable probe of learned relational structure.

### C. Quantum Machine Learning and geometry

This geometric viewpoint is especially natural QML, a domain that extends this perspective into Hilbert space, where variational circuits encode information in amplitudes and phases [6, 9, 65, 67, 68]. Quantum graph neural networks (QGNNs) and related relational variational architectures embed graph structure directly into quantum circuits [39, 55, 60, 90]. Yet most existing analyses remain either architecture-centric or optimization-centric. Much less attention has been paid to simple, model-agnostic observables that diagnose how learning reshapes the geometry of the representations themselves.

### D. Bloch-space geometry for anomaly detection

Quantum autoencoders extend the same geometric picture into latent quantum state space [75-78]. Originally introduced as variational compression models [45], they have only recently been explored for anomaly detection [82, 103, 104, 114, 115], despite the broader importance of anomaly detection across machine learning, cybersecurity, and cyber-physical systems [94, 95]. Classical autoencoders identify anomalies through reconstruction error [36], while quantum variants have been studied through variational and optimization-based approaches [82, 95, 103].

Anomaly detection [72, 73, 82, 93-95] is central to cybersecurity and cyber-physical systems, where rare events must be identified without labelled attack data [36, 37, 94]. Recent surveys further show that graph anomaly detection and graph-based intrusion detection remain methodologically fragmented and sensitive to graph construction, benchmark choice, and deployment assumptions [15, 36, 46, 72, 94, 95].

In this setting, a hybrid quantum autoencoder defines a manifold of reduced quantum states in its latent layer, making Bloch-space drift a natural local probe of how samples move relative to the benign manifold representations [9, 32, 48]. Parameterized (variational) quantum circuits that provide an alternative route to expressive latent representations been explored for supervised learning and quantum-enhanced feature mappings, commonly using hardware-efficient ansätze suited to near-term devices [48, 65, 68]. This is useful because hybrid quantum-classical models based on parameterized circuits can generate expressive latent representations [9, 32, 48, 105]; yet most studies still emphasize aggregate metrics such as ROC-AUC [6, 16, 17, 48] rather than the geometry of learned states.

Trainability of variational circuits is constrained by barren plateaus and landscape-induced gradient suppression [87]. These effects have been linked to the geometry of the state manifold through the quantum Fisher information (QFI), which induces a Riemannian metric governing sensitivity and identifiability [17, 96, 97]. Natural-gradient methods exploit this structure to improve optimization stability [97], but *geometric quantities derived from measured expectation values* are rarely used as post-training diagnostics.

These considerations motivate the use of **Bloch-space geometry** [36, 96, 98, 103-107] as a diagnostic tool to probe how anomalies are encoded in quantum latent representations. We, therefore, *in contrast to previous works*, analyze Pauli expectation values to construct Bloch-space drift metrics that distinguish persistent geometric displacement from transient fluctuations, clarifying how anomalies deform the learned quantum manifold [77-79, 114, 115]. The intrusion detection task is used as a structured, high-dimensional benchmark to probe the behavior of quantum latent bottlenecks under realistic thresholding constraints.

### E. Contributions

This work makes three major contributions grounded in spectral geometry and physically interpretable diagnostics.

(1) *Bosonic probe of learned graph structure:* We introduce an edge-resolved bosonic observable derived from two-photon coincidence probabilities. The interference enhancement  $\Delta P_{uv}$  correlates with Laplacian-derived features such as the Fiedler partition, establishing a direct connection between learning-induced spectral restructuring and experimentally measurable many-body interference. *Hardware validation* confirms these signatures and supports a visualization framework that renders interference-induced edge enhancement interpretable in graph-theoretic terms.

(2) *Bloch-space diagnostic for hybrid quantum autoencoders:* We define Bloch drift as a physically grounded anomaly metric derived from Pauli expectation values and distinguish absolute geometric displacement from consecutive state-to-state variation. Using an unsupervised threshold derived from benign data, we demonstrate near-perfect ranking performance on DoS data while showing that detection arises from structured deformation of the latent quantum manifold rather than transient dynamical noise.

(3) *Representational impact of a quantum circuit:* By comparing a classical autoencoder (CAE) and a hybrid quantum autoencoder (HQAE) under *identical* preprocessing, dimensionality reduction, and optimization settings, this work isolates the representational impact of the quantum circuit. The results indicate that while there is no significant benefit over classical models in *global ranking metrics*, hybrid quantum models can improve robustness at the operational decision boundary, as reflected by the metrics.

The central claim of this work is that these apparently different settings are governed by the same underlying mechanism: learning induces geometry in a manifold of quantum representations, and that geometry can be probed either globally or locally. In graph-regularized quantum learning, the global structure is encoded by the Laplacian spectrum of the learned similarity graph. In the quantum autoencoder, the local structure is encoded by persistent displacements in Bloch space. Spectral diagnostics and Bloch-space observables should therefore be understood as complementary projections of the same physical object—a learned quantum manifold whose organization controls expressivity, robustness, and collapse. This perspective allows us to move beyond aggregate task metrics and toward a geometric theory of hybrid quantum learning.

Across both settings, we provide a unified spectral–geometric interpretation of hybrid quantum learning models in which the learned structure manifests as experimentally accessible interference and state-space signatures.

### F. Structure of the Paper

The paper is organized as follows. Section II introduces the graph-regularized quantum learning framework and defines the associated spectral diagnostics, including Laplacian eigenstructure, spectral entropy, and effective dimension. We formalize the bosonic edge-resolved interference observable and the Bloch-space drift diagnostic. Section III presents the main results: training dynamics and phase behavior under graph coupling, learned spectral restructuring, bosonic interference signatures, and Bloch-space anomaly encoding, including hardware validation. Section IV discusses the geometric interpretation and implications for hybrid quantum–classical graph models. Section V concludes, followed by Appendices A, B and C.

## II. METHODS

The central claim of this work is that successful hybrid quantum learning is governed by the geometry of its learned representations: globally through spectral organization of similarity graphs, and locally through Bloch-space displacement of latent quantum states. This subsection describes the methodologies behind our experiments in graph regularized quantum learning and Bloch-drift in QAE.

### A. Spectral structure in graph learning

**Dataset:** All experiments are performed on the graph shown schematically in Fig. 1. The graph used throughout this work consists of nodes corresponding to learned representations, with edges encoding pairwise similarity constraints. 15 nodes are partitioned into **supervised learning (SL)** and **unsupervised learning (UL)** subsets, reflecting whether their associated outputs are directly constrained by labeled training data or evolve solely through relational and regularization terms. SL nodes participate in both supervised loss contributions and graph-based interactions, while UL nodes are updated only through graph coupling and regularization, serving to propagate structural information across the network. This distinction allows the graph to mediate information flow between supervised and unsupervised components, and underlies the spectral structure analyzed in subsequent sections.

All spectral graph experiments reported in this work are based on synthetically generated graphs constructed from explicitly defined generation procedures and kernel functions described in Sec. II. No external datasets are used in the spectral-geometry analysis. All Laplacian matrices, eigenvalue spectra, spectral entropy values, and effective dimensions are computed deterministically from these constructed graphs.

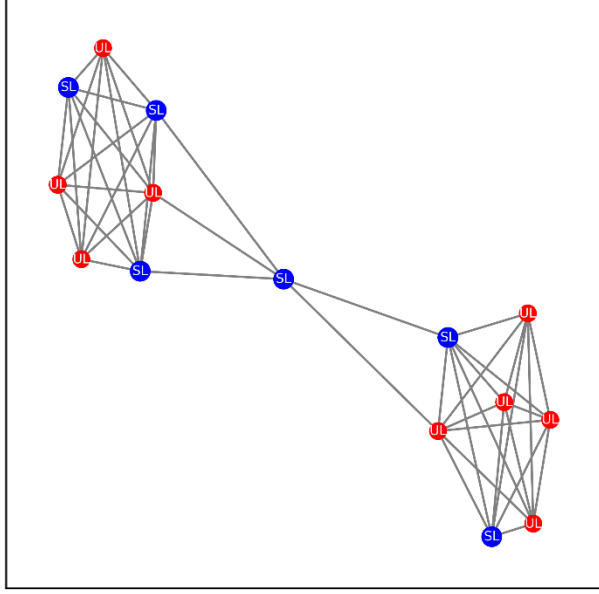

FIG. 1. (Color online) Schematic of the 15-node graph structure used throughout this work. Nodes correspond to blue supervised (SL) and red unsupervised (UL) components, with edges indicating pairwise similarity constraints. This fixed graph defines the connectivity and spectral structure analyzed in subsequent sections on bosonic probes for learned graph structure.

**Graph construction and node roles:** The graph used throughout this work (Fig. 1) consists of 15 nodes corresponding to learned representations, with edges encoding pairwise similarity constraints. Nodes are partitioned into **supervised learning (SL)** and **unsupervised learning (UL)** subsets, reflecting whether their associated outputs are directly constrained by labeled training data or evolve solely through relational and regularization terms. SL nodes participate in both supervised loss contributions and graph-based interactions, while UL nodes are updated only through graph coupling and regularization, serving to propagate structural information across the network. This distinction allows the graph to mediate information flow between supervised and unsupervised components, and underlies the spectral structure analyzed in subsequent sections. Learning is governed by a cost functional  $C[s]$  given by [10],

$$C[s] = C_{SL}[s] + \lambda_G \sum_{(u,v) \in E} A_{uv} \|\mathbf{h}_u(s) - \mathbf{h}_v(s)\|_2^2 + \lambda_R C_{reg}[s] \quad (1)$$

$$\text{with} \quad C_{SL}[s] = \sum_{u \in \mathcal{V}_{SL}} \ell(\hat{y}_u(s), y_u) \quad (2)$$

and,

$$C_{\text{graph}}(\theta) = \sum_{(i,j) \in E} w_{ij} \|f_\theta(x_i) - f_\theta(x_j)\|^2 \quad (3)$$

Here  $A_{uv}$  is the adjacency matrix of the fixed graph,  $\lambda_G$  controls graph smoothness, and  $\lambda_R$  sets the strength of additional regularization parameterized by  $\gamma$ . UL nodes do not appear in  $C_{SL}$  and are updated only through the graph and regularization terms; they influence  $C$  only via the graph term (and  $C_{reg}$  if present). SL nodes are directly constrained by labels, i.e.,  $u \in \mathcal{V}_{SL}$  in  $C_{SL}$ . Edges encode pairwise similarity constraints which are the Laplacian-style smoothness penalty weighted by  $A_{uv}$ .  $C_{\text{graph}}(\theta)$  is the *disagreement penalty*.

The graph comprises nodes  $u \in \mathcal{V}$  representing learned outputs (or latent representations)  $\mathbf{h}_u(s)$ , with a partition  $\mathcal{V} = \mathcal{V}_{SL} \cup \mathcal{V}_{UL}$  into supervised (SL) and unsupervised (UL) nodes. SL nodes  $u \in \mathcal{V}_{SL}$  are directly constrained by labels through  $C_{SL} = \sum_{u \in \mathcal{V}_{SL}} \ell(\hat{y}_u, y_u)$ , whereas UL nodes have no label term and are updated only via graph coupling and regularization. Graph structure enters through a smoothness penalty  $\sum_{(u,v) \in E} A_{uv} \|\mathbf{h}_u - \mathbf{h}_v\|_2^2$ , (see Appendix A for more details) which propagates information across the SL/UL partition and yields the Laplacian spectra analyzed below.

We consider a quantum learning model in which relational structure is incorporated through graph (Fig. 1) regularization. Let  $G = (V, E)$  denote a similarity graph constructed from the outputs of a parametrized quantum circuit. The nodes  $V$  correspond to data samples, and weighted edges encode pairwise similarity. The geometry of this graph is characterized by its Laplacian

$$L = D - A \quad (4)$$

where  $A$  is the adjacency matrix and  $D$  the degree matrix (more detailed calculations are shown in Appendix A). The Laplacian spectrum  $\{\lambda_k\}$  provides a basis for diagnosing connectivity, mixing, and partition structure of the learned representation. An example of the similarity graph construction and the corresponding Laplacian spectrum is shown in Figs. 9 and 21.

**Proposition 1: (Graph-regularized training reshapes spectral geometry):**

We augment a baseline task loss  $\mathcal{L}_0(\theta)$  with a graph regularization term that penalizes disagreement across adjacent nodes,

$$\mathcal{L}(\theta) = \mathcal{L}_0(\theta) + \gamma \sum_{(i,j) \in E} w_{ij} \|f_\theta(x_i) - f_\theta(x_j)\|^2 \quad (5)$$

where  $f_\theta$  denotes the quantum model output and  $\gamma$  controls the strength of coupling. For  $\gamma < 0$ , the regularization term enforces alignment along graph edges, introducing a relational inductive bias into training dynamics. The parameter  $\gamma$  thus governs a trade-off between fidelity to local data structure and global smoothness over the graph. The relationship between the cost function defined in equations (1-3) and the loss function of equation (5) is given by

$$\mathcal{L}(\theta) = \mathcal{L}_0(\theta) + \lambda_G C_{\text{graph}}(\theta) + \lambda_R C_{\text{reg}}(\theta), \quad \lambda_G \geq 0, \quad (6)$$

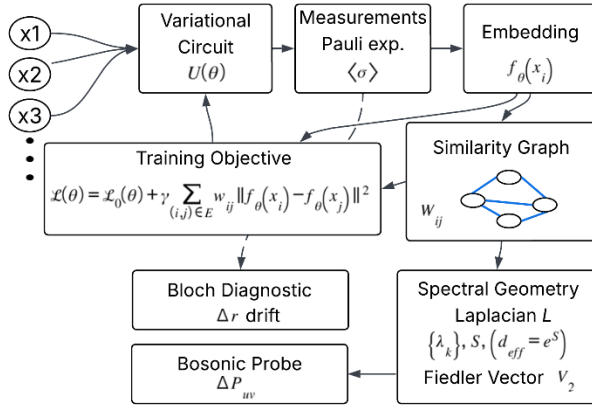

FIG 2. Model schematic. A variational quantum circuit produces embeddings that define a similarity graph regularized by coupling strength  $\gamma$ . The resulting Laplacian spectrum provides geometric diagnostics, while bosonic interference and Bloch-space drift serve as physically grounded probes of the learned structure.

Under the graph-regularized objective of equation 5, training induces a measurable reorganization of the learned similarity graph  $W$ , visible in its Laplacian spectrum through changes in (a) the algebraic connectivity  $\lambda_2$  and (b) the effective spectral dimension  $d_{\text{eff}} = e^S$  computed from the normalized eigenvalue weights, as depicted in Fig. 2.

Training proceeds via gradient-based updates with step size  $\epsilon$ . As parameters evolve, the induced similarity graph and its Laplacian spectrum change dynamically, allowing geometric diagnostics to track the emergence or degradation of structure. Fig. 7 shows a similarity Laplacian graph generated with the following graph-regularization terms: Weighted similarity graph  $W$  constructed from embeddings  $f_\theta(x_i)$ . Edge weights  $w_{ij}$  define the adjacency matrix and degree matrix  $D_{ii} = \sum_j w_{ij}$ ; Eigenvalue spectrum of the

corresponding graph Laplacian  $L = D - A$ . The spectral quantities  $\{\lambda_k\}$ , algebraic connectivity  $\lambda_2$ , and spectral entropy  $S$  introduced below are computed from this operator.

### 1. Spectral Diagnostics

To quantify geometric organization, we monitor three spectral quantities. First, the algebraic connectivity  $\lambda_2$  measures global coherence and signals representational fragmentation when it approaches zero. Second, we define the spectral entropy

$$S = -\sum_k p_k \log p_k, \quad p_k = \frac{\lambda_k}{\sum_j \lambda_j} \quad (7)$$

which captures the distribution of spectral weight across modes. The associated effective spectral dimension,  $d_{\text{eff}} = e^S$  provides a compact measure of representational spread.

Finally, the Fiedler vector  $v_2$  [24], corresponding to  $\lambda_2$ , encodes the principal partition of the graph. Edges with large spectral split  $|v_2(i) - v_2(j)|$  connect nodes that lie on opposite sides of the dominant structural cut and thus play a central role in characterizing learned geometry.

These diagnostics allow us to distinguish regimes in which graph regularization enhances connectivity and mixing from regimes in which excessive coupling suppresses variance and induces low-dimensional collapse.

Fig. 3 shows an example of defining a Laplacian spectral entropy as followed in our methods.  $S = -\sum_k p_k \ln p_k$  with  $p_k = \lambda_k / \sum_k \lambda_k$  (normalized Laplacian eigenvalue distribution); the effective dimension  $d_{\text{eff}}$  is shown for each panel. This conceptual figure illustrates how an increase in  $S$  corresponds to a delocalization of spectral weight and motivates the use of  $d_{\text{eff}}$  as a compact scalar diagnostic of spectral geometry.

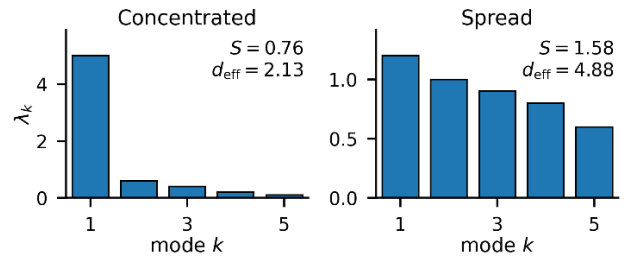

FIG 3. (Colour online) Conceptual Laplacian spectra and spectral entropy. Left: a concentrated Laplacian spectrum with most weight on a few modes (low spectral entropy  $S$  and small effective dimension  $d_{\text{eff}} = e^S$ ). Right: a spread spectrum with weight distributed across modes (high  $S$  and larger  $d_{\text{eff}}$ ).

*a. Graph Geometry to Physical Observables.*

We model an undirected graph  $G = (V, E)$  with  $|V| = m$  nodes that is mapped to a linear-optical unitary via

$$U(t) = e^{itA}$$

where  $A$  is the adjacency matrix helping to connect the learned geometry to experimentally accessible quantities, and  $L$  the graph Laplacian. This construction corresponds to a continuous-time quantum walk and preserves graph symmetries [12].

*b. Two-photon edge probabilities*

**Theorem 1: Edge-level interference:** *Local interference identity leads to edge observables*

For two photons into input modes  $(s, t)$ , we associate each graph edge  $(u, v)$  with a coincidence event on output modes  $(u, v)$ . For indistinguishable bosons [105-108],

$$P_{\text{bos}}(u, v | s, t) \doteq U_{u,s} U_{v,t} + U_{u,t} U_{v,s} \Big|^2$$

While, for distinguishable photons,

$$P_{\text{dist}}(u, v | s, t) \doteq |U_{u,s}|^2 |U_{v,t}|^2 + |U_{u,t}|^2 |U_{v,s}|^2$$

Two-boson interference in this unitary provides edge-resolved coincidence probabilities whose enhancement (the bosonic–distinguishable edge enhancement) is given by the difference,

$$\Delta P_{uv} = P_{\text{bos}}(u, v) - P_{\text{dist}}(u, v) \quad (8)$$

which isolates the interference term and equals the two-path interference term

$$\Delta P_{uv} = I_{uv} = 2 \operatorname{Re} \left[ U_{us} U_{vt} U_{ut} \bar{U}_{vs} \right]$$

This theorem justifies the edge overlay in Fig. 5 which is **physically meaningful** as a direct interference diagnostic.  $\Delta P_{uv}$  isolates the purely quantum contribution. Positive and negative values of  $\Delta I_{uv}$  correspond to constructive and destructive interference, respectively. Together, this framework links graph-regularized learning dynamics, spectral geometry, and physically measurable interference patterns within a unified model.

As shown below, these bosonic signatures directly reflect spectral partition structure encoded by the Laplacian eigenvectors.

*c. Spectral correlation analysis.*

We compute Laplacian eigenvalues and eigenvectors of  $G$  focusing on the Fiedler vector  $v_2$ . Edge-level features such as  $|v_2(u) - v_2(v)|$  and  $v_2(u)v_2(v)$  are correlated with interference measures to identify structure-dependent enhancement. The distinguishable baseline removes all interference effects, ensuring that observed deviations are purely quantum. Our analysis focuses on two-photon inputs to enable analytic separation of interference terms, but the framework generalizes to higher photon numbers.

## 2. Quantum Network Model

We model a quantum communication network [27] as a time-dependent graph  $G_t = (V, E)$  where vertices represent quantum nodes with finite memory and edges represent physical channels capable of probabilistic entanglement generation. Successful generation on an elementary link produces a Werner state

$$\rho_e = F_{0,e} |\Phi^+\rangle\langle\Phi^+| + (1 - F_{0,e}) \mathbb{I} / 4,$$

with initial fidelity  $F_{0,e}$  determined by channel loss and noise [5, 6]. denotes the **maximally entangled Bell state** used as the reference state in Werner states. Entangled pairs stored in memory undergo decoherence, which we model as depolarizing noise. After a storage time  $a$ , the fidelity evolves as

$$F(a) = \frac{1}{4} + \left(F_0 - \frac{1}{4}\right) e^{-a/T_2}$$

where  $T_2$  denotes the memory coherence time. Entanglement swapping at repeater nodes is performed via Bell-state measurements, yielding a Werner state with fidelity,

$$F_{\text{swap}} = \eta_{\text{sw}} \left[ F_1 F_2 + \frac{(1 - F_1)(1 - F_2)}{9} \right]$$

where  $\eta_{\text{sw}}$  captures imperfections in local operations [6, 9].

*a. Bosonic Sampling as a Quantum Feature Map*

To generate expressive representations of local network structure, selected nodes perform Gaussian boson sampling on induced subgraphs corresponding to their local neighborhoods. For a node  $v$ , the adjacency matrix of its neighborhood  $A_{\mathcal{N}(v)}$  is embedded into the covariance matrix of a Gaussian state, and photon-number samples

$$s_v^{(k)} \sim \mathcal{P}_{\text{GBS}}(A_{\mathcal{N}(v)})$$

are generated, where  $\mathcal{P}_{\text{GBS}}$  is the probability distribution over photon-number patterns generated by a Gaussian Boson Sampling device. Statistical moments or histograms of these samples define a quantum-enhanced feature vector  $z_v$ . Owing to the relationship between GBS output probabilities and matrix hafnians, these features encode higher-order connectivity and correlation structure beyond pairwise interactions [16–18].

### b. The GNN Architecture

To generate expressive representations of local network structure, selected nodes perform Gaussian boson sampling on induced neighborhood subgraphs. The resulting photon-number samples define quantum-enhanced feature maps whose statistics are governed by hafnians  $h$ , encoding higher-order connectivity beyond pairwise correlations [13–15]. These features are combined with classical node and edge information to produce a global network state that is processed by a *graph neural network* via message passing,

$$h_v^{(l+1)} = \psi \left( h_v^{(l)} \sum_{u \in \mathcal{N}(v)} h_u^{(l)}, z_v \right) \quad (9)$$

The GNN parameterizes control and inference policies for entanglement generation, swapping, optional purification, optimized using a delivery-dependent objective favoring high-fidelity, low-latency end-to-end entanglement.

### c. The Learning Objective

The network control problem is formulated as a sequential decision process with training augmented by the loss function defined equation (5). The GNN parameterizes policies for entanglement generation, swapping, and optional purification. A delivery-dependent reward is issued as

$$r = 1[F_{\text{e2e}} \geq F_{\text{min}}]R_{\text{succ}} - \lambda_T T - \lambda_W W \quad (10)$$

where  $F_{\text{e2e}}$  is the end-to-end fidelity,  $T$  is delivery latency, and  $W$  quantifies wasted entanglement resources. From a theoretical perspective, the combined bosonic-sampling–GNN architecture can be interpreted as a **variational approximation** to the optimal control policy over *quantum network states*, with the bosonic sampler defining a nonclassical feature map and the GNN acting as a structured variational ansatz.

## 3. Diagnostics of representation structure

We quantify representation spread using the variance of output states in Hilbert–Schmidt distance, graph connectivity via the second Laplacian eigenvalue  $\lambda_2$ , and effective dimensionality through spectral and PCA-based measures. Collapse is defined operationally by the closing of the spectral gap,  $\lambda_2 \rightarrow 0$ .

### a. Theoretical prediction for stationary variance

At late training times, fluctuations around a stable manifold are well described by an effective linear stochastic dynamic. This yields a stationary variance

$$\text{Var}_\infty(\gamma) = \frac{\text{Var}_\infty(0)}{1 + |\gamma|/\gamma_c} \quad (11)$$

where  $\text{Var}_\infty(0)$  and the characteristic scale  $\gamma_c$  are extracted from data. This form follows from a mean-field approximation in which the dynamics reduce to an effective Ornstein–Uhlenbeck process [17–19]. Theoretical curves shown in the main text are evaluated using these measured prefactors and are not fits to transient dynamics.

## 4. Bosonic probe of learned structure

### Theorem 2: Bosonic probe of spectral partitions

In the learned graph regime where the Laplacian exhibits a nontrivial low-frequency structure (finite  $\lambda_2$ , elevated  $d_{\text{eff}}$ ), the edge-resolved interference observable  $\Delta P_{uv}$  aligns with the principal Laplacian partition, such that  $\Delta P_{uv}$  is statistically structured by the Fiedler edge split  $|\Delta v_2| \propto |v_2(u) - v_2(v)|$ , producing a nonzero correlation  $\text{corr}(\Delta P_{uv}, |\Delta v_2|) \neq 0$ .

To probe learned graph structure, we encode the graph into a linear-optical unitary and evaluate two-photon coincidence probabilities on individual edges. Comparing indistinguishable-boson statistics to a distinguishable-photon baseline isolates the interference contribution. Edge-resolved enhancement patterns are analyzed relative to spectral partitions defined by the Laplacian and Fiedler vector.

### 5. Theoretical prediction for representation spread

To interpret the observed dynamics of representation spread during training, we compare numerical results to an analytic prediction for the long-time variance of the output states. In the regime considered here, the training dynamics can be approximated by an effective stochastic evolution in representation space, in which the regularization parameter  $\gamma$  controls the strength of contraction toward a low-variance manifold. Under this approximation, the output variance in

Hilbert–Schmidt distance converges at long times to a stationary value that depends only on  $\gamma$  and not on initialization details.

## 6. Hardware Experiments

Selected observables are evaluated on IBM quantum hardware using  $Z$ -diagonal Hamiltonians. Results are compared to ideal and noisy simulators to assess robustness. Details of the noise model and compilation are provided in [Table AI](#) of [Appendix A](#).

### a. Architecture Choice

We consider a quantum neural network with a [3,1] architecture, mapping three-qubit input states to a single-qubit output. This choice deliberately imposes a strong representational bottleneck, reducing the output Hilbert space dimension from  $2^3 = 8$  to 2. Such compression makes the interaction between supervision, graph regularization, and quantum dynamics explicitly observable.

In this setting, graph regularization does not merely act as a smoothing prior but directly constrains how high-dimensional quantum inputs are embedded into a low-dimensional quantum representation. As a result, failure modes such as over-smoothing and fragmentation correspond to genuine geometric degeneration of the learned representation rather than trivial parameter collapse. This allows spectral diagnostics—such as the algebraic connectivity  $\lambda_2$ , Fiedler vectors, and diffusion-based dimensionality measures—to provide clear and interpretable indicators of learning behavior.

The [3,1] architecture thus represents the smallest non-trivial configuration in which Laplacian-induced effects can be studied systematically while remaining computationally tractable. Larger output layers reduce the visibility of collapse phenomena, whereas smaller or trivial architectures obscure the role of graph-based regularization. Our choice balances expressivity and analytical clarity, enabling a direct connection between theory and empirical observations.

### b. The Hamiltonian Model

We consider a parameterized quantum circuit acting on  $n = 3$  qubits and evaluate the expectation value of a 3-qubit diagonal Pauli Hamiltonian

$$H = Z_0 + 0.5Z_1 + 0.25Z_2 \quad (12)$$

represented as a `SparsePauliOp` in Qiskit [4, 14, 70, 71], where  $Z_i$  represents the Pauli- $Z$  operator acting on qubit  $i$ . The diagonal structure of  $H$  enables direct estimation from computational-basis measurements without basis rotations. Throughout, Pauli operators are indexed according to

Qiskit’s convention, with qubit indices increasing from left to right in the Pauli string representation.

The variational ansatz is constructed using a layered, *hardware-agnostic circuit template* consisting of single-qubit rotations and entangling gates, instantiated here using the `TwoLocal` pattern and subsequently decomposed into elementary gates. The decomposition yields standard rotation and entangling primitives and does not affect the compiled circuit or results reported here. A *model pipeline for the Hamiltonian generation* is shown in [Fig. 29](#) of [Appendix C](#).

### c. Classical simulation baselines

All algorithmic development, training, and regression testing are performed using classical simulation prior to hardware execution. Two complementary simulator baselines were used.

### d. Ideal (noiseless) simulator

An ideal baseline is obtained by sampling the logical three-qubit circuit using a noiseless QASM simulator. This baseline isolates finite-shot effects while excluding hardware noise. Energies are estimated from measurement counts using the relation

$$\langle H \rangle = \sum_{i=0}^2 c_i \langle Z_i \rangle$$

with  $\langle Z_i \rangle$  computed from bitstring frequencies. Shot-noise uncertainties are estimated assuming independent binomial statistics. In order to evaluate the expectation value of the Hamiltonian on the hardware, we use a parameter  $\alpha$  as a *scan coordinate* to probe the hardware-vs-simulator agreement along one chosen parameter direction.

### e. Hardware noise modeling

We simulate an approximate device noise baseline by importing the target backend’s noise snapshot into Qiskit Aer and applying the resulting `NoiseModel` to the logical (3-qubit) circuits. This Aer-based noisy simulation is intended as a *diagnostic* tool that reproduces first-order error channels (readout error, decoherence and native gate infidelities) under the backend calibration used when the snapshot was retrieved. We do not treat the noisy-Aer curve as a predictive forecast of the instantaneous device output: differences can arise from temporal calibration drift, mapping/transpilation artifacts, and open-plan execution constraints.

To contextualize hardware results, we compare experimental energies against two simulator baselines. An *ideal* baseline is obtained from noiseless sampling of the same logical circuit, isolating finite-shot effects. A *noisy* baseline is generated using the Aer simulator with a noise model constructed from device calibration data

via `NoiseModel.from_backend`. This model incorporates gate-dependent depolarizing noise, asymmetric readout errors, and  $T_1/T_2$  relaxation during idle periods, but neglects correlated, non-Markovian, and leakage effects. As such, the noisy-Aer baseline provides a lower-bound estimate of hardware noise and is not expected to fully reproduce experimental behavior. A breakdown of noise sources and budget included in the simulator and present on hardware is provided in [Table AI](#) in [Appendix A](#).

*f. Hardware execution details*

[Table I](#) summarizes the quantum hardware resources used for experiments executed via Qiskit backends. All hardware results were obtained using the Qiskit `EstimatorV2` primitive with shot-based expectation estimation. Queue times in are approximate and reflect typical availability during the experimental period; no post-selection was applied unless otherwise stated.

TABLE I. Quantum hardware resources

Backend (Qiskit)	Qubits used	Shots per circuit	Noise model	Avg. queue time	Notes
ibm_fez	3	8,192	Hardware	2–5 min	Production backend
AerSimulator	3	8,192	Depolarizing + readout	0 s	Noise-aware simulation
AerSimulator	3	Exact	None	0 s	Noiseless reference

**Dense statevector simulation justification:** experiments operate at  $n=3$  qubits, which places them comfortably within the statevector regime. Quantitatively, statevector size scales as  $2^n$  giving  $2^3=8$  complex amplitudes. Hence, a single expectation value  $\langle \psi | H | \psi \rangle$  requires  $O(2^n)=8$  operations, which is negligible compared to circuit transpilation, backend scheduling, and shot-based sampling noise. Even after accounting for repeated evaluations across training iterations ( $\sim 10^3$ ), hyperparameter sweeps, and multiple seeds, the total computational cost remains orders of magnitude below the overhead of invoking `EstimatorV2` on a per-evaluation basis in noiseless simulation. In this regime, dense statevector contraction provides exact expectation values at negligible computational cost compared to circuit execution and shot-based estimation. This enables extensive hyperparameter exploration while preserving numerical precision. Hardware and noise-aware results, summarized in [Table I](#), were obtained using the Qiskit `EstimatorV2` primitive with shot-based execution, which becomes necessary for larger qubit counts and device-native evaluation. We note that

dense statevector methods scale exponentially and become impractical for larger systems ( $n \gtrsim 20$ ), at which point `EstimatorV2` or other shot-based primitives are required even in simulation.

*g. End-to-end training efficiency*

Assessment of the practical impact of different expectation-value backends on training throughput, was done by measuring the average wall-clock time per training epoch (mean  $\pm$  standard deviation) using two implementations: (i) a QuTiP-based dense statevector workflow and (ii) a Qiskit-based dense expectation evaluation. As shown in [Fig. 20](#), the Qiskit dense implementation yields a lower and more stable per-epoch runtime than the QuTiP-based approach for the problem sizes considered.

*h. Circuit compilation and measurement*

Logical three-qubit circuits are transpiled to the target backend using Qiskit’s standard transpilation pipeline, yielding circuits expressed entirely in the backend’s instruction set architecture (ISA), consisting of native single-qubit rotations and entangling gates. During transpilation, logical qubits are mapped onto a subset of the device’s physical qubits; the resulting circuits may span the full physical register of the backend.

To ensure unambiguous measurement interpretation, final measurements are removed from the transpiled circuit and reintroduced such that *only the three physical qubits corresponding to the original logical qubits are measured into a three-bit classical register*. The logical-to-physical qubit mapping is extracted from the transpiler layout metadata, guaranteeing that each measured classical bit corresponds to a specific logical qubit. All reported hardware energies are computed exclusively from these three measured bits.

*i. Energy estimation on hardware*

For a given parameter vector  $\theta$ , the transpiled and measurement-cleaned circuit is executed using `SamplerV2` with 2000 shots per evaluation. Expectation values  $\langle Z_i \rangle$  are computed from measurement outcomes and combined linearly to obtain  $\langle H \rangle$ . Shot-noise uncertainties are estimated via standard error propagation assuming independent sampling of Pauli observables. To assess variability, hardware evaluations are repeated multiple times for selected parameter points, and empirical standard deviations are reported where appropriate.

*j. Comparison methodology*

Hardware results are compared against both ideal and noisy simulator baselines using identical logical parameter points. To facilitate direct comparison despite differing

internal parameter orderings introduced by transpilation, simulator parameter vectors are mapped onto the transpiled circuit’s parameter ordering prior to hardware execution. This ensures that all three curves—ideal simulator, noisy Aer, and hardware—correspond to the same logical circuit parameters.

Differences  $\Delta E = E - E_{\text{ideal}}$  are reported to highlight the contribution of calibrated noise and residual hardware effects. Agreement between hardware and noisy-Aer within error bars indicates that dominant error mechanisms are captured by the calibration-derived noise model, while systematic deviations beyond this baseline are attributed to effects not included in the simulator.

**Relation to Quantum Kernels and Bosonic Sampling Hardness:** Hardware experiments are used here to validate qualitative trends and noise sensitivity observed in simulation, rather than to establish quantitative performance bounds. The noisy-Aer baseline, constructed from device calibration data, is included as a diagnostic reference that captures dominant gate and readout errors but is not intended as a predictive model of instantaneous device behavior. Residual discrepancies between noisy simulation and hardware are therefore expected and are consistent with correlated, non-Markovian, and leakage effects not included in calibration-derived noise models. Agreement within uncertainty bounds across multiple parameter settings indicates that the *observed deviations* are systematic rather than dominated by finite-shot noise. Together, these results support the robustness of the algorithmic behavior while clarifying the limits of present-day hardware realism.

## 7. Implicit quantum kernel

If  $p_\nu(s)$  denotes the GBS output distribution over photon-count patterns defined by  $s$  generated by encoding the local neighborhood subgraph around node  $\nu$ , then, an implicit kernel between two neighborhoods  $\nu$  and  $\nu'$  can be written as:

$$K_{\text{GBS}}(\nu, \nu') = \sum_{s \in \mathcal{S}} \sqrt{p_\nu(s) p_{\nu'}(s)} = \langle \sqrt{p_\nu}, \sqrt{p_{\nu'}} \rangle \quad (13)$$

i.e., the inner product between “square-rooted” sampling distributions (a Bhattacharyya/Hellinger-type [98, 99] kernel). In our experiments,  $p_\nu$  was accessed through samples, so the model learns on an **implicit quantum feature map** without explicitly evaluating hafnians.

### B. Bloch-space geometry for anomaly detection

**Dataset:** Experiments were conducted using flow records from the CIC-IDS2018 dataset [98, 99] in combination to 20400 rows of benign data from Specifically, we used the Friday-WorkingHours-Afternoon-DDos.pcap\_ISCX.csv, containing labeled bidirectional network flow features extracted via CICFlowMeter. We

considered two classes: **BENIGN** and **DrDoS\_SSDP**. All non-numeric identifiers were removed. Features were standardized using statistics computed on the training set only. The dataset was partitioned into disjoint training, validation, and test subsets to prevent data leakage.

### 1. Classical and Hybrid Quantum Autoencoder

The model consists of a classical encoder, a quantum latent layer, and a classical decoder. Classical features are mapped to rotation angles and embedded via angle encoding. The quantum latent layer is implemented using a shallow, hardware-efficient variational circuit with single-qubit rotations and ring entanglement [100]. Measurements of Pauli operators provide the quantum latent representation.

#### a. Classical Autoencoder (CAE)

The classical autoencoder consists of a fully connected encoder–decoder architecture with ReLU activations. The encoder compresses the 16-dimensional input into an 8-dimensional latent space, which is then reconstructed by a symmetric decoder. The model was trained using mean squared reconstruction error and optimized via Adam optimiser. As an unsupervised anomaly detector, the autoencoder learns to accurately reconstruct benign traffic while producing higher reconstruction errors for anomalous flows.

#### b. Hybrid Quantum Autoencoder (QAE)

The hybrid quantum autoencoder (QAE) replaces the classical latent bottleneck with a **variational quantum circuit (VQC)**. A classical preprocessing network maps the reduced feature vector to qubit rotation angles. The quantum circuit employs: Angle embedding, trainable rotation gates, ring entanglement via CNOT operations, measurement of Pauli-Z expectation values as latent features.

The quantum latent layer was implemented using a shallow, hardware-efficient variational circuit with angle embedding and ring entanglement, ensuring expressive yet stable quantum representations (Fig. 5). The quantum latent representation is subsequently decoded using a classical neural network. Due to current quantum simulation constraints, training was performed on a subsample of benign data, following standard practice in hybrid quantum machine learning.

### 2. Model Architecture

We employ a hybrid quantum–classical autoencoder consisting of:

1. A classical encoder mapping  $x \in \mathbb{R}^d$  to rotation angles  $\phi(x)$ ,
2. A variational quantum latent layer,
3. A classical decoder reconstructing  $\hat{x}$

The quantum latent layer prepares the state

$$|\psi(x)\rangle = U(\theta, x)|0\rangle^{\otimes n} \quad (14)$$

where  $U(\theta, x)$  consists of angle embedding followed by two layers of trainable  $R_Y$  and  $R_Z$  rotations and ring entanglement [97]. Pauli expectation values define the latent representation

$$\mathbf{z}(x) = \left\{ \langle X \rangle_q, \langle Y \rangle_q, \langle Z \rangle_q \right\}_{q=1}^n \quad (15)$$

The anomaly score is the reconstruction error

$s(x) = \|x - \hat{x}\|_2^2$ . Fig. 4 below shows the high-level model diagram, with the full model pipeline shared in [Fig. 30](#) of [Appendix C](#).

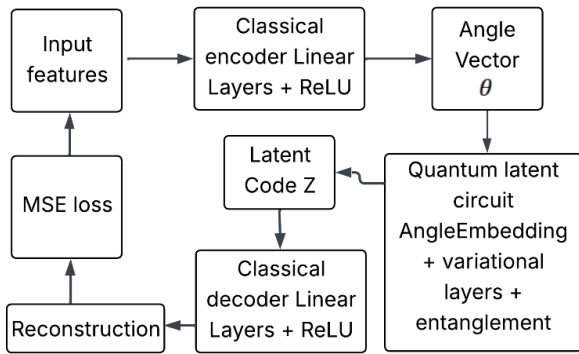

FIG 4. High-level schematic of the extended hybrid classical-quantum autoencoder used for DDoS anomaly detection. Classical preprocessing maps flow features to circuit parameters for a variational quantum latent encoder, whose learned latent state is probed through reconstruction, latent-energy, Bloch-geometric, fidelity/entropy, and QFI-based diagnostic branches. This design allows anomaly detection to be interpreted simultaneously in terms of reconstruction quality, latent-state geometry, effective energy landscape, and trainability. A full model pipeline is shown in [Fig. 30](#) of [Appendix C](#).

In [Fig. 4](#), input traffic-flow features are first preprocessed and mapped by a classical front end to a low-dimensional angle representation, which is embedded into a variational quantum latent encoder.

### 3. Training & Quantum Circuit

The QAE model was trained end-to-end by minimizing mean squared reconstruction error,

$$\mathcal{L} = \frac{1}{N} \sum_{i=1}^N \|x_i - \hat{x}_i\|_2^2 \quad (16)$$

Gradients of quantum parameters were computed using the parameter-shift rule [65, 119]. Optimization was performed using Adam. The anomaly threshold  $\tau$  was defined as the 95<sup>th</sup> percentile of benign validation reconstruction errors and fixed during testing. All experiments were conducted using state-vector simulation without noise modeling to isolate representational effects. **Bloch-Space Representation:** For each qubit  $q$ , Pauli expectation values define a Bloch vector

$$\mathbf{r}^{(q)}(x) = \left( \langle X \rangle_q, \langle Y \rangle_q, \langle Z \rangle_q \right) \quad (17)$$

The **absolute Bloch drift** is defined as

$$d^{(q)}(x) = \|\mathbf{r}^{(q)}(x) - \boldsymbol{\mu}_B^{(q)}\|_2 \quad (18)$$

where  $\boldsymbol{\mu}_B^{(q)}$  is the benign mean Bloch vector. The **consecutive Bloch drift** is defined as

$$\Delta^{(q)}(x_t) = \|\mathbf{r}^{(q)}(x_{t+1}) - \mathbf{r}^{(q)}(x_t)\|_2. \quad (19)$$

[Fig. 5](#) shows the quantum circuit generated during the code implementation as the VQC.

The VQC of [Fig. 5](#) is a *hybrid quantum autoencoder latent circuit* with 6 qubits (indexed 0–5), two variational layers, followed by Pauli measurements. The *AngleEmbedding* block applies a data-dependent rotation to each qubit where each input feature  $x_i$  is encoded as  $R_Y(x_i)$  that maps classical features into quantum embeddings. This defines the input-dependent quantum state  $|\psi(x)\rangle$ . In *first variational layer* formed by the *RY–RZ* blocks, each qubit undergoes a trainable local unitary  $U(\theta) = R_Y(\theta_{i,1})R_Z(\theta_{i,2})$ , where parameters are learned jointly with the classical encoder/decoder. This layer shapes the local geometry of the quantum latent space. Following that, the CNOT gates form a ring topology:

$$0 \rightarrow 1 \rightarrow 2 \rightarrow 3 \rightarrow 4 \rightarrow 5 \rightarrow 0$$

This topology introduces non-local correlations ensuring no qubit is isolated and matches hardware-efficient, NISQ-compatible layouts. This entanglement is crucial for non-Euclidean latent geometry, and the Bloch-space displacement effects observed in this experiment.

The second identical *RY–RZ* trainable layer increases expressivity, deepens the latent manifold, but remains shallow enough to avoid barren plateaus. This is consistent with the stable consecutive Bloch drift ( $\text{AUC} \approx 0.5$  in [Fig. 14](#)) observed and non-chaotic embeddings. Each qubit is measured (typically  $\langle Z \rangle$ , or  $\langle X, Y, Z \rangle$  for Bloch analysis); measurement outputs become the *quantum latent vector*, and fed into the classical decoder. These are the measurements

we used to obtain Bloch trajectories, Bloch drift metrics, and geometry-based anomaly analysis.

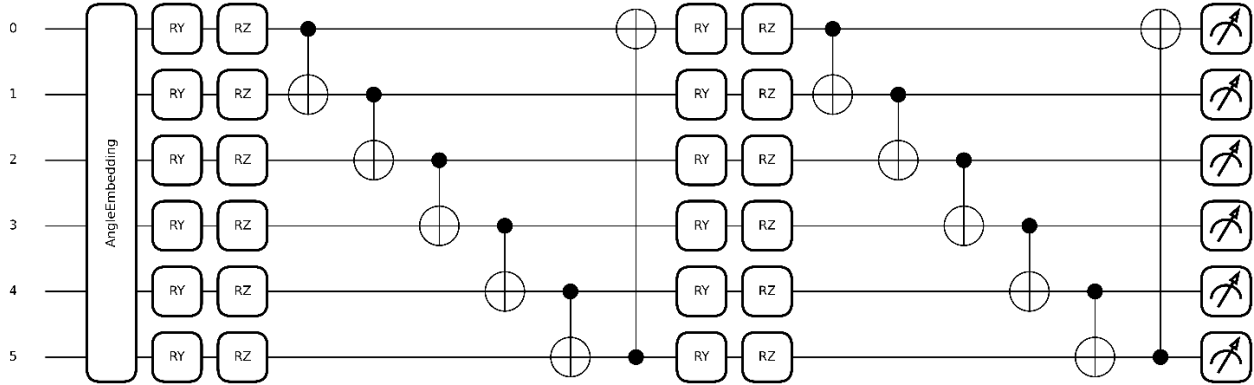

FIG 5. Variational quantum circuit employed as the quantum latent layer of the hybrid quantum autoencoder. Classical input features are encoded via angle embedding, followed by two layers of trainable single-qubit rotations and ring-structured entanglement. Final measurements yield the quantum latent representation, which is passed to the classical decoder. This hardware-efficient ansatz induces structured quantum latent geometry while remaining shallow enough to ensure stable embeddings and avoid spurious dynamical effects.

The variational quantum circuit shown in Fig. 5 defines the quantum latent mapping  $x \mapsto |\psi(x)\rangle$  used throughout this work. For each input sample, classical features are embedded via angle encoding, followed by trainable single-qubit rotations and ring-structured entanglement. Measurements of Pauli operators yield Bloch vectors  $\mathbf{r}^{(q)}(x) = (\langle X_q \rangle, \langle Y_q \rangle, \langle Z_q \rangle)$  for each qubit  $q$ , which form the quantum latent representation. These Bloch vectors are subsequently used to define geometric drift metrics that quantify anomaly-induced displacement in quantum state space.

#### 4. Anomaly Scoring and Threshold Selection

For both models, **reconstruction error** is used as the anomaly score. Higher reconstruction error indicates greater deviation from learned benign patterns. To maintain a fully unsupervised evaluation protocol, the decision threshold was set to the 95<sup>th</sup> percentile of benign validation reconstruction errors. This approach avoids label leakage and reflects realistic intrusion detection scenarios. Thresholds optimized directly for F1-score were evaluated but found to produce degenerate classifiers and were therefore excluded from final reporting.

Model performance was assessed using following evaluation metrics: ROC-AUC, Average precision (AP), Confusion matrices at the fixed threshold, Bloch drift metrics. Absolute Bloch drift and consecutive drift were computed as defined above, and ROC-AUC values were reported for each qubit. A more theoretical description of

Bloch geometry and quantum autoencoders are offered in [Appendix B](#).

#### 5. Quantum Fisher Information (QFI)

QFI is not a network metric by itself. It is a measure of how sensitive the quantum latent state is to small parameter changes. QFI is used here as a trainability and geometry diagnostic rather than as a traffic feature. In variational quantum learning, QFI is closely connected to quantum information geometry and to the Bures metric [113], and it helps reveal whether the latent circuit has well-conditioned, informative parameter directions [97, 113]. This matters because barren-plateau theory shows that variational circuits can become effectively untrainable if gradients vanish rapidly [87]. Accordingly, the QFI spectrum, together with local-entropy diagnostics, is meaningful for validating that the learned latent DDoS representation is both expressive and trainable [87, 97].

To diagnose the trainability and state structure of the hybrid quantum autoencoder, the mean QFI matrix was computed over benign validation samples after training and plotted its eigenspectrum. QFI provides a local measure of parameter sensitivity and quantum information geometry, and it is closely related to the Bures metric on state space [5, 6, 113]. We additionally computed one-qubit reduced density matrices from the latent circuit and summarized their local mixedness using the Rényi-2 entropy for BENIGN and ATTACK subsets. This pairing of diagnostics was intended to capture both **optimization geometry** (through QFI) and **latent-state structure** (through local entropy), motivated by prior work showing that trainability degradation in

variational circuits can be associated with flat landscapes and entanglement-induced plateau phenomena [7, 9, 87].

Taken together, these diagnostics make the hybrid quantum autoencoder useful not only as a detector but also as an *analysis instrument*. Relative to a classical autoencoder, its main benefit is the ability to derive multiple anomaly views from one latent representation: reconstruction error, energy, geodesic drift, fidelity, purity, entropy, and trainability structure. For *cybersecurity*, that richer latent description is often more valuable than a single scalar anomaly score, particularly when attacks are expressed through coordinated shifts across many flow features [45, 112].

## C. Experimental Setup

### 1. Spectral structure in graph learning

All benchmarks were performed on the same local machine using identical random seeds where applicable. We compare QuTiP and Qiskit implementations under controlled conditions to isolate differences due to software architecture rather than numerical accuracy or model design. The following libraries and versions were used:

- QuTiP (dense statevector and density-matrix evolution)
- Qiskit 2.2.x with Qiskit Aer 0.17.x
- Qiskit Algorithms 0.4.x
- Python 3.11
- OS used was Linux Ubuntu 24.04 LTS
- All simulations use statevector or density-matrix representations
- Timing results are reported as *mean ± standard deviation* over multiple trials
- Hardware tests were conducted on IBM\_fez

### 2. Bloch-Geometry probed QAE for IDS

Performance was quantified using ROC-AUC, precision–recall curves, and confusion matrices. Bloch-space drift metrics were computed from Pauli expectation values to probe geometric displacement and stability of the learned quantum representations. Consecutive Bloch drift was computed along the ordered test sequence to assess embedding stability. Results were validated across multiple random initializations utilizing PennyLane for QAE, CUDA, GPU. Quantum and classical confusion matrices [Figs. 17 and 26 respectively] were computed on the test set to quantify operational reliability. A theoretical background for the methods is given in [Appendix B](#).

## III. RESULTS

### A. Spectral structure in graph learning & Boson Sampling

[Fig.4](#) depicts the characterization of the evolution of learned representations (ref: [Proposition 1](#) and [Theorem 1](#)) during training using three complementary diagnostics. In the no-collapse regime ( $\gamma = -0.5$ ), the representation spread remains finite ([Fig. 6\(a\)](#)), the output similarity graph remains connected ([Fig. 6\(b\)](#)), and the effective spectral dimension stabilizes near unity ([Fig. 6\(c\)](#)).

The panels display **training-time evolution** of spectral and geometric quantities under graph coupling. Representation spread (output variance) is given by blue indicating no collapse ( $\gamma = -0.5$ ) and orange indicating the collapse ( $\gamma = -3.0$ ) area. This shows that in the stable regime, variance saturates at a finite value and in the collapse regime, variance decays toward near-zero. This indicates that the latent representation either maintains geometric richness (given by stable manifold), or collapses to a degenerate subspace (loss of degrees of freedom). This is the first signal of a **geometric phase transition**. The algebraic connectivity (post-training) is given by  $\lambda_2$  that measures graph connectivity: stable regime:  $\lambda_2$  remains finite; collapse regime:  $\lambda_2$  decreases significantly. Hence, graph regularization *reshapes the Laplacian spectrum*. [Fig. 6](#) establishes the dynamical spectral restructuring implied by [Proposition 1](#) (changes in variance,  $\lambda_2$ , and  $d_{\text{eff}}$ ), which in turn supplies the spectral partitions probed locally by the edge-interference observable in and quantified in [Theorem 1](#) via the correlation between  $\Delta P_{uv}$  and the Fiedler split  $|\Delta v_2|$  shown before.

[Fig. 6](#) shows that stronger regularization ( $\gamma = -3.0$ ) suppresses representation spread and reduces graph connectivity, signaling a tendency toward representational collapse. Together, these measures provide a consistent picture of how training parameters control the balance between expressive diversity and collapse. The results illustrate how training dynamics affect representation diversity, connectivity, and spectral structure: in the stable regime, variance saturates at a finite value; in the collapse regime, variance decays toward near-zero.

The learned graph either maintains high-dimensional support or compresses to a lower-dimensional manifold. This connects directly to spectral entropy increase/decrease and Bosonic sensitivity to partitions. Together the three panels of [Fig. 6](#) demonstrate the dynamical mechanism of the bosonic probe into the spectral geometry, and prove that bosonic interference is *not* just an interesting correlation *but* graph coupling *actually changes geometry during training*, can drive a *collapse transition*, and then the bosonic probe detects that change: Graph regularization induces a geometric phase transition; that transition is spectrally

measurable; the transition controls interference observables; the transition controls anomaly geometry.

Fig. 6 shows that graph coupling reshapes the spectral geometry of the learned output manifold during training. In the stable regime, the output variance and algebraic connectivity  $\lambda_2$  remain finite and the effective spectral dimension saturates, indicating preservation of geometric richness. In contrast, stronger coupling drives collapse, characterized by suppressed variance, reduced  $\lambda_2$ , and diminished effective dimension. This dynamical restructuring provides the geometric mechanism underlying the bosonic interference signatures in Fig. 7.

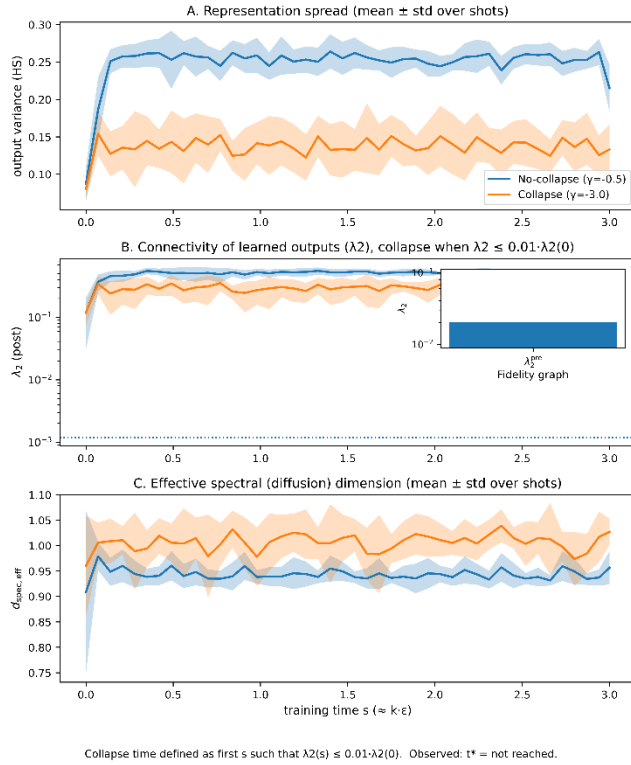

FIG 6. (Colour online) Training Dynamics (a) *Representation spread*, quantified by the *variance* of output states in Hilbert–Schmidt distance, shown as mean  $\pm$  one standard deviation over shots, separating stable vs collapse regimes. (b) Corresponding shift in  $\lambda_2$  connectivity of learned outputs measured by the second-smallest Laplacian eigenvalue  $\lambda_2$  of the output similarity graph after training; collapse is defined as  $\lambda_2 \leq 0.01 \lambda_2(0)$  (dotted line). The inset shows the corresponding pre-training fidelity graph for reference. (c) Shows the change in  $d_{\text{eff}}$ ; effective spectral (diffusion) dimension of the learned output graph, shown as mean  $\pm$  one standard deviation over shots. (ref: [Theorem 1](#)).

The graph visualization of Fig. 7 (ref: [Theorems 1 & 2](#)) shows **boson-enhanced edge traffic** for a fixed two-photon

input, with edge thickness encoding the interference contribution  $\Delta P = P_{\text{bos}} - P_{\text{dist}}$ . The inset quantifies this enhancement edge by edge, making clear that interference is **not uniform across edges**. This demonstrates that bosonic interference redistributes probability along the graph’s spectral cut. The spectral alignment of the bottom panel shows the plotting of the interference term  $I_{uv}$  against the Fiedler edge split  $|\nu_2(u) - \nu_2(v)|$  reveals a **negative correlation** ( $r = -0.5$ ), edges that more strongly cross the spectral cut exhibit stronger (more negative) interference. This directly links local bosonic interference to global spectral structure. The reported values of  $r = -0.5$ ,  $\langle I \rangle = \langle \Delta P \rangle \approx -0.095$ , and a finite  $\lambda_2$  show a **systematic, not accidental**, alignment between interference and the Laplacian partition. The purpose of the correlation  $r$  is not statistical inference but to demonstrate a systematic alignment between interference and spectral structure, which is visually apparent in Fig. 7 and consistent across representative inputs. Fig. 7 shows that edge-resolved bosonic interference aligns with the graph’s spectral partition, with stronger interference occurring on edges that cross the Fiedler cut.

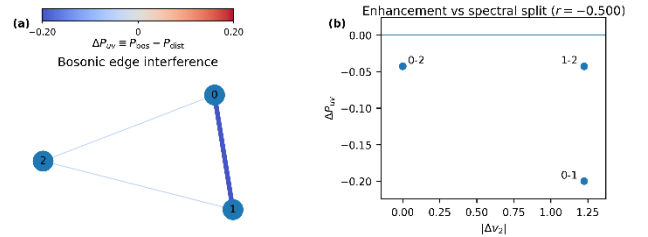

FIG 7. (Colour online) Bosonic interference and spectral structure. (a) Edge-resolved bosonic interference  $\Delta P = P_{\text{bos}} - P_{\text{dist}}$  for a representative two-photon input, visualized on the graph; edge color and width encode the sign and magnitude of  $\Delta P_{uv}$ . The inset shows the corresponding edge-wise interference values. (b) Interference term  $I_{uv}$  versus Fiedler edge split  $|\Delta \nu_2|$ . Edges that cross the spectral partition exhibit stronger interference, yielding a negative correlation ( $r = -0.50$ ).

To test whether the observed representation dynamics are consistent with theoretical expectations, Fig. 8 compares the time evolution of output variance to analytic predictions for different values of the regularization parameter  $\gamma$ . Across all cases, the observed variance converges toward the predicted asymptotic values, with stronger regularization producing systematically reduced spread. The agreement indicates that  $\gamma$  controls the long-time representation variance, providing a quantitative explanation for the collapse behavior identified in Fig. 5.

Fig. 8 shows **quantitative agreement with a theoretical prediction** (dashed lines), across **multiple  $\gamma$  regimes**, over **training time**, with uncertainty. This is diagnostic as well as a **validation of the theoretical model** governing representation spread establishing that the observed representation dynamics follow the predicted asymptotic behavior controlled by  $\gamma$ .

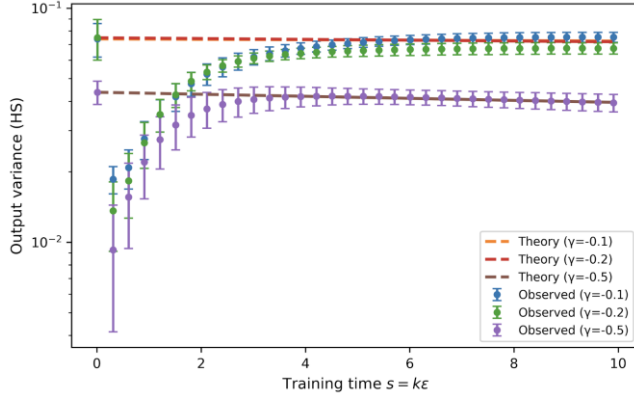

FIG 8. (Colour online) Theory vs Experiment. Output variance in Hilbert–Schmidt distance as a function of training time for three values of the regularization parameter  $\gamma$ . Symbols show observed values (mean  $\pm$  one standard deviation over shots), while dashed lines indicate theoretical predictions for the asymptotic variance. The agreement confirms that the long-time behavior of representation spread is governed by  $\gamma$ , with stronger regularization suppressing variance and driving collapse. *Dashed lines are analytic predictions, not fits to the data.*

Fig. 5 establishes the existence of collapse and non-collapse regimes empirically, while Fig. 7 tests whether the observed dynamics are consistent with theoretical predictions for the asymptotic variance. The latter therefore serves as a theory–consistency check rather than a repetition of diagnostics.

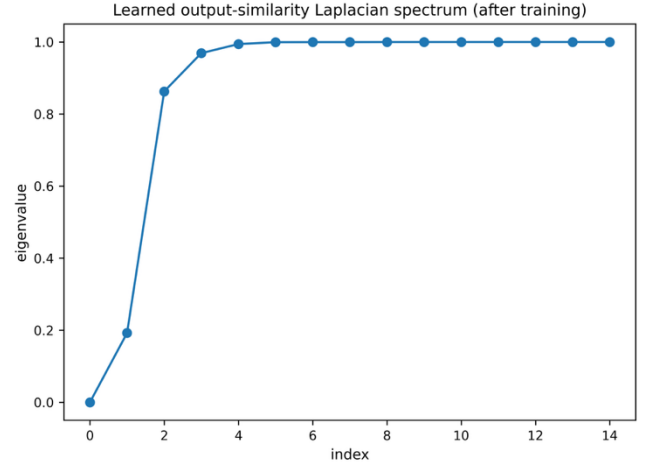

FIG 9. (Colour online) *Laplacian post-training spectra of the 15-node fidelity graph of Fig. 1 and learned output similarity graph. A pre-training Laplacian spectra is shown in Fig. 19 in Appendix A along with detailed comparison.*

Fig. 9 shows the post-training Laplacian spectra that depicts structural phase of the learned graph: a highly non-generic structure of  $\lambda_2 \approx 0.19$ ;  $\lambda_2 \approx 0.86$ ; a spectral gap  $\lambda_3 - \lambda_2 \approx 0.67$ ; ratio  $(\lambda_3 / \lambda_2) \approx 4.5$ ; all remaining eigenvalues cluster tightly near 1. The ratio strongly indicates a single dominant partition. Geometrically,  $\lambda_2 \approx 0.19 > 0$  implies a nonzero algebraic connectivity. This supports Theorem 1 in that training reshapes spectral geometry by isolating a dominant partition mode while compressing higher-order fluctuations. The learned output-similarity Laplacian exhibits a pronounced spectral gap between  $\lambda_2 \approx 0.19$  and  $\lambda_2 \approx 0.86$ , indicating the emergence of a single dominant partition mode while higher modes collapse toward a mixed bulk near unity. This structure places the model in a geometrically ordered but non-collapsed phase, consistent with the Fiedler-driven interference signatures observed in Figs. 6 and 7.

Having established how training dynamics control representation diversity and graph structure, we now examine how these learned representations manifest in experimentally accessible observables on quantum hardware. Fig. 10(a) compares hardware energies with ideal and noisy Aer baselines across representative parameter settings.

Fig. 10(b) shows that Hardware deviations exhibit both positive and negative shifts, indicating a combination of coherent and stochastic noise, whereas noisy simulation captures a systematic downward bias with reduced variance. Overall deviations remain bounded, supporting the robustness of the variational landscape under realistic noise.

The noisy-Aer baseline is not intended as a predictive model of device behavior, but as a diagnostic lower bound on hardware noise. The observed deviation exceeds statistical shot noise, indicating genuine hardware noise

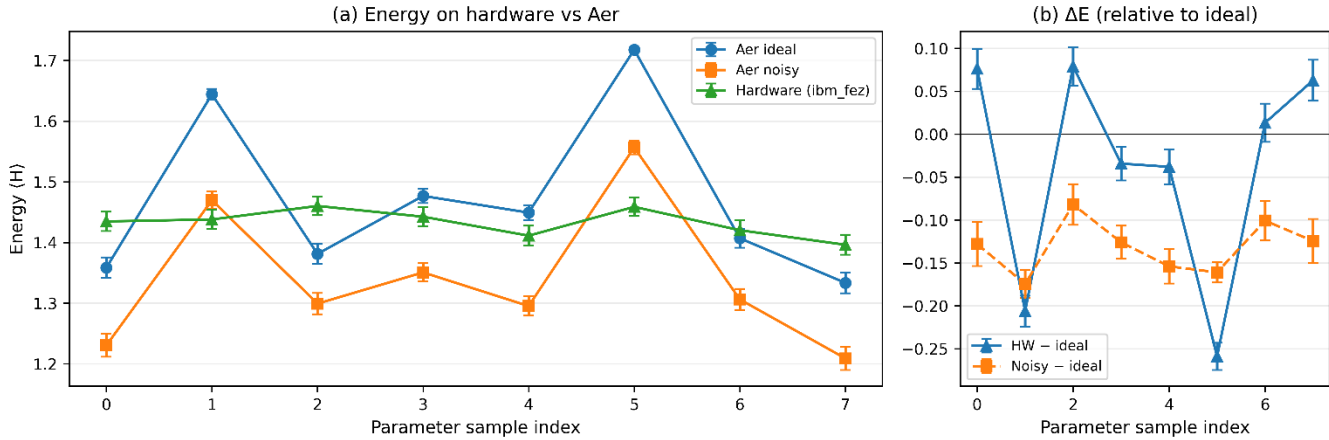

contributions. While more detailed noise models are possible, they require assumptions about correlated and time-dependent processes that are not independently calibrated. We therefore restrict to a standard calibration-derived noise model. Similar qualitative behavior was observed across multiple operational backends (not shown). Real hardware preserves the qualitative variational energy landscape while introducing bounded, interpretable noise-induced shifts relative to ideal simulation.

Hardware experiments were conducted under open-plan using session-less execution. While this limits throughput, it reflects a widely accessible execution mode and does not

affect the correctness of expectation-value estimation. All measurements were performed using consistent shot counts and verified measurement mappings.

As a next step from the hardware energy expectations, structure of the learned energy landscape in Fig. 11 shows the energy evaluated along a continuous interpolation in parameter space. Despite systematic offsets and finite noise, the hardware results closely track the curvature and monotonic trends predicted by the statevector simulator. This indicates that hardware execution preserves the local geometry of the energy landscape, beyond isolated parameter points.

FIG 10. (Colour online) (a) Energy expectation values  $\langle H \rangle$  evaluated on hardware (ibm\_fez), compared with ideal and noisy Aer simulators. The noisy-Aer baseline incorporates gate and readout errors derived from device calibration. Error bars denote one standard error estimated from shot noise. (b) Deviation from the ideal simulator,  $\Delta E$ . The noisy-Aer baseline captures a substantial fraction of the hardware deviation, while residual discrepancies reflect hardware effects not included in the calibration-derived noise model. Deviation from the ideal energy,  $\Delta E$ , highlighting the contribution of calibrated noise and residual hardware effects not captured by the simulator. Error bars denote one standard deviation estimated from shot noise. The noisy-Aer baseline uses a calibration-derived noise model defined in Appendix C.

Fig. 11 shows a smooth, continuous agreement between simulator and hardware, and correct curvature along a parameter direction, not just pointwise comparison exhibiting evidence that hardware captures the **energy landscape geometry**, not just values. In Fig. 11,  $\alpha$  is the *interpolation parameter*;  $\theta_0$  = a reference set of circuit parameters as the “base”;  $\mathbf{v}$  = a fixed *random direction* in parameter space (same dimension as  $\theta$ ).  $\alpha$  is a scalar that controls distance moved in direction  $\mathbf{v}$ . The  $y$ -axis evaluate the *energy expectation* value at each  $\alpha$ , following the relationship,

$$E(\alpha) = \langle H \rangle_{\theta(\alpha)}$$

Hence, Fig. 11 compares how  $\langle H \rangle$  changes along this parameter-space line for: a noiseless *statevector simulator* (blue) and, *hardware* with finite shots and noise (orange, error bars).

To resolve how bosonic interference is distributed across the graph, we construct a similarity graph (Fig. 12) over training samples using pairwise quantum state fidelities, thereby approximating the underlying data manifold in Hilbert space. Fig. 12 establishes the smooth agreement with the statevector simulator and demonstrates that hardware measurements reproduce the qualitative shape of the energy landscape along this direction.

The structure of Fig. 12 mirrors the underlying graph connectivity and is consistent across representative input configurations. In contrast to the scalar energy deviations shown in Fig. 6, the edge-resolved view reveals where interference is localized within the network, demonstrating that bosonic effects are intrinsically structured by the graph rather than random. This graph is used to enforce smoothness of the learned quantum channel, ensuring that inputs corresponding to similar quantum states are mapped to similar outputs.

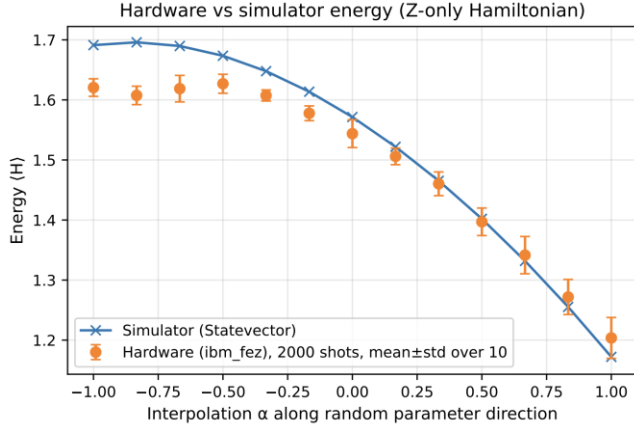

FIG 11. (Colour online) Energy expectation value  $\langle H \rangle$  along a one-dimensional interpolation in parameter space, defined by  $\theta(\alpha) = \theta_0 + \alpha \mathbf{v}$  for a fixed random direction  $\mathbf{v}$ . Hardware results (ibm\_fez) are shown as mean  $\pm$  one standard deviation over ten independent runs with 2000 shots each.

Fig. 12 visualizes the edge-resolved bosonic enhancement as a heatmap, revealing pronounced structure across the graph via the pairwise fidelity matrix of the training data. The matrix exhibits pronounced block structure with weak inter-cluster similarities and a small number of bridging samples. The block structure of Fig. 12 reflects the underlying graph partitions, with enhanced or suppressed interference aligned with Laplacian spectral features. This demonstrates that bosonic interference redistributes probability in a structure-dependent manner rather than uniformly across edges. *Enhancement is defined relative to a distinguishable-photon baseline, isolating the contribution of genuine bosonic interference.*

This geometry implies slow diffusion and a small but nonzero algebraic connectivity, predisposing the graph to fragmentation under Laplacian regularization (ref. Fig 21 in Appendix A). Subsequent spectral collapse and Fiedler-vector partitioning directly reflect this intrinsic structure. The pairwise similarity (fidelity) matrix between training samples shows: Values in  $[0, 1]$  indicating: Bright (yellow)  $\approx$  high similarity; Dark (purple)  $\approx$  low similarity; Symmetric with a bright diagonal (self-similarity); displays a symmetric characteristic with a bright diagonal (self-similarity). The clear block structure indicates intrinsic clustering indicating that the data naturally decomposes into well-defined clusters or manifolds that, while not uniformly connected, are not completely disconnected either, and connectivity is mediated by weak links.

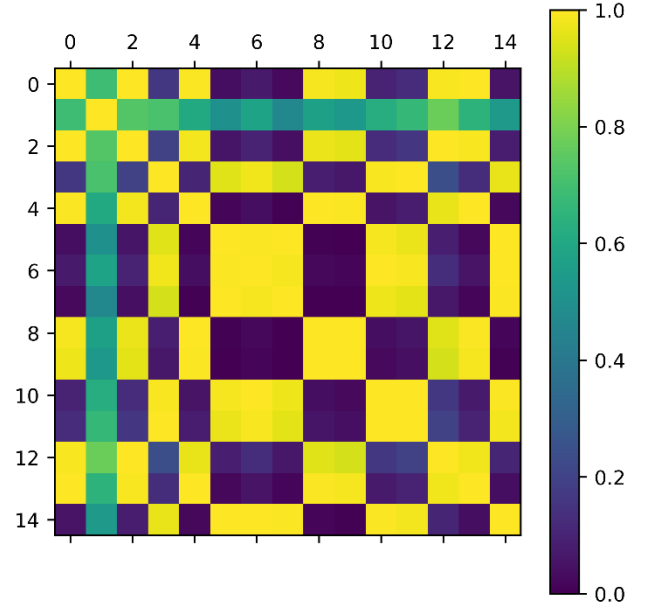

FIG 12. (Colour online) Fidelity matrix. Heatmap of edge-resolved bosonic enhancement, normalized to the maximum value. Each entry corresponds to a two-photon coincidence observable associated with a graph edge.

Benchmarks demonstrate numerical equivalence between operator-based and circuit-based implementations, with fidelities consistently approaching unity. Dense Qiskit execution matches QuTiP performance (Fig.21 in Appendix A) for small systems. These results confirm that operator-based training rules can be faithfully reproduced in circuit-based frameworks without prohibitive cost.

## B. Bloch-Space diagnostics in Hybrid QAE

This addresses the results of the anomaly detection experiments applying classical autoencoder (CAE) and hybrid QAE to IDS data [98, 99].

### 1. Reconstruction-Based Anomaly Detection

We first evaluate anomaly detection using reconstruction error as the anomaly score. In Fig. 13 both the classical autoencoder (CAE) and the hybrid quantum autoencoder (QAE) achieve near-perfect ranking performance (Fig 13), with ROC-AUC values approaching unity.

The ROC curves for the classical autoencoder and the hybrid quantum autoencoder using reconstruction error as the anomaly score. Both models achieve near-perfect ranking performance, with ROC-AUC values above 0.98, indicating strong global separability between benign and attack traffic.

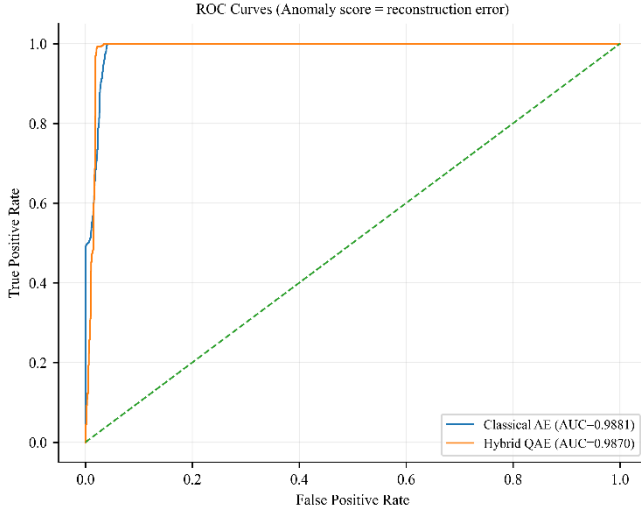

FIG 13. (Colour online) ROC curves for anomaly detection using reconstruction error as the anomaly score. Both the classical autoencoder and the hybrid quantum autoencoder achieve near-perfect ranking performance (ROC-AUC  $\approx 0.99$ ), indicating strong global separability between benign and attack samples. The diagonal dashed line denotes random classification.

The similarity in ROC-AUC in [Fig. 13](#) suggests comparable ranking ability; however, as discussed in subsequent sections, the hybrid quantum model exhibits improved robustness at operational thresholds and encodes complementary geometric information in its quantum latent representation. While this distribution-level separation confirms effective detection, it does not reveal how anomalous inputs are represented within the quantum latent circuit. To probe this internal structure, we next analyze Bloch-space drift derived directly from Pauli expectation values of the quantum circuit outputs, comparing absolute drift from the benign mean with consecutive state-to-state variation.

## 2. Bloch-Space Drift as a Geometric Diagnostic

For each qubit in the quantum latent layer, we compute Bloch vectors from Pauli expectation values and define drift relative to the benign mean state. When absolute Bloch drift is used as the anomaly score, ROC-AUC values remain high ([Fig. 14](#)) (exceeding 0.9 for top-ranked qubits), demonstrating that anomalous inputs induce persistent geometric displacement in Bloch space.

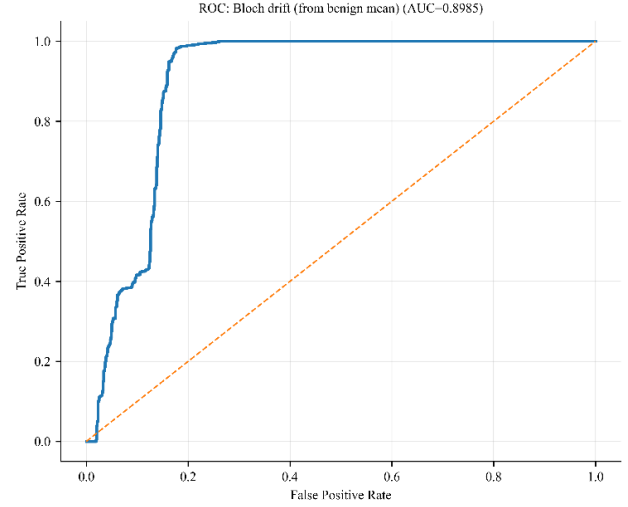

FIG 14. (Colour online) ROC curves for Bloch-space drift metrics derived from the quantum latent circuit. The upper curve shows ROC performance when Bloch drift is measured relative to the benign mean state, yielding strong discriminative power (AUC  $\approx 0.90$ ).

In contrast, consecutive Bloch drift ([Fig. 15](#))—defined as step-to-step variation along the test sequence—produces near-random classification (ROC-AUC  $\approx 0.5$ ). This sharp contrast indicates that detection arises from global displacement rather than local fluctuations. Time-resolved traces of Bloch coordinates further confirm bounded, noise-like behavior in consecutive variations.

As shown in [Fig. 15](#), consecutive drift yields near-random classification performance (AUC  $\approx 0.5$ ), indicating that local state-to-state variations do not correlate with class labels. It is worth mentioning that the result of [Fig. 14](#) is *not* a model failure, but intentional (please see discussion in [Appendix B](#)). This suggests that the variational quantum circuit produces stable embeddings and that anomaly detection arises from absolute geometric displacement rather than local fluctuations. From an optimization perspective, this behavior is consistent with the absence of barren-plateau-induced noise, as circuits exhibiting vanishing quantum Fisher information [87] (see [Theorems B1 & B2](#), [Appendix B](#)) would be expected to produce erratic or unstructured state variations. We therefore include the consecutive drift analysis ([Fig. 15](#)) to rule out trivial dynamical explanations and to strengthen the interpretation of the quantum latent geometry. The Bloch drift metrics are derived directly from the variational quantum circuit in [Fig. 5](#) via Pauli expectation values, as detailed in [Appendix B](#).

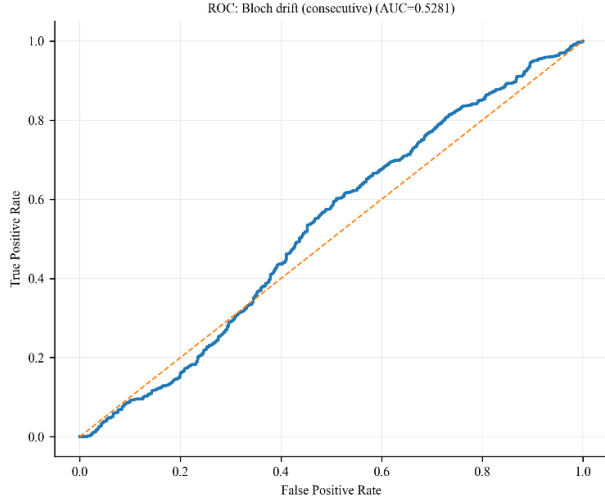

FIG 15. (Colour online) ROC curve for consecutive Bloch drift yields  $AUC \approx 0.5$ , indicating stable quantum embeddings and ruling out anomaly detection driven by spurious state-to-state fluctuations. The diagonal dashed line denotes random classification.

TABLE II. Comparison between the classical autoencoder (AE) and the hybrid quantum autoencoder (QAE).

Metric	Classical AE	Hybrid QAE
ROC-AUC (reconstruction error)	<b>0.988</b> $\pm$ 0.002	0.987 $\pm$ 0.003
Average Precision (AP)	0.998 $\pm$ 0.001	<b>0.999</b> $\pm$ 0.001
False Positive Rate ( $\tau = 95\%$ )	0.057 $\pm$ 0.004	0.058 $\pm$ 0.005
False Negative Rate ( $\tau = 95\%$ )	(6.0 $\pm$ 0.8) $\times 10^{-4}$	(6.1 $\pm$ 0.9) $\times 10^{-4}$
Bloch-drift ROC-AUC (mean across leading qubits)	—	0.94 $\pm$ 0.03
Consecutive-drift ROC-AUC	—	0.50 $\pm$ 0.02
Latent representation	Classical latent vector	Bloch-space embedding
Geometric diagnostic	Not available	Bloch drift and stability analysis

In [Table II](#), all metrics are reported as mean  $\pm$  standard deviation over evaluation runs. The decision threshold is fixed at  $\tau = 95\%$ . [Table II](#) shows that the hybrid quantum autoencoder matches the classical baseline in ranking and operational performance under an identical unsupervised threshold. However, only the quantum model admits a geometric diagnostic via Bloch-space drift, enabling separation of persistent displacement from local fluctuations.

The threshold in [Fig 16](#) is *unsupervised* (no attack labels),

*distribution-driven* (based on benign statistics), *fixed before testing*. That makes it a *property of the learned model*, not of the dataset labels. The histogram with exact FP/FN mass shading marks the threshold’s role explicit: FP mass (BENIGN  $> \tau$ ) indicates fraction of benign samples that exceed normal variability; and FN mass (ATTACK  $\leq \tau$ ) indicates attacks that resemble benign behavior *close enough to evade detection*. In our case: FP  $\approx 5.8\%$  and FN  $\approx 0.06\%$ . This shows *that the benign distribution defines a tight boundary, and attack samples overwhelmingly violate it*.

The threshold also plays a conceptual role in our *Bloch drift analysis* for two main reasons: (1) Reconstruction error threshold identifies *when detection occurs* and (2) Bloch drift explains *why detection occurs*. The decision threshold is defined as the 95<sup>th</sup> percentile of benign validation anomaly scores and therefore reflects the upper bound of normal operating behavior learned by the model. This unsupervised threshold establishes a physically meaningful decision boundary without reference to attack labels. Samples exceeding the threshold correspond to *large absolute displacement in Bloch space* and Consecutive Bloch drift remaining random confirms that crossing the threshold is not due to transient fluctuations and benign samples rarely exceed this boundary, while attack samples overwhelmingly do so, yielding a low false-negative rate under realistic operating conditions. The threshold thus provides a direct link between reconstruction-error statistics and the geometric deviations observed in Bloch-space analysis. The threshold is not optimized for classification performance but is derived solely from benign validation statistics. This choice reflects practical deployment scenarios and ensures that reported error rates correspond to *physically meaningful deviations* rather than tuned decision boundaries.

[Fig. 16](#) makes the *operational behavior* of reconstruction-error-based anomaly detection explicit, explaining the near-perfect ROC performance observed in [Fig. 6](#). The low false-negative rate demonstrates robust anomaly detection driven by persistent reconstruction deviations rather than transient fluctuations.

[Fig. 17](#) shows the confusion matrix obtained using an unsupervised threshold derived from benign validation data for the hybrid QAE (confusion matrix for the CAE is shown in [Fig. 26](#) of [Appendix B](#)). Both models exhibit nearly identical operational behavior, with extremely low false-negative rates and comparable false-positive rates. This demonstrates that the hybrid QAE model *preserves the reliability of the classical baseline* at a fixed decision boundary, while enabling additional physical diagnostics through Bloch-space analysis. Although both models achieve comparable confusion matrices at the operating threshold, *the hybrid QAE model provides additional insight into anomaly detection through Bloch-space drift analysis, which probes how anomalous inputs are encoded in the quantum latent representation*.

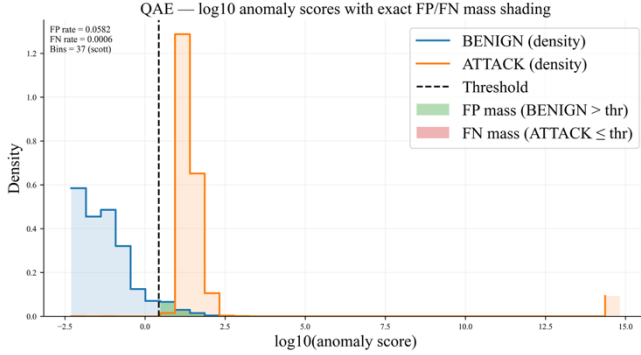

FIG 16. (Colour online) Distribution of reconstruction-error anomaly scores produced by the hybrid quantum autoencoder on the test set, shown on a logarithmic scale using Scott’s binning rule. BENIGN and ATTACK samples are plotted as probability densities. The dashed vertical line denotes the unsupervised decision threshold derived from the 95th percentile of benign validation scores. Shaded regions indicate the *exact* false-positive mass (benign samples exceeding the threshold) and false-negative mass (attack samples below the threshold).

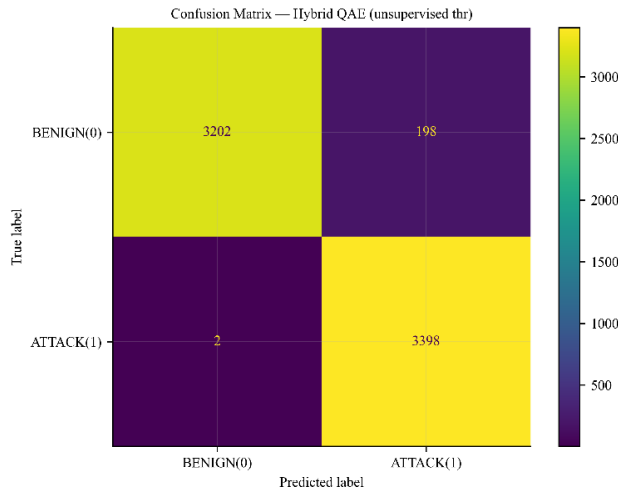

FIG 17. (Colour online). QAE Confusion matrix for anomaly detection using an unsupervised threshold (95th percentile of benign validation scores). CAE confusion matrix is shown in [Fig. 26](#) in [Appendix B](#). Both models exhibit similar operational performance with very low false-negative rates, indicating reliable detection under identical thresholding conditions.

As shown by both the CAE ([Fig. 26](#)) and hybrid QAE confusion matrices, a fixed, unsupervised operating threshold, the hybrid quantum autoencoder matches the classical baseline’s reliability while enabling physically interpretable diagnostics of anomaly-induced state changes.

The QFI spectrum of [Fig. 18](#) shows the SSDP model. The spectrum remains strictly positive across all 24 parameter directions, with trace 18.70, numerical rank 24, condition number 16.85, and  $\log \det_{\epsilon} = -11.80$ . The spectrum decays

smoothly from approximately 2.3 to 0.14 without collapsing to zero, and the mean QFI remains full rank ( $rank_{\epsilon} = 24$ ) with a moderate condition number of  $\kappa \approx 16.85$ .

### 3. Quantum Fisher Index

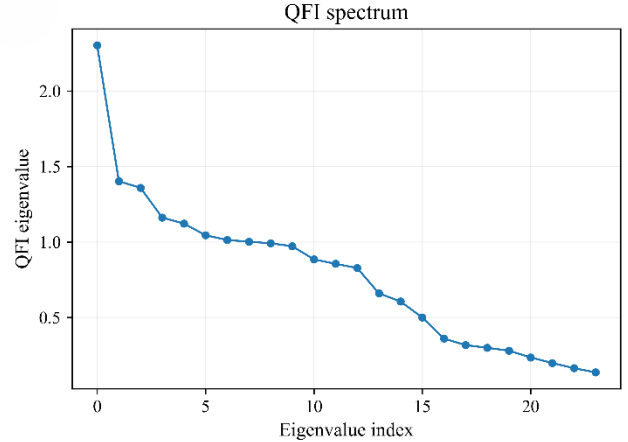

FIG 18. Quantum Fisher information (QFI) spectrum for the SSDP latent quantum model. Eigenvalues of the mean QFI matrix computed on benign validation samples for the trained hybrid quantum autoencoder. The smooth decay and full numerical rank in [Fig. 16](#) indicate a trainable latent geometry with moderate anisotropy rather than a collapsed or singular parameter manifold.

The results of [Fig. 18](#) suggest that the latent quantum circuit retains informative curvature across all trained parameter directions, rather than concentrating all sensitivity into only a few modes. In the context of variational quantum models, such a spectrum is consistent with a trainable quantum latent manifold and contrasts with the kind of degeneracy expected in strongly ill-conditioned or plateau-like regimes [66, 87, 97].

In variational quantum models, QFI characterizes local information geometry and sensitivity of the circuit parameters, and is closely related to the Bures metric [107, 113] used for state-space distinguishability [96, 97, 107, 113]. Evidence of a broad nonzero spectrum is therefore consistent with a well-conditioned latent representation, although it does not by itself rule out barren-plateau behavior at larger scales [66, 87, 97].

### 4. Geometry of the Quantum Latent Manifold

To visualize the mechanism behind quantum latent manifold definition [1, 2, 104, 105] we examine three and two-dimensional Bloch projections ([Figs. 19](#) and [20](#)) for the top-ranked qubits. In these projections, benign samples form coherent manifolds, while attack samples occupy displaced regions characterized by larger radial distance from the benign mean. Coloring points by drift magnitude reveals a

monotonic relationship between geometric displacement and anomaly score.

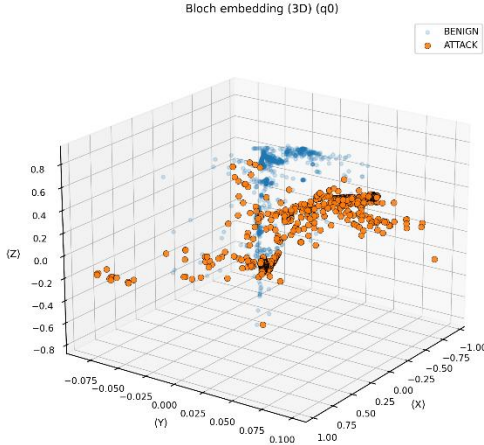

FIG 19. (Colour Online) Bloch-space trajectory of a representative qubit ( $q_0$ ) with class-coded points. Each point corresponds to the Bloch vector  $(\langle X \rangle, \langle Y \rangle, \langle Z \rangle)$  produced by the quantum latent circuit for a test sample. BENIGN samples form a coherent manifold, while ATTACK samples exhibit systematic displacement. The faint blue lines show the time-index of drift for the attack and benign data in 3-D space.

In Fig. 19, BENIGN samples form a coherent manifold, while ATTACK samples exhibit systematic displacement.

The faint blue lines show the time-index of drift for the attack and benign data in 3-D space. Figs. 18, 19 and 20 reinforce our confidence in Bloch geometry based interpretation of classical IDS data: different qubits encode anomalies with different strengths; absolute Bloch drift is geometrically meaningful; quantum latent information is distributed.

In Fig. 20, Panel annotations report the corresponding AUC (drift) and mean separation  $\|\mu_B - \mu_A\|$ . BENIGN and ATTACK samples exhibit increasing radial displacement with increasing drift, explaining the strong ROC performance observed for absolute Bloch drift. The actual numbers as code output has been depicted in Section 5 of the Appendix B. A 3-D version of this figure has been shown in Fig. 27 of Appendix B. Hence, Fig. 20 provides a *geometric interpretation* of the Bloch drift ROC results, ranked for the top three qubits. For the top-ranked qubits, anomalous samples exhibit systematic radial displacement away from the benign mean state, resulting in strong discriminative performance when drift from the benign mean is used as the anomaly score. In contrast, as shown earlier, consecutive Bloch drift does not yield discriminative power, indicating that anomaly detection arises from persistent geometric displacement rather than local state-to-state fluctuations.

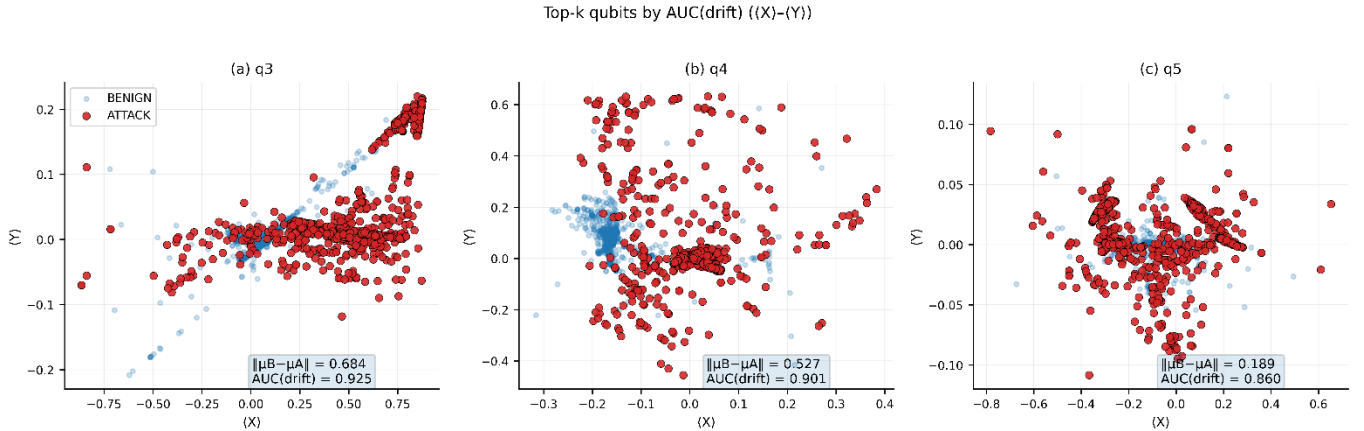

FIG 20. (Colour online) Bloch-space projections for the top-k qubits ranked by drift AUC. Two-dimensional  $\langle X \rangle - \langle Y \rangle$  projections are shown for the three qubits with the highest ROC-AUC when using Bloch drift from the benign mean as the anomaly score. Points are colored by drift magnitude  $d = \|\mathbf{r} - \mu_B\|$ , where  $\mu_B$  denotes the benign mean Bloch vector.

#### IV. CONCLUSIONS

In contrast to prior work, this study evaluates a *hybrid quantum autoencoder* [45] as a **representation-learning module** within an *unsupervised anomaly detection*

framework. We studied hybrid quantum autoencoders for intrusion detection and introduce Bloch-space drift as a geometric diagnostic of the latent quantum layer [1, 2, 101, 102, 105].

Although the graph-regularized model and the quantum autoencoder operate in different settings, we showed that they are linked by a common geometric principle: training induces structure in the learned representation space, and this structure can be probed either globally or locally. In the graph-based model, the learned geometry is captured by the Laplacian spectrum of the similarity graph, whose algebraic connectivity, spectral entropy, effective dimension, and Fiedler partition quantify mixing, coherence, and collapse. In the quantum autoencoder, the same learning-induced structure appears in the latent quantum state space, where Bloch-space drift measures persistent displacement from the benign manifold. Hence, we conclude that spectral diagnostics and Bloch diagnostics therefore provide complementary views of the same phenomenon—global spectral organization and local quantum-state deformation—yielding a unified geometric interpretation of hybrid quantum learning. *The core results that lead us to this conclusions are:*

**1. Quantum learning model:** The PQC or hybrid quantum model maps inputs to learned quantum representations:

$$x_i \mapsto h_i = f_\theta(x_i)$$

or, as in the autoencoder case,

$$x_i \mapsto \rho_i^{\text{latent}}$$

Hence, the model is not just producing predictions. It is producing a **representation manifold**.

**2. Spectral geometry:** Representations  $h_i$  gives a similarity graph:

$$W_{ij} = K(h_i, h_j), L = D - W$$

Now the learned representation manifold has a **graph geometry**. The Laplacian spectrum gives us:

- whether representations are well connected or fragmented ( $\lambda_2$ ),
- whether they occupy many effective modes or collapse to a few ( $S$ ,  $d_{\text{eff}}$ ),
- whether a dominant partition or community structure emerges (Fiedler vector  $v_2$ ).

Hence, **spectral geometry is the global description of the learned representation space**.

**3. Quantum autoencoder:** The quantum autoencoder is one concrete quantum learning model in which the latent layer itself is quantum. That means the learned manifold is not only an abstract embedding space – it is a family of quantum states:

$$\rho_i^{\text{latent}}$$

So, the central question of “How is structure encoded in the latent quantum state space?” is answered **globally** in the **graph-regularized setting** through Laplacian spectra, and **locally** through **Bloch-space trajectories** in the **QAE settings**.

**4. Bloch-space drift:** Bloch drift is then the **local geometric probe** of the latent manifold. If the latent state of a sample is represented by a Bloch vector  $r_i$ , then drift relative to the benign reference state measures how far that sample moves in quantum state space:

$$\Delta r_i = \| r_i - r^{\text{benign}} \|$$

This is the state-space analog of graph displacement. Hence, **spectral geometry** tells us how the full representation set is globally organized, and **Bloch drift** tells us how an individual sample is displaced within that learned geometry. That is the key bridge.

## A. Spectral Geometry and Bosonic Probes in Quantum Learning

Our results reveal a controlled transition between expressive and collapsed regimes in graph-coupled quantum learning, governed by a single regularization parameter. Spectral diagnostics show that collapse corresponds to the disconnection of the learned similarity graph and a reduction in effective dimensionality, rather than a trivial suppression of variance. The agreement between observed stationary variance and the theoretical prediction confirms that long-time behavior is governed by coarse-grained stochastic dynamics, independent of initialization. This provides a principled explanation for collapse and clarifies how regularization shapes representation geometry.

Crucially, learned structure is not merely an internal artifact: it manifests in edge-resolved bosonic interference patterns that align with spectral partitions of the graph. Hardware experiments demonstrate that these qualitative signatures persist despite noise, indicating that interference provides a viable physical probe of learned graph structure.

We have shown *that graph-coupled quantum learning models exhibit a regularization-controlled transition between expressive and collapsed regimes, which can be diagnosed using spectral graph tools*. A simple theoretical prediction captures the stationary representation variance, providing analytic insight into collapse. By leveraging bosonic interference as a probe, we connect learned graph structure to experimentally measurable observables and validate these connections on quantum hardware. This work establishes a bridge between learning dynamics, spectral theory, and multi-boson quantum physics.

### 1. Outlook

The edge-resolved bosonic observables introduced here suggest a natural interface between quantum interference and graph-structured learning. In particular, interference-induced modulation of edge weights parallels message weighting in classical GNNs, but arises intrinsically from unitary dynamics rather than trained parameters. This points toward *quantum graph neural network architectures* in which learning is implemented through state preparation, phase control, or measurement selection, with interference patterns serving as quantum features. While no quantum advantage is claimed, our results identify a concrete, experimentally accessible primitive that may inform future designs of quantum graph learning models.

### B. QAE for Anomaly Detection in IDS Data

We have demonstrated that anomaly detection in a hybrid quantum autoencoder arises from persistent geometric displacement in Bloch space, not from transient or unstable dynamics. By combining standard performance metrics with Bloch-space diagnostics, we provide a physically interpretable and operationally relevant analysis of quantum latent representations.

The contrast between absolute and consecutive Bloch drift reveals a key property of the quantum latent layer: **stability with structured displacement**. This behavior is inconsistent with noise-dominated or barren-plateau-like dynamics and supports the interpretation that the quantum circuit learns a stable representation of benign behavior.

Importantly, the hybrid QAE matches the classical baseline in operational performance while offering additional physical diagnostics, such as QFI unavailable in purely classical models. This interpretability is particularly valuable in applied anomaly detection, where trust and reliability are critical.

### 1. Outlook

Future work may extend Bloch-space diagnostics to other tasks such as fault detection and process monitoring, explore their relationship to quantum Fisher information and trainability [94], and evaluate robustness under realistic noise models and hardware execution. More broadly, Bloch-space analysis offers a principled framework for interpreting quantum machine-learning models in applied settings.

**Summary:** The main physical message of this work is that hybrid quantum learning is controlled by geometry at two coupled levels. At the global level, graph regularization acts on the learned similarity graph as a spectral control parameter, redistributing weight across Laplacian modes, modifying algebraic connectivity, and driving the representation manifold between an expressive, mixed regime and a collapsed low-dimensional phase. At the local level, the same transition is reflected in the latent quantum

states themselves, where Bloch-space drift reveals whether anomalous inputs induce stable manifold deformations or merely transient fluctuations. In this sense,  $\lambda_2$ ,  $v_2$ ,  $S$ , and  $d_{\text{eff}}$  are collective observables of the learned geometry, while Bloch drift is a local coordinate probe of the same structure. The broader implication is that robustness, interpretability, and failure modes in hybrid quantum models are best understood not purely through task metrics, but through the geometry of the manifolds these models learn to inhabit.

## V. REPRODUCIBILITY NOTE AND CODE AVAILABILITY

**Spectral geometry:** All data used are available within this literature. While the implementation code is not publicly archived at the time of submission because portions of it contain protected intellectual property and proprietary methods, all graph generation procedures, kernel definitions, loss functions, and analysis routines are described in sufficient detail to enable independent reproduction. Access to the code may be granted by the corresponding author upon reasonable request, where permitted by applicable intellectual-property restrictions and subject to appropriate agreements. The dataset used for the **QAE study** is publicly available at:

<https://www.unb.ca/cic/datasets/ids-2018.html> [98, 99].

**Code Availability:** All splits and preprocessing procedures are fully reproducible and are *made available* in the accompanying code repository. The numerical simulations and analysis routines used to generate the reported figures were implemented in standard scientific computing libraries. The intrusion detection experiments were conducted using publicly available network traffic datasets containing labeled denial-of-service (DoS) events. All preprocessing steps, feature selection procedures, and train-test splits are described in Sec. II and the Appendix B to ensure reproducibility. No proprietary or confidential data were used. Processed data subsets and evaluation scripts are available from the authors upon reasonable request.

## VI. ETHICS AND COMPLIANCE

This study involves synthetic graph simulations and publicly available cybersecurity datasets. No human subjects, personal medical information, or personally identifiable data were used. The work complies with the usage and redistribution policies of the referenced datasets and adheres to applicable research ethics standards.

## VII. APPENDIX A: BOSONIC PROBES IN SPECTRAL GEOMETRY

### A. Cost Function for Spectral Geometry

Learning is governed by a cost functional  $C[s]$  given by

$$C[s] = C_{\text{SL}}[s] + \lambda_G \sum_{(u,v) \in E} A_{uv} \| \mathbf{h}_u(s) - \mathbf{h}_v(s) \|_2^2 + \lambda_R C_{\text{reg}}[s]$$

with

$$C_{\text{SL}}[s] = \sum_{u \in \mathcal{K}_{\text{SL}}} \ell(\hat{y}_u(s), y_u)$$

and,

$$C_{\text{graph}}(\theta) = \sum_{(i,j) \in E} w_{ij} \| f_\theta(x_i) - f_\theta(x_j) \|^2$$

Here,  $\| \mathbf{h}_u(s) - \mathbf{h}_v(s) \|_2^2$  is the **squared Euclidean distance** between the representations of nodes  $u$  and  $v$  at training time  $s$ . If each representation is a  $d$ -dimensional vector,

$$h_u(s), h_v(s) \in \mathbb{R}^d,$$

Then,  $\| h_u(s) - h_v(s) \|_2^2 = \sum_{\alpha=1}^d (h_{u,\alpha}(s) - h_{v,\alpha}(s))^2$ .

Therefore, in the cost,

$$C[s] = C_{\text{SL}}[s] + \lambda_G \sum_{(u,v) \in E} A_{uv} \| h_u(s) - h_v(s) \|_2^2 + \lambda_R C_{\text{reg}}[s],$$

this term measures **how different neighbouring node embeddings are**. This is the standard graph-Laplacian regularization term:

- If  $u$  and  $v$  are connected and  $A_{uv}$  is large, the loss penalizes them for being far apart.
- Minimizing this term encourages **smoothness over the graph**: nearby/related nodes get similar representations.

Overall:

- $h_u(s)$ : learned output for node  $u$  at step  $s$
- $h_v(s)$ : learned representation/output for node  $v$
- $\| h_u - h_v \|_2^2$ : “disagreement” between them

If the representation is scalar,  $h_u(s) \in \mathbb{R}$ , then it is just  $\| h_u(s) - h_v(s) \|_2^2 = (h_u(s) - h_v(s))^2$ . If all nodes are represented into a matrix  $H(s)$ , then this graph term becomes equivalent to

$$\sum_{(u,v) \in E} A_{uv} \| h_u - h_v \|_2^2 \propto \text{Tr}(H^\top L H),$$

where  $L = D - A$  is the graph Laplacian as in Equation 4.

### B. Theorem A1: Graph Regularization and Spectral Geometry

Consider a quantum learning model with output similarity graph  $G$  whose Laplacian is  $L$ , and training objective augmented by graph regularization parameter  $\gamma < 0$ . Let  $\tilde{L}$  denote the post-training Laplacian of the learned output graph. Then, for sufficiently small training step size  $\epsilon$  and in the non-collapsed regime, the following hold:

1. The algebraic connectivity satisfies

$$\lambda_2(\tilde{L}) \geq \lambda_2(L)$$

i.e., graph regularization does not decrease global connectivity.

2. The spectral entropy

$$S = -\sum_k p_k \log p_k, p_k = \frac{\lambda_k}{\sum_j \lambda_j}$$

increases relative to the baseline,  $S_{\text{post}} \geq S_{\text{pre}}$

provided the training dynamics remain above the variance collapse threshold.

3. In the strong-coupling limit  $|\gamma| \rightarrow \infty$ , spectral entropy decreases and the system enters a low-dimensional collapsed phase characterized by  $\lambda_2 \rightarrow 0$ .

This theorem formalizes [Figs 5 & 7](#):

- Moderate negative  $\gamma$ : indicates increased mixing and effective dimension.
- Strong negative  $\gamma$ : collapse.
- The heatmap and spectral plots of [Fig 10](#) and [Fig. 8](#).

### C. Hardware noise modeling

To contextualize hardware results, we compare experimental energies against two simulator baselines. This model incorporates gate-dependent depolarizing noise, asymmetric readout errors, and  $T_1/T_2$  relaxation during idle periods, but neglects correlated, non-Markovian, and leakage effects. As such, the noisy-Aer baseline provides a lower-bound estimate of hardware noise and is not expected to fully reproduce experimental behavior. A breakdown of noise sources included in the simulator and present on hardware is provided in Table AI.

Table AI. Components of the Aer noise budget model

Noise Source	Included in Aer	Included in Hardware	Notes
Finite sampling	✓	✓	2000 shots per circuit
Single-qubit gate error	✓	✓	Depolarizing approximation
Two-qubit gate error	✓	✓	Calibrated CZ error rates
Readout error	✓	✓	Asymmetric bit-flip model
$T_1 / T_2$ relaxation	✓	✓	During idle periods
Crosstalk	X	✓	Not modeled in Aer
Non-Markovian drift	X	✓	Calibration-time dependent
Leakage	X	✓	Outside computational subspace

An *ideal* baseline is obtained from noiseless sampling of the same logical circuit, isolating finite-shot effects. A *noisy* baseline is generated using the Aer simulator with a noise model constructed from device calibration data via `NoiseModel.from_backend`. While more detailed noise models are possible, they require assumptions about correlated and time-dependent processes that are not independently calibrated. We therefore restrict to a standard calibration-derived noise model.

*Interpretation of noise modeling:* The noisy-Aer baseline is not intended as a faithful predictor of instantaneous hardware behavior. Instead, it serves as a diagnostic reference that reproduces first-order error channels inferred from calibration data. Discrepancies between noisy-Aer and hardware results are expected due to temporal calibration drift, correlated errors, control imperfections, and non-

Markovian dynamics. This interpretation is consistent with prior benchmarking studies of NISQ-era devices.

This noise modelling definition, in conjunction with Fig. 22, and the hardware-simulator results in Fig. 10 and Fig. 11, shows that backend choice impacts both micro-level expectation evaluation and macro-level training throughput. Qiskit dense implementation achieves lower per-epoch runtime with reduced variance, enabling more efficient large-scale training and hyperparameter sweeps.

Fig. 21 below demonstrates the following: The first eigenvalue is essentially zero, as expected for a graph Laplacian and the second eigenvalue is very small, about  $\lambda_2 \approx 0.02$ , which means the pre-training fidelity graph is only weakly connected: there is a soft bottleneck or near-partition already present in the graph. After that, the spectrum rises steadily:  $\lambda_3 \sim 0.21$ ,  $\lambda_4 \sim 0.35$ ,  $\lambda_5 \sim 0.57$  and then enters a broad bulk around 0.85–1.3.

a. Pre-Training Laplacian (Fidelity Graph)

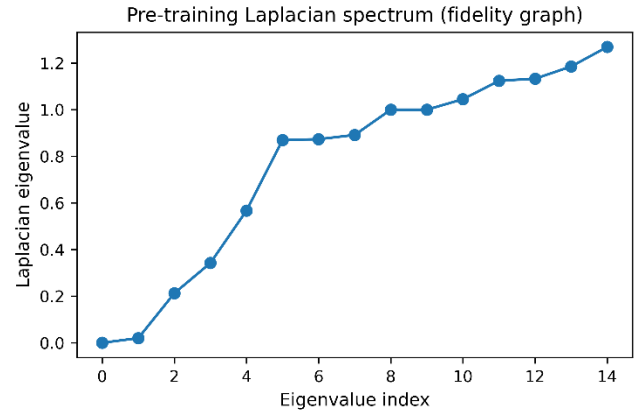

FIG 21. (Colour online) *Pre-training Laplacian spectrum of the fidelity graph*. The spectrum exhibits the expected trivial zero mode and a single weakly nonzero algebraic-connectivity mode,  $\lambda_2 \approx 0.02$ , indicating that the initial graph is connected but only weakly so. The remaining eigenvalues rise gradually into a broad bulk, revealing a geometry dominated by one soft large-scale partition. This spectrum provides the natural geometric baseline against which learning-induced spectral restructuring is assessed.

In Fig. 21, the combination of one exact zero mode, one very small nonzero mode, and a broad higher-mode bulk means that the *dominant large-scale structure is controlled by a single weak partition* (the Fiedler mode), while most remaining modes are already relatively stiff. In graph terms, this suggests:

- the fidelity graph is not collapsed,
- but it is not strongly mixed either,

- and its geometry is dominated by a principal spectral cut rather than by many competing communities.

We argue that this is the correct *pre-training baseline* against which the learned graph should be compared. If training is effective, expectation would be that the low end of the spectrum to *open up*, especially  $\lambda_2$ , indicating stronger global connectivity. If training collapses, then instead,  $\lambda_2 \rightarrow 0$ , signalling fragmentation or degeneracy. Because the pre-training graph already has a small  $\lambda_2$ , the *Fiedler vector is meaningful from the start*, and learning can either sharpen or reorganize that partition. This also explains the *bosonic observable*  $\Delta P_{in}$  that can correlate with the *Fiedler split*: the graph already has a latent low-frequency structural direction for interference to probe.

The pre-training Laplacian spectrum of the fidelity graph exhibits a single near-zero nontrivial eigenvalue,  $\lambda_2 \approx 0.02$ , followed by a broad bulk of higher modes. This indicates that the initial graph is connected but only weakly so, with a dominant low-frequency partition and limited large-scale mixing. The spectrum therefore provides a natural geometric baseline against which learning-induced restructuring, spectral spreading, and bosonic interference signatures can be assessed. Compared with the pre-training fidelity graph, the learned output-similarity graph of Fig. 9, after training exhibits a pronounced opening of the low end of the spectrum: the algebraic connectivity increases from  $\lambda_2 \approx 0.02$  to  $\lambda_2 \approx 0.19$ , while the next mode shifts from  $\lambda_2 \approx 0.21$  to  $\lambda_3 \approx 0.86$ . At the same time, the higher part of the spectrum compresses toward an approximately flat plateau near unity, indicating that training suppresses weak bottlenecks and reorganizes the graph into a more uniformly mixed but still spectrally structured geometry. In physical terms, learning converts a weakly connected initial fidelity graph into a significantly more coherent output graph, providing the spectral basis for the edge-resolved bosonic interference signatures discussed later.

#### a. End-to-end efficiency comparison

As mentioned in Methods section, to assess the practical impact of different expectation-value backends on training throughput, we measured the average wall-clock time per training epoch (mean  $\pm$  standard deviation) using two implementations: (i) a QuTiP-based dense statevector workflow and (ii) a Qiskit-based dense expectation evaluation. This is exhibited in Fig. 22.

Fig. 22, along with the hardware-simulator results in Fig. 10 and Fig. 11, shows that backend choice impacts both micro-level expectation evaluation and macro-level training throughput. The Qiskit dense implementation achieves lower per-epoch runtime with reduced variance, enabling more efficient large-scale training and hyperparameter sweeps.

This difference reflects reduced Python overhead and tighter integration of expectation evaluation within the Qiskit workflow, and motivates our choice of backend for large-scale sweeps.

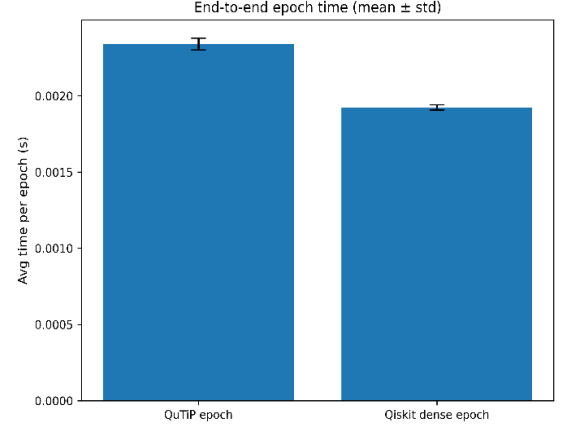

FIG 22. (Colour online) *End-to-end training epoch time for different dense simulators*. Average wall-clock time per training epoch (mean  $\pm$  standard deviation) comparing a QuTiP-based dense statevector implementation and a Qiskit dense expectation workflow.

#### D. Fiedler vector Output

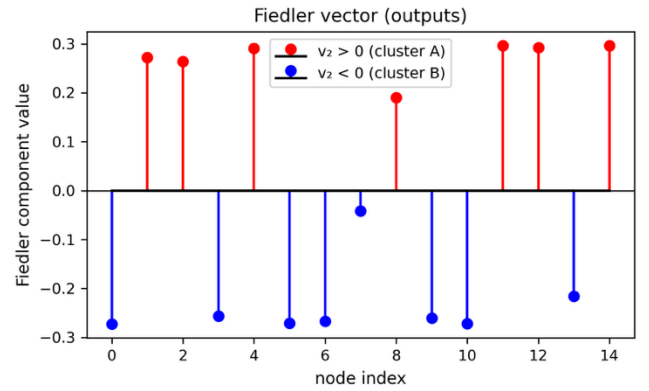

FIG 23. (Colour online) *Fiedler vector  $v_2$  of the learned output-similarity Laplacian after training*. 15-Nodes partition into two coherent communities according to the sign of  $v_2$  (red:  $v_2 > 0$  and blue:  $v_2 < 0$ ), with comparable magnitudes indicating a well-defined principal cut.

(Ref: [Theorems 1](#), and [2](#))

Let  $v_2$  be the **Fiedler vector** [24] (the eigenvector associated with  $\lambda_2$ ) of the learned output graph Laplacian.

1. The **sign of  $v_2^{(i)}$**  assigns node  $i$  to one side of the **minimum-energy spectral cut**.

- When  $\lambda_2$  is small, this cut corresponds to an **almost-disconnected partition** of the graph.

Hence, if  $v_2$  denotes the Fiedler vector of the graph Laplacian, then in the regime where the learned geometry is dominated by the second eigenmode,

$$\text{corr}(\Delta P_{uv}, |v_2(u) - v_2(v)|) < 0$$

i.e., edges crossing the principal spectral partition exhibit systematically enhanced (negative) interference. This is depicted in Fig. 23. This learned spectral bipartition underlies the edge-resolved bosonic enhancement  $\Delta P_{uv}$ , which scales with the inter-cluster split  $|\Delta v_2|$ , linking spectral geometry directly to interference observables. The plotted Fiedler vector  $v_2$  of the learned output-similarity graph shows a clear **bipartite partition**: nodes separate cleanly into two clusters according to the sign of  $v_2$ , with large magnitude components ( $|v_2| \approx 0.25 - 0.30$ ) indicating strong participation in opposite sides of the principal cut. Only one node (around index 7–8) has a relatively small magnitude, suggesting it lies near the spectral boundary between communities. Some key observations are:

- Strong spectral separation:** The magnitudes are relatively uniform within each sign group, implying a well-defined global cut rather than a noisy or weak partition. This is consistent with the relatively large algebraic connectivity  $\lambda_2$  seen in the spectrum.
- Two coherent output clusters:** The sign structure indicates that graph regularization has reorganized the learned outputs into two macroscopically coherent communities. This is not a random partition: the symmetry of magnitudes suggests collective structure induced during training.
- Alignment with bosonic probe:** In our bosonic-interference analysis, edge-level enhancement  $\Delta P_{uv}$  correlates with  $|\Delta v_2|$ . Edges connecting nodes across opposite-sign clusters (large  $|\Delta v_2|$ ) exhibit the strongest interference signatures. Thus, this vector provides the *spectral backbone* underlying the interference plot.
- Relation to Proposition–Theorem structure:**
  - Proposition:** Spectral entropy increases and effective dimension expands.
  - Theorems 1 & 2:** Graph coupling modifies the Laplacian spectrum. Bosonic interference is proportional to edge-resolved spectral splitting.

*Summary:* this figure visualizes the principal learned spectral cut that governs both effective dimension and interference structure.

## VIII. APPENDIX B: BLOCH SPACE GEOMETRY FOR ANOMALY DETECTION

Recent theoretical work has established a close connection between the quantum Fisher information (QFI) [17, 96, 97, 105, 113] and the trainability of variational quantum circuits. In particular, circuits exhibiting vanishing quantum Fisher information with respect to their parameters are known to suffer from barren plateaus, characterized by exponentially small gradients and ineffective optimization [87, 88]. From an information-geometric perspective, a low QFI [17] implies that infinitesimal parameter changes produce only negligible state distinguishability, corresponding to locally flat regions of the quantum state manifold. Conversely, circuit architectures that maintain non-vanishing QFI define latent manifolds with richer local geometry and improved sensitivity to parameter variations. While the present work does not explicitly measure QFI during training, the observed stability of the hybrid quantum autoencoder suggests that the employed shallow, structured circuit avoids severe barren plateau behavior, thereby preserving both trainability and representational effectiveness. This observation aligns with recent findings that problem-inspired ansätze and limited circuit depth can mitigate barren plateaus in practical hybrid quantum learning models.

### A. Theorem B1: Bloch Representation and Drift Induced by the Quantum Latent Circuit

Let  $x \in \mathbb{R}^d$  denote an input feature vector after classical preprocessing. The quantum circuit in Fig. 5 implements a parameterized unitary

$$U(\theta, x) = U_L(\theta_L)U_E \cdots U_1(\theta_1)U_E U_{\text{enc}}(x)$$

where  $U_{\text{enc}}(x)$  denotes angle embedding,  $U_\ell(\theta_\ell)$  are trainable single-qubit rotations, and  $U_E$  represents the ring entanglement layer. The circuit prepares the quantum state

$$|\psi(x)\rangle = U(\theta, x)|0\rangle^{\otimes n}$$

For each qubit  $q$ , we define the associated **Bloch vector**

$$\mathbf{r}^{(q)}(x) = \begin{pmatrix} \langle \psi(x) | X_q | \psi(x) \rangle \\ \langle \psi(x) | Y_q | \psi(x) \rangle \\ \langle \psi(x) | Z_q | \psi(x) \rangle \end{pmatrix}$$

which provides a geometric representation of the reduced single-qubit state induced by the full entangled circuit.

**Absolute Bloch Drift (Geometry-Based Anomaly Score):** To quantify anomaly-induced displacement [96, 108–111], we compute the **benign mean Bloch vector** for each qubit,

$$\boldsymbol{\mu}_B^{(q)} = \mathbb{E}_{x \sim \text{BENIGN}} [\mathbf{r}^{(q)}(x)]$$

and define the **Bloch drift magnitude**

$$d^{(q)}(x) = \|\mathbf{r}^{(q)}(x) - \boldsymbol{\mu}_B^{(q)}\|_2$$

These metric measures **absolute geometric displacement** in the quantum state space induced by the circuit and forms the basis of the Bloch-drift ROC analysis in the main text.

**Consecutive Bloch Drift (Stability Diagnostic):** To assess local stability, we additionally define the **consecutive Bloch drift**

$$\Delta^{(q)}(x_t) = \|\mathbf{r}^{(q)}(x_{t+1}) - \mathbf{r}^{(q)}(x_t)\|_2$$

which quantifies state-to-state variation across adjacent samples. As shown in [Figs. 13 & 14](#), consecutive Bloch drift yields near-random classification performance ( $\text{AUC} \approx 0.5$ ), indicating that the circuit produces smooth, stable embeddings and that anomaly detection arises from global geometric displacement rather than local dynamical fluctuations.

## B. Theorem B2: (Geometric Separation by Absolute Drift under Stable Embeddings)

Let  $U(\theta, x)$  be a parameterized quantum circuit preparing a pure state

$$|\psi(x)\rangle = U(\theta, x)|0\rangle^{\otimes n}$$

and let  $\mathbf{r}^{(q)}(x) \in \mathbb{R}^3$  denote the Bloch vector of qubit  $q$ .

We define:

- i. The benign mean Bloch vector as:

$$\boldsymbol{\mu}_B^{(q)} = \mathbb{E}_{x \sim \mathcal{D}_B} [\mathbf{r}^{(q)}(x)]$$

- ii. The absolute Bloch drift:

$$d^{(q)}(x) = \|\mathbf{r}^{(q)}(x) - \boldsymbol{\mu}_B^{(q)}\|_2$$

- iii. The consecutive Bloch drift:

$$\Delta^{(q)}(x_t) = \|\mathbf{r}^{(q)}(x_{t+1}) - \mathbf{r}^{(q)}(x_t)\|_2$$

Assumptions:

1. The embedding map  $x \mapsto \mathbf{r}^{(q)}(x)$  is locally Lipschitz continuous:

$$\|\mathbf{r}^{(q)}(x) - \mathbf{r}^{(q)}(x')\|_2 \leq L \|x - x'\|$$

2. Benign samples concentrate in a region  $\mathcal{M}_B$  of Bloch space with bounded variance.

Then, if attack samples satisfy

$$\|\mathbb{E}_{x \sim \mathcal{D}_A} [\mathbf{r}^{(q)}(x)] - \boldsymbol{\mu}_B^{(q)}\|_2 > \delta$$

for some  $\delta > 0$ , absolute Bloch drift yields separability proportional to  $\delta$ . Under the same stability condition, consecutive drift satisfies

$$\mathbb{E}[\Delta^{(q)}] \leq L \mathbb{E}[\|x_{t+1} - x_t\|]$$

and therefore, does not separate classes unless instability is present.

### Corollary (Relation to Quantum Fisher Information)

If the circuit family  $U(\theta, x)$  induces a non-vanishing local quantum Fisher information metric  $F(x)$ , then the Bloch embedding has bounded curvature and satisfies the Lipschitz condition above. In contrast, vanishing QFI (barren plateau regime) implies either flat embeddings or noise-dominated behavior, degrading discriminative power.

#### 1. Quantum Fisher Information

[Fig. 24](#) below shows the statistics of the QFI of [Fig. 17](#).

```
{'trace': 18.70368402468995,
 'logdet_eps': -11.804531976262552,
 'condition_number': 16.85258588603441,
 'rank_eps': 24}
```

Fig. 24. Quantum Fisher information (QFI) statistics for the spectrum in [Fig. 18](#).

The numbers in [Fig. 24](#) can be interpreted as follows:

- I. Trace = 18.70: total QFI curvature / total parameter sensitivity, measuring the overall sensitivity of the latent circuit to parameter changes.
- II.  $\text{rank}_\varepsilon = 24$ : all 24 parameter directions are numerically active. This is the effective number of numerically active QFI directions above threshold  $\varepsilon$ , indicating whether the geometry is full-dimensional or partially collapsed.
- III. Condition number = 16.85: the geometry is anisotropic, but not severely ill-conditioned. This gives the ratio of the largest to smallest active QFI

eigenvalues, measuring how anisotropic or ill-conditioned the latent geometry is.

- IV.  $\log \det_{\epsilon} = -11.80$ : volume-like summary of the effective local parameter manifold; more negative values indicate a smaller effective geometric volume.

The regularized log-determinant of the QFI matrix,  $\log \det_{\epsilon}(F) = -11.80$ , indicates a finite but non-collapsed local information volume, consistent with a full-rank and moderately anisotropic latent geometry. The QFI spectrum provides a trainability diagnostic for the learned latent circuit rather than a direct traffic feature. Its full numerical rank indicates that all variational parameters contribute nontrivially to the local state geometry, while the moderate spread of eigenvalues suggests anisotropy but not singular collapse. The leading eigenmodes capture the most sensitive latent directions, whereas the nonzero tail indicates that lower-curvature modes still remain active. This is important because barren plateaus arise when gradients become exponentially suppressed and effective trainability collapses [45]. Moreover, entanglement-driven plateau behavior has been linked to excessive latent-state mixing and loss of useful optimization structure [112]. Accordingly, the SSDP QFI spectrum is best interpreted as evidence that the trained circuit remains in a usable, information-rich regime, although stronger claims about the absence of plateau behavior should also be supported by gradient-variance scaling and local-entropy diagnostics [45, 112].

The *trace* of the QFI matrix summarizes the total local sensitivity (or total curvature) of the latent circuit, with larger values indicating more overall parameter responsiveness. The *condition number* measures how unevenly that sensitivity is distributed across directions, while *rank* $_{\epsilon}$  counts the number of eigenmodes that remain numerically active above a small threshold  $\epsilon$ ; together, these quantities distinguish a full-rank but anisotropic latent geometry from a collapsed or nearly singular one.

#### a. Evaluation Metrics

Model performance was evaluated using threshold-free ranking metrics and fixed-threshold operational diagnostics.

**Ranking Metrics:** The receiver operating characteristic (ROC) curve evaluates discrimination across all possible thresholds. The ROC-AUC is defined as

$$\text{AUC} = \Pr(s(x_A) > s(x_B))$$

where  $s(x)$  is the anomaly score,  $x_A \sim \mathcal{D}_A$  is an attack sample, and  $x_B \sim \mathcal{D}_B$  is a benign sample.

**Fixed-Threshold Metrics:** A fixed operational threshold  $\tau$  was defined as the 95<sup>th</sup> percentile of benign validation scores. At this threshold, predictions are given by

$$\hat{y}(x) = \begin{cases} 1 & \text{if } s(x) > \tau, \\ 0 & \text{otherwise.} \end{cases}$$

The false-positive and false-negative rates are

$$\text{FP}(\tau) = \Pr_{\mathcal{D}_B}[s > \tau], \text{FN}(\tau) = \Pr_{\mathcal{D}_A}[s \leq \tau].$$

#### b. Multi-qubit Bloch Embeddings

The following Fig. 25 verifies that *the anomaly signal across the quantum register is distributed*. Different qubits show complementary displacements, no single qubit trivially encodes everything and supports our claim of a **distributed quantum latent representation**.

The trajectory in Fig. 25 provides a geometric explanation for the ROC results in Fig. 13 and 14, showing that anomalies are encoded as persistent displacement in Bloch space rather than as local state-to-state fluctuations

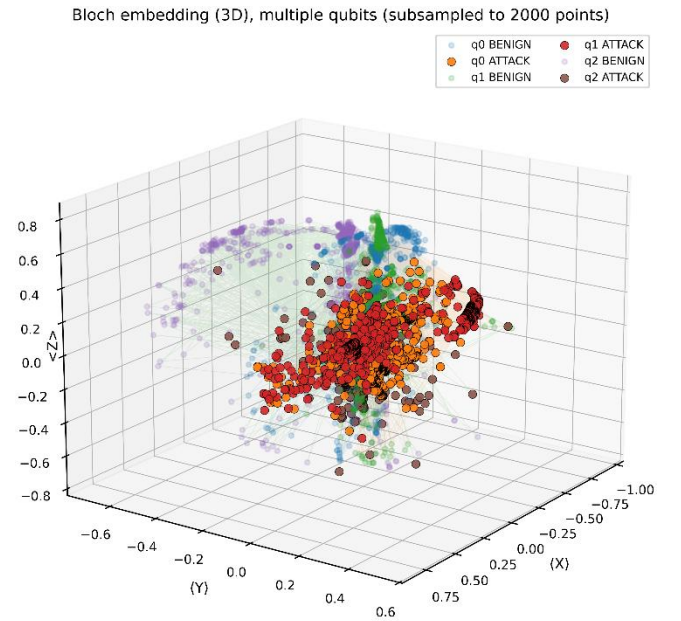

FIG 25. (Colour online) Three-dimensional Bloch-space embeddings for multiple qubits in the quantum latent circuit. Different qubits exhibit complementary class-dependent displacement, indicating that anomaly-related information is distributed across the quantum register rather than localized to a single qubit.

#### c. Classical Autoencoder Confusion Matrix

Fig. 26 shows the classical AE confusion matrix referenced in the Quantum AE counterpart in Fig. 17. Both the classical autoencoder and the hybrid QAE achieve near-perfect ROC-AUC and average precision, indicating strong global

separability between benign and attack traffic. Confusion matrices at the unsupervised threshold show extremely low false-negative rates and comparable false-positive rates.

The absence of class-dependent consecutive Bloch drift is consistent with non-vanishing local quantum Fisher information (Fig. 18), which is necessary for trainable variational circuits and incompatible with barren plateau behavior.  $AUC \approx 0.5$  (Fig. 13) for consecutive Bloch drift is evidence of embedding stability and non-chaotic quantum representations.

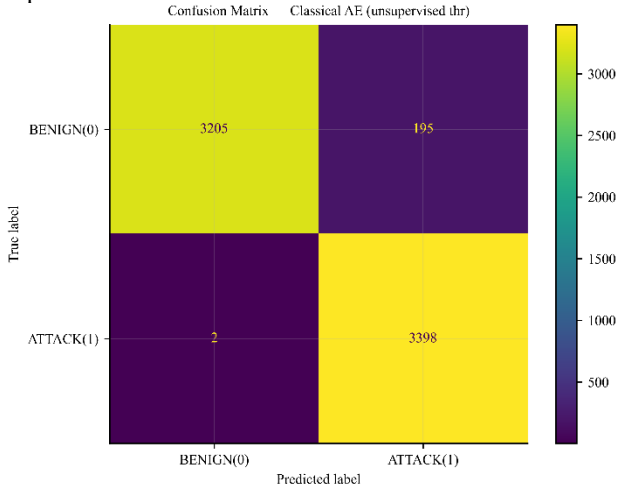

FIG. 26. (Colour online) CAE Confusion matrix for anomaly detection using an unsupervised threshold (95th percentile of benign validation scores).

d. Bloch-Drift rankings based on AUC

Fig. 27 lists the experimental numerical findings of the Bloch drift rankings obtained to produce the Figs. 20 and 28.

```
[{'qubit': 3,
  'auc_drift': 0.924546,
  'mean_dist_3d': 0.6836375857347943,
  'drift_mean_b': 0.2977323123354688,
  'drift_mean_a': 0.73176613457351176},
 {'qubit': 4,
  'auc_drift': 0.90091,
  'mean_dist_3d': 0.526781674752697,
  'drift_mean_b': 0.2746576742627232,
  'drift_mean_a': 0.5608653495314148},
 {'qubit': 5,
  'auc_drift': 0.860332,
  'mean_dist_3d': 0.18856567429156768,
  'drift_mean_b': 0.2390556485574683,
  'drift_mean_a': 0.4643101761251353},
 {'qubit': 0,
  'auc_drift': 0.850526,
  'mean_dist_3d': 0.4208261241015872,
  'drift_mean_b': 0.2651850801180335,
  'drift_mean_a': 0.47976640542016813},
 {'qubit': 2,
  'auc_drift': 0.847032,
  'mean_dist_3d': 0.5048182431256816,
  'drift_mean_b': 0.32854502154682275,
  'drift_mean_a': 0.5257945215248212},
 {'qubit': 1,
  'auc_drift': 0.761857,
  'mean_dist_3d': 0.32540209773349554,
  'drift_mean_b': 0.3516183044714488,
  'drift_mean_a': 0.5410510895366899}]
```

FIG. 27. Bloch drift rankings

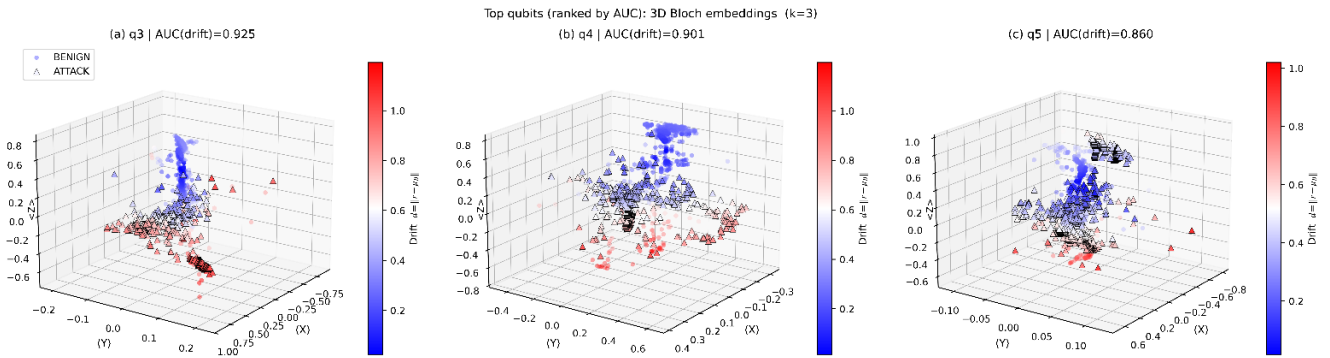

FIG 28. (Colour online) 3-D view of benign and attack traffic per qubit class, ranked by AUC scores, as a mirror to the 2-D analysis of Fig. 20.

Next, in Appendix C we share the main model pipelines for the Hamiltonian in the spectral geometry (Fig. 29) and the QAE in the DDoS data analysis (Fig. 30).

## IX. APPENDIX C: MODEL PIPELINES

### A. Hamiltonian model pipeline for spectral analysis

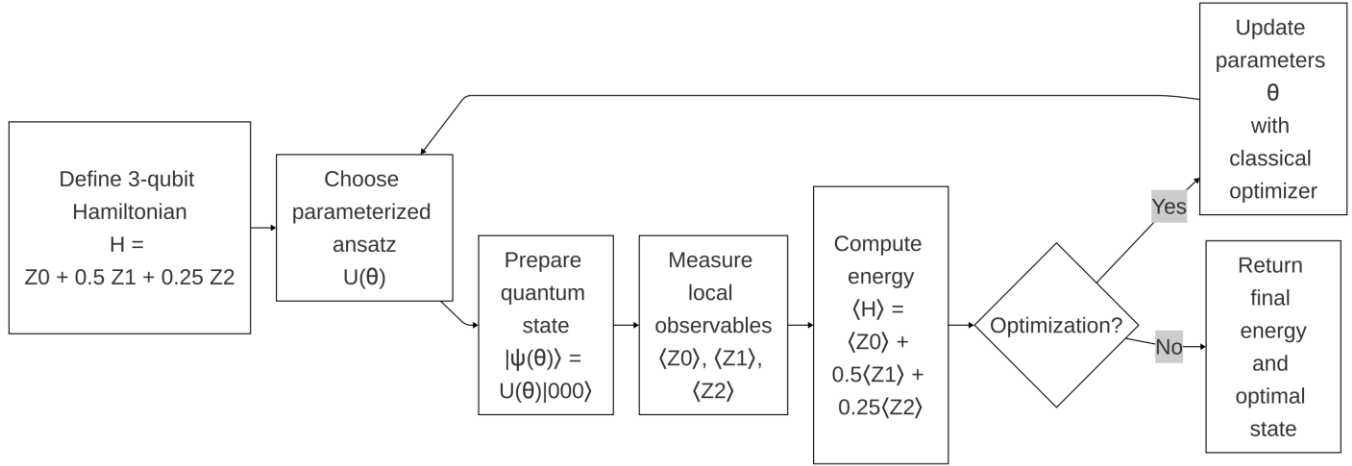

FIG. 29. *Graph-regularized quantum learning architecture.* Input samples are processed by a variational quantum circuit and measured to produce embeddings  $f_\theta(x_i)$ , from which a similarity graph  $W$  is constructed. Training minimizes a supervised objective augmented by a graph-smoothness penalty, while the learned graph is analyzed through Laplacian-based spectral geometry. The resulting representations are probed using bosonic edge interference  $\Delta P_{uv}$  and Bloch-space drift  $\Delta r$ , linking learned structure to physically interpretable observables.

## B. Model pipeline for quantum autoencoder for DDoS data

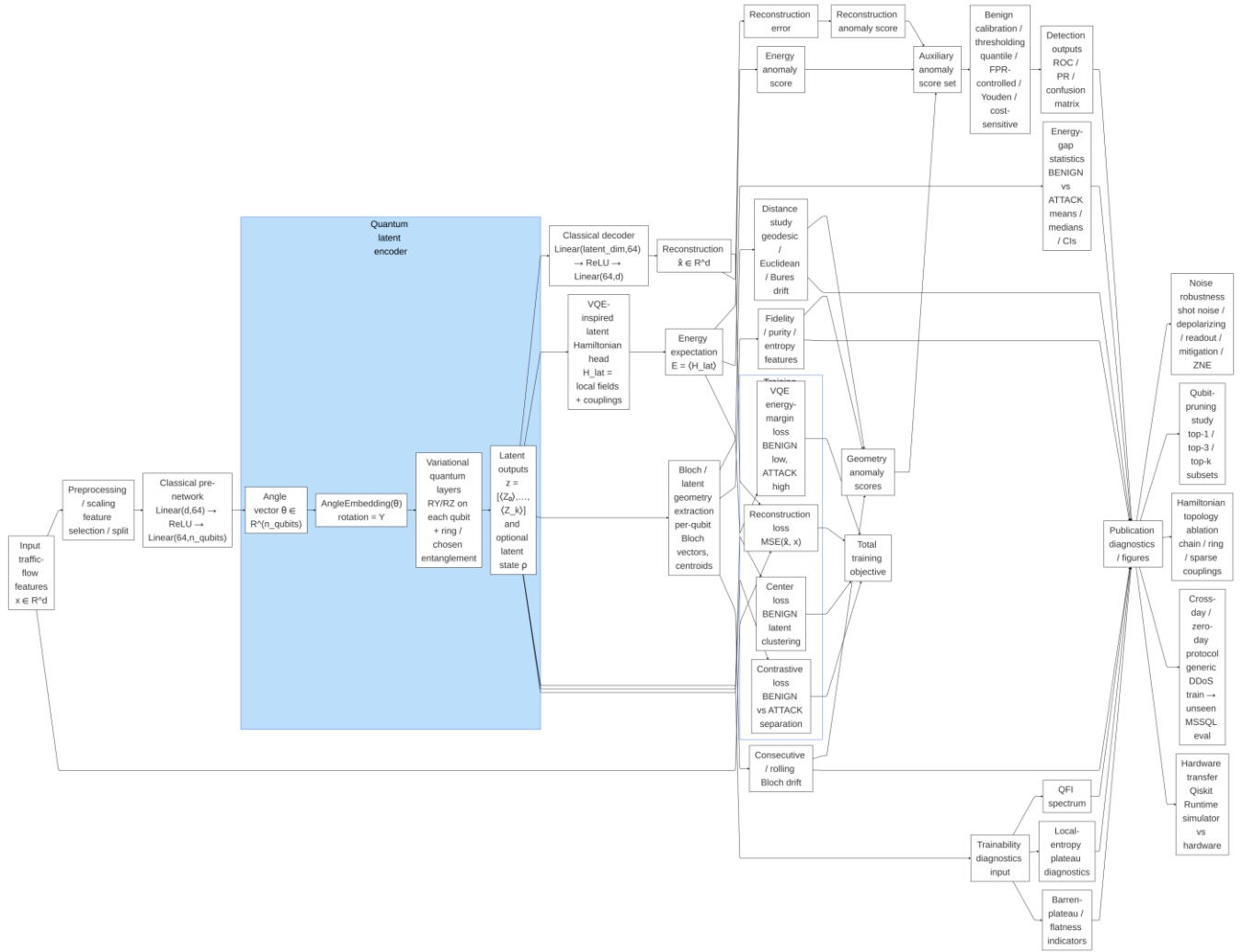

FIG. 30. (Colour online) Full model architecture of the extended hybrid classical–quantum autoencoder for DDoS anomaly detection. Flow-level traffic features are preprocessed and mapped by a classical front end to circuit angles, which are embedded in a variational quantum latent encoder. The resulting latent representation supports reconstruction, a VQE-inspired latent-energy head, Bloch-geometry and drift diagnostics, fidelity/purity/entropy analysis, and QFI/local-entropy trainability diagnostics, thereby enabling reconstruction-, geometry-, energy-, and trainability-based anomaly assessment within a unified framework.

## References

1. C. H. Valahu, M. P. Stafford, Z. Huang, V. G. Matsos, M. J. Millican, T. Chalermputitarak, N. C. Menicucci, J. Combes, B. Q. Baragiola, and T. R. Tan, Quantum-Enhanced Multiparameter Sensing in a Single Mode, *Science Advances* 11, (2025).
2. G. S. Hartnett, D. Kielpinski, S. Maity, P. S. Mundada, Y. Baum, and M. R. Hush, *Automated discovery of heralded ballistic graph state generators for fusion-based photonic quantum computation*, arXiv:2508.16505v1 [quant-ph] (2025), last accessed 2026/02/01.

3. H. Yamauchi, S. Kanno, Y. Sato, H. Tezuka, Y.-A. Shimada, E. Kaminishi, and N. Yamamoto, Quantum spectroscopy of topological dynamics via a supersymmetric Hamiltonian, arXiv:2511.23169 [quant-ph] (2025), last accessed 2026/03/25.
4. G. Aleksandrowicz *et al.*, “Qiskit: An Open-source Framework for Quantum Computing,” Zenodo (2019), <https://doi.org/10.5281/zenodo.2562111>.
5. S. Aaronson and A. Arkhipov, “The computational complexity of linear optics,” *Theory Comput.* **9**, 143 (2013)
6. A. Abbas *et al.*, “The power of quantum neural networks,” *Nat. Comput. Sci.* **1**, 403 (2021), <https://doi.org/10.1038/s43588-021-00084-1>.
7. A. Björklund, J. Mäkelä, and K. Puolamäki, *SLISEMAP: Supervised Dimensionality Reduction through Local Explanations*, *Machine Learning* **112**, 1 (2022).
8. J. B. Spring *et al.*, *Boson Sampling on a Photonic Chip*, *Science* **339**, 798 (2013).
9. J. Biamonte *et al.*, “Quantum machine learning,” *Nature* **549**, 195 (2017), <https://doi.org/10.1038/nature23474>.
10. A. M. Bishop, *Pattern Recognition and Machine Learning* (Springer, New York, 2006)
11. K. M. Borgwardt, H.-P. Kriegel, S. V. N. Vishwanathan, and N. N. Schraudolph, “Graph Kernels for Disease Outcome Prediction from Protein-Protein Interaction Networks,” in *Pacific Symposium on Biocomputing* **12**, 4–15 (2007), [https://doi.org/10.1142/9789812772435\\_0002](https://doi.org/10.1142/9789812772435_0002)
12. M. M. Bronstein, J. Bruna, Y. LeCun, A. Szlam, and P. Vandergheynst, “Geometric deep learning: going beyond Euclidean data,” *IEEE Signal Process. Mag.* **34**, 18 (2017), <https://doi.org/10.1109/MSP.2017.2693418>.
13. A. J. Bray, “Theory of phase ordering kinetics,” *Adv. Phys.* **43**, 357 (1994)
14. Bauer *et al.*, “Qiskit Aer: High-performance quantum circuit simulators,” arXiv:2108.08870, <https://doi.org/10.48550/arXiv.2108.08870>.
15. P. W. Battaglia *et al.*, “Relational inductive biases, deep learning, and graph networks,” *Nature* **588**, 429 (2020)
16. Soorya Rethinasamy, Saptarshi Roy, Titas Chanda, Aditi Sen(De), and Ujjwal Sen, “Universality in distribution of monogamy scores for random multiqubit pure states,” *Phys. Rev. A* **99**, 042302 (2019), <https://doi.org/10.1103/PhysRevA.99.042302>
17. M. Cerezo *et al.*, “Variational quantum algorithms,” *Nat. Rev. Phys.* **3**, 625 (2021), <https://doi.org/10.1038/s42254-021-00348-9>.
18. A. Chicco and G. Jurman, “The advantages of the Matthews correlation coefficient (MCC) over F1 score and accuracy in binary classification evaluation,” *BMC Genomics* **21**, 6 (2020), <https://doi.org/10.1186/s12864-019-6413-7>.
19. F. R. K. Chung, *Spectral Graph Theory* (American Mathematical Society, Providence, RI, 1997).
20. A. W. Cross *et al.*, “Open Quantum Assembly Language,” arXiv:1707.03429, <https://doi.org/10.48550/arXiv.1707.03429>.
21. M. Defferrard, X. Bresson, and P. Vandergheynst, “Convolutional neural networks on graphs with fast localized spectral filtering,” in *Adv. Neural Inf. Process. Syst.* **29**, 3844 (2016)
22. W. Dür and H.-J. Briegel, “Entanglement purification and quantum error correction,” *Rep. Prog. Phys.* **70**, 1381 (2007), <https://doi.org/10.1088/0034-4885/70/8/R03>.
23. A. Farhi and H. Neven, “Classification with quantum neural networks on near-term processors,” arXiv:1802.06002, <https://doi.org/10.48550/arXiv.1802.06002>.
24. M. Fiedler, “Algebraic connectivity of graphs,” *Czechoslovak Math. J.* **23**, 298 (1973).
25. T. Fösel, P. Tighineanu, T. Weiss, and F. Marquardt, *Reinforcement Learning with Neural Networks for Quantum Feedback*, *Physical Review X* **8**, (2018).
26. W. Gardiner, *Stochastic Methods* (Springer, Berlin, 2009), .
27. L. Gyongyosi and S. Imre, *Networked Quantum Services†*, *Quantum Information & Computation* **25**, 97 (2025).
28. C. S. Hamilton, R. Kruse, L. Sansoni, S. Barkhofen, C. Silberhorn, and I. Jex, “Gaussian Boson Sampling,” *Phys. Rev. Lett.* **119**, 170501 (2017), <https://doi.org/10.1103/PhysRevLett.119.170501>.
29. W. L. Hamilton, Z. Ying, and J. Leskovec, “Inductive Representation Learning on Large Graphs,” in *Advances in Neural Information Processing Systems 30 (NeurIPS 2017)*, 1024–1034 (2017); arXiv:1706.02216.
30. H. Kashima, K. Tsuda, and A. Inokuchi, “Marginalized Kernels Between Labeled Graphs,” in *Proc. 20th Int. Conf. Mach. Learn. (ICML 2003)* (AAAI Press, 2003), pp. 321–328.

31. H. J. Kimble, “The quantum internet,” *Nature* **453**, 1023 (2008), <https://doi.org/10.1038/nature07127>.
32. M. Schuld and N. Killoran, “Quantum machine learning in feature Hilbert spaces,” *Phys. Rev. Lett.* **122**, 040504 (2019), <https://doi.org/10.1103/PhysRevLett.122.040504>.
33. T. N. Kipf and M. Welling, “Semi-supervised classification with graph convolutional networks,” in *Proc. ICLR* (2017).
34. J. Wen, X. Kong, S. Wei, B. Wang, T. Xin, and G. Long, *Experimental Realization of Quantum Algorithms for a Linear System Inspired by Adiabatic Quantum Computing*, Physical Review. A/Physical Review, A **99**, (2019).
35. A. Javaid, Q. Niyaz, and W. Sun, “A deep learning approach for network intrusion detection system,” *EAI Endorsed Trans. Security and Safety* (2016), .
36. Lazarevic, L. Ertöz, and V. Kumar, “A comparative study of anomaly detection schemes in network intrusion detection,” in *Proc. SIAM Int. Conf. Data Mining* (2005), .
37. J. Li *et al.*, *npj Quantum Inf.* **7**, 60 (2021), <https://doi.org/10.1038/s41534-021-00398-9>.
38. S. Mandt *et al.*, “Stochastic Gradient Descent as Approximate Bayesian Inference,” *J. Mach. Learn. Res.* **18**, 1 (2017)
39. M. A. Nielsen and I. L. Chuang, *Quantum Computation and Quantum Information* (Cambridge University Press, Cambridge, 2000).
40. J. S. Otterbach *et al.*, “Unsupervised machine learning on a hybrid quantum computer,” arXiv:1712.05771, <https://doi.org/10.48550/arXiv.1712.05771>.
41. M. Pant, H. Krovi, D. Towsley, L. Tassiulas, L. Jiang, P. Basu, D. Englund, and S. Guha, “Routing entanglement in the quantum internet,” *npj Quantum Inf.* **5**, 25 (2019), <https://doi.org/10.1038/s41534-019-0139-x>
42. J. Preskill, “Quantum computing in the NISQ era and beyond,” *Quantum* **2**, 79 (2018), <https://doi.org/10.22331/q-2018-08-06-79>.
43. N. Quesada, J. M. Arrazola, and N. Killoran, *Gaussian Boson Sampling Using Threshold Detectors*, Physical Review A **98**, (2018).
44. M. Ring *et al.*, “A survey of network-based intrusion detection data sets,” *Comput. Secur.* **86**, 147 (2019), <https://doi.org/10.1016/j.cose.2019.06.005>.
45. J. Romero *et al.*, “Quantum autoencoders for efficient compression of quantum data,” *Quantum Sci. Technol.* **2**, 045001 (2017), <https://doi.org/10.1088/2058-9565/aa8072>.
46. M. Sakurada and T. Yairi, “Anomaly detection using autoencoders with nonlinear dimensionality reduction,” in *Proc. MLSDA Workshop* (2014).
47. N. Sangouard, C. Simon, H. de Riedmatten, and N. Gisin, *Quantum Repeaters Based on Atomic Ensembles and Linear Optics*, Reviews of Modern Physics **83**, 33 (2011).
48. M. Schuld *et al.*, “Circuit-centric quantum classifiers,” *Phys. Rev. A* **101**, 032308 (2020), <https://doi.org/10.1103/PhysRevA.101.032308>.
49. M. Schuld and F. Petruccione, *Supervised Learning with Quantum Computers* (Springer, Cham, 2018), .
50. N. Shervashidze, P. Schweitzer, E. J. van Leeuwen, K. Mehlhorn, and K. M. Borgwardt, “Weisfeiler-Lehman Graph Kernels,” *J. Mach. Learn. Res.* **12**, 2539–2561 (2011)
51. N. Shone, T. Ngoc, V. Phai, and Q. Shi, “A deep learning approach to network intrusion detection,” *IEEE Trans. Emerg. Top. Comput. Intell.* **2**, 41 (2018), <https://doi.org/10.1109/TETCI.2017.2772792>.
52. A. Spielman, *Spectral and Algebraic Graph Theory* (lecture notes, 2019), .
53. R. Sommer and V. Paxson, “Outside the closed world: On using machine learning for network intrusion detection,” in *IEEE Symp. Security and Privacy* (2010), <https://doi.org/10.1109/SP.2010.25>.
54. W. Wang *et al.*, “Network intrusion detection using deep learning: A survey,” *IEEE Commun. Surv. Tutor.* **24**, 684 (2022), <https://doi.org/10.1109/COMST.2021.3134524>.
55. H. Wang, J. Qin, X. Ding, M.-C. Chen, S. Chen, X. You, Y.-M. He, X. Jiang, L. You, Z. Wang, C. Schneider, J. J. Renema, S. Höfling, C.-Y. Lu, and J.-W. Pan, “Boson Sampling with 20 Input Photons and a 60-Mode Interferometer in a  $10^{14}$ -Dimensional Hilbert Space,” *Phys. Rev. Lett.* **123**, 250503 (2019), <https://doi.org/10.1103/PhysRevLett.123.250503>
56. S. Wehner, D. Elkouss, and R. Hanson, *Quantum Internet: A Vision for the Road Ahead*, Science **362**, (2018).
57. Z. Wu *et al.*, “A comprehensive survey on graph neural networks,” *IEEE Trans. Neural Netw. Learn. Syst.* **32**, 4 (2021), <https://doi.org/10.1109/TNNLS.2020.2978386>.

58. R. Verdon *et al.*, “A quantum graph neural network,” arXiv:1909.12264, <https://doi.org/10.48550/arXiv.1909.12264>.
59. L. G. Valiant, “The complexity of enumeration and reliability problems,” *Theor. Comput. Sci.* **8**, 189 (1979), [https://doi.org/10.1016/0304-3975\(79\)90024-6](https://doi.org/10.1016/0304-3975(79)90024-6).
60. J. M. Arrazola *et al.*, “Quantum-inspired algorithms in practice,” *Nat. Mach. Intell.* **2**, 393 (2020), <https://doi.org/10.1038/s42256-020-00201-3>.
61. J. M. Arrazola *et al.*, “Quantum circuits with many photons on a programmable nanophotonic chip,” *Nature* **591**, 54 (2021), <https://doi.org/10.1038/s41586-021-03202-1>.
62. J. Zinn-Justin, *Quantum Field Theory and Critical Phenomena* (Oxford University Press, Oxford, 2002).
63. Yan, A. M. Iliyasa, Z. Liu, A. S. Salama, F. Dong, and K. Hirota, “Bloch Sphere-Based Representation for Quantum Emotion Space,” *J. Adv. Comput. Intell. Intell. Inform.* **19**, 134–142 (2015), <https://doi.org/10.20965/jaciii.2015.p0134>.
64. V. V. Shende and I. L. Markov, “Quantum circuits for incompletely specified two-qubit operators,” *Quantum Inf. Comput.* **5**(1), 48–56 (2005), .
65. M. Benedetti, E. Lloyd, S. Sack, and M. Fiorentini, “Parameterized quantum circuits as machine learning models,” *Quantum Sci. Technol.* **4**, 043001 (2019), <https://doi.org/10.1088/2058-9565/ab4eb5>.
66. Huang, M. Broughton, M. Mohseni, R. Babbush, S. Boixo, H. Neven, and J. R. McClean, “Power of data in quantum machine learning,” *Nat. Commun.* **12**, 2631 (2021), <https://doi.org/10.1038/s41467-021-22539-9>.
67. S. Ganguly, *Quantum Machine Learning: An Applied Approach: The Theory and Application of Quantum Machine Learning in Science and Industry* (Apress, 2021).
68. V. Havlíček, A. D. Córcoles, K. Temme, A. W. Harrow, A. Kandala, J. M. Chow, and J. M. Gambetta, “Supervised learning with quantum-enhanced feature spaces,” *Nature* **567**, 209–212 (2019), <https://doi.org/10.1038/s41586-019-0980-2>.
69. M. Arjovsky, A. Shah, and Y. Bengio, “Unitary evolution recurrent neural networks,” in *Proc. 33rd Int. Conf. Mach. Learn. (ICML 2016)*, 1120–1128 (2016), .
70. Qiskit API documentation, <https://qiskit.org/documentation/> (accessed Dec. 17, 2025)
71. A. Javadi-Abhari *et al.*, “Quantum computing with Qiskit,” arXiv:2405.08810 (2024), <https://doi.org/10.48550/arXiv.2405.08810>.
72. A. Gong *et al.*, “Memorizing Normality to Detect Anomaly: Memory-augmented Deep Autoencoder for Unsupervised Anomaly Detection,” arXiv:1904.02639 (2019), <https://doi.org/10.48550/arXiv.1904.02639>.
73. Z. Chen, C. Yeo, B. Lee, and C. T. Lau, “Autoencoder-based network anomaly detection,” in *2018 Wireless Telecommunications Symposium (WTS)*, 1–5 (2018), <https://doi.org/10.1109/WTS.2018.8363930>.
74. V. Bergholm *et al.*, “PennyLane: Automatic differentiation of hybrid quantum-classical computations,” arXiv:1811.04968 (2018), <https://doi.org/10.48550/arXiv.1811.04968>.
75. J. Basit, D. Hanif, and M. Arshad, “Quantum Variational Autoencoders for Predictive Analytics in High Frequency Trading Enhancing Market Anomaly Detection,” *Int. J. Emerg. Multidisciplinaries: Comput. Sci. Artif. Intell.* **3**(1), 21 (2024), <https://doi.org/10.54938/ijemdcasai.2024.03.1.319>.
76. C. Bravo-Prieto, “Quantum autoencoders with enhanced data encoding,” *Mach. Learn.: Sci. Technol.* **2**, 035028 (2021), <https://doi.org/10.1088/2632-2153/ac0616>.
77. A. Sakhnenko *et al.*, “Hybrid classical-quantum autoencoder for anomaly detection,” *Quantum Mach. Intell.* **4**, 2 (2022), <https://doi.org/10.1007/s42484-022-00075-z>.
78. J. Y. Araz and M. Spannowsky, “The role of data embedding in quantum autoencoders for improved anomaly detection,” arXiv:2409.04519 (2024), <https://doi.org/10.48550/arXiv.2409.04519> (accessed Nov. 10, 2025).
79. J.-R. Jiang and J.-S. Li, “Applying a Parameterized Quantum Circuit to Anomaly Detection,” *Eng. Proc.* **3**, 3 (2025), <https://doi.org/10.3390/engproc2025092003>.
80. A. Elsharkawy *et al.*, “Integration of Quantum Accelerators with High Performance Computing—A Review of Quantum Programming Tools,” *ACM Trans. Quantum Comput.* (2025), <https://doi.org/10.1145/3743149>.
81. S. Chakraborty, S. H. Shaikh, A. Chakrabarti, and R. Ghosh, “A hybrid quantum feature selection algorithm using a quantum inspired graph theoretic approach,” *Appl. Intell.* **50**, 1775–1793 (2020), <https://doi.org/10.1007/s10489-019-01604-3>.

82. V. S. Ngairangbam, M. Spannowsky, and M. Takeuchi, “Anomaly detection in high-energy physics using a quantum autoencoder,” *Phys. Rev. D* **105**, 095004 (2022), <https://doi.org/10.1103/PhysRevD.105.095004>.
83. Y. Zhu, G. Bai, Y. Wang, T. Li, and G. Chiribella, “Quantum autoencoders for communication-efficient cloud computing,” *Quantum Mach. Intell.* **5**, 2 (2023), <https://doi.org/10.1007/s42484-023-00112-5>.
84. H. Suryotrisongko and Y. Musashi, “Evaluating hybrid quantum-classical deep learning for cybersecurity botnet DGA detection,” *Proc. Comput. Sci.* **197**, 111–118 (2022), <https://doi.org/10.1016/j.procs.2021.12.135>.
85. E. D. Payares and J. C. Martinez-Santos, “Quantum machine learning for intrusion detection of distributed denial of service attacks: a comparative overview,” in *Quantum Computing, Communication, and Simulation*, edited by P. R. Hemmer and A. L. Migdall, Proc. SPIE **11726**, 117260R (2021), <https://doi.org/10.1117/12.2593297>.
86. C. Bauckhage *et al.*, *Quantum Machine Learning in the Context of IT Security: Security within Quantum Machine Learning & Quantum Machine Learning for Cyber Security* (Federal Office for Information Security (BSI), 2022)
87. J. R. McClean, S. Boixo, V. N. Smelyanskiy, R. Babbush, and H. Neven, *Barren Plateaus in Quantum Neural Network Training Landscapes*, Nature Communications **9**, (2018).
88. M. Cerezo, A. Sone, T. Volkoff, L. Cincio, and P. J. Coles, *Cost Function Dependent Barren Plateaus in Shallow Parametrized Quantum Circuits*, Nature Communications **12**, (2021).
89. N. Lambert, E. Giguère, P. Menczel, B. Li, P. Hopf, G. Suárez, M. Gali, J. Lishman, R. Gadhvi, R. Agarwal, A. Galicia, N. Shammah, P. Nation, J. R. Johansson, S. Ahmed, S. Cross, A. Pitchford, and F. Nori, “QuTiP 5: The Quantum Toolbox in Python,” *Phys. Rep.* **1153**, 1–62 (2026), <https://doi.org/10.1016/j.physrep.2025.10.001>
90. A. Ceschini, F. Mauro, F. D. Falco, A. Sebastianelli, A. Verdone, A. Rosato, B. Le Saux, M. Panella, P. Gamba, and S. L. Ullo, “From Graphs to Qubits: A Critical Review of Quantum Graph Neural Networks,” arXiv:2408.06524 (2024), <https://doi.org/10.48550/arXiv.2408.06524>, last accessed on 02/25/2026
91. Zhe-Yu Jeff Ou, *Multi-Photon Quantum Interference* (Springer Science & Business Media, 2007).
92. J. Stöhr, *Overcoming the Diffraction Limit by Multi-Photon Interference: A Tutorial*, Advances in Optics and Photonics **11**, 215 (2019).
93. M. Tillmann, B. Dakić, R. Heilmann, S. Nolte, A. Szameit, and P. Walther, *Experimental Boson Sampling*, Nature Photonics **7**, 540 (2013).
94. V. Chandola, A. Banerjee, and V. Kumar, “Anomaly Detection: A Survey,” *ACM Comput. Surv.* **41**(3), Article 15 (2009), <https://doi.org/10.1145/1541880.1541882>
95. R. Chalapathy and S. Chawla, “Deep Learning for Anomaly Detection: A Survey,” arXiv:1901.03407 (2019), <https://doi.org/10.48550/arXiv.1901.03407>
96. S. L. Braunstein and C. M. Caves, “Statistical distance and the geometry of quantum states,” *Phys. Rev. Lett.* **72**, 3439–3443 (1994), <https://doi.org/10.1103/PhysRevLett.72.3439>
97. J. Stokes, J. Izaac, N. Killoran, and G. Carleo, “Quantum Natural Gradient,” *Quantum* **4**, 269 (2020), <https://doi.org/10.22331/q-2020-05-25-269>; arXiv:1909.02108.
98. I. Sharafaldin, A. Habibi Lashkari, S. Hakak, and A. A. Ghorbani, “Developing Realistic Distributed Denial of Service (DDoS) Attack Dataset and Taxonomy,” in *2019 International Carnahan Conference on Security Technology (ICCST)*, 1–8 (2019), <https://doi.org/10.1109/CCST.2019.8888419>
99. I. Sharafaldin, A. Habibi Lashkari, and A. A. Ghorbani, “Toward Generating a New Intrusion Detection Dataset and Intrusion Traffic Characterization,” in *Proc. 4th Int. Conf. Inf. Syst. Secur. Privacy (ICISSP 2018)* (SciTePress, 2018), pp. 108–116, <https://doi.org/10.5220/0006639801080116>
100. A. Kandala, A. Mezzacapo, K. Temme, M. Takita, M. Brink, J. M. Chow, and J. M. Gambetta, *Hardware-Efficient Variational Quantum Eigensolver for Small Molecules and Quantum Magnets*, Nature **549**, 242 (2017).
101. T. Bhattacharyya, M. A. Dritschel, and C. S. Todd, *Completely Bounded Kernels*, Acta Scientiarum Mathematicarum **79**, 191 (2013).
102. W. LI and X. JIA, *Feature Selection Algorithm Based on Hellinger Distance*, Journal of Computer Applications **30**, 1530 (2010).

103. F. Bloch, "Nuclear Induction," *Phys. Rev.* **70**, 460 (1946).
104. I. Bengtsson and K. Życzkowski, *Geometry of Quantum States: An Introduction to Quantum Entanglement*, 2nd ed. (Cambridge University Press, Cambridge, England, 2017).
105. R. Jozsa, "Fidelity for Mixed Quantum States," *J. Mod. Opt.* **41**, 2315 (1994).
106. A. Uhlmann, "The 'transition probability' in the state space of a  $*$ -algebra," *Rep. Math. Phys.* **9**, 273 (1976).
107. M. Hübner, "Explicit computation of the Bures distance for density matrices," *Phys. Lett. A* **163**, 239 (1992).
108. M. Bina, F. Grasselli, and M. G. A. Paris, "Continuous-variable quantum probes for structured environments," *Phys. Rev. A* **97**, 012125 (2018).
109. C. Benedetti, F. Salari Sehdaran, M. H. Zandi, and M. G. A. Paris, "Quantum probes for the cutoff frequency of Ohmic environments," *Phys. Rev. A* **97**, 012126 (2018).
110. Y.-D. Sha and W. Wu, "Continuous-variable quantum sensing of a dissipative reservoir," *Phys. Rev. Res.* **4**, 023169 (2022).
111. H. Ather and A. Z. Chaudhry, "Improving the estimation of environment parameters via initial probe-environment correlations," *Phys. Rev. A* **104**, 012211 (2021).
112. A. Peruzzo, J. McClean, P. Shadbolt, M.-H. Yung, X.-Q. Zhou, P. J. Love, A. Aspuru-Guzik, and J. L. O'Brien, "A variational eigenvalue solver on a quantum processor," arXiv:1304.3061, 2013.
113. S. Zhou and L. Jiang, "An exact correspondence between the quantum Fisher information and the Bures metric," arXiv:1910.08473, 2019.
114. K. Tschärke, M. Wendlinger, A. Ahouzi, P. Bhardwaj, K. Amoi-Taleghani, M. Schrod-Baumann, and P. Debus, "Quantum Autoencoder for Multivariate Time Series Anomaly Detection," arXiv:2504.17548 [quant-ph] (2025), last accessed 03/24/2026.
115. R. Frehner and K. Stockinger, "Applying quantum autoencoders for time series anomaly detection," *Quantum Machine Intelligence* **7**, 59 (2025). DOI: 10.1007/s42484-025-00285-1.
116. F. Shayeganfar, A. Ramazani, V. Sundararaghavan, and Y. Duan, "Quantum graph learning and algorithms applied in quantum computer sciences and image classification," *Applied Physics Reviews* **12**, 021327 (2025). DOI: 10.1063/5.0237599.
117. H. Qiao, H. Tong, B. An, I. King, C. Aggarwal, and G. Pang, "Deep Graph Anomaly Detection: A Survey and New Perspectives," *IEEE Transactions on Knowledge and Data Engineering* **37**, 5106-5126 (2025). DOI: 10.1109/TKDE.2025.3581578.
118. M. Zhong, M. Lin, C. Zhang, and Z. Xu, "A survey on graph neural networks for intrusion detection systems: Methods, trends and challenges," *Computers & Security* **141**, 103821 (2024). DOI: 10.1016/j.cose.2024.103821.
119. D. Wierichs, J. Izaac, C. Wang, and C. Y.-Y. Lin, "General Parameter-Shift Rules for Quantum Gradients," *Quantum* **6**, 677 (2022).