

Algebras of order parameters in one-dimensional spin systems

AMEYA CHAVDA,[△] CLEMENT DELCAMP,[□] ALEX TURZILLO,[◇] MINYOUNG YOU[◇]

[△]*Center for Theoretical Physics, Department of Physics, Columbia University, New York, U.S.A*

[□]*Laboratoire Alexander Grothendieck, Institut des Hautes Études Scientifiques & CNRS, Bures-sur-Yvette, France*

[◇]*Department of Applied Mathematics and Theoretical Physics, University of Cambridge, Cambridge, United Kingdom*

[◇]*Yukawa Institute for Theoretical Physics, Kyoto University, Kyoto, Japan*

ameya.chavda@columbia.edu, delcamp@ihes.fr, amt201@cam.ac.uk,
miyou849@gmail.com

We study order parameters in one-dimensional quantum lattice models with finite invertible or non-invertible symmetry. We investigate what properties a string operator must satisfy in order to acquire a non-vanishing expectation value in a given gapped phase. We deduce that multiplets of string order parameters organise into a Lagrangian algebra in the Drinfel'd centre of the symmetry category. In particular, we highlight the role of the multiplication rule as governing the fusion of the twisted sector local operators that constitute the string operator in the infrared limit. Our derivations exploit the tensor network approach to the classification of gapped phases and its reformulation in terms of module categories over the symmetry category. Within this framework, a gapped phase is associated with a pattern of spontaneous symmetry breaking wherein a Morita class of algebras of topological lines is preserved in the ground state subspace. The crux of the proof is to show that the expectation value of any string operator explicitly depends on the tube algebra module associated with the Lagrangian algebra, which is realised as the full centre of the corresponding module category. Finally, we demonstrate that these techniques extend to phases of symmetric mixed states.

Contents

1	Introduction	2
2	Symmetric gapped phases	6
2.1	Microscopic Hilbert space	6
2.2	Symmetric states	10
2.3	Classification	12
2.4	Renormalisation group fixed points	13
3	Algebras of order parameters	17
3.1	String operators	17
3.2	Order parameters	23
3.3	Lagrangian algebras	26
3.4	Example: $\text{Vec}_{\mathbb{Z}_2 \oplus \mathbb{Z}_2}$	31
3.5	Example: Vec_{A_4}	34
4	Non-invertible symmetry	38
4.1	Microscopic Hilbert space	39
4.2	Symmetric gapped phases	41
4.3	Renormalisation group fixed points	44
4.4	String operators	45
4.5	Order parameters	51
4.6	Example: $\text{Rep}(A_4)$	54
4.7	Generalisation	55
5	Phases of symmetric mixed states	56
5.1	Matrix product density operators	56
5.2	Classification	59
5.3	Order parameters	62
5.4	Condensable algebras	63
A	Algebras	66
B	Drinfel'd centres and tube algebras	71
B.1	Drinfel'd centre of the category of group graded vector spaces	72
B.2	Drinfel'd centre of the category of group representations	74

Introduction

In condensed matter theory, arguably the most interesting aspect of the notion of *symmetry* is the absence thereof, or more precisely, the idea that a physical state—typically a ground state or a thermal equilibrium state—possesses less symmetry than the theory describing it. We distinguish two situations: the system possesses either a unique symmetric ground state that is left invariant by all symmetry operators, or a space of degenerate and orthogonal ground states that are related by the action of these operators. Within the Landau paradigm, distinct gapped phases of matter are classified by such patterns of *spontaneous symmetry breaking*.

Closely related to spontaneous symmetry breaking is the concept of an *order parameter*. Fundamentally, an order parameter is a physical observable used to detect *phase transitions*. It typically consists of a local operator whose vacuum expectation value vanishes in the symmetric phase but acquires a non-zero value in the symmetry-broken one. A stricter definition requires this local operator to have a unique expectation value for each symmetry-broken state. In spite of being a ubiquitous tool across theoretical physics, the contours of this concept continue to evolve. For example, the discovery of *symmetry-protected topological* (SPT) phases in one-dimensional quantum lattice models during the 1980s eventually challenged this paradigm [Hal83]. Famously, (non-trivial) SPT phases cannot be detected by local order parameters; rather, they require non-local *string order parameters* [dNR89, PGWS⁺08, PT12]. The existence of such SPT phases stems from the fact that there may be multiple (inequivalent) ways for a state to be left invariant by all the symmetry operators. A well known manifestation of this phenomenon is the presence of *edge modes* that transform projectively under the symmetry group, leading to a classification scheme based on *group cohomology* [KT92, GW09, CGW11, SPGC11].

The concept of symmetry itself has also been evolving. Indeed, reformulating symmetries in the language of *topological defects* has led to generalisations of the concept, commonly referred to as *generalised symmetries* [GKSW14, FMT22]. In particular, a (global internal) symmetry may be defined in terms of transformations of the degrees of freedom that cannot be ‘undone’, leading to the concept of a *non-invertible symmetry*. This formalises an idea that has long been anticipated by the study, for instance, of *Verlinde lines* [Ver88, PZ01] and related topological defects [OA96b, OA96a, FFRS04, FFRS06] in (1+1)d rational conformal field theories (CFTs). Another common source of examples are ordinary global symmetries with respect to non-abelian groups, which upon *gauging* produce non-invertible symmetries [Tac17, BT17, Del21, BSNW22, BBFP22, BBSNT22]. While ordinary symmetries are captured by group theory, these generalised symmetries necessitate higher mathematical structures. In (1+1)d, assuming finiteness and semi-simplicity, the relevant mathematical framework is provided by (*spherical*) *fusion category* theory [BT17, CLS⁺18, TW19, KLV⁺20, SN23, Sha23]. Naturally, this new notion of symmetry has necessitated a rethinking of the traditional concepts of gapped phases, spontaneous symmetry breaking, charges, and order parameters, as well as the identification of the relevant mathematical tools. Remarkably, these developments have shed light on the invertible case as well. In that spirit, this manuscript aims to provide a framework that refines our understanding of order parameters for gapped phases with invertible symmetries, while simultaneously tackling the more challenging case of non-invertible symmetries.

A lot of the intuition surrounding the physics of non-invertible symmetries stems from a picture that has been developed alongside it, namely that a theory with a given finite symmetry can be realised as a boundary theory of a higher-dimensional fully extended *topological quantum field theory* (TQFT)

hosting a gauged version of this symmetry. An early incarnation of this mechanism within the context of two-dimensional rational CFTs was explored in ref. [FRS02, FRS04a, FRS04b, FRS05]. More recently, this idea has born multiple names, namely ‘strange correlators’ [YBR⁺14, VBW⁺18], ‘topological holography’ [KWZ17, K LW⁺20, JW20, JW21, CW22, HC23, Hua24], ‘Symmetry Topological Field Theory (SymTFT)’ [ABGE⁺21, KOZ22, KNZZ23], or the ‘sandwich construction’ [FMT22]. The upshot is that all properties of a theory pertaining to its symmetry can be understood in terms of this higher-dimensional TQFT. This picture can be made especially explicit on the lattice [AMF16, FT18, VBW⁺18, AFM20, VLT21, DI24]. In the context of quantum lattice models, it boils down to the so-called *anyonic chain* construction [FTL⁺06, GAT⁺13, BG17, Ina21, LDOV21, LDV22], and higher-dimensional generalisations thereof [DT23, IO23, MABT23, CSSZ24, VDCD25, Eck25].

One important insight this picture suggests is that symmetric gapped phases are classified by topological *boundary conditions* of the corresponding SymTFT, yielding a classification of (1+1)d symmetric gapped phases in terms *indecomposable module categories* over the symmetry fusion category [TW19, KORS20]. In this formulation, vacua are in one-to-one correspondence with simple objects in this module category. In the invertible case, this readily recovers the ordinary classification of gapped phases of matter. This picture also sheds light on the notion of (generalised) charge for non-invertible symmetries. In general, a charge with respect to a non-invertible symmetry is a *twisted sector local operator*, i.e. a local operator living at the endpoint of topological symmetry line. Multiplets of twisted sector local operators form modules over the so-called *tube algebra* $\text{Tube}(\mathcal{C})$ of the symmetry (spherical) fusion category \mathcal{C} —a construction with an illustrious history going back to subfactor theory [Ocn94, Ocn01, Izu00, Mü03a, NY18]—via a process sometimes referred as the ‘lasso’ action of the symmetry lines [LOST22, BSN23, BBG23]. Crucially, the category $\text{Mod}(\text{Tube}(\mathcal{C}))$ of modules over the tube algebra is equivalent to the *Drinfel’d centre* $\mathcal{Z}(\mathcal{C})$ of the fusion category \mathcal{C} . In general, for every symmetry fusion category, the Drinfel’d centre is a *non-degenerate braided fusion category*, and it encodes the bulk operators of the corresponding SymTFT [TV92, BW93]. This classification of the multiplets of twisted sector local operators coincide with that of the topological sectors of theory, i.e. charge sectors of the various twisted Hilbert spaces. This is a task that can be performed very explicitly on the lattice within the anyonic chain framework [AFM20, LOST22, LDV22].

In this language, string operators can be thought as pairs of twisted sector local operators connected by a common topological line. We wish to understand what kind of properties string operators—or rather the corresponding twisted sector local operators—need to satisfy in order to be candidate order parameters for a given gapped symmetric phase. More specifically, we are interested in the space of string operators that acquire non-vanishing expectation values in the ground state subspace. Crystallising earlier ideas, a general statement has recently emerged in the literature [MMT22, BBPSN23], stating that order parameters form a specific structure within the Drinfel’d centre $\mathcal{Z}(\mathcal{C})$ of the symmetry fusion category \mathcal{C} known as a *Lagrangian algebra* [DNO13].

Lagrangian algebras in $\mathcal{Z}(\mathcal{C})$ are in one-to-one correspondence with indecomposable module categories over \mathcal{C} . In the SymTFT picture, they encode which collections of bulk line operators *condense* on the corresponding gapped boundary, as well as they way in which they condense [BS08, KK12, Kon13]. Because bulk line operators in the Lagrangian algebra terminate on the gapped boundary, one expects the corresponding string operators to acquire a non-vanishing expectation value in the ground state subspace of the corresponding gapped phase. Conversely, the operators that do not condense—those that are *confined* to the boundary—form a fusion category known as the Morita dual $\mathcal{C}_{\mathcal{M}}^*$ of the symmetry fusion category \mathcal{C} with respect to the module category \mathcal{M} . These operators produce the *excitations* on top of the ground states of the gapped phase so that the expectation values of the corresponding string operators necessarily vanish. Notably, most recent studies have focused on the meaning of the

object underlying the Lagrangian algebra, the role of the multiplication having been largely ignored. However, it is known that a single object in $\mathcal{Z}(\mathcal{C})$ can be equipped with distinct Lagrangian algebra structures. Within our context, this implies the existence of string order parameters that cannot be specified solely by the way they transform [PT12, KB25, KW25]. The goal of this manuscript is to provide further evidence in support of this conjecture and highlight the role of the multiplication rule.

Our focus is on one-dimensional quantum lattice models with *non-anomalous* symmetries. We demonstrate the following results. Given an arbitrary representative of a symmetric gapped phase, one proves that in order for the expectation value of a generic string operator not to vanish in the ground state subspace, the corresponding twisted sector local operators must transform in specific ways. More precisely, we show that any irreducible multiplet of twisted sector local operators with non-vanishing expectation values must be associated with a simple object in $\mathcal{Z}(\mathcal{C})$ that is a direct summand of the Lagrangian algebra associated with the gapped phase. We do so by showing that, up to terms that decay exponentially in the length of the string, the expectation values explicitly involve the module of the tube algebra associated with this Lagrangian algebra. Practically, we exploit the *tensor network* approach to the classification of gapped phases [PGVWC06, SPGC11, GRLM22], allowing us to pick an arbitrary gapped phase representative in the form of a *block-injective matrix product state* (MPS), and its reformulation in terms of indecomposable module categories over the symmetry fusion category.

While these derivations are relatively straightforward in the invertible case, non-invertible symmetries present greater computational challenges. Whenever the symmetry is described by the fusion category $\text{Rep}(G)$ of representations of a finite group G , one can conveniently exploit the fact that the Lagrangian algebras are known very explicitly, which allows for instance to decompose them into simple objects [DS17]. Beyond this specific scenario, explicit expressions are largely unavailable. However, one can rely on Davydov’s *full centre* construction [Dav10, DKR11]. Viewing the Lagrangian algebra as the full centre of the relevant module category makes its *half-braiding natural isomorphism* explicit in terms of the module category associator. Since objects of $\mathcal{Z}(\mathcal{C})$ are equivalent to $\text{Tube}(\mathcal{C})$ -modules, this immediately yields the $\text{Tube}(\mathcal{C})$ -module structure of the corresponding object in the same form that appears in our derivations.

This result raises interesting conceptual points. Even when a non-invertible symmetry is fully spontaneously broken, it can still admit some non-local string operators whose expectation values in the ground state are non-zero, in sharp contrast with the invertible case. For instance, for a $\text{Rep}(G)$ symmetry, this occurs whenever ground states are associated with higher-dimensional representations. Because these ground states possess varying degrees of entanglement, they are not strictly equivalent [BBPSN23, LDV24, CBNM25]. By construction, the topological lines entering the definition of such string order parameters are preserved in these ground states. Crucially, the collection of all such lines do not form a fusion subcategory as they are typically not even closed under the monoidal structure of the symmetry fusion category. This highlights an important aspect of spontaneous symmetry breaking, namely that the symmetry that is preserved in a given ground state is captured by an *algebra of lines* in the symmetry category. More precisely, the algebra of lines that is preserved in a given ground state is the *internal hom* of the associated simple object in the corresponding module category. Therefore, the symmetry of the theory and the symmetry of the ground states are not on the same level of mathematical abstraction. While different ground states generally preserve non-isomorphic algebras, these algebras are *Morita equivalent*, which is sufficient to ensure that they are all compatible with the same module category labelling the gapped phase [Ost01].

In general, for a given gapped phase representative, many irreducible multiplets of twisted sector local operators associated with a direct summand of the corresponding Lagrangian algebra may be defined. Not every multiplet of string operators will acquire an expectation value in the vacuum. In particular, this may happen when several Lagrangian algebra structures can be defined on the same underlying object in the Drinfel'd centre. For *renormalisation group fixed points* of the gapped phase, we argue that given string operators that yield non-vanishing expectation values, when projecting them into the *infrared*—an operation that the tensor network formalism allows us to perform rather straightforwardly—we obtain a multiplet of twisted sector local operators that fuse according to the multiplication rule of the Lagrangian algebra. In other words, a (generic) string operator whose projection into the infrared does not reproduce the expected multiplication rule would have a vanishing expectation value. We verify this statement very explicitly in the invertible case. We posit that a more systematic study of this aspect beyond renormalisation group fixed points would require operator algebraic techniques [FNW92, Nac96, Oga20, RMO24, EJ25].

Organisation of the manuscript: In sec. 2, we review the tensor network description of one-dimensional gapped phases with finite invertible symmetry and the construction of renormalisation group fixed point representatives for these phases. In sec. 3, we define string operators in terms of twisted-sector local operators and explain how their multiplets transform as modules over the tube algebra, or equivalently as objects of the Drinfel'd centre. We then show that only those irreducible multiplets appearing as direct summands of the associated Lagrangian algebra can acquire non-vanishing expectation values. At fixed points, we further show that the order parameters which survive in the infrared fuse according to the multiplication of this Lagrangian algebra. Explicit examples are included to illustrate how this algebraic structure refines the usual notion of string order. Sec. 4 extends the construction to non-invertible symmetries and demonstrates the analogous result that string order parameters again furnish direct summands of the Lagrangian algebra associated with the relevant module category. We clarify that the symmetry preserved in a given ground state is encoded into the internal hom of the corresponding simple objects in the module category. In sec. 5, we quickly show how our methods also apply to phases of symmetric mixed states for invertible symmetries. Various mathematical definitions and results are collected in appendices.

Acknowledgements: C. D. is grateful to Lea Bottini, Laurens Lootens and Giovanni Rizi for insightful discussions. The authors would like to thank the Isaac Newton Institute for Mathematical Sciences, Cambridge, for support and hospitality during the programme *Quantum field theory with boundaries, impurities, and defects*, where work on this paper was undertaken. This work was supported by *EPSRC grant EP/Z000580/1*. A. C. gratefully acknowledges the support and hospitality of the Institut des Hautes Études Scientifiques during the completion of part of this work. A. C. is supported by the National Science Foundation Graduate Research Fellowship under *Grant No. DGE-2036197*. A. T. acknowledges funding from the EU's Horizon 2020 research and innovation programme under the *Marie Skłodowska-Curie grant agreement No. 101273289* as well as from the *UKRI grant EP/Z003342/1*.

Symmetric gapped phases

Given a finite group G , we review the classification of one-dimensional G -symmetric gapped phases in terms of block-injective tensor networks, which we reinterpret in terms of indecomposable module categories over the fusion category Vec_G . This formalism is then exploited to construct families of renormalisation group fixed points for each gapped phase. Relevant category theoretic concepts are introduced in app A.

2.1 Microscopic Hilbert space

Consider a one-dimensional quantum theory with a finite non-anomalous invertible (0-form) symmetry, i.e., a finite ‘ordinary’ symmetry.¹ Let G be the finite group of symmetry transformations. The corresponding topological lines are encoded into the (pivotal unitary) fusion category Vec_G of finite-dimensional G -graded vector spaces and grading preserving linear maps. Recall that representatives of isomorphism classes of simple objects in Vec_G are provided by the one-dimensional vector spaces $\mathbb{C}_g = \mathbb{C}\{e_g\}$, for every $g \in G$, such that $(\mathbb{C}_g)_x = \delta_{g,x} \mathbb{C}$ and $\text{Hom}_{\text{Vec}_G}(\mathbb{C}_g, \mathbb{C}_x) \cong \delta_{g,x} \mathbb{C}$, for every $g, x \in G$. The tensor product of two simple objects is provided by the multiplication rule of G according to $\mathbb{C}_{g_1} \otimes \mathbb{C}_{g_2} \cong \mathbb{C}_{g_1 g_2}$, for every $g_1, g_2 \in G$.

There are many ways to realise a symmetry G (or rather Vec_G) in one-dimensional quantum lattice models [LDOV21, LDV22, JSW24]. Throughout this manuscript, we work within the following setup: Let $\text{Rep}(G)$ be the category of finite-dimensional representation of G . Let $V = \mathbb{C}\{v_d\}_{d=1, \dots, \dim_{\mathbb{C}} V}$ be an object in $\text{Rep}(G)$ with algebra homomorphism $\rho: \mathbb{C}[G] \rightarrow \text{End}_{\mathbb{C}}(V)$ between the group algebra $\mathbb{C}[G] = \mathbb{C}\{e_g\}_{g \in G}$ and the algebra $\text{End}_{\mathbb{C}}(V) = V \otimes V^*$ of endomorphisms of V .² We write the basis of the dual vector space as $V^* := \text{Hom}(V, \mathbb{C}) = \mathbb{C}\{v^d\}_{d=1, \dots, \dim_{\mathbb{C}} V}$. Pick a finite subset Λ of the lattice \mathbb{Z} . To every ‘site’ $i \in \Lambda$, we assign a copy of the vector space V together with a copy of the algebra $\text{Mat}_{\mathbb{C}}(\dim_{\mathbb{C}} V)$ of complex $\dim_{\mathbb{C}} V \times \dim_{\mathbb{C}} V$ matrices. We identify $\mathcal{A}_{\Lambda} := \bigotimes_{i \in \Lambda} \text{Mat}_{\mathbb{C}}(\dim_{\mathbb{C}} V)_{\{i\}}$ with the algebra of bounded operators acting on the microscopic Hilbert space $\mathcal{H}_{\Lambda} := \bigotimes_{i \in \Lambda} V_{\{i\}}$. To every topological line labelled by $\mathbb{C}_g \in \text{Vec}_G$, we then assign the bounded operator $\bigotimes_{i \in \Lambda} \rho(g)_{\{i\}} = \prod_{i \in \Lambda} \rho(g)_i$, where, as customary, $\rho(g)_i \equiv \rho(e_g)_i$ ³ denotes the embedding of $\rho(g) \in \text{Mat}_{\mathbb{C}}(\dim_{\mathbb{C}} V)_{\{i\}}$ into \mathcal{A}_{Λ} by tensoring with the identity operator. Requiring $V \in \text{Rep}(G)$ to be a *faithful* representation guarantees that the symmetry Vec_G acts faithfully on \mathcal{H}_{Λ} . Finally, every G -equivariant map $\varphi: V^{\otimes N} \rightarrow V^{\otimes N}$ gives rise to a symmetric operator $\varphi_{i, \dots, i+N-1} \in \mathcal{A}_{\Lambda}$, where the copies of V are here assigned to sites $i, \dots, i+N-1 \in \Lambda$.

Any state in \mathcal{H}_{Λ} can be expressed as a Matrix Product State (MPS) (see ref. [CPGSV21] for review of tensor network techniques). In general, one can define a *translation invariant* MPS in \mathcal{H}_{Λ} via a choice of linear map $\theta: M \rightarrow V \otimes M$, where $M = \mathbb{C}\{m_l\}_{l=1, \dots, \dim_{\mathbb{C}} M}$ is some finite-dimensional vector space. It is customary to refer to V as the ‘physical’ vector space and M as a ‘virtual’ vector space. Writing $M^* = \text{Hom}(M, \mathbb{C}) = \mathbb{C}\{m^l\}_{l=1, \dots, \dim_{\mathbb{C}} M}$, we can express the linear map θ as the following tensor:

$$\theta \equiv \sum_{l_1, l_2=1}^{\dim_{\mathbb{C}} M} \theta_{l_2}^{l_1} \otimes m_{l_1} \otimes m^{l_2} \equiv \sum_{l_1, l_2=1}^{\dim_{\mathbb{C}} M} \sum_{d=1}^{\dim_{\mathbb{C}} V} (\theta_{l_2}^{l_1})^d v_d \otimes m_{l_1} \otimes m^{l_2}, \quad (2.1)$$

¹Exploiting the anyonic chain framework developed in ref. [FTL+06, GAT+13, BG17, LDOV21, LDV22], we could easily generalise our results to the case of an anomalous symmetry. However, this would force us to define the microscopic Hilbert space in such a way that making contact with the existing literature on order parameters would not be as enlightening.

²Throughout, all the (linear and projective) representations are assumed to be *unitary*.

³Throughout, we freely conflate group homomorphisms and the corresponding linear extensions.

such that $\theta_{l_2}^{l_1} \in V$, for every $l_1, l_2 \in \{1, \dots, \dim_{\mathbb{C}} M\}$, and $(\theta_{l_1}^{l_1})^d \in \mathbb{C}$, for every $d \in \{1, \dots, \dim_{\mathbb{C}} V\}$. As such, θ is typically referred to as the ‘MPS tensor’ in the literature. As is customary, we shall use graphical notation. We depict the MPS tensor θ as⁴

$$\theta \equiv \begin{array}{c} \uparrow \\ \bigcirc \\ \leftarrow \end{array} \equiv \sum_{l_1, l_2=1}^{\dim_{\mathbb{C}} M} \sum_{d=1}^{\dim_{\mathbb{C}} V} l_1 \begin{array}{c} \uparrow \\ \bigcirc \\ \leftarrow \end{array} l_2 v_d \otimes m_{l_1} \otimes m^{l_2}. \quad (2.2)$$

Assuming *closed periodic* boundary conditions, the MPS $\Psi(\theta) \in \mathcal{H}_{\Lambda}$ associated with the map θ reads

$$\Psi(\theta) := \sum_{l_1, \dots, l_{|\Lambda|}} \theta_{l_2}^{l_1} \otimes \theta_{l_3}^{l_2} \otimes \dots \otimes \theta_{l_1}^{l_{|\Lambda|}}. \quad (2.3)$$

Alternatively, defining $\theta^d := \sum_{l_1, l_2=1}^{\dim_{\mathbb{C}} M} (\theta_{l_2}^{l_1})^d m_{l_1} \otimes m^{l_2} \in \text{End}_{\mathbb{C}}(M)$, for every $d \in \{1, \dots, \dim_{\mathbb{C}} V\}$, the same MPS can be written as

$$\Psi(\theta) = \sum_{d_1, \dots, d_{|\Lambda|}} \text{tr}_M[\theta^{d_1} \theta^{d_2} \dots \theta^{d_{|\Lambda|}}] v_{d_1} \otimes v_{d_2} \otimes \dots \otimes v_{d_{|\Lambda|}}. \quad (2.4)$$

Graphically,

$$\Psi(\theta) \equiv \left\| \begin{array}{c} \uparrow \\ \bigcirc \\ \leftarrow \end{array} \dots \begin{array}{c} \uparrow \\ \bigcirc \\ \leftarrow \end{array} \begin{array}{c} \uparrow \\ \bigcirc \\ \leftarrow \end{array} \begin{array}{c} \uparrow \\ \bigcirc \\ \leftarrow \end{array} \begin{array}{c} \uparrow \\ \bigcirc \\ \leftarrow \end{array} \begin{array}{c} \uparrow \\ \bigcirc \\ \leftarrow \end{array} \right\|. \quad (2.5)$$

A special class of MPSs consists of *injective* MPSs. An MPS is said to be injective if the linear map $\text{End}_{\mathbb{C}}(M) \rightarrow V, m_{l_1} \otimes m^{l_2} \mapsto \theta_{l_2}^{l_1}$ is injective;⁵ equivalently, if the set $\{\theta^d\}_{d=1, \dots, \dim_{\mathbb{C}} V}$ spans the matrix algebra $\text{Mat}_{\mathbb{C}}(\dim_{\mathbb{C}} M)$. An important object is the *transfer matrix* \mathbb{E}_{θ} of the MPS tensor θ , which is defined as

$$\begin{aligned} \mathbb{E}_{\theta} &:= \sum_{d=1}^{\dim_{\mathbb{C}} V} \bar{\theta}^d \otimes \theta^d \equiv \begin{array}{c} \bar{\theta} \\ \leftarrow \bigcirc \rightarrow \\ \uparrow \\ \leftarrow \bigcirc \rightarrow \\ \theta \end{array} : \text{End}_{\mathbb{C}}(M)^* \rightarrow \text{End}_{\mathbb{C}}(M)^* \\ &\equiv \sum_{l_1, \dots, l_4=1}^{\dim_{\mathbb{C}} M} (\mathbb{E}_{\theta})_{l_4 l_2}^{l_3 l_1} m^{l_3} \otimes m_{l_1} \otimes m_{l_4} \otimes m^{l_2}, \end{aligned} \quad (2.6)$$

where $(\mathbb{E}_{\theta})_{l_4 l_2}^{l_3 l_1} := \sum_{d=1}^{\dim_{\mathbb{C}} V} (\theta_{l_2}^{l_1})^d \overline{(\theta_{l_4}^{l_3})^d}$. The transfer matrix of any injective MPS tensor admits a single and non-degenerate *right* eigenvalue $\xi \in \mathbb{C}$ of largest weight. Graphically,

$$\begin{array}{c} \bar{\theta} \\ \leftarrow \bigcirc \rightarrow \\ \uparrow \\ \leftarrow \bigcirc \rightarrow \\ \theta \end{array} \Xi = \xi \cdot \begin{array}{c} \Xi \\ \leftarrow \bigcirc \rightarrow \end{array} \quad (2.7)$$

where $\Xi \in \text{End}_{\mathbb{C}}(M)^*$ is the unique right eigenvector with eigenvalue ξ . Without loss of generality, one can normalise the MPS tensor θ so that $\xi = 1$, making Ξ a *fixed point* of \mathbb{E}_{θ} . Similarly, one can consider *left* eigenvectors of the transfer matrix, where again 1 is the unique peripheral eigenvalue and

⁴Typically, since one only deals with one MPS tensor at a time, we can omit the corresponding label for visual clarity.

⁵In words, the tensor θ , interpreted as a map from the virtual space to the physical space, is injective.

there is a unique left fixed point. Via basis transformations, it is always possible to bring θ into its *left canonical form* so that this fixed point is the identity map in $\text{End}_{\mathbb{C}}(M)$ [Sch11]. Graphically,

$$\text{id}_M \text{ (with } \bar{\theta} \text{ and } \theta \text{)} = \text{id}_M \text{ (with } \bar{\theta} \text{ and } \theta \text{)} . \quad (2.8)$$

Below, we always assume such a left canonical form. Since all other eigenvalues have magnitude less than 1, the product of N transfer matrices tends toward a projector in the limit of large N :

$$\text{Transfer matrices} = \Xi \circ \text{id}_M + O(e^{N\tilde{\xi}}) \xrightarrow{N \rightarrow \infty} \Xi \circ \text{id}_M , \quad (2.9)$$

where $\tilde{\xi}$ denotes the eigenvalue of second highest magnitude. This implies that the right fixed point Ξ is normalized as $\text{tr}_M[\Xi] = 1$ because $\Xi = \lim_{N \rightarrow \infty} \mathbb{E}_{\theta}^N \Xi = \text{tr}_M[\Xi] \Xi$. A special class of MPS are renormalisation group fixed points (see sec. 2.4), defined as those for which the transfer matrix \mathbb{E} is a projector. For such states, one can set $\Xi = \text{id}_M$ by a local change of basis on the physical sites; when we discuss fixed point states in sec. 2.4, we will assume we have done this.

Crucial to our analysis is the statement that any injective MPS can be realised as the unique ground state of a gapped symmetric local parent Hamiltonian. Conversely, any ground state of a one-dimensional local gapped quantum lattice model can be efficiently approximated by an MPS whose *bond dimension* $\dim_{\mathbb{C}} M$ does not depend on the system size [PGVWC06, Has07, SPGC11]. Furthermore, if there is a single vacuum in this gapped phase, the MPS can always be chosen to be injective by blocking sites; otherwise gapped ground states need to satisfy additional *cluster decomposition properties* in order to be efficiently approximated by an injective MPS, so as to rule out for instance *cat-like* states [PGVWC06].

It is always possible to bring a periodic⁶ MPS into a *block-diagonal* form, whereby $M = \bigoplus_a M_a$ and θ^d is a block-diagonal matrix $\bigoplus_a \theta_a^d$, where $\theta_a^d \in \text{End}_{\mathbb{C}}(M_a)$ for every $d \in \{1, \dots, \dim_{\mathbb{C}} V\}$ [PGVWC06]. Graphically,

$$\theta = \bigoplus_a \theta = \bigoplus_a \theta_a , \quad (2.10)$$

where we introduced $\theta_a : M_a \rightarrow V \otimes M_a$ such that $(\theta_a)^d := \theta_a^d \in \text{End}_{\mathbb{C}}(M_a)$, for every $d \in \{1, \dots, \dim_{\mathbb{C}} V\}$. By blocking sites,⁷ we may further assume that each θ_a is injective. Given that two injective MPSs yield either proportional or orthogonal states in the infinite volume limit [CPGSV16], one focuses in the following on block-injective MPSs whose blocks are injective and orthogonal to each other. This implies that the mixed transfer matrix

$$\mathbb{E}_{\theta_{a_1} \theta_{a_2}} := \sum_{d=1}^{\dim_{\mathbb{C}} V} \bar{\theta}_{a_1}^d \otimes \theta_{a_2}^d \quad (2.11)$$

⁶On twisted boundary conditions, off-block-diagonal components of the MPS tensor cannot be eliminated, so the general form is more complicated; we will not consider this case here.

⁷Without blocking sites, the blocks θ_a can be taken to be irreducible (i.e. lacking invariant subspaces) but not injective. Some irreducible blocks may be *normal*, meaning that they become injective upon blocking. Other irreducible blocks may fail to be normal, indicating spontaneous symmetry breaking of translation symmetry; such blocks split into multiple irreducible ones upon blocking. We always assume we have blocked sites, so that our tensors are block-injective.

has spectral radius less than 1 if $a_1 \neq a_2$. The full transfer matrix \mathbb{E}_θ decomposes as $\mathbb{E}_\theta = \bigoplus_{a_1, a_2} \mathbb{E}_{\theta_{a_1} \theta_{a_2}}$ and has a space of right fixed points spanned by the fixed points Ξ_a of $\mathbb{E}_{\theta_a} = \mathbb{E}_{\theta_a \theta_a}$.

The same way states in \mathcal{H}_Λ can be expressed as MPSs, the symmetry operator $\prod_{i \in \Lambda} \rho(g)_i$ associated with the simple object $\mathbb{C}_g \in \text{Vec}_G$ can be realised as a Matrix Product Operator (MPO) of the form⁸

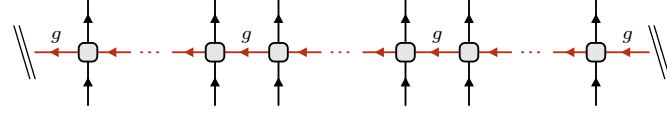
(2.12)

in terms of a tensor

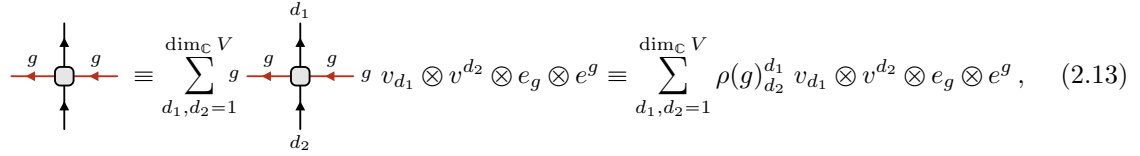
(2.13)

where $\text{Hom}(\mathbb{C}_g, \mathbb{C}) = \mathbb{C}\{e^g\}$. All these symmetry operators can be organised into a block-injective MPO

(2.14)

The fact that $\rho : \mathbb{C}[G] \rightarrow \text{End}_{\mathbb{C}}(V)$ is an algebra homomorphism yields the identity

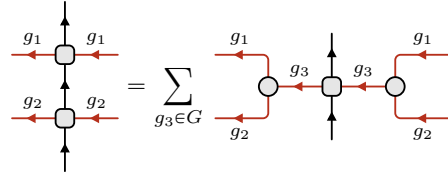
(2.15)

where, for every $g_1, g_2, g_3 \in G$, we introduced tensors $\mathbb{C}_{g_1} \otimes \mathbb{C}_{g_2} \rightarrow \mathbb{C}_{g_3}$ and $\mathbb{C}_{g_3} \rightarrow \mathbb{C}_{g_1} \otimes \mathbb{C}_{g_2}$ given by

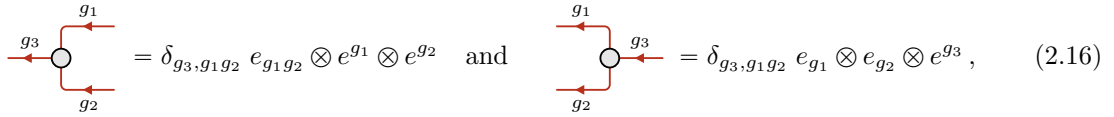
(2.16)

respectively, such that

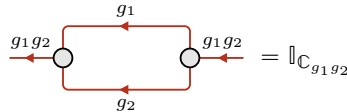
(2.17)

⁸Even though the symmetry operator $\prod_{i \in \Lambda} \rho(g)_i = \bigotimes_{i \in \Lambda} \rho(g)_{\{i\}}$ is a tensor product operator, it is useful to treat it as an MPO with a one-dimensional bond space. Moreover, it offers visual support for the corresponding topological line.

Physically, we interpret this operation as a consequence of the topological invariance of the symmetry lines, allowing us to fuse them locally. Clearly, we have the following equality

$$(2.18)$$

for every $g_1, g_2, g_3 \in G$, which is the manifestation that the symmetry G is *non-anomalous* and that the associator of Vec_G evaluates to the identity.

2.2 Symmetric states

Let us now review the classification of one-dimensional G -symmetric gapped phases in terms of block-injective MPSs [SPGC11, CGW11, GRLM22]. Consider a block-injective tensor $\theta = \bigoplus_a \theta_a$ of the form (2.10) and the corresponding MPS. Each block labelled by some index a produces an MPS $\Psi(\theta_a)$ in \mathcal{H}_Λ . The block-injective MPS is said to be G -symmetric if the subspace $\mathbb{C}\{\Psi(\theta_a)\}_a$ is closed under the action of $\prod_{i \in \Lambda} \rho(g)_i$, for every $g \in G$ and any system size $|\Lambda|$. Suppose $\Psi(\theta)$ is G -symmetric. It turns out that the set of labels a that index the injective blocks is a G -set, i.e. it forms a *permutation representation* of G [SPGC11, CGW11, GRLM22]. Explicitly, this means that acting with $\prod_{i \in \Lambda} \rho(g)_i$ on $\Psi(\theta_a)$ for any a results in an injective MPS proportional to $\Psi(\theta_{g(a)})$, where $g(a)$ refers to the image of a under the action of g , for every $g \in G$. The fact that this is true for any system size $|\Lambda|$ implies by the *fundamental theorem* of MPS the existence of linear maps $\phi^{g,a} : \mathbb{C}_g \otimes M_a \rightarrow M_{g(a)}$ and $\bar{\phi}^{g,a} : M_{g(a)} \rightarrow \mathbb{C}_g \otimes M_a$ such that [SPGC11, CGW11, GRLM22]

$$(2.19)$$

and

$$(2.20)$$

for every label a and $g \in G$. Physically, one can also interpret this local action as a consequence of the topological invariance of the symmetry lines. These relations imply that the fixed points of the MPS transfer matrix (2.7) satisfy

$$(2.21)$$

Since $\Xi_{g(a)}$ is the unique fixed point of $\Xi_{\theta_{g(a)}}$, we conclude

$$\begin{array}{c} \bar{\phi}^{g,a} \\ \circ \\ \begin{array}{l} \xrightarrow{g(a)} \\ \xrightarrow{a} \end{array} \\ \downarrow g \\ \begin{array}{l} \xrightarrow{g(a)} \\ \xrightarrow{a} \end{array} \\ \circ \\ \phi^{g,a} \end{array} \Xi_a = \begin{array}{c} \begin{array}{l} \xrightarrow{g(a)} \\ \xrightarrow{a} \end{array} \\ \circ \\ \Xi_{g(a)} \\ \begin{array}{l} \xrightarrow{g(a)} \\ \xrightarrow{a} \end{array} \end{array} . \quad (2.22)$$

Now, consider the actions of two symmetry lines associated with simple objects \mathbb{C}_{g_1} and \mathbb{C}_{g_2} in Vec_G , respectively. Instead of successively acting with both lines, one can first (locally) fuse them before (locally) acting with the resulting line associated with $\mathbb{C}_{g_1 g_2} \in \text{Vec}_G$. Given that $g_1(g_2(a)) = (g_1 g_2)(a)$, for every label a and $g_1, g_2 \in G$, we have the following relation:⁹

$$\begin{array}{c} \begin{array}{c} \begin{array}{c} \xrightarrow{g_1} \\ \xrightarrow{g_1 g_2} \end{array} \\ \circ \\ \begin{array}{c} \xrightarrow{g_2} \\ \xrightarrow{a} \end{array} \end{array} \\ \downarrow \\ \begin{array}{c} \begin{array}{c} \xrightarrow{g_1} \\ \xrightarrow{g_1 g_2} \end{array} \\ \circ \\ \begin{array}{c} \xrightarrow{g_2} \\ \xrightarrow{a} \end{array} \end{array} \\ \downarrow \\ \begin{array}{c} \begin{array}{c} \xrightarrow{g_1} \\ \xrightarrow{g_2(a)} \end{array} \\ \circ \\ \begin{array}{c} \xrightarrow{a} \\ \xrightarrow{a} \end{array} \end{array} \end{array} = \begin{array}{c} \begin{array}{c} \xrightarrow{g_1} \\ \xrightarrow{g_2(a)} \end{array} \\ \circ \\ \begin{array}{c} \xrightarrow{a} \\ \xrightarrow{a} \end{array} \end{array} \end{array} . \quad (2.23)$$

From orthogonality conditions (2.17) and (2.20) follow the existence of complex numbers $\alpha^{\triangleright}(g_1, g_2)(a) \in \mathbb{C}$ satisfying

$$\begin{array}{c} \begin{array}{c} \xrightarrow{g_1} \\ \xrightarrow{g_1 g_2} \end{array} \\ \circ \\ \begin{array}{c} \xrightarrow{g_2} \\ \xrightarrow{a} \end{array} \end{array} \begin{array}{c} \xrightarrow{g_1} \\ \xrightarrow{g_2} \end{array} \begin{array}{c} \xrightarrow{a} \\ \xrightarrow{a} \end{array} = \alpha^{\triangleright}(g_1, g_2)(a) \begin{array}{c} \begin{array}{c} \xrightarrow{g_1} \\ \xrightarrow{g_1 g_2} \end{array} \\ \circ \\ \begin{array}{c} \xrightarrow{a} \\ \xrightarrow{a} \end{array} \end{array} . \quad (2.24)$$

Explicitly, these complex numbers evaluate to

$$\begin{array}{c} \begin{array}{c} \xrightarrow{g_1} \\ \xrightarrow{g_1 g_2} \end{array} \\ \circ \\ \begin{array}{c} \xrightarrow{g_2} \\ \xrightarrow{a} \end{array} \end{array} \begin{array}{c} \xrightarrow{g_1} \\ \xrightarrow{g_2} \end{array} \begin{array}{c} \xrightarrow{a} \\ \xrightarrow{a} \end{array} = \alpha^{\triangleright}(g_1, g_2)(a) \mathbb{1}_{M_{g_1(g_2(a))}} . \quad (2.25)$$

Now, consider the actions of three symmetry lines associated with simple objects \mathbb{C}_{g_1} , \mathbb{C}_{g_2} and \mathbb{C}_{g_3} in Vec_G , respectively. Instead of successively acting with the three lines, one can instead fuse the first two, fuse the resulting line associated with $\mathbb{C}_{g_1 g_2} \in \text{Vec}_G$ with the third one, before acting with the resulting line associated with $\mathbb{C}_{g_1 g_2 g_3} \in \text{Vec}_G$. Using eq. (2.18) and eq. (2.24), one can relate the resulting combinations of lines in two different ways, which requires that the equation

$$\alpha^{\triangleright}(g_2, g_3)(a) \alpha^{\triangleright}(g_1, g_2 g_3)(a) = \alpha^{\triangleright}(g_1 g_2, g_3)(a) \alpha^{\triangleright}(g_1, g_2)(g_3(a)) \quad (2.26)$$

holds for every label a and $g_1, g_2, g_3 \in G$. Note that the linear maps $\{\phi^{g,a}\}_{g \in G, a}$ are only defined up to multiplicative phase factors so that we actually have an equivalence class of complex numbers $\alpha^{\triangleright}(g_1, g_2)(a) \in \mathbb{C}$ satisfying eq. (2.26) (see below).

⁹Note that some labels are occasionally omitted for visual clarity; however, these can always be unambiguously deduced from those remaining.

It turns out that any collection $\{\phi^{g,a}\}_{g \in G, a}$ of linear maps satisfying (2.24) such that eq. (2.26) holds provides the input datum of a (\mathbb{C} -linear) *module category* over \mathbf{Vec}_G (see app. A for definition). Moreover, by block-injectivity of $\Psi(\theta)$, this module category is *finite* and *semisimple* so that the set of labels that index the injective blocks provides the set of isomorphism classes of simple objects of the module category. Therefore, the classification of G -symmetric gapped phases in terms of G -symmetric block-injective MPSs reduces to the classification of *indecomposable* (finite semisimple) module categories over \mathbf{Vec}_G . Note that this is compatible with the hypothesis that gapped phases are described at long distances by topological quantum field theories (TQFTs). Indeed, 2d TQFTs that can be coupled to topological lines in \mathbf{Vec}_G are classified by indecomposable (finite semisimple) module categories over \mathbf{Vec}_G [Tur10].

2.3 Classification

Let us now recall the classification of indecomposable module categories over \mathbf{Vec}_G . As reviewed in app. A, module categories over \mathbf{Vec}_G can be constructed from algebra objects in \mathbf{Vec}_G . By definition, an algebra in \mathbf{Vec}_G is a G -graded algebra, i.e., a G -graded vector space $A = \bigoplus_{g \in G} A_g$ that is equipped with a grading preserving multiplication so that $A_{g_1} A_{g_2} \subseteq A_{g_1 g_2}$, for every $g_1, g_2 \in G$. For instance, let $H \leq G$ be a subgroup and β be a normalised representative of a cohomology class in $H^2(H, \mathbb{U}(1))$. The twisted group algebra $\mathbb{C}[H]^\beta$ is G -graded, as a result of H being a subgroup of G . We denote the corresponding algebra object by $A[H, \beta]$. For every algebra $\text{End}(V)$ of endomorphisms of a finite-dimensional complex vector space V , $\mathbb{C}[H]^\beta \otimes \text{End}(V)$ also carries the structure of an algebra object in \mathbf{Vec}_G , which happens to be *Morita equivalent* to $A[H, \beta]$. Let $\mathcal{M}(H, \beta)$ be the category $\text{Mod}_{\mathbf{Vec}_G}(A[H, \beta])$ of right $A[H, \beta]$ -modules in \mathbf{Vec}_G . By construction, $\mathcal{M}(H, \beta)$ carries the structure of a left \mathbf{Vec}_G -module category.

Concretely, $\mathcal{M}(H, \beta)$ is equivalent to the indecomposable finite semisimple \mathbf{Vec}_G -module category of G/H -graded vector spaces. Let $\{r_a\}_{a=1, \dots, (G:H)}$ be a choice of representatives in G for the set of left cosets in G/H such that $r_1 = 1_G$. Representatives of isomorphism classes of simple objects in $\mathcal{M}(H, \beta)$ are provided by the one-dimensional vector spaces $\{\mathbb{C}_{r_a H}\}_{a=1, \dots, (G:H)}$ such that $(\mathbb{C}_{r_{a_1} H})_{r_{a_2} H} = \delta_{a_1, a_2} \mathbb{C}$. For every $g \in G$ and $r_a H \in G/H$, there is a unique $g(a) \in \{1, \dots, (G:H)\}$ such that $g \cdot r_a H = r_{g(a)} H$. The simple object $\mathbb{C}_g \in \mathbf{Vec}_G$ acts on $M = \bigoplus_{a=1}^{(G:H)} M_{r_a H}$ via the action of G on cosets as $\mathbb{C}_g \triangleright M = \bigoplus_{a=1}^{(G:H)} M_{r_{g^{-1}(a)} H}$. In particular, we have $\mathbb{C}_g \triangleright \mathbb{C}_{r_a H} = \mathbb{C}_{g \cdot r_a H} = \mathbb{C}_{r_{g(a)} H}$, for every $g \in G$ and $a \in \{1, \dots, (G:H)\}$. This provides the action bifunctor $\triangleright : \mathbf{Vec}_G \times \mathcal{M}(H, \beta) \rightarrow \mathcal{M}(H, \beta)$. Constructing the module associator α^\triangleright relies on a corollary of *Shapiro's lemma* stating that

$$H^2(H, \mathbb{U}(1)) \cong H^2(G, \text{Fun}(G/H, \mathbb{U}(1))), \quad (2.27)$$

where the right G -module structure of the abelian group $\text{Fun}(G/H, \mathbb{U}(1))$ is given by $(f \cdot g)(-) = f(g \cdot -)$, for every $f \in \text{Fun}(G/H, \mathbb{U}(1))$ and $g \in G$. Indeed, since for each $g \in G$ and $r_a H \in G/H$ there is a unique $g(a) \in \{1, \dots, (G:H)\}$ such that $g \cdot r_a H = r_{g(a)} H$, there is a unique group element $h_{g,a} \in H$ such that $gr_a = r_{g(a)} h_{g,a}$. Associativity of the multiplication in G imposes that

$$h_{g_1, g_2(a)} h_{g_2, a} = h_{g_1 g_2, a}, \quad (2.28)$$

for every $g_1, g_2 \in G$ and $r_a H \in G/H$. The module associator α^\triangleright is specified by isomorphisms

$$\alpha^\triangleright(g_1, g_2)(r_a H) \cdot \text{id}_{\mathbb{C}_{(g_1 g_2) \cdot r_a H}} : (\mathbb{C}_{g_1} \otimes \mathbb{C}_{g_2}) \triangleright \mathbb{C}_{r_a H} \xrightarrow{\cong} \mathbb{C}_{g_1} \triangleright (\mathbb{C}_{g_2} \triangleright \mathbb{C}_{r_a H}), \quad (2.29)$$

where the 2-cochain $\alpha^\triangleright \in C^2(G, \text{Fun}(G/H, \mathbb{U}(1)))$ is defined via

$$\alpha^\triangleright(g_1, g_2)(r_a H) := \beta(h_{g_1, g_2(a)}, h_{g_2, a}), \quad (2.30)$$

for every $g_1, g_2 \in G$ and $r_a H \in G/H$. It then follows from the 2-cocycle satisfied by β that $\alpha^\triangleright \in Z^2(G, \text{Fun}(G/H, \text{U}(1)))$, i.e.

$$\alpha^\triangleright(g_2, g_3)(r_a H) \alpha^\triangleright(g_1, g_2 g_3)(r_a H) = \alpha^\triangleright(g_1 g_2, g_3)(r_a H) \alpha^\triangleright(g_1, g_2)(g_3 \cdot r_a H), \quad (2.31)$$

for every $g_1, g_2, g_3 \in G$ and $r_a H \in G/H$, which in turn ensures that α^\triangleright fulfils the required *pentagon axiom* (see app. A). This precisely amounts to eq. (2.26) in the case where the set of labels that index the injective blocks of the block-injective MPS is given by G/H .

It turns out that every indecomposable finite semisimple Vec_G -module category is of the form $\mathcal{M}(H, \beta) = \text{Mod}_{\text{Vec}_G}(\mathbb{C}[H]^\beta)$ for some subgroup $H \leq G$ and 2-cocycle β in $Z^2(H, \text{U}(1))$ [Ost02, Nai0d, EGNO16]. Conversely, for every simple object $\mathbb{C}_{r_a H}$ in $\mathcal{M}(H, \beta)$, one can verify that the *internal hom* $\underline{\text{Hom}}(\mathbb{C}_{r_a H}, \mathbb{C}_{r_a H})$ is provided by $\bigoplus_{h \in H} \mathbb{C}_{r_a h r_a^{-1}}$, as an object in Vec_G (see app. A for definition). The multiplication of the algebra object $\underline{\text{Hom}}(\mathbb{C}_{r_a H}, \mathbb{C}_{r_a H})$ is that of $\mathbb{C}[r_a H r_a^{-1}]$ twisted by the 2-cocycle β^{r_a} such that $\beta^{r_a}(r_a h_1 r_a^{-1}, r_a h_2 r_a^{-1}) = \beta(h_1, h_2) = \alpha^\triangleright(r_a h_1 r_a^{-1}, r_a h_2 r_a^{-1})(r_a H)$, for every $h_1, h_2 \in H$. This algebra is Morita equivalent to $\mathbb{C}[H]^\beta$, as expected.

Naturally, one recovers the well-known classification of G -symmetric one-dimensional gapped phases [CGW11, SPGC11]. In particular, $\mathcal{M}(\{1_G\}, 1) = \text{Vec}_G$ corresponds to the phase where the whole symmetry is spontaneously broken, while $\mathcal{M}(G, \beta)$ labels a symmetry protected topological (SPT) phase whose edge modes transform according to β -projective representations of the group. In other words, no topological lines are preserved in the ground state subspace of the gapped phase labelled by $\mathcal{M}(\{1_G\}, 1)$, whereas the unique ground state of the gapped phase labelled by $\mathcal{M}(G, \beta)$ preserves an algebra object of topological lines that is Morita equivalent to $A[G, \beta]$. More generally, we state that $\mathcal{M}(H, \beta)$ labels the spontaneously symmetry broken phase where each ground state in the $(G : H)$ -dimensional ground state subspace preserves an algebra object of topological lines that is Morita equivalent to $A[H, \beta]$. In particular, we wish to emphasise that we should not think of the symmetry Vec_G as spontaneously broken to a subsymmetry—or to any symmetry, for that matter—that would be encoded in a fusion category. This does not involve the appropriate level of abstraction, as the amount of symmetry preserved in any ground state is rather captured by an algebra object in Vec_G . This rephrasing of the usual classification will turn out to be crucial in sec. 4.

2.4 Renormalisation group fixed points

Let H be a subgroup of G and β a normalised representative of a cohomology class in $H^2(H, \text{U}(1))$. Suppose we want to construct ground states at some renormalisation group fixed point of the Vec_G -symmetric gapped phase labelled by the Vec_G -module category $\mathcal{M}(H, \beta)$. We already know that $\mathcal{M}(H, \beta)$ is equivalent to the category of right modules in Vec_G over an algebra object in Vec_G that is Morita equivalent to $A[H, \beta]$. We could use this information to build the renormalisation group fixed points as in ref. [BBSNT24]; however this choice would not be compatible with the choice of microscopic Hilbert space we made in sec. 2.1. Indeed, recall that in this manuscript one realises the symmetry Vec_G via a choice of object in $\text{Rep}(G)$. Implicitly, we are employing the result that the *Morita dual* $(\text{Vec}_G)_{\text{Vec}}^* := \text{Fun}_{\text{Vec}_G}(\text{Vec}, \text{Vec})$ of Vec_G with respect to the Vec_G -module category Vec is equivalent to $\text{Rep}(G)$ [LDOV21] (see app. A for definitions). It follows that indecomposable left Vec_G -module $\mathcal{M}(H, \beta)$ can also be realised as the category of left modules (in Vec) over an indecomposable finite separable algebra object in $\text{Rep}(G)$ [Mom10]. This is the realisation that is compatible with our choice of microscopic Hilbert space [Ina21, DHY24]. To identify a suitable algebra object in $\text{Rep}(G)$, one must first invoke the 2-equivalence (see app. A)

$$\text{Fun}_{\text{Vec}_G}(\text{Vec}, -) : \text{Mod}(\text{Vec}_G) \rightarrow \text{Mod}(\text{Rep}(G)^{\text{op}}), \quad (2.32)$$

which establishes the one-to-one correspondence between Vec_G -module categories and $\text{Rep}(G)$ -module categories. In particular, one can check that $\text{Fun}_{\text{Vec}_G}(\text{Vec}, \mathcal{M}(H, \beta))$ is equivalent to the category $\text{Rep}^\beta(H)$ of finite-dimensional β -projective representations of H (see ref. [DI24] for an explicit derivation), where the $\text{Rep}(G)$ -module structure of $\text{Rep}^\beta(H)$ is simply given by the monoidal structure of Vec via the *restriction functor* $\text{Res}_H^G : \text{Rep}(G) \rightarrow \text{Rep}(H)$. It follows that any algebra object A in $\text{Rep}(G)$ such that $\text{Mod}_{\text{Rep}(G)}(A)$ is equivalent to $\text{Rep}^\beta(H)$, as a $\text{Rep}(G)$ -module category, is suitable.

Following ref. [Ost01, Dav10], let us construct such an algebra given a pair (H, β) . First of all, recall that algebra objects in $\text{Rep}(G)$ are G -equivariant algebras, i.e., algebras (in Vec) with a (left) G -action that is compatible with the multiplication. Let U be a simple object in $\text{Rep}^\beta(H)$ and let $\pi : \mathbb{C}[H]^\beta \rightarrow \text{End}_{\mathbb{C}}(U)$ denotes the corresponding algebra homomorphism between the twisted group algebra $\mathbb{C}[H]^\beta = \mathbb{C}\{e_h\}_{h \in H}$ and the algebra $\text{End}_{\mathbb{C}}(U)$ of endomorphisms of U . The algebra homomorphism equips the algebra $\text{End}_{\mathbb{C}}(U)$ with an H -equivariant structure, whereby $h \cdot f := \pi(e_h) f \pi(e_h)^{-1} \equiv \pi(h) f \pi(h)^{-1}$, for every $h \in H$ and $f \in \text{End}_{\mathbb{C}}(U)$. We promote this algebra object in $\text{Rep}(H)$ to an algebra object in $\text{Rep}(G)$ via the *induction functor* $\text{Ind}_H^G : \text{Rep}(H) \rightarrow \text{Rep}(G)$:

$$A(H, \beta, U) \equiv \text{Ind}_H^G(\text{End}_{\mathbb{C}}(U)) := \mathbb{C}\{\sigma : G \rightarrow \text{End}_{\mathbb{C}}(U) \mid \sigma(gh^{-1}) = h \cdot \sigma(g)\}_{g \in G, h \in H}. \quad (2.33)$$

The algebraic structure of $A(H, \beta, U)$ is provided by *pointwise* multiplication; its G -equivariant structure is given by $(g \cdot \sigma)(-) = \sigma(g^{-1} -)$, for every $\sigma \in A(H, \beta, U)$ and $g \in G$. Whenever $\beta = 1$, one can always choose U to be the trivial representation, at which point $A(H, 1)$ boils down to the algebra $\mathbb{C}(G/H)$ of functions $G/H \rightarrow \mathbb{C}$ with pointwise multiplication. As an object in $\text{Rep}(G)$, $\mathbb{C}(G/H)$ is isomorphic to the induced representation $\text{Ind}_H^G(\mathbb{C})$.

Let us examine the G -equivariant structure of the algebra $A(H, \beta, U)$ in more detail. As in sec. 2.3, let $\{r_a\}_{a=1, \dots, (G:H)}$ denote a set of representatives for the left cosets in G/H . For each $g \in G$, there is a unique $a \in \{1, \dots, (G:H)\}$ such that $g \in r_a H$; therefore, there is a unique $h \in H$ such that $g = r_a h$. Given $f \in \text{End}_{\mathbb{C}}(U)$, define the function $\sigma_{a,f} : G \rightarrow \text{End}_{\mathbb{C}}(U)$ via

$$\sigma_{a,f}(g) = \begin{cases} \pi(h)^{-1} f \pi(h) & \text{if } g \equiv r_a h \in r_a H, \\ 0 & \text{otherwise,} \end{cases} \quad (2.34)$$

for every $g \in G$. By definition, $\sigma_{a,f} \in A(H, \beta, U)$, for every $a \in \{1, \dots, (G:H)\}$ and $f \in \text{End}_{\mathbb{C}}(U)$. For a fixed $a \in \{1, \dots, (G:H)\}$, consider the vector space $\mathbb{C}\{\sigma_{a,f} \mid f \in \text{End}_{\mathbb{C}}(U)\}$. Clearly, it defines a subalgebra of $A(H, \beta, U)$ which is isomorphic to $\text{End}_{\mathbb{C}}(U)$. As a matter of fact, we have

$$\mathbb{C}\{\sigma_{a,f} \mid f \in \text{End}_{\mathbb{C}}(U)\} \cong \mathbb{C}\{\sigma \in A(H, \beta, U) \mid \sigma(g) = 0 \text{ if } g \notin r_a H\} =: A(H, \beta, U)_{(a)}. \quad (2.35)$$

Moreover, for every function $\sigma \in A(H, \beta, U)$ we have the following decomposition:

$$\sigma = \sum_{a=1}^{(G:H)} \sigma_{a,f_a}, \quad (2.36)$$

where $f_a := \sigma(r_a) \in \text{End}_{\mathbb{C}}(U)$. One can further check that this decomposition is actually unique, which in turn induces the following decomposition of $A(H, \beta, U)$, as an algebra in Vec :

$$A(H, \beta, U) \cong \bigoplus_{a=1}^{(G:H)} A(H, \beta, U)_{(a)}. \quad (2.37)$$

Therefore, it is enough to examine the action of G on functions $\sigma_{a,f}$, for every $a \in \{1, \dots, (G:H)\}$ and $f \in \text{End}_{\mathbb{C}}(U)$. By definition, $(g \cdot \sigma_{a,f})(x) = \sigma_{a,f}(g^{-1}x)$, for every $g, x \in G$, which is non-zero if

and only if $x \in g \cdot r_a H = r_{g(a)} H$. Moreover, recall that for each $g \in G$ and $r_a H \in G/H$, there is a unique $h_{g,a} \in H$ such that $gr_a = r_{g(a)} h_{g,a}$. Suppose that $x \equiv r_{g(a)} h \in r_{g(a)} H$, we find

$$\begin{aligned} (g \cdot \sigma_{a,f})(x) &= \sigma_{a,f}(r_a h_{g,a}^{-1} r_{g(a)}^{-1} r_{g(a)} h) \\ &= (h^{-1} h_{g,a}) \cdot \sigma_{a,f}(r_a) = \pi(h^{-1} h_{g,a}) f \pi(h^{-1} h_{g,a})^{-1}, \end{aligned} \quad (2.38)$$

which implies that

$$g \cdot \sigma_{a,f} = \sigma_{g(a), \pi(h_{g,a}) f \pi(h_{g,a})^{-1}}. \quad (2.39)$$

Given $U = \mathbb{C}\{u_b\}_{b=1, \dots, \dim_{\mathbb{C}} U}$, we have $\text{End}_{\mathbb{C}}(U) = \mathbb{C}\{u_{b_1} \otimes u_{b_2}\}_{b_1, b_2=1, \dots, \dim_{\mathbb{C}} U}$ and thus $A(H, \beta, U) = \mathbb{C}\{\sigma_{a, u_{b_1} \otimes u_{b_2}}\}_{a, b_1, b_2}$. We conclude this presentation of the algebra $A(H, \beta, U)$ by mentioning that it can always be endowed the structure of a Δ -separable symmetric Frobenius algebra [FRS02, FS09, KZ17] making in particular $A(H, \beta, U)$ a coalgebra whose comultiplication rule descends from the multiplication of $A(H, \beta, U)$.

We are now ready to confirm that the category $\text{Mod}(A(H, \beta, U))$ of modules over the G -equivariant algebra is equivalent to the Vec_G -module category $\mathcal{M}(H, \beta)$. Consider a module over $A(H, \beta, U)$. It follows from eq. (2.37) and $A(H, \beta, U)_{(a)} \cong \text{End}_{\mathbb{C}}(U)$ that this module is G/H -graded such that, for every $a \in \{1, \dots, (G : H)\}$, homogeneous components of degree a span a vector space isomorphic to U . In particular, given u such that $|u| = r_a H \in G/H$, each $\sigma \in A(H, \beta, U)$ acts as $\sigma \cdot u = \sigma(r_a)(u)$. Therefore, we already know that $\text{Mod}(A(H, \beta, U))$ is equivalent to $\mathcal{M}(H, \beta)$ as a category. We are left to confirm the Vec_G -module structure, which descends from the G -equivariant structure of $A(H, \beta, U)$. Let $U_{r_a H}$ be a simple module over $A(H, \beta, U)$ such that $(U_{r_a H})_{r_a H} \cong U$. For every $\mathbb{C}_g = \mathbb{C}\{e_g\} \in \text{Vec}_G$, we define $\mathbb{C}_g \triangleright U_{r_a H}$ to be $\mathbb{C}_g \otimes U_{r_a H}$ as a vector space. The $A(H, \beta, U)$ -module structure on $\mathbb{C}_g \otimes U_{r_a H}$ is provided by

$$\sigma \cdot (e_g \otimes u) = e_g \otimes (g^{-1} \cdot \sigma) \cdot u, \quad (2.40)$$

for every $u \in U_{r_a H}$ and $\sigma \in A(H, \beta, U)$, so that, in particular, we have

$$(g \cdot \sigma_{a,f})(e_g \otimes u) = e_g \otimes f(u). \quad (2.41)$$

From eq. (2.39), we deduce that $e_g \otimes u$ must be homogeneous of degree $r_{g(a)} H \in G/H$ so that $\mathbb{C}_g \triangleright U_{r_a H} \cong U_{r_{g(a)} H}$. Let $\phi^{g,a} : e_g \otimes u \mapsto \pi(h_{g,a})(u)$ implement the isomorphism $\mathbb{C}_g \triangleright U_{r_a H} \cong U_{r_{g(a)} H}$. It is indeed compatible with eq. (2.41) since, by virtue of eq. (2.39),

$$(g \cdot \sigma_{a,f})(\phi^{g,a}(e_g \otimes u)) = (g \cdot \sigma_{a,f})(\pi(h_{g,a})(u)) = \pi(h_{g,a})(f(u)) = \phi^{g,a}(e_g \otimes f(u)). \quad (2.42)$$

It now remains to compute the module associator. For every $\mathbb{C}_{g_1}, \mathbb{C}_{g_2}$ and $U_{r_a H} \in \text{Mod}(A(H, \beta, U))$, isomorphisms $(\mathbb{C}_{g_1} \otimes \mathbb{C}_{g_2}) \triangleright U_{r_a H} \cong U_{r_{(g_1 g_2)(a)} H}$ and $\mathbb{C}_{g_1} \triangleright (\mathbb{C}_{g_2} \triangleright U_{r_a H}) \cong U_{r_{(g_1 g_2)(a)} H}$ are implemented by

$$\begin{aligned} e_{g_1} \otimes e_{g_2} \otimes u &\longmapsto e_{g_1 g_2} \otimes u \xrightarrow{\phi_{g_1 g_2, a}} \pi(h_{g_1 g_2, a})(u) \\ \text{and } e_{g_1} \otimes e_{g_2} \otimes u &\xrightarrow{\text{id}_{\mathbb{C}_{g_1}} \otimes \phi_{g_2, a}} e_{g_1} \otimes \pi(h_{g_2, a})(u) \xrightarrow{\phi_{g_1, g_2(a)}} \pi(h_{g_1, g_2(a)})(\pi(h_{g_2, a})(u)), \end{aligned} \quad (2.43)$$

respectively. It finally follows from eq. (2.28) that these isomorphisms differ by $\beta(h_{g_1, g_2(a)}, h_{g_2, a})$, which reproduces the expected module associator of $\mathcal{M}(H, \beta)$ as per eq. (2.30). Note that choosing a different map implementing the isomorphism $\mathbb{C}_g \triangleright U_{r_a H} \cong U_{r_{g(a)} H}$ would result in a 2-cocycle in

the same cohomology class. This completes the demonstration that $\text{Mod}(A(H, \beta, U)) \simeq \mathcal{M}(H, \beta)$, as Vec_G -module categories.

Exploiting the previous derivation, let us construct the ground state subspace of a renormalisation group fixed point associated with $\mathcal{M}(H, \beta)$. Our exposition is closely related to that of ref. [KTY16]. Vacua are labelled by simple objects in $\mathcal{M}(H, \beta)$, which we just realised as the category of left modules over the algebra $A(H, \beta, U)$. Every such $A(H, \beta, U)$ -module also possesses the structure of a left *comodule* over $A(H, \beta, U)^{*,\text{cop}}$, which is the dual coalgebra $A(H, \beta, U)^*$ with coopposite comultiplication. It follows from $A(H, \beta, U)$ being endowed the structure of a Δ -separable Frobenius algebra that the coalgebra $A(H, \beta, U)^{*,\text{cop}}$ also possesses the structure of an algebra whose multiplication rule is the opposite of that of the dual Frobenius algebra, thereby inviting us to consider $A(H, \beta, U)^{*,\text{op},\text{cop}}$. Therefore, we take ground states to span a subspace of the tensor product space $\bigotimes_{i \in \Lambda} A(H, \beta, U)_{\{i\}}^*$ obtained by choosing the local vector space to be $A(H, \beta, U)^* \equiv \mathbb{C}\{\sigma_{a,u^{b_1} \otimes u^{b_2}}\}_{a,b_1,b_2}$.¹⁰ Physically, one typically wants to think of $\bigotimes_{i \in \Lambda} A(H, \beta, U)_{\{i\}}^*$ as being itself a subspace of a microscopic Hilbert space $\mathcal{H}_\Lambda = \bigotimes_{i \in \Lambda} V_{\{i\}}$, where $V \in \text{Rep}(G)$ is a faithful representation such that $A(H, \beta, U)^* \hookrightarrow V$. The action of topological lines in Vec_G on this Hilbert space is provided by the G -equivariant structure of $A(H, \beta, U)^*$ so that $\rho : \mathbb{C}[G] \rightarrow \text{End}_{\mathbb{C}}(A(H, \beta, U)^*)$ is given by

$$\begin{aligned} \rho(g)(\sigma_{a,u^{b_2} \otimes u^{b_4}}) &:= g \cdot \sigma_{a,u^{b_2} \otimes u^{b_4}} = \sigma_{g(a),h_{g,a} \cdot u^{b_2}, h_{g,a} \cdot u^{b_4}} \\ &= \sum_{b_1, b_3} \pi(h_{g,a}^{-1})_{b_1}^{b_2} \pi(h_{g,a})_{b_4}^{b_3} \sigma_{g(a),u^{b_1} \otimes u^{b_3}}, \end{aligned} \quad (2.44)$$

for every $g \in G$, $a \in \{1, \dots, (G : H)\}$ and $b_2, b_4 \in \{1, \dots, \dim_{\mathbb{C}} U\}$. For every simple object $U_{r_a H} \in \text{Mod}(A(H, \beta, U))$, with $a \in \{1, \dots, (G : H)\}$, let $\theta_a : U_{r_a H} \rightarrow A(H, U, \beta)^* \otimes U_{r_a H}$ denote the left $A(H, U, \beta)^{*,\text{op},\text{cop}}$ -comodule structure of $U_{r_a H}$. For every $a \in \{1, \dots, (G : H)\}$, we write

$$\theta_a \equiv \sum_{b_1, b_2=1}^{\dim_{\mathbb{C}} U} \theta_{a,b_2}^{b_1} u_{b_1} \otimes u^{b_2} \quad (2.45)$$

such that $\theta_{a,b_2}^{b_1} \in A(H, \beta, U)^*$. Assuming closed periodic boundary conditions, one associates to the tensor θ_a the following injective MPS in $\bigotimes_{i \in \Lambda} A(H, \beta, U)_{\{i\}}^*$:

$$\Psi(\theta_a) := \sum_{b_1, \dots, b_{|\Lambda|}} \theta_{a,b_2}^{b_1} \otimes \theta_{a,b_3}^{b_2} \otimes \dots \otimes \theta_{a,b_1}^{b_{|\Lambda|}}. \quad (2.46)$$

But, it follows from the definitions that

$$\theta_{a,b_2}^{b_1} = \sigma_{a,u^{b_1} \otimes u^{b_2}}, \quad (2.47)$$

for every $a \in \{1, \dots, (G : H)\}$ and $b_1, b_2 \in \{1, \dots, \dim_{\mathbb{C}} U\}$. Therefore, the previous formula boils down to

$$\Psi(\theta_a) = \sum_{b_1, \dots, b_\Lambda} \sigma_{a,u^{b_1} \otimes u^{b_2}} \otimes \sigma_{a,u^{b_2} \otimes u^{b_3}} \otimes \dots \otimes \sigma_{a,u^{b_{|\Lambda|}} \otimes u^{b_1}}. \quad (2.48)$$

¹⁰These manipulations are required by the fact that we defined in sec. 2.1 the MPS tensors as linear maps of the form $M \rightarrow V \otimes M$.

A topological line labelled by $\mathbb{C}_g \in \text{Vec}_G$ acts on this MPS as

$$\begin{aligned} \left(\prod_{i \in \Lambda} \rho(g)_i \right) \Psi(\theta_a) &= \sum_{b_1, \dots, b_{|\Lambda|}} (g \cdot \sigma_{a, u^{b_1} \otimes u^{b_2}}) \otimes \cdots \otimes (g \cdot \sigma_{a, u^{b_{|\Lambda|}} \otimes u^{b_1}}) \\ &= \sum_{b_1, \dots, b_{|\Lambda|}} \sigma_{g(a), u^{b_1} \otimes u^{b_2}} \otimes \cdots \otimes \sigma_{g(a), u^{b_{|\Lambda|}} \otimes u^{b_1}} = \Psi(\theta_{g(a)}), \end{aligned} \quad (2.49)$$

where we used eq. (2.44). As expected, acting with topological lines $\mathbb{C}_g \in \text{Vec}_G$ permutes ground states via the left action of the group on G/H . It follows that for each $a \in \{1, \dots, (G : H)\}$, topological lines labelled by $\mathbb{C}_{r_a h r_a^{-1}} \in \text{Vec}_G$, for every $r_a h r_a^{-1}$ in the stabiliser $r_a H r_a^{-1}$ of $r_a H \in G/A$, leave the ground state associated with $r_a H \in G/H$ invariant. Finally, it follows from our verification of $\text{Mod}(A(H, \beta, U)) \simeq \mathcal{M}(H, \beta)$ that $\Psi(\theta_a)$ preserves the algebra $\mathbb{C}[r_a H r_a^{-1}]^{\beta^{r_a}}$ of lines in Vec_G . This implies that the resulting G -symmetric block-injective MPS defines a renormalisation group fixed point associated with the gapped phase $\mathcal{M}(H, \beta)$.

SECTION 3

Algebras of order parameters

Within the framework of the previous section, we explain how to construct irreducible multiplets of string operators associated with simple objects in the so-called Drinfel'd centre $\mathcal{Z}(\text{Vec}_G)$ of Vec_G . We then demonstrate that order parameters form Lagrangian algebras in $\mathcal{Z}(\text{Vec}_G)$.

3.1 String operators

We work within the framework of sec. 2.1, whereby the microscopic Hilbert space is of the form $\mathcal{H}_\Lambda = \bigotimes_{i \in \Lambda} V_{\{i\}}$, where V a faithful representation in $\text{Rep}(G)$ with algebra homomorphism $\rho: \mathbb{C}[G] \rightarrow \text{End}_{\mathbb{C}}(V)$ so that the action of the topological line $\mathbb{C}_g \in \text{Vec}_G$ on \mathcal{H}_Λ is given by $\prod_{i \in \Lambda} \rho(g)_i$.

Let us begin with a discussion of multiplets of *local* operators. Note that locality of the operator does not necessarily indicate that the support of the corresponding operator in the algebra \mathcal{A}_Λ is a single site $i \in \Lambda$. Given a simple object W in $\text{Rep}(G)$ with action homomorphism $\varrho: \mathbb{C}[G] \rightarrow \text{End}_{\mathbb{C}}(W)$, one can construct a local operator $\mathcal{O}_i \in \mathcal{A}_\Lambda$ transforming in the representation W if and only if $\text{Hom}_{\text{Rep}(G)}(W \otimes V, V) \equiv \text{Hom}_G(W \otimes V, V)$ is non-trivial. For instance, choosing V to be the *regular* representation $\mathbb{C}(G)$ guarantees that a local operator in \mathcal{A}_Λ supported at a single site can be associated to any simple object in $\text{Rep}(G)$. More generally, since every irreducible representation occurs in some finite tensor power of any faithful representation, a local operator in \mathcal{A}_Λ with finite support can be associated to any simple object in $\text{Rep}(G)$. Henceforth, we assume without loss of generality that V is chosen such that $\text{Hom}_G(W \otimes V, V)$ is non-trivial for every $W \in \text{Irr}(\text{Rep}(G))$.

Given $W \in \text{Rep}(G)$, let $\varphi_V^{WV}: W \otimes V \rightarrow V$ be a choice of G -equivariant map. Let us write $W = \mathbb{C}\{w_c\}_{c=1, \dots, \dim_{\mathbb{C}} W}$. For every $c \in \{1, \dots, \dim_{\mathbb{C}} W\}$, we define $\mathcal{O}(w_c)_i$, for any $i \in \Lambda$, as the embedding of $\mathcal{O}(w_c) := \varphi_V^{WV}(w_c \otimes -) \in \text{End}_{\mathbb{C}}(V)$ into \mathcal{A}_Λ . Graphically,

$$\begin{array}{c} \uparrow \\ \circ \\ \uparrow \end{array} \equiv \begin{array}{c} \uparrow \\ \circ \\ \uparrow \end{array} \xleftarrow{W} \begin{array}{c} \uparrow \\ \circ \\ \uparrow \end{array} \xleftarrow{c} \equiv \mathcal{O}(w_c). \quad (3.1)$$

By virtue of the G -equivariance of φ_V^{WV} , we have

$$\text{Ad}_{\rho(g)}(\mathcal{O}(w_c)) := \rho(g) \mathcal{O}(w_c) \rho(g)^{-1} = g \begin{array}{c} \uparrow \\ \circ \\ \uparrow \\ c \\ \uparrow \\ \circ \\ \uparrow \\ \circ \\ \uparrow \end{array} g = \varphi_V^{WV} \begin{array}{c} \uparrow \\ \circ \\ \uparrow \\ W \\ \leftarrow \\ \circ \\ \leftarrow \\ W \\ \leftarrow \\ c \\ \uparrow \end{array} g = \mathcal{O}(\varrho(g)(w_c)), \quad (3.2)$$

for every $g \in G$, which in turn implies that $\mathcal{O}(w_c)_i$ transforms in the representation W under the action of symmetry lines:

$$\bigotimes_{j \in \Lambda} \text{Ad}_{\rho(g)_j}(\mathcal{O}(w_c)_i) = \mathcal{O}(\varrho(g)(w_c))_i. \quad (3.3)$$

Therefore, every φ_V^{WV} labels a multiplet $\{\mathcal{O}(w_c)_i\}_{c=1, \dots, \dim_{\mathbb{C}} W}$ of local operators transforming in the irreducible representation W . Notice that while the number of multiplets depends on the choice of Hilbert space, the number of local operators in each multiplet is fixed by the dimension of the corresponding representation. Therefore, depending on the Hilbert space, there may be considerable freedom in finding local operators forming a given multiplet.

The same way we define local operators transforming in a representation $W \in \text{Rep}(G)$, every G -equivariant map $\varphi_W^{VW^*} : V \otimes W^* \rightarrow V$ labels a multiplet $\{\mathcal{O}(w^c)_i\}_{c=1, \dots, \dim_{\mathbb{C}} W}$ of local operators transforming in the representation $W^* = \mathbb{C}\{w^c\}_{c=1, \dots, \dim_{\mathbb{C}} W}$. Combining both types of operators, we can consider the operator $\mathcal{O}(w_{c_1})_i \mathcal{O}(w_{c_2})_j$, for any $c_1, c_2 \in \{1, \dots, \dim_{\mathbb{C}} W\}$ and $i, j \in \Lambda$, which transform in the representation $W \otimes W^* \cong \text{End}_{\mathbb{C}}(W)$.

Let us now examine multiplets of *twisted sector local operators*. Loosely, a twisted sector local operator is a local operator that live at the endpoint of a twisting symmetry defect. Since local operators are labelled by objects in $\text{Rep}(G)$ and symmetry defects are labelled by objects in Vec_G , one expects a twisted sector local operator to be associated with a vector space that is both G -equivariant and G -graded. But,

$$\bigotimes_{j \in \Lambda} \text{Ad}_{\rho(g)_j}(\rho(x)_i) = \rho(gxg^{-1})_i, \quad (3.4)$$

for every $g, x \in G$ and $i \in \Lambda$, which requires G -equivariance and G -grading to be compatible with one another.

More formally, define a G -equivariant G -graded vector space as a G -graded vector space $W = \bigoplus_{x \in G} W_x$ together with a collection $\{\varrho(g) : W \xrightarrow{\cong} W\}_{g \in G}$ of automorphisms such that $\varrho(g)(W_x) \subseteq W_{g x g^{-1}}$, for every $g, x \in G$, and $\varrho(g_1)\varrho(g_2) = \varrho(g_1 g_2)$, for every $g_1, g_2 \in G$. Consider the *non-degenerate braided fusion* category Vec_G^G of G -equivariant G -graded vector space and G -equivariant grading preserving linear maps (see app. A for definitions). The monoidal structure is provided by the usual tensor product of G -graded vectors spaces with the group acting diagonally. Since conjugacy classes partition the group, the support of an object in Vec_G^G is a union of conjugacy classes in $\text{Cl}(G)$. Moreover, for every $W \in \text{Vec}_G^G$, we have by definition that $W = \bigoplus_{[x_0] \in \text{Cl}(G)} W_{[x_0]}$ with $W_{[x_0]} := \bigoplus_{x \in [x_0]} W_x$. It follows that

$$\text{Vec}_G^G = \bigoplus_{[x_0] \in \text{Cl}(G)} (\text{Vec}_G^G)_{[x_0]}, \quad (3.5)$$

where $(\mathbf{Vec}_G^G)_{[x_0]}$ is the subcategory consisting of objects $W \in \mathbf{Vec}_G^G$ such that $\text{supp}(W) = [x_0]$. Furthermore, one can show that (see e.g. ref. [DS17])

$$(\mathbf{Vec}_G^G)_{[x_0]} \simeq \mathbf{Mod}(\mathbb{C}[Z_G(x_0)]), \quad (3.6)$$

where $Z_G(x_0)$ denotes the centraliser in G of the representative x_0 of $[x_0]$. Let us briefly review the main argument here. On the one hand, given $W_{[x_0]} \in (\mathbf{Vec}_G^G)_{[x_0]}$, W_{x_0} has the structure of a $\mathbb{C}[Z_G(x_0)]$ -module, by definition. On the other hand, given $\hat{W} = \mathbb{C}\{w_c\}_{c=1, \dots, \dim_{\mathbb{C}} \hat{W}} \in \mathbf{Mod}(\mathbb{C}[Z_G(x_0)])$ with algebra homomorphism $\hat{\rho} : \mathbb{C}[Z_G(x_0)] \rightarrow \text{End}_{\mathbb{C}}(\hat{W})$, the induced representation of \hat{W} in G defined as

$$W \equiv \text{Ind}_{Z_G(x_0)}^G(\hat{W}) = \mathbb{C}\{\varpi : G \rightarrow \hat{W} \mid \varpi(gz^{-1}) = \hat{\rho}(z)(\varpi(g))\}_{g \in G, z \in Z_G(x_0)} \quad (3.7)$$

is a G -equivariant G -graded vector space with support $\text{supp}(W) = [x_0]$. Indeed, mimicking the derivations of sec. 2.4, let $\{r_x\}_{x \in [x_0]}$ be a choice of representatives in G for the left cosets in $G/Z_G(x_0)$.¹¹ For each $g \in G$, there is a unique $x \in [x_0]$ such that $g \in r_x Z_G(x_0)$. Given $c \in \{1, \dots, \dim_{\mathbb{C}} \hat{W}\}$, define the function $\varpi_{x, w_c} : G \rightarrow \hat{W}$ via

$$\varpi_{x, w_c}(g) = \begin{cases} \hat{\rho}(z)^{-1}(w_c) & \text{if } g \equiv r_x z \in r_x Z_G(x_0), \\ 0 & \text{otherwise,} \end{cases} \quad (3.8)$$

for every $g \in G$. One readily verifies that $W = \mathbb{C}\{\varpi_{x, w_c}\}_{x \in [x_0], c=1, \dots, \dim_{\mathbb{C}} \hat{W}}$ such that ϖ_{x, w_c} is homogeneous of degree $|\varpi_{x, w_c}| = x = r_x x_0 r_x^{-1} \in G$. As usual, the G -equivariance structure is given by $(g \cdot \varpi_{x, w_c})(-) = \varpi_{x, w_c}(g^{-1} -)$. Explicitly, for each $g \in G$ and $r_x Z_G(x_0) \in G/Z_G(x_0)$, there is a unique group element $z_{g, x} \in Z_G(x_0)$ such that $gr_x = r_{gx} z_{g, x}$. Suppose that $y \equiv r_{gx} z_{g, x} \in r_{gx} Z_G(x_0)$, we find

$$\begin{aligned} (g \cdot \varpi_{x, w_c})(y) &= \varpi_{x, w_c}(r_x z_{g, x}^{-1} r_{gx}^{-1} r_{gx} z_{g, x}) \\ &= \hat{\rho}(z_{g, x}^{-1})(\varpi_{x, w_c}) \end{aligned} \quad (3.9)$$

which implies that

$$g \cdot \varpi_{x, w_c} = \varpi_{gx} z_{g, x}^{-1}(\varpi_{x, w_c}), \quad (3.10)$$

for every $g \in G$. Therefore, $|g \cdot \varpi_{x, w_c}| = gxg^{-1} = g|\varpi_{x, w_c}|g^{-1}$. This confirms that $W \in (\mathbf{Vec}_G^G)_{[x_0]}$. We can further show that the two functors thus constructed are indeed inverse of each other, up to natural isomorphisms, thereby establishing equivalence (3.6). It follows from eq. (3.5) and (3.6) that simple objects in \mathbf{Vec}_G^G are labelled by pairs $([x_0], \hat{W})$ consisting of a conjugacy class $[x_0] \in \text{Cl}(G)$ and a simple object $\hat{W} \in \mathbf{Mod}(\mathbb{C}[Z_G(x_0)])$.

Given a simple object $([x_0], \hat{W})$ in \mathbf{Vec}_G^G , let us now construct multiplets of twisted sector local operators. As before, let W denote the induced representation $\text{Ind}_{Z_G(x_0)}^G(\hat{W})$ of \hat{W} in G . Let $\varphi_V^{WV} : W \otimes V \rightarrow V$ be a choice of G -equivariant map so that $\varphi_V^{WV}(\varpi_{x, w_c} \otimes -) \in \text{End}_{\mathbb{C}}(V)$, for every $x \in [x_0]$ and $c \in \{1, \dots, \dim_{\mathbb{C}} \hat{W}\}$.¹² By virtue of the G -equivariance of φ_V^{WV} , we have

$$\text{Ad}_{\rho(g)}(\varphi_V^{WV}(\varpi_{x, w_c} \otimes -)) = \varphi_V^{WV}(\varpi_{gx} z_{g, x}^{-1}(\varpi_{x, w_c}) \otimes -), \quad (3.11)$$

for every $g \in G$. By construction, as a G -graded vector space, $W = \bigoplus_{x \in [x_0]} W_x$ such that $\text{supp}(W) = [x_0]$ and $W_x \cong \hat{W}$, for every $x \in [x_0]$. It follows that, for every $x \in [x_0]$, the restriction of $\varphi_V^{WV}(\varpi_{x, w_c} \otimes -)$

¹¹Recall from the orbit-stabiliser theorem that $(G : Z_G(x_0)) = |[x_0]|$.

¹²In order to compute the space of G -equivariant maps φ_V^{WV} , it is useful to recall the ‘projection formula’, which stipulates that $W \otimes V = \text{Ind}_{Z_G(x_0)}^G(\hat{W}) \otimes V \cong \text{Ind}_{Z_G(x_0)}^G(\hat{W} \otimes \text{Res}_{Z_G(x_0)}^G(V))$.

for every $g, x \in G$, where ${}^g x := gxg^{-1}$. Henceforth, we refer to such a tensor network as a ‘tube’. The r.h.s. of eq. (3.16) realises the $*$ -structure of $\text{Tube}(\text{Vec}_G)$, which is verifiably an algebra anti-homomorphism. The multiplication rule of $\text{Tube}(\text{Vec}_G)$ reads

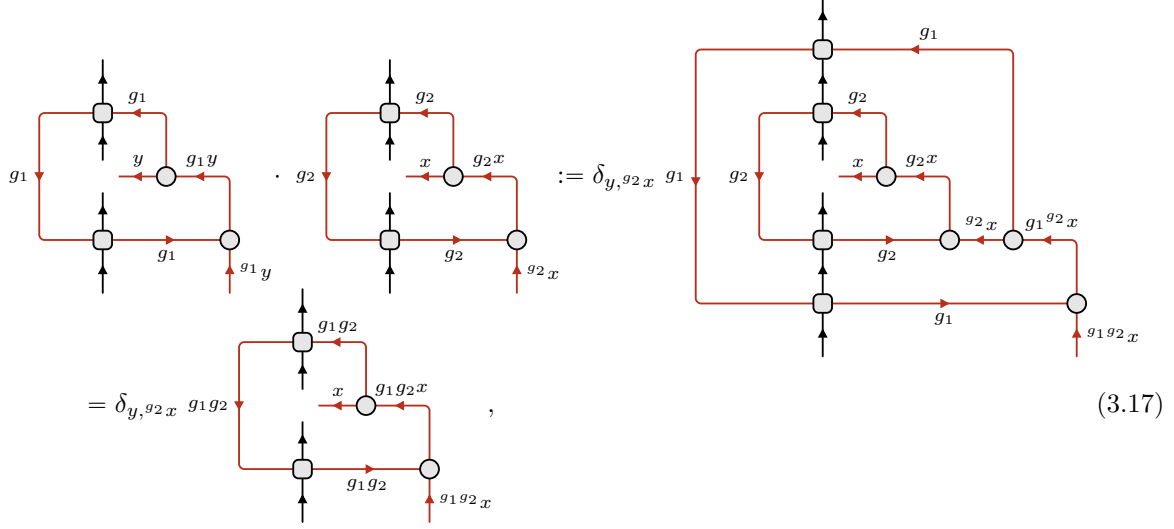

$$\begin{aligned}
 & \left(\text{Tube}(g_1, y) \cdot \text{Tube}(g_2, x) \right) := \delta_{y, g_2 x} \text{Tube}(g_1, g_2 x) \\
 & = \delta_{y, g_2 x} \text{Tube}(g_1 g_2, x) \quad , \quad (3.17)
 \end{aligned}$$

for every $g_1, g_2, x, y \in G$, where we used eq. (2.15) together with eq. (2.18) and eq. (2.17). We are now in a position to verify that twisted sector local operators (3.12) furnish simple modules over $\text{Tube}(\text{Vec}_G)$. Clearly, contracting a tube (3.16) with a tensor (3.12) results in a tensor of the same form. Concretely, acting with the tube labelled by $g, y \in G$ on the tensor labelled by $x \in G$ and $c_2 \in \{1, \dots, \dim_{\mathbb{C}} \hat{W}\}$ results in

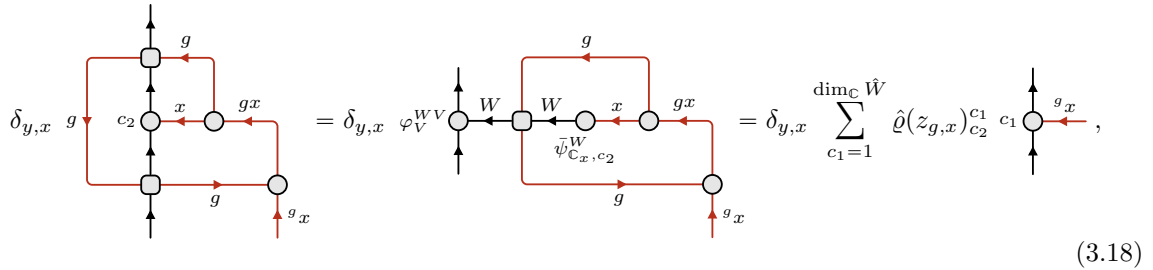

$$\delta_{y, x} \text{Tube}(g, y) \cdot \text{Tensor}(x, c_2) = \delta_{y, x} \varphi_V^{WV} \cdot \text{Tensor}(x, c_2) = \delta_{y, x} \sum_{c_1=1}^{\dim_{\mathbb{C}} \hat{W}} \hat{\varrho}(z_{g, x})_{c_2}^{c_1} \text{Tensor}(x, c_1) \quad , \quad (3.18)$$

where we used eq. (3.2) before performing all the contractions. This confirms that the collection of tensors of the form (3.12), for every $x \in [x_0]$ and $c \in \{1, \dots, \dim_{\mathbb{C}} \hat{W}\}$, furnish a module over $\text{Tube}(\text{Vec}_G)$ with underlying vector space $\bigoplus_{x \in G} \text{Hom}_{\text{Vec}_G}(\mathbb{C}_x, W)$, namely that associated with the simple object $([x_0], \hat{W})$ in $\text{Mod}(\text{Tube}(\text{Vec}_G)) \simeq \text{Vec}_G^G$ (see app. B). We conclude that for every choice of G -equivariant map $\varphi_V^{WV} : W \otimes V \rightarrow V$, tensors (3.12), for every $x \in [x_0]$ and $c \in \{1, \dots, \dim_{\mathbb{C}} \hat{W}\}$, furnish a multiplet of twisted sector local operators that transform in the irreducible representation $([x_0], \hat{W})$ of $\text{Tube}(\text{Vec}_G)$. Multiplets of twisted local operators associated with any object in Vec_G^G are constructed similarly.

For every choice of G -equivariant map $\varphi_V^{VW^*} : V \otimes W^* \rightarrow V$, one can construct another collection of tensors that form the *Hermitian dual* of the module associated with $([x_0], \hat{W})$. Concretely, for every

$x \in [x_0]$ and $c \in \{1, \dots, \dim_{\mathbb{C}} \hat{W}\}$, define

$$\begin{array}{c} \uparrow \\ \circ \\ \downarrow \end{array} \begin{array}{c} x \\ \leftarrow \\ \circ \\ \leftarrow \\ \psi_{\mathbb{C}_{x,c}}^W \end{array} \equiv \begin{array}{c} \uparrow \\ \circ \\ \downarrow \end{array} \begin{array}{c} W \\ \leftarrow \\ \circ \\ \leftarrow \\ \psi_{\mathbb{C}_{x,c}}^W \end{array} \begin{array}{c} \uparrow \\ \circ \\ \downarrow \end{array} \varphi_V^{VW^*} \equiv e_x \otimes \varphi_V^{VW^*} (- \otimes \varpi^{x,w_c}), \quad (3.19)$$

where we introduced

$$\begin{array}{c} \uparrow \\ \circ \\ \downarrow \end{array} \begin{array}{c} W \\ \leftarrow \\ \circ \\ \leftarrow \\ \psi_{\mathbb{C}_{x,c}}^W \end{array} \equiv e_x \otimes \varpi^{x,w_c}. \quad (3.20)$$

In particular, it follows from eq. (3.16) that the Hermitian dual of (3.18) agrees with the result of acting with the Hermitian dual of the tube labelled by $g, y \in G$ on the tensor (3.19).

Let $([x_0], \hat{W})$ label a simple object in Vec_G^G and choose a group element $x \in G$. Consider twisted sector local operators of the form (3.12) and (3.19) associated with c_1 and c_2 in $\{1, \dots, \dim_{\mathbb{C}} \hat{W}\}$, respectively. Placing the corresponding tensors at sites $i < j$ in Λ , we contract them via a symmetry MPO (2.12) with open boundary conditions. This ‘truncated’ symmetry MPO implements the action of the symmetry line $\mathbb{C}_x \in \text{Vec}_G$ on sites $i+1, i+2, \dots, j-2, j-1$. We denote the embedding in \mathcal{A}_Λ of the resulting tensor network operator as $\mathcal{S}(x, c_1, c_2)_{i, \dots, j}$. Graphically,

$$\mathcal{S}(x, c_1, c_2)_{i, \dots, j} \equiv \begin{array}{c} \uparrow \\ \circ \\ \downarrow \end{array} c_1 \begin{array}{c} \uparrow \\ \circ \\ \downarrow \end{array} \begin{array}{c} x \\ \leftarrow \\ \circ \\ \leftarrow \\ \psi_{\mathbb{C}_{x,c_1}}^W \end{array} \cdots \begin{array}{c} \uparrow \\ \circ \\ \downarrow \end{array} \begin{array}{c} x \\ \leftarrow \\ \circ \\ \leftarrow \\ \psi_{\mathbb{C}_{x,c_2}}^W \end{array} c_2. \quad (3.21)$$

In the physics literature, operators of this form are typically referred to as ‘string operators’ [dNR89, PGWS⁺08, PT12]. However, key aspects set our construction apart from typical definitions. Indeed, a string operator is commonly defined as a product of local operators with a truncated symmetry operator of the form $\prod_{k=i+1}^{j-1} \rho(x)_k$. In general, this approach fails to explicitly capture the G -grading structure of twisted sector local operators. Therefore, a naive interpretation of such a definition could yield contradictions. For instance, consider two simple objects in Vec_G^G labelled by $([x_0], \hat{W}_1)$ and $([x_0], \hat{W}_2)$, where $[x_0] \in \text{Cl}(G)$ and $\hat{W}_1, \hat{W}_2 \in \text{Irr}(\text{Mod}(\mathbb{C}[Z_G(x_0)]))$, such that $\text{Ind}_{Z_G(x_0)}^G(\hat{W}_1) \cong \text{Ind}_{Z_G(x_0)}^G(\hat{W}_2)$. If we were to simply require the endpoint local operators to transform in the representation $\text{Ind}_{Z_G(x_0)}^G(\hat{W}_1) \cong \text{Ind}_{Z_G(x_0)}^G(\hat{W}_2)$, one would not be able to distinguish the resulting string operators. Instead, one typically requires the endpoint local operators to transform in the representations \hat{W}_1 and \hat{W}_2 when acting with symmetry lines in $\text{Vec}_{Z_G(x_0)}$, respectively, which does produce the desired result. But this only becomes a constructive definition when introducing the G -grading structure of the twisted sector local operators.

Let us examine a couple of special cases. Choosing $[x_0] = [1_G]$, one recovers the situation described at the beginning of this section, whereby the string operator $\mathcal{S}(1_G, c_1, c_2)_{i, \dots, j}$ boils down to $\mathcal{O}(w_{c_1})_i; \mathcal{O}(w_{c_2})_j$. Choosing $\hat{W} = \mathbb{C} \in \text{Mod}(\mathbb{C}[Z_G(x_0)])$, for any $[x_0] \in \text{Cl}(G)$, it follows from $\text{Ind}_{Z_G(x_0)}^G(\mathbb{C}) \cong \mathbb{C}(G/Z_G(x_0))$ that even though \hat{W} is trivial, the end operators may need to transform non-trivially.¹⁵ In general, one can construct many multiplets of twisted sector local operators that transform adequately. In particular, let us emphasise that $\prod_{k=i+1}^{j-1} \rho(x)_k$, for any $x \in G$ corresponds to a very specific choice of multiplet.

We conclude with brief comments about ‘fusion’ of twisted sector local operators. Let W_1 and W_2 be two objects in Vec_G^G . Given G -equivariant maps $\varphi_V^{W_1 V} : W_1 \otimes V \rightarrow V$ and $\varphi_V^{W_2 V} : W_2 \otimes V \rightarrow$

¹⁵Whenever G is abelian, since conjugacy classes are all of size one, the end operators always need transform trivially.

V , one can construct multiplets of twisted local operators transforming in the representations of $\text{Tube}(\text{Vec}_G)$ associated with W_1 and W_2 , respectively. Given $x_1 \in \text{supp}(W_1)$ and $x_2 \in \text{supp}(W_2)$, let $c_1 \in \{1, \dots, \dim_{\mathbb{C}}(W_1)_{x_1}\}$ and $c_2 \in \{1, \dots, \dim_{\mathbb{C}}(W_2)_{x_2}\}$ label basis vectors of $(W_1)_{x_1}$ and $(W_2)_{x_2}$, respectively. Consider the tensor network

$$(3.22)$$

where we are adapting eq. (3.12) to the case of non-necessarily simple objects in Vec_G^G . Clearly, the collection of such tensors form a new module over $\text{Tube}(\text{Vec}_G)$, and thus a new multiplet of twisted sector local operators. By definition, they transform in the representation associated with $W_1 \otimes W_2 \in \text{Vec}_G^G$.

3.2 Order parameters

Given a G -symmetric gapped phase, we are now ready to identify string operators that may serve as *order parameters* in the ground state subspace. We are asking for necessary conditions that the corresponding multiplets of twisted sector local operators must satisfy in order for the string operators to acquire a non-vanishing expectation value in at least one state in the ground state subspace.

Consider a representative of the gapped phase associated with the indecomposable Vec_G -module category $\mathcal{M}(H, \beta)$. Recall that each ground state in the $(G : H)$ -dimensional ground state subspace preserves an algebra object of topological lines that is Morita equivalent to $A[H, \beta]$. Specifically, the ground state labelled by $a \in \{1, \dots, (G : H)\}$ preserves the internal hom $\underline{\text{Hom}}(\mathbb{C}_{r_a H}, \mathbb{C}_{r_a H})$ in Vec_G , which is isomorphic to $\mathbb{C}[r_a H r_a^{-1}]^{\beta_{r_a}}$ as an algebra.

Let us begin by identifying local order parameters. Let W be a simple object in $\text{Rep}(G)$. For every G -equivariant map $\varphi_V^{WV} : W \otimes V \rightarrow V$, one can construct a multiplet of local operators according to eq. (3.1), which transform in the representation W . Write $\langle - \rangle_a : W \rightarrow \mathbb{C}$ the operation that consists in computing the expectation value of these local operators in the ground state labelled by $a \in \{1, \dots, (G : H)\}$, where \mathbb{C} is here interpreted as the trivial representation of G . Since the ground state preserves the algebra $\mathbb{C}[r_a H r_a^{-1}]^{\beta_{r_a}}$ of symmetry lines—i.e., the corresponding symmetry operators leave the ground state invariant—the map $\langle - \rangle_a$ must be H -equivariant. But $\text{Hom}_H(\text{Res}_H^G(W), \mathbb{C})$ is non-trivial if and only if \mathbb{C} is a direct summand of $\text{Res}_H^G(W)$. Therefore, \mathbb{C} is required to be a direct summand of $\text{Res}_H^G(W)$ for expectation values of local operators transforming in the representation W to be non-vanishing. Note that this is only a necessary condition for acquiring a vacuum expectation value; it is often possible to construct a local operator that contains a singlet under H but nevertheless yields a vanishing expectation value.

Suppose we found a G -equivariant map $\varphi_V^{WV} : W \otimes V \rightarrow V$ so that local operators in the resulting multiplet have non-vanishing expectation values. One can conclude that \mathbb{C} is a direct summand of $\text{Res}_H^G(W)$. Linearly independent G -equivariant maps $W \otimes V \rightarrow V$ yield inequivalent multiplets of local operators. However, these inequivalent multiplets may still yield linearly dependent expectation values. Computing the number of inequivalent multiplets of local operators transforming in the representation W that yields linearly independent expectation values amounts to computing the multiplicity of \mathbb{C} in $\text{Res}_H^G(W)$, i.e., the dimension of the vector space $\text{Hom}_H(\text{Res}_H^G(W), \mathbb{C})$. By Frobenius reciprocity, $\text{Hom}_H(\text{Res}_H^G(W), \mathbb{C}) \cong \text{Hom}_G(W, \text{Ind}_H^G(\mathbb{C}))$. We conclude that local order parameters form

a (reducible) multiplet of local operators that transform in the representation $\text{Ind}_H^G(\mathbb{C}) \cong \mathbb{C}(G/H)$. The corresponding object in Vec_G^G is given by $\bigoplus_{W \in \mathbb{C}(G/H)} \dim_{\mathbb{C}} W \cdot ([1_G], W)$.

Naturally, this is in agreement with the statement that ground states are in one-to-one correspondence with the transitive G -set G/H . Indeed, it is always possible to construct a local operator that projects onto a specific ground state so that its expectation value is non-vanishing in this ground state only. For instance, consider the renormalisation group fixed points of sec. 2.4. For every $a \in \{1, \dots, (G : H)\}$, defining $\varsigma_a : G \rightarrow \mathbb{C}$ via $\varsigma_a(g) = 1$ if $g \in r_a H$, and 0 otherwise, we have $\mathbb{C}(G/H) = \mathbb{C}\{\varsigma_a\}_{a=1, \dots, (G:H)}$. The map $\mathbb{C}(G/H) \otimes A(H, \beta, U)^* \rightarrow A(H, \beta, U)^*$ defined by $\varsigma_{a_2} \otimes \sigma_{a_1, u^{b_1} \otimes u^{b_2}} \mapsto \delta_{a_1, a_2} \sigma_{a_1, u^{b_1} \otimes u^{b_2}}$, for every $a_1, a_2 \in \{1, \dots, (G : H)\}$ and $b_1, b_2 \in \{1, \dots, \dim_{\mathbb{C}} U\}$, is clearly G -equivariant and defines a (reducible) multiplet of local operators. The local operator $\mathcal{O}(\varsigma_a)_i$ acts as a projector onto the ground state labelled by a . Finally, local operators can be combined into a single order parameter in this reducible multiplet that distinguishes all the $(G : H)$ -many degenerate ground states.

Let us now study the general scenario. Given a simple object $([x_0], \hat{W})$ in Vec_G^G , consider the string operator $\mathcal{S}(x, c_1, c_2)_{i, \dots, j}$ constructed in eq. (3.21), for $x \in [x_0]$ and $c_1, c_2 \in \{1, \dots, \dim_{\mathbb{C}} \hat{W}\}$. The expectation value of this string operator in the ground state labelled by $a \in \{1, \dots, (G : H)\}$ is provided by

$$(3.23)$$

Employing eq. (2.19) at every site $k \in [i + 1, j - 1]$ together with eq. (2.20), it follows from eq. (2.9) that (3.23) evaluates to

$$(3.24)$$

up to terms that decay exponentially in the length of the string. Immediately, one obtains a preliminary constraint. In order for the factors in eq. (3.24) not to vanish, the line $\mathbb{C}_x \in \text{Vec}_G$ must belong to the algebra of preserved lines, i.e., x must lie in $r_a H r_a^{-1}$. Thus we assume that there is a group element $h \in H$ such that $x = r_a h$. Which additional necessary conditions must the string operator satisfy in order for these factors not to vanish?

Clearly, the two factors in eq. (3.24) play symmetric roles. Therefore, it is enough to study one of them. For instance, let us focus on the right-hand-side factor. This quantity is the result of contracting a twisted sector local operator of the form (3.19) with the tensor network:

$$(3.25)$$

While twisted sector local operators of the form (3.19) are arranged into the Hermitian dual of the simple module over $\text{Tube}(\text{Vec}_G)$ labelled by $([x_0], \hat{W})$, we claim that tensor networks of the form (3.12), for every $h \in H$ and $a \in \{1, \dots, (G : H)\}$, form a reducible module over $\text{Tube}(\text{Vec}_G)$. Acting with the tube (3.16) corresponding to $e_g \otimes \varsigma_y \in \text{Tube}(\text{Vec}_G)$ on the tensor network (3.25) labelled by $h \in H$ and $a \in \{1, \dots, (G : H)\}$ results in

$$(3.26)$$

One can simplify this tensor network by utilising eq. (2.19) together with eq. (2.20), before invoking eq. (2.22) as well as eq. (2.24) and its converse:

$$(3.27)$$

where in the last step we used that $h_{g, (r_a h)(a)} = h_{g, a}$, $h_{r_a h, a} = h$ and $h_{g r_a h, g(a)} = h_{g, a} h h_{g, a}^{-1}$, for every $g \in G$, $h \in H$ and $a \in \{1, \dots, (G : H)\}$. Let us confirm that this action does endow the space of tensor networks (3.25) with the structure of a module over $\text{Tube}(\text{Vec}_G)$. Firstly, it follows from $g r_a = r_{g(a)} h_{g, a}$, which implies $g r_a h = r_{g(a)} (h_{g, a} h h_{g, a}^{-1}) r_{g(a)}^{-1}$, that (3.27) is indeed of the form (3.25), whereby the label in $\{1, \dots, (G : H)\}$ is chosen to be $g(a)$, while the group element in H is chosen to be $h_{g, a} h h_{g, a}^{-1}$. Secondly, let

$$\beta_{h_2}(h_1) \equiv \mathbf{t}(\beta)(h_2 \xrightarrow{h_1} h_1 h_2 h_1^{-1}) := \frac{\beta(h_1, h_2)}{\beta(h_1 h_2 h_1^{-1}, h_1)}, \quad (3.28)$$

for every $h_1, h_2 \in H$. The so-called *transgression* map $\mathbf{t} : Z^2(H, \text{U}(1)) \rightarrow Z^1(H//H, \text{U}(1))$ maps the group 2-cocycle β to the groupoid 1-cocycle $\mathbf{t}(\beta)$, which satisfies

$$\begin{aligned} \beta_{h_3}(h_1 h_2) &= \mathbf{t}(\beta)(h_3 \xrightarrow{h_1 h_2} h_1 h_2 h_3 h_2^{-1} h_1^{-1}) \\ &= \mathbf{t}(\beta)(h_2 h_3 h_2^{-1} \xrightarrow{h_1} h_1 h_2 h_3 h_2^{-1} h_1^{-1}) \mathbf{t}(\beta)(h_3 \xrightarrow{h_2} h_2 h_3 h_2^{-1}) = \beta_{h_2 h_3 h_2^{-1}}(h_1) \beta_{h_3}(h_2), \end{aligned} \quad (3.29)$$

for every $h_1, h_2, h_3 \in H$. In particular, notice that for every $h \in H$, the restriction of β_h to the centraliser $Z_H(h)$ of h in H defines a one-dimensional representation that we denote by \mathbb{C}_{β_h} . This confirms that the tensor networks (3.25) arrange into a module over the tube algebra $\text{Tube}(\text{Vec}_G)$. Let us denote this $\text{Tube}(\text{Vec}_G)$ -module by $L(H, \beta)$.

What can we infer from these derivations? For every basis vector of the simple module labelled by $([x_0], \hat{W})$ and every basis vector of the module $L(H, \beta)$, the right-hand-side factor of (3.24) computes a complex number. As matter of fact, this operation defines an inner product between these $\text{Tube}(\text{Vec}_G)$ -modules. By definition (3.16) of the $*$ -structure of $\text{Tube}(\text{Vec}_G)$, one can further confirm that this inner product is invariant under the action of $\text{Tube}(\text{Vec}_G)$. This implies that, in order for the expectation value (3.23) of the string operator $\mathcal{S}(x, c_1, c_2)_{i, \dots, j}$ not to vanish, the simple module $([x_0], \hat{W})$ must be direct summand of $L(H, \beta)$. Conversely, suppose that the string operator $\mathcal{S}(x, c_1, c_2)_{i, \dots, j}$ acquires a non-vanishing expectation value, one can conclude that $([x_0], \hat{W})$ is a direct summand of $L(H, \beta)$. Now, the definition of the string operator $\mathcal{S}(x, c_1, c_2)_{i, \dots, j}$ requires choosing G -equivariant maps $\varphi_V^{WV} : W \otimes V \rightarrow V$ and $\varphi_V^{VW^*} : V \otimes W^* \rightarrow V$. Computing the number of inequivalent multiplets of twisted local operators transforming in the module $([x_0], \hat{W})$ of $\text{Tube}(\text{Vec}_G)$ that produce linearly independent expectation values amounts to computing the multiplicity of $([x_0], \hat{W})$ in $L(H, \beta)$, thus allowing us to fully reconstruct this module.

Before continuing, let us briefly comment on the expectation value of the string operators on the block-injective MPS $\Psi(\theta) = \sum_a \Psi(\theta_a)$ as opposed to on its blocks $\Psi(\theta_a)$. Because distinct blocks are orthogonal, the mixed transfer matrices (2.11) have spectral radii less than 1. Therefore, for any finitely supported operator \mathcal{O} , the overlap of $\Psi(\theta_{a_1})$ and $\mathcal{O}\Psi(\theta_{a_2})$ vanishes unless $a_1 = a_2$. We conclude that the full expectation value is determined by the expectation values in the individual blocks.

3.3 Lagrangian algebras

Above, we demonstrated that string order parameters for the G -symmetric gapped phase associated with the Vec_G -module category $\mathcal{M}(H, \beta)$ are such that the corresponding twisted sector local operators form the $\text{Tube}(\text{Vec}_G)$ -module $L(H, \beta)$. Let us elucidate further the meaning of this object.

We begin by computing the G -equivariant G -graded vector space corresponding to $L(H, \beta)$ under $\text{Vec}_G^G \simeq \text{Mod}(\text{Tube}(\text{Vec}_G))$. Consider the twisted group algebra $\mathbb{C}[H]^\beta = \mathbb{C}\{e_h\}_{h \in H}$. It is equipped with an H -equivariant structure given by

$$h_1 \cdot e_{h_2} = \beta_{h_2}(h_1) e_{h_1 h_2 h_1^{-1}}, \quad (3.30)$$

for every $h_1, h_2 \in H$. We promote the H -action of $\mathbb{C}[H]^\beta$ to a G -action via the induction functor:

$$\text{Ind}_H^G(\mathbb{C}[H]^\beta) := \mathbb{C}\{\zeta : G \rightarrow \mathbb{C}[H]^\beta \mid \zeta(gh^{-1}) = h \cdot \zeta(g)\}_{\forall g \in G, \forall h \in H}. \quad (3.31)$$

The G -equivariant structure, as usual, is given by $(g \cdot \zeta)(-) = \zeta(g^{-1} -)$. Moreover, $\text{Ind}_H^G(\mathbb{C}[H]^\beta)$ is G -graded, whereby every function $\zeta \in \text{Ind}_H^G(\mathbb{C}[H]^\beta)$ is homogeneous of degree $x \in G$ if and only if $\zeta(y) \in \mathbb{C}[H]^\beta$ is homogeneous of degree $y^{-1}xy$, for every $y \in G$. In particular, we have $\text{Ind}_H^G(\mathbb{C}[H]^\beta)_{1_G} \cong \mathbb{C}(G/H)$. Furthermore, if ζ is homogeneous of degree $x \in G$, then, by definition, $g \cdot \zeta$ is homogeneous of degree gxg^{-1} . Therefore, $\text{Ind}_H^G(\mathbb{C}[H]^\beta)$ defines an object in Vec_G^G . Mimicking the derivations of sec. 2.4, we find that $\text{Ind}_H^G(\mathbb{C}[H]^\beta) = \mathbb{C}\{\varsigma_{a,h}\}_{a=1, \dots, (G:H), h \in H}$, where the function $\varsigma_{a,h} : G \rightarrow \mathbb{C}[H]^\beta$ is defined by

$$\varsigma_{a,h}(g) = \begin{cases} \beta_h(h_1^{-1}) e_{h_1^{-1} h h_1} & \text{if } g \equiv r_a h_1 \in r_a H, \\ 0 & \text{otherwise,} \end{cases} \quad (3.32)$$

for every $g \in G$. By definition, the function $\varsigma_{a,h}$ is homogeneous of degree $|\varsigma_{a,h}| = r_a h r_a^{-1} \in G$. Let us examine the action of G on $\varsigma_{a,h}$, for every $a \in \{1, \dots, (G : H)\}$ and $h \in H$. By definition, $(g \cdot \varsigma_{a,h})(x) = \varsigma_{a,h}(g^{-1}x)$, for every $g, x \in G$, which is non-zero if and only if $x \in g \cdot r_a H = r_{g(a)} H$. Moreover, recall that for each $g \in G$ and $r_a H \in G/H$, there is a unique $h_{g,a} \in H$ such that $g r_a = r_{g(a)} h_{g,a}$. Suppose that $x \equiv r_{g(a)} h_1 \in r_{g(a)} H$, we find

$$\begin{aligned} (g \cdot \varsigma_{a,h})(x) &= \varsigma_{a,h}(r_a h_{g,a}^{-1} r_{g(a)}^{-1} r_{g(a)} h_1) \\ &= (h_1^{-1} h_{g,a}) \cdot \varsigma_{a,h}(r_a) = \beta_h(h_1^{-1} h_{g,a}) e_{h_1^{-1} h_{g,a} h h_{g,a}^{-1} h_1}, \end{aligned} \quad (3.33)$$

where we used in the last step the fact that $\varsigma_{a,h}(r_a) = e_h$. Invoking the cocycle condition (3.29) finally implies that

$$g \cdot \varsigma_{a,h} = \beta_h(h_{g,a}) \varsigma_{g(a), h_{g,a} h h_{g,a}^{-1}}. \quad (3.34)$$

At this point, one can explicitly verify that $|g \cdot \varsigma_{a,h}| = g |\varsigma_{a,h}| g^{-1}$.

As detailed in app. B, the corresponding $\text{Tube}(\text{Vec}_G)$ -module is simply given by $\mathbb{C}\{\varsigma_{a,h}\}_{a,h}$ with

$$(e_g \otimes \varsigma_y) \cdot \varsigma_{a,h} := \delta_{y, r_a h} \beta_h(h_{g,a}) \varsigma_{g(a), h_{g,a} h h_{g,a}^{-1}}, \quad (3.35)$$

for every $g, y \in G$, $a \in \{1, \dots, (G : H)\}$ and $h \in H$. This is precisely the $\text{Tube}(\text{Vec}_G)$ -module $L(H, \beta)$ we found in sec. 3.2. Concretely, the basis vector $\varsigma_{a,h}$ is identified with the tensor network (3.25) associated with the ground state labelled by a and twisting line $\mathbb{C}_{|\varsigma_{a,h}|} = \mathbb{C}_{r_a h r_a^{-1}} \in \text{Vec}_G$.

At this point, it would be useful to have an explicit formula providing the multiplicity of any simple object $\equiv ([x_0], \hat{W}) \in \text{Vec}_G^G$ in $L(H, \beta)$. As modules over $\text{Tube}(\text{Vec}_G)$, characters of $([x_0], \hat{W})$ and $L(H, \beta)$ are given by (see app. B)

$$\begin{aligned} \chi^{([x_0], \hat{W})}(e_g \otimes \varsigma_x) &= \delta_{x \in [x_0]} \delta_{g x, x g} \chi^{\hat{W}}(z_{g,x}), \\ \chi^{L(H, \beta)}(e_g \otimes \varsigma_x) &= \frac{\delta_{g x, x g}}{|H|} \sum_{y \in G} \delta_{g \in y^{-1} H y} \delta_{x \in y^{-1} H y} \beta_{y x y^{-1}}(y g y^{-1}), \end{aligned} \quad (3.36)$$

respectively, for every $e_g \otimes \varsigma_x \in \text{Tube}(\text{Vec}_G)$. Their inner product reads

$$\begin{aligned} \langle \chi^{L(H, \beta)}, \chi^{([x_0], \hat{W})} \rangle &= \frac{1}{|G|} \sum_{g, x \in G} \overline{\chi^{L(H, \beta)}(e_g \otimes \varsigma_x)} \chi^{([x_0], \hat{W})}(e_g \otimes \varsigma_x) \\ &= \frac{1}{|G| |H|} \sum_{g, x, y \in G} \delta_{g x, x g} \delta_{g \in y^{-1} H y} \delta_{x \in y^{-1} H y} \delta_{x \in [x_0]} \overline{\beta_{y x y^{-1}}(y g y^{-1})} \chi^{\hat{W}}(z_{g,x}) \\ &= \frac{1}{|H|} \sum_{g, x \in G} \delta_{g x, x g} \delta_{g \in H} \delta_{x \in H} \delta_{x \in [x_0]} \frac{\chi^{\hat{W}}(z_{g,x})}{\beta_x(g)} \\ &= \frac{1}{|H|} \sum_{x \in [x_0] \cap H} \sum_{g \in Z_H(x)} \frac{\chi^{\hat{W}}(r_x^{-1} g r_x)}{\beta_x(g)} = \frac{1}{|H|} \sum_{x \in [x_0] \cap H} \sum_{g \in Z_H(x_0)} \frac{\chi^{\hat{W}}(g)}{\beta_{x_0}(g)} \end{aligned} \quad (3.37)$$

where in the last step we used the facts that $\beta_{r_x x_0 r_x^{-1}}(r_x g r_x^{-1}) = \beta_{x_0}(g)$, for every $g \in Z_H(x_0)$ and $x \in [x_0]$. By inspection, we find that

$$\langle \chi^{L(H, \beta)}, \chi^{([x_0], \hat{W})} \rangle = \langle \chi^{\mathbb{C}[H]^\beta}, \chi^{\text{Res}_H^G([x_0], \hat{W})} \rangle, \quad (3.38)$$

which is consistent with the Frobenius reciprocity condition

$$\text{Hom}_{\text{Vec}_G^G}(L(H, \beta), W) \cong \text{Hom}_{\text{Vec}_G^G}(\mathbb{C}[H]^\beta, \text{Res}_H^G(W)), \quad (3.39)$$

where Vec_G^H is the category of H -equivariant G -graded vector spaces.

Let us explore a couple of special cases. On the one hand, choosing $H = \{1_G\}$, one finds that $L(\{1_G\}, 1) \cong \mathbb{C}(G) \in \text{Vec}_G^G$, which is consistent with the fact that in the gapped phase where the whole symmetry is spontaneously broken, all the order parameters are local operators. On the other hand, choosing $H = G$, one finds that $L(G, \beta) \cong \mathbb{C}[G]^\beta \in \text{Vec}_G^G$, which decomposes as

$$\mathbb{C}[G]^\beta \cong \bigoplus_{[x_0] \in \text{Cl}(G)} ([x_0], \mathbb{C}_{\beta_{x_0}}). \quad (3.40)$$

Notice that the object $L(G, \beta) \in \text{Vec}_G^G$ only depends on β through its transgression (3.28). As such, it is possible for multiplets of twisted sector local operators associated with distinct G -symmetric gapped phases to correspond to the same object in Vec_G^G . This is a phenomenon that is well documented for gapped phases preserving a finite group with non-trivial *Bogomolov multiplier* [PT12, Dav14, KB25].¹⁶ However, this does not necessarily imply that the same string operators may serve as order parameters for distinct gapped phases. Indeed, even though the corresponding twisted sector local operators transform in the same way, they may still be different.

Mathematically, the resolution of the above conundrum goes as follows: By induction, the object $L(H, \beta) \in \text{Vec}_G^G$ is equipped with the structure of an algebra in Vec_G^G , i.e., a G -equivariant G -graded algebra. The multiplication rule, which is provided by the pointwise multiplication of functions $G \rightarrow \mathbb{C}[H]^\beta$, reads

$$\varsigma_{a_1, h_1} \cdot \varsigma_{a_2, h_2} = \delta_{a_1, a_2} \beta(h_1, h_2) \varsigma_{a_1, h_1 h_2}, \quad (3.41)$$

for every $a_1, a_2 \in \{1, \dots, (G : H)\}$ and $h_1, h_2 \in H$, where we used the fact that

$$\beta_{h_1}(h_3) \beta_{h_2}(h_3) \beta(h_3 h_1 h_3^{-1}, h_3 h_2 h_3^{-1}) = \beta_{h_1 h_2}(h_3) \beta(h_1, h_2), \quad (3.42)$$

for every $h_1, h_2, h_3 \in H$. As expected, one recovers that $L(G, \beta)$ is equivalent to $\mathbb{C}[G]^\beta$ as an algebra. Notice that the multiplication rule of $L(H, \beta)$ explicitly depends on the 2-cocycle β . Therefore, even for two 2-cocycles β_1 and β_2 such that $L(H, \beta_1)$ and $L(H, \beta_2)$ would be isomorphic as objects in Vec_G^G , they would still be non-isomorphic algebra objects. As a matter of fact, one can readily check that $L(H, \beta)$ is a *Lagrangian algebra* in Vec_G^G , i.e., a connected, indecomposable, separable and commutative algebra such that $\text{FPdim}(L(H, \beta)) = |G|$ (see app. A).¹⁷ Crucially, Lagrangian algebras in Vec_G^G are in one-to-one correspondence with indecomposable module categories over Vec_G so that each symmetric gapped phase is assigned a unique Lagrangian algebra, up to isomorphisms. Overall, we have shown that string order parameters do organise into the Lagrangian algebra in $\mathcal{Z}(\text{Vec}_G)$ associated with the gapped phase [BBPSN23].

Physically, one detects the multiplication rule of the Lagrangian algebra $L(H, \beta)$ by checking the fusion rules of the corresponding twisted sector local order parameters. For instance, consider the

¹⁶A finite group G with non-trivial Bogomolov multiplier produces distinct symmetry protected topological phases whose response theories produce identical topological invariants on the two-torus. This can only happen if G is non-abelian. Indeed, whenever G is abelian, it is enough to compute the topological invariants on the two-torus. Within our context, this means that whenever G is abelian the object $L(H, \beta)$ fully specifies the gapped phase. In other words, we must be able to reconstruct a 2-cocycle β from the collection $\{\mathbb{C}_{\beta_x}\}_{x \in G}$ of one-dimensional representations. Indeed, consider the map $Z^2(G, \text{U}(1)) \rightarrow \text{Hom}(G, \text{Hom}(G, \text{U}(1)))$ given by $\beta \mapsto (x \mapsto \beta_x)$. It can be verified to be a group homomorphism whose kernel consists of coboundaries, so that \mathbb{C}_{β_x} being trivial for every $x \in G$ implies that β is trivial [dGTS21].

¹⁷Note that $L(H, \beta)$ is clearly not commutative as an algebra in Vec , but it is commutative as an algebra in Vec_G^G thanks to the definition of the braiding (see app. A) [DS17].

renormalisation group fixed point we built in sec. 2.4 from the algebra $A(H, \beta, U) \in \text{Rep}(G)$. Let $\varphi_{A(H, \beta, U)^*}^{L(H, \beta)A(H, \beta, U)^*} : L(H, \beta) \otimes A(H, \beta, U)^* \rightarrow A(H, \beta, U)^*$ be the linear map defined by

$$\varsigma_{a_2, h} \otimes \sigma_{a_1, u^{b_1} \otimes u_{b_2}} \mapsto \delta_{a_1, a_2} \sigma_{a_1, u^{b_1} \otimes h \cdot u_{b_2}}. \quad (3.43)$$

It follows from

$$\begin{aligned} & (g \cdot \varsigma_{a_2, h}) \otimes (g \cdot \sigma_{a_1, u^{b_1} \otimes u_{b_2}}) \\ & \mapsto \delta_{g(a_1), g(a_2)} \beta_h(h_{g, a}) \sigma_{g(a_1), h_{g, a} \cdot u^{b_1} \otimes (h_{g, a} h h_{g, a}^{-1}) \cdot (h_{g, a} \cdot u^{b_2})} \\ & = \delta_{a_1, a_2} \beta(h_{g, a}, h) \sigma_{g(a_1), h_{g, a} \cdot u^{b_1} \otimes (h_{g, a} h) \cdot u^{b_2}} \\ & = \delta_{a_1, a_2} \sigma_{g(a_1), h_{g, a} \cdot u^{b_1} \otimes h_{g, a} \cdot (h \cdot u^{b_2})} = \delta_{a_1, a_2} g \cdot \sigma_{a_1, (u^{b_1} \otimes h \cdot u_{b_2})}, \end{aligned} \quad (3.44)$$

that $\varphi_{A(H, \beta, U)^*}^{L(H, \beta)A(H, \beta, U)^*}$ is a G -equivariant map. Therefore, one can use it to construct twisted sector local operators. Notice that these twisted sector local operators are special in the sense that they yield string operators that stabilise the ground states. Moreover, from the definition, it is clear that such twisted sector local operators fuse according to the multiplication rule of $L(H, \beta)$. But there is considerable freedom in finding a multiplet of twisted sector local operators that furnish a copy of the object $L(G, \beta)$ and there is no guarantee a priori that they should all reproduce this multiplication rule.

In light of these comments, let us argue that the (canonical) multiplet associated with the map (3.43) is in fact the one that ‘survives in the infrared’ in the sense described below. Pick any multiplet of twisted sector local operators furnishing the object $L(H, \beta)$. Although these twisted sector local operators transform in the same $\text{Tube}(\text{Vec}_G)$ -module as those built from the G -equivariant map (3.43), they may be built from a different map $\varphi_{A(H, \beta, U)^*}^{L(H, \beta)A(H, \beta, U)^*}$. Recall that $L(H, \beta) = \mathbb{C}\{\varsigma_{a, h}\}_{a=1, \dots, (G:H), h \in H}$ with $|\varsigma_{a, h}| = r_a h r_a^{-1}$. The vector space underlying the $\text{Tube}(\text{Vec}_G)$ -module associated with $L(H, \beta) = \bigoplus_{g \in G} L(H, \beta)_g$ is provided by $\bigoplus_{g \in G} \text{Hom}_{\text{Vec}_G}(\mathbb{C}_g, L(H, \beta))$. The dimension of $L(H, \beta)_g$ equals the number of cosets $r_a H \in G/H$ such that $g(a) = a$. Indeed, for every $a \in \{1, \dots, (G:H)\}$ and $g \in G$ such that $g(a) = a$, we know that there is a unique $h_{g, a} \in H$ such that $g = r_a h_{g, a} r_a^{-1}$. Therefore, for every $g \in G$ and $a \in \{1, \dots, (G:H)\}$ such that $g(a) = a$, one can construct a twisted sector local operator

$$\begin{array}{c} \uparrow \\ \circ \\ \downarrow \end{array} \begin{array}{c} \leftarrow g \\ \leftarrow \\ \leftarrow \end{array} = \mathcal{O}(\varsigma_{a, h_{g, a}}) \otimes e^g, \quad (3.45)$$

where we introduced the notation

$$\mathcal{O}(\varsigma_{a, h_{g, a}}) := \varphi_{A(H, \beta, U)^*}^{L(H, \beta)A(H, \beta, U)^*} (\varsigma_{a, h_{g, a}} \otimes -). \quad (3.46)$$

Equivalently, for every $a \in \{1, \dots, (G:H)\}$ and $h \in H$, one constructs a twisted sector local operator with twisting line $\mathbb{C}_{r_a h} \in \text{Vec}_G$. Similarly, one picks any multiplet of twisted sector local operators furnishing the Hermitian dual of $L(H, \beta)$. Together, they yield string operators of the form $\mathcal{S}(g, a_1, a_2)_{i, \dots, j}$, for every $a_1, a_2 \in \{1, \dots, (G:H)\}$ and $g \in G$ such that $g(a_1) = a_1$ and $g(a_2) = a_2$. In order for such a string operator to have a non-vanishing expectation value in the ground state subspace, we already know that the linear map $\mathcal{O}(\varsigma_{a_1, h_{g, a_1}})$ must decompose into blocks over G/H because ground state labelled by distinct cosets in G/H are orthogonal in the infrared limit.

Let us now compute what $\mathcal{S}(g, a_1, a_2)_{i, \dots, j}$ projects onto in the infrared. We constructed in sec. 2.4 the MPS tensor θ of the renormalisation group fixed point associated with the algebra object $A(H, \beta, U) \in \text{Rep}(G)$. After normalisation, the corresponding transfer matrix is provided by

$$\mathbb{E}_\theta \equiv \bigoplus_{a=1}^{(G:H)} \mathbb{E}_{\theta_a} = \frac{1}{\dim_{\mathbb{C}} U} \bigoplus_{a=1}^{(G:H)} \mathbb{1}_{U^*} \circ \mathbb{1}_U . \quad (3.47)$$

Clearly, both the left and right fixed points of this transfer matrix are provided by the identity map on the virtual space. In the same vein, for every $h \in H$, let us introduce the mixed transfer matrix

$$\mathbb{E}_\theta^h \equiv \bigoplus_{a=1}^{(G:H)} \mathbb{E}_{\theta_a}^h := \bigoplus_{a=1}^{(G:H)} \begin{array}{c} \text{---} a \text{---} \\ \uparrow \\ \text{---} a \text{---} \\ \uparrow \\ \text{---} r^a h \text{---} \\ \uparrow \\ \text{---} a \text{---} \\ \uparrow \\ \text{---} a \text{---} \end{array} . \quad (3.48)$$

Given $a \in \{1, \dots, (G : H)\}$ and $h \in H$, one defines the right fixed point Ξ_a^h of the mixed transfer matrix $\mathbb{E}_{\theta_a}^h$ according to

$$\begin{array}{c} \text{---} a \text{---} \\ \uparrow \\ \text{---} a \text{---} \\ \uparrow \\ \text{---} r^a h \text{---} \\ \uparrow \\ \text{---} a \text{---} \\ \uparrow \\ \text{---} a \text{---} \end{array} \Xi_a^h = \begin{array}{c} \text{---} a \text{---} \\ \uparrow \\ \text{---} a \text{---} \\ \uparrow \\ \text{---} r^a h \text{---} \\ \uparrow \\ \text{---} a \text{---} \\ \uparrow \\ \text{---} a \text{---} \end{array} \Xi_a^h . \quad (3.49)$$

Using eq. (2.19), together with the fact that the transfer matrix \mathbb{E}_{θ_a} has a unique (right) fixed point yields

$$\begin{array}{c} \text{---} a \text{---} \\ \uparrow \\ \text{---} a \text{---} \\ \uparrow \\ \text{---} r^a h \text{---} \\ \uparrow \\ \text{---} a \text{---} \\ \uparrow \\ \text{---} a \text{---} \end{array} \Xi_a^h = \begin{array}{c} \text{---} a \text{---} \\ \uparrow \\ \text{---} a \text{---} \\ \uparrow \\ \text{---} r^a h \text{---} \\ \uparrow \\ \text{---} a \text{---} \\ \uparrow \\ \text{---} a \text{---} \end{array} \mathbb{1}_{U^*} . \quad (3.50)$$

Remembering from sec. 2.4 that $\phi^{g,a}: e_g \otimes u \mapsto \pi(h_{g,a})(u)$, one easily deduces the space of right fixed points of the mixed transfer matrix \mathbb{E}_θ^h . One proceeds similarly for the left fixed points. Finally, for every $h \in H$ we introduce

$$\mathbb{E}_\theta^{\mathcal{O}, a_1, h} \equiv \bigoplus_{a=1}^{(G:H)} \mathbb{E}_{\theta_a}^{\mathcal{O}, a_1, h} := \bigoplus_{a=1}^{(G:H)} \begin{array}{c} \text{---} a \text{---} \\ \uparrow \\ \text{---} a \text{---} \\ \uparrow \\ \text{---} a_1 \text{---} \\ \uparrow \\ \text{---} r^a h \text{---} \\ \uparrow \\ \text{---} a \text{---} \\ \uparrow \\ \text{---} a \text{---} \end{array} , \quad (3.51)$$

where $\mathbb{E}_{\theta_a}^{\mathcal{O}, a_1, h}$ is zero unless $(r^a h)(a_1) = a_1$.

Now, consider the expectation value of $\mathcal{S}(g, a_1, a_2)_{i, \dots, j}$ in the ground state labelled by $a \in \{1, \dots, (G : H)\}$. In order to get a non-zero value, we already know that there must be a $h \in H$ such that $g = r_a h r_a^{-1}$. Since we are considering a renormalisation group fixed point model, it immediately reduces to an expression of the form (3.24). As usual, it is enough to focus on the contribution from a single twisted sector local operator, say the one on the left-hand side. The left-hand ‘half’ of

the expectation value loosely takes the form $\mathbb{E}_{\theta_a} \cdots \mathbb{E}_{\theta_a} \mathbb{E}_{\theta_a}^{\mathcal{O}, a_1, h} \mathbb{E}_{\theta_a}^h \mathbb{E}_{\theta_a}^h \cdots$, such that

$$\mathbb{E}_{\theta_a} \mathbb{E}_{\theta_a}^{\mathcal{O}, a_1, h} \mathbb{E}_{\theta_a}^h = \frac{1}{(\dim_{\mathbb{C}} U)^2} \mathbb{1}_{U*} \cdot \text{Diagram} \quad (3.52)$$

In particular, one recognises the type of inner product between $\text{Tube}(\text{Vec}_G)$ -module one considered in sec. 3.2, which enforces $a_1 = a$ in order to be non-zero. One interprets the virtual operator $\mathbb{E}_{\theta_a} \mathbb{E}_{\theta_a}^{\mathcal{O}, a, h} \mathbb{E}_{\theta_a}^h$, which is the projection of $\mathbb{E}_{\theta_a}^{\mathcal{O}, a, h}$ onto the dominant eigenspace of the transfer matrix, as the part that survives in the infrared.¹⁸ By injectivity, for every $a \in \{1, \dots, (G : H)\}$ and $h \in H$, there is a unique linear map $\tilde{\mathcal{O}}(\varsigma_{a, h})$ such that

$$\mathbb{E}_{\theta_a}^{\tilde{\mathcal{O}}, a, h} = \mathbb{E}_{\theta_a} \mathbb{E}_{\theta_a}^{\mathcal{O}, a, h} \mathbb{E}_{\theta_a}^h. \quad (3.53)$$

which is simply obtained by absorbing the result of the aforementioned inner product into the identity matrix $\mathbb{1}_{U*}$. Explicitly, one finds that $\tilde{\mathcal{O}}(\varsigma_{a, h})$ is a linear map that projects onto the block of $A(H, \beta, U)^*$ labelled by a , and the operator in each block is proportional to $\mathbb{1}_{U*} \otimes \pi(h)$. Bringing everything together, one obtains the projection in the infrared of the multiplet of twisted sector local operators, which readily fuse according to the multiplication rule of $L(H, \beta)$.

What about an arbitrary representative of the gapped phase labelled by $\mathcal{M}(H, \beta)$? For any representative, consider the corresponding block-injective tensor $\theta: M \rightarrow V \otimes M$ whose properties were discussed in sec. 2.2. By construction, $M = \bigoplus_{a=1}^{G:H} M_a$ such that $M_{a_1} \cong M_{a_2}$, for every $a_1, a_2 \in \{1, \dots, (G : H)\}$. Moreover, it follows from eq. (2.24) that M_a , for every $a \in \{1, \dots, (G : H)\}$, is equipped with the structure of a β -projective representation of H in such a way that the whole virtual space $M \otimes M^*$ transforms like $\text{Ind}_H^G(\text{End}_{\mathbb{C}}(M_a))$, for any $a \in \{1, \dots, (G : H)\}$. By definition, the tensor θ interpreted as a map from the virtual space to the physical one is injective. Moreover, thanks to eq. (2.19), it is G -equivariant. Therefore, the physical vector space V must contain $\text{Ind}_H^G(\text{End}_{\mathbb{C}}(M_a))$ as a subrepresentation. This guarantees that the local Hilbert space is large enough to accommodate all the twisted local operators furnishing the multiplet associated with the Lagrangian algebra $L(H, \beta)$. Besides, in light of the above derivations, we posit that, for any gapped representative, any multiplet of string order parameters flows in infrared to a multiplet of twisted local operators that not only transform like $L(H, \beta)$ but also fuse according to its multiplication rule.

3.4 Example: $\text{Vec}_{\mathbb{Z}_2 \oplus \mathbb{Z}_2}$

Consider the *Klein four-group* $\mathbb{Z}_2 \oplus \mathbb{Z}_2 = \{(), (12)(34), (13)(24), (14)(23)\}$. As an abelian group, each conjugacy class contains a single group element and the stabiliser subgroup of each conjugacy class is the group $\mathbb{Z}_2 \oplus \mathbb{Z}_2$ itself. It admits four one-dimensional (linear) irreducible representations denoted

¹⁸Since we are considering a renormalisation group fixed point, no information is actually projected out in the sense that replacing $\mathbb{E}_{\theta_a}^{\mathcal{O}, a, h}$ by $\mathbb{E}_{\theta_a} \mathbb{E}_{\theta_a}^{\mathcal{O}, a, h} \mathbb{E}_{\theta_a}^h$ in the computation of the expectation values actually provide the exact same result, up to normalisation.

by $\{\mathbb{C}_{(1,1)}, \mathbb{C}_{(1,-1)}, \mathbb{C}_{(-1,1)}, \mathbb{C}_{(-1,-1)}\}$. The character table is given by

	()	(12)(34)	(13)(24)	(14)(23)	
$\mathbb{C}_{(1,1)}$	1	1	1	1	
$\mathbb{C}_{(1,-1)}$	1	1	-1	-1	.
$\mathbb{C}_{(-1,1)}$	1	-1	1	-1	
$\mathbb{C}_{(-1,-1)}$	1	-1	-1	1	

(3.54)

It counts five (conjugacy classes of) subgroups given by $\mathbb{Z}_2 \oplus \mathbb{Z}_2$, $\mathbb{Z}_2 \oplus 0 = \langle (12)(34) \rangle$, $0 \oplus \mathbb{Z}_2 = \langle (13)(24) \rangle$, the diagonal subgroup $\Delta(\mathbb{Z}_2 \oplus \mathbb{Z}_2) = \langle (14)(23) \rangle$ and the trivial subgroup. We employ the same notation for the irreducible representation of the subgroups as for $\mathbb{Z}_2 \oplus \mathbb{Z}_2$. The Schur multiplier $H^2(\mathbb{Z}_2 \oplus \mathbb{Z}_2, \mathbb{U}(1))$ is found to be isomorphic to \mathbb{Z}_2 . Given a normalised representative of the non-trivial cohomology class in $H^2(\mathbb{Z}_2 \oplus \mathbb{Z}_2, \mathbb{U}(1))$, the group $\mathbb{Z}_2 \oplus \mathbb{Z}_2$ admits a single irreducible projective representations denoted by U_2 and satisfying $U_2 \otimes U_2 \cong \mathbb{C}_{(1,1)} \oplus \mathbb{C}_{(1,-1)} \oplus \mathbb{C}_{(-1,1)} \oplus \mathbb{C}_{(-1,-1)}$.

The sixteen simple objects in $\text{Vec}_{\mathbb{Z}_2 \oplus \mathbb{Z}_2}^{\mathbb{Z}_2 \oplus \mathbb{Z}_2}$ are simply obtained by pairing every group element with every linear irreducible representation, each labelling a multiplet of twisted sector local operators. Finally, using the above data, we find six Lagrangian algebras, namely $L(\mathbb{Z}_2, 1)$, $L(\Delta(\mathbb{Z}_2 \oplus \mathbb{Z}_2), 1)$, $L(0 \oplus \mathbb{Z}_2, 1)$, $L(\mathbb{Z}_2 \oplus 0, 1)$, $L(\mathbb{Z}_2 \oplus \mathbb{Z}_2, 1)$ and $L(\mathbb{Z}_2 \oplus \mathbb{Z}_2, \beta)$, which we explicitly compute below:

- $L(0, 1)$: By definition, every vector in $L(0, 1)$ is homogeneous of degree the identity in $\mathbb{Z}_2 \oplus \mathbb{Z}_2$ so that $\text{supp}(L(0, 1)) = ()$. Moreover, as an object in $\text{Rep}(\mathbb{Z}_2 \oplus \mathbb{Z}_2)$, it is isomorphic to $\text{Ind}_{\mathbb{Z}_1}^{\mathbb{Z}_2 \oplus \mathbb{Z}_2}(\mathbb{C})$. Therefore,

$$L(\mathbb{Z}_1, 1) \cong ((), \mathbb{C}_{(1,1)}) \oplus ((), \mathbb{C}_{(1,-1)}) \oplus ((), \mathbb{C}_{(-1,1)}) \oplus ((), \mathbb{C}_{(-1,-1)}). \quad (3.55)$$

- $L(\Delta(\mathbb{Z}_2 \oplus \mathbb{Z}_2), 1)$: Since $\mathbb{Z}_2 \oplus \mathbb{Z}_2$ is abelian, $\varsigma \in L(\Delta(\mathbb{Z}_2 \oplus \mathbb{Z}_2), 1)$ is homogeneous of degree $y \in \mathbb{Z}_2 \oplus \mathbb{Z}_2$ if and only if $\varsigma(x) \in \mathbb{C}[\Delta(\mathbb{Z}_2 \oplus \mathbb{Z}_2)]$ is homogeneous of degree y , for every $x \in \mathbb{Z}_2 \oplus \mathbb{Z}_2$. Therefore, $\text{supp}(L(\Delta(\mathbb{Z}_2 \oplus \mathbb{Z}_2), 1)) = \{(), (14)(23)\}$ so that $L(\Delta(\mathbb{Z}_2 \oplus \mathbb{Z}_2), 1)$ decomposes as $L(\Delta(\mathbb{Z}_2 \oplus \mathbb{Z}_2), 1)_{()} \oplus L(\Delta(\mathbb{Z}_2 \oplus \mathbb{Z}_2), 1)_{(14)(23)}$. Moreover, as objects in $\text{Rep}(\mathbb{Z}_2 \oplus \mathbb{Z}_2)$, both $L(\Delta(\mathbb{Z}_2 \oplus \mathbb{Z}_2), 1)_{()}$ and $L(\Delta(\mathbb{Z}_2 \oplus \mathbb{Z}_2), 1)_{(14)(23)}$ are isomorphic to $\text{Ind}_{\Delta(\mathbb{Z}_2 \oplus \mathbb{Z}_2)}^{\mathbb{Z}_2 \oplus \mathbb{Z}_2}(\mathbb{C}_{(1,1)}) \cong \mathbb{C}_{(1,1)} \oplus \mathbb{C}_{(-1,-1)}$. Bringing everything together, one obtains

$$L(\Delta(\mathbb{Z}_2 \oplus \mathbb{Z}_2), 1) \cong ((), \mathbb{C}_{(1,1)}) \oplus ((), \mathbb{C}_{(-1,-1)}) \oplus ((14)(23), \mathbb{C}_{(1,1)}) \oplus ((14)(23), \mathbb{C}_{(-1,-1)}). \quad (3.56)$$

- $L(0 \oplus \mathbb{Z}_2, 1)$: Proceeding as above, we have $L(0 \oplus \mathbb{Z}_2, 1) \cong L(0 \oplus \mathbb{Z}_2, 1)_{()} \oplus L(0 \oplus \mathbb{Z}_2, 1)_{(13)(24)}$. Moreover, as objects in $\text{Rep}(\mathbb{Z}_2 \oplus \mathbb{Z}_2)$, both $L(0 \oplus \mathbb{Z}_2, 1)_{()}$ and $L(0 \oplus \mathbb{Z}_2, 1)_{(13)(24)}$ are isomorphic to $\text{Ind}_{0 \oplus \mathbb{Z}_2}^{\mathbb{Z}_2 \oplus \mathbb{Z}_2}(\mathbb{C}_{(1,1)}) \cong \mathbb{C}_{(1,1)} \oplus \mathbb{C}_{(-1,1)}$, so that

$$L(0 \oplus \mathbb{Z}_2, 1) \cong ((), \mathbb{C}_{(1,1)}) \oplus ((), \mathbb{C}_{(-1,1)}) \oplus ((13)(24), \mathbb{C}_{(1,1)}) \oplus ((13)(24), \mathbb{C}_{(-1,1)}). \quad (3.57)$$

- $L(\mathbb{Z}_2 \oplus 0, 1)$: Proceeding as above, we have $L(\mathbb{Z}_2 \oplus 0, 1) \cong L(\mathbb{Z}_2 \oplus 0, 1)_{()} \oplus L(\mathbb{Z}_2 \oplus 0, 1)_{(12)(34)}$. Moreover, as objects in $\text{Rep}(\mathbb{Z}_2 \oplus \mathbb{Z}_2)$, both $L(\mathbb{Z}_2 \oplus 0, 1)_{()}$ and $L(\mathbb{Z}_2 \oplus 0, 1)_{(12)(34)}$ are isomorphic to $\text{Ind}_{\mathbb{Z}_2 \oplus 0}^{\mathbb{Z}_2 \oplus \mathbb{Z}_2}(\mathbb{C}_{(1,1)}) \cong \mathbb{C}_{(1,1)} \oplus \mathbb{C}_{(1,-1)}$, so that

$$L(\mathbb{Z}_2 \oplus 0, 1) \cong ((), \mathbb{C}_{(1,1)}) \oplus ((), \mathbb{C}_{(1,-1)}) \oplus ((12)(34), \mathbb{C}_{(1,1)}) \oplus ((12)(34), \mathbb{C}_{(1,-1)}). \quad (3.58)$$

- $L(\mathbb{Z}_2 \oplus \mathbb{Z}_2, 1)$: By definition, $L(\mathbb{Z}_2 \oplus \mathbb{Z}_2, 1) \cong \mathbb{C}[\mathbb{Z}_2 \oplus \mathbb{Z}_2]$ such that all the homogeneous elements transform in the trivial representation of $\mathbb{Z}_2 \oplus \mathbb{Z}_2$. It immediately follows that

$$L(\mathbb{Z}_2 \oplus \mathbb{Z}_2, 1) \cong ((), \mathbb{C}_{(1,1)}) \oplus ((12)(34), \mathbb{C}_{(1,1)}) \oplus ((13)(24), \mathbb{C}_{(1,1)}) \oplus ((14)(23), \mathbb{C}_{(1,1)}). \quad (3.59)$$

• $L(\mathbb{Z}_2 \oplus \mathbb{Z}_2, \beta)$: Let us now choose β to be the normalised representative of the non-trivial cohomology class in $H^2(\mathbb{Z}_2 \oplus \mathbb{Z}_2, \mathbb{U}(1))$ such that $\beta(g_1, g_2)$ equals -1 if $g_1 \in \{(13)(24), (14)(23)\}$ and $g_2 \in \{(12)(34), (14)(23)\}$, and equals $+1$ otherwise. By definition, $L(\mathbb{Z}_2 \oplus \mathbb{Z}_2, \beta) = \mathbb{C}[\mathbb{Z}_2 \oplus \mathbb{Z}_2]^\beta = \mathbb{C}\{e_g\}_{g \in \mathbb{Z}_2 \oplus \mathbb{Z}_2}$ with the G -equivariant structure being provided by $g_1 \cdot e_{g_2} = \frac{\beta(g_1, g_2)}{\beta(g_2, g_1)} e_{g_2}$, for every $g_1, g_2 \in \mathbb{Z}_2 \oplus \mathbb{Z}_2$. By inspection, $\mathbb{C}\{e_{(12)(34)}\} \cong \mathbb{C}_{(1,-1)}$, $\mathbb{C}\{e_{(13)(24)}\} \cong \mathbb{C}_{(-1,1)}$ and $\mathbb{C}\{e_{(14)(23)}\} \cong \mathbb{C}_{(-1,-1)}$. Bringing everything together yields

$$L(\mathbb{Z}_2 \oplus \mathbb{Z}_2, \beta) \cong ((), \mathbb{C}_{(1,1)}) \oplus ((12)(34), \mathbb{C}_{(1,-1)}) \oplus ((13)(24), \mathbb{C}_{(-1,1)}) \oplus ((14)(23), \mathbb{C}_{(-1,-1)}). \quad (3.60)$$

Let us discuss some physical consequences of these computations. We focus on the non-trivial SPT and its corresponding Lagrangian algebra $L(\mathbb{Z}_2 \oplus \mathbb{Z}_2, \beta)$. Suppose for now that the microscopic Hilbert space of the physical system is provided by $\mathcal{H}_\Lambda = \bigotimes_{i \in \Lambda} V_{\{i\}}$, where V is chosen to be $\text{End}_{\mathbb{C}}(U_2)^* \cong \mathbb{C}(\mathbb{Z}_2 \oplus \mathbb{Z}_2)$. This is the Hilbert space of the renormalisation group fixed point associated with $\mathcal{M}(\mathbb{Z}_2 \oplus \mathbb{Z}_2, \beta)$ —a.k.a. the *cluster state* [SAV11, SAF⁺11]—that we constructed in sec. 2.4. Recall that the vector space $\text{End}_{\mathbb{C}}(U_2) \cong \text{Mat}_{\mathbb{C}}(2)$ is spanned by the identity matrix $\mathbb{1}$ and the spin-1/2 *Pauli matrices* $\{\sigma^x, \sigma^z, \sigma^x \sigma^z\}$. Besides, let $\pi: \mathbb{C}[\mathbb{Z}_2 \oplus \mathbb{Z}_2]^\beta \rightarrow \text{End}_{\mathbb{C}}(U_2)$. With the above conventions, we have $\pi(()) = \mathbb{1}$, $\pi((12)(34)) = \sigma^x$, $\pi((13)(24)) = \sigma^z$ and $\pi((14)(23)) = \sigma^x \sigma^z$. Recall that the group G acts on $f \in \text{End}_{\mathbb{C}}(U_2)$ via $g \cdot f = \pi(g) f \pi(g)^{-1}$, for every $g \in G$. Since $\text{End}_{\mathbb{C}}(U_2) \cong \mathbb{C}^2 \otimes \mathbb{C}^2$, as a vector space, it is convenient to think about the local Hilbert space as a pair of *qubits*. Choosing to work in a basis of eigenvectors of σ^z , one finds that the topological lines $\mathbb{C}_{(12)(34)}$, $\mathbb{C}_{(13)(24)}$ and $\mathbb{C}_{(14)(23)}$ acts on the local Hilbert space $\mathbb{C}^2 \otimes \mathbb{C}^2$ as $\sigma^z \otimes \mathbb{1}$, $\mathbb{1} \otimes \sigma^z$ and $\sigma^z \otimes \sigma^z$, respectively. We are now ready to construct the string order parameters. The multiplet of twisted sector local operators is defined with respect to the linear map we introduced in eq. (3.43). Here, to every homogeneous element in $L(\mathbb{Z}_2 \oplus \mathbb{Z}_2, \beta)$ of degree g , this map assigns the operator $\pi(g)$, which acts on $\text{End}_{\mathbb{C}}(U_2)$ by postcomposition. Paying attention to the fact that $\sigma^x \sigma^z = -\sigma^z \sigma^x$, in the qubit basis it yields

$$\begin{array}{c} \uparrow \\ \textcircled{1} \\ \uparrow \end{array} \xrightarrow{(12)(34)} = (\mathbb{1} \otimes \sigma^x) \otimes e^{(12)(34)}, \quad \begin{array}{c} \uparrow \\ \textcircled{1} \\ \uparrow \end{array} \xrightarrow{(13)(24)} = (\sigma^x \otimes \sigma^z) \otimes e^{(13)(24)}, \quad (3.61)$$

and similarly for the twisted sector local operators of the form (3.19). It follows from $(\mathbb{1} \otimes \sigma^x)(\sigma^x \otimes \sigma^z) = -(\sigma^x \otimes \sigma^z)(\mathbb{1} \otimes \sigma^x)$ that these twisted sector local operators do fuse according to the multiplication rule of $L(\mathbb{Z}_2 \oplus \mathbb{Z}_2, \beta)$. Bringing everything together, one recovers for instance the usual string operator associated with the simple object $((12)(34), \mathbb{C}_{(1,-1)})$:

$$\mathcal{S}((12)(34), 1, 1)_{i, \dots, j} = (\mathbb{1} \otimes \sigma^x)_i \left(\prod_{k=i+1}^{j-1} (\sigma^z \otimes \mathbb{1})_k \right) (\sigma^z \otimes \sigma^x)_j. \quad (3.62)$$

The other two non-trivial string operators associated with $((13)(24), \mathbb{C}_{(1,-1)})$ and $((14)(23), \mathbb{C}_{(1,-1)})$, respectively, are constructed similarly.

A more interesting scenario consists in expressing the same multiplet of string order parameters for a spin-1 model where the local Hilbert space would typically be taken to be the three-dimensional spin-1 representation of $\text{SO}(3)$. This is the setup of the *AKLT model* [AKLT87] and the *antiferromagnetic Heisenberg model*, which are both in the same SPT phase as above, i.e. the *Haldane phase* [Hal83, KT92, Osh92, PTBO10, CGW11]. In this context, local operators are typically expressed in terms of spin-1 operators $\{S^x, S^y, S^z\}$ in the standard angular momentum basis. But our framework still require defining the microscopic Hilbert space in terms of objects in $\text{Rep}(\mathbb{Z}_2 \oplus \mathbb{Z}_2)$. Notice that the

restriction of the spin-1 representation of $\text{SO}(3)$ to $\mathbb{Z}_2 \oplus \mathbb{Z}_2$ is isomorphic to $\mathbb{C}_{(1,-1)} \oplus \mathbb{C}_{(-1,1)} \oplus \mathbb{C}_{(-1,-1)}$, which one chooses as our local vector space V . Furthermore, one uses this isomorphism to express the spin-1 operators in a basis of $\mathbb{C}_{(1,-1)} \oplus \mathbb{C}_{(-1,1)} \oplus \mathbb{C}_{(-1,-1)}$. At this point, one can verify that the topological lines $\mathbb{C}_{(12)(34)}$ and $\mathbb{C}_{(14)(23)}$ acts diagonally on the local Hilbert space as $e^{i\pi S^z}$ and $e^{i\pi S^x}$, respectively (see the treatment of the *Kennedy–Tasaki* duality in ref. [LDOV21]). Similarly, the same linear map we used in eq. (3.61) now produces the twisted sector local operators $S^x \otimes e^{(12)(34)}$ and $-S^x \otimes e^{(13)(24)}$. It follows that the same abstract string operator associated with the simple object $((12)(34), \mathbb{C}_{(1,-1)})$ now acts as

$$\mathcal{S}((12)(34), 1, 1)_{i, \dots, j} = -S_i^x \exp\left(i\pi \sum_{k=i+1}^{j-1} S_k^z\right) S_j^x, \quad (3.63)$$

recovering the celebrated string order parameter introduced by Nijs and Rommelse in ref. [dNR89]. We can repeat the same operations for $((13)(24), \mathbb{C}_{(-1,1)})$ and verify once again that twisted sector local operators in the multiplet fuse according to the multiplication rule of $L(\mathbb{Z}_2 \oplus \mathbb{Z}_2, \beta)$.

3.5 Example: $\text{Vec}_{\mathbb{A}_4}$

Let \mathbb{A}_4 be the *alternating* group of order 12. It is isomorphic to $(\mathbb{Z}_2 \oplus \mathbb{Z}_2) \rtimes \mathbb{Z}_3$, where \mathbb{Z}_3 cyclically permutes the three non-identity elements of the $\mathbb{Z}_2 \oplus \mathbb{Z}_2$ normal subgroup. It can be interpreted as the group of orientation-preserving symmetries of the tetrahedron, or equivalently, the group of even permutations on $\{1, 2, 3, 4\}$. In that spirit, we denote the identity element by $()$, the generators of $\mathbb{Z}_2 \oplus \mathbb{Z}_2$ by $(12)(34)$ and $(13)(24)$, and the generator of \mathbb{Z}_3 by (123) .

Let us begin by listing basic properties of \mathbb{A}_4 . As a set, it is the disjoint union of four conjugacy classes, which read

$$[()] = \{()\}, \quad [(12)(34)] = \{(12)(34), (13)(24), (14)(23)\}, \quad (3.64)$$

$$[(123)] = \{(123), (134), (142), (243)\}, \quad [(132)] = \{(132), (143), (124), (234)\}. \quad (3.65)$$

The associated centraliser subgroups are $Z_{\mathbb{A}_4}([()]) = \mathbb{A}_4$, $Z_{\mathbb{A}_4}([(12)(34)]) = \mathbb{Z}_2 \oplus \mathbb{Z}_2 = \langle (12)(34), (13)(24) \rangle$, $Z_{\mathbb{A}_4}([(123)]) = \mathbb{Z}_3 = \langle (123) \rangle$ and $Z_{\mathbb{A}_4}([(132)]) = \mathbb{Z}_3 = \langle (132) \rangle$, respectively. Correspondingly, it admits four (linear) irreducible representations, namely three one-dimensional irreducible representations denoted by $\{\mathbb{C}_1, \mathbb{C}_\omega, \mathbb{C}_{\bar{\omega}}\}$, where ω stands for $\exp(\frac{2\pi i}{3})$, and a single three-dimensional irreducible representation denoted by V_3 . The character table is given by

	[()]	[(12)(34)]	[(123)]	[(132)]	
\mathbb{C}_1	1	1	1	1	(3.66)
\mathbb{C}_ω	1	1	ω	$\bar{\omega}$	
$\mathbb{C}_{\bar{\omega}}$	1	1	$\bar{\omega}$	ω	
V_3	3	-1	0	0	

while the non-trivial fusion rules read

$$\begin{aligned} \mathbb{C}_\omega \otimes \mathbb{C}_\omega &\cong \mathbb{C}_{\bar{\omega}}, & \mathbb{C}_{\bar{\omega}} \otimes \mathbb{C}_{\bar{\omega}} &\cong \mathbb{C}_\omega, & \mathbb{C}_\omega \otimes \mathbb{C}_{\bar{\omega}} &\cong \mathbb{C}_1, & \mathbb{C}_\omega \otimes V_3 &\cong V_3 \cong \mathbb{C}_{\bar{\omega}} \otimes V_3, \\ V_3 \otimes V_3 &\cong \mathbb{C}_1 \oplus \mathbb{C}_\omega \oplus \mathbb{C}_{\bar{\omega}} \oplus 2 \cdot V_3. \end{aligned} \quad (3.67)$$

For future reference, we choose a basis for V_3 such that the representation matrices of (123) and $(12)(34)$ are given by

$$\begin{pmatrix} 0 & 0 & 1 \\ 1 & 0 & 0 \\ 0 & 1 & 0 \end{pmatrix} \quad \text{and} \quad \begin{pmatrix} 1 & 0 & 0 \\ 0 & -1 & 0 \\ 0 & 0 & -1 \end{pmatrix}, \quad (3.68)$$

respectively.

It counts five conjugacy classes of subgroups represented by \mathbb{A}_4 , $\mathbb{Z}_2 \oplus \mathbb{Z}_2 = \langle (12)(34), (13)(24) \rangle$, $\mathbb{Z}_3 = \langle (123) \rangle$, $\mathbb{Z}_2 = \langle (12)(34) \rangle$ and the trivial subgroup. By analogy, we denote the irreducible representations of \mathbb{Z}_2 by $\{\mathbb{C}_1, \mathbb{C}_{-1}\}$, those of $\mathbb{Z}_2 \oplus \mathbb{Z}_2$ by $\{\mathbb{C}_{(1,1)}, \mathbb{C}_{(1,-1)}, \mathbb{C}_{(-1,1)}, \mathbb{C}_{(-1,-1)}\}$, and those of \mathbb{Z}_3 by $\{\mathbb{C}_1, \mathbb{C}_\omega, \mathbb{C}_{\bar{\omega}}\}$. The character table of $\mathbb{Z}_2 \oplus \mathbb{Z}_2$ was provided above, while that of \mathbb{Z}_3 is given by

$$\begin{array}{c|ccc} & () & (123) & (132) \\ \hline \mathbb{C}_1 & 1 & 1 & 1 \\ \mathbb{C}_\omega & 1 & \omega & \bar{\omega} \\ \mathbb{C}_{\bar{\omega}} & 1 & \bar{\omega} & \omega \end{array} \quad (3.69)$$

They satisfy the obvious fusion rules.

The Schur multiplier $H^2(\mathbb{A}_4, \mathbb{U}(1))$ is found to be isomorphic to \mathbb{Z}_2 . Given a (normalised) representative of the non-trivial cohomology class in $H^2(\mathbb{A}_4, \mathbb{U}(1))$, the group \mathbb{A}_4 admits three two-dimensional irreducible projective representations denoted by $\{U_1, U_\omega, U_{\bar{\omega}}\}$. They satisfy the fusion rules

$$\begin{aligned} \mathbb{C}_\omega \otimes U_\omega &\cong U_{\bar{\omega}}, & \mathbb{C}_{\bar{\omega}} \otimes U_{\bar{\omega}} &\cong U_\omega, & \mathbb{C}_\omega \otimes U_{\bar{\omega}} &\cong U_1, \\ U_1 \otimes V_3 &\cong U_\omega \otimes V_3 \cong U_{\bar{\omega}} \otimes V_3 \cong U_1 \oplus U_\omega \oplus U_{\bar{\omega}}, \end{aligned} \quad (3.70)$$

$$U_1 \otimes U_1 \cong U_\omega \otimes U_{\bar{\omega}} \cong \mathbb{C}_1 \oplus V_3, \quad U_{\bar{\omega}} \otimes U_{\bar{\omega}} \cong U_1 \otimes U_\omega \cong \mathbb{C}_\omega \oplus V_3, \quad U_\omega \otimes U_\omega \cong U_1 \otimes U_{\bar{\omega}} \cong \mathbb{C}_{\bar{\omega}} \oplus V_3.$$

Out of the four representatives of conjugacy classes of proper subgroups, only $\mathbb{Z}_2 \oplus \mathbb{Z}_2$ admits a non-trivial Schur multiplier, which is also isomorphic to \mathbb{Z}_2 . We still denote its single two-dimensional irreducible projective representation by U_2 .

As reviewed in sec. 3.2, simple objects in $\text{Vec}_{\mathbb{A}_4}^{\mathbb{A}_4}$ are labelled by pairs $([x_0], \hat{W})$ consisting of a conjugacy class $[x_0] \in \text{Cl}(\mathbb{A}_4)$ and a simple object $\hat{W} \in \text{Mod}(\mathbb{C}[Z_{\mathbb{A}_4}(x_0)])$. Using the above data, we find fourteen simple objects: $([()], \mathbb{C}_1)$, $([()], \mathbb{C}_\omega)$, $([()], \mathbb{C}_{\bar{\omega}})$, $([()], V_3)$, $([(12)(34)], \mathbb{C}_{(1,1)})$, $([(12)(34)], \mathbb{C}_{(1,-1)})$, $([(12)(34)], \mathbb{C}_{(-1,1)})$, $([(12)(34)], \mathbb{C}_{(-1,-1)})$, $([(123)], \mathbb{C}_1)$, $([(123)], \mathbb{C}_\omega)$, $([(123)], \mathbb{C}_{\bar{\omega}})$, $([(132)], \mathbb{C}_1)$, $([(132)], \mathbb{C}_\omega)$ and $([(132)], \mathbb{C}_{\bar{\omega}})$, each labelling a multiplet of twisted sector local operators. Finally, Lagrangian algebras in $\text{Vec}_{\mathbb{A}_4}^{\mathbb{A}_4}$ are labelled by (conjugacy classes) of subgroups $H \leq \mathbb{A}_4$ and cohomology classes in $H^2(H, \mathbb{U}(1))$. Using the above data, we find seven Lagrangian algebras: $L(0, 1)$, $L(\mathbb{Z}_2, 1)$, $L(\mathbb{Z}_3, 1)$, $L(\mathbb{Z}_2 \oplus \mathbb{Z}_2, 1)$, $L(\mathbb{Z}_2 \oplus \mathbb{Z}_2, \beta)$, $L(\mathbb{A}_4, 1)$ and $L(\mathbb{A}_4, \beta)$, which we explicitly compute below:¹⁹

- $L(0, 1)$: Every element of $L(0, 1)$ is homogeneous of degree $() \in \mathbb{A}_4$. But, $L(0, 1)_{()} \cong \mathbb{C}(\mathbb{A}_4)$, as an object in $\text{Rep}(\mathbb{A}_4)$. It follows from the decomposition of the regular representation into irreducible representations that

$$L(0, 1) \cong ([()], \mathbb{C}_1) \oplus ([()], \mathbb{C}_\omega) \oplus ([()], \mathbb{C}_{\bar{\omega}}) \oplus 3 \cdot ([()], V_3) \quad (3.71)$$

- $L(\mathbb{Z}_2, 1)$: Consider the subgroup $\mathbb{Z}_2 = \langle (12)(34) \rangle$. Recall that $\varsigma \in L(\mathbb{Z}_2, 1)$ is homogeneous of degree $y \in \mathbb{A}_4$ if and only if $\varsigma(x) \in \mathbb{C}[\mathbb{Z}_2]$ is homogeneous of degree $x^{-1}yx$, for every $x \in G$. Therefore, $\text{supp}(L(\mathbb{Z}_2, 1)) = [()] \cup [(12)(34)]$. On the one hand, we already know that $L(\mathbb{Z}_2, 1)_{[()] } \cong \mathbb{C}(\mathbb{A}_4/\mathbb{Z}_2)$, which is isomorphic to $\text{Ind}_{\mathbb{Z}_2}^{\mathbb{A}_4}(\mathbb{C}_1)$ as an object in $\text{Rep}(\mathbb{A}_4)$. From the character table, we read that $\text{Res}_{\mathbb{Z}_2}^{\mathbb{A}_4}(\mathbb{C}_1) \cong \text{Res}_{\mathbb{Z}_2}^{\mathbb{A}_4}(\mathbb{C}_\omega) \cong \text{Res}_{\mathbb{Z}_2}^{\mathbb{A}_4}(\mathbb{C}_{\bar{\omega}}) \cong \mathbb{C}_1$ and

$$\dim_{\mathbb{C}} \text{Hom}_{\text{Rep}(\mathbb{Z}_2)}(\text{Res}_{\mathbb{Z}_2}^{\mathbb{A}_4}(V_3), \mathbb{C}_1) = \frac{1}{2}(3 - 1) = 1. \quad (3.72)$$

¹⁹In order to obtain the decomposition into simple objects of each Lagrangian, one could simply employ the multiplicity formula (3.37), but it more enlightening to derive it from the definition.

By Frobenius reciprocity, one obtains that $\text{Ind}_{\mathbb{Z}_2}^{\mathbb{A}_4}(\mathbb{C}_1) \cong \mathbb{C}_1 \oplus \mathbb{C}_\omega \oplus \mathbb{C}_{\bar{\omega}} \oplus V_3$. It follows that, as an object in $\text{Vec}_{\mathbb{A}_4}^{\mathbb{A}_4}$, we have $L(\mathbb{Z}_2, 1)_{[()]} \cong ([()], \mathbb{C}_1) \oplus ([()], \mathbb{C}_\omega) \oplus ([()], \mathbb{C}_{\bar{\omega}}) \oplus ([()], V_3)$. On the other hand, suppose that $\varsigma \in L(\mathbb{Z}_2, 1)$ is homogeneous of degree $(12)(34)$, which requires that $\text{supp}(\varsigma) = Z_G((12)(34)) \cong \mathbb{Z}_2 \oplus \mathbb{Z}_2$. The defining requirement that $\varsigma(gh^{-1}) = h \cdot \varsigma(g)$, for every $g \in \mathbb{Z}_2 \oplus \mathbb{Z}_2$ and $h \in \mathbb{Z}_2$, then implies that $L(\mathbb{Z}_2, 1)_{(12)(34)} \cong \mathbb{C}((\mathbb{Z}_2 \oplus \mathbb{Z}_2)/\mathbb{Z}_2)$, which is isomorphic to $\text{Ind}_{\mathbb{Z}_2}^{\mathbb{Z}_2 \oplus \mathbb{Z}_2}(\mathbb{C}_1)$ as an object in $\text{Rep}(\mathbb{Z}_2 \oplus \mathbb{Z}_2)$. From the character table of $\mathbb{Z}_2 \oplus \mathbb{Z}_2$, we read that $\text{Res}_{\mathbb{Z}_2}^{\mathbb{Z}_2 \oplus \mathbb{Z}_2}(\mathbb{C}_{(1,1)}) \cong \text{Res}_{\mathbb{Z}_2}^{\mathbb{Z}_2 \oplus \mathbb{Z}_2}(\mathbb{C}_{(1,-1)}) \cong \mathbb{C}_1$. By Frobenius reciprocity, one obtains that $\text{Ind}_{\mathbb{Z}_2}^{\mathbb{Z}_2 \oplus \mathbb{Z}_2}(\mathbb{C}_1) \cong \mathbb{C}_{(1,1)} \oplus \mathbb{C}_{(1,-1)}$. Repeating the same derivations for $L(\mathbb{Z}_2, 1)_{(13)(24)}$ and $L(\mathbb{Z}_2, 1)_{(14)(23)}$ yields that, as an object in $\text{Vec}_{\mathbb{A}_4}^{\mathbb{A}_4}$, we have $L(\mathbb{Z}_2, 1)_{[(12)(34)]} \cong ([(12)(34)], \mathbb{C}_{(1,1)}) \oplus ([(12)(34)], \mathbb{C}_{(1,-1)})$. Bringing everything together yields

$$L(\mathbb{Z}_2, 1) \cong ([()], \mathbb{C}_1) \oplus ([()], \mathbb{C}_\omega) \oplus ([()], \mathbb{C}_{\bar{\omega}}) \oplus ([()], V_3) \oplus ([(12)(34)], \mathbb{C}_{(1,1)}) \oplus ([(12)(34)], \mathbb{C}_{(1,-1)}). \quad (3.73)$$

• $L(\mathbb{Z}_3, 1)$: Consider the subgroup $\mathbb{Z}_3 = \langle (123) \rangle$. By definition, $\varsigma \in L(\mathbb{Z}_3, 1)$ is homogeneous of degree $y \in \mathbb{A}_4$ if and only if $\varsigma(x) \in \mathbb{C}[\mathbb{Z}_3]$ is homogeneous of degree $x^{-1}yx$, for every $x \in \mathbb{A}_4$. This means $x^{-1}yx$ must evaluate to an element within \mathbb{Z}_3 . Therefore, $\text{supp}(L(\mathbb{Z}_3, 1)) = [()] \cup [(123)] \cup [(132)]$. On the one hand, we have $L(\mathbb{Z}_3, 1)_{[()]} \cong \mathbb{C}(\mathbb{A}_4/\mathbb{Z}_3)$, which is isomorphic to $\text{Ind}_{\mathbb{Z}_3}^{\mathbb{A}_4}(\mathbb{C}_1)$ as an object in $\text{Rep}(\mathbb{A}_4)$. From the character table and Frobenius reciprocity, one obtains that $\text{Ind}_{\mathbb{Z}_3}^{\mathbb{A}_4}(\mathbb{C}_1) \cong \mathbb{C}_1 \oplus V_3$. Therefore, as an object in $\text{Vec}_{\mathbb{A}_4}^{\mathbb{A}_4}$, we have $L(\mathbb{Z}_3, 1)_{[()]} \cong ([()], \mathbb{C}_1) \oplus ([()], V_3)$. On the other hand, suppose ς is homogeneous of degree $y \in [(123)]$. For $\varsigma(x)$ to be non-zero, the condition $x^{-1}yx \in \mathbb{Z}_3$ must hold. Since conjugation preserves the conjugacy class and $[(123)] \cap \mathbb{Z}_3 = \{(123)\}$, it follows that $x^{-1}yx = y$, which implies $x \in Z_{\mathbb{A}_4}(y)$. The support is therefore exactly the centraliser $Z_{\mathbb{A}_4}((123)) = \mathbb{Z}_3$. Given that the index $(Z_{\mathbb{A}_4}(y) : \mathbb{Z}_3) = 1$, the equivariance structure on this one-dimensional space corresponds to the trivial representation of the centraliser. By the analogous argument for the class $[(132)]$, we obtain $L(\mathbb{Z}_3, 1)_{[(123)]} \cong ([(123)], \mathbb{C}_1)$ and $L(\mathbb{Z}_3, 1)_{[(132)]} \cong ([(132)], \mathbb{C}_1)$. Bringing everything together yields

$$L(\mathbb{Z}_3, 1) \cong ([()], \mathbb{C}_1) \oplus ([()], V_3) \oplus ([(123)], \mathbb{C}_1) \oplus ([(132)], \mathbb{C}_1). \quad (3.74)$$

• $L(\mathbb{Z}_2 \oplus \mathbb{Z}_2, 1)$: Consider the subgroup $\mathbb{Z}_2 \oplus \mathbb{Z}_2 = \langle (12)(34), (13)(24) \rangle$. By definition, $\varsigma \in L(\mathbb{Z}_2 \oplus \mathbb{Z}_2, 1)$, is homogeneous of degree $y \in \mathbb{A}_4$ if and only if $\varsigma(x) \in \mathbb{C}[\mathbb{Z}_2 \oplus \mathbb{Z}_2]$ is homogeneous of degree $x^{-1}yx$, for every $x \in G$. Therefore, $\text{supp}(L(\mathbb{Z}_2 \oplus \mathbb{Z}_2, 1)) = [()] \cup [(12)(34)]$. On the one hand, we have $L(\mathbb{Z}_2 \oplus \mathbb{Z}_2, 1)_{[()]} \cong \mathbb{C}(\mathbb{A}_4/\mathbb{Z}_2 \oplus \mathbb{Z}_2)$, which is isomorphic to $\text{Ind}_{\mathbb{Z}_2 \oplus \mathbb{Z}_2}^{\mathbb{A}_4}(\mathbb{C}_{(1,1)})$ as an object in $\text{Rep}(\mathbb{A}_4)$. From the character table and Frobenius reciprocity, one obtains that $\text{Ind}_{\mathbb{Z}_2 \oplus \mathbb{Z}_2}^{\mathbb{A}_4}(\mathbb{C}_{(1,1)}) \cong \mathbb{C}_1 \oplus \mathbb{C}_\omega \oplus \mathbb{C}_{\bar{\omega}}$. Therefore, as an object in $\text{Vec}_{\mathbb{A}_4}^{\mathbb{A}_4}$, we have $L(\mathbb{Z}_2 \oplus \mathbb{Z}_2, 1)_{[()]} \cong ([()], \mathbb{C}_1) \oplus ([()], \mathbb{C}_\omega) \oplus ([()], \mathbb{C}_{\bar{\omega}})$. On the other hand, suppose that $\varsigma \in L(\mathbb{Z}_2 \oplus \mathbb{Z}_2, 1)$ is homogeneous of degree $(12)(34)$ so that, for every $x \in \mathbb{A}_4$, $\varsigma(x) \in \mathbb{C}[\mathbb{Z}_2 \oplus \mathbb{Z}_2]$ must be homogeneous of degree $x^{-1}(12)(34)x$. Recall that the basis functions $\varsigma_{a,h}$ we introduced in eq. (3.32), where $a \in \{1, \dots, (\mathbb{A}_4 : \mathbb{Z}_2 \oplus \mathbb{Z}_2)\}$ and $h \in \mathbb{Z}_2 \oplus \mathbb{Z}_2$ are homogeneous of degree $r_a h r_a^{-1}$. But $\mathbb{A}_4/(\mathbb{Z}_2 \oplus \mathbb{Z}_2) = \{\mathbb{Z}_2 \oplus \mathbb{Z}_2, (123)(\mathbb{Z}_2 \oplus \mathbb{Z}_2), (132)(\mathbb{Z}_2 \oplus \mathbb{Z}_2)\}$ and $(123) \cdot (13)(24) \cdot (132) = (132) \cdot (14)(23) \cdot (123) = (12)(34)$, so that the space of functions ς that are homogeneous of degree $(12)(34)$ is spanned by $\varsigma_{1,(12)(34)}$, $\varsigma_{2,(13)(24)}$ and $\varsigma_{3,(14)(23)}$, whereby $r_1 = ()$, $r_2 = (123)$ and $r_3 = (132)$. Similarly, one finds that the nine-dimensional space of homogeneous functions of degree in $[(12)(34)]$ is spanned by functions $\varsigma_{a,h}$ such that $a \in \{1, \dots, (\mathbb{A}_4 : \mathbb{Z}_2 \oplus \mathbb{Z}_2)\}$ and $h \in [(12)(34)]$. Now, recall that the G -equivariance structure of $L(\mathbb{Z}_2 \oplus \mathbb{Z}_2, 1)$ is given by $g \cdot \varsigma_{a,h} = \varsigma_{g(a), h g a h g^{-1}} = \varsigma_{g(a), h}$, for every $g \in \mathbb{A}_4$ and $h \in [(12)(34)]$. Therefore, for each $h \in [(12)(34)]$, $\mathbb{C}\{\varsigma_{a,h}\}_{a=1, \dots, (\mathbb{A}_4 : \mathbb{Z}_2 \oplus \mathbb{Z}_2)} \cong \mathbb{C}(\mathbb{A}_4/\mathbb{Z}_2 \oplus \mathbb{Z}_2)$, so that $L(\mathbb{Z}_2 \oplus \mathbb{Z}_2, 1)_{[(12)(34)]} \cong 3 \cdot ([(12)(34)], \mathbb{C}_{(1,1)})$. Bringing everything together yields

$$L(\mathbb{Z}_2 \oplus \mathbb{Z}_2, 1) \cong ([()], \mathbb{C}_1) \oplus ([()], \mathbb{C}_\omega) \oplus ([()], \mathbb{C}_{\bar{\omega}}) \oplus 3 \cdot ([(12)(34)], \mathbb{C}_{(1,1)}). \quad (3.75)$$

• $L(\mathbb{Z}_2 \oplus \mathbb{Z}_2, \beta)$: Let us now choose β to be the normalised representative of the non-trivial cohomology class in $H^2(\mathbb{Z}_2 \oplus \mathbb{Z}_2, \mathbb{U}(1))$ such that $\beta(h_1, h_2)$ equals -1 if $h_1 \in \{(13)(24), (14)(23)\}$ and $h_2 \in \{(12)(34), (14)(23)\}$, and equals $+1$ otherwise. We have already established that $L(\mathbb{Z}_2 \oplus \mathbb{Z}_2, \beta)_{[(\cdot)]}$ decomposes as $([(\cdot)], \mathbb{C}_1) \oplus (([\cdot]), \mathbb{C}_\omega) \oplus (([\cdot]), \mathbb{C}_{\bar{\omega}})$, as an object in $\text{Vec}_{\mathbb{A}_4}^{\mathbb{A}_4}$. We also already know that the space of functions in $L(\mathbb{Z}_2 \oplus \mathbb{Z}_2, \beta)$ that are homogeneous of degree in $[(12)(34)]$ is spanned by functions $\varsigma_{a,h}$ for $a \in \{1, \dots, (\mathbb{A}_1 : \mathbb{Z}_2 \oplus \mathbb{Z}_2)\}$ and $h \in [(12)(34)]$. The G -equivariant structure is now given by $g \cdot \varsigma_{a,h} = \beta_h(h_{g,a}) \varsigma_{g(a),h}$, where $\beta_h(h_{g,a}) = \beta(h_{g,a}, h) / \beta(h, h_{g,a})$. For instance, fix h to be $(12)(34)$. Given the above formula for β , we have $\beta_{(12)(34)}(h_{g,a}) = \beta(h_{g,a}, (12)(34))$. For every $g \in \mathbb{Z}_2 \oplus \mathbb{Z}_2$, we have $g \cdot \varsigma_{a,(12)(34)} = \beta(h_{g,a}, (12)(34)) \varsigma_{a,(12)(34)}$. In particular, for every $g \in \mathbb{Z}_2 \oplus \mathbb{Z}_2$, $g \cdot \varsigma_{1,(12)(34)} = \beta(g, (12)(34)) \varsigma_{1,(12)(34)}$, which equals $-\varsigma_{1,(12)(34)}$ if $g \in \{(13)(24), (14)(23)\}$, and equals $\varsigma_{1,(12)(34)}$ otherwise. Therefore, $\mathbb{C}\{\varsigma_{1,(12)(34)}\} \cong \mathbb{C}_{(1,-1)}$ as a representation of $\mathbb{Z}_2 \oplus \mathbb{Z}_2$. Similarly, it follows from $h_{(12)(34),2} = (13)(24)$, $h_{(12)(34),3} = (14)(23)$, $h_{(13)(24),2} = (14)(23)$ and $h_{(13)(24),3} = (12)(34)$ that $\mathbb{C}\{\varsigma_{2,(12)(34)}\} \cong \mathbb{C}\{\varsigma_{3,(12)(34)}\} \cong \mathbb{C}_{(1,-1)}$. A similar computation holds for $h = (13)(24)$ and $h = (14)(23)$. This is enough to imply that, for each $h \in [(12)(34)]$, $\mathbb{C}\{\varsigma_{a,h}\}_{a=1, \dots, (\mathbb{A}_1 : \mathbb{Z}_2 \oplus \mathbb{Z}_2)} \cong \text{Ind}_{\mathbb{Z}_2 \oplus \mathbb{Z}_2}^{\mathbb{A}_4}(\mathbb{C}_{(1,-1)})$. Therefore, as an object in $\text{Vec}_{\mathbb{A}_4}^{\mathbb{A}_4}$, we have $L(\mathbb{Z}_2 \oplus \mathbb{Z}_2, \beta)_{[(12)(34)]} \cong 3 \cdot (([12)(34)], \mathbb{C}_{(1,-1)})$. Bringing everything together yields

$$L(\mathbb{Z}_2 \oplus \mathbb{Z}_2, \beta) \cong (([\cdot]), \mathbb{C}_1) \oplus (([\cdot]), \mathbb{C}_\omega) \oplus (([\cdot]), \mathbb{C}_{\bar{\omega}}) \oplus 3 \cdot (([12)(34)], \mathbb{C}_{(1,-1)}). \quad (3.76)$$

• $L(\mathbb{A}_4, 1)$: By definition, $L(\mathbb{A}_4, 1) = \mathbb{C}[\mathbb{A}_4] = \mathbb{C}\{e_g\}_{g \in \mathbb{A}_4}$ with $g_1 \cdot e_{g_2} = e_{g_1 g_2 g_1^{-1}}$, for every $g_1, g_2 \in \mathbb{A}_4$. One immediately concludes that $\mathbb{C}[\mathbb{A}_4] \cong \mathbb{C}(\mathbb{A}_4 / Z_{\mathbb{A}_4}(\cdot)) \oplus \mathbb{C}(\mathbb{A}_4 / Z_{\mathbb{A}_4}((12)(34))) \oplus \mathbb{C}(\mathbb{A}_4 / Z_{\mathbb{A}_4}((123))) \oplus \mathbb{C}(\mathbb{A}_4 / Z_{\mathbb{A}_4}((132)))$, as an object in $\text{Rep}(\mathbb{A}_4)$. Remembering that $\mathbb{C}(\mathbb{A}_4 / Z_{\mathbb{A}_4}(x_0)) \cong \text{Ind}_{Z_{\mathbb{A}_4}(x_0)}^{\mathbb{A}_4}(\mathbb{C})$, for every $[x_0] \in \text{Cl}(\mathbb{A}_4)$, one finally obtains

$$L(\mathbb{A}_4, 1) \cong (([\cdot]), \mathbb{C}_1) \oplus (([12)(34)], \mathbb{C}_{(1,1)}) \oplus (([123]), \mathbb{C}_1) \oplus (([132]), \mathbb{C}_1). \quad (3.77)$$

• $L(\mathbb{A}_4, \beta)$: Let β be the normalised representative of the non-trivial cohomology class in $H^2(\mathbb{A}_4, \mathbb{U}(1))$ that restricts to the 2-cocycle of $\mathbb{Z}_2 \oplus \mathbb{Z}_2$ utilised in the computation of $L(\mathbb{Z}_2 \oplus \mathbb{Z}_2, \beta)$. By definition, $L(\mathbb{A}_4, \beta) = \mathbb{C}[\mathbb{A}_4]^\beta$. We have already established that it decomposes as (3.40), as an object in $\text{Vec}_{\mathbb{A}_4}^{\mathbb{A}_4}$, so that we simply need to compute the one-dimensional representations $\mathbb{C}_{\beta_{x_0}}$, for every $[x_0] \in \text{Cl}(\mathbb{A}_4)$. Simply mimicking the derivation of $L(\mathbb{Z}_2 \oplus \mathbb{Z}_2, \beta)$ yields

$$L(\mathbb{A}_4, \beta) \cong (([\cdot]), \mathbb{C}_1) \oplus (([12)(34)], \mathbb{C}_{(1,-1)}) \oplus (([123]), \mathbb{C}_1) \oplus (([132]), \mathbb{C}_1). \quad (3.78)$$

Let us make some general remarks about these Lagrangian algebras. First, we notice that out of the fourteen total simple objects of $\mathcal{Z}(\text{Vec}_{\mathbb{A}_4})$, eight simple objects appear in Lagrangian algebras. One can construct multiplets of order parameters associated with each one of these eight simple objects. However, inspecting how these Lagrangian algebras intersect, we find that not all of them are required to identify each one of the seven gapped phases. As a matter of fact, it is enough to consider three order parameters only.

We begin by noticing that $(([\cdot]), \mathbb{C}_\omega)$ and $(([\cdot]), \mathbb{C}_{\bar{\omega}})$ always come in pair, and so do $(([123]), \mathbb{C}_1)$ and $(([132]), \mathbb{C}_1)$. Moreover, these two pairs of objects are mutually exclusive, thereby dividing the seven gapped phases into two sets. Together, these pairs of objects signal whether the algebra $\mathbb{C}[\mathbb{Z}_3]$ of lines is preserved in the ground state subspace. The object $(([123]), \mathbb{C}_1) \oplus (([132]), \mathbb{C}_1)$ appears in three Lagrangian algebras indicating that the algebra $\mathbb{C}[\mathbb{Z}_3]$ of lines is preserved in the three corresponding gapped phases. Further inspection reveals that these three gapped phases are distinguished

by their corresponding Lagrangian algebras, each containing a distinct three-dimensional simple object: $([()], V_3)$, $([(12)(34)], \mathbb{C}_{(1,1)})$, and $([(12)(34)], \mathbb{C}_{(1,-1)})$, respectively. The presence of the simple object $([()], V_3)$, which corresponds to a multiplet of charged local operators signals that the algebra $\mathbb{C}[\mathbb{Z}_2 \oplus \mathbb{Z}_2]$ of lines cannot be preserved, at least not in its entirety. On the other hand, since $[(12)(34)]$ contains all the non-trivial elements of $\mathbb{Z}_2 \oplus \mathbb{Z}_2$, the presence of the simple objects $([(12)(34)], \mathbb{C}_{(1,1)})$ and $([(12)(34)], \mathbb{C}_{(1,-1)})$ signals that the algebras $\mathbb{C}[\mathbb{Z}_2 \oplus \mathbb{Z}_2]$ and $\mathbb{C}[\mathbb{Z}_2 \oplus \mathbb{Z}_2]^\beta$, respectively, must be at least partially preserved. The remaining four gapped phases where the algebra of lines $\mathbb{C}[\mathbb{Z}_3]$ is not preserved can also be distinguished in terms of these three simple objects: each appears individually in a single Lagrangian algebra, while the three of them simultaneously appears in the last one. Combining these remarks, we can detect any \mathbb{A}_4 -symmetric gapped phase by measuring the expectation values of three order parameters, namely two local operators in the multiplets associated with $([()], \mathbb{C}_\omega)$ and $([()], V_3)$, respectively, as well as a string operator in the multiplet associated with $([(12)(34)], \mathbb{C}_{(1,1)})$.

Let us consider a couple of examples. Suppose the three order parameters mentioned above acquire non-vanishing expectation values in the ground state subspace. Together, they signal that the algebra $\mathbb{C}[\mathbb{Z}_3]$ of lines cannot be preserved, and although the algebras $\mathbb{C}[\mathbb{Z}_2 \oplus \mathbb{Z}_2]$ or $\mathbb{C}[\mathbb{Z}_2 \oplus \mathbb{Z}_2]^\beta$ may not be fully preserved either, the whole symmetry $\text{Vec}_{\mathbb{A}_4}$ cannot be spontaneously broken. There is only one possibility, namely the gapped phase with Lagrangian algebra $L(\mathbb{Z}_2, 1)$. The presence of the simple object $([(12)(34)], \mathbb{C}_{(1,-1)})$ may seem surprising—this type of terms being typical of non-trivial SPTs—but it is consistent with the fact that the restriction of the 2-cocycle to \mathbb{Z}_2 is trivial. Suppose instead that all the order parameters yield vanishing expectation values in the ground state subspace. We know from the local charged operators that all the symmetry lines are preserved in the ground state subspace; and since the string operators associated with $([(12)(34)], \mathbb{C}_{(1,1)})$ does not gain an expectation value either, then they must form the algebra $\mathbb{C}[\mathbb{A}_4]^\beta$. The only possibility is the gapped phase associated with the Lagrangian algebra $L(\mathbb{A}_4, \beta)$.

We conclude with a comment echoing previous remarks. We are accustomed to the idea that string order parameters for non-trivial SPTs may require the endpoint twisted sector local operators to transform non-trivially. In the present example, this is reflected by the appearance of the simple objects $([(12)(34)], \mathbb{C}_{(1,-1)})$ —which depends implicitly on the 2-cocycle β —in the Lagrangian algebra $L(\mathbb{A}_4, \beta)$. For non-abelian groups, however, such dressing can also be necessary for trivial SPTs. Consider, for instance, the fixed point of the trivial SPT associated with the Lagrangian algebra $L(\mathbb{A}_4, 1)$, constructed from the algebra $A(\mathbb{A}_4, 1, V_3)$. Observe the presence of the simple object $([(123)], \mathbb{C}_1)$, which, as an object in $\text{Rep}(A_4)$, is isomorphic to $\text{Ind}_{\mathbb{Z}_3}^{\mathbb{A}_4}(\mathbb{C}_1) \cong \mathbb{C}_1 \oplus V_3$. In particular, this implies that the space of multiplets is quite large. While a generic string operator in a generic multiplet would acquire a non-vanishing expectation value, choosing a multiplet so that the string operator would boil down to the ordinary *disorder operators* would result in a vanishing expectation value, by virtue of the representation matrix of (123) in the representation V_3 being traceless. Instead, the canonical multiplet defined via eq. (3.43) would have a non-vanishing expectation value.

SECTION 4

Non-invertible symmetry

In this section, we extend the techniques we employed in the invertible case to the case of a finite non-invertible symmetry. Although we focus on the case of symmetry lines furnishing the fusion category of representations of a finite group G , we argue that the techniques apply more generally.

4.1 Microscopic Hilbert space

Consider any one-dimensional quantum theory with a symmetry Vec_G . Gauging the symmetry results in a new (effective) one-dimensional quantum theory with a non-invertible symmetry [FFRS09, Tac17, BT17]. The topological lines of this new theory are encoded into the fusion category $\text{Rep}(G)$ of finite-dimensional representations of G and G -equivariant maps. More generally, as for invertible symmetries, there are many ways to realise a symmetry $\text{Rep}(G)$ in one-dimensional quantum lattice models [LDOV21, LDV22, JSW24]. Throughout this section, we work within the following setup: Let $K = \bigoplus_{g \in G} K_g = \mathbb{C}\{k_r\}_{r=1, \dots, \dim_{\mathbb{C}} K}$ be an object in Vec_G and Λ be a finite subset of the lattice \mathbb{Z} . To every ‘site’ $i \in \Lambda$, we assign a copy of the vector space K together with a copy of the algebra $\text{Mat}_{\mathbb{C}}(\dim_{\mathbb{C}} K)$ so that we identify $\mathcal{A}_{\Lambda} := \bigotimes_{i \in \Lambda} \text{Mat}_{\mathbb{C}}(\dim_{\mathbb{C}} K)_{\{i\}}$ with the algebra of bounded operators acting on the microscopic Hilbert space $\mathcal{H}_{\Lambda} := \bigotimes_{i \in \Lambda} K_{\{i\}}$. As in sec. 2.1, any state in \mathcal{H}_{Λ} can be expressed as an MPS.

Consider the topological line labelled by a simple object $V = \mathbb{C}\{v_d\}_{d=1, \dots, \dim_{\mathbb{C}} V}$ in $\text{Rep}(G)$ with algebra homomorphism $\rho: \mathbb{C}[G] \rightarrow \text{End}_{\mathbb{C}}(V)$. Let us construct the corresponding symmetry MPO. Note that for every $r \in \{1, \dots, \dim_{\mathbb{C}} K\}$, the basis vector $k_r \in K$ decomposes uniquely as a sum $\sum_{g \in G} k_{r,g}$ of homogeneous components such that $|k_{r,g}| = g \in G$. In other words, recall that $\text{Vec}_G \simeq \text{Comod}(\mathbb{C}[G])$, such that the *coaction* $K \rightarrow \mathbb{C}[G] \otimes K$ of the $\mathbb{C}[G]$ -comodule associated with $K \in \text{Vec}_G$ is provided by $k_r \mapsto \sum_{g \in G} e_g \otimes k_{r,g}$, for every $g \in G$ and $r \in \{1, \dots, \dim_{\mathbb{C}} K\}$. Assuming closed boundary conditions, the MPO labelled by V is provided by

$$\sum_{r_1, \dots, r_{|\Lambda|}} \sum_{g_1, \dots, g_{|\Lambda|}} \text{tr}_V [\rho(g_1^{-1}) \rho(g_2^{-1}) \cdots \rho(g_{|\Lambda|}^{-1})] k_{r_1, g_1} \otimes \cdots \otimes k_{r_{|\Lambda|}, g_{|\Lambda|}} \otimes k^{r_1, g_1} \otimes \cdots \otimes k^{r_{|\Lambda|}, g_{|\Lambda|}}. \quad (4.1)$$

Finally, every G -grading preserving map $K^{\otimes N} \rightarrow K^{\otimes N}$ gives rise to a symmetric operator in \mathcal{A}_{Λ} .

The symmetry MPO labelled by any $V \in \text{Irr}(\text{Rep}(G))$ can be conveniently depicted as

where we introduced the tensor²⁰

$$\begin{aligned} \begin{array}{c} \uparrow \\ V \\ \leftarrow \square \rightarrow \\ \uparrow \\ V \end{array} &\equiv \sum_{d_1, d_2=1}^{\dim_{\mathbb{C}} V} \sum_{r=1}^{\dim_{\mathbb{C}} K} \begin{array}{c} r \\ \uparrow \\ d_1 \leftarrow \square \rightarrow d_2 \\ \uparrow \\ r \end{array} k_r \otimes k^r \otimes v_{d_1} \otimes v^{d_2} \\ &\equiv \sum_{d_1, d_2=1}^{\dim_{\mathbb{C}} V} \sum_{r=1}^{\dim_{\mathbb{C}} K} \sum_{g \in G} \rho(g^{-1})_{d_2}^{d_1} k_{r,g} \otimes k^{r,g} \otimes v_{d_1} \otimes v^{d_2}. \end{aligned} \quad (4.3)$$

²⁰Notice that in the case where K would be chosen to be $\mathbb{C}[G]$, the tensor (4.3) boils down to a rotated version of the tensor (2.13) we defined previously. In sec. 2.1, we realised the symmetry Vec_G implicitly invoking the equivalence $(\text{Rep}(G))_{\text{Vec}}^* \simeq \text{Vec}_G$, which makes Vec an invertible $(\text{Rep}(G), \text{Vec}_G)$ -bimodule category. We are now realising the symmetry $\text{Rep}(G)$ invoking the equivalence $(\text{Vec}_G)_{\text{Vec}}^* \simeq \text{Rep}(G)$, which makes Vec an invertible $(\text{Vec}_G, \text{Rep}(G))$ -bimodule category. This discrepancy explains why the group is required to act from the right. Note that we could have avoided this convention at the cost of reversing some arrows but our choice allows us to treat both cases—and ultimately the case of an arbitrary symmetry fusion category—in a similar way. Moreover, our convention is that dictated by the equivalences $\text{Mod}(\text{Tube}(\text{Vec}_G)) \simeq \mathcal{Z}(\text{Vec}_G) \simeq \text{Vec}_G^{\mathcal{C}} \simeq \mathcal{Z}(\text{Rep}(G)) \simeq \text{Mod}(\text{Tube}(\text{Rep}(G)))$ (see sec. 4.5).

The various symmetry operators can be organised into a block-injective MPO

$$\begin{array}{c} \uparrow \\ \leftarrow \square \leftarrow \\ \uparrow \end{array} = \bigoplus_{V \in \text{Irr}(\text{Rep}(G))} \begin{array}{c} \uparrow \\ \leftarrow V \square V \leftarrow \\ \uparrow \end{array} . \quad (4.4)$$

For every $V_1, V_2, V_3 \in \text{Irr}(\text{Rep}(G))$, let $N_{V_3}^{V_1 V_2}$ be the non-negative integer such that $V_1 \otimes V_2 \cong \bigoplus_{V_3 \in \text{Irr}(\text{Rep}(G))} N_{V_3}^{V_1 V_2} V_3$. For each $i \in \{1, \dots, N_{V_3}^{V_1 V_2}\}$, let us denote by $\varphi_{V_3, i}^{V_1 V_2}$ and $\bar{\varphi}_{V_3, i}^{V_1 V_2}$ the linear maps furnishing bases for $\text{Hom}_G(V_1 \otimes V_2, V_3)$ and $\text{Hom}_G(V_3, V_1 \otimes V_2)$, respectively. By definition of the monoidal structure in $\text{Rep}(G)$, for every $V_1 = \mathbb{C}\{v_{d_1}\}_{d_1}, V_2 = \mathbb{C}\{v_{d_2}\}_{d_2} \in \text{Irr}(\text{Rep}(G))$, we have

$$\begin{array}{c} \uparrow \\ \leftarrow V_1 \square \leftarrow \\ \uparrow \\ \leftarrow V_2 \square \leftarrow \\ \uparrow \end{array} = \sum_{\substack{V_3 \in V_1 \otimes V_2 \\ 1 \leq i \leq N_{V_3}^{V_1 V_2}}} \begin{array}{c} \leftarrow V_1 \\ \varphi_{V_3, i}^{V_1 V_2} \\ \leftarrow V_2 \end{array} \begin{array}{c} \uparrow \\ \leftarrow V_3 \square \leftarrow \\ \uparrow \end{array} \begin{array}{c} \leftarrow V_1 \\ \varphi_{V_3, i}^{V_1 V_2} \\ \leftarrow V_2 \end{array} , \quad (4.5)$$

where, for every $V_3 = \mathbb{C}\{v_{d_3}\}_{d_3} \in V_1 \otimes V_2$ and $i \in \{1, \dots, N_{V_3}^{V_1 V_2}\}$, we introduced tensors

$$\begin{array}{c} \leftarrow V_3 \\ \varphi_{V_3, i}^{V_1 V_2} \\ \leftarrow V_2 \end{array} \begin{array}{c} \leftarrow V_1 \\ \varphi_{V_3, i}^{V_1 V_2} \\ \leftarrow V_2 \end{array} \equiv \sum_{\substack{1 \leq d_1 \leq \dim_{\mathbb{C}} V_1 \\ 1 \leq d_2 \leq \dim_{\mathbb{C}} V_2 \\ 1 \leq d_3 \leq \dim_{\mathbb{C}} V_3}} \begin{array}{c} \leftarrow V_3 \\ \varphi_{V_3, i}^{V_1 V_2} \\ \leftarrow V_2 \end{array} \begin{array}{c} \leftarrow V_1 \\ d_1 \\ \leftarrow V_2 \\ d_2 \end{array} v_{d_3} \otimes v^{d_1} \otimes v^{d_2} \equiv \sum_{\substack{1 \leq d_1 \leq \dim_{\mathbb{C}} V_1 \\ 1 \leq d_2 \leq \dim_{\mathbb{C}} V_2 \\ 1 \leq d_3 \leq \dim_{\mathbb{C}} V_3}} \overline{\begin{bmatrix} V_1 & V_2 & V_3 \\ d_1 & d_2 & d_3 \end{bmatrix}}_i v_{d_3} \otimes v^{d_1} \otimes v^{d_2}$$

$$\begin{array}{c} \leftarrow V_1 \\ \bar{\varphi}_{V_3, i}^{V_1 V_2} \\ \leftarrow V_2 \end{array} \begin{array}{c} \leftarrow V_3 \\ \bar{\varphi}_{V_3, i}^{V_1 V_2} \\ \leftarrow V_2 \end{array} \equiv \sum_{\substack{1 \leq d_1 \leq \dim_{\mathbb{C}} V_1 \\ 1 \leq d_2 \leq \dim_{\mathbb{C}} V_2 \\ 1 \leq d_3 \leq \dim_{\mathbb{C}} V_3}} \begin{array}{c} \leftarrow V_1 \\ d_1 \\ \leftarrow V_3 \\ d_2 \end{array} v_{d_1} \otimes v_{d_2} \otimes v^{d_3} \equiv \sum_{\substack{1 \leq d_1 \leq \dim_{\mathbb{C}} V_1 \\ 1 \leq d_2 \leq \dim_{\mathbb{C}} V_2 \\ 1 \leq d_3 \leq \dim_{\mathbb{C}} V_3}} \begin{bmatrix} V_1 & V_2 & V_3 \\ d_1 & d_2 & d_3 \end{bmatrix}_i v_{d_1} \otimes v_{d_2} \otimes v^{d_3} ,$$

which evaluate to *Clebsch–Gordan coefficients* satisfying the orthogonality condition

$$\sum_{\substack{1 \leq d_1 \leq \dim_{\mathbb{C}} V_1 \\ 1 \leq d_2 \leq \dim_{\mathbb{C}} V_2}} \overline{\begin{bmatrix} V_1 & V_2 & V_3 \\ d_1 & d_2 & d_3 \end{bmatrix}}_{i_1} \begin{bmatrix} V_1 & V_2 & V_4 \\ d_1 & d_2 & d_4 \end{bmatrix}_{i_2} = \delta_{V_3, V_4} \delta_{d_3, d_4} \delta_{i_1, i_2} . \quad (4.6)$$

As in the invertible case, we interpret this operation as a consequence of the topological invariance of the symmetry lines, allowing us to fuse them locally. Moreover, it follows from the orthogonality condition (4.6) that

$$\begin{array}{c} \leftarrow V_4 \\ \varphi_{V_4, i_4}^{V_1 V_6} \\ \leftarrow V_2 \\ \varphi_{V_5, i_3}^{V_2 V_3} \\ \leftarrow V_3 \end{array} \begin{array}{c} \leftarrow V_1 \\ \varphi_{V_5, i_1}^{V_1 V_2} \\ \leftarrow V_2 \\ \varphi_{V_4, i_2}^{V_5 V_3} \\ \leftarrow V_3 \end{array} = \sum_{V_5 \in V_1 \otimes V_2} \sum_{\substack{1 \leq i_1 \leq N_{V_5}^{V_1 V_2} \\ 1 \leq i_2 \leq N_{V_4}^{V_5 V_3}}} (F_{V_4}^{V_1 V_2 V_3})_{V_6, i_3 i_4}^{V_5, i_1 i_2} \begin{array}{c} \leftarrow V_4 \\ \varphi_{V_4, i_2}^{V_5 V_3} \\ \leftarrow V_2 \\ \varphi_{V_5, i_1}^{V_1 V_2} \\ \leftarrow V_3 \end{array} , \quad (4.7)$$

for every $V_1, \dots, V_4, V_6 \in \text{Irr}(\text{Rep}(G))$, $i_3 \in \{1, \dots, N_{V_5}^{V_2 V_3}\}$ and $i_4 \in \{1, \dots, N_{V_4}^{V_1 V_6}\}$ where we introduced the F -symbols

$$(F_{V_4}^{V_1 V_2 V_3})_{V_6, i_3 i_4}^{V_5, i_1 i_2} := \frac{1}{\dim_{\mathbb{C}} V_4} \sum_{d_1, \dots, d_6} \overline{\begin{bmatrix} V_2 & V_3 & V_6 \\ d_3 & d_3 & d_6 \end{bmatrix}}_{i_3} \overline{\begin{bmatrix} V_1 & V_6 & V_4 \\ d_1 & d_6 & d_4 \end{bmatrix}}_{i_4} \begin{bmatrix} V_1 & V_2 & V_5 \\ d_1 & d_2 & d_5 \end{bmatrix}_{i_1} \begin{bmatrix} V_5 & V_3 & V_4 \\ d_5 & d_3 & d_4 \end{bmatrix}_{i_2} . \quad (4.8)$$

Eq. (4.7) merely encodes a change of basis of $\text{Hom}_G(V_1 \otimes V_2 \otimes V_3, V_4)$. These F -symbols are subject to the *Biedenharn–Elliott* identity, which encodes the pentagon axiom of the monoidal associator of $\text{Rep}(G)$.

4.2 Symmetric gapped phases

Let us now review the classification of one-dimensional $\text{Rep}(G)$ -symmetric gapped phases in terms of block-injective MPSs. As in sec. 2.2, one could proceed by showing that a $\text{Rep}(G)$ -symmetric block-injective MPS furnish a $\text{Rep}(G)$ -module category, classify indecomposable $\text{Rep}(G)$ -module categories, and then construct gapped phases representatives associated with indecomposable $\text{Rep}(G)$ -module categories [GRLM22]. Since we have already commented on the classification of $\text{Rep}(G)$ -module categories, we shall directly construct the corresponding representatives.

In sec. 2.4, we reviewed that (finite semisimple) indecomposable module categories over $\text{Rep}(G)$ and in one-to-one correspondence with those over Vec_G . For every subgroup $H \leq G$ and normalised representative β of a cohomology class $[\beta] \in H^2(H, \text{U}(1))$, recall that the corresponding indecomposable $\text{Rep}(G)$ -module category is provided by the category $\text{Rep}^\beta(H)$ of finite-dimensional projective representation of H such that the $\text{Rep}(G)$ -module structure is provided by the tensor product of representations via the restriction functor $\text{Res}_H^G : \text{Rep}(G) \rightarrow \text{Rep}(H)$. Let us construct a representative of the gapped phase associated with $\text{Rep}^\beta(H)$. Consider a block-injective MPS built from a tensor $\theta : M \rightarrow K \otimes M = \sum_{l_1, l_2=1}^{\dim_{\mathbb{C}} M} \sum_{r=1}^{\dim_{\mathbb{C}} K} (\theta_{l_2}^{l_1})^r k_r \otimes m_{l_1} \otimes m^{l_2}$ such that $\theta^r := \sum_{l_1, l_2}^{\dim_{\mathbb{C}} M} (\theta_{l_2}^{l_1})^r m_{l_1} \otimes m^{l_2} \equiv \bigoplus_{U \in \text{Irr}(\text{Rep}^\beta(H))} \theta_U^r$, where $\theta_U^r \in \text{End}_{\mathbb{C}}(M_U)$, for every $r \in \{1, \dots, \dim_{\mathbb{C}} K\}$. Graphically,²¹

$$\begin{array}{c} \uparrow \\ \text{---} \bigcirc \text{---} \\ \theta \end{array} = \bigoplus_{U \in \text{Irr}(\text{Rep}^\beta(H))} \begin{array}{c} \uparrow \\ \text{---} \bigcirc \text{---} \\ \theta \end{array} \begin{array}{c} U \\ \text{---} \end{array} \begin{array}{c} U \\ \text{---} \end{array} . \quad (4.9)$$

This block-injective MPS is assumed to be $\text{Rep}(G)$ -symmetric, in the sense that the subspace of \mathcal{H}_Λ spanned by its constitute injective MPSs is closed under the action of symmetry MPOs (4.2), for every $V \in \text{Irr}(\text{Rep}(G))$. For every $V \in \text{Irr}(\text{Rep}(G))$ and $U_1, U_2 \in \text{Irr}(\text{Rep}^\beta(H))$, let $N_{U_2}^{VU_1}$ be the non-negative integer such that $V \triangleright U_1 := \text{Res}_H^G(V) \otimes U_1 \cong \bigoplus_{U_2 \in \text{Irr}(\text{Rep}^\beta(H))} N_{U_2}^{VU_1} U_2$. For every $i \in \{1, \dots, N_{U_2}^{VU_1}\}$, there are three-valent tensors $\phi_{U_2, i}^{VU_1}$ and $\bar{\phi}_{U_2, i}^{VU_1}$ such that

$$\begin{array}{c} \begin{array}{c} \uparrow \\ \text{---} \bigcirc \text{---} \\ V \end{array} \\ \begin{array}{c} \leftarrow \text{---} \bigcirc \text{---} \leftarrow \\ U_1 \end{array} \\ \begin{array}{c} \leftarrow \text{---} \bigcirc \text{---} \leftarrow \\ U_1 \end{array} \end{array} = \sum_{\substack{U_2 \in V \triangleright U_1 \\ 1 \leq i \leq N_{U_2}^{VU_1}}} \begin{array}{c} \begin{array}{c} \leftarrow \text{---} \bigcirc \text{---} \leftarrow \\ U_1 \end{array} \\ \begin{array}{c} \leftarrow \text{---} \bigcirc \text{---} \leftarrow \\ U_2 \end{array} \\ \begin{array}{c} \uparrow \\ \text{---} \bigcirc \text{---} \\ U_2 \end{array} \\ \begin{array}{c} \leftarrow \text{---} \bigcirc \text{---} \leftarrow \\ U_1 \end{array} \end{array} \begin{array}{c} \bar{\phi}_{U_2, i}^{VU_1} \\ \phi_{U_2, i}^{VU_1} \end{array} \quad (4.10)$$

and

$$\begin{array}{c} \begin{array}{c} \leftarrow \text{---} \bigcirc \text{---} \leftarrow \\ U_2 \end{array} \\ \begin{array}{c} \leftarrow \text{---} \bigcirc \text{---} \leftarrow \\ U_1 \end{array} \\ \begin{array}{c} \leftarrow \text{---} \bigcirc \text{---} \leftarrow \\ U_3 \end{array} \end{array} = \delta_{U_2, U_3} \delta_{i_1, i_2} \Downarrow_{M_{U_2}} . \quad (4.11)$$

These relations imply that the fixed points of the MPS transfer matrix satisfy an analogue of (2.22).

²¹Here, $U \in \text{Irr}(\text{Rep}^\beta(H))$ merely labels a block of the block-injective MPS tensor, while the corresponding bond space is provided by M_U . In the case of renormalisation group fixed points (see sec. 4.3), these may coincide, but they generically do not.

Now, consider the actions of two symmetry lines associated with simple objects U_1 and U_2 in $\text{Rep}(G)$, respectively. Instead of successively acting with both lines, one can first (locally) fuse them before (locally) acting with the resulting line, which gives rise to the following relation:

$$\sum_{\substack{V_3 \in V_1 \otimes V_2 \\ U_2 \in V_3 \triangleright U_1 \\ i_1, i_2}} \begin{array}{c} \begin{array}{c} V_1 \\ \downarrow \\ \bar{\varphi}_{V_3, i_1}^{V_1 V_2} \\ \downarrow \\ V_2 \end{array} \\ \begin{array}{c} \begin{array}{c} V_1 \\ \downarrow \\ \bar{\varphi}_{U_2, i_2}^{V_3 U_1} \\ \downarrow \\ U_1 \end{array} \\ \begin{array}{c} U_1 \\ \leftarrow \\ U_2 \\ \leftarrow \\ U_2 \\ \leftarrow \\ U_1 \end{array} \end{array} = \sum_{\substack{U_3 \in V_2 \triangleright U_1 \\ U_2 \in V_1 \triangleright U_3 \\ i_3, i_4}} \begin{array}{c} \begin{array}{c} V_1 \\ \downarrow \\ \bar{\varphi}_{U_3, i_3}^{V_2 U_1} \\ \downarrow \\ U_1 \end{array} \\ \begin{array}{c} \begin{array}{c} V_1 \\ \downarrow \\ \bar{\varphi}_{U_2, i_4}^{V_1 U_3} \\ \downarrow \\ U_2 \end{array} \\ \begin{array}{c} U_1 \\ \leftarrow \\ U_3 \\ \leftarrow \\ U_2 \\ \leftarrow \\ U_2 \\ \leftarrow \\ U_3 \\ \leftarrow \\ U_1 \end{array} \end{array} \end{array} \quad (4.12)$$

From orthogonality conditions (4.6) and (4.11) follow the existence of complex $\triangleright F$ -symbols satisfying

$$\begin{array}{c} \begin{array}{c} V_1 \\ \downarrow \\ \bar{\varphi}_{U_2, i_4}^{V_1 U_3} \\ \downarrow \\ U_2 \end{array} \\ \begin{array}{c} U_2 \\ \leftarrow \\ U_3 \\ \leftarrow \\ U_1 \end{array} \end{array} = \sum_{\substack{V_3 \in V_1 \otimes V_2 \\ i_1, i_2}} (\triangleright F_{U_2}^{V_1 V_2 U_1})_{U_3, i_3 i_4}^{V_3, i_1 i_2} \begin{array}{c} \begin{array}{c} V_1 \\ \downarrow \\ \bar{\varphi}_{U_2, i_2}^{V_3 U_1} \\ \downarrow \\ U_2 \end{array} \\ \begin{array}{c} U_2 \\ \leftarrow \\ U_1 \end{array} \end{array}, \quad (4.13)$$

where

$$(\triangleright F_{U_2}^{V_1 V_2 U_1})_{U_3, i_3 i_4}^{V_3, i_1 i_2} \delta_{U_2, U_4} \mathbb{1}_{M_{U_2}} = \begin{array}{c} \begin{array}{c} V_1 \\ \downarrow \\ \bar{\varphi}_{V_3, i_1}^{V_1 V_2} \\ \downarrow \\ V_2 \end{array} \\ \begin{array}{c} \begin{array}{c} V_1 \\ \downarrow \\ \bar{\varphi}_{U_3, i_4}^{V_2 U_1} \\ \downarrow \\ U_3 \end{array} \\ \begin{array}{c} U_2 \\ \leftarrow \\ U_3 \\ \leftarrow \\ U_1 \\ \leftarrow \\ U_4 \end{array} \end{array} \end{array} \quad (4.14)$$

Explicitly, the complex $\triangleright F$ -symbols evaluate to

$$(\triangleright F_{U_2}^{V_1 V_2 U_1})_{U_3, i_3 i_4}^{V_3, i_1 i_2} = \frac{1}{\dim_{\mathbb{C}} U_2} \sum_{\substack{d_1, d_2, d_3 \\ b_1, b_2, b_3}} \overline{\begin{bmatrix} V_2 & U_1 & U_3 \\ d_2 & b_1 & b_3 \end{bmatrix}}_{i_3} \overline{\begin{bmatrix} V_1 & U_3 & U_2 \\ d_1 & b_3 & b_2 \end{bmatrix}}_{i_4} \begin{bmatrix} V_1 & V_2 & V_3 \\ d_1 & d_2 & d_3 \end{bmatrix}_{i_1} \begin{bmatrix} V_3 & U_1 & U_2 \\ d_3 & b_1 & b_2 \end{bmatrix}_{i_2}, \quad (4.15)$$

where we introduced the Clebsch–Gordan coefficients associated with the action bifunctor $\triangleright : \text{Rep}(G) \times \text{Rep}^\beta(H) \rightarrow \text{Rep}^\beta(H)$. Now, consider the actions of three symmetry lines. Instead of successively acting with the three lines, one can instead fuse the first two, fuse the resulting line with the third one, before acting with the resulting line. Using eq. (4.7) and eq. (4.13), one can relate the resulting combinations of lines in two different ways, which requires the mixed Biedenharn–Elliott identity

$$\begin{aligned} & \sum_{i_7=1}^{N_{U_2}^{V_5 U_3}} (\triangleright F_{U_2}^{V_1 V_2 U_3})_{U_4, i_5 i_6}^{V_5, i_1 i_7} (\triangleright F_{U_2}^{V_5 V_3 U_1})_{U_3, i_2 i_7}^{V_3, i_2 i_3} \\ &= \sum_{V_6 \in V_2 \otimes V_3} \sum_{i_8=1}^{N_{V_6}^{V_2 V_3}} \sum_{i_9=1}^{N_{V_4}^{V_1 V_6}} \sum_{i_{10}=1}^{N_{U_4}^{V_6 U_1}} (\triangleright F_{U_4}^{V_2 V_3 U_1})_{U_3, i_4 i_5}^{V_6, i_8 i_{10}} (\triangleright F_{U_2}^{V_1 V_6 U_1})_{U_4, i_{10} i_6}^{V_4, i_9 i_3} (F_{V_4}^{V_1 V_2 V_3})_{V_6, i_8 i_9}^{V_5, i_1 i_2} \end{aligned} \quad (4.16)$$

to hold, for every $V_1, \dots, V_5 \in \text{Irr}(\text{Rep}(G))$, $U_1, \dots, U_4 \in \text{Rep}^\beta(H)$, $i_1 \in \{1, \dots, N_{V_5}^{V_1 V_2}\}$ and multiplicity labels i_1, \dots, i_6 . This identity guarantees that the pentagon axiom of the module associator of $\text{Rep}^\beta(H)$ is satisfied.

Above, we constructed a representative of the $\text{Rep}(G)$ -symmetric gapped phase associated with the $\text{Rep}(G)$ -module category $\text{Rep}^\beta(H)$ such that the set of vacua is in one-to-one correspondence with $\text{Irr}(\text{Rep}^\beta(H))$. Pick a simple object $U \in \text{Irr}(\text{Rep}^\beta(H))$. Recall that the internal hom $\underline{\text{Hom}}(U, U) \in \text{Rep}(G)$ is such that we have an isomorphism $\text{Hom}_{\text{Rep}^\beta(H)}(X \triangleright U, U) \cong \text{Hom}_{\text{Rep}(G)}(X, \underline{\text{Hom}}(U, U))$ that is natural in X , for every $X \in \text{Rep}(G)$ (see app. A). By Frobenius reciprocity,

$$\begin{aligned} \text{Hom}_{\text{Rep}^\beta(H)}(X \triangleright U, U) &= \text{Hom}_{\text{Rep}^\beta(H)}(\text{Res}_H^G(X) \otimes U, U) \\ &\cong \text{Hom}_{\text{Rep}^\beta(H)}(\text{Res}_H^G(X), \text{End}_{\mathbb{C}}(U)) \cong \text{Hom}_{\text{Rep}(G)}(X, \text{Ind}_H^G(\text{End}_{\mathbb{C}}(U))), \end{aligned} \quad (4.17)$$

for every $X \in \text{Rep}(G)$. An application of the *Yoneda lemma* yields $\underline{\text{Hom}}(U, U) \cong \text{Ind}_H^G(\text{End}_{\mathbb{C}}(U))$. The $\text{Rep}(G)$ -module structure of $\text{Rep}^\beta(H)$ endows $\underline{\text{Hom}}(U, U)$ with the structure of an algebra in $\text{Rep}(G)$ (see app. A). One can further verify that $\underline{\text{Hom}}(U, U)$ is isomorphic to the algebra object $A(H, \beta, U)$ one constructed in sec. 2.4. Finally, one recovers the $\text{Rep}(G)$ -module category $\text{Rep}^\beta(H)$ as $\text{Mod}_{\text{Rep}(G)}(A(H, \beta, U))$ (see app. A). In particular, this implies that for any two $U_1, U_2 \in \text{Irr}(\text{Rep}^\beta(H))$, the algebras $A(H, \beta, U_1)$ and $A(H, \beta, U_2)$ are Morita equivalent.

Physically, the internal hom $\underline{\text{Hom}}(U, U)$ is the algebra of lines that is preserved in the ground state labelled by $U \in \text{Irr}(\text{Rep}^\beta(H))$. By definition, the algebra $\underline{\text{Hom}}(U, U)$ is constituted of lines $X \in \text{Irr}(\text{Rep}(G))$ for which the hom-space $\text{Hom}_{\text{Rep}^\beta(H)}(X \triangleright U, U)$ is non-trivial. Therefore, we say that a symmetry line is preserved in the ground state labelled by $U \in \text{Irr}(\text{Rep}^\beta(H))$ if acting with it on the ground state results in a state with non-zero overlap. We often find a stronger condition in the literature, namely that the resulting state is proportional to the initial one. This stronger condition typically ensures that the preserved lines are closed under the tensor product, in such a way that they may form a fusion subcategory. As we already commented in sec. 2.3, this does not accurately capture spontaneous breaking of invertible or non-invertible symmetries. Indeed, the amount of symmetry preserved in the ground state labelled by any $U \in \text{Irr}(\text{Rep}^\beta(H))$ is captured by an algebra object, namely $\underline{\text{Hom}}(U, U) \cong A(H, \beta, U)$ in $\text{Rep}(G)$. Embracing this viewpoint is crucial for two reasons: (i) This guarantees that algebras of preserved lines in any two ground states are Morita equivalent, i.e., they preserve equivalent amounts of symmetry. (ii) This is required to ensure that we are not excluding any order parameters (see sec. 4.5).

At this point, it is interesting to observe that for distinct $U_1, U_2 \in \text{Irr}(\text{Rep}^\beta(H))$, the algebra objects $A(H, \beta, U_1)$ and $A(H, \beta, U_2)$ —though Morita equivalent—may be drastically different, e.g., whenever U_1 and U_2 do not share the same dimension. Let us study an example. Let $G = \mathbb{A}_4$ be the alternating group of order 12 explored in sec. 3.5. Consider the gapped phase associated with the $\text{Rep}(\mathbb{A}_4)$ -module category provided by $\text{Rep}(\mathbb{A}_4)$ itself. Algebras of preserved lines in the ground states labelled by the one-dimensional irreducible representation $\mathbb{C}_1, \mathbb{C}_\omega$ and $\mathbb{C}_{\bar{\omega}}$ are all trivial, while that in the ground state labelled by the three-dimensional representation V_3 is given by $A(\mathbb{A}_4, 1, V_3) \cong \text{End}_{\mathbb{C}}(V_3)$, which decomposes as $\mathbb{C}_1 \oplus \mathbb{C}_\omega \oplus \mathbb{C}_{\bar{\omega}} \oplus 2 \cdot V_3$. Therefore, in spite of the symmetry $\text{Rep}(G)$ being spontaneously broken, some symmetry is preserved in the ground state labelled by V_3 , which translates into more entanglement [LDV24]. In that regard, the various ground states are not on equal footing [BBPSN23, LDV24, CBNM25]. Were we to only include lines that strictly preserve the ground state labelled by V_3 —i.e., those labelled by the one-dimensional irreducible representations—we would obtain an algebra that is not Morita equivalent to the trivial one, which would ultimately lead to contradictions as we must still be able to reconstruct the whole gapped phase from any ground state. To further illustrate our remarks, let us also consider the gapped phase associated with the $\text{Rep}(\mathbb{A}_4)$ -module category $\text{Rep}(\mathbb{Z}_3)$. The algebra of lines that is preserved in the ground state labelled

by $\mathbb{C}_{1/\omega/\bar{\omega}} \in \text{Irr}(\text{Rep}(\mathbb{Z}_3))$ is provided by $A(\mathbb{Z}_3, 1, \mathbb{C}_{1/\omega/\bar{\omega}}) \cong \text{Ind}_{\mathbb{Z}_3}^{A_4}(\mathbb{C}_1) \cong \mathbb{C}_1 \oplus V_3$. Clearly, this collection of lines is not closed under the tensor product of $\text{Rep}(A_4)$, but they do form an algebra, as required.

4.3 Renormalisation group fixed points

Let H be a subgroup of G and β a normalised representative of a cohomology class in $H^2(H, \mathbb{U}(1))$. Suppose we want to construct the ground state subspace at some renormalisation group fixed point of the $\text{Rep}(G)$ -symmetric gapped phase labelled by the $\text{Rep}(G)$ -module category $\text{Rep}^\beta(H)$. Above, we commented that $\text{Rep}^\beta(H)$ is equivalent to the category $\text{Mod}_{\text{Rep}(G)}(A(H, \beta, U))$ of right modules in $\text{Rep}(G)$ over the algebra object $A(H, \beta, U)$, for any $U \in \text{Irr}(\text{Rep}^\beta(H))$. We could exploit this equivalence in order to build renormalisation group fixed points, but, as in our treatment of the symmetry Vec_G , this would not be compatible with the choice of microscopic Hilbert space we made in sec. 4.1.²² Indeed, recall that our microscopic Hilbert space requires a choice of object in Vec_G . Here, Vec_G is realised as the Morita dual $(\text{Rep}(G))_{\text{Vec}}^*$ of $\text{Rep}(G)$ with respect to Vec . From this Morita equivalence follows that $\text{Rep}^\beta(H)$ can also be realised as the category of left modules in Vec over an indecomposable (finite separable) algebra object in Vec_G . A suitable choice is provided by the algebra object $A[H, \beta]$, which also possesses the structure of a Δ -separable symmetric Frobenius algebra. Recall that $A[H, \beta]$ is the algebra object with underlying object $\bigoplus_{h \in H} \mathbb{C}_h$ whose algebraic structure is provided by the twisted group algebra $\mathbb{C}[H]^\beta = \mathbb{C}\{e_h\}_{h \in H}$ such that $|e_h| = h \in G$ and $e_{h_1} \cdot e_{h_2} = \beta(h_1, h_2) e_{h_1 h_2}$, for every $h, h_1, h_2 \in G$. Indeed, we already know that $\text{Rep}^\beta(H) \simeq \text{Mod}(\mathbb{C}[H]^\beta)$.

Let us exploit the equivalence $\text{Mod}(\mathbb{C}[H]^\beta) \simeq \text{Rep}^\beta(H)$ to construct the ground state subspace at a renormalisation group fixed point associated with the $\text{Rep}(G)$ -module category $\text{Rep}^\beta(H)$. As in sec. 2.4, our conventions dictate that rather than the Δ -separable symmetric Frobenius algebra $A[H, \beta]$, one should consider $A[H, \beta]^{*, \text{op}, \text{cop}} = \mathbb{C}\{e^h\}_{h \in H}$ such that $|e^h| = h^{-1}$,²³ for every $h \in H$, and exploit the fact that every left module over $A[H, \beta]$ is also a left comodule over $A[H, \beta]^{*, \text{op}, \text{cop}}$. Therefore, we take ground states to span a subspace of the tensor product space $\bigotimes_{i \in \Lambda} A[H, \beta]_{\{i\}}^*$, which may itself be the subspace of a larger microscopic Hilbert space. The action of topological lines in $\text{Rep}(G)$ on $\bigotimes_{i \in \Lambda} A[H, \beta]_{\{i\}}^*$ is provided by the G -graded structure of $A[H, \beta]^* = \mathbb{C}\{e^h\}_{h \in G}$ via definition (4.3) of the MPO tensors. Concretely, given $V \in \text{Rep}(G)$ with $\rho : \mathbb{C}[G] \rightarrow \text{End}_{\mathbb{C}}(V)$, recall from eq. (4.3) that the MPO tensor actually depends on the inverse of the grading of the basis element in the G -graded vector space $K = \bigoplus_{g \in G} K_g$. Since $|e^h| = h^{-1} \in H$, for every $h \in H$, the MPO reads

$$\sum_{h_1, \dots, h_{|\Lambda|} \in H} \text{tr}_V [\rho(h_1) \rho(h_2) \cdots \rho(h_{|\Lambda|})] e^{h_1} \otimes \cdots \otimes e^{h_{|\Lambda|}} \otimes e_{h_1} \otimes \cdots \otimes e_{h_{|\Lambda|}}. \quad (4.18)$$

Let $U = \mathbb{C}\{u_b\}_{b=1, \dots, \dim_{\mathbb{C}} U}$ be a simple object in $\text{Mod}(\mathbb{C}[H]^\beta)$ with algebra homomorphism $\pi : \mathbb{C}[H]^\beta \rightarrow$

²²The realisation of the symmetry $\text{Rep}(G)$ alluded to here differs drastically from the one considered in this manuscript, as the microscopic Hilbert space is typically not a tensor product space.

²³The evaluation pairing $A[H, \beta]^* \otimes A[H, \beta] \rightarrow \mathbb{C}, e^h \otimes e_h \mapsto e^h(e_h) = 1$ being a linear map in Vec_G of degree the identity in H , it requires $|e^h| = h^{-1} \in H$.

$\text{End}_{\mathbb{C}}(U)$. For every $b_1, b_2 \in \{1, \dots, \dim_{\mathbb{C}} U\}$, one defines an algebra element²⁴

$$\pi_{b_2}^{b_1} := \sum_{h \in H} \pi(h)_{b_2}^{b_1} e^h \in A[H, \beta]^*. \quad (4.19)$$

Assuming closed periodic boundary conditions, one associates to this collection of algebra elements the following injective MPS in $\bigotimes_{i \in \Lambda} A[H, \beta]_{\{i\}}^*$:

$$\begin{aligned} \Psi(\pi) &:= \sum_{b_1, \dots, b_{|\Lambda|}} \pi_{b_2}^{b_1} \otimes \pi_{b_3}^{b_2} \otimes \dots \otimes \pi_{b_{|\Lambda|}}^{b_{|\Lambda|-1}} \\ &= \sum_{h_1, \dots, h_{|\Lambda|}} \text{tr}_U [\pi(h_1) \pi(h_2) \dots \pi(h_{|\Lambda|})] e^{h_1} \otimes e^{h_2} \otimes \dots \otimes e^{h_{|\Lambda|}}. \end{aligned} \quad (4.20)$$

Acting with the topological line $V \in \text{Irr}(\text{Rep}(G))$ with $\rho: \mathbb{C}[G] \rightarrow \text{End}_{\mathbb{C}}(V)$ on the MPS $\Psi(\pi_1)$ with $\pi_1: \mathbb{C}[H]^\beta \rightarrow \text{End}_{\mathbb{C}}(U_1)$ results in $\sum_{U_2 \in V \triangleright U_1} N_{U_2}^{V U_1} \Psi(\pi_2)$, where we are using the fact that

$$\rho(h)_{d_2}^{d_1} \pi_1(h)_{b_2}^{b_1} = \sum_{\substack{U_2 \in V \triangleright U_1 \\ 1 \leq i \leq N_{U_2}^{V U_1}}} \sum_{b_3, b_4=1}^{\dim_{\mathbb{C}} U_2} \begin{bmatrix} V & U_1 & U_2 \\ d_1 & b_1 & b_3 \end{bmatrix}_i \pi_2(h)_{b_4}^{b_3} \overline{\begin{bmatrix} V & U_1 & U_2 \\ d_2 & b_2 & b_4 \end{bmatrix}_i}, \quad (4.21)$$

for every $h \in H$, $b_1, b_2 \in \{1, \dots, \dim_{\mathbb{C}} U\}$ and $d_1, d_2 \in \{1, \dots, \dim_{\mathbb{C}} V\}$. As expected, the topological line $V \in \text{Irr}(\text{Rep}(G))$ acts on the ground state subspace according to $\text{Res}_H^G(V) \otimes -$, thereby confirming that the $\text{Rep}(G)$ -symmetric block-injective MPS furnished by all the irreducible representations in $\text{Mod}(\mathbb{C}[H]^\beta)$ defines a renormalisation group fixed point associated with the gapped phase $\text{Rep}^\beta(H)$. In this scenario, it is especially easy to build gapped parent Hamiltonians in terms of G -grading preserving linear maps $e^{h_1} \otimes e^{h_2} \mapsto \frac{1}{|H|} \sum_{y \in H} \frac{\beta(y, y^{-1} h_2)}{\beta(h_1, y)} e^{h_1 y} \otimes e^{y^{-1} h_2}$. As a matter of fact, this map is built from the multiplication and the comultiplication of the Δ -separable symmetric Frobenius algebra $A[H, \beta]^{*, \text{op}, \text{cop}}$. The resulting local operators are projectors thanks to separability, and commute with one another thanks to the Frobenius property [Ina21].

4.4 String operators

We work within the framework of sec. 4.1, whereby the microscopic Hilbert space is of the form $\mathcal{H}_\Lambda = \bigotimes_{i \in \Lambda} K_{\{i\}}$, where $K = \bigoplus_{g \in G} K_g = \mathbb{C}\{k_r\}_{r=1, \dots, \dim_{\mathbb{C}} K}$ is an object in Vec_G , so that the action of the topological line $V \in \text{Irr}(\text{Rep}(G))$ on \mathcal{H}_Λ is given by the MPO (4.2). Given a symmetry Vec_G , we explained in sec. 3.1 that twisted sector local operators furnish representations of the tube algebra $\text{Tube}(\text{Vec}_G)$, whose category $\text{Mod}(\text{Tube}(\text{Vec}_G))$ is equivalent to the Drinfel'd centre $\mathcal{Z}(\text{Vec}_G)$ of Vec_G . More generally, given a non-invertible symmetry encoded in a fusion category \mathcal{C} , every multiplet of twisted sector local operators corresponds to an object in the Drinfel'd centre $\mathcal{Z}(\mathcal{C})$ of \mathcal{C} , which can be realised as $\text{Mod}(\text{Tube}(\mathcal{C}))$. It follows from Vec_G and $\text{Rep}(G)$ being Morita equivalent that $\mathcal{Z}(\text{Vec}_G) \simeq$

²⁴Let us spell out these manipulations in some detail. Given that the multiplication of $A[H, \beta] = \mathbb{C}\{e_h\}_{h \in H}$ is provided by $e_{h_1} \cdot e_{h_2} = \beta(h_1, h_2) e_{h_1 h_2}$, for every $h_1, h_2 \in H$, the comultiplication that makes $A[H, \beta]$ a Δ -separable symmetric Frobenius algebra is given by $\Delta(e_h) = |H|^{-1} \sum_{y \in H} \beta(y, y^{-1} h)^{-1} e_y \otimes e_{y^{-1} h}$. By definition of the dual, the comultiplication of $A[H, \beta]^* = \mathbb{C}\{e^h\}_{h \in H}$ is defined via the multiplication of $A[H, \beta]$. After renormalisation, it reads $\Delta^*(e^h) = |H|^{-1} \sum_{y \in H} \beta(y, y^{-1} g) e^y \otimes e^{y^{-1} h}$. The coopposite comultiplication is then given by $\Delta^{*, \text{cop}}(e^h) = |H|^{-1} \sum_{y \in H} \beta(y, y^{-1} g) e^{y^{-1} h} \otimes e^y$. The compatible multiplication rule, which is the opposite of that $A[H, \beta]^*$, is then provided by $e^{h_1} \cdot e^{h_2} = \beta(h_2, h_1)^{-1} e^{h_2 h_1}$. Now, given $U = \mathbb{C}\{u_b\} \in \text{Mod}(A[H, \beta])$, one can verify that $u_{b_2} \mapsto \sum_{h \in H} e^h \otimes e_h \cdot u_{b_2} = \sum_{h \in H} \sum_{b_1} \pi(h)_{b_2}^{b_1} e^h \otimes u_{b_1} \equiv \sum_{b_1} \pi_{b_2}^{b_1} \otimes u_{b_1}$ equips U with the structure of a left comodule over $A[H, \beta]^{*, \text{op}, \text{cop}}$.

$\mathcal{Z}(\text{Rep}(G))$ (see app. A). In sec. 3.1, we further exploited the fact that $\mathcal{Z}(\text{Vec}_G) \simeq \text{Vec}_G^G$. Therefore, we also have $\mathcal{Z}(\text{Rep}(G)) \simeq \text{Vec}_G^G$. As a matter of fact, the equivalence $\mathcal{Z}(\text{Vec}_G) \simeq \mathcal{Z}(\text{Rep}(G))$ naturally factors through Vec_G^G (see app. B).

For every a simple object in Vec_G^G , let us construct multiplets of twisted sector local operators for the symmetry $\text{Rep}(G)$. As in sec. 3.1. given $[x_0] \in \text{Cl}(G)$ and $\hat{W} \in \text{Irr}(\text{Mod}(\mathbb{C}[Z_G(x_0)]))$, we denote the corresponding simple object in Vec_G^G by $([x_0], \hat{W})$. Recall that, as an object in Vec_G , the simple object $([x_0], \hat{W})$ is isomorphic to $W = \bigoplus_{x \in [x_0]} W_x$ with $W_x \cong \hat{W}$, for every $x \in [x_0]$. On the other hand, as an object in $\text{Rep}(G)$, it is isomorphic to the induced representation $W = \text{Ind}_{Z_G(x_0)}^G(\hat{W}) = \mathbb{C}\{\varpi_{x,w_c}\}_{x \in [x_0], c=1, \dots, \dim_{\mathbb{C}} \hat{W}}$ such that $|\varpi_{x,w_c}| = x \in G$ (see sec. 3.1). Let $\psi_K^{WK} : W \otimes K \rightarrow K$ be a choice of G -grading preserving map. For every $w \in W$, the embedding of $\psi_K^{WK}(w \otimes -) \in \text{End}_{\mathbb{C}}(T)$ in \mathcal{A}_Λ is a local operator. In particular, suppose $w = \varpi_{x,w_c}$, then $\psi_K^{WK}(\varpi_{x,w_c} \otimes -)(T_g) \subseteq T_{gx}$. In general, $W = \text{Ind}_{Z_G(x_0)}^G(\hat{W})$ is not a simple object in $\text{Rep}(G)$. Let $S = \mathbb{C}\{s_f\}_{f=1, \dots, \dim_{\mathbb{C}} S} \in \text{Irr}(\text{Rep}(G))$ be a direct summand of W with multiplicity $N_S^W \in \mathbb{N}$. Given $f \in \{1, \dots, \dim_{\mathbb{C}} S\}$, note that the basis vector s_f is typically not homogeneous. For every $i \in \{1, \dots, N_S^W\}$, let $\varphi_{S,i}^W : W \rightarrow S$ be a choice of basis vector in $\text{Hom}_G(W, S)$. For every $S \in \text{Irr}(\text{Rep}(G))$ and $j \in \{1, \dots, N_S^W\}$, one defines a tensor

$$\begin{array}{c} \uparrow \\ \textcircled{j} \xrightarrow{S} \\ \downarrow \end{array} \equiv \psi_K^{WK} \begin{array}{c} \uparrow \\ \textcircled{W} \xrightarrow{S} \\ \downarrow \\ \varphi_{S,j}^W \end{array} \equiv \sum_{f=1}^{\dim_{\mathbb{C}} S} \psi_K^{WK}(\bar{\varphi}_{S,j}^W(s_f) \otimes -) \otimes s^f, \quad (4.22)$$

where

$$\begin{array}{c} \textcircled{W} \xrightarrow{S} \\ \varphi_{S,j}^W \end{array} \equiv \sum_{f=1}^{\dim_{\mathbb{C}} S} \bar{\varphi}_{S,j}^W(s_f) \otimes s^f \equiv \sum_{f=1}^{\dim_{\mathbb{C}} S} \sum_{x \in [x_0]} \sum_{c=1}^{\dim_{\mathbb{C}} \hat{W}} [W|S]_{x,c|f} \varpi_{x,w_c} \otimes s^f. \quad (4.23)$$

In eq. (4.23), we introduced a notation for the coefficients of the G -equivariant maps $\varphi_{S,i}^W$, which satisfy the orthogonality condition

$$\sum_{x \in [x_0]} \sum_{c=1}^{\dim_{\mathbb{C}} \hat{W}} \overline{[W|S_1]_{x,c|f_1}} [W|S_2]_{x,c|f_2} = \delta_{S_1, S_2} \delta_{f_1, f_2} \delta_{j_1, j_2}. \quad (4.24)$$

For every choice of G -grading preserving map ψ_K^{WK} , we claim that tensors (4.22) furnish a multiplet of twisted sector local operators associated with the simple object $([x_0], \hat{W})$ in $\text{Vec}_G^G \simeq \mathcal{Z}(\text{Rep}(G))$. Recall the symmetry $\text{Rep}(G)$ acts on twisted sector local operators via its tube algebra $\text{Tube}(\text{Rep}(G))$. Given an object in Vec_G^G , we explain in app. B.2 how to construct the corresponding object in $\mathcal{Z}(\text{Rep}(G))$, and subsequently the corresponding module in $\text{Mod}(\text{Tube}(\text{Rep}(G)))$. Our goal is to verify that tensors (4.22) transform in this module.

Within our framework, $\text{Tube}(\text{Rep}(G))$ is realised as follows: As a vector space, it is spanned by tensor networks of the form

$$\begin{array}{c} \uparrow \\ \textcircled{V} \xrightarrow{V} \\ \downarrow \\ \textcircled{S_1} \xrightarrow{S_2} \\ \downarrow \\ \textcircled{S_2} \xrightarrow{S_3} \\ \downarrow \\ \textcircled{S_3} \end{array} \equiv \left(\begin{array}{c} \uparrow \\ \textcircled{V} \xrightarrow{V} \\ \downarrow \\ \textcircled{S_3} \xrightarrow{S_2} \\ \downarrow \\ \textcircled{S_2} \xrightarrow{S_1} \\ \downarrow \\ \textcircled{S_1} \end{array} \right)^\dagger, \quad (4.25)$$

for every $V, S_1, S_2, S_3 \in \text{Irr}(\text{Rep}(G))$, $i_1 \in \{1, \dots, N_{S_2}^{V S_1}\}$ and $i_2 \in \{1, \dots, N_{S_2}^{S_3 V}\}$ such that $\text{Hom}_G(V \otimes S_1, S_2) = \mathbb{C}\{\varphi_{S_2, i_1}^{V S_1}\}_{i_1}$ and $\text{Hom}_G(S_3 \otimes V, S_2) = \mathbb{C}\{\varphi_{S_2, i_2}^{S_3 V}\}_{i_2}$. The r.h.s. of eq. (4.25) realises the $*$ -structure of $\text{Tube}(\text{Rep}(G))$. The multiplication rule of $\text{Tube}(\text{Rep}(G))$ reads

$$\begin{aligned}
& \text{Diagram 1} \cdot \text{Diagram 2} := \delta_{S_3, S_4} \text{Diagram 3} \\
& \equiv \sum_{\substack{V_3 \in V_1 \otimes V_2 \\ S_7 \in V_3 \otimes S_1}} \sum_{\substack{1 \leq i_5 \leq N_{S_7}^{V_3 S_1} \\ 1 \leq i_6 \leq N_{S_7}^{S_6 V_3}}} \Gamma_{V_3, S_7, i_5, i_6}^{V_1, V_2, S_1, \dots, S_6, i_1, \dots, i_4} \text{Diagram 4}, \tag{4.26}
\end{aligned}$$

for every $V_1, V_2, S_1, \dots, S_6 \in \text{Irr}(\text{Rep}(G))$, $i_1 \in \{1, \dots, N_{S_2}^{V_2 S_1}\}$, $i_2 \in \{1, \dots, N_{S_2}^{S_3 V_2}\}$, $i_3 \in \{1, \dots, N_{S_5}^{V_1 S_4}\}$ and $i_4 \in \{1, \dots, N_{S_5}^{S_6 V_1}\}$, where the structure constants of the algebra are given by

$$\Gamma_{V_3, S_7, i_5, i_6}^{V_1, V_2, S_1, \dots, S_6, i_1, \dots, i_4} := \delta_{S_3, S_4} \sum_{\substack{1 \leq i_7 \leq N_{S_7}^{V_1 S_2} \\ 1 \leq i_8 \leq N_{S_7}^{S_5 V_2} \\ 1 \leq i_9 \leq N_{V_3}^{V_1 V_2}}} (F_{S_7}^{V_1 S_3 V_2})_{S_2, i_2 i_7}^{S_5, i_3 i_8} (\bar{F}_{S_7}^{S_6 V_1 V_2})_{S_5, i_4 i_8}^{V_3, i_9 i_6} (\bar{F}_{S_7}^{V_1 V_2 S_1})_{S_2, i_1 i_7}^{V_3, i_9 i_5}. \tag{4.27}$$

In order to obtain eq. (4.27), we used eq. (4.5) together with eq. (4.7) and eq. (4.6).

We are now in a position to verify that twisted sector local operators (4.22) furnish simple modules over $\text{Tube}(\text{Rep}(G))$. Given $([x_0], \hat{W}) \in \text{Irr}(\text{Vec}_G^G)$, contracting the tube labelled by $V, S_1, S_2, S_3 \in \text{Irr}(\text{Rep}(G))$, $i_1 \in \{1, \dots, N_{S_2}^{V S_1}\}$ and $i_2 \in \{1, \dots, N_{S_3}^{S_3 V}\}$ with the tensor (4.22) labelled by $S_5 \in \text{Irr}(\text{Rep}(G))$ and $j_2 \in \{1, \dots, N_{S_1}^W\}$ results in

$$\begin{aligned}
& \delta_{S_1, S_5} \text{Diagram 1} = \delta_{S_1, S_5} \text{Diagram 2} \\
& \equiv \sum_{\substack{S_4 \in W \\ 1 \leq j_1 \leq N_{S_4}^W}} (\Upsilon_{S_2, i_1 i_2}^{S_1 V S_3})_{S_5, j_2}^{S_4, j_1} \text{Diagram 3}, \tag{4.28}
\end{aligned}$$

$i_4 \in \{1, \dots, N_{S_5}^{S_6 V_1}\}$, $j_1 \in \{1, \dots, N_{S_7}^W\}$ and $j_3 \in \{1, \dots, N_{S_9}^W\}$. In the first step, we used the fact that²⁵

$$\sum_{1 \leq j_2 \leq N_{S_3}^W} \text{[Diagram]} = (\dim_{\mathbb{C}} S_3) \text{[Simplified Diagram]}$$

followed by

$$\rho_1(x^{-1})_{d_2}^{d_1} \rho_2(x^{-1})_{d_4}^{d_3} = \sum_{\substack{V_3 \in V_1 \otimes V_2 \\ 1 \leq i \leq N_{V_3}^{V_1 V_2}}} \sum_{d_5, d_6=1}^{\dim_{\mathbb{C}} V_3} \begin{bmatrix} V_1 & V_2 & V_3 \\ d_1 & d_3 & d_5 \end{bmatrix}_i \rho_3(x^{-1})_{d_6}^{d_5} \overline{\begin{bmatrix} V_1 & V_2 & V_3 \\ d_2 & d_4 & d_6 \end{bmatrix}_i}. \quad (4.32)$$

Finally, invoking $\text{Mod}(\text{Tube}(\text{Rep}(G))) \simeq \mathcal{Z}(\text{Rep}(G))$, one confirms in app. B.2 that the module furnished by tensors (4.22) with underlying vector space $\bigoplus_{S \in \text{Irr}(\text{Rep}(G))} \text{Hom}_G(S, W)$ is that associated with the simple object $([x_0], \hat{W})$ in $\text{Vec}_G^G \simeq \text{Mod}(\text{Tube}(\text{Rep}(G)))$. We conclude that for every choice of G -grading preserving map $\psi_K^{W^* K} : W \otimes K \rightarrow K$, tensors (4.22), for every simple direct summand S of W and $i \in \{1, \dots, N_{S_7}^W\}$, furnish a multiplet of twisted sector local operators that transform in the irreducible module $([x_0], \hat{W})$ of $\text{Tube}(\text{Rep}(G))$. Multiplets of twisted local operators associated with any object in Vec_G^G are constructed similarly.

For every choice of G -grading preserving map $\psi_K^{K W^*} : K \otimes W^* \rightarrow K$, one can construct another collection of tensors that form the Hermitian dual of the module associated with $([x_0], \hat{W})$. Concretely, for every simple direct summand S of W and $j \in \{1, \dots, N_S^W\}$, define

$$\begin{array}{c} \uparrow \\ S \\ \circ \\ \leftarrow \\ j \end{array} \equiv \begin{array}{c} \uparrow \\ S \\ \circ \\ \leftarrow \\ W \\ \circ \\ \leftarrow \\ \psi_{S,j}^W \\ \uparrow \end{array} \equiv \sum_{x \in [x_0]} \sum_{c=1}^{\dim_{\mathbb{C}} \hat{W}} \varphi_{S,j}^W(\varpi_{x,w_c}) \otimes \psi_K^{K W^*}(- \otimes \varpi^{x,w_c}), \quad (4.33)$$

where

$$\begin{array}{c} \uparrow \\ S \\ \circ \\ \leftarrow \\ W \\ \circ \\ \leftarrow \\ \psi_{S,j}^W \\ \uparrow \end{array} \equiv \sum_{x \in [x_0]} \sum_{c=1}^{\dim_{\mathbb{C}} \hat{W}} \varphi_{S,j}^W(\varpi_{x,w_c}) \otimes \varpi^{x,w_c} \equiv \sum_{f=1}^{\dim_{\mathbb{C}} S} \sum_{x \in [x_0]} \sum_{c=1}^{\dim_{\mathbb{C}} \hat{W}} \overline{\begin{bmatrix} W & S \\ x, c & f_4 \end{bmatrix}_j} s_f \otimes \varpi^{x,w_c}. \quad (4.34)$$

Given definition (4.25) of the $*$ -structure of $\text{Tube}(\text{Rep}(G))$, the Hermitian dual of (4.28) agrees with the result of acting with the Hermitian dual of the tube on the tensor (4.33).

Let $([x_0], \hat{W})$ label a simple object in Vec_G^G and choose a simple direct summand $S \in \text{Irr}(\text{Rep}(G))$ of W . Consider twisted sector local operators of the form (4.22) and (4.33) associated with j_1 and j_2

²⁵This formula follows from thinking about the closed tensor network on the l.h.s. as a morphism in $\text{Hom}_G(\mathbb{C}, \mathbb{C})$ in such a way that the sum over $j_2 \in \{1, \dots, N_{S_3}^W\}$ amounts to resolving an identity morphism. In deriving eq. (4.31), we used this property after expressing the Υ -symbols in terms of the corresponding tensor networks, where one should think of the map $\bar{\varphi}_{S_3, j_2}^W$ depicted on the l.h.s. as a piece of the former tensor network.

in $\{1, \dots, N_S^W\}$, respectively. Placing the corresponding tensors at sites $i < j$ in Λ , we contract them via a symmetry MPO (4.2) with open boundary conditions. We denote the embedding in \mathcal{A}_Λ of the resulting tensor network operator as $\mathcal{S}(S, j_1, j_2)_{i, \dots, j}$. Graphically,

$$\mathcal{S}(S, j_1, j_2)_{i, \dots, j} \equiv \begin{array}{c} \uparrow \\ \circlearrowleft \text{---} S \text{---} \circlearrowright \\ \uparrow \end{array} \cdots \begin{array}{c} \uparrow \\ \circlearrowleft \text{---} S \text{---} \circlearrowright \\ \uparrow \end{array} \begin{array}{c} \uparrow \\ \circlearrowleft \text{---} j_2 \\ \uparrow \end{array} . \quad (4.35)$$

These are the string operators for $\text{Rep}(G)$ -symmetric gapped phases.

Let us examine some special cases. Given $[x_0] \in \text{Cl}(G)$, choose $\hat{W} = \mathbb{C}$. Recall that as an object in Vec_G , $([x_0], \mathbb{C})$ is isomorphic to $W = \bigoplus_{x \in [x_0]} \mathbb{C}$. On the other hand, as an object in $\text{Rep}(G)$, it is isomorphic to the induced representation $\text{Ind}_{Z_G(x_0)}^G(\mathbb{C}) \cong \mathbb{C}(G/Z_G(x_0)) = \mathbb{C}\{\varpi_x\}_{x \in [x_0]}$ such that $|\varpi_x| = x \in G$, for every $x \in [x_0]$. By Frobenius reciprocity, the trivial representation \mathbb{C} is always a direct summand of $\mathbb{C}(G/Z_G(x_0))$ such that $N_{\mathbb{C}}^{\mathbb{C}(G/Z_G(x_0))} = 1$. Choose $S = \mathbb{C}$. By definition, $\bar{\varphi}_{\mathbb{C}}^{\mathbb{C}(G/Z_G(x_0))}(1) = \sum_{x \in [x_0]} \varpi_x$. Suppose that $\mathcal{H}_\Lambda = \bigotimes_{i \in \Lambda} \mathbb{C}[G]^*$, where $\mathbb{C}[G]^* = \bigoplus_{g \in G} \mathbb{C}_{g^{-1}} = \mathbb{C}\{e^g\}_{g \in G} \in \text{Vec}_G$. Consider the multiplet of local operators defined via the G -grading preserving map

$$\psi_{\mathbb{C}[G]^*}^{W\mathbb{C}[G]^*} : W \otimes \mathbb{C}[G]^* \rightarrow \mathbb{C}[G]^* \quad (4.36)$$

$$\varpi_x \otimes e^g \mapsto e^{gx^{-1}} .$$

It follows that the local operator labelled by $S = \mathbb{C}$ acts by right translation as

$$R^{[x_0]} \equiv \sum_{x \in [x_0]} R^x := \sum_{x \in [x_0]} \sum_{g \in G} e^{gx^{-1}} \otimes e_g . \quad (4.37)$$

Similarly, $\psi_{\mathbb{C}[G]^*}^{\mathbb{C}[G]^*W^*} : e^g \otimes \varpi^x \mapsto e^{xg}$ would yield $L^{[x_0]} \equiv \sum_{x \in [x_0]} L^x := \sum_{x \in [x_0]} \sum_{g \in G} e^{xg} \otimes e_g$. The remaining operators in the multiplet, which are twisted sector local operators, are constructed analogously.

For instance, choose $G = \mathbb{A}_4$, and consider the simple object $([(12)(34)], \mathbb{C}_{(1,1)})$. As an object in $\text{Vec}_{\mathbb{A}_4}$, it is isomorphic to $\bigoplus_{x \in [(12)(34)]} \mathbb{C}_{(1,1)}$; as an object in $\text{Rep}(\mathbb{A}_4)$, it is isomorphic to $W = \text{Ind}_{\mathbb{Z}_2 \oplus \mathbb{Z}_2}^{\mathbb{A}_4}(\mathbb{C}_{(1,1)}) \cong \mathbb{C}_1 \oplus \mathbb{C}_\omega \oplus \mathbb{C}_{\bar{\omega}}$. Choose $S = \mathbb{C}_\omega$. By definition, $\bar{\varphi}_{\mathbb{C}_\omega}^W(1) = \varpi_{(12)(34)} + \omega \varpi_{(13)(24)} + \bar{\omega} \varpi_{(14)(23)}$. One can now construct the corresponding twisted sector local operator in the multiplet associated with the map (4.36), and ultimately the string operator. Since $S = \mathbb{C}_\omega$ is a one-dimensional irreducible representation, it remains possible to write down the result very explicitly, namely²⁶

$$\mathcal{S}(\mathbb{C}_\omega, 1, 1)_{i, \dots, j} = R_i^{[x_0], \omega} \left(\prod_{k=i+1}^{j-1} \chi_k^\omega \right) L_j^{[x_0], \omega} , \quad (4.38)$$

where $\chi^\omega := \sum_{g \in G} \chi^\omega(g) e^g \otimes e_g$, $R^{[x_0], \omega} := R^{(12)(34)} + \omega R^{(13)(24)} + \bar{\omega} R^{(14)(23)}$ and $L^{[x_0], \omega} := L^{(12)(34)} + \bar{\omega} L^{(13)(24)} + \omega L^{(14)(23)}$.

Let us now study a different type of multiplet. Still choosing $G = \mathbb{A}_4$, consider the simple objects $([()], V_3)$ and $([(12)(34)], \mathbb{C}_{(1,-1)})$ in $\text{Vec}_{\mathbb{A}_4}^{\mathbb{A}_4}$. Since $\text{Ind}_{\mathbb{Z}_2 \oplus \mathbb{Z}_2}^{\mathbb{A}_4}(\mathbb{C}_{(1,-1)}) \cong V_3$, there is a single string operator in every multiplet associated with these simple objects. For both simple objects, the twisting line is always given by V_3 , but the twisted sector local operators do differ. Given that every basis vector in $([()], V_3)$ is homogeneous of degree the identity, the resulting string operator amounts to summing

²⁶Similar operators appeared for instance in ref. [BBSNT24].

the symmetry MPO labelled by V_3 over all possible basis open boundary conditions. In contrast, basis vectors in the \mathbb{A}_4 -equivariant \mathbb{A}_4 -graded vector space $([(12)(34)], \mathbb{C}_{(1,-1)})$ are homogeneous of degrees (12)(34), (13)(24) and (14)(23), respectively. Let $\mathbb{C}_{(1,-1)} = \mathbb{C}\{w_1\}$, $W = \text{Ind}_{\mathbb{Z}_2 \oplus \mathbb{Z}_2}^{\mathbb{A}_4}(\mathbb{C}_{(1,-1)}) = \mathbb{C}\{\varpi_{x,w_1}\}_{x \in [(12)(34)]}$ and $V_3 = \mathbb{C}\{s_1, s_2, s_3\}$ be the basis given in eq. (3.68). It follows that the G -equivariant map $\bar{\varphi}_{V_3}^W: V_3 \rightarrow W$ is taken to act as $s_1 \mapsto \varpi_{(12)(34),w_1}$, $s_2 \mapsto \varpi_{(13)(24),w_1}$ and $s_3 \mapsto \varpi_{(14)(23),w_1}$. Given that $|\varpi_{x,w_1}| = x \in \mathbb{A}_4$, for every $x \in [(12)(34)]$, the twisted sector local operator on $\mathbb{C}[A_4]^*$ defined via eq. (4.36) reads

$$\begin{array}{c} \uparrow \\ \textcircled{1} \\ \uparrow \end{array} \xrightarrow{V_3} = R^{(12)(34)} \otimes s^1 + R^{(13)(24)} \otimes s^2 + R^{(14)(23)} \otimes s^3. \quad (4.39)$$

Finally, the string operator is obtained applying the construction depicted in eq. (4.35).

4.5 Order parameters

Given a $\text{Rep}(G)$ -symmetric gapped phase, we now would like to identify string operators that may serve as *order parameters* in the ground state subspace. As in the invertible case we are asking for necessary conditions that the corresponding multiplets of twisted sector local operators must satisfy in order for the string operators to acquire a non-vanishing expectation value in at least one state in the ground state subspace. Though more technical, the derivation mimics that of sec. 3.2. As a matter of fact the conclusion is the same, namely that suitable irreducible multiplets of twisted sector local order parameters must furnish a direct summand of a Lagrangian algebra in $\mathcal{Z}(\text{Rep}(G))$. In particular, by virtue of $\mathcal{Z}(\text{Rep}(G)) \simeq \text{Vec}_G^G \simeq \mathcal{Z}(\text{Vec}_G)$, which follows from the Morita equivalence between $\text{Rep}(G)$ and Vec_G , we have already computed in sec. 3.3 these Lagrangian algebras.

Consider a representative of the gapped phase associated with the indecomposable $\text{Rep}(G)$ -module category $\text{Rep}^\beta(H)$. Recall that ground states in the ground state subspace preserve algebra objects of topological lines that are two-by-two Morita equivalent. Specifically, the ground state labelled by $U \in \text{Irr}(\text{Rep}^\beta(U))$ preserves the internal hom $\underline{\text{Hom}}(U, U) \cong A(H, U, \beta)$ in $\text{Rep}(G)$. Our goal is to demonstrate that in order for a string operator to serve as an order parameter, its constitutive irreducible multiplet of twisted sector local operators must furnish a direct summand of the Lagrangian algebra $L(H, \beta)$.

In order to appreciate most of the technical subtleties that are specific to a non-invertible symmetry, it is enough to focus on the $\text{Rep}(G)$ -symmetric gapped phase associated with $\text{Rep}^\beta(G)$. Given a simple object $([x_0], \hat{W})$ in Vec_G^G , consider the string operator $\mathcal{S}(S, j_1, j_2)_{i, \dots, j}$ constructed in eq. (4.35), for $S \in \text{Irr}(\text{Rep}(G))$ a direct summand of $W = \text{Ind}_{\mathbb{Z}_G(x_0)}^G(\hat{W})$ and $j_1, j_2 \in \{1, \dots, N_S^W\}$. The expectation value of this string operator in the ground state labelled by $U \in \text{Irr}(\text{Rep}^\beta(G))$ is given by

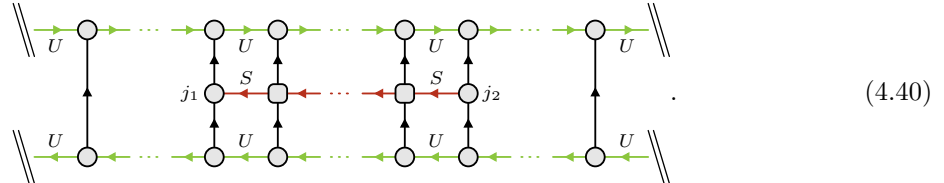

Employing eq. (4.10) followed by eq. (4.11) at every site $k \in [i+1, j-1]$ together, it follows from

eq. (2.9) that (4.40) evaluates to

$$\sum_{i=1}^{N_U^{SU}} U \cdot \left(\begin{array}{c} \text{Diagram 1} \\ \text{Diagram 2} \end{array} \right) \cdot U \quad (4.41)$$

up to terms that decay exponentially in the length of the string. As in the invertible case, one immediately obtains a preliminary constraint, namely that the simple S object must be a direct summand of the algebra object $A(H, \beta, U)$ of preserved lines in the ground state labelled by U . Focusing on the right-hand-side factor in eq. (4.41), consider the collection of tensor networks

$$\left(\begin{array}{c} \text{Diagram} \end{array} \right) \quad (4.42)$$

over $U \in \text{Irr}(\text{Rep}^\beta(G))$ and basis vector $\phi_{U,i}^{SU}$ in $\text{Hom}_{\text{Rep}^\beta(G)}(S \otimes U, U)$ labelled by $i \in \{1, \dots, N_U^{SU}\}$. Let us show that this collection furnishes a (reducible) module over $\text{Tube}(\text{Rep}(G))$. Acting with the tube (4.25) labelled by $V, S_1, S_2, S_3 \in \text{Irr}(\text{Rep}(G))$, $i_1 \in \{1, \dots, N_{S_2}^{VS_1}\}$ and $i_2 \in \{1, \dots, N_{S_3}^{S_2V}\}$ on the tensor network (4.42) labelled by $U_1 \in \text{Rep}^\beta(G)$, $S_4 \in \text{End}_{\mathbb{C}}(U_1)$ and $j_2 \in \{1, \dots, N_{U_1}^{S_4U_1}\}$ results in

$$\delta_{S_1, S_4} U_1 \cdot \left(\begin{array}{c} \text{Diagram} \end{array} \right) \cdot U_1 \quad (4.43)$$

One can simplify this tensor network by utilising eq. (4.10) together with eq. (4.11), before invoking

eq. (4.13) and its converse:

$$\begin{aligned}
& \delta_{S_1, S_4} \sum_{\substack{U_2 \in V \triangleright U_1 \\ 1 \leq j_4 \leq N_{U_2}^{V U_1}}} \text{Diagram} \\
&= \delta_{S_1, S_4} \sum_{\substack{U_2 \in V \triangleright U_1 \\ 1 \leq j_4 \leq N_{U_2}^{V U_1}}} \sum_{\substack{1 \leq j_3 \leq N_{U_2}^{S_2 U_1} \\ 1 \leq j_1 \leq N_{U_2}^{S_3 U_2}}} (\triangleright \bar{F}_{U_2}^{S_3 V U_1})_{S_2, i_2 j_3}^{U_2, j_4 j_1} (\triangleright F_{U_2}^{V S_1 U_1})_{U_1, j_2 j_4}^{S_2, i_1 j_3} \text{Diagram}
\end{aligned} \tag{4.44}$$

Using the mixed Biedenharn–Elliott identity (4.16), one can show that

$$\begin{aligned}
& \delta_{S_3, S_4} \sum_{\substack{V_3 \in V_1 \otimes V_2 \\ S_7 \in V_3 \otimes S_1}} \sum_{\substack{1 \leq i_5 \leq N_{S_7}^{V_3 S_1} \\ 1 \leq i_6 \leq N_{S_7}^{S_6 V_3}}} \sum_{\substack{U_3 \in V_3 \triangleright U_1 \\ 1 \leq j_9 \leq N_{U_2}^{V_3 U_1}}} \sum_{\substack{1 \leq j_8 \leq N_{U_3}^{S_2 U_1} \\ 1 \leq j_1 \leq N_{U_3}^{S_3 U_3}}} (\triangleright \bar{F}_{U_3}^{S_6 V_3 U_1})_{S_7, i_6 j_8}^{U_3, j_9 j_1} (\triangleright F_{U_3}^{V_3 S_1 U_1})_{U_1, j_3 j_9}^{S_7, i_5 j_8} \\
&= \delta_{S_3, S_4} \sum_{\substack{U_2 \in V_2 \triangleright U_1 \\ 1 \leq j_5 \leq N_{U_2}^{V_2 U_1}}} \sum_{\substack{1 \leq j_4 \leq N_{U_2}^{S_2 U_1} \\ 1 \leq j_2 \leq N_{U_2}^{S_3 U_2}}} \sum_{\substack{U_3 \in V_1 \triangleright U_2 \\ 1 \leq j_7 \leq N_{U_3}^{V_1 U_2}}} \sum_{\substack{1 \leq j_6 \leq N_{U_3}^{S_5 U_2} \\ 1 \leq j_1 \leq N_{U_3}^{S_3 U_3}}} (\triangleright \bar{F}_{U_2}^{S_3 V_2 U_1})_{S_2, i_2 j_4}^{U_2, j_5 j_1} (\triangleright F_{U_2}^{V_2 S_1 U_1})_{U_1, j_3 j_5}^{S_2, i_1 j_4} \\
&\quad \quad \quad (\triangleright \bar{F}_{U_3}^{S_6 V_1 U_2})_{S_5, i_4 j_6}^{U_3, j_7 j_2} (\triangleright F_{U_3}^{V_1 S_4 U_2})_{U_2, j_2 j_7}^{S_5, i_3 j_6},
\end{aligned} \tag{4.45}$$

for every for every $V_1, V_2, S_1, \dots, S_8 \in \text{Irr}(\text{Rep}(G))$, $i_1 \in \{1, \dots, N_{S_2}^{V_2 S_1}\}$, $i_2 \in \{1, \dots, N_{S_2}^{S_3 V_2}\}$, $i_3 \in \{1, \dots, N_{S_5}^{V_1 S_4}\}$, $i_4 \in \{1, \dots, N_{S_5}^{S_6 V_1}\}$ and $j_3 \in \{1, \dots, N_{U_1}^{S_8 U_1}\}$. This confirms that the action (4.44) does endow the space of tensor networks (4.42) with the structure of a module over $\text{Tube}(\text{Rep}(G))$. In app. B.2, one proves that this module is that associated with the Lagrangian algebra $L(G, \beta)$ under the equivalence $\text{Vec}_G^G \simeq \mathcal{Z}(\text{Rep}(G)) \simeq \text{Mod}(\text{Tube}(\text{Rep}(G)))$. As in the invertible case, this proves that in order for an irreducible multiplet of twisted sector local operators to provide string operators that may have non-vanishing expectation values in the $\text{Rep}(G)$ -symmetric gapped phases associated with the $\text{Rep}(G)$ -module category $\text{Rep}^\beta(G)$, the corresponding simple object in $\mathcal{Z}(\text{Rep}(G)) \simeq \text{Vec}_G^G$ must be a direct summand of the Lagrangian algebra $L(G, \beta)$. Conversely, by inspecting the space of twisted sector local operators yielding non-vanishing expectation values, one can reconstruct the Lagrangian algebra object. Almost as easily, one can verify that in the gapped phase associated with the $\text{Rep}(G)$ -module category $\text{Rep}^\beta(H)$, for any $H \leq G$ and $[\beta] \in H^2(H, \text{U}(1))$, irreducible multiplets of twisted sector local operators must furnish direct summands of the Lagrangian algebra $L(H, \beta)$.

A couple of physical remarks are in order. Consider the gapped phase associated with the module category $\text{Rep}(G)$ over itself. This is the gapped phase where the whole symmetry $\text{Rep}(G)$ is spontaneously broken in the sense that the dimension of the ground state subspace equals the number of elements in $\text{Irr}(\text{Rep}(G))$. Moreover, there is a preferred vacuum—that associated with the identity object in $\text{Rep}(G)$ —such that acting on it by any simple non-trivial line in $\text{Rep}(G)$ results in an orthogonal vacuum. In that sense, this is analogous to the spontaneously symmetry broken phase

associated with an invertible symmetry. However, as we have already clarified in sec. 4.2, all the vacua are not quite on equal footing since the algebras of lines that are preserved in these ground states may be very different—in spite of being Morita equivalent. In particular, that associated with the preferred vacuum mentioned above is trivial. This implies that order parameters in this ground state are all strictly local. In contrast, ground states labelled by higher-dimensional irreducible representations of G admit genuine string operators. Mathematically, this follows from the fact that simple direct summands in the Lagrangian algebra $L(G, 1) \cong \bigoplus_{[x_0] \in \text{Cl}(G)} ([x_0], \mathbb{C})$ typically include non-trivial irreducible representations of G as objects in $\text{Rep}(G)$.²⁷

Now, suppose that the Bogomolov multiplier of G is non-trivial and let β be a normalised representative of a non-trivial class in it. By definition, for every $g_1 \in G$ and $g_2 \in Z_G(g_1)$, $\beta(g_1, g_2) = \beta(g_2, g_1)$. This implies that every conjugacy class of G is β -regular so that the number of simple objects in $\text{Rep}^\beta(G)$ equals the number of conjugacy classes of G and thus the number of simple objects in $\text{Rep}^\beta(G)$. We commented in sec. 3.3 that the corresponding Lagrangian algebra $L(G, \beta) = \bigoplus_{[x_0] \in \text{Cl}(G)} ([x_0], \mathbb{C}_{\beta_{x_0}})$ is equivalent to $L(G, 1)$ as an object in Vec_G^G , but not as an algebra. For instance, consider the renormalisation group fixed point of sec. 4.3 for the gapped phase associated with $\text{Rep}(G)$ -module category $\text{Rep}^\beta(G)$. Recall that the microscopic Hilbert space is provided by $\mathcal{H}_\Lambda = \bigotimes_{i \in \Lambda} A[G, \beta]^*$, where $A[G, \beta]^* = \mathbb{C}\{e^g\}_{g \in G}$, such that MPS tensors are provided by the left $A[G, \beta]^*$ - op, cop -comodule structure of the left $A[G, \beta]$ -modules. Consider the multiplet of twisted sector local operators furnishing $L(G, \beta)$ associated with the G -grading preserving map

$$\begin{aligned} \psi_{A[G, \beta]^*}^{L(G, \beta)A[G, \beta]^*} : L(G, \beta) \otimes A[G, \beta]^* &\rightarrow A[G, \beta]^* \\ e_{g_1} \otimes e^{g_2} &\mapsto \beta(g_2 g_1^{-1}, g_1^{-1}) e^{g_2 g_1^{-1}}. \end{aligned} \quad (4.46)$$

According to foot. 24, this map essentially implements the comultiplication rule of $A[H, \beta]^*$ - op, cop . It follows that twisted sector local operators in this multiplet fuse according to the multiplication rule of $L(G, \beta)$. Mimicking the derivations of sec. 3.3, one could show that, in the infrared, multiplets of order parameters furnishing $L(G, \beta)$ are further required to be defined in terms of such G -grading preserving maps so as to yield non-vanishing expectation values, thereby distinguishing the gapped phases $\text{Rep}(G)$ and $\text{Rep}^\beta(G)$. But a stronger statement applies here. Indeed, only in the gapped phase $\text{Rep}(G)$ does there exist a ground state in which only local operators admit a non-trivial expectation value.

4.6 Example: $\text{Rep}(\mathbb{A}_4)$

Consider the non-invertible symmetry encoded into the fusion category $\text{Rep}(\mathbb{A}_4)$ of finite-dimensional representations of the alternating group \mathbb{A}_4 of order 12 (see sec. 3.5). We focus on the two SPT phases associated with the $\text{Rep}(\mathbb{A}_4)$ -module category $\text{Rep}(\mathbb{Z}_1)$ and $\text{Rep}^\beta(\mathbb{Z}_2 \oplus \mathbb{Z}_2)$ with β the normalised representative of the non-trivial cohomology class in $H^2(\mathbb{Z}_2 \oplus \mathbb{Z}_2, \text{U}(1))$ [You25]. The relevant Lagrangian algebras $L(0, 1)$ and $L(\mathbb{Z}_2 \oplus \mathbb{Z}_2, \beta)$ were computed in sec. 3.5. By inspection, we find that the multiplets $([()], V_3)$ and $([(12)(34)], \mathbb{C}_{(1, -1)})$ of twisted sector local operators distinguish these two phases.

In sec. 4.3, we explained how to construct renormalisation group fixed points for these two phases. The input algebras are provided by $A[\mathbb{C}, 1] \cong \mathbb{C}$ and $A[\mathbb{Z}_2 \oplus \mathbb{Z}_2, \beta]^*$ - $\text{op, cop} \cong (\mathbb{C}[\mathbb{Z}_2 \oplus \mathbb{Z}_2]^\beta)^*$ - op, cop , respectively, and the MPS are given by eq. (4.20). It is convenient to embed both models into the microscopic Hilbert space $\bigotimes_{i \in \Lambda} \mathbb{C}[\mathbb{A}_4]_{\{i\}}^*$, at which point the unique string operator in any multiplet

²⁷Note that the same Lagrangian algebra $L(G, \beta)$ was associated with an SPT for the symmetry Vec_G . This duality can be traced back to the fact that $(\text{Vec}_G)_{\text{Vec}}^* \simeq \text{Rep}(G)$, which encodes the notion that gauging the symmetry Vec_G results in a theory with symmetry $\text{Rep}(G)$.

associated with $([()], V_3)$ and $([(12)(34)], \mathbb{C}_{(1,-1)})$ are of the same form as those we constructed in sec. 4.4.

First, consider the trivial SPT associated with the $\text{Rep}(\mathbb{A}_4)$ -module category $\text{Rep}(\mathbb{Z}_2) = \text{Vec}$. The unique ground state is the product state $e^{1\mathbb{A}_4} \otimes e^{1\mathbb{A}_4} \otimes \dots \otimes e^{1\mathbb{A}_4}$. In sec. 4.4, we explained that for any multiplet associated with $([()], V_3)$, the unique string operator acts diagonally in the computational basis. Furthermore, the ground state is clearly an eigenvector of the symmetry operator labelled by V_3 . Together, this guarantees that the expectation value of this string operator is non-zero. In contrast, the string operator in any multiplet associated with $([(12)(34)], \mathbb{C}_{(1,-1)})$ would have a vanishing expectation value as it would act at the endpoints by right or left translations by a non-identity group element.

Now, consider the non-trivial SPT associated with the $\text{Rep}(\mathbb{A}_4)$ -module category $\text{Rep}^\beta(\mathbb{Z}_2 \oplus \mathbb{Z}_2)$. The unique ground state in this phase can be verified to be the cluster state that we already encountered in sec. 3.4 in the context of the invertible symmetry $\text{Vec}_{\mathbb{Z}_2 \oplus \mathbb{Z}_2}$. Recall that $\text{Res}_{\mathbb{Z}_2 \oplus \mathbb{Z}_2}^{V_3}(V_3) \cong \mathbb{C}_{(1,-1)} \oplus \mathbb{C}_{(-1,1)} \oplus \mathbb{C}_{(-1,-1)}$. Up to a choice of basis, it follows that the non-invertible symmetry operator labelled by V_3 acts on the cluster state as the sum of three operators associated with the non-trivial invertible lines in $\text{Vec}_{\mathbb{Z}_2 \oplus \mathbb{Z}_2}$. Choosing the multiplet $([(12)(34)], \mathbb{C}_{(1,-1)})$ associated with the \mathbb{A}_4 -grading preserving map (4.36), it follows from eq. (4.39) that the string operator acts in the same way as the sum of the three non-trivial string operators we constructed in sec. 3.4. Therefore, the expectation value is non-vanishing.²⁸ As a matter of fact, different choices of \mathbb{A}_4 -grading preserving maps allows us to isolate each one of these string operators. For instance, one can choose $\psi_{\mathbb{C}[\mathbb{A}_4]^*}^{W\mathbb{C}[\mathbb{A}_4]^*}$, where $W = \text{Ind}_{\mathbb{Z}_2 \oplus \mathbb{Z}_2}^{\mathbb{A}_4}(\mathbb{C}_{(1,-1)})$, such that $\varpi_{(12)(34), w_1} \otimes - \mapsto R^{(12)(34)}$, and zero otherwise. The resulting string operator then coincides with eq. (3.61). The fact there are three linearly independent \mathbb{A}_4 -grading preserving maps one can choose, each reproducing one of the non-trivial string operators of the cluster state we constructed in sec. 3.4 explains the multiplicity of the simple object $([(12)(34)], \mathbb{C}_{(1,-1)})$ in the Lagrangian algebra. This shows that string order parameters can distinguish different gapped phases much more easily than by computing the corresponding $\triangleright F$ -symbols [You25].

4.7 Generalisation

For non-invertible symmetry lines furnishing the fusion category $\text{Rep}(G)$, one demonstrated in this section that in order for an irreducible multiplet of twisted sector local operators to provide string order parameters in the gapped phase associated with the $\text{Rep}(G)$ -module category $\text{Rep}^\beta(H)$, they must transform in a direct summand of the Lagrangian algebra $L(H, \beta)$. The crux of our argument relies on the observation that the expectation value of any string operator in the ground state subspace explicitly depends on the $\text{Tube}(\text{Rep}(G))$ -module associated with $L(H, \beta) \in \text{Vec}_G^G$ via the equivalence $\text{Mod}(\text{Tube}(\text{Rep}(G))) \simeq \mathcal{Z}(\text{Rep}(G)) \simeq \text{Vec}_G^G$. We established this correspondence in app. B.2 by explicitly computing the Lagrangian algebra as an object in $\mathcal{Z}(\text{Rep}(G))$, before expressing its half-braiding natural isomorphism in terms of the $\triangleright F$ - and $\triangleright \bar{F}$ -symbols appearing in eq. (4.44).

We claim that our approach generalises to any fusion category \mathcal{C} . Given a fusion category \mathcal{C} , consider the gapped phase associated with the (indecomposable finite semisimple) \mathcal{C} -module category \mathcal{M} . It is easy to imagine how the derivations of sec. 4.5 would generalise to this case. In particular, one would find that in order for string operators to acquire non-vanishing expectation values, they must be built from irreducible multiplets of twisted sector local operators that transform in a simple direct summand of a certain module over $\text{Tube}(\mathcal{C})$. The defining $\text{Tube}(\mathcal{C})$ -action of this module would be

²⁸Within our framework, it essentially follows from the fact that both the MPS tensor and the action tensor encoding the local action of the symmetry line V_3 via the restriction functor $\text{Res}_{\mathbb{Z}_2 \oplus \mathbb{Z}_2}^{V_3}$ evaluate to the Pauli matrices. When computing the expectation value, the non-trivial action of the endpoint local operator produces a virtual tensor that precisely cancels with the action tensor.

expressed in terms of $\triangleright F$ - and $\triangleright \bar{F}$ -symbols, as in eq. (4.21). One would then demonstrate that this $\text{Tube}(\mathcal{C})$ -module precisely coincides with a Lagrangian algebra object in $\mathcal{Z}(\mathcal{C})$ under the equivalence $\mathcal{Z}(\mathcal{C}) \simeq \text{Mod}(\text{Tube}(\mathcal{C}))$. More concretely, indecomposable finite semisimple \mathcal{C} -module categories \mathcal{M} are in one-to-one correspondence with Lagrangian algebras in $\mathcal{Z}(\mathcal{C})$. Given such an \mathcal{M} , the corresponding Lagrangian algebra can be constructed as the *full centre* $\mathcal{Z}(\mathcal{M})$ of \mathcal{M} in $\mathcal{Z}(\mathcal{C})$ [Dav10, DKR11]. Crucially, this construction establishes that the half-braiding natural isomorphism of the Lagrangian algebra in $\mathcal{Z}(\mathcal{C})$ associated with \mathcal{M} can be expressed in terms of the module associator of \mathcal{M} , in a way that precisely coincides with the $\triangleright F$ - and $\triangleright \bar{F}$ -symbols appearing in the definition of the $\text{Tube}(\mathcal{C})$ -module structure (see app. A).²⁹

SECTION 5

Phases of symmetric mixed states

In this section, we briefly demonstrate how our approach further generalises to the case of symmetric mixed states with respect to invertible symmetries. We explain how string order parameters furnish condensable algebras in the Drinfel'd centre of the symmetry fusion category.

5.1 Matrix product density operators

The study of symmetric phases of matter can be extended from pure states to mixed states. In this context, decoherence both destroys some patterns of entanglement and enables new ones, leading to a richer phase classification. Previous work on symmetric mixed states has studied their SPT phases [dGTS21, MW23, LYX25, ZQB26, MZB⁺25] (including some *intrinsically mixed* SPT phases which are obstructed from arising in pure states) as well as phases that exhibit an intrinsically mixed form of symmetry breaking called *strong-to-weak spontaneous symmetry breaking* (SWSSB) [LJX23, MZB⁺25, LMZ⁺25, SGOY24]. The representation of these states with matrix product tensor networks has also been investigated [MT25, XLB24, GZZ⁺25]. Mixed state phases can be studied from the perspective of symmetry TFT [QSC⁺25, SNTWZ25, LWB25]. Consistent with these results, we find that string order parameters furnish (typically non-Lagrangian) *condensable algebras* in the Drinfel'd centre of the symmetry fusion category. Specifically, we find that expectation values $\text{tr}[\mathcal{S}\Psi]$ of string operators \mathcal{S} in a mixed state Ψ are enough to reconstruct the condensable algebra as an object, which ultimately implies that it suffices to compute such expectation values to distinguish phases.³⁰

We work within the framework of sec. 2.1, whereby the microscopic Hilbert space is defined to be $\mathcal{H}_\Lambda = \bigotimes_{i \in \Lambda} V_{\{i\}}$, where $V \in \text{Rep}(G)$ is a faithful representation. Any *mixed state* in \mathcal{H}_Λ can be expressed as a matrix product density operator (MPDO). Here, we focus on MPDOs with finite bond dimension in the thermodynamic limit; physically, this condition is meant to exclude criticality and is analogous to the gapped condition on pure states.

²⁹Consider $\text{Rep}^\beta(G) \in \text{Mod}(\text{Rep}(G))$. The full centre construction relates the half-braiding isomorphism $R_{V,L(G,\beta)} : V \otimes L(G,\beta) \cong L(G,\beta) \otimes V$ of the Lagrangian algebra $L(G,\beta) \in \mathcal{Z}(\text{Rep}(G))$ associated with $\text{Rep}^\beta(G)$ to the components $\alpha_{V,L(G,\beta),U_1}^\triangleright$ and $\bar{\alpha}_{L(G,\beta),V,U_1}^\triangleright$ of the module associator α^\triangleright and its inverse of $\text{Rep}^\beta(G)$, for every irreducible linear representation V and irreducible β -projective representation U_1 . Decomposing $L(G,\beta)$ into simple objects in $\text{Rep}(G)$ and computing the matrix coefficients of $R_{V,L(G,\beta)}$ precisely recovers the combinations of $\triangleright F$ - and $\triangleright \bar{F}$ -symbols found in eq. (4.44) (see app. B.2).

³⁰In particular, knowledge of Rényi-2 correlators $\text{tr}[\mathcal{S}\Psi\mathcal{S}'\Psi]$ [LJX23, LMZ⁺25] and more general Rényi-1 correlators $\text{tr}[\mathcal{S}\sqrt{\Psi}\mathcal{S}'\sqrt{\Psi}]$ [Wei25] are not necessary to distinguish a phase from all others. For example, the \mathbb{Z}_2 strong-to-weak symmetry breaking phase, associated with the condensable algebra $C = 0$, is completely characterised by the vanishing of all string expectation values [MT25].

We now specialise to MPDOs. An MPDO $\Psi(\theta)$ is an MPO that satisfies the conditions of *self-adjointness* $\Psi(\theta)^\dagger = \Psi(\theta)$ and *positivity*. These conditions constrain the topological invariants that the MPDO can realise [MT25, XLB24]. In the context of MPDOs, the injectivity condition is known as *strong injectivity*.

The transfer matrix \mathbb{E}_θ of the MPDO tensor θ is defined as³¹

$$\mathbb{E}_\theta := \sum_{d=1}^{\dim_{\mathbb{C}} V} \theta_d^d \equiv \begin{array}{c} \text{---} \\ \uparrow \\ \square \\ \downarrow \\ \text{---} \end{array} \in \text{End}_{\mathbb{C}}(M) \quad (5.8)$$

$$\equiv \sum_{l_1, l_2=1}^{\dim_{\mathbb{C}} M} (\mathbb{E}_\theta)_{l_2}^{l_1} m_{l_1} \otimes m^{l_2},$$

where $(\mathbb{E}_\theta)_{l_2}^{l_1} := \sum_{d=1}^{\dim_{\mathbb{C}} V} (\theta_d^{l_1})_{l_2}^d$. An MPDO is said to be *weakly injective* if the transfer matrix admits a single and non-degenerate eigenvalue $\xi \in \mathbb{C}$ of largest weight. Graphically,

$$\begin{array}{c} \text{---} \\ \uparrow \\ \square \\ \downarrow \\ \text{---} \end{array} \triangleright \Xi_r = \xi \cdot \leftarrow \triangleright \Xi_r, \quad \Xi_l \triangleleft \begin{array}{c} \text{---} \\ \uparrow \\ \square \\ \downarrow \\ \text{---} \end{array} = \xi \cdot \Xi_l \triangleleft \leftarrow, \quad (5.9)$$

where $\Xi_r, \Xi_l \in M$ are the unique right and left eigenvectors with eigenvalue ξ . Without loss of generality, one can normalise the MPDO tensor θ so that $\xi = 1$, making Ξ_r and Ξ_l right and left *fixed points* of \mathbb{E}_θ . Since all other eigenvalues have magnitude less than 1, the product of N transfer matrices tends toward a projector in the limit of large N :

$$\begin{array}{c} \text{---} \\ \uparrow \\ \square \\ \downarrow \\ \text{---} \end{array} \begin{array}{c} \text{---} \\ \uparrow \\ \square \\ \downarrow \\ \text{---} \end{array} \dots \begin{array}{c} \text{---} \\ \uparrow \\ \square \\ \downarrow \\ \text{---} \end{array} \begin{array}{c} \text{---} \\ \uparrow \\ \square \\ \downarrow \\ \text{---} \end{array} = \begin{array}{c} \leftarrow \triangleright \\ \Xi_l \Xi_r \end{array} + O(e^{N\tilde{\xi}}) \xrightarrow{N \rightarrow \infty} \begin{array}{c} \leftarrow \triangleright \\ \Xi_l \Xi_r \end{array}, \quad (5.10)$$

where $\tilde{\xi}$ denotes the eigenvalue of second highest magnitude. A special class of MPDOs are renormalisation group fixed points, defined as those for which the transfer matrix \mathbb{E} is a projector.

It is worth noting that the blocks $\Psi(\theta_a)$ of an MPDO $\Psi(\theta)$ may themselves fail to be MPDOs because they fail positivity.³² It is believed that strong injectivity and positivity imply weak injectivity, but this claim is yet to be proven.³³ We will assume in the following that at least one of the positive blocks is weakly injective, and this will turn out to imply that many other blocks are weakly injective too. The transfer matrix \mathbb{E}_θ of a block injective MPDO tensor decomposes as $\mathbb{E}_\theta = \oplus_a \mathbb{E}_{\theta_a}$ and has a space of fixed points spanned by the fixed points Ξ_a of \mathbb{E}_{θ_a} of the blocks.

³¹This transfer matrix is distinguished from the transfer matrix of the MPO tensor realized as an MPS tensor. The latter transfer matrix involves two copies of the tensor.

³²For example, in the two-block MPDO $\mathbb{1} \dots \mathbb{1} + \sigma^x \dots \sigma^x$, the block corresponding to $\sigma^x \dots \sigma^x$ is not itself an MPDO.

³³The claim is stated as a conjecture in ref. [MT25]. It is proven for *locally purified* MPDOs in ref. [GZZ+25].

The expectation value of an operator \mathcal{O} supported on a finite interval has the form

(5.11)

In the thermodynamic limit, it involves an infinite number of copies of the transfer matrix. Therefore on a block whose transfer matrix has spectral radius less than 1, the expectation value vanishes.³⁴ Note, however, that these blocks still affect expectation values of non-local operators like symmetry operators.

5.2 Classification

We now review the classification of phases of symmetric mixed states, as formulated in ref. [QSC⁺25, Dav09, WP23, MT25, XLB24, GZZ⁺25].³⁵ Let $H \leq G$ be subgroup of G and $N \triangleleft H$ a normal subgroup of H . Pick a cocycle $\beta \in Z^2(N, \text{U}(1))$ and a function $\epsilon: N \times H \rightarrow \text{U}(1)$ satisfying

$$\epsilon_n(h_1 h_2) = \epsilon_{h_2 n h_2^{-1}}(h_1) \epsilon_n(h_2), \quad (5.12)$$

$$\epsilon_{n_1}(h) \epsilon_{n_2}(h) \beta(h n_1 h^{-1}, h n_2 h^{-1}) = \epsilon_{n_1 n_2}(h) \beta(n_1, n_2), \quad (5.13)$$

$$\frac{\beta(n_1, n_2)}{\beta(n_1 n_2 n_1^{-1}, n_1)} = \epsilon_{n_2}(n_1), \quad (5.14)$$

for every $h, h_1, h_2 \in H$ and $n, n_1, n_2 \in N$. Each quadruple (H, N, β, ϵ) , up to simultaneously shifting β by a coboundary $d\lambda$ and $\epsilon_n(h)$ by $\lambda(h)/\lambda(h n h^{-1})$, labels a phase of G -symmetric mixed states. Below we explain how to construct a representative of the phase of G -symmetric mixed states associated with the quadruple (H, N, β, ϵ) . But first, we need to explain the physical meaning of this classification. Throughout, we borrow the notation of sec. 2.3.

Consider a block-injective tensor $\theta = \bigoplus_a \theta_a$ and the corresponding MPDO. Each block labelled by some index a produces an MPDO $\Psi(\theta_a)$ in $\text{End}_{\mathbb{C}}(\mathcal{H}_{\Lambda})$. The block-injective MPDO is said to be G -symmetric if the subspace $\mathbb{C}\{\Psi(\theta_a)\}_a$ is closed under the left action of the symmetry lines $\prod_{i \in \Lambda} \rho(g)_i$, for every $g \in G$ and any system size $|\Lambda|$, and is also closed under the right action of the symmetry lines. Suppose the MPDO is symmetric. Then, regarding the MPDO as an MPS with physical space $\text{End}_{\mathbb{C}}(V)$, the arguments from before imply that the MPDO define a $\text{Vec}_{G \times G}$ -module category; in particular, the set of labels a that index the injective blocks is a $(G \times G)$ -set such that $(g_l, g_r)(a) = g_l(g_r(a)) = g_r(g_l(a))$, for every $(g_l, g_r) \in G \times G$. Explicitly, acting with the left symmetry on $\Psi(\theta_a)$ for any a results in an injective MPS proportional to $\Psi(\theta_{g_l(a)})$, whereas acting with the right symmetry results in a state proportional to $\Psi(\theta_{g_r(a)})$. However, not all $\text{Vec}_{G \times G}$ -module categories are compatible with the constraints of self-adjointness and positivity of the MPDO [MT25, XLB24], and it is only after imposing these constraints that the aforementioned classification is obtained.

³⁴Two examples to have in mind are the following: In the strong-to-weak symmetry breaking state $| \dots | + \sigma^x \dots \sigma^x$, the block corresponding to $\sigma^x \dots \sigma^x$ has transfer matrix $\mathbb{E} = 0$ and does not contribute. In the pure symmetry breaking state $(|0 \dots 0\rangle + |1 \dots 1\rangle)(\langle 0 \dots 0| + \langle 1 \dots 1|)$, the two off-diagonal blocks do not contribute.

³⁵While this classification has appeared in the literature, its explicit realisation in terms of block-injective MPDOs has not, to our knowledge, been spelled out in the full generality treated here.

As in the pure state case, an indecomposable module category has blocks labelled by cosets of the subgroup of block-fixing symmetry lines in the full group of symmetry lines. In the present setting, this means the blocks are labelled by $a \in \{1, \dots, (G \times G : S)\}$, where S is the subgroup that stabilises blocks. The subgroup $H \leq G$ consists of the lines whose diagonal action fixes all blocks, i.e., lines $\mathbb{C}h \in \text{Vec}_G$ for which $h_l h_r(a) = a$ for all a . The subgroup $N \triangleleft H$ consists of lines whose left action fixes all blocks; one can verify that N is normal in H and, since $\Psi(\theta)$ is self-adjoint, is equal to the subgroup of lines whose right action fixes all blocks. Thus, S is the subgroup $\{(nh, h) \in G \times G \mid (n, h) \in N \times H\}$. This means that the number of blocks is $(G : H)(G : N)$. We will refer to H and N , respectively, as the subgroups of *weakly and strongly preserved lines*.³⁶

Let us now argue that only $(G : H)$ of these blocks contribute to local observables. It was shown above that a block contributes if and only if its transfer matrix has a spectral radius of 1. Fix a basepoint block a_0 , which we assume is weakly injective. Any other block is related to the basepoint by the action of some element $(g_1, g_2) \in G \times G$. Therefore, the transfer matrix \mathbb{E}_{θ_a} of a block a is given by $\text{tr}_V[\theta_a] = \text{tr}_V[U_{g_2}^{-1} \theta_{a_0} U_{g_1}] = \text{tr}_V[U_{g_1 g_2^{-1}} \theta_{a_0}]$. If $g_1 g_2^{-1} \in N$, the transfer matrix of the block a has unique peripheral eigenvalue 1; in fact, it is related to the transfer matrix of the basepoint a_0 by conjugation by $\phi^{r_{a_0} g_1 g_2^{-1} r_{a_0}^{-1}, a_0}$, defined below in eq. (5.17). On the other hand, if $g_1 g_2^{-1} \notin N$, we believe that the spectral radius is strictly less than 1; this has been shown when the MPDO represents a pure state [BC17] and the argument straightforwardly extends to large class of MPDOs, namely those with local purifications. If $g_1 g_2^{-1} = n \in N$, then $g_2^{-1} = g_1^{-1} n$, and since n fixes the block a , this means that the block a is related to the basepoint a_0 by the action of $(g_1, g_1) \in G \times G$. Since the intersection of the diagonal subgroup $\Delta(G) := \{(g, g) \in G \times G \mid g \in G\}$ with the stabiliser S is $\Delta(H)$, we conclude that the contributing blocks are labelled by cosets in $\Delta(G)/(\Delta(G) \cap S) \cong G/H$. Note that the space of contributing blocks is closed under conjugation. Note also that since the basepoint a_0 is weakly injective by assumption and the contributing blocks are related to it by conjugation, they are weakly injective as well. In the following, we restrict to these contributing blocks.

The block-injective built from θ is weakly G -symmetric in the sense that the space spanned by its constitutive injective MPDOs is closed under the action of $\bigotimes_{i \in \Lambda} \text{Ad}_{\rho(g)_i}$, for every $g \in G$. For every $g \in G$ and $a \in \{1, \dots, (G : H)\}$, there are four-valent tensors $\eta^{g,a}$ and $\bar{\eta}^{g,a}$ such that

$$(5.15)$$

³⁶In the language typically used to describe mixed state phases, the block-injective MPDOs we consider are *strongly symmetric* with respect to the full group G of symmetries. H is the group of *not-completely-broken symmetries*, while N is the group of *not-at-all-broken symmetries*. The quotient $K = H/N$ consists of *strong-to-weak-broken symmetries*. No generality has been lost in taking all symmetries to be strong: to realize a strong-to-weak broken symmetry as a weak symmetry of the block-injective MPDO, one can remove blocks from the MPDO so that the left action of that symmetry line is no longer a symmetry; for example, the \mathbb{Z}_2 strong-to-weak symmetry breaking state $\mathbb{1} \cdots \mathbb{1} + \sigma^x \cdots \sigma^x$ [MZB⁺25, LMZ⁺25] becomes the weakly symmetric state $\mathbb{1} \cdots \mathbb{1}$ upon removing the block corresponding to $\sigma^x \cdots \sigma^x$.

and

$$= \mathbb{1}_{M_{g(a)}} . \quad (5.16)$$

Consider the adjoint actions of two symmetry lines labelled by simple objects \mathbb{C}_{g_1} and \mathbb{C}_{g_2} in Vec_G , respectively. As in the pure state case, one can either successively act with both lines, or first locally fuse them before acting with the resulting line. However, in the mixed state case, this does not give rise to a non-trivial complex phase due to the constraints of self-adjointness and positivity on the MPDO [MT25, XLB24].

By construction, for every $a \in \{1, \dots, (G : H)\}$, the MPDO labelled by a is weakly $r_a H r_a^{-1}$ -symmetric in the sense that is invariant under the action of $\bigotimes_{i \in \Lambda} \text{Ad}_{\rho(r_a h r_a^{-1})_i}$, for every $h \in H$. The MPDO is also strongly N -symmetric in the sense that it is an eigenstate of $\bigotimes_{i \in \Lambda} \rho(r_a n r_a^{-1})_i$, for every $n \in N$. For every $n \in N$ and $a \in \{1, \dots, (G : H)\}$, there are three-valent tensors $\phi^{r_a n, a}$ and $\bar{\phi}^{r_a n, a}$ such that

$$= \mathbb{1}_{M_a} . \quad (5.17)$$

and

$$= \mathbb{1}_{M_a} . \quad (5.18)$$

In analogy with the pure state case, we have

$$= \beta(n_1, n_2) \mathbb{1}_{M_a} , \quad (5.19)$$

which implies that in every block, there is an algebra of strongly preserved lines that is Morita equivalent to $\mathbb{C}[N]^\beta$.

In addition, the strong and the weak symmetry conditions are compatible in the following way:

$$= \epsilon_{r_a n r_a^{-1}}(h_{g,a}) \mathbb{1}_{M_a} . \quad (5.20)$$

where we used the fact that $g^r a n = r_{g(a)} h_{g,a} n$.

These relations imply that the right fixed points $\Xi_{r,a}$ of the transfer matrix satisfy

$$\Xi_{r,a} = \text{[Diagram 1]} = \text{[Diagram 2]} = \text{[Diagram 3]} \quad (5.21)$$

where in the last step we used eq. (5.15) together with eq. (5.16). Then, since $\Xi_{r,a}$ is the unique right fixed point of \mathbb{E}_{θ_a} , it can be concluded that

$$\Xi_{r,a} = \text{[Diagram 4]} \quad (5.22)$$

Analogous relations hold for left fixed points.

5.3 Order parameters

Given a phase of G -symmetric mixed states, we are now ready to identify string operators that may serve as *order parameters*. Consider a representative of the phase associated with the quadruple (H, N, β, ϵ) . Given a simple object $([x_0], \hat{W})$ in $\text{Vec}_G^{\mathbb{C}}$, let $\mathcal{S}(x, c_1, c_2)_{i, \dots, j}$ be the string operator constructed in eq. (3.21), for $x \in [x_0]$ and $c_1, c_2 \in \{1, \dots, \dim_{\mathbb{C}} \hat{W}\}$. Let us compute the expectation value of this string operator in state labelled by $a \in \{1, \dots, (G : H)\}$. By definition, the twisting line \mathbb{C}_x needs to be part of the algebra of *strongly* preserved lines for the expectation value not to vanish, i.e. it must lie in $r_a N r_a^{-1}$. Therefore, we assume there is a group element $n \in N$ such that $x = r_a n$. Employing eq. (5.17) at every site $k \in [i + 1, j - 1]$ together with eq. (5.18), it follows from the mixed state analogue of eq. (2.9) that the expectation value evaluates to

$$\Xi_{1,a} \text{[Diagram 5]} \Xi_{r,a} = \text{[Diagram 6]} \Xi_{r,a} \quad (5.23)$$

up to terms that decay exponentially in the length of the string. As usual, let us focus on the right-hand-side factor. This quantity is the result of contracting a twisted sector local operator of the form (3.19) with the tensor network:

$$\Xi_{1,a} \text{[Diagram 7]} \Xi_{r,a} \quad (5.24)$$

We claim that tensor networks of the form (5.24), for every $n \in N$ and $a \in \{1, \dots, (G : H)\}$, form a reducible module over $\text{Tube}(\text{Vec}_G)$. Acting with the tube (3.16) corresponding to $e_g \otimes \varsigma_y \in \text{Tube}(\text{Vec}_G)$ on the tensor network (5.24) labelled by $n \in N$ and $a \in \{1, \dots, (G : H)\}$ results in

$$\delta_{y, r_a n} \cdot \Xi_{1,a} \triangleleft \Xi_{r,a} = \delta_{y, r_a n} \cdot \Xi_{1,a} \triangleleft \Xi_{r,a} . \quad (5.25)$$

One can simplify this tensor network by utilising eq. (5.15), before invoking eq. (5.22) as well as eq. (5.20) and eq. (5.16):

$$\delta_{y, r_a n} \cdot \Xi_{1,a} \triangleleft \Xi_{r,a} = \delta_{y, r_a n} \epsilon_n(h_{g,a}) \cdot \Xi_{1,g(a)} \triangleleft \Xi_{r,g(a)} . \quad (5.26)$$

It remains to verify that this action does endow the space of tensor networks (5.24) with the structure of a module over $\text{Tube}(\text{Vec}_G)$. Firstly, it follows from $gr_a = r_{g(a)}h_{g,a}$, which implies $gr_a n = r_{g(a)}(h_{g,a}nh_{g,a}^{-1})r_{g(a)}^{-1}$, that (5.26) is indeed of the form (5.24), whereby the label in $\{1, \dots, (G : H)\}$ is chosen to be $g(a)$, while the group element in $N \triangleleft H$ is chosen to be $h_{g,a}nh_{g,a}^{-1}$. Together, it confirms that the tensor networks (5.24) arrange into a module over the tube algebra $\text{Tube}(\text{Vec}_G)$. Let us denote this $\text{Tube}(\text{Vec}_G)$ -module by $C(H, N, \beta, \epsilon)$. Invoking the same arguments as in sec. 3.2 and sec. 4.5, one deduces that in order for the string operator $\mathcal{S}(x, c_1, c_2)_{i, \dots, j}$, the simple object $([x_0], \hat{W})$ must be a direct summand of the object in Vec_G^G associated with $C(H, N, \beta, \epsilon)$.

5.4 Condensable algebras

Let us shed some light on the $\text{Tube}(\text{Vec}_G)$ -module $C(H, N, \beta, \epsilon)$ introduced in the previous section. We begin by computing the G -equivariant G -graded vector space corresponding to $C(H, N, \beta, \epsilon)$ via $\text{Vec}_G^G \simeq \text{Mod}(\text{Tube}(\text{Vec}_G))$. Let $\mathbb{C}[N]_\epsilon^\beta = \mathbb{C}\{e_n\}_{n \in N}$ denote the twisted group algebra $\mathbb{C}[N]_\epsilon^\beta$ that is equipped with the H -equivariant structure given by

$$h \cdot e_n = \epsilon_n(h) e_{hnh^{-1}} , \quad (5.27)$$

for every $h \in H$ and $n \in N$. We promote the H -action of $\mathbb{C}[N]_\epsilon^\beta$ to a G -action via the induction functor:

$$\text{Ind}_H^G(\mathbb{C}[N]_\epsilon^\beta) := \mathbb{C}\{\varsigma : G \rightarrow \mathbb{C}[N]_\epsilon^\beta \mid \varsigma(gh^{-1}) = h \cdot \varsigma(g)\}_{\forall g \in G, \forall h \in H}. \quad (5.28)$$

The G -equivariant structure, as usual, is given by $(g \cdot \varsigma)(-) = \varsigma(g^{-1}-)$. Moreover, $\text{Ind}_H^G(\mathbb{C}[N]_\epsilon^\beta)$ is G -graded, whereby every function $\varsigma \in \text{Ind}_H^G(\mathbb{C}[N]_\epsilon^\beta)$ is homogeneous of degree $x \in G$ if and only if $\varsigma(y) \in \mathbb{C}[N]_\epsilon^\beta$ is homogeneous of degree $y^{-1}xy \in N$, for every $y \in G$. In particular, we have $\text{Ind}_H^G(\mathbb{C}[N]_\epsilon^\beta)_{1_G} \cong \mathbb{C}(G/H)$. Furthermore, if ς is homogeneous of degree $x \in G$, then, by definition, $g \cdot \varsigma$ is homogeneous of degree gxg^{-1} . Therefore, $\text{Ind}_H^G(\mathbb{C}[N]_\epsilon^\beta)$ defines an object in Vec_G^G . Mimicking the derivations of sec. 2.4, we find that $\text{Ind}_H^G(\mathbb{C}[N]_\epsilon^\beta) = \mathbb{C}\{\varsigma_{a,n}\}_{a=1,\dots,(G:H), n \in N}$, where the function $\varsigma_{a,n} : G \rightarrow \mathbb{C}[N]_\epsilon^\beta$ is defined by

$$\varsigma_{a,n}(g) = \begin{cases} \epsilon_n(h^{-1}) e_{h^{-1}nh} & \text{if } g \equiv r_a h \in r_a H, \\ 0 & \text{otherwise,} \end{cases} \quad (5.29)$$

for every $g \in G$. By definition, the function $\varsigma_{a,n}$ is homogeneous of degree $|\varsigma_{a,n}| = r_a n r_a^{-1} \in G$. Let us examine the action of G on $\varsigma_{a,n}$, for every $a \in \{1, \dots, (G:H)\}$ and $n \in N$. By definition, $(g \cdot \varsigma_{a,n})(x) = \varsigma_{a,n}(g^{-1}x)$, for every $g, x \in G$, which is non-zero if and only if $x \in g \cdot r_a H = r_{g(a)} H$. Moreover, recall that for each $g \in G$ and $r_a H \in G/H$, there is a unique $h_{g,a} \in H$ such that $gr_a = r_{g(a)} h_{g,a}$. Suppose that $x \equiv r_{g(a)} h \in r_{g(a)} H$, we find

$$\begin{aligned} (g \cdot \varsigma_{a,n})(x) &= \varsigma_{a,n}(r_a h_{g,a}^{-1} r_{g(a)}^{-1} r_{g(a)} h) \\ &= (h^{-1} h_{g,a}) \cdot \varsigma_{a,n}(r_a) = \epsilon_n(h^{-1} h_{g,a}) e_{h^{-1} h_{g,a} n h_{g,a}^{-1} h}, \end{aligned} \quad (5.30)$$

where we used in the last step the fact that $\varsigma_{a,n}(r_a) = e_n$. Invoking condition (5.12) finally implies that

$$g \cdot \varsigma_{a,n} = \epsilon_n(h_{g,a}) \varsigma_{g(a), h_{g,a} n h_{g,a}^{-1}}. \quad (5.31)$$

At this point, one can explicitly verify that $|g \cdot \varsigma_{a,n}| = g|\varsigma_{a,n}|g^{-1}$. The corresponding $\text{Tube}(\text{Vec}_G)$ -module is simply given by $\mathbb{C}\{\varsigma_{a,n}\}_{a,n}$ with

$$(e_g \otimes \varsigma_y) \cdot \varsigma_{a,n} := \delta_{y, r_a n} \epsilon_n(h_{g,a}) \varsigma_{g(a), h_{g,a} n h_{g,a}^{-1}}, \quad (5.32)$$

for every $g, y \in G$, $a \in \{1, \dots, (G:H)\}$ and $n \in N$. This is precisely the $\text{Tube}(\text{Vec}_G)$ -module $C(H, N, \beta, \epsilon)$ we found in sec. 5.3. Concretely, the basis vector $\varsigma_{a,n}$ is identified with the tensor network (5.24) associated with the ground state labelled by a and twisting line $\mathbb{C}_{|\varsigma_{a,n}|} = \mathbb{C}_{r_a n r_a^{-1}} \in \text{Vec}_G$. Mimicking the derivations of sec. 3.3, one can derive an explicit formula providing the multiplicity of any simple object $([x_0], \hat{W}) \in \text{Vec}_G^G$ in $C(H, N, \beta, \epsilon)$ [DS17].

By induction, the object $C(H, N, \beta, \epsilon) \in \text{Vec}_G^G$ is equipped with the structure of an algebra in Vec_G^G , i.e., a G -equivariant G -graded algebra. The multiplication rule, which is provided by the pointwise multiplication of functions $G \rightarrow \mathbb{C}[N]^\beta$, reads

$$\varsigma_{a_1, n_1} \cdot \varsigma_{a_2, n_2} = \delta_{a_1, a_2} \beta(n_1, n_2) \varsigma_{a_1, n_1 n_2}, \quad (5.33)$$

for every $a_1, a_2 \in \{1, \dots, (G:H)\}$ and $n_1, n_2 \in N$, where we used eq. (5.13). One can further check that $C(H, N, \beta, \epsilon)$ is a *condensable algebra* in Vec_G^G , i.e., a connected, indecomposable, separable and commutative algebra (see app. A). The notion that condensable algebras should describe order parameters for mixed state gapped phases already appeared in ref. [QSC⁺25, SNTWZ25].

Finally, let us remark that Lagrangian algebras are special cases of condensable algebras, namely those whose square of the Frobenius–Perron dimension equals the Frobenius–Perron dimension of the braided fusion category they belong to (see app. A). In particular, whenever $H = N$ and $\epsilon = \beta$, it follows from eq. (5.14) that $C(H, H, \beta, \beta) \cong L(H, \beta)$. This is in agreement with the notion that if the algebras of weakly preserved and strongly preserved lines are identical, then it reduces to the pure state case.

Algebras

In this appendix, we collect the definitions of category theoretic concepts that are used throughout this manuscript, together with basic results. For additional details, we encourage the reader to consult ref. [EGNO16], on which we rely extensively.

We assume the reader is familiar with the notion of braided fusion category; otherwise, we recommend consulting ref. [ENO10, DGNO10]. Nonetheless, for convenience, we recall below the list of defining properties of a fusion category over the field of complex numbers:

DEFINITION A.1 (Fusion category). *A fusion category is a finite semisimple \mathbb{C} -linear abelian rigid monoidal category with finitely many isomorphism classes, and such that the space of endomorphisms of the unit is isomorphic to \mathbb{C} .*

Throughout, all the categories are assumed to be finite, semisimple and \mathbb{C} -linear. Given a fusion category \mathcal{C} , the set of representatives of its finitely many isomorphism classes of simple objects is denoted by $\text{Irr}(\mathcal{C})$. The monoidal structure is designated by $(\otimes, 1_{\mathcal{C}}, \alpha)$, where $\otimes : \mathcal{C} \times \mathcal{C} \rightarrow \mathcal{C}$ is the tensor product bifunctor, $1_{\mathcal{C}}$ the unit object, and $\alpha : (- \otimes -) \otimes - \xrightarrow{\sim} - \otimes (- \otimes -)$ the monoidal associator.³⁷ Components of the monoidal associator are written as $\alpha_{X_1, X_2, X_3} : (X_1 \otimes X_2) \otimes X_3 \xrightarrow{\sim} X_1 \otimes (X_2 \otimes X_3)$. For an object $X \in \mathcal{C}$, let X^* denotes its dual, and write the corresponding evaluation and coevaluation morphisms as $\text{ev}_X : X^* \otimes X \rightarrow 1_{\mathcal{C}}$ and $\text{coev}_X : 1_{\mathcal{C}} \rightarrow X^* \otimes X$, respectively. Finally, \mathcal{C}^{op} denotes the fusion category opposite to \mathcal{C} with monoidal structure $(\otimes^{\text{op}}, 1_{\mathcal{C}}, \alpha^{\text{op}})$ such that $X_1 \otimes^{\text{op}} X_2 := X_2 \otimes X_1$ and $\alpha_{X_1, X_2, X_3}^{\text{op}} := \alpha_{X_3, X_2, X_1}^{-1}$, for every $X_1, X_2, X_3 \in \mathcal{C}$.

First, one requires a notion of algebra in a fusion category:

DEFINITION A.2 (Algebra object). *An algebra in a fusion category $\mathcal{C} \equiv (\mathcal{C}, \otimes, 1_{\mathcal{C}}, \alpha)$ is a triple (A, μ, η) consisting of an object A in \mathcal{C} and morphisms $\mu : A \otimes A \rightarrow A$ and $\eta : 1_{\mathcal{C}} \rightarrow A$ in \mathcal{C} , which are required to satisfy associativity and unitality conditions involving the monoidal structure of \mathcal{C} . The morphisms μ and η are referred to as the ‘multiplication’ and the ‘unit’ of A , respectively.*

One recovers the ordinary notion of finite-dimensional unital associative algebra over the field \mathbb{C} by considering algebras in the fusion category Vec of complex vector spaces. For any fusion category \mathcal{C} , the unit trivially carries the structure of an algebra object. More generally, for any $X \in \mathcal{C}$, the object $A = X \otimes X^*$ carries the structure of an algebra, with multiplication $\text{id}_X \otimes \text{ev}_X \otimes \text{id}_{X^*}$ and unit coev_X .

The same way one considers modules over ordinary algebras, there is a notion of module over an algebra in a fusion category:

DEFINITION A.3 (Module object). *A right module over an algebra $A \equiv (A, \mu, \eta)$ (or right A -module) in a fusion category $(\mathcal{C}, \otimes, 1_{\mathcal{C}}, \alpha)$ is pair (M, p) consisting of an object M in \mathcal{C} and an ‘action’ morphism $p : M \otimes A \rightarrow M$ in \mathcal{C} , which is required to satisfy a pentagon axiom involving the monoidal structure of \mathcal{C} and the algebraic structure of A , as well as a unitality condition.*

For instance, consider the algebra $A = X \otimes X^*$ associated with any object $X \in \mathcal{C}$; for every $Y \in \mathcal{C}$, the object $M = Y \otimes X^*$ has the structure of a right module over A with $\text{id}_Y \otimes \text{ev}_X \otimes \text{id}_{X^*} : M \otimes A \rightarrow M$. In general, given two modules (M_1, p_1) and (M_2, p_2) over an algebra A in a fusion category \mathcal{C} , a module homomorphism between them is a morphism $M_1 \rightarrow M_2$ between the corresponding objects that is

³⁷Without loss of generality, we always assume the unit object to be strict.

compatible with the action morphisms p_1 and p_2 . Module homomorphisms between (M_1, p_1) and (M_2, p_2) form a subspace of $\text{Hom}_{\mathcal{C}}(M_1, M_2)$ that is stable under composition. It follows that, given an algebra A in \mathcal{C} , module objects over it form a finite category denoted by $\text{Mod}_{\mathcal{C}}(A)$.³⁸

Left modules over an algebra object A in \mathcal{C} (or left A -modules) are defined similarly. An object M in a fusion category \mathcal{C} is said to be a bimodule over an algebra object A (or (A, A) -bimodule) if it is equipped with both a left A -module structure and a right A -module structure such that the action morphisms are compatible. Given two (A, A) -bimodules in \mathcal{C} , one defines a bimodule homomorphism between them as a morphism in \mathcal{C} that is simultaneously a homomorphism of left A -modules and of right A -modules. We are now ready to introduce an important family of algebra objects:

DEFINITION A.4 (Separable algebra). *An algebra (A, μ, η) in a fusion category \mathcal{C} is said to be ‘separable’ if the multiplication μ admits a ‘section’ $\Delta : A \rightarrow A \otimes A$ such $\mu \circ \Delta = \text{id}_A$ as a homomorphism of (A, A) -bimodules.*

The finite category $\text{Mod}_{\mathcal{C}}(A)$ of modules over any *separable* algebra A in a fusion category \mathcal{C} can be shown to be semisimple. Moreover, $\text{Mod}_{\mathcal{C}}(A)$ turns out to have the structure of a (finite semisimple) *module category* over \mathcal{C} :

DEFINITION A.5 (Module category). *A (left) module category over a fusion category \mathcal{C} (or left \mathcal{C} -module category) is a triple $(\mathcal{M}, \triangleright, \alpha^{\triangleright})$ consisting of a (finite semisimple \mathcal{C} -linear) category \mathcal{M} , an ‘action’ bifunctor $\triangleright : \mathcal{C} \times \mathcal{M} \rightarrow \mathcal{M}$, and a natural isomorphism $\alpha^{\triangleright} : (- \otimes -) \triangleright - \xrightarrow{\sim} - \triangleright (- \triangleright -)$, which is required to satisfy a pentagon axiom involving the monoidal structure of \mathcal{C} .³⁹ The natural isomorphism α^{\triangleright} is referred to as the ‘module associator’ of \mathcal{M} .*

Right module categories are defined similarly. First of all, every fusion category \mathcal{C} is a module category over itself—referred to as the ‘regular’ module category—such that the action bifunctor is given by the tensor product bifunctor. A \mathcal{C} -module category is said to be ‘indecomposable’ whenever it cannot be written as a direct of \mathcal{C} -module categories. As alluded to above, the category $\text{Mod}_{\mathcal{C}}(A)$ or right modules over any algebra object A in a fusion category \mathcal{C} carries the structure of a left \mathcal{C} -module category. The action bifunctor $\triangleright : \mathcal{C} \times \text{Mod}_{\mathcal{C}}(A) \rightarrow \text{Mod}_{\mathcal{C}}(A)$ is simply given by the monoidal structure of \mathcal{C} . Indeed, for any $X \in \mathcal{C}$ and $(M, p) \in \text{Mod}_{\mathcal{C}}(A)$, the object $X \triangleright M := X \otimes M$ together with the action morphism

$$(X \otimes M) \otimes A \xrightarrow{\alpha_{X, M, A}} X \otimes (M \otimes A) \xrightarrow{\text{id}_X \otimes p} X \otimes M \quad (\text{A.1})$$

defines another object in $\text{Mod}_{\mathcal{C}}(A)$. Components of the module associator α^{\triangleright} are then given by $\alpha_{X_1, X_2, M}^{\triangleright} = \alpha_{X_1, X_2, M}$, for every $X_1, X_2 \in \mathcal{C}$ and $M \in \mathcal{M}$, and can be shown to be isomorphisms of A -modules, which completes the argument. For instance, the category of modules over the trivial algebra object in any fusion category \mathcal{C} is equivalent to the regular module category, i.e., $\text{Mod}_{\mathcal{C}}(1_{\mathcal{C}}) \simeq \mathcal{C}$.

The above construction can be used to introduce a notion of Morita equivalence between algebras objects:

DEFINITION A.6 (Algebraic Morita equivalence). *Two algebras (A_1, μ_1, η_1) and (A_2, μ_2, η_2) in a fusion category \mathcal{C} are said to be ‘Morita equivalent’ if their categories of modules $\text{Mod}_{\mathcal{C}}(A_1)$ and $\text{Mod}_{\mathcal{C}}(A_2)$ are equivalent as \mathcal{C} -module categories.*

For instance, one can easily verify that the algebra $A = X \otimes X^*$ associated with any object $X \in \mathcal{C}$ is Morita equivalent to the trivial algebra associated with the unit object.

³⁸Whenever $\mathcal{C} = \text{Vec}$, we simply write $\text{Mod}(A) \equiv \text{Mod}_{\text{Vec}}(A)$.

³⁹We always assume the action of the unit object $1_{\mathcal{C}} \in \mathcal{C}$ to be strict so that $1_{\mathcal{C}} \triangleright M = M$, for every $M \in \mathcal{M}$.

We already know that considering categories of modules over algebras in a fusion category \mathcal{C} is a general way of constructing module categories over \mathcal{C} . As a matter of fact, every *finite* module category over a fusion category \mathcal{C} is equivalent to $\text{Mod}_{\mathcal{C}}(A)$ for a suitable algebra object A [Ost01]. Given a module category over \mathcal{C} , finding such an algebra requires the following concept:

DEFINITION A.7 (Internal hom). *Let $\mathcal{M} \equiv (\mathcal{M}, \triangleright, \alpha^{\triangleright})$ be a module category over a fusion category \mathcal{C} . For every objects $M_1, M_2 \in \mathcal{M}$, there exist an object $\underline{\text{Hom}}(M_1, M_2) \in \mathcal{C}$, referred to as the ‘internal hom’ from M_1 to M_2 , and an isomorphism $\underline{\alpha}_{X, M_1, M_2} : \text{Hom}_{\mathcal{M}}(X \triangleright M_1, M_2) \xrightarrow{\sim} \text{Hom}_{\mathcal{C}}(X, \underline{\text{Hom}}(M_1, M_2))$ that is natural in X , for every $X \in \text{Irr}(\mathcal{C})$.*

Given two objects M_1 and M_2 in a \mathcal{C} -module category \mathcal{M} , consider the isomorphism $\underline{\alpha}_{\underline{\text{Hom}}(M_1, M_2), M_1, M_2}$, and define the ‘internal evaluation’ morphism ev_{M_1, M_2} as the preimage of $\text{id}_{\underline{\text{Hom}}(M_1, M_2)}$, i.e.,

$$\text{ev}_{M_1, M_2} := \underline{\alpha}_{\underline{\text{Hom}}(M_1, M_2), M_1, M_2}^{-1}(\text{id}_{\underline{\text{Hom}}(M_1, M_2)}) : \underline{\text{Hom}}(M_1, M_2) \triangleright M_1 \rightarrow M_2. \quad (\text{A.2})$$

Given three objects $M_1, M_2, M_3 \in \mathcal{M}$, one can then use these internal evaluation morphisms to construct a canonical map of the form

$$\circ_{M_1, M_2, M_3} : \underline{\text{Hom}}(M_2, M_3) \otimes \underline{\text{Hom}}(M_1, M_2) \rightarrow \underline{\text{Hom}}(M_1, M_3) \quad (\text{A.3})$$

as the image under $\underline{\alpha}_{\underline{\text{Hom}}(M_2, M_3) \otimes \underline{\text{Hom}}(M_1, M_2), M_1, M_3}$ of the composition

$$\begin{aligned} & (\underline{\text{Hom}}(M_2, M_3) \otimes \underline{\text{Hom}}(M_1, M_2)) \triangleright M_1 \\ & \xrightarrow{\underline{\alpha}_{\underline{\text{Hom}}(M_2, M_3), \underline{\text{Hom}}(M_1, M_2), M_1}^{\triangleright}} \underline{\text{Hom}}(M_2, M_3) \triangleright (\underline{\text{Hom}}(M_1, M_2) \triangleright M_1) \\ & \xrightarrow{\text{id}_{\underline{\text{Hom}}(M_2, M_3)} \triangleright \text{ev}_{M_1, M_2}} \underline{\text{Hom}}(M_2, M_3) \triangleright M_2 \xrightarrow{\text{ev}_{M_2, M_3}} M_3. \end{aligned} \quad (\text{A.4})$$

In particular, the map \circ_{M_1, M_1, M_2} endows any internal hom $\underline{\text{Hom}}(M_1, M_1)$ with the structure of an algebra in \mathcal{C} , while the map \circ_{M_1, M_1, M_2} endows any internal hom $\underline{\text{Hom}}(M_1, M_2)$ with the structure of a right $\underline{\text{Hom}}(M_1, M_1)$ -module in \mathcal{C} . Given a finite \mathcal{C} -module category \mathcal{M} , one can then demonstrate that for every $M \in \mathcal{M}$, the category $\text{Mod}_{\mathcal{C}}(\underline{\text{Hom}}(M, M))$ is equivalent to \mathcal{M} , as a \mathcal{C} -module category [EGNO16]. For instance, consider the regular \mathcal{C} -module category; for every $X \in \mathcal{C}$, we have $\underline{\text{Hom}}(X, X) \cong X \otimes X^*$, as expected.

One requires a notion of functors between module categories:

DEFINITION A.8 (Module functors). *Let $(\mathcal{M}, \triangleright, \alpha^{\triangleright})$ and $(\mathcal{N}, \triangleright', \alpha^{\triangleright'})$ be two module categories over a fusion category \mathcal{C} . A \mathcal{C} -module functor from \mathcal{M} to \mathcal{N} is a pair (F, ω) consisting of a functor $F : \mathcal{M} \rightarrow \mathcal{N}$ and a natural isomorphism $\omega : F(- \triangleright -) \xrightarrow{\sim} - \triangleright' F(-)$, which is required to satisfy a pentagon axiom involving the module structures of both \mathcal{M} and \mathcal{N} .*

Similarly, one defines a notion of module natural transformation between module functors, which form the morphisms of the category $\text{Func}_{\mathcal{C}}(\mathcal{M}, \mathcal{N})$ of \mathcal{C} -module functors between two \mathcal{C} -module categories \mathcal{M} and \mathcal{N} . Given a fusion category \mathcal{C} , \mathcal{C} -module categories, \mathcal{C} -module functors and \mathcal{C} -module natural transformations are organised into a 2-category $\text{Mod}(\mathcal{C})$.

Crucially, given an indecomposable (finite semisimple) \mathcal{C} -module category \mathcal{M} , the category $\mathcal{C}_{\mathcal{M}}^* := \text{Func}_{\mathcal{C}}(\mathcal{M}, \mathcal{M})$ of \mathcal{C} -module endofunctors of \mathcal{M} carries the structure of a fusion category, where the monoidal structure is provided by the composition of \mathcal{C} -module functors. We refer to $\mathcal{C}_{\mathcal{M}}^*$ as the ‘Morita dual’ of \mathcal{C} with respect to \mathcal{M} :

DEFINITION A.9 (Categorical Morita equivalence). *Two fusion categories \mathcal{C} and \mathcal{D} are said to be ‘Morita equivalent’ if there is an indecomposable (finite semisimple) \mathcal{C} -module category \mathcal{M} such that $\mathcal{C}_{\mathcal{M}}^* \simeq \mathcal{D}^{\text{op}}$.*

This notion of categorical Morita equivalence does categorify the previous notion of algebraic Morita equivalence. In particular, module categories over a fusion category \mathcal{C} are in one-to-one correspondence with module categories over its Morita dual $\mathcal{C}_{\mathcal{M}}^*$ with respect to any (indecomposable finite semisimple) \mathcal{C} -module category \mathcal{M} . Specifically, given a \mathcal{C} -module category \mathcal{N} , $\text{Func}(\mathcal{M}, \mathcal{N})$ carries the structure of a module category over $(\mathcal{C}_{\mathcal{M}}^*)^{\text{op}}$. As a matter of fact, the 2-functor $\text{Func}(\mathcal{M}, -) : \text{Mod}(\mathcal{C}) \rightarrow \text{Mod}((\mathcal{C}_{\mathcal{M}}^*)^{\text{op}})$ is a 2-equivalence. This is a 2-categorical invariant of Morita equivalence. Another invariant of Morita equivalence is provided by the Drinfel’d centre construction [Maj91, JS91]:

DEFINITION A.10 (Drinfel’d centre). *The ‘Drinfel’d centre’ $\mathcal{Z}(\mathcal{C})$ of a fusion category \mathcal{C} is the monoidal category whose objects are pairs $(Z, R_{-,Z})$ consisting of an object $Z \in \mathcal{C}$ and a ‘half-braiding’ natural isomorphism $R_{-,Z} : - \otimes Z \xrightarrow{\sim} Z \otimes -$, which is required to satisfy a hexagon axiom involving the monoidal structure of \mathcal{C} . A morphism in $\mathcal{Z}(\mathcal{C})$ between two objects (Z_1, R_{-,Z_1}) and (Z_2, R_{-,Z_2}) is a morphism $f \in \text{Hom}_{\mathcal{C}}(Z_1, Z_2)$ such that $(f \otimes \text{id}_X) \circ R_{X,Z_1} = R_{X,Z_2} \circ (\text{id}_X \otimes f)$. The tensor product of these two objects is given by $(Z_1 \otimes Z_2, R_{-,Z_1 \otimes Z_2})$, where $R_{-,Z_1 \otimes Z_2}$ is defined via a hexagonal commutative diagram involving the half-braiding isomorphisms as well as the monoidal structure of \mathcal{C} .*

In addition to being a monoidal category, the Drinfel’d centre $\mathcal{Z}(\mathcal{C})$ of a fusion category \mathcal{C} can be verified to carry a fusion structure. Moreover, it is braided, where the braiding natural isomorphism is constructed from the individual half-braiding natural isomorphisms. Furthermore, it is ‘non-degenerate’, in the sense that the full subcategory of objects $(Z, R_{-,Z}) \in \mathcal{Z}(\mathcal{C})$ satisfying $R_{X,Z} \circ R_{Z,X} = \text{id}_{X \otimes Z}$, for every $X \in \mathcal{C}$, is equivalent to Vec [Mü03a, DGNO10]. For every indecomposable module category \mathcal{M} over a fusion category \mathcal{C} , we can then show that $\mathcal{Z}(\mathcal{C}) \simeq \mathcal{Z}(\mathcal{C}_{\mathcal{M}}^*)$, as non-degenerate braided fusion categories [Mü03b]. The proof consists in first establishing that $\mathcal{Z}(\mathcal{C})$ is equivalent to $(\mathcal{C} \boxtimes \mathcal{C}_{\mathcal{M}}^*)_{\mathcal{M}}^*$, which is symmetric in \mathcal{C} and $\mathcal{C}_{\mathcal{M}}^*$.

Whenever dealing with a braided fusion category \mathcal{B} with braiding R , one can require an algebra object (A, μ, η) in \mathcal{B} to be ‘commutative’, i.e., $\mu = \mu \circ R_{A,A}$, and subsequently ‘étale’:

DEFINITION A.11 (Étale algebra). *An algebra A in a braided fusion category \mathcal{B} is said to be ‘étale’ if it is indecomposable, separable and commutative.*

In general, an algebra object is said to be connected whenever the hom-space between the underlying object and the unit object is isomorphic to \mathbb{C} . In the physics literature, connected étale algebras are often referred to as ‘condensable’ algebras. We are now ready to introduce the following family of algebra objects in a braided fusion category:

DEFINITION A.12 (Lagrangian algebra). *A ‘Lagrangian’ algebra in a braided fusion category \mathcal{B} is a connected étale algebra L such that $\text{FPdim}(L)^2 = \text{FPdim}(\mathcal{B})$.*

In the main text, we always consider Lagrangian algebras in the Drinfel’d centre of a fusion category \mathcal{C} , where $\text{FPdim}(\mathcal{Z}(\mathcal{C})) = \text{FPdim}(\mathcal{C})^2$. In this case, it is always possible to construct a Lagrangian algebra L in $\mathcal{Z}(\mathcal{C})$ from the data of an indecomposable separable algebra in \mathcal{C} via the ‘full centre’ construction [Dav10]:

DEFINITION A.13 (Full centre of an algebra). Let (A, μ, η) be an algebra in a fusion category \mathcal{C} . Consider pairs $((Z, R_{-,Z}), \zeta)$ consisting of objects $(Z, R_{-,Z})$ in $\mathcal{Z}(\mathcal{C})$ and morphisms $\zeta : Z \rightarrow A$ in \mathcal{C} such that the following diagram commutes:

$$\begin{array}{ccc}
A \otimes Z & \xrightarrow{R_{A,Z}} & Z \otimes A \\
\text{id}_A \otimes \zeta \downarrow & & \downarrow \zeta \otimes \text{id}_A \\
A \otimes A & \xrightarrow{\mu} A \xleftarrow{\mu} & A \otimes A
\end{array} \quad (\text{A.5})$$

The ‘full centre’ $\mathcal{Z}(A)$ of A is an object in $\mathcal{Z}(\mathcal{C})$ equipped with a morphism $\mathcal{Z}(A) \rightarrow A$ such that for every such pair $((Z, R_{-,Z}), \zeta)$ there is a unique morphism $Z \rightarrow \mathcal{Z}(A)$ in $\mathcal{Z}(\mathcal{C})$ making the diagram

$$\begin{array}{ccc}
Z & \xrightarrow{\quad} & \mathcal{Z}(A) \\
& \searrow \zeta & \swarrow \\
& & A
\end{array} \quad (\text{A.6})$$

commutes.

As alluded to above, the full centre $\mathcal{Z}(A)$ of an indecomposable separable algebra A in a fusion category \mathcal{C} can be shown to be a Lagrangian algebra in $\mathcal{Z}(\mathcal{C})$ [DS17]. In a similar vein, one can define the centre of a module category over a fusion category \mathcal{C} :

DEFINITION A.14 (Full centre of a module category). Let $(\mathcal{M}, \triangleright, \alpha^\triangleright)$ be a module category over a fusion category \mathcal{C} . Consider pairs $((Z, R_{-,Z}), \zeta)$ consisting of objects $(Z, R_{-,Z})$ in $\mathcal{Z}(\mathcal{C})$ and collections ζ of morphisms $\zeta_M : Z \triangleright M \rightarrow M$ in \mathcal{M} that are natural in $M \in \mathcal{M}$ such that the following diagram commutes for every $M \in \mathcal{M}$ and $X \in \mathcal{C}$:

$$\begin{array}{ccc}
(X \otimes Z) \triangleright M & \xrightarrow{R_{X,Z} \triangleright \text{id}_M} & (Z \otimes X) \triangleright M \\
\alpha_{X,Z,M}^\triangleright \downarrow & & \downarrow \alpha_{Z,X,M}^\triangleright \\
X \triangleright (Z \triangleright M) & \xrightarrow{\text{id}_X \triangleright \zeta_M} X \triangleright M \xleftarrow{\zeta_{X \triangleright M}} & Z \triangleright (X \triangleright M)
\end{array} \quad (\text{A.7})$$

The ‘full centre’ $\mathcal{Z}(\mathcal{M})$ of \mathcal{M} is an object in $\mathcal{Z}(\mathcal{C})$ equipped with a collection of morphisms $\mathcal{Z}(\mathcal{M}) \triangleright M \rightarrow M$ such that for every such pair $((Z, R_{-,Z}), \zeta)$ there is a unique morphism $Z \rightarrow \mathcal{Z}(\mathcal{M})$ in $\mathcal{Z}(\mathcal{C})$ making the diagram

$$\begin{array}{ccc}
Z \triangleright M & \xrightarrow{\quad} & \mathcal{Z}(\mathcal{M}) \triangleright M \\
& \searrow \zeta_M & \swarrow \\
& & M
\end{array} \quad (\text{A.8})$$

commutes, for every $M \in \mathcal{M}$.

For any algebra A in a fusion category \mathcal{C} , one can then verify that the centre $\mathcal{Z}(\text{Mod}_{\mathcal{C}}(A))$ of the \mathcal{C} -module category $\text{Mod}_{\mathcal{C}}(A)$ coincides with the full centre $\mathcal{Z}(A)$ of A [Dav10]. The \mathcal{C} -module categories of modules over Morita equivalent algebras being equivalent, this makes the full centre construction an invariant of Morita equivalence. Therefore, Morita equivalent indecomposable separable algebras yield equivalent Lagrangian algebras.

Drinfel'd centres and tube algebras

Numerous results in the main text exploits the equivalences between the category of G -equivariant G -graded vector spaces, the Drinfel'd centres of the category of G -graded vector spaces and the category of G -representations, as well as the category of modules over the tube algebras of the category of G -graded vector spaces and the category of G -representations. Here, we briefly sketch these equivalences before deriving results that are used in the main text.

Before proceeding with our examples, let us briefly sketch the general case. Let \mathcal{C} be a (unitary) fusion category. Consider the vector space

$$\text{Tube}(\mathcal{C}) \equiv \bigoplus_{X_1, X_2 \in \text{Irr}(\mathcal{C})} \text{Tube}(\mathcal{C})_{X_2}^{X_1}, \quad \text{Tube}(\mathcal{C})_{X_2}^{X_1} := \bigoplus_{Y \in \text{Irr}(\mathcal{C})} \text{Hom}_{\mathcal{C}}(X_2 \otimes Y, Y \otimes X_1). \quad (\text{B.1})$$

For every $X_1, X_2 \in \text{Irr}(\mathcal{C})$, one thinks about the vector space $\text{Tube}(\mathcal{C})_{X_2}^{X_1}$ as the space of formal \mathbb{C} -linear combinations of equivalence classes of *string diagrams* on the cylinder for incoming simple boundary condition X_2 and outgoing simple boundary condition X_1 . This vector space has the structure of a $*$ -algebra with the multiplication of two elements defined by ‘gluing’ the corresponding equivalence classes of string diagrams and the $*$ -operation obtained by flipping the string diagrams upside down, inverting the orientation of all the strings, and taking the inverse of all the morphisms. We refer to this $*$ -algebra as the *tube algebra* $\text{Tube}(\mathcal{C})$ of \mathcal{C} . More concretely, given $Y_1, Y_2, X_1, X_2, X_3, X_4 \in \text{Irr}(\mathcal{C})$, let $\varphi_{Y_2 X_1}^{X_2 Y_2} \in \text{Tube}(\mathcal{C})_{X_2}^{X_1}$ and $\varphi_{Y_1 X_3}^{X_4 Y_1} \in \text{Tube}(\mathcal{C})_{X_4}^{X_3}$, which we regard as elements of $\text{Tube}(\mathcal{C})$. The multiplication rule reads

$$\begin{aligned} \varphi_{Y_1 X_3}^{X_4 Y_1} \cdot \varphi_{Y_2 X_1}^{X_2 Y_2} &:= \delta_{X_2, X_3} \sum_{\substack{Y_3 \in Y_1 \otimes Y_2 \\ 1 \leq i \leq N_{Y_3}^{Y_1 Y_2}}} (\text{id}_{X_4} \otimes \bar{\varphi}_{Y_3, i}^{Y_1 Y_2}) \circ (\varphi_{Y_1 X_2}^{X_4 Y_1} \otimes \text{id}_{Y_2}) \circ (\text{id}_{Y_1} \otimes \varphi_{Y_1 X_1}^{X_2 Y_2}) \circ (\varphi_{Y_3, i}^{Y_1 Y_2} \otimes \text{id}_{X_1}) \\ &\in \text{Tube}(\mathcal{C})_{X_4}^{X_1}. \end{aligned} \quad (\text{B.2})$$

In order to extract the structure constants of this algebra, one typically works in the basis provided by the decomposition

$$\text{Tube}(\mathcal{C})_{X_3}^{X_1} = \bigoplus_{Y, X_2 \in \text{Irr}(\mathcal{C})} \text{Hom}_{\mathcal{C}}(X_3 \otimes Y, X_2) \otimes \text{Hom}_{\mathcal{C}}(X_2, Y \otimes X_1). \quad (\text{B.3})$$

At this point, one recovers the framework of the main text and the structure constants can be expressed in terms of the F -symbols of the monoidal structure (see e.g. eq. (4.27)). Similarly, one can conveniently expand the result of the $*$ -operation mentioned above in this basis. By virtue of being a finite-dimensional $*$ -algebra, $\text{Tube}(\mathcal{C})$ is semisimple, and so is its category $\text{Mod}(\text{Tube}(\mathcal{C}))$ of modules. It is well known that $\text{Mod}(\text{Tube}(\mathcal{C})) \simeq \mathcal{Z}(\mathcal{C})$ [Ocn94, Ocn01, Izu00, Mii03a, NY18]. In particular, given an object $(Z, R_{-, Z}) \in \mathcal{Z}(\mathcal{C})$, the vector space underlying the corresponding module in $\text{Mod}(\text{Tube}(\mathcal{C}))$ is given by $\bigoplus_{X \in \text{Irr}(\mathcal{C})} \text{Hom}_{\mathcal{C}}(X, Z)$ and the action of the tube element $\varphi_{Y X_1}^{X_2 Y} \in \text{Tube}(\mathcal{C})_{X_2}^{X_1}$ on the module element $\varphi_Z^X \in \text{Hom}_{\mathcal{C}}(X, Z)$ is given by

$$\begin{aligned} \varphi_{Y X_1}^{X_2 Y} \cdot \varphi_Z^X &:= \delta_{X_1, X} (\text{id}_Z \otimes \text{ev}_Y^*) \circ (R_{Y, Z} \otimes \text{id}_{Y^*}) \circ (\text{id}_Y \otimes \varphi_Z^X \otimes \text{id}_{Y^*}) \\ &\quad \circ (\varphi_{Y X}^{X_2 Y} \otimes \text{id}_{Y^*}) \circ (\text{id}_{X_2} \otimes \text{coev}_Y^*) \in \text{Hom}_{\mathcal{C}}(X_2, Z). \end{aligned} \quad (\text{B.4})$$

This action is best expressed graphically in the same vein as eq. (4.28).

B.1 Drinfel'd centre of the category of group graded vector spaces

Consider the fusion category Vec_G of G -graded vector spaces. The Drinfel'd centre $\mathcal{Z}(\text{Vec}_G)$ of Vec_G is equivalent, as a braided fusion category, to the category Vec_G^G of G -equivariant G -graded vector spaces. Recall that an object in Vec_G^G consists of a G -graded vector space $W = \bigoplus_{x \in G} W_x$ together with a compatible G -equivariant structure such that $g \cdot W_x \subseteq W_{g x g^{-1}}$, for every $g, x \in G$. Let $(W, R_{-,W})$ be an object in $\mathcal{Z}(\text{Vec}_G)$; it consists of a G -graded vector space $W = \bigoplus_{x \in G} W_x$ and a collection of G -grading preserving isomorphisms $R_{K,W}: K \otimes W \xrightarrow{\sim} W \otimes K$ that are natural in K , for every $K \in \text{Vec}_G$. In particular, for every $g \in G$, we have $R_{\mathbb{C}_g, W}: \mathbb{C}_g \otimes W \xrightarrow{\sim} W \otimes \mathbb{C}_g$. It follows from $\mathbb{C}_g \otimes W \cong \bigoplus_{x \in G} W_{g^{-1}x}$ and $W \otimes \mathbb{C}_g \cong \bigoplus_{x \in G} W_{xg^{-1}}$ that $R_{\mathbb{C}_g, W}$ boils down to a collection of isomorphisms $W_x \xrightarrow{\sim} W_{g x g^{-1}}$, for every $g, x \in G$. The natural isomorphism $R_{-,W}$ is subject to a hexagon axiom, which imposes

$$(R_{\mathbb{C}_{g_1}, W} \otimes \text{id}_{\mathbb{C}_{g_2}}) \circ (\text{id}_{\mathbb{C}_{g_1}} \otimes R_{\mathbb{C}_{g_2}, W}) = R_{\mathbb{C}_{g_1 g_2}, W}, \quad (\text{B.5})$$

for every $g_1, g_2 \in G$. It follows that the isomorphisms $W_x \xrightarrow{\sim} W_{g x g^{-1}}$ do equip W with a G -equivariant structure that is compatible with the G -grading. Conversely, given an object $W \in \text{Vec}_G^G$, the corresponding object in $\mathcal{Z}(\text{Vec}_G)$ has the same underlying G -graded vector space and the half-braiding natural isomorphism is provided by

$$R_{K,W}(k \otimes w) = g \cdot w \otimes k, \quad (\text{B.6})$$

for $K = \bigoplus_{g \in G} K_g \in \text{Vec}_G$, $k \in K_g$ and $w \in W$. This is the equivalence $\mathcal{Z}(\text{Vec}_G) \simeq \text{Vec}_G^G$.

Let us consider a couple of special cases. Given $[x_0] \in \text{Cl}(G)$ and $\hat{W} \in \text{Irr}(\text{Rep}(Z_G(x_0)))$, let $W \equiv ([x_0], \hat{W})$ be the corresponding simple object in Vec_G^G . Recall that, as a G -graded vector space, $W = \bigoplus_{x \in [x_0]} W_x$, such that $W_x \cong \hat{W}$, for every $x \in [x_0]$, and as a G -representation, $W \cong \text{Ind}_{Z_G(x_0)}^G(\hat{W}) = \mathbb{C}\{\varpi_{x,w_c}\}_{x \in [x_0], c=1, \dots, \dim_{\mathbb{C}} \hat{W}}$ such that $g \cdot \varpi_{x,w_c} = \varpi_{g x g^{-1}, z_{g,x} \cdot w_c}$, where $g r_x = r_{g x g^{-1}} z_{g,x}$, for every $g \in G$ (see sec. 3.2). Therefore, the half-braiding natural isomorphism of the corresponding object in $\mathcal{Z}(\text{Vec}_G)$ is provided by

$$R_{\mathbb{C}_g, W}(e_g \otimes \varpi_{x,w_c}) = \varpi_{g x g^{-1}, z_{g,x} \cdot w_c} \otimes e_g, \quad (\text{B.7})$$

for every $g \in G$, $x \in [x_0]$ and $c \in \{1, \dots, \dim_{\mathbb{C}} \hat{W}\}$.

Diagrammatically,

$$\begin{array}{c} \downarrow g \\ W \\ \leftarrow \square \rightarrow W \\ \downarrow g \end{array} \equiv R_{\mathbb{C}_g, W}, \quad (\text{B.8})$$

which can be fully specified by the collection of so-called Ω -symbols satisfying (see notation in sec. 3.2)

$$\begin{array}{c} \downarrow g \\ W \\ \leftarrow \square \rightarrow W \\ \downarrow g \end{array} \equiv \sum_{x \in [x_0]} \sum_{c_1, c_2=1}^{\dim_{\mathbb{C}} \hat{W}} \Omega_{\mathbb{C}_x \mathbb{C}_{g x} \mathbb{C}_{g x g^{-1}, c_1 c_2}}^{W \mathbb{C}_g} \begin{array}{c} \leftarrow W \\ \leftarrow \circ \xrightarrow{g x} \circ \xrightarrow{g x} \circ \rightarrow W \\ \downarrow g \\ \psi_{\mathbb{C}_{g x}, c_1}^W \quad \psi_{\mathbb{C}_x, c_2}^W \end{array}. \quad (\text{B.9})$$

It follows from the orthogonality conditions satisfied by the G -grading preserving linear maps that

$$\Omega_{\mathbb{C}_x \mathbb{C}_{g x} \mathbb{C}_{g x g^{-1}, c_1 c_2}}^{W \mathbb{C}_g} \mathbb{1}_{\mathbb{C}_{g x}} = \begin{array}{c} \begin{array}{c} \leftarrow W \\ \leftarrow \circ \xrightarrow{g x} \circ \xrightarrow{g x} \circ \rightarrow W \\ \downarrow g \\ \psi_{\mathbb{C}_{g x}, c_1}^W \quad \psi_{\mathbb{C}_x, c_2}^W \end{array} \end{array} \quad (\text{B.10})$$

Explicitly, the Ω -symbols evaluate to

$$\Omega_{\mathbb{C}_x \mathbb{C}_{g_x} \mathbb{C}_{g_x g^{-1}, c_1 c_2}}^{W \mathbb{C}_g} = \hat{\varrho}(z_{g,x})_{c_2}^{c_1}, \quad (\text{B.11})$$

where $\hat{\varrho} : \mathbb{C}[Z_G(x_0)] \rightarrow \text{End}_{\mathbb{C}}(\hat{W})$. As another example, consider the Lagrangian algebra $L(H, \beta) = \text{Ind}_H^G(\mathbb{C}[H]^\beta) \in \text{Vec}_G^G$ defined in sec. 3.3. Writing $L(H, \beta) = \mathbb{C}\{\varsigma_{a,h}\}_{a=1, \dots, (G:H), h \in H}$, the G -equivariant G -graded vector space structure is defined via $|\varsigma_{a,h}| = r_a h r_a^{-1}$ and $g \cdot \varsigma_{a,h} = \beta_h(h_{g,a}) \varsigma_{g(a), h_{g,a} h h_{g,a}^{-1}}$, for every $g \in G$, where $g r_a = r_{g(a)} h_{g,a}$ and $\beta_-(-)$ was defined in eq. (3.28). Therefore, the half-braiding natural isomorphism of the corresponding object in $\mathcal{Z}(\text{Vec}_G)$ is provided by

$$R_{\mathbb{C}_g, L(H, \beta)}(e_g \otimes \varsigma_{a,h}) = \beta_h(h_{g,a}) \varsigma_{g(a), h_{g,a} h h_{g,a}^{-1}} \otimes e_g, \quad (\text{B.12})$$

for every $g \in G$, $h \in H$ and $a \in \{1, \dots, (G:H)\}$.

Let us now briefly review the equivalence $\text{Vec}_G^G \simeq \text{Tube}(\text{Vec}_G)$. Let $\mathbb{C}[G] = \mathbb{C}\{e_g\}_{g \in G}$ be the group algebra with multiplication rule $e_{g_1} \cdot e_{g_2} = e_{g_1 g_2}$, for every $g_1, g_2 \in G$, and $\mathbb{C}(G) = \mathbb{C}\{\varsigma_x\}_{x \in G}$ be the algebra of functions $G \rightarrow \mathbb{C}$ with multiplication rule $\varsigma_x \cdot \varsigma_y = \delta_{x,y} \varsigma_{x,y}$, for every $x, y \in G$. By definition, the linear space underlying $\text{Tube}(\text{Vec}_G)$ is $\bigoplus_{g,x \in G} \text{Hom}_{\text{Vec}_G}(\mathbb{C}_{g_x g^{-1}} \otimes \mathbb{C}_g, \mathbb{C}_g \otimes \mathbb{C}_x)$. Clearly, as a vector space, $\text{Tube}(\text{Vec}_G) \cong \mathbb{C}[G] \otimes \mathbb{C}(G) = \mathbb{C}\{e_g \otimes \varsigma_x\}_{g,x \in G}$. In this basis, the multiplication rule of $\text{Tube}(\text{Vec}_G)$ obtained by stacking the string diagrams reads

$$(e_{g_1} \otimes \varsigma_y) \cdot (e_{g_2} \otimes \varsigma_x) := \delta_{y, g_2 x g_2^{-1}} (e_{g_1 g_2} \otimes \varsigma_x), \quad (\text{B.13})$$

for every $g_1, g_2, x, y \in G$, while the $*$ -structure is provided by $(e_g \otimes \varsigma_x)^* = e_{g^{-1}} \otimes \varsigma_{g x g^{-1}}$, for every $x, g \in G$.

Let W be a module over $\text{Tube}(\text{Vec}_G)$. Since both $\mathbb{C}[G]$ and $\mathbb{C}(G)$ form subalgebras of $\text{Tube}(\text{Vec}_G)$, W is equipped with the structure of a (left) module over both $\mathbb{C}[G]$ and $\mathbb{C}(G)$. Since $\text{Mod}(\mathbb{C}[G]) \simeq \text{Rep}(G)$ and $\text{Mod}(\mathbb{C}(G)) \simeq \text{Vec}_G$, W is both a G -graded vector space and a G -representation. More explicitly, we have $W = \bigoplus_{x \in G} W_x$ such that $W_x := (e_{1_G} \otimes \varsigma_x)W$, for every $x \in G$. For every $x \in G$ and $w \in W_x$, define $g \cdot w := (e_g \otimes \varsigma_x) \cdot w$. It follows from

$$(e_{1_G} \otimes \varsigma_{g x g^{-1}}) \cdot (e_g \otimes \varsigma_x) = (e_g \otimes \varsigma_x) \cdot (e_{1_G} \otimes \varsigma_x), \quad (\text{B.14})$$

for every $g, x \in G$, that $|g \cdot w| = g|w|g^{-1} = g x g^{-1}$, for every $w \in W_x$. Therefore, $g \cdot W_x \subseteq W_{g x g^{-1}}$ and $W \in \text{Vec}_G^G$. Conversely, given an object $W \in \text{Vec}_G^G$, its $\text{Tube}(\text{Vec}_G)$ -module structure is given by

$$(e_g \otimes \varsigma_y) \cdot w := \delta_{x,y} g \cdot w \quad (\text{B.15})$$

for $g, x, y \in G$ and $w \in W_x$, in such a way that $g \cdot w = \sum_{x \in G} (e_g \otimes \varsigma_x) \cdot w$. In particular, given a simple object $([x_0], \hat{W})$ in Vec_G^G with $W \cong \text{Ind}_{Z_G(x_0)}^G(\hat{W}) = \mathbb{C}\{\varpi_{x,w_c}\}_{x \in [x_0], c=1, \dots, \dim_{\mathbb{C}} \hat{W}}$, its $\text{Tube}(\text{Vec}_G)$ -module structure is given by

$$(e_g \otimes \varsigma_y) \cdot \varpi_{x,w_c} := \delta_{y,x} \varpi_{g x g^{-1}, z_{g,x} \cdot w_c}, \quad (\text{B.16})$$

for every $g, y \in G$, $x \in [x_0]$ and $c \in \{1, \dots, \dim_{\mathbb{C}} \hat{W}\}$. As another example, consider the Lagrangian algebra $L(H, \beta)$. Using the same notation as above,

$$(e_g \otimes \varsigma_y) \cdot \varsigma_{a,h} = \delta_{y, r_a h r_a^{-1}} \beta_h(h_{g,a}) \varsigma_{g(a), h_{g,a} h h_{g,a}^{-1}}, \quad (\text{B.17})$$

for every $g, y \in G$, $a \in \{1, \dots, (G:H)\}$ and $h \in H$.

We are now ready to make an important remark: Let $([x_0], \hat{W}_1)$ and $([x_0], \hat{W}_2)$ be two simple objects in Vec_G^G . Suppose \hat{W}_1 and \hat{W}_2 are non-isomorphic. It is still possible that $\text{Ind}_{Z_G(x_0)}^G(\hat{W}_1) \cong \text{Ind}_{Z_G(x_0)}^G(\hat{W}_2)$. But the simple objects $([x_0], \hat{W}_1)$ and $([x_0], \hat{W}_2)$ are well and truly non-isomorphic, precisely because their corresponding $\text{Tube}(\text{Vec}_G)$ -module structures ‘remember’ the grading. Physically, this is the reason why it is crucial to treat the endpoints of string operators as twisted sector local operators that transform like modules over $\text{Tube}(\text{Vec}_G)$, rather than local operators dressing a truncated symmetry operator (see sec. 3.1).

Finally, let us derive the character formulas used in the main text. Given $W \in \text{Mod}(\text{Tube}(\text{Vec}_G))$, let χ^W be the corresponding character. By definition, we have $\chi^W(e_g \otimes \varsigma_x) = \delta_{gx, xg} \text{tr}_{W_x}[g]$. For the simple object $([x_0], \hat{W})$, this becomes

$$\chi^{([x_0], \hat{W})}(e_g \otimes \varsigma_x) = \delta_{x \in [x_0]} \delta_{gx, xg} \chi^{\hat{W}}(z_{g,x}), \quad (\text{B.18})$$

where $z_{g,x} \in Z_G(x_0)$ is defined by $gr_x = r_{gxg^{-1}}z_{g,x}$. Similarly, let us compute the character of $L(H, \beta)$. By definition,

$$\begin{aligned} \chi^{L(H, \beta)}(e_g \otimes \varsigma_x) &= \sum_{a=1}^{(G:H)} \sum_{h \in H} \delta_{x, r_a h r_a^{-1}} \beta_h(h_{g,a}) \varsigma^{a,h}(\varsigma_{g(a), h_{g,a} h h_{g,a}^{-1}}) \\ &= \sum_{a=1}^{(G:H)} \sum_{h \in H} \delta_{x, r_a h r_a^{-1}} \delta_{g(a), a} \delta_{h_{g,a} h h_{g,a}^{-1}, h} \beta_h(h_{g,a}). \end{aligned} \quad (\text{B.19})$$

Since $gr_a = r_{g(a)}h_{g,a}$, $g(a) = a$ implies $g = r_a h_{g,a} r_a^{-1}$. Together with $x = r_a h r_a^{-1}$ and $h_{g,a} h = h h_{g,a}$, this implies $gx = xg$. Therefore,

$$\begin{aligned} \chi^{L(H, \beta)}(e_g \otimes \varsigma_x) &= \delta_{gx, xg} \sum_{a=1}^{(G:H)} \sum_{h \in H} \delta_{x, r_a h r_a^{-1}} \delta_{g(a), a} \beta_{r_a^{-1} x r_a}(r_a^{-1} g r_a) \\ &= \delta_{gx, xg} \sum_{a=1}^{(G:H)} \delta_{x \in r_a H r_a^{-1}} \delta_{g \in r_a H r_a^{-1}} \beta_{r_a^{-1} x r_a}(r_a^{-1} g r_a). \end{aligned} \quad (\text{B.20})$$

Replacing the sum over cosets by a sum group elements in G finally yields

$$\chi^{L(H, \beta)}(e_g \otimes \varsigma_x) = \frac{\delta_{gx, xg}}{|H|} \sum_{y \in G} \delta_{g \in y^{-1} H y} \delta_{x \in y^{-1} H y} \beta_{y x y^{-1}}(y g y^{-1}), \quad (\text{B.21})$$

which is the formula used in the main text.

B.2 Drinfel'd centre of the category of group representations

Consider the category $\text{Rep}(G)$ of representations of G . Let us sketch the equivalence $\mathcal{Z}(\text{Rep}(G)) \simeq \text{Vec}_G^G$. Let $(W, R_{-,W})$ be an object in $\mathcal{Z}(\text{Rep}(G))$; it consists of an object $W \in \text{Rep}(G)$ and a collection of G -equivariant isomorphisms $R_{V,W}: V \otimes W \xrightarrow{\sim} W \otimes V$ that are natural in V , for every $V \in \text{Rep}(G)$. In particular, we have an isomorphism $R_{\mathbb{C}[G],W}: \mathbb{C}[G] \otimes W \xrightarrow{\sim} W \otimes \mathbb{C}[G]$, where $\mathbb{C}[G]$ is treated as the regular representation. For any $w \in W$, consider $R_{\mathbb{C}[G],W}(e_{1_G} \otimes w)$. One can expand $R_{\mathbb{C}[G],W}(e_{1_G} \otimes w) \in W \otimes \mathbb{C}[G]$ in the basis of $\mathbb{C}[G]$, $R_{\mathbb{C}[G],W}(e_{1_G} \otimes w) \equiv \sum_{x \in G} w_{x^{-1}} \otimes e_x$, which defines $w_{x^{-1}} \in W$ uniquely. Let $\epsilon: \mathbb{C}[G] \rightarrow \mathbb{C}$ be the G -equivariant map $e_g \mapsto 1$, for every $g \in G$. By naturality of the half-braiding,

$$(\text{id}_W \otimes \epsilon) \circ R_{\mathbb{C}[G],W} = R_{\mathbb{C},W} \circ (\epsilon \otimes \text{id}_W). \quad (\text{B.22})$$

Applying both sides to $e_{1_G} \otimes w$ yields

$$\sum_{x \in G} w_{x^{-1}} \otimes \epsilon(e_x) = \sum_{x \in G} w_x \otimes 1 = R_{\mathbb{C}[G], W}(1 \otimes w) = w \otimes 1, \quad (\text{B.23})$$

from which follows that $w = \sum_{x \in G} w_x$. Defining $W_x := \{w \in W \mid R_{\mathbb{C}[G], W}(e_{1_G} \otimes w) = w \otimes e_{x^{-1}}\}$, we obtain $W = \bigoplus_{x \in G} W_x$. It remains to check that the G -equivariant structure is compatible with this G -grading. Let $w \in W_x$. By definition, $R_{\mathbb{C}[G], W}(e_{1_G} \otimes w) = w \otimes e_{x^{-1}}$. Since $R_{\mathbb{C}[G], W}$ is a map in $\text{Rep}(G)$, we have

$$R_{\mathbb{C}[G], W}(e_g \otimes g \cdot w) = R_{\mathbb{C}[G], W}(g \cdot (e_{1_G} \otimes w)) = g \cdot R_{\mathbb{C}[G], W}(e_{1_G} \otimes w) = g \cdot w \otimes e_{gx^{-1}}. \quad (\text{B.24})$$

Let $R_g: \mathbb{C}[G] \rightarrow \mathbb{C}[G], e_x \mapsto e_{xg^{-1}}$. By naturality of the half-braiding,

$$(\text{id}_W \otimes R_g) \circ R_{\mathbb{C}[G], W} = R_{\mathbb{C}[G], W} \circ (R_g \otimes \text{id}_W). \quad (\text{B.25})$$

Applying both sides to $e_{1_G} \otimes w$ yields $w \otimes e_{x^{-1}g^{-1}} = R_{\mathbb{C}[G], W}(e_{g^{-1}} \otimes w)$ so that

$$R_{\mathbb{C}[G], W}(e_{1_G} \otimes g \cdot w) = g \cdot R_{\mathbb{C}[G], W}(e_{g^{-1}} \otimes w) = g \cdot w \otimes e_{gx^{-1}g^{-1}}. \quad (\text{B.26})$$

Therefore, for every $w \in W_x, g \cdot w \in W_{gxg^{-1}}$, as required. Bringing everything together, $W \in \text{Vec}_G^G$. Conversely, given $W \in \text{Vec}_G^G$, the corresponding object in $\mathcal{Z}(\text{Rep}(G))$ has the same underlying G -representation and the half-braiding natural isomorphism is provided by

$$R_{V, W}(v \otimes w) = w \otimes x^{-1} \cdot v, \quad (\text{B.27})$$

for every $V \in \text{Rep}(G), v \in V$ and $w \in W_x$.

Let us consider a couple of special cases. Let $W = ([x_0], \hat{W})$ be a simple object in Vec_G^G . As a G -graded vector space $W = \bigoplus_{x \in G} W_x$ such that $W_x = \mathbb{C}\{\varpi_{x, w_c}\}_{x \in [x_0], c=1, \dots, \dim_{\mathbb{C}} \hat{W} \cong \hat{W}}$, for every $x \in [x_0]$. Therefore, the half-braiding of the corresponding object in $\mathcal{Z}(\text{Rep}(G))$ is given by

$$R_{V, W}(v \otimes \varpi_{x, w_c}) = \varpi_{x, w_c} \otimes x^{-1} \cdot v, \quad (\text{B.28})$$

for every $V \in \text{Rep}(G)$ and $v \in V$. Diagrammatically,

$$\begin{array}{c} \downarrow V \\ \leftarrow W \text{---} \bigcirc \text{---} W \rightarrow \\ \downarrow V \end{array} \equiv R_{V, W}. \quad (\text{B.29})$$

As in the Vec_G , the half-braiding can be fully specified by a collection of Ω -symbols defined via

$$\begin{array}{c} \downarrow V \\ \leftarrow W \text{---} \bigcirc \text{---} W \rightarrow \\ \downarrow V \end{array} \equiv \sum_{\substack{S_1, S_3 \in W \\ S_2 \in V \triangleright S_3}} \sum_{\substack{1 \leq j_1 \leq N_{S_1}^W \\ 1 \leq j_2 \leq N_{S_3}^W}} \sum_{\substack{1 \leq i_1 \leq N_{S_2}^{V S_1} \\ 1 \leq i_2 \leq N_{S_2}^{S_3 V}}} \Omega_{S_1 S_2 S_3, i_1 i_2 j_1 j_2} \begin{array}{c} \downarrow V \\ \leftarrow W \text{---} \bigcirc \text{---} S_3 \text{---} \bigcirc \text{---} S_2 \text{---} \bigcirc \text{---} S_1 \text{---} \bigcirc \text{---} W \rightarrow \\ \downarrow V \end{array} \quad (\text{B.30})$$

Using the orthogonality conditions satisfied by the G -equivariant linear maps, we obtain

$$\Omega_{S_1 S_2 S_3, i_1 i_2 j_1 j_2} \parallel_{S_2} = \begin{array}{c} \downarrow V \\ \leftarrow S_2 \text{---} \bigcirc \text{---} S_3 \text{---} \bigcirc \text{---} W \text{---} \bigcirc \text{---} S_1 \text{---} \bigcirc \text{---} S_2 \text{---} \bigcirc \text{---} W \rightarrow \\ \downarrow V \end{array} \quad (\text{B.31})$$

Explicitly, the Ω -symbols evaluate to

$$\Omega_{S_1 S_2 S_3, i_1 i_2 j_1 j_2}^{WV} = \frac{1}{\dim_{\mathbb{C}} S_2} \sum_{\substack{x \in [x_0] \\ 1 \leq c \leq \dim_{\mathbb{C}} \hat{W}}} \sum_{\substack{1 \leq f_1 \leq \dim_{\mathbb{C}} S_1 \\ 1 \leq f_2 \leq \dim_{\mathbb{C}} S_2 \\ 1 \leq f_3 \leq \dim_{\mathbb{C}} S_3 \\ 1 \leq d_1, d_2 \leq \dim_{\mathbb{C}} V}} \overline{[W \mid S_3]_{x,c} \mid f_3}_{j_1} \overline{[S_3 \mid V \mid S_2]_{f_3 \ d_1 \mid f_2}}_{i_2} \rho(x^{-1})_{d_1}^{d_2} \overline{[V \mid S_1 \mid S_2]_{d_2 \ f_1 \mid f_2}}_{i_1} \overline{[W \mid S_1]_{x,c} \mid f_1}_{j_2}, \quad (\text{B.32})$$

where $\rho: \mathbb{C}[G] \rightarrow \text{End}_{\mathbb{C}}(V)$. As another example, consider the Lagrangian algebra $L(H, \beta)$. Recall that $L(H, \beta) = \mathbb{C}\{\varsigma_{a,h}\}_{a=1,\dots,(G:H), h \in H}$ such that $|\varsigma_{a,h}| = r_a h r_a^{-1}$. Therefore, $R_{V,L(H,\beta)}(v \otimes \varsigma_{a,h}) = \varsigma_{a,h} \otimes (r_a h^{-1}) \cdot v$, for every $v \in V$.

We are now ready to perform the main computation of this appendix. Specialising to the Lagrangian algebra $L(G, \beta)$, we need to compute the Ω -symbols of the corresponding object in $\mathcal{Z}(\text{Rep}(G))$. As commented above, the half-braiding natural isomorphism of $L(G, \beta)$ is easily expressed in the basis $\mathbb{C}\{\varsigma_{1,g}\}_{g \in G}$ given that $\varsigma_{1,g}$ is homogeneous of degree $|\varsigma_{1,g}| = g$. Thus, the difficulty stems from decomposing $L(G, \beta)$ into simple objects in $\text{Rep}(G)$. Recall that as an object in $\text{Rep}(G)$, $L(G, \beta)$ is isomorphic to $\mathbb{C}[G]^{\beta} = \mathbb{C}\{e_g\}_{g \in G}$, where $g_1 \cdot e_{g_2} = \beta_{g_2}(g_1) e_{g_1 g_2 g_1^{-1}}$, for every $g_1, g_2 \in G$. Therefore,

$$\mathbb{C}[G]^{\beta} \cong \bigoplus_{U \in \text{Irr}(\text{Rep}^{\beta}(G))} \text{End}_{\mathbb{C}}(U), \quad (\text{B.33})$$

as an object in $\text{Rep}(G)$. Indeed, by Fourier transform, the matrix unit basis of $\text{End}_{\mathbb{C}}(U)$, for every $U \in \text{Irr}(\text{Rep}^{\beta}(G))$, can be expressed in terms of $\{e_g\}_g$ as

$$u_{b_1} \otimes u^{b_2} = \sqrt{\frac{\dim_{\mathbb{C}} U}{|G|}} \sum_{g \in G} \overline{\pi(g)_{b_2}^{b_1}} e_g, \quad (\text{B.34})$$

where $\pi: \mathbb{C}[G]^{\beta} \rightarrow \text{End}_{\mathbb{C}}(U)$. Recall that

$$\overline{\pi(g)_{b_2}^{b_1}} = \frac{1}{\beta(g, g^{-1})} \pi(g^{-1})_{b_1}^{b_2}, \quad (\text{B.35})$$

for every $g \in G$ and $b_1, b_2 \in \{1, \dots, \dim_{\mathbb{C}} U\}$. It follows from the orthogonality condition

$$\frac{1}{|G|} \sum_{g \in G} \pi_1(g)_{b_2}^{b_1} \overline{\pi_2(g)_{b_4}^{b_3}} = \frac{\delta_{U_1, U_2}}{\dim_{\mathbb{C}} U_1} \delta_{b_1, b_3} \delta_{b_2, b_4}, \quad (\text{B.36})$$

where $\pi_1: \mathbb{C}[G]^{\beta} \rightarrow \text{End}_{\mathbb{C}}(U_1)$ and $\pi_2: \mathbb{C}[G]^{\beta} \rightarrow \text{End}_{\mathbb{C}}(U_2)$, for every $U_1, U_2 \in \text{Irr}(\text{Rep}^{\beta}(G))$, $b_1, b_2 \in \{1, \dots, \dim_{\mathbb{C}} U_1\}$ and $b_3, b_4 \in \{1, \dots, \dim_{\mathbb{C}} U_2\}$, that the inverse map is given by⁴⁰

$$e_g = \sum_{U \in \text{Irr}(\text{Rep}^{\beta}(G))} \sum_{b_1, b_2=1}^{\dim_{\mathbb{C}} U} \left(\sqrt{\frac{\dim_{\mathbb{C}} U}{|G|}} \pi(g)_{b_2}^{b_1} \right) u_{b_1} \otimes u^{b_2}. \quad (\text{B.37})$$

In order to obtain the decomposition of $\mathbb{C}[G]^{\beta}$ into simple objects, one further needs to decompose each (linear) representation $\text{End}_{\mathbb{C}}(U)$, for every $U \in \text{Irr}(\text{Rep}^{\beta}(G))$. Given $U = \mathbb{C}\{u_b\}_b \in \text{Irr}(\text{Rep}^{\beta}(G))$, let $S = \mathbb{C}\{s_f\}_f \in \text{Irr}(\text{Rep}(G))$ be a direct summand of $\text{End}_{\mathbb{C}}(U)$ and write

$$\text{Hom}_G(\text{End}_{\mathbb{C}}(U), S) = \mathbb{C}\{\varphi_{S,j}^{UU^*}\}_j. \quad (\text{B.38})$$

⁴⁰Note that this is the transform that guarantees that both the basis of $\mathbb{C}[G]^{\beta}$ and $\text{End}_{\mathbb{C}}(U)$ are orthonormal. In order to establish eq. (B.33) as an isomorphism of G -equivariant algebra, a different normalisation is required.

Recall that by our convention

$$\varphi_{S,j}^{UU^*}(u_{b_1} \otimes u_{b_2}) = \sum_{f=1}^{\dim_{\mathbb{C}} S} \overline{\begin{bmatrix} U & U^* & S \\ b_1 & b_2 & f \end{bmatrix}_j} s_f. \quad (\text{B.39})$$

Besides, note that $\text{Hom}_G(\text{End}_{\mathbb{C}}(U), S) \cong \text{Hom}_G(U, S \otimes U)$, which is implemented by⁴¹

$$\overline{\begin{bmatrix} U & U^* & S \\ b_1 & b_2 & f_1 \end{bmatrix}_j} = \sqrt{\frac{\dim_{\mathbb{C}} S}{\dim_{\mathbb{C}} U}} \begin{bmatrix} S & U & U \\ f_1 & b_2 & b_1 \end{bmatrix}_j. \quad (\text{B.40})$$

Therefore, given any basis vector s_f in the simple direct summand S of $\text{End}_{\mathbb{C}}(U)$ associated with multiplicity label $j \in \{1, \dots, N_S^{UU^*}\}$, one identifies

$$s_f = \sqrt{\frac{\dim_{\mathbb{C}} S}{\dim_{\mathbb{C}} U}} \sum_{b_1, b_2=1}^{\dim_{\mathbb{C}} U} \overline{\begin{bmatrix} S & U & U \\ f_1 & b_2 & b_1 \end{bmatrix}_j} u_{b_1} \otimes u_{b_2}. \quad (\text{B.41})$$

Together with the Fourier transform spelt out above, this yields

$$s_f = \sqrt{\frac{\dim_{\mathbb{C}} S}{|G|}} \sum_{b_1, b_2=1}^{\dim_{\mathbb{C}} U} \sum_{g \in G} \left(\overline{\begin{bmatrix} S & U & U \\ f & b_2 & b_1 \end{bmatrix}_j} \overline{\pi(g)_{b_2}^{b_1}} \right) e_g. \quad (\text{B.42})$$

Conversely, for every $g \in G$, we have

$$e_g = \sum_{\substack{U \in \text{Irr}(\text{Rep}^{\beta}(G)) \\ S \in U \otimes U^* \\ 1 \leq j \leq N_S^{UU^*}}} \sum_{b_1, b_2=1}^{\dim_{\mathbb{C}} U} \sum_{f=1}^{\dim_{\mathbb{C}} S} \left(\sqrt{\frac{\dim_{\mathbb{C}} S}{|G|}} \begin{bmatrix} S & U & U \\ f & b_2 & b_1 \end{bmatrix}_j \pi(g)_{b_2}^{b_1} \right) s_f. \quad (\text{B.43})$$

We are now ready to compute the Ω -symbols. Let $V = \mathbb{C}\{v_d\}_{d \in \text{Irr}(\text{Rep}(G))}$, $U_1 = \mathbb{C}\{u_{b_1}\}_{b_1 \in \text{Irr}(\text{Rep}^{\beta}(G))}$ and $S_1 = \mathbb{C}\{s_{f_1}\}_{f_1}$ the simple direct summand of $\text{End}_{\mathbb{C}}(U_1)$ associated with multiplicity label $j_2 \in \{1, \dots, N_{S_1}^{U_1 U_1^*}\}$. Let us begin by computing the image of the basis vector $v_{d_2} \otimes s_{f_1}$ under the half-braiding isomorphism $R_{V, L(G, \beta)} : V \otimes L(G, \beta) \xrightarrow{\sim} L(G, \beta) \otimes V$. By definition,

$$R_{V, L(G, \beta)}(v_{d_2} \otimes s_{f_1}) = \sqrt{\frac{\dim_{\mathbb{C}} S_1}{|G|}} \sum_{b_1, b_2=1}^{\dim_{\mathbb{C}} U_1} \sum_{g \in G} \left(\overline{\begin{bmatrix} S_1 & U_1 & U_1 \\ f_1 & b_2 & b_1 \end{bmatrix}_{j_2}} \overline{\pi_1(g)_{b_2}^{b_1}} \right) e_g \otimes (g^{-1} \cdot v_{d_2}). \quad (\text{B.44})$$

In order to simplify this expression, one begins by spelling out $g^{-1} \cdot v_{d_2} = \sum_{d_1=1}^{\dim_{\mathbb{C}} V} \overline{\rho(g)_{d_1}^{d_2}} v_{d_1}$ before employing eq. (B.43), which results in

$$R_{V, L(G, \beta)}(v_{d_2} \otimes s_{f_1}) = \sum_{\substack{U_2 \in \text{Irr}(\text{Rep}^{\beta}(G)) \\ S_3 \in U_2 \otimes U_2^* \\ 1 \leq j_1 \leq N_{S_3}^{U_2 U_2^*}}} \sum_{\substack{1 \leq d_1 \leq \dim_{\mathbb{C}} V \\ 1 \leq b_1, b_2 \leq \dim_{\mathbb{C}} U_1 \\ 1 \leq b_3, b_4 \leq \dim_{\mathbb{C}} U_2 \\ 1 \leq f_3 \leq \dim_{\mathbb{C}} S_3 \\ g \in G}} \left(\frac{\sqrt{\dim_{\mathbb{C}} S_1 \dim_{\mathbb{C}} S_3}}{|G|} \overline{\begin{bmatrix} S_1 & U_1 & U_1 \\ f_1 & b_1 & b_2 \end{bmatrix}_{j_2}} \overline{\begin{bmatrix} S_3 & U_2 & U_2 \\ f_3 & b_3 & b_4 \end{bmatrix}_{j_1}}}{\overline{\rho(g)_{d_1}^{d_2}} \overline{\pi_1(g)_{b_1}^{b_2}} \overline{\pi_2(g)_{b_3}^{b_4}}} \right) s_{f_3} \otimes v_{d_1}. \quad (\text{B.45})$$

Invoking

$$\frac{1}{|G|} \sum_{g \in G} \overline{\rho(g)_{d_1}^{d_2}} \overline{\pi_1(g)_{b_1}^{b_2}} \overline{\pi_2(g)_{b_3}^{b_4}} = \frac{1}{\dim_{\mathbb{C}} U_2} \sum_{1 \leq j_4 \leq N_{U_2}^{V U_1}} \overline{\begin{bmatrix} V & U_1 & U_2 \\ d_2 & b_2 & b_4 \end{bmatrix}_{j_4}} \overline{\begin{bmatrix} V & U_1 & U_2 \\ d_1 & b_1 & b_3 \end{bmatrix}_{j_4}} \quad (\text{B.46})$$

⁴¹As a consistency check, consider the orthogonality conditions satisfied by the two sets of Clebsch–Gordan coefficients.

it boils down to

$$R_{V,L(G,\beta)}(v_{d_2} \otimes s_{f_1}) = \sum_{\substack{U_2 \in \text{Irr}(\text{Rep}^\beta(G)) \\ S_3 \in U_2 \otimes U_2^* \\ 1 \leq j_1 \leq N_{S_3}^{U_2 U_2^*} \\ 1 \leq j_4 \leq N_{U_2}^{V U_1}}} \sum_{\substack{1 \leq d_1 \leq \dim_{\mathbb{C}} V \\ 1 \leq b_1, b_2 \leq \dim_{\mathbb{C}} U_1 \\ 1 \leq b_3, b_4 \leq \dim_{\mathbb{C}} U_2 \\ 1 \leq f_3 \leq \dim_{\mathbb{C}} S_3}} \left(\frac{\sqrt{\dim_{\mathbb{C}} S_1 \dim_{\mathbb{C}} S_3}}{\dim_{\mathbb{C}} U_2} \overline{\begin{bmatrix} S_1 & U_1 & U_1 \\ f_1 & b_1 & b_2 \end{bmatrix}}_{j_2}} \begin{bmatrix} S_3 & U_2 & U_2 \\ f_3 & b_3 & b_4 \end{bmatrix}_{j_1} \right. \\ \left. \begin{bmatrix} V & U_1 & U_2 \\ d_1 & b_1 & b_3 \end{bmatrix}_{j_4} \overline{\begin{bmatrix} V & U_1 & U_2 \\ d_2 & b_2 & b_4 \end{bmatrix}}_{j_4} \right) s_{f_3} \otimes v_{d_1}. \quad (\text{B.47})$$

We are left to express the induced maps $V \otimes S_1 \rightarrow S_3 \otimes V$ in the basis

$$\mathbb{C}\{\varphi_{S_2, i_1}^{V S_1} \otimes \varphi_{S_2, i_2}^{S_3 V}\}_{S_2, i_1, i_2} = \bigoplus_{S_2 \in V \otimes S_1} \text{Hom}_G(V \otimes S_1, S_2) \otimes \text{Hom}_G(S_2, S_3 \otimes V) \quad (\text{B.48})$$

so as to obtain

$$\Omega_{S_1 S_2 S_3, i_1 i_2 j_1 j_2}^{L(G,\beta)V} = \sum_{\substack{U_1, U_2 \in \text{Irr}(\text{Rep}^\beta(G)) \\ 1 \leq j_4 \leq N_{U_2}^{V U_1}}} \sum_{\substack{1 \leq d_1, d_2 \leq \dim_{\mathbb{C}} V \\ 1 \leq b_1, b_2 \leq \dim_{\mathbb{C}} U_1 \\ 1 \leq b_3, b_4 \leq \dim_{\mathbb{C}} U_2 \\ 1 \leq f_1 \leq \dim_{\mathbb{C}} S_1 \\ 1 \leq f_2 \leq \dim_{\mathbb{C}} S_2 \\ 1 \leq f_3 \leq \dim_{\mathbb{C}} S_3}} \left(\frac{\sqrt{\dim_{\mathbb{C}} S_1 \dim_{\mathbb{C}} S_3}}{\dim_{\mathbb{C}} U_2 \dim_{\mathbb{C}} S_2} \overline{\begin{bmatrix} S_1 & U_1 & U_1 \\ f_1 & b_1 & b_2 \end{bmatrix}}_{j_2}} \begin{bmatrix} S_3 & U_2 & U_2 \\ f_3 & b_3 & b_4 \end{bmatrix}_{j_1} \right. \\ \left. \begin{bmatrix} V & S_1 & S_2 \\ d_2 & f_1 & f_2 \end{bmatrix}_{i_1} \begin{bmatrix} V & U_1 & U_2 \\ d_1 & b_1 & b_3 \end{bmatrix}_{j_4} \overline{\begin{bmatrix} V & U_1 & U_2 \\ d_2 & b_2 & b_4 \end{bmatrix}}_{j_4} \overline{\begin{bmatrix} S_3 & V & S_2 \\ f_3 & d_1 & f_2 \end{bmatrix}}_{i_2} \right),$$

By definition of the $\triangleright F$ -symbols, we have

$$\sum_{b_2=1}^{\dim_{\mathbb{C}} U_1} \overline{\begin{bmatrix} V & U_1 & U_2 \\ d_2 & b_2 & b_4 \end{bmatrix}}_{j_4} \overline{\begin{bmatrix} S_1 & U_1 & U_1 \\ f_1 & b_1 & b_2 \end{bmatrix}}_{j_2} = \sum_{\substack{S_4 \in V \otimes S_1 \\ 1 \leq i_3 \leq N_{S_4}^{V S_1} \\ 1 \leq j_3 \leq N_{U_2}^{S_4 U_1}}} \sum_{f_4=1}^{\dim_{\mathbb{C}} S_4} (\triangleright F_{U_2}^{V S_1 U_1})_{U_1, j_2 j_4}^{S_4, i_3 j_3} \overline{\begin{bmatrix} V & S_1 & S_4 \\ d_2 & f_1 & f_4 \end{bmatrix}}_{i_3} \overline{\begin{bmatrix} S_4 & U_1 & U_2 \\ f_4 & b_1 & b_4 \end{bmatrix}}_{j_3}. \quad (\text{B.49})$$

Together with the orthogonality condition

$$\sum_{\substack{1 \leq d_2 \leq \dim_{\mathbb{C}} V \\ 1 \leq f_1 \leq \dim_{\mathbb{C}} S_1}} \overline{\begin{bmatrix} V & S_1 & S_4 \\ d_2 & f_1 & f_4 \end{bmatrix}}_{i_3} \begin{bmatrix} V & S_1 & S_2 \\ d_2 & f_1 & f_2 \end{bmatrix}_{i_1} = \delta_{S_2, S_4} \delta_{f_2, f_4} \delta_{i_1, i_3}, \quad (\text{B.50})$$

it allows us to rewrite the previous expression for the Ω -symbols as

$$\Omega_{S_1 S_2 S_3, i_1 i_2 j_1 j_2}^{L(G,\beta)V} = \sum_{\substack{U_1, U_2 \in \text{Irr}(\text{Rep}^\beta(G)) \\ 1 \leq j_3 \leq N_{U_2}^{S_2 U_1} \\ 1 \leq j_4 \leq N_{U_2}^{V U_1}}} \sum_{\substack{1 \leq d_1 \leq \dim_{\mathbb{C}} V \\ 1 \leq b_1 \leq \dim_{\mathbb{C}} U_1 \\ 1 \leq b_3, b_4 \leq \dim_{\mathbb{C}} U_2 \\ 1 \leq f_2 \leq \dim_{\mathbb{C}} S_2 \\ 1 \leq f_3 \leq \dim_{\mathbb{C}} S_3}} \left(\frac{\sqrt{\dim_{\mathbb{C}} S_1 \dim_{\mathbb{C}} S_3}}{\dim_{\mathbb{C}} U_2 \dim_{\mathbb{C}} S_2} (\triangleright F_{U_2}^{V S_1 U_1})_{U_1, j_2 j_4}^{S_4, i_3 j_3}} \begin{bmatrix} S_3 & U_2 & U_2 \\ f_3 & b_3 & b_4 \end{bmatrix}_{j_1} \right. \\ \left. \overline{\begin{bmatrix} S_2 & U_1 & U_2 \\ f_2 & b_1 & b_4 \end{bmatrix}}_{j_3} \begin{bmatrix} V & U_1 & U_2 \\ d_1 & b_1 & b_3 \end{bmatrix}_{j_4} \overline{\begin{bmatrix} S_3 & V & S_2 \\ f_3 & d_1 & f_2 \end{bmatrix}}_{i_2} \right),$$

Finally, it follows from

$$(\triangleright \bar{F}_{U_2}^{S_3 V U_1})_{S_2, i_2 j_3}^{U_2, j_4 j_1} = \frac{1}{\dim_{\mathbb{C}} U_2} \sum_{\substack{1 \leq d_1 \leq \dim_{\mathbb{C}} V \\ 1 \leq b_1 \leq \dim_{\mathbb{C}} U_1 \\ 1 \leq b_3, b_4 \leq \dim_{\mathbb{C}} U_2 \\ 1 \leq f_2 \leq \dim_{\mathbb{C}} S_2 \\ 1 \leq f_3 \leq \dim_{\mathbb{C}} S_3}} \begin{bmatrix} S_3 & U_2 & U_2 \\ f_3 & b_3 & b_4 \end{bmatrix}_{j_1} \begin{bmatrix} V & U_1 & U_2 \\ d_1 & b_1 & b_3 \end{bmatrix}_{j_4} \overline{\begin{bmatrix} S_2 & U_1 & U_2 \\ f_2 & b_1 & b_4 \end{bmatrix}}_{j_3} \overline{\begin{bmatrix} S_3 & V & S_2 \\ f_3 & d_1 & f_2 \end{bmatrix}}_{i_2}, \quad (\text{B.51})$$

that

$$\Omega_{S_1 S_2 S_3, i_1 i_2 j_1 j_2}^{L(G, \beta) V} = \frac{\sqrt{\dim_{\mathbb{C}} S_1 \dim_{\mathbb{C}} S_3}}{\dim_{\mathbb{C}} S_2} \sum_{\substack{U_1, U_2 \in \text{Irr}(\text{Rep}^\beta(G)) \\ 1 \leq j_3 \leq N_{U_2}^{S_2 U_1} \\ 1 \leq j_4 \leq N_{U_2}^{V U_1}}} (\triangleright F_{U_2}^{V S_1 U_1})_{U_1, j_2 j_4}^{S_4, i_3 j_3} (\triangleright \bar{F}_{U_2}^{S_3 V U_1})_{S_2, i_2 j_3}^{U_2, j_4 j_1}. \quad (\text{B.52})$$

Let us conclude this appendix with some comments about the equivalence $\text{Mod}(\text{Tube}(\text{Rep}(G))) \simeq \mathcal{Z}(\text{Rep}(G))$. At the beginning of this appendix, we mentioned that the vector space underlying the $\text{Tube}(\text{Rep}(G))$ -module associated with $W \in \mathcal{Z}(\text{Rep}(G))$ is given by $\bigoplus_{S \in \text{Irr}(G)} \text{Hom}_{\mathbb{C}}(S, W)$. In sec. 4.4, we constructed tensors that span this vector space and we explicitly computed how $\text{Tube}(\text{Rep}(G))$ acts on this vector space. In particular, for every simple object in $\mathcal{Z}(\text{Rep}(G))$, we computed in eq. (4.30) the matrix coefficients—referred to in the main text as Υ -symbols—of every element of $\text{Tube}(\text{Rep}(G))$ in the corresponding module. These are immediately related to the Ω -symbols of the half-braiding. By inspection, we find that they differ by a factor of $\frac{\dim_{\mathbb{C}} S_2}{\dim_{\mathbb{C}} S_3}$. As a consistency check, inserting in eq. (4.28) definition (B.30) of the Ω -symbols readily recovers the Υ -symbols. This is the essence of the equivalence $\text{Mod}(\text{Tube}(\text{Rep}(G))) \simeq \mathcal{Z}(\text{Rep}(G))$.

We are now able to confirm that the $\text{Tube}(\text{Rep}(G))$ -module computed in eq. (4.44) is isomorphic to that associated with $L(G, \beta)$ under the equivalence $\mathcal{Z}(\text{Rep}(G)) \simeq \text{Mod}(\text{Tube}(\text{Rep}(G)))$. From our treatment of this equivalence for the simple objects, we know Ω -symbols and Υ -symbols of the corresponding $\text{Tube}(\text{Rep}(G))$ -module differ by a factor of $\frac{\dim_{\mathbb{C}} S_2}{\dim_{\mathbb{C}} S_3}$. However, this presupposes that the vector space underlying the $\text{Tube}(\text{Rep}(G))$ -module is of the form $\bigoplus_{S \in \text{Irr}(\text{Rep}(G))} \text{Hom}_G(S, W)$, where $W \in \text{Vec}_G^{\mathbb{C}} \simeq \mathcal{Z}(\text{Rep}(G))$. Applied to $W = L(G, \beta)$, this would be $\bigoplus_S \bigoplus_U \text{Hom}_G(S, \text{End}_{\mathbb{C}}(U))$. Rather, in the main text, the underlying vector space is taken to be isomorphic to $\bigoplus_S \bigoplus_U \text{Hom}_G(S \otimes U, U)$. As spelt out above, the isomorphism $\text{Hom}_G(S, U \otimes U^*) \cong \text{Hom}_G(S \otimes U, U)$ rescales the orthonormal basis elements by a factor of $\sqrt{\dim_{\mathbb{C}} S} / \sqrt{\dim_{\mathbb{C}} U}$. Furthermore, in our derivation, the module is realised via tensor network operators evaluated on the physical Hilbert space. In a tensor network, closing a diagram inherently performs a partial trace over the internal degrees of freedom. This physical trace operation weights each module element by additional quantum dimensions. Because the basis elements extracted from the tensor network are normalized with respect to the physical Hilbert–Schmidt inner product, the matrix coefficients evaluated on the lattice (the Υ -symbols) further differ from those we would associate to the Ω -symbols by multiplicative factors provided by these quantum dimensions.

References

- [ABGE⁺21] F. Apruzzi, F. Bonetti, I. n. García Etxebarria, S. S. Hosseini, and S. Schafer-Nameki, *Symmetry TFTs from String Theory*, *Commun. Math. Phys.* **402** (2023) 895–949, [arXiv:2112.02092 \[hep-th\]](#).
- [AFM20] D. Aasen, P. Fendley, and R. S. K. Mong, *Topological Defects on the Lattice: Dualities and Degeneracies*, [arXiv:2008.08598 \[cond-mat.stat-mech\]](#).
- [AKLT87] I. Affleck, T. Kennedy, E. H. Lieb, and H. Tasaki, *Rigorous results on valence-bond ground states in antiferromagnets*, *Phys. Rev. Lett.* **59** (1987) 799–802.
- [AMF16] D. Aasen, R. S. K. Mong, and P. Fendley, *Topological Defects on the Lattice I: The Ising model*, *J. Phys. A* **49** (2016) 354001, [arXiv:1601.07185 \[cond-mat.stat-mech\]](#).
- [BBFP22] T. Bartsch, M. Bullimore, A. E. V. Ferrari, and J. Pearson, *Non-invertible Symmetries and Higher Representation Theory I*, [arXiv:2208.05993 \[hep-th\]](#).
- [BBG23] T. Bartsch, M. Bullimore, and A. Grigoletto, *Representation theory for categorical symmetries*, [arXiv:2305.17165 \[hep-th\]](#).
- [BBPSN23] L. Bhardwaj, L. E. Bottini, D. Pajter, and S. Schäfer-Nameki, *Gapped phases with non-invertible symmetries: (1+1)d*, *SciPost Phys.* **18** (2025) 032, [arXiv:2310.03784 \[hep-th\]](#).
- [BBSNT22] L. Bhardwaj, L. E. Bottini, S. Schafer-Nameki, and A. Tiwari, *Non-invertible higher-categorical symmetries*, *SciPost Phys.* **14** (2023) 007, [arXiv:2204.06564 \[hep-th\]](#).
- [BBSNT24] L. Bhardwaj, L. E. Bottini, S. Schafer-Nameki, and A. Tiwari, *Lattice Models for Phases and Transitions with Non-Invertible Symmetries*, [arXiv:2405.05964 \[cond-mat.str-el\]](#).
- [BC17] J. C. Bridgeman and C. T. Chubb, *Hand-waving and interpretive dance: an introductory course on tensor networks*, *Journal of Physics A: Mathematical and Theoretical* **50** (2017) 223001.
- [BG17] M. Buican and A. Gromov, *Anyonic Chains, Topological Defects, and Conformal Field Theory*, *Commun. Math. Phys.* **356** (2017) 1017–1056, [arXiv:1701.02800 \[hep-th\]](#).
- [BS08] F. A. Bais and J. K. Slingerland, *Condensate induced transitions between topologically ordered phases*, *Phys. Rev. B* **79** (2009) 045316, [arXiv:0808.0627 \[cond-mat.mes-hall\]](#).
- [BSN23] L. Bhardwaj and S. Schafer-Nameki, *Generalized charges, part I: Invertible symmetries and higher representations*, *SciPost Phys.* **16** (2024) 093, [arXiv:2304.02660 \[hep-th\]](#).
- [BSNW22] L. Bhardwaj, S. Schafer-Nameki, and J. Wu, *Universal Non-Invertible Symmetries*, *Fortsch. Phys.* **70** (2022) 2200143, [arXiv:2208.05973 \[hep-th\]](#).
- [BT17] L. Bhardwaj and Y. Tachikawa, *On finite symmetries and their gauging in two dimensions*, *JHEP* **03** (2018) 189, [arXiv:1704.02330 \[hep-th\]](#).
- [BW93] J. W. Barrett and B. W. Westbury, *Invariants of piecewise linear three manifolds*, *Trans. Am. Math. Soc.* **348** (1996) 3997–4022, [arXiv:hep-th/9311155](#).
- [CBNM25] K. T. K. Chung, U. Borla, A. H. Nevidomskyy, and S. Moroz, *Spontaneously Broken Non-Invertible Symmetries in Transverse-Field Ising Qudit Chains*, [arXiv:2508.11003 \[cond-mat.str-el\]](#).
- [CGW11] X. Chen, Z.-C. Gu, and X.-G. Wen, *Classification of gapped symmetric phases in one-dimensional spin systems*, *Phys. Rev. B* **83** (2011) 035107.

- [CLS⁺18] C.-M. Chang, Y.-H. Lin, S.-H. Shao, Y. Wang, and X. Yin, *Topological Defect Lines and Renormalization Group Flows in Two Dimensions*, *JHEP* **01** (2019) 026, [arXiv:1802.04445 \[hep-th\]](#).
- [CPGSV16] J. I. Cirac, D. Perez-Garcia, N. Schuch, and F. Verstraete, *Matrix Product Density Operators: Renormalization Fixed Points and Boundary Theories*, *Annals Phys.* **378** (2017) 100, [arXiv:1606.00608 \[quant-ph\]](#).
- [CPGSV21] J. I. Cirac, D. Pérez-García, N. Schuch, and F. Verstraete, *Matrix product states and projected entangled pair states: Concepts, symmetries, theorems*, *Rev. Mod. Phys.* **93** (2021) 045003.
- [CSSZ24] Y. Choi, Y. Sanghavi, S.-H. Shao, and Y. Zheng, *Non-invertible and higher-form symmetries in 2+1d lattice gauge theories*, [arXiv:2405.13105 \[cond-mat.str-el\]](#).
- [CW22] A. Chatterjee and X.-G. Wen, *Symmetry as a shadow of topological order and a derivation of topological holographic principle*, *Phys. Rev. B* **107** (2023) 155136, [arXiv:2203.03596 \[cond-mat.str-el\]](#).
- [Dav09] A. Davydov, *Modular invariants for group-theoretical modular data. i*, 2009. [arXiv:0908.1044 \[math.QA\]](#). <https://arxiv.org/abs/0908.1044>.
- [Dav10] A. Davydov, *Centre of an algebra*, *Advances in Mathematics* **225** (2010) 319–348.
- [Dav14] A. Davydov, *Bogomolov multiplier, double class-preserving automorphisms, and modular invariants for orbifolds*, *Journal of Mathematical Physics* **55** (2014) 092305.
- [Del21] C. Delcamp, *Tensor network approach to electromagnetic duality in (3+1)d topological gauge models*, *JHEP* **08** (2022) 149, [arXiv:2112.08324 \[cond-mat.str-el\]](#).
- [DGNO10] V. Drinfeld, S. Gelaki, D. Nikshych, and V. Ostrik, *On braided fusion categories I*, *Selecta Mathematica* **16** (2010) 1–119.
- [dGTS21] C. de Groot, A. Turzillo, and N. Schuch, *Symmetry Protected Topological Order in Open Quantum Systems*, *Quantum* **6** (2022) 856, [arXiv:2112.04483 \[quant-ph\]](#).
- [DHY24] C. Delcamp, E. Heng, and M. Yu, *Nonsemisimple noninvertible symmetry*, *Phys. Rev. B* **112** (2025) 085135, [arXiv:2412.19635 \[cond-mat.str-el\]](#).
- [DI24] C. Delcamp and N. Ishtiaque, *Symmetry topological field theory and non-abelian kramers–wannier dualities of generalised ising models*, *Annales Henri Poincaré* (2025) , [arXiv:2408.06074 \[hep-th\]](#).
- [DKR11] A. Davydov, L. Kong, and I. Runkel, *Field theories with defects and the centre functor*, [arXiv:1107.0495 \[math.QA\]](#).
- [DNO13] A. Davydov, D. Nikshych, and V. Ostrik, *On the structure of the witt group of braided fusion categories*, *Selecta Mathematica* **19** (2013) 237–269.
- [dNR89] M. den Nijs and K. Rommelse, *Preroughening transitions in crystal surfaces and valence-bond phases in quantum spin chains*, *Phys. Rev. B* **40** (1989) 4709–4734.
- [Dri89] V. G. Drinfeld, *Quasi Hopf algebras*, *Alg. Anal.* **1N6** (1989) 114–148.
- [DS17] A. Davydov and D. Simmons, *On lagrangian algebras in group-theoretical braided fusion categories*, *Journal of Algebra* **471** (2017) 149–175.
- [DT23] C. Delcamp and A. Tiwari, *Higher categorical symmetries and gauging in two-dimensional spin systems*, *SciPost Phys.* **16** (2024) 110, [arXiv:2301.01259 \[hep-th\]](#).
- [DW90] R. Dijkgraaf and E. Witten, *Topological Gauge Theories and Group Cohomology*, *Commun. Math. Phys.* **129** (1990) 393.

- [Eck25] L. Eck, *Dualities between 2+1d fusion surface models from braided fusion categories*, *SciPost Phys.* **19** (2025) 157, [arXiv:2501.14722 \[cond-mat.str-el\]](#).
- [EGNO16] P. Etingof, S. Gelaki, D. Nikshych, and V. Ostrik, *Tensor categories*, vol. 205, American Mathematical Soc., 2016.
- [EJ25] D. E. Evans and C. Jones, *An operator algebraic approach to fusion category symmetry on the lattice*, [arXiv:2507.05185 \[math-ph\]](#).
- [ENO10] P. Etingof, D. Nikshych, and V. Ostrik, *Fusion categories and homotopy theory*, *Quantum topology* **1** (2010) 209–273.
- [FFRS04] J. Frohlich, J. Fuchs, I. Runkel, and C. Schweigert, *Kramers-Wannier duality from conformal defects*, *Phys. Rev. Lett.* **93** (2004) 070601, [arXiv:cond-mat/0404051](#).
- [FFRS06] J. Frohlich, J. Fuchs, I. Runkel, and C. Schweigert, *Duality and defects in rational conformal field theory*, *Nucl. Phys. B* **763** (2007) 354–430, [arXiv:hep-th/0607247](#).
- [FFRS09] J. Frohlich, J. Fuchs, I. Runkel, and C. Schweigert, *Defect Lines, Dualities and Generalised Orbifolds*, 16th International Congress on Mathematical Physics, 2010, pp. 608–613. [arXiv:0909.5013 \[math-ph\]](#).
- [FMT22] D. S. Freed, G. W. Moore, and C. Teleman, *Topological symmetry in quantum field theory*, [arXiv:2209.07471 \[hep-th\]](#).
- [FNW92] M. Fannes, B. Nachtergaele, and R. F. Werner, *Finitely correlated states on quantum spin chains*, *Communications in Mathematical Physics* **144** (1992) 443 – 490.
- [FRS02] J. Fuchs, I. Runkel, and C. Schweigert, *TFT construction of RCFT correlators I: partition functions*, *Nuclear Physics B* **646** (2002) 353–497.
- [FRS04a] J. Fuchs, I. Runkel, and C. Schweigert, *TFT construction of RCFT correlators: III: simple currents*, *Nuclear Physics B* **694** (2004) 277–353.
- [FRS04b] J. Fuchs, I. Runkel, and C. Schweigert, *TFT construction of RCFT correlators II: unoriented world sheets*, *Nuclear Physics B* **678** (2004) 511–637.
- [FRS05] J. Fuchs, I. Runkel, and C. Schweigert, *TFT construction of RCFT correlators IV:: Structure constants and correlation functions*, *Nuclear Physics B* **715** (2005) 539–638.
- [FS09] J. Fuchs and C. Stigner, *On Frobenius algebras in rigid monoidal categories*, 2009. [arXiv:0901.4886 \[math.CT\]](#).
- [FT18] D. S. Freed and C. Teleman, *Topological dualities in the Ising model*, *Geom. Topol.* **26** (2022) 1907–1984, [arXiv:1806.00008 \[math.AT\]](#).
- [FTL⁺06] A. Feiguin, S. Trebst, A. W. W. Ludwig, M. Troyer, A. Kitaev, Z. Wang, and M. H. Freedman, *Interacting anyons in topological quantum liquids: The golden chain*, *Phys. Rev. Lett.* **98** (2007) 160409, [arXiv:cond-mat/0612341](#).
- [GAT⁺13] C. Gils, E. Ardonne, S. Trebst, D. A. Huse, A. W. W. Ludwig, M. Troyer, and Z. Wang, *Anyonic quantum spin chains: Spin-1 generalizations and topological stability*, *Phys. Rev. B* **87** (2013) 235120.
- [GKSW14] D. Gaiotto, A. Kapustin, N. Seiberg, and B. Willett, *Generalized Global Symmetries*, *JHEP* **02** (2015) 172, [arXiv:1412.5148 \[hep-th\]](#).
- [GRLM22] J. Garre-Rubio, L. Lootens, and A. Molnár, *Classifying phases protected by matrix product operator symmetries using matrix product states*, *Quantum* **7** (2023) 927, [arXiv:2203.12563 \[cond-mat.str-el\]](#).

- [GW09] Z.-C. Gu and X.-G. Wen, *Tensor-entanglement-filtering renormalization approach and symmetry-protected topological order*, *Phys. Rev. B* **80** (2009) 155131.
- [GZZ⁺25] Y. Guo, J.-H. Zhang, H.-R. Zhang, S. Yang, and Z. Bi, *Locally purified density operators for symmetry-protected topological phases in mixed states*, *Phys. Rev. X* **15** (2025) 021060.
- [Hal83] F. D. M. Haldane, *Nonlinear field theory of large-spin heisenberg antiferromagnets: Semiclassically quantized solitons of the one-dimensional easy-axis néel state*, *Phys. Rev. Lett.* **50** (1983) 1153–1156.
- [Has07] M. B. Hastings, *An area law for one-dimensional quantum systems*, *J. Stat. Mech.* **0708** (2007) P08024, [arXiv:0705.2024 \[quant-ph\]](#).
- [HC23] S.-J. Huang and M. Cheng, *Topological holography, quantum criticality, and boundary states*, [arXiv:2310.16878 \[cond-mat.str-el\]](#).
- [Hua24] S.-J. Huang, *Fermionic quantum criticality through the lens of topological holography*, [arXiv:2405.09611 \[cond-mat.str-el\]](#).
- [Ina21] K. Inamura, *On lattice models of gapped phases with fusion category symmetries*, *JHEP* **03** (2022) 036, [arXiv:2110.12882 \[cond-mat.str-el\]](#).
- [IO23] K. Inamura and K. Ohmori, *Fusion Surface Models: 2+1d Lattice Models from Fusion 2-Categories*, *SciPost Phys.* **16** (2024) 143, [arXiv:2305.05774 \[cond-mat.str-el\]](#).
- [Izu00] M. Izumi, *The structure of sectors associated with longo–rehren inclusions: I. general theory*, *Communications in Mathematical Physics* **213** (2000) 127–179.
- [JS91] A. Joyal and R. Street, *Tortile yang-baxter operators in tensor categories*, *Journal of Pure and Applied Algebra* **71** (1991) 43–51.
- [JSW24] C. Jones, K. Schatz, and D. J. Williamson, *Quantum cellular automata and categorical dualities of spin chains*, [arXiv:2410.08884 \[math-ph\]](#).
- [JW20] W. Ji and X.-G. Wen, *Categorical symmetry and noninvertible anomaly in symmetry-breaking and topological phase transitions*, *Phys. Rev. Res.* **2** (2020) 033417.
- [JW21] W. Ji and X.-G. Wen, *A unified view on symmetry, anomalous symmetry and non-invertible gravitational anomaly*, [arXiv:2106.02069 \[cond-mat.str-el\]](#).
- [KB25] R. Kobayashi and M. Barkeshli, *Soft symmetries of topological orders*, *Phys. Rev. B* **113** (2026) 115150, [arXiv:2501.03314 \[cond-mat.str-el\]](#).
- [KK12] A. Kitaev and L. Kong, *Models for gapped boundaries and domain walls*, *Communications in Mathematical Physics* **313** (2012) 351–373.
- [KLW⁺20] L. Kong, T. Lan, X.-G. Wen, Z.-H. Zhang, and H. Zheng, *Algebraic higher symmetry and categorical symmetry: A holographic and entanglement view of symmetry*, *Phys. Rev. Res.* **2** (2020) 043086.
- [KNZZ23] J. Kaidi, E. Nardoni, G. Zafrir, and Y. Zheng, *Symmetry TFTs and anomalies of non-invertible symmetries*, *JHEP* **10** (2023) 053, [arXiv:2301.07112 \[hep-th\]](#).
- [Kon13] L. Kong, *Anyon condensation and tensor categories*, *Nucl. Phys. B* **886** (2014) 436–482, [arXiv:1307.8244 \[cond-mat.str-el\]](#).
- [KORS20] Z. Komargodski, K. Ohmori, K. Roumpedakis, and S. Seifnashri, *Symmetries and strings of adjoint QCD_2* , *JHEP* **03** (2021) 103, [arXiv:2008.07567 \[hep-th\]](#).
- [KOZ22] J. Kaidi, K. Ohmori, and Y. Zheng, *Symmetry TFTs for Non-invertible Defects*, *Commun. Math. Phys.* **404** (2023) 1021–1124, [arXiv:2209.11062 \[hep-th\]](#).

- [KT92] T. Kennedy and H. Tasaki, *Hidden $Z_2 \times Z_2$ symmetry breaking in Haldane-gap antiferromagnets*, *Phys. Rev. B* **45** (1992) 304.
- [KTY16] A. Kapustin, A. Turzillo, and M. You, *Topological Field Theory and Matrix Product States*, *Phys. Rev. B* **96** (2017) 075125, [arXiv:1607.06766 \[cond-mat.str-el\]](#).
- [KW25] R. Kobayashi and H. Watanabe, *Projective Representations, Bogomolov Multiplier, and Their Applications in Physics*, *Int. J. Theor. Phys.* **65** (2026) 65, [arXiv:2507.12515 \[cond-mat.str-el\]](#).
- [KWZ17] L. Kong, X.-G. Wen, and H. Zheng, *Boundary-bulk relation in topological orders*, *Nuclear Physics B* **922** (2017) 62–76.
- [KZ17] L. Kong and H. Zheng, *Semisimple and separable algebras in multi-fusion categories*, 2019. [arXiv:1706.06904 \[math.QA\]](#).
- [LDOV21] L. Lootens, C. Delcamp, G. Ortiz, and F. Verstraete, *Dualities in One-Dimensional Quantum Lattice Models: Symmetric Hamiltonians and Matrix Product Operator Intertwiners*, *PRX Quantum* **4** (2023) 020357, [arXiv:2112.09091 \[quant-ph\]](#).
- [LDV22] L. Lootens, C. Delcamp, and F. Verstraete, *Dualities in One-Dimensional Quantum Lattice Models: Topological Sectors*, *PRX Quantum* **5** (2024) 010338, [arXiv:2211.03777 \[quant-ph\]](#).
- [LDV24] L. Lootens, C. Delcamp, and F. Verstraete, *Entanglement and the density matrix renormalization group in the generalized Landau paradigm*, *Nature Phys.* **21** (2025) 1657–1663, [arXiv:2408.06334 \[quant-ph\]](#).
- [LJX23] J. Y. Lee, C.-M. Jian, and C. Xu, *Quantum criticality under decoherence or weak measurement*, *PRX Quantum* **4** (2023) .
- [LMZ⁺25] L. A. Lessa, R. Ma, J.-H. Zhang, Z. Bi, M. Cheng, and C. Wang, *Strong-to-weak spontaneous symmetry breaking in mixed quantum states*, *PRX Quantum* **6** (2025) 010344.
- [LOST22] Y.-H. Lin, M. Okada, S. Seifnashri, and Y. Tachikawa, *Asymptotic density of states in 2d CFTs with non-invertible symmetries*, *JHEP* **03** (2023) 094, [arXiv:2208.05495 \[hep-th\]](#).
- [LWB25] R. Luo, Y.-N. Wang, and Z. Bi, *Topological holography for mixed-state phases and phase transitions*, 2025. [arXiv:2507.06218 \[cond-mat.str-el\]](#).
<https://arxiv.org/abs/2507.06218>.
- [LYX25] J. Y. Lee, Y.-Z. You, and C. Xu, *Symmetry protected topological phases under decoherence*, *Quantum* **9** (2025) 1607.
- [MABT23] H. Moradi, O. M. Aksoy, J. H. Bardarson, and A. Tiwari, *Symmetry fractionalization, mixed-anomalies and dualities in quantum spin models with generalized symmetries*, [arXiv:2307.01266 \[cond-mat.str-el\]](#).
- [Maj91] S. Majid, *Representations, duals and quantum doubles of monoidal categories*, Proceedings of the Winter School "Geometry and Physics", Circolo Matematico di Palermo, 1991, pp. [197]–206.
- [MMT22] H. Moradi, S. F. Moosavian, and A. Tiwari, *Topological holography: Towards a unification of Landau and beyond-Landau physics*, *SciPost Phys. Core* **6** (2023) 066, [arXiv:2207.10712 \[cond-mat.str-el\]](#).
- [Mom10] M. Mombelli, *Module categories over pointed hopf algebras*, *Mathematische Zeitschrift* **266** (2010) 319–344.
- [MT25] R. Ma and A. Turzillo, *Symmetry-protected topological phases of mixed states in the doubled space*, *PRX Quantum* **6** (2025) 010348.

- [MW23] R. Ma and C. Wang, *Average symmetry-protected topological phases*, *Physical Review X* **13** (2023) .
- [MZB⁺25] R. Ma, J.-H. Zhang, Z. Bi, M. Cheng, and C. Wang, *Topological phases with average symmetries: The decohered, the disordered, and the intrinsic*, *Physical Review X* **15** (2025) .
- [Mü03a] M. Müger, *From subfactors to categories and topology ii: The quantum double of tensor categories and subfactors*, *Journal of Pure and Applied Algebra* **180** (2003) 159–219.
- [Mü03b] M. Müger, *From subfactors to categories and topology i: Frobenius algebras in and morita equivalence of tensor categories*, *Journal of Pure and Applied Algebra* **180** (2003) 81–157.
- [Nac96] B. Nachtergaele, *The spectral gap for some spin chains with discrete symmetry breaking*, *Communications in Mathematical Physics* **175** (1996) 565–606.
- [Nai0d] D. Naidu, *Categorical morita equivalence for group-theoretical categories*, *Communications in Algebra* **35** (2007) 3544–3565, <https://doi.org/10.1080/00927870701511996>.
- [NY18] S. Neshveyev and M. Yamashita, *A few remarks on the tube algebra of a monoidal category*, *Proceedings of the Edinburgh Mathematical Society* **61** (2018) 735–758.
- [OA96a] M. Oshikawa and I. Affleck, *Defect lines in the Ising model and boundary states on orbifolds*, *Phys. Rev. Lett.* **77** (1996) 2604–2607, [arXiv:hep-th/9606177](https://arxiv.org/abs/hep-th/9606177).
- [OA96b] M. Oshikawa and I. Affleck, *Boundary conformal field theory approach to the critical two-dimensional Ising model with a defect line*, *Nucl. Phys. B* **495** (1997) 533–582, [arXiv:cond-mat/9612187](https://arxiv.org/abs/cond-mat/9612187).
- [Ocn94] A. Ocneanu, *Chirality for operator algebras*, *Subfactors* (Kyuzeso, 1993) (1994) 39–63.
- [Ocn01] A. Ocneanu, *Operator algebras, topology and subgroups of quantum symmetry—construction of subgroups of quantum groups*, *Taniguchi Conference on Mathematics Nara*, vol. 98, 2001, pp. 235–263.
- [Oga20] Y. Ogata, *Classification of symmetry protected topological phases in quantum spin chains*, *Curr. Dev. Math.* **2020** (2020) 41–104.
- [Osh92] M. Oshikawa, *Hidden $\mathbb{Z}_2 \times \mathbb{Z}_2$ symmetry in quantum spin chains with arbitrary integer spin*, *Journal of Physics: Condensed Matter* **4** (1992) 7469.
- [Ost01] V. Ostrik, *Module categories, weak Hopf algebras and modular invariants*, *Transform. Groups* **8** (2003) 177–206, [arXiv:math/0111139](https://arxiv.org/abs/math/0111139).
- [Ost02] V. Ostrik, *Module categories over the Drinfeld double of a finite group*, *arXiv Mathematics e-prints* (2002) math/0202130, [arXiv:math/0202130](https://arxiv.org/abs/math/0202130) [[math.QA](https://arxiv.org/abs/math/0202130)].
- [PGVWC06] D. Perez-Garcia, F. Verstraete, M. M. Wolf, and J. I. Cirac, *Matrix product state representations*, *Quant. Inf. Comput.* **7** (2007) 401–430, [arXiv:quant-ph/0608197](https://arxiv.org/abs/quant-ph/0608197).
- [PGWS⁺08] D. Pérez-García, M. M. Wolf, M. Sanz, F. Verstraete, and J. I. Cirac, *String order and symmetries in quantum spin lattices*, *Phys. Rev. Lett.* **100** (2008) 167202.
- [PT12] F. Pollmann and A. M. Turner, *Detection of symmetry-protected topological phases in one dimension*, *Phys. Rev. B* **86** (2012) 125441.
- [PTBO10] F. Pollmann, A. M. Turner, E. Berg, and M. Oshikawa, *Entanglement spectrum of a topological phase in one dimension*, *Phys. Rev. B* **81** (2010) 064439.
- [PZ01] V. Petkova and J.-B. Zuber, *Generalised twisted partition functions*, *Physics Letters B* **504** (2001) 157–164.

- [QSC⁺25] M. Qi, R. Sohal, X. Chen, D. T. Stephen, and A. Prem, *The Symmetry Taco: Equivalences between Gapped, Gapless, and Mixed-State SPTs*, [arXiv:2507.05335](#) [[cond-mat.str-el](#)].
- [RMO24] J. G. Rubio, A. Molnar, and Y. Ogata, *Classifying symmetric and symmetry-broken spin chain phases with anomalous group actions*, [arXiv:2403.18573](#) [[quant-ph](#)].
- [RPD90] P. Roche, V. Pasquier, and R. Dijkgraaf, *QuasiHopf algebras, group cohomology and orbifold models*, *Nucl. Phys. B Proc. Suppl.* **18** (1990) 60–72.
- [SAF⁺11] P. Smacchia, L. Amico, P. Facchi, R. Fazio, G. Florio, S. Pascazio, and V. Vedral, *Statistical mechanics of the cluster ising model*, *Phys. Rev. A* **84** (2011) 022304.
- [SAV11] W. Son, L. Amico, and V. Vedral, *Topological order in 1D Cluster state protected by symmetry*, *Quant. Inf. Proc.* **11** (2012) 1961–1968, [arXiv:1111.7173](#) [[quant-ph](#)].
- [Sch11] U. Schollwöck, *The density-matrix renormalization group in the age of matrix product states*, *Annals of Physics* **326** (2011) 96–192. January 2011 Special Issue.
- [SGOY24] P. Sala, S. Gopalakrishnan, M. Oshikawa, and Y. You, *Spontaneous strong symmetry breaking in open systems: Purification perspective*, 2024. [arXiv:2405.02402](#) [[quant-ph](#)]. <https://arxiv.org/abs/2405.02402>.
- [Sha23] S.-H. Shao, *What’s Done Cannot Be Undone: TASI Lectures on Non-Invertible Symmetries*, [arXiv:2308.00747](#) [[hep-th](#)].
- [SN23] S. Schafer-Nameki, *ICTP lectures on (non-)invertible generalized symmetries*, *Phys. Rept.* **1063** (2024) 1–55, [arXiv:2305.18296](#) [[hep-th](#)].
- [SNTWZ25] S. Schafer-Nameki, A. Tiwari, A. Warman, and C. Zhang, *SymTFT Approach for Mixed States with Non-Invertible Symmetries*, [arXiv:2507.05350](#) [[quant-ph](#)].
- [SPGC11] N. Schuch, D. Pérez-García, and I. Cirac, *Classifying quantum phases using matrix product states and projected entangled pair states*, *Phys. Rev. B* **84** (2011) 165139.
- [Tac17] Y. Tachikawa, *On gauging finite subgroups*, *SciPost Phys.* **8** (2020) 015, [arXiv:1712.09542](#) [[hep-th](#)].
- [Tur10] V. G. Turaev, *Homotopy quantum field theory*, EMS Tracts in Mathematics, vol. 10, European Mathematical Society (EMS), Zürich, 2010.
- [TV92] V. G. Turaev and O. Y. Viro, *State sum invariants of 3 manifolds and quantum 6j symbols*, *Topology* **31** (1992) 865–902.
- [TW19] R. Thorngren and Y. Wang, *Fusion category symmetry. Part I. Anomaly in-flow and gapped phases*, *JHEP* **04** (2024) 132, [arXiv:1912.02817](#) [[hep-th](#)].
- [VBW⁺18] R. Vanhove, M. Bal, D. J. Williamson, N. Bultinck, J. Haegeman, and F. Verstraete, *Mapping topological to conformal field theories through strange correlators*, *Phys. Rev. Lett.* **121** (2018) 177203.
- [VDCD25] B. Vancraeynest-De Cuiper and C. Delcamp, *Twisted gauging and topological sectors in (2+1)d Abelian lattice gauge theories*, *SciPost Phys.* **19** (2025) 054, [arXiv:2501.16301](#) [[cond-mat.str-el](#)].
- [Ver88] E. P. Verlinde, *Fusion Rules and Modular Transformations in 2D Conformal Field Theory*, *Nucl. Phys. B* **300** (1988) 360–376.
- [VLTV21] R. Vanhove, L. Lootens, H.-H. Tu, and F. Verstraete, *Topological aspects of the critical three-state Potts model*, *J. Phys. A* **55** (2022) 235002, [arXiv:2107.11177](#) [[math-ph](#)].

- [Wei25] Z. Weinstein, *Efficient detection of strong-to-weak spontaneous symmetry breaking via the Rényi-1 correlator*, *Physical Review Letters* **134** (2025) .
- [Wil05] S. Willerton, *The twisted Drinfeld double of a finite group via gerbes and finite groupoids*, *Algebraic & Geometric Topology* **8** (2005) 1419–1457.
- [WP23] R. Wen and A. C. Potter, *Classification of 1+1D gapless symmetry protected phases via topological holography*, *Phys. Rev. B* **111** (2025) 115161, [arXiv:2311.00050](#) [[cond-mat.str-el](#)].
- [XLB24] H. Xue, J. Y. Lee, and Y. Bao, *Tensor network formulation of symmetry protected topological phases in mixed states*, [arXiv:2403.17069](#) [[cond-mat.str-el](#)].
- [YBR⁺14] Y.-Z. You, Z. Bi, A. Rasmussen, K. Slagle, and C. Xu, *Wave function and strange correlator of short-range entangled states*, *Phys. Rev. Lett.* **112** (2014) 247202.
- [You25] M. You, *Symmetric entanglers for non-invertible SPT phases*, [arXiv:2509.04581](#) [[cond-mat.str-el](#)].
- [ZQB26] J.-H. Zhang, Y. Qi, and Z. Bi, *Fidelity strange correlators for average symmetry-protected topological phases*, *Science Bulletin* **71** (2026) 688–691.